

# BRITPART

The quality parts for Land Rovers

## Accessory Catalogue

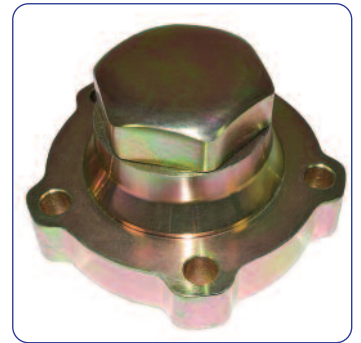
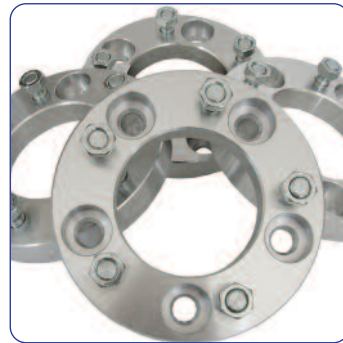

**11**th edition



Photograph courtesy of Esther Jansen



Welcome to the 11th Edition of the Britpart Accessory Catalogue. With **8 more pages** than the last issue we have packed this edition with more product images and **nearly 200 new products** including accessories for the all new Discovery Sport. You're sure to find all the accessories you need, no matter what model Land Rover you drive.

<b>01</b>	<b>Exterior Protection</b>	5 - 16
<b>02</b>	<b>Side &amp; Rear Steps</b>	17 - 22
<b>03</b>	<b>Racks &amp; Luggage Boxes</b>	23 - 30
<b>04</b>	<b>Wheels</b>	31 - 38
<b>05</b>	<b>Lighting Equipment</b>	39 - 46
<b>06</b>	<b>Towing Equipment</b>	47 - 54
<b>07</b>	<b>Interior Protection</b>	55 - 64
<b>08</b>	<b>Seats &amp; Trim</b>	65 - 72
<b>09</b>	<b>Off-Road Equipment</b>	73 - 82
<b>10</b>	<b>Winching Equipment</b>	83 - 94
<b>11</b>	<b>Performance Equipment</b>	95 - 108
<b>12</b>	<b>Suspension &amp; Axle Equipment</b>	109 - 126
<b>13</b>	<b>Vehicle Diagnostics</b>	127 - 138
<b>14</b>	<b>Repair &amp; Service</b>	
	Repair & Service Parts	140 - 152
	Chassis & Body Components	153 - 160
	Service Kits	161 - 164
	Consumables	165 - 170
	Tools	171 - 174
<b>15</b>	<b>Vehicle Enhancements</b>	175 - 188
<b>16</b>	<b>Miscellaneous</b>	189 - 198

At Britpart we are always adding new and exciting products to our accessories range, so remember to look at [www.britpart.com](http://www.britpart.com) for all the latest additions. Also worth remembering is that if there is no picture in the catalogue of a product, then visit our website as there are plenty more product pictures on-line. You can also check out all the news on our Facebook page, so why not visit and 'like us' at [www.facebook.com/britpart](https://www.facebook.com/britpart)

## The Marque

Britpart is the leading independent wholesaler of parts and accessories for Land Rover vehicles, supplying in excess of 800 customers worldwide from government agencies to trade outlets.

# BRITPART

The name 'Britpart' is synonymous with quality parts for Land Rovers and the company has earned a truly enviable reputation around the globe. For over 30 years, Land Rover enthusiasts the world over have come to identify Britpart as a brand to be trusted.

The Britpart logo has become a widely recognised and highly respected marque; it embodies excellence in the field, both in quality and commitment to meeting the needs of the customer.

## Products

Britpart has always reacted swiftly to the demands of the parts market for all Land Rover vehicles, aiming to provide customers with exactly what they want, when they want it. Parts have long been the mainstay of Britpart's business, with many parts simply being unavailable from other sources; however, accessories are now becoming a major part of the business as owners of Land Rovers, old and new, are customising their vehicles to suit their individual tastes and lifestyles; everything they need is now available from Britpart.



The vast array of Britpart accessories ensures that no two Land Rovers are ever identical!

Land Rover appointed Britpart as an 'Approved European Parts Distributor' for all Land Rover Genuine Parts; this, together with Britpart's own vast range of parts and accessories, along with their extensive inventory of O.E.M. product, has resulted in Britpart becoming the ultimate 'One-Stop-Shop' providing everything its customers could possibly require, all ordered and delivered from one dedicated source.

## Quality

Britpart is approved by Lloyd's Register Quality Assurance to BS EN ISO 9001:2008.



Britpart is renowned for quality parts at very competitive prices and takes pride in its excellent customer service, maintaining high stock levels with the aim of fulfilling orders promptly.

## Distribution

Parts and accessories for Land Rover vehicles continually flow in and out of the massive state-of-the-art warehouse. Britpart's fleet of vans and trucks all sport the undeniably eye-catching Britpart blue and white livery. Between them they cover the length and breadth of the United Kingdom, including Northern Ireland, delivering directly to Britpart customers on a regular basis, adding to the personal touch that customers have come to associate with Britpart.

## Service

Britpart has an enthusiastic and highly knowledgeable team so that you deal with people who have in-depth knowledge of the business. In addition to major government contracts, we successfully support individual parts retailers, supplying spares for Land Rover models old and new including Series, Defender, Range Rover, Discovery and Freelander.

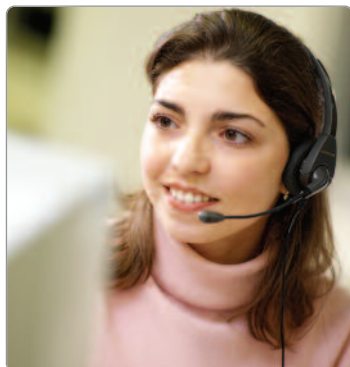

The lively Sales operation boasts three highly trained teams; one each for Home Sales, European Sales and Export Sales with technical experts and sales advisors in each, eager to answer the telephone and organise despatch of goods to their customers within the shortest possible time.

## Handmade

The highly skilled team in the Trim Shop make a wide range of seats, seat covers, bases, backs and benches etc for Land Rover vehicles by hand.



Equally skilled is the team in the Lock Shop where a wide range of light engineering work is carried out.

In keeping with the Britpart philosophy, all products leaving the Trim Shop and the Lock Shop are produced to the highest standards and meet with the strictest safety regulations.

## Global

When Land Rover finally severed its association with Santana Motor SA it was Britpart who bought up all the existing stock from the factory in Spain and shipped it to their UK headquarters in Shropshire. The shipment included everything from small components to body panels and new engines, along with all the original drawings and tooling. Some of the stock was found to be interchangeable with Land Rover parts and a proportion of the rest is gradually making the journey back home with the assistance of our partner in Spain, Britpart España, Estanfi Automoción.

Britpart's other partners around the globe include: Britpart France, Britpart Belgium, Britpart Brazil, Britpart USA and Britpart Poland.

Britpart is seeking to further expand its comprehensive customer base overseas and is continually looking for well established independent stockists of Land Rover parts to work closely with.

## Quality Parts

Britpart hold in excess of 17,000 stock items from o-rings and oil seals to engines and exhaust systems. Customers can choose from Britpart quality parts, O.E.M. products and Land Rover Genuine Parts; all delivered promptly at competitive prices.

Everything required for servicing, repairing, restoring or even rebuilding any Land Rover can be supplied by Britpart, thus enabling customers to order all they need on just one order sheet making it easy to keep track of stock and take delivery.



## Quality Accessories

Britpart have all the latest accessories you need to customise your Land Rover, whatever the model, to look great on the road and work better off it! From wheels to roof racks, Britpart have everything to ensure that no two Land Rovers need ever look identical.



## Our commitment to you!...

For over 30 years Britpart has been supplying quality parts and accessories for Land Rover users across the world and now we are very proud to announce that all\* Britpart parts and accessories will be backed by an industry leading **24 month guarantee.**

With a recent multi-million pound investment in the best Land Rover products and with extensive investment in new staff, equipment and procedures we are convinced this new guarantee will give consumers more confidence in Britpart products. This is backed up with our approval by Lloyd's Register Quality Assurance to BS EN ISO 9001:2008.

This pioneering guarantee will cover over 12,000 parts from our extensive parts catalogue, from springs to clutches and from winches to shock absorbers, confidence in the products we supply is assured. If any part is found to be defective following an inspection by our quality team due to faulty materials or workmanship then that part will be replaced free of charge.

With this significant development in Britpart's philosophy we are now confident that the parts the end users fit to their Land Rovers will deliver time after time, whether the customer is buying a part for a Series 3 or a new Range Rover, they are backed by the same 24 month guarantee.

Look out for the Britpart Guarantee Logo which will be gracing all our products in the forthcoming months as a constant reminder to the customer they are fitting the best available parts and accessories to their Land Rover.



\*Subject to our standard terms and conditions. Proof of purchase required by the original point of purchase. Excludes Genuine Land Rovers parts, reconditioned gearboxes & engines. This guarantee does not affect your statutory rights.

Section contents

<b>Chequer plate</b>	<b>6</b>	<b>Side protection</b>	
<b>Dirt D-fenders</b>	<b>11</b>	Rock sliders	<b>14</b>
<b>Front protection</b>		Rubbing strips	<b>14</b>
A Bars	<b>7</b>	Wheel arch kits	<b>14</b>
Bumpers & bumperettes	<b>7</b>	<b>Underside protection</b>	
<b>Lamp guards</b>	<b>8 - 11</b>	Diff guard	<b>15</b>
<b>Locking fuel cap</b>	<b>7</b>	Fuel cooler guard	<b>15</b>
<b>Mirrors</b>	<b>11</b>	Steering/sump & transmission guards	<b>15</b>
<b>Mudflaps</b>	<b>12</b>	Swivel housing gaiter kits	<b>16</b>
<b>Rear protection</b>		Universal joint silicone sleeves	<b>16</b>
Bumpers & bumperettes	<b>13</b>	<b>Wind deflectors</b>	<b>16</b>
Parking sensors	<b>13</b>		
Replacement rear surround cameras	<b>13</b>		
Reversing camera kit	<b>13</b>		



“Going off-road? Then don’t take a chance with your Land Rover’s protection. Here’s where to find all the equipment your Land Rover will need to protect it - front to back and top to bottom - from all the hidden dangers you may encounter.”

exterior protection

## Chequer Plate



DA2054



DA2062



DA2066 / DA4049



DA2070



DA4049B



DA4049S



DA4073 / DA4072

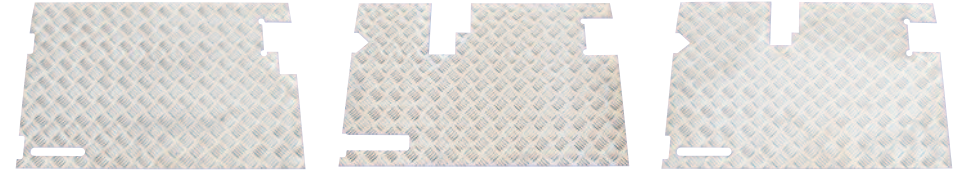

DA2067

DA2068

DA2069



DA2061

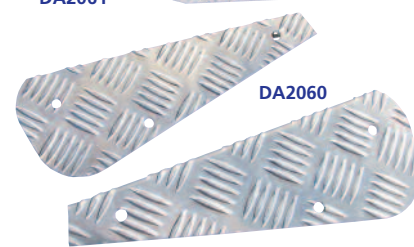

DA2060



DA4073B



DA4296



DA4072B

Add some **heavy-duty** protection to your Land Rover!

### Defender - Natural aluminium finish

DA2054	Bumper top plate	Single
DA2062	Bumper top plates	Pair
DA2060	Mudflap brackets	Pair
DA2061	Rear cross member	Single
DA2063	Rear floor - 110 County Station Wagon	Single
DA2064	Rear sides - 110 County Station Wagon	Pair
DA2067	Rear door - without wiper	Single
DA2068	Rear door - wiper - late	Single
DA2069	Rear door - wiper - early	Single
DA2070	Load bay liner - 90/Pickup/Hard top/County Station Wagon	Kit
DA4072	Sills - 90	Pair
DA4073	Rear wing - 90	Pair
DA4100	Sills - 110	Pair
DA4071	Rear wing - 110	Pair
DA4049	Wing tops	Pair
DA4049S	Wing tops	Pair
DA2066	Bonnet protector	Pair
DA2066	Curved plate - pre-drilled holes	Single
DA4342	Bonnet protector	Kit

**Note** - Painted silver finish  
Defender - 1983 - 2006

Defender - 2007 onwards

### Defender - Satin black finish

DA4072B	Sills - 90	Pair
DA4073B	Rear wing - 90	Pair
DA4100B	Sills - 110	Pair
DA4071B	Rear wing - 110	Pair
DA4049B	Wing tops	Pair
DA3081	Bonnet protector	Single
DA3081	Curved plate - pre-drilled holes	Single
DA4343	Bonnet protector	Kit

**Defender - Chequer Plate Kits** - Natural aluminium finish  
Kit contains - bonnet, wings, sills & rear corner protection

DA4296	Defender 90	Kit
DA4297	Defender 110	Kit

**Series** - Natural aluminium finish

DA2004	Wing top	Pair
DA2050	Rear cross member	Single
DA2051	Load bay liner	Short wheel base
DA2052	Sills	Short wheel base
DA2053	Sills	Long wheel base
DA2054	Bumper plate	Single
DA2067	Rear door	Without wiper
DA4074	Rear wing	Short wheel base

**Miscellaneous** - Natural aluminium finish

DA2065	Chequer plate steel sheet	1,200 x 2,500mm	Single
--------	---------------------------	-----------------	--------

**Front Protection**  
A Bars



<b>Defender</b>			
<b>VPLPP0060</b>	Defender - no winch	Black rubber	Includes spot lamp brackets
<b>VPLPP0061</b>	Defender - with winch (genuine winch bumper only)	Black rubber	Includes spot lamp brackets
<b>Discovery</b>			
<b>LR005237LR</b>	Discovery 3	Moulded black rubber	Includes spot lamp brackets
<b>VPLAP0022</b>	Discovery 4	Moulded black rubber	Includes spot lamp brackets
<b>Freelander</b>			
<b>STC50413</b>	Freelander 1	Preformed plastic & foam	No spot lamp brackets
<b>LR003319</b>	Freelander 2 - with or without parking sensors	Black bumper styling cover	No spot lamp brackets
<b>Range Rover</b>			
<b>VUB501980</b>	Range Rover Sport - 2005 - 2009	Moulded grey plastic	No spot lamp brackets
<b>LR005239</b>	Range Rover L322	Moulded black plastic	Includes spot lamp brackets

**IMPORTANT NOTICE**  
Please check local legislation before fitting a frontal protection device to a vehicle that is to be used on public roads.

Add some **front end protection** to your vehicle with an A Bar - also a great addition if you'd like to add spot lamps to your Land Rover!



**Bumpers & Bumperettes**

For more images of this bumper go to [www.britpart.com](http://www.britpart.com)

**Locking Fuel Cap**



**DA1227**  
Discovery 2  
Locking fuel cap  
Supplied with 2 keys



**Winch Bumpers?**

- see winching equipment section

<b>DPB000270</b>	Defender	Military front bumper	
<b>DPB000270GALV</b>	Defender	Military front bumper	Galvanised
<b>DA5678 NEW</b>	Defender	Front bumper with LED lights	
This smart and functional standard fit Defender bumper is equipped with a pair of LED lights for additional lighting in the dark or day light running for safety.			
<b>RRC6681</b>	Defender	Centre pin for bumper	
<b>RRC6682</b>	Defender	'R' Clip for centre pin	
<b>DA5626</b>	Defender	Bumper kit - contains all the above part numbers	
<b>RTC4769</b>	Defender/Series	Front bumperette - single	Galvanised

## Lamp Guards

### Defender



DA4077



DA1079



DA4400



STC53161

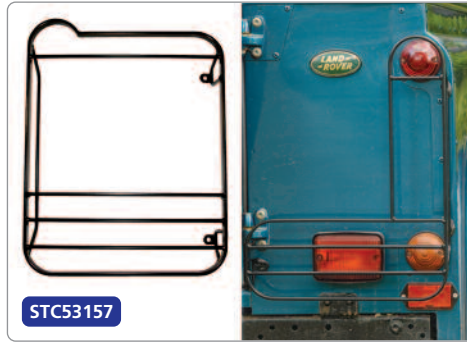

STC53157



STC53158



DA4349

<b>DA4077</b>	Defender - all models	Front	Wolf style	Pair
<b>DA1079</b>	Defender - 2003 - 2006 & 2007 onwards	Rear	Wolf style - rectangular & round	Pair
<b>DA4400</b>	Defender - Td5 - 2003 onwards	Front & rear	Wolf style	Kit
<b>RTC8969</b>	Defender - up to 2A622423	Front	Rectangular	Pair
<b>STC53161</b>	Defender - 2A622424 onwards	Front	Rectangular	Pair
<b>RTC8860AA</b>	Defender - up to 2A	Rear	1 x Square & 1 x L-shape	Pair
<b>STC53157</b>	Defender - 2A onwards	Rear	1 x Square & 1 x L-shape	Pair
<b>DA4133</b>	Defender - Td5	Rear	Rectangular	Single
<b>DA4134</b>	Defender - Td5	Rear	Round	Single
<b>STC53158</b>	Defender - all models	Rear	Square hinged	Pair
<b>VUB504110</b>	Defender - all models	Rear	Round	Pair
<b>STC8056</b>	Defender 110 - Hi-Capacity	Rear	Rectangular	Pair
<b>DA4349</b>	Defender - all models	Rear	Round ABS plastic tail light	Single

They will not rust and you don't need to drill your car to fit these - fitted in seconds. They fit the genuine Land Rover fog and reversing light and the NAS lights. The guard fits over the round rear lights that are roughly 95mm diameter. It is carefully designed complete with the drain hole at the bottom that lines up with the drain hole in the NAS light base.

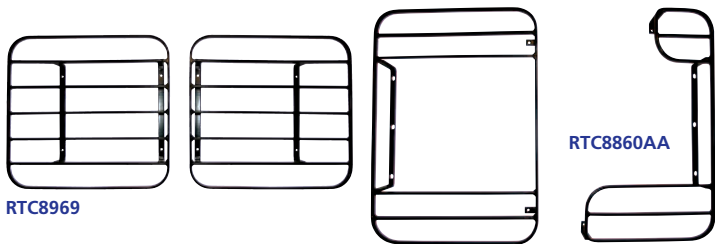

RTC8969

RTC8860AA

DA4134

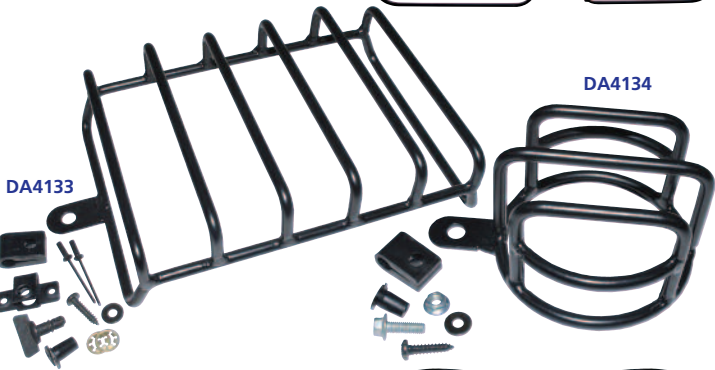

DA4133

STC8056

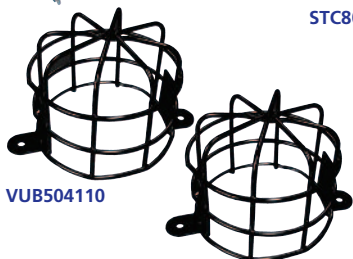

VUB504110

### Series

345985

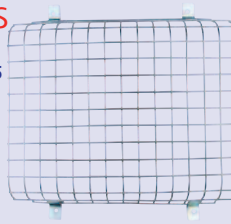

345985P

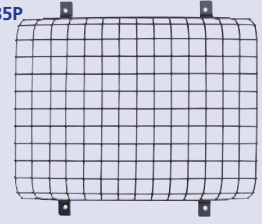

MRC316

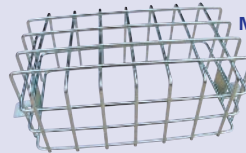

MRC316P



**Note** - All Series lamp guards supplied as singles

#### 345985

Front  
Natural finish

#### MRC316

Rear  
Natural finish

#### 345985P

Front  
Plastic coated

#### MRC316P

Rear  
Plastic coated







**Note** - All Discovery lamp guards supplied as pairs

<b>DA4172</b>	Discovery 1 - 300Tdi	Front - acrylic headlamp protectors
<b>STC8453G</b>	Discovery 1	Rear bumper - no drill fit
<b>RTC9503AA</b>	Discovery 1	Rear wing
<b>STC50026</b>	Discovery 2 - up to 3A	Front
<b>STC50064</b>	Discovery 2 - up to 3A	Front - acrylic headlamp protectors
<b>STC53181</b>	Discovery 2 - 3A onwards	Front
	<b>Note</b> - For fitment with nudge bar (STC53176)	
<b>STC53193</b>	Discovery 2 - 3A onwards	Front
<b>STC50027</b>	Discovery 2 - all models	Rear bumper & rear upper set
<b>STC53194</b>	Discovery 2 - all models	Rear wing
<b>VUB500520</b>	Discovery 2 - all models	Rear low
	<b>Note</b> - Not suitable for vehicles with parking sensors	
<b>VUB501200</b>	Discovery 3 - all models	Front
<b>VUB501380</b>	Discovery 3 - all models	Rear
<b>VPLAP0008</b>	Discovery 4 - all models	Front
<b>VPLAP0009</b>	Discovery 4 - all models	Rear



Photograph courtesy of Mark Harrison

Protect those **valuable headlights** from accidental damage either on or off-road!

## Range Rover



STC8503AALR



STC8504ABLR



STC8027LR



DA4173



Got a great looking Land Rover? Then why not enter the Britpart calendar competition?

[www.britpart.com/calendar](http://www.britpart.com/calendar)



VUB501930



VPLSP0010



VUB501920



VPLTP0064



VUB001070

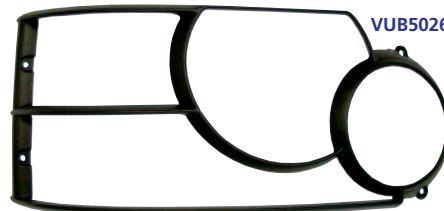

VUB502610



VUB001080LR

**Note** - All Range Rover lamp guards supplied as pairs

**STC8027LR** Range Rover Classic

**STC8503AALR** Range Rover P38

**STC8504ABLR** Range Rover P38

**DA4173** Range Rover P38 - up to 1999

Acrylic headlamp protectors

Rear - hinged

Front - drill fit

Rear - drill fit

Front

**VUB501930**

**VUB501920**

**VPLSP0010**

**VPLTP0064**

**VUB001070**

**Note** - Front lamp guards not compatible with wraparound protection bar

**VUB502610**

**VUB001080LR**

Range Rover Sport - 2005 - 2009

Range Rover Sport - 2005 - 2009

Range Rover Sport - 2010 - 2013

Range Rover Sport - 2010 - 2013

Range Rover L322 - up to 6A

Range Rover L322 - 6A onwards

Range Rover L322

Front

Rear

Front

Rear

Front

Front

Rear

Customise your Range Rover - see vehicle enhancement section



LR002408



LR003685

Protect those **valuable headlights** from accidental damage either on or off-road!

- LR002408**  
Freelander 2  
Front Pair
- LR003685**  
Freelander 2  
Rear Pair

**Unbreakable Mirrors for Defenders**

- Optical quality polycarbonate lens - will not shatter like glass or discolour in sunlight.
- Strong, flexible polypropylene casing - will absorb hard blows without breaking.
- Universal - can be fitted to either left or right of vehicle.
- Lightweight - puts less strain on body fixings.
- Hard lacquer coating on lens - will repel condensation and surface water.
- Excellent reflectivity - superb daylight and night time vision.

Unbreakable Mirrors & Arms		Head Dimensions	Arm Length	
<b>DA4404</b>	Flat mirror	204 x 140mm (8 x 5 1/2")	No arm	Flat with fixing kit
<b>DA4405</b>	Flat mirror	204 x 140mm (8 x 5 1/2")	170mm	Flat with fixing kit and short arm
<b>DA4406</b>	Flat mirror	204 x 140mm (8 x 5 1/2")	290mm	Flat with fixing kit and long arm
<b>DA4407</b>	Convex mirror	204 x 140mm (8 x 5 1/2")	No arm	Convex with fixing kit
<b>DA4408</b>	Convex mirror	204 x 140mm (8 x 5 1/2")	170mm	Convex with fixing kit and short arm
<b>DA4409</b>	Convex mirror	204 x 140mm (8 x 5 1/2")	290mm	Convex with fixing kit and long arm

Standard Mirrors & Fittings Series			
<b>DA2128</b>	Mirror arm	7"	Standard
<b>DA2130</b>	Mirror head	7 x 5"	Standard
<b>DA2301</b>	Mirror glass	7 x 5"	Standard

Defender			
<b>MTC5083</b>	Mirror arm	7"	Standard
<b>RR8443</b>	Mirror arm	11 1/2"	Large
<b>MTC5084</b>	Mirror head	5 x 8"	Standard
<b>DA4034</b>	Mirror head	6 x 10 1/2"	Large
<b>MTC5217</b>	Mirror assembly		Standard



Good visibility is imperative on today's highways and byways so these new high impact resistant mirror heads are essential stock items.

**Mirrors**

**Dirt D-fenders**

**Keep the side of your Defender cleaner!**

Dirt D-Fenders are a great solution to the annoying problem of mud splashes through the gap which exists between the bottom of the wheel arch and the mudflap of your Defender. They are an especially useful addition if you are using wider tyres. The Dirt D-Fenders attach with rivets into the underside of the sill and wheel arch flare. Supplied in pairs with the fitting kit.

**Note** - Dirt D-Fenders will not fit Defenders with rock/tree sliders fitted.



<b>DA1193</b>	Defender 90,110,130	Rear of front wheel
<b>DA1198</b>	Defender 90,110	Front of rear wheel
<b>DA1197</b>	Defender 90	Rear of rear wheel
<b>DA1194</b>	Defender 110	Rear of rear wheel

## Mudflaps

### Defender - 1987 onwards

#### Front Mudflaps

<b>CAS500180PMA</b>	90/110/130 - up to AA792970	RH
<b>LR055323</b>	90/110/130 - from AA792971	RH
<b>CAS500190PMA</b>	90/110/130 - up to AA792970	LH
<b>LR055333</b>	90/110/130 - from AA792971	LH
<b>RTC4685</b>	90/110/130 - flaps only	Pair
<b>RTC9479</b>	90/110/130 - with brackets	Pair

#### Rear Mudflaps

<b>CAT500410PMA</b>	90 - up to AA792970 - black Britpart logo	RH
<b>LR055332</b>	90 - from AA792971 - black Britpart logo	RH
<b>CAT500540PMA</b>	90 - up to AA792970 with exhaust cut-out - black Britpart logo	LH
<b>LR055340</b>	90 - from AA792971 with exhaust cut-out - black Britpart logo	LH
<b>CAT500450PMA</b>	90 - no exhaust cut-out - black Britpart logo	LH
<b>DA4531</b>	90 - with exhaust cut-out - yellow Britpart logo	Pair
<b>DA4532</b>	90 - no exhaust cut-out - yellow Britpart logo	Pair
<b>DA4533</b>	90 - universal fitment - no exhaust cut-out	Pair

#### Wide mudflaps - yellow Britpart logo

<b>MXC6412</b>	90 - from FA414687 up to WA159806	RH
<b>MXC6413</b>	90 - from FA414687 up to WA159806	LH
<b>MUC3990</b>	90 - hard & soft top - from AA232011 up to FA414686	LH
<b>MUC2344</b>	90 - from 3A650368 up to 5A690309	RH
<b>DA4534</b>	110/130 Crew cab - yellow Britpart logo	Pair
<b>DA4536</b>	110/130 Crew cab	Pair

#### Wide mudflaps - yellow Britpart logo

<b>BTR277</b>	110/130 - universal - flap only - from FA414616	Single
<b>CAT500340PMA</b>	110/130 - up to AA792970 - black Britpart logo	RH
<b>LR055330</b>	110/130 - from AA792971 - black Britpart logo	RH
<b>CAT500350PMA</b>	110/130 - up to AA792970 - black Britpart logo	LH
<b>LR055334</b>	110/130 - from AA792971 - black Britpart logo	LH
<b>CAT500360PMA</b>	110/130 HCPU - up to AA792970 - black Britpart logo	RH
<b>LR055331</b>	110/130 HCPU - from AA792971 - black Britpart logo	RH
<b>CAT500370PMA</b>	110/130 HCPU - up to AA792970	LH
<b>LR055339</b>	110/130 HCPU - from AA792971	LH
<b>DA4535</b>	110/130 HCPU - yellow Britpart logo	Pair

Britpart now offer a wider than standard mudflap, ideal for Defenders fitted with wheel spacers.



#### DA1188

Galvanised front mudflap brackets - pair  
Equivalent to MTC3000 & MTC3001  
Defender 90 & 110

#### DA1187

Galvanised rear mudflap brackets - pair  
Equivalent to MUC3986 & MUC3987  
Defender 90

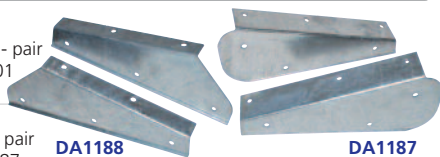

## REDUCE THOSE MUDDY SPLASHES FROM OVER YOUR LAND ROVER!

### Discovery

<b>Discovery 1</b>		
<b>RTC6820</b>	Front	Pair
<b>RTC6821</b>	Rear	Pair
<b>Discovery 2</b>		
<b>CAS100900</b>	Front & rear	RH
<b>CAS100910</b>	Front & rear	LH
<b>Discovery 3</b>		
<b>CAS500010PCL</b>	Front	Pair
<b>CAT500010PCL</b>	Rear	Unpainted bumper
<b>VPLAP0017</b>	Rear	Partially painted bumper
<b>Discovery 4</b>		
<b>CAS500010PCL</b>	Front	Pair
<b>CAT500010PCL</b>	Rear	Unpainted bumper
<b>VPLAP0017</b>	Rear	Partially painted bumper
<b>Discovery Sport</b>		
<b>VPLCP0203 NEW</b>	Front	Pair
<b>VPLCP0204 NEW</b>	Rear	7-seat without spare wheel & 5-seat
<b>VPLCP0205 NEW</b>	Rear	7-seat with spare wheel

### Freelander

#### Freelander 1

<b>STC7978AB</b>	Front	Up to 1A999999 - Hatton Grey	Pair
<b>STC53075AA</b>	Front	From 2A000001 - Black	Pair
<b>STC53076AA</b>	Rear	From 2A000001 up to 3A999999 - Black	Pair
<b>CAT500060PMA</b>	Rear	From 4A000001 - Black	Pair

#### Freelander 2

<b>LR003324</b>	Front		Pair
<b>LR003322</b>	Rear		Pair

### Range Rover

#### Range Rover Classic

<b>RTC9562</b>	Front	1986 - 1994	Pair
<b>MXC5587</b>	Front - flap only	1986 - 1994	Single
<b>MXC5587</b>	Rear - flap only	1986 - 1994	Single

#### Range Rover P38

<b>CAS100920</b>	Front	From XA428522	RH
<b>CAS100930</b>	Front	From XA428522	LH
<b>STC8535</b>	Front		Pair
<b>STC8536</b>	Rear	Single exhaust	Pair
<b>STC7703</b>	Rear	Twin exhaust	Pair
<b>CAT101160</b>	Rear	From XA428522	RH
<b>CAT101170</b>	Rear	From XA428522	LH

#### Range Rover Sport - 2005 - 2009

<b>CAS500070PCL</b>	Front		Pair
<b>CAT500120PCL</b>	Rear	Less sport bumper protection	Pair

#### Range Rover Sport - 2010 - 2013

<b>CAS500070PCL</b>	Front		Pair
<b>VPLSP0016</b>	Rear		Pair

#### Range Rover Sport - 2014 onwards

<b>VPLWP0167</b>	Front	Compatible with electric deployable step	Pair
<b>VPLWP0165</b>	Front	Not compatible with electric deployable step	Pair
<b>VPLWP0166</b>	Rear		Pair

#### Range Rover L322 - 2002 - 2009

<b>CAS000150PMA</b>	Front	Up to 5A999999	Pair
<b>VUB001320</b>	Front	Up to 5A999999	RH
<b>VUB001330</b>	Front	Up to 5A999999	LH
<b>CAS500060PMA</b>	Front	From 6A198416	Pair
<b>VUB503940</b>	Front	From 6A198416 - for side step	Pair
<b>CAT000180PMA</b>	Rear	Up to 5A999999	Pair
<b>CAT500070PMA</b>	Rear	From 6A198416	Pair

#### Range Rover L322 - 2010 - 2012

<b>CAS500060PMA</b>	Front	From AA000001	Pair
<b>CAT500070PMA</b>	Rear	From AA000001	Pair

#### Range Rover L405 - 2013 onwards

<b>VPLGP0111</b>	Front	Compatible with electric deployable step	Pair
<b>VPLGP0109</b>	Front	Not compatible with electric deployable step	Pair
<b>VPLGP0110</b>	Rear		Pair

#### Range Rover Evoque

<b>VPLVP0065</b>	Front	Pure & Prestige	Pair
<b>VPLVP0069</b>	Rear	Pure & Prestige	Pair
<b>VPLVP0066</b>	Front	Dynamic	Pair
<b>VPLVP0070</b>	Rear	Dynamic	Pair



More mudflap images at [www.britpart.com/mudflaps](http://www.britpart.com/mudflaps)

Note - RH - Right hand side / LH - Left hand side

**Rear Protection**  
Bumpers & Bumperettes



**DA5647**  
Discovery 1 - 300Tdi - will also fit 200Tdi see note below

- One piece rear heavy-duty bumper manufactured from 5mm steel with incorporated steel end caps and 2 recovery points, finished in black
- Provision for nato/recovery point in centre of bumper
- Fixed to standard mounting points and for added strength, extra fixings in centre where tow bar mounts

**Note** - Tow bar and rear lights not included. Will fit 200Tdi if 300Tdi lamps are used.  
Right lamp - AMR6510; left lamp - AMR6509

**DA5646**  
Discovery 2

- One piece rear heavy-duty bumper manufactured from 4mm steel with incorporated steel end caps, finished in black
- 2 Recovery points and 2 Hi-Lift jacking points included
- Fixed to standard mounting points and for added strength, extra fixings in centre where tow bar mounts

**Note** - Tow bar and rear lights not included  
Up to 3A771194 - right lamp - XFB101480; left lamp - XFB101490  
From 3A771195 - right lamp - XFB000720; left lamp - XFB000730

<b>DA2071</b>	Defender/Series	Rear bumperettes	Pair	Black
<b>RRC2970</b>	Defender/Series	Rear bumperette	Single - RHS	Black
<b>RRC2971</b>	Defender/Series	Rear bumperette	Single - LHS	Black
<b>DA1056</b>	Lightweight	Military style bumperette	Single	Galvanised
<b>ISG000040</b>	Defender Wolf	Rear bumperette	Single - RHS	Black
<b>ISG000050</b>	Defender Wolf	Rear bumperette	Single - LHS	Black



**ADDED PROTECTION!**

**Reversing Camera Kit**

**DA5540**  
This is a high performance, fully automatic, practical driver assistance device. The primary objective is very simple: to help a driver to see things that they may not otherwise see when reversing.

The camera is rated at IP68 which means it is impervious to dust and water. The camera offers a view of the rear bumper and blind spot when backing up. The camera can be mounted in various locations with or without the supplied adhesive or screw on bracket. A single connection is made to the reverse light circuit and ground. This can be done near the rear light cluster or inside the vehicle, whichever is the most convenient. A 3/16" connector is fed through or more typically under the vehicle and into the cabin where it is plugged into the 3.5" slimline monitor. No other connections or work is involved. When the vehicle is put into reverse gear, a sharp and vivid image is instantly displayed on the screen.

With the patented cable technology, installation should take around 30 - 45 minutes. No other system in the market is as quick and easy to install.



- Small, discreet, camera.
- Panoramic view.
- Instant image on.
- Single cable installation technology.
- Works seamlessly with supplied LCD monitor.
- Typically installed above number plate to include the rear bumper in the field of view.
- Outstanding image quality both day and night.
- IP68 rated (100% water and dust proof).



**Replacement Rear Surround Cameras**

**LR031790 NEW**  
Range Rover Sport - 2010 - 2013

**LR031812 NEW**  
Range Rover L322 - 2010 - 2012



**Parking Sensors**

*These bumper mounted sensors will detect the distance between your vehicle and any rear obstruction and warn the driver to any potential obstructions.*

**DA4511**  
Valeo Beep&Park Kit Rear Parking Assistance System



An advanced parking solution for obstacle detection at the rear of your vehicle. Reduce the risk of collision during reversing and reverse parking manoeuvres with this kit.

As the reverse gear is engaged, a sound indicates that the reverse sensors are activated. Any obstacle at the rear of the vehicle is then detected and signalled to the driver through a progressive sound whose frequency increases when moving closer to the obstacle.

Enhance your safety through obstacle detection, even when objects are out of the driver's field of vision.

Improve comfort through easy parking manoeuvres.

Suitable for 12v cars, SUVs and light commercial vehicles.

Add an extra set of 'eyes' when reversing...

- Kit contents include -
- 4 x Bumper fit sensors
  - 1 x Warning buzzer
  - 1 x Control unit
  - 1 x Wiring harness
  - 1 x Cutting tool
  - 1 x Fitting accessories
  - 1 x Installation instructions

\*Note - Sensors do not work with metal bumpers

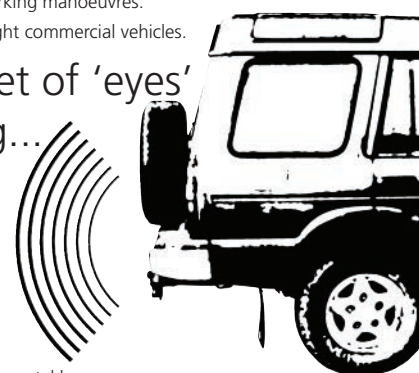

## Side Protection

### Rock Sliders

For more information and images of these rock sliders please visit [www.britpart.com](http://www.britpart.com)



**DA7533** Rock slider/side steps - pair Discovery 3 & Discovery 4

**DA7534** Aluminium finish **DA7534B** Black finish  
Discovery 3 & Discovery 4

**The best of both worlds with these fitted to your Discovery!**

**Rock slider** - an essential purchase for any off road use. They prevent damage to the underside sill of the vehicle and allow for safe passage over rocky and rough terrain.

**Side steps** - users often fit side steps to enable easy access to and from the car - this is a problem when going off road as they bend, break and cause snagging. These are heavy-duty side steps made from 5mm steel plate with 50mm tube backed up by an additional 2 x 40mm tube supports. The joints are TiG welded for a smooth OEM finish.

These rock sliders (sill protectors) are manufactured from 6mm 5083 aluminium and come completely machined and drilled ready to fit. An essential purchase for any off-road use as they prevent damage to the underside sill of the vehicle and allow for safe passage over rocky and rough terrain. Attaches to your vehicle using 11 mounting points on the side and underneath and when the car doors are closed they are almost unseen, but you have the piece of mind that your car sills are safe from damage. These units require no additional drilling just unscrewing and unclipping of the plastic OEM parts.

**DA1307 NEW** Defender 90 - 1983 onwards  
**DA1308 NEW** Defender 110 - 1984 onwards

Great protection for the side of your Defender and they replace the sill of your vehicle. These rock sliders are a fully welded steel construction with heavy-duty chassis mounted brackets and zinc primed with a smart black powder coated finish.



**For more side protection - see side & rear step section**

### Rubbing Strips

**VPLAP0013 NEW** Discovery 3/Discovery 4  
**DGJ500020PCL** Range Rover Sport - 2005 - 2013

Protect your bodywork from dents and scrapes with a smart set of 4 solid and durable bodyside moulding strips.



### Wheel Arch Kits



#### Standard Wheel Arch Kits

**DA1059** Defender - all models 4 eyebrows and rivets  
**DA1140** Discovery 2 Front/Rear & RHS/LHS

Replace any faded or damaged wheel arches with this OEM replacement wheel arch kit

#### Off-Road Wheel Arch Kits

2.5" wheel arch kits. Wings need cutting for fitment.

**DA2364** Discovery 1/Range Rover Classic 3-door  
**DA2365** Discovery 1/Range Rover Classic 5-door

2" wider than standard enabling tyres up to 14" wide and/or wheel spacers to be fitted while being legal for MOT testing. Made from an unbreakable plastic - ideal for extreme off-road use.

**DA2366** Defender 90/110 - 1984 onwards

These two Discovery 2 wheel arches enable larger tyres to be fitted while still being legal as these arches cover the tyres when wider tyres are fitted. The 50mm ones are required for large off set wheels while the 75mm arches will cover the tyres when wheel spacers are used. They are virtually indestructible and all fixings are supplied with the kit. Up to 35" diameter tyres are ok with a 2" lift and these arches as just over 40mm is cut out of the wings when fitting them.

**DA1960** Discovery 2 50mm  
**DA1961** Discovery 2 75mm

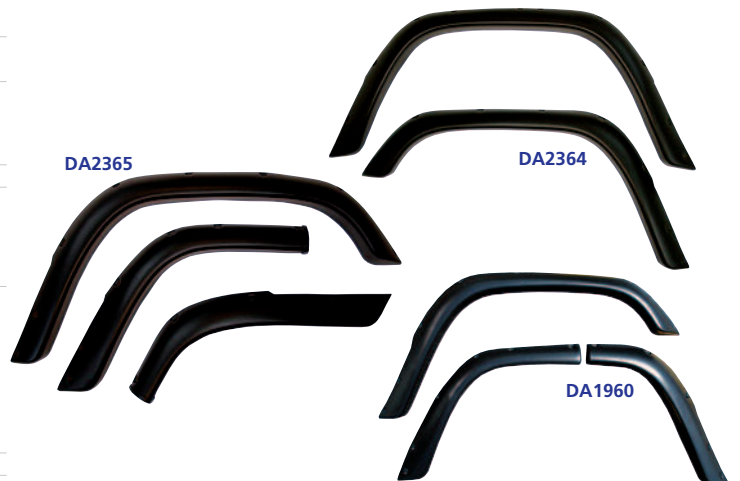

**Underside Protection**  
Steering/Sump & Transmission Guards

**Sump guards**

These guards from Britpart are manufactured from high-quality, hard-wearing and corrosion resistant materials to counteract any unforeseen obstacles your Land Rover may encounter whilst off-roading. All fixings are supplied and the guards fit into the vehicle's pre-existing holes. Each guard has holes at the front to allow for water drainage and also to help with ventilation for the cooling system.

<b>DA2228</b>	Defender - 1985 -2006 & 2007 onwards	RHD & LHD	Galvanised steel	Main plate - 4mm thick; brackets - 6mm thick
<b>DA5507</b>	Defender - 1985 -2006 & 2007 onwards	RHD	Aluminium	Main plate - 8mm thick; brackets - 8mm thick
<b>DA5507LHD</b>	Defender - 1985 -2006 & 2007 onwards	LHD	Aluminium	Main plate - 8mm thick; brackets - 8mm thick
<b>DA5508</b>	Discovery 1/Range Rover Classic	RHD & LHD	Aluminium	Main plate - 8mm thick; brackets - 8mm thick
<b>DA2249</b>	Discovery 2	RHD & LHD	Powered coated steel	Main plate - 5mm thick; brackets - 5mm thick

**Note** - For use with Discovery 2 winch bumper DA5645

An essential purchase for any off road use as they prevent damage to the underside of the engine and the intercooler at the front of the vehicle. Manufactured from 8mm 5083 aluminium with a smart silver or black finish and supplied completely machined and drilled ready to bolt directly to the 4 pre-drilled holes in the chassis with supplied galvanised fixings. The guard requires no additional drilling just unscrewing and clipping of the plastic OEM parts. Fitting should take 5 minutes.

Discovery 3	<b>DA7530</b>	Silver finish	<b>DA7530B</b>	Black finish
Discovery 4	<b>DA7535</b>	Silver finish	<b>DA7535B</b>	Black finish

**Sump plate**

**DA7536** Discovery 3

This sump plate protects the underside of the engine and allows the car to slide over objects, forward and backwards due the rear lip. With a natural finish the plate is made from 6mm 5083 grade aluminium and has been water jet cut to a precise finish. Plate bolts directly into existing holes and bulkheads already in the chassis, using the standard Land Rover fixings.

**Transmission Guards**

**DA5625** Defender - Td5

Reduce damage to your Defender 90. Made from galvanised steel, this transmission guard protects your 90's gear box and cross members from snagging and reduces damage to your vehicle. Bolts on and is easy to fit and importantly it is also easy to remove when your vehicle needs servicing. **Note** - Only fits with centre exhaust removed and pipe fitted.

**DA7532** Discovery 3

This transmission plate protects the underside of the transmission and allow the car to slide over objects. With a natural finish the plate is made from 6mm 5083 grade aluminium and water jet cut to a precise finish. Plate bolts directly into existing holes and bulkheads already in the chassis, using the standard Land Rover fixings and two additional fixings. **Note** - Can only be fitted when sump plate (DA7536) is also fitted.

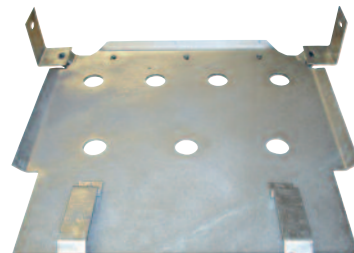

Added **protection** from those hidden dangers when off-roading!

**Fuel Cooler Guard NEW**



**DA6540**  
Defender - Tdci  
Protect the Defender's vulnerable fuel cooler with this easy to fit electro-plated guard.



**Diff Guard**

**DA2250B**  
Defender/Discovery 1/Range Rover Classic

Give your vehicle some extra protection with a diff guard. This guard is simple to fit (no drilling) and has the added advantage of having the fill plug accessible at all times. With electroplate finish.



## Swivel Housing Gaiter Kits



DA3057

- Bond in place under existing flange
  - Completely seals against dust, water and grit
  - Moulded in high performance neoprene rubber
  - No special tools required
  - Proven tongue and groove for easy assembly
  - Two year guarantee
  - Kit includes two gaiters, metal straps, bonding agent, gloves and full instructions
- Permanent protection** for swivels, spheres and joints!
- DA3056** Series  
**DA3057** Defender/Discovery 1/Range Rover Classic  
**DA3057GLUE** Additional bonding agent for DA3056 & DA3057  
 For easier fitment of gaiter without dismantling the axle assembly

## Universal Joint Silicone Sleeves



*Protection for your rear universal joint.*

DA4810

DA4811

- DA4810** Rear UJ silicone sleeve for 63mm diameter propshafts  
**DA4811** Rear UJ silicone sleeve for 51mm diameter propshafts  
 Suitable for Series, Defender, Discovery 1, Discovery 2 & Range Rover Classic.  
 By adding one of these silicone sleeves you will reduce debris from building up in the universal joint which, in time, will increase the life span of the joint.

## Wind Deflectors



DA6078



DA6070



DA6071



DA6072



DA6073



DA6077



DA6074



DA6076



DA6107



DA6075



DA6108



DA6093



DA6094

*The Britpart wind deflectors will reduce buffeting and wind noise when driving with the window open. Custom designed for each vehicle and easily attached - no drilling required for fitment!*

<b>DA6078</b>	Defender/Series	Front	2 piece kit
<b>DA6070</b>	Discovery 1	Front & rear	4 piece kit
<b>DA6071</b>	Discovery 2	Front & rear	4 piece kit
<b>DA6072</b>	Discovery 3/Discovery 4	Front & rear	4 piece kit
<b>DA6073</b>	Freelander 1 - 2 door	Front	2 piece kit
<b>DA6077</b>	Freelander 1	Front & rear	4 piece kit
<b>DA6074</b>	Freelander 2	Front & rear	4 piece kit
<b>DA6070</b>	Range Rover Classic	Front & rear	4 piece kit
<b>DA6076</b>	Range Rover Sport - 2005 - 2013	Front & rear	4 piece kit
<b>DA6107 NEW</b>	Range Rover Sport - 2014 onwards	Front & rear	4 piece kit
<b>DA6075</b>	Range Rover L322	Front & rear	4 piece kit
<b>DA6108 NEW</b>	Range Rover L405	Front & rear	4 piece kit
<b>DA6093</b>	Range Rover Evoque - 3 door	Front	2 piece kit
<b>DA6094</b>	Range Rover Evoque - 5 door	Front & rear	4 piece kit



## Section contents

<b>Side &amp; rear steps</b>	
Defender	18
Discovery	19
Freelander	20
Range Rover	21

“Add some smart new steps to your Land Rover for assistance with getting in and out, or replace any old damaged steps with a new set.”

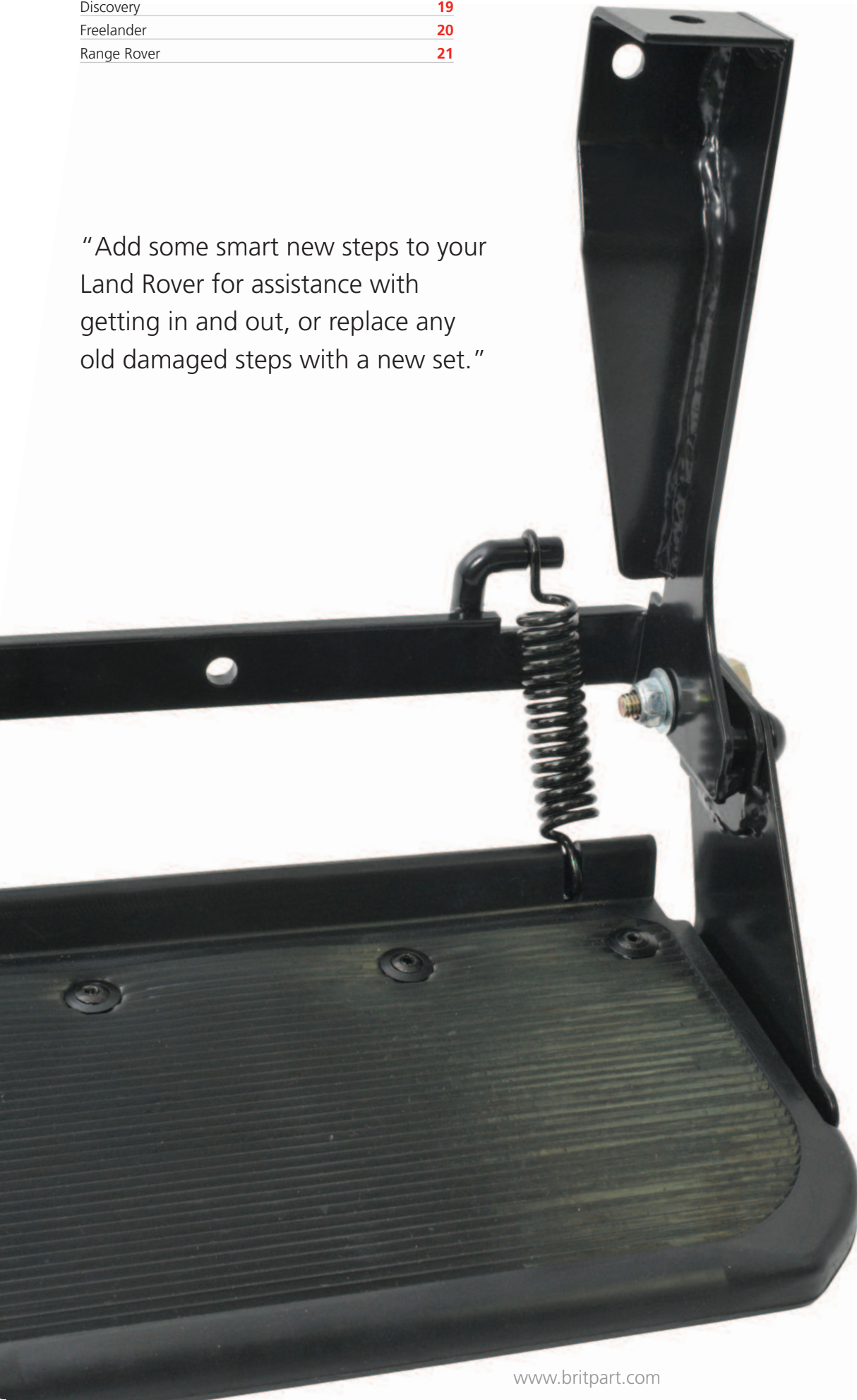

side & rear steps

## Defender

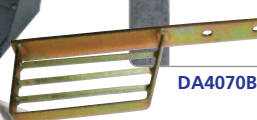
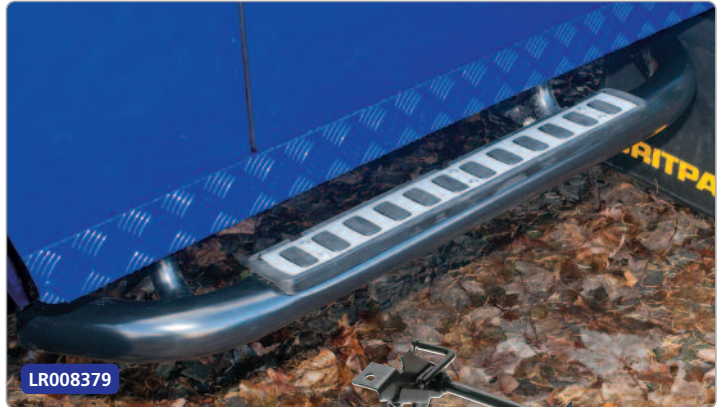

*For rock sliders - see exterior protection section*

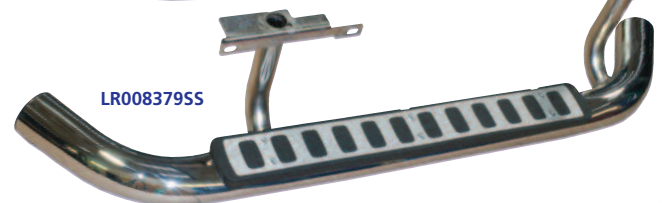
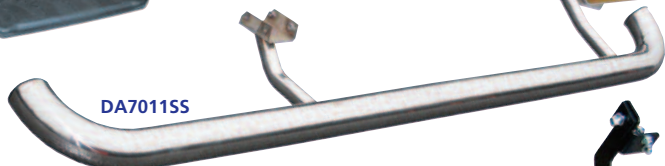

### Side Protectors

<b>DA7012</b>	Defender 90	Black with chequer plate top	Pair
<b>DA7012SS</b>	Defender 90	Stainless steel	Pair
<b>DA7011</b>	Defender 110	Black with chequer plate top	Pair
<b>DA7011SS</b>	Defender 110	Stainless steel	Pair

### Side Steps

<b>DA4101</b>	Defender 90	Black with rubber top	Pair
<b>DA4060</b>	Defender 110	Black with rubber top	Pair
<b>STC7631</b>	All models	Folding side step with rubber top	Single
<b>STC7631MT</b>	All models	Folding side step with rubber tyre tread top	Single
<b>DA4814</b>		Replacement rubber top with tyre tread pattern for STC7631	Single

Fire & Ice style - black with rubber and anodised aluminium top			Pair
<b>LR008379</b>	Defender 90 – 2003 ->/Defender 110 – 2-dr pick-up – 2003 ->		
<b>LR008375</b>	Defender 110 – 2003 -> - not 2-dr pick-up		

Fire & Ice style - stainless steel with rubber and anodised aluminium top			Pair
<b>LR008379SS</b>	Defender 90 – 2003 ->/Defender 110 – 2-dr pick-up – 2003 ->		
<b>LR008375SS</b>	Defender 110 – 2003 -> - not 2-dr pick-up		

Black with rubber and anodised aluminium chequer plate top			Pair
<b>LR029295/7KIT</b>	Defender 90 – 2003 ->/Defender 110 – 2-dr Pick-up – 2003 ->		
<b>LR029294KIT</b>	Defender 110 – 2003 -> - not 2-dr pick-up		

### Rear Steps

<b>STC50269AA</b>	Defender 90 - XA onwards	Rear step - inc. regulation tow bracket	
<b>STC50301</b>	Defender 110 - XA onwards	Rear step - inc. regulation tow bracket	
<b>DA4070</b>	All models	Rear tow ballstep - double with zinc plated finish Will also fit any vehicle with a drop plate tow hitch.	
<b>DA4070B</b>	All models	Rear tow ballstep - double with black Will also fit any vehicle with a drop plate tow hitch.	
<b>STC7632</b>	All models	Folding rear door step with rubber top	
<b>STC7632MT</b>	All models	Folding rear door step with rubber tyre tread top	
<b>DA4818</b>		Replacement rubber top with tyre tread pattern for STC7632	Single



<b>Discovery 1</b>			
RTC9505AC	Rear retractable step		
RTC9593AA	Spare shock absorber for rear retractable step (RTC9505AC)		
STC8130AB	Side steps	Chevron tread	Pair
<b>Discovery 2</b>			
STC50290	Rear retractable step - up to 1A298103		
KVL100040	Spare shock absorber for rear retractable step (STC50290)		
STC50030	Side steps - including mudflaps	Chevron tread	Pair
STC50032	Side steps - including mudflaps	Stainless steel	Pair
<b>Discovery 3</b>			
VTD500010	Black steel side protection tubes		Pair
VTD500020	Stainless steel side protection tubes		Pair
VTK500010	Side steps		Pair
VPLAP0035	With polypropylene side step top and a brushed aluminium side trim		
<b>Discovery 4</b>			
VTD500010	Black steel side protection tubes		Pair
VTD500020	Stainless steel side protection tubes		Pair
VTK500010	Side steps		Pair
VPLAP0035	With polypropylene side step top and a brushed aluminium side trim		
<b>Discovery Sport</b>			
VPLCP0210 <b>NEW</b>	Side steps		Pair
VPLCP0209 <b>NEW</b>	Side step tubes		Pair



**DA7533** Rock slider/side steps - pair Discovery 3 & Discovery 4

**The best of both worlds with these fitted to your Discovery!**

**Rock slider** - an essential purchase for any off road use. They prevent damage to the underside sill of the vehicle and allow for safe passage over rocky and rough terrain.

**Side step** - users often fit side steps to enable easy access to and from the car - this is a problem when going off road as they bend, break and cause snagging. These are heavy-duty side steps made from 5mm steel plate with 50mm tube backed up by an additional 2 x 40mm tube supports. The joints are TiG welded for a smooth OEM finish.

The other benefit of this rock slider/side step combo is that the outer 'bar' pushes away small trees and scrub from the bodywork of the vehicle. They can also be used to 'slide' around thick trees when grip is minimal. These units require no additional drilling just unscrewing and unclipping of the plastic OEM parts. Fitment should take 15 minutes each side. Grip tape supplied loose for optional fitment.

## Freelander



<b>Freelander 1</b>		
<b>STC53077</b>	Side steps Black	Pair
<b>STC53078</b>	Side steps Stainless steel	Pair

<b>Freelander 2</b>		
<b>LR002773</b>	Side steps With thermo plastic elastomer side step top and a brushed aluminium side trim	Pair
<b>LR003318</b>	Side protection tubes Stainless steel	Pair



**Range Rover**

**Range Rover Classic**  
**STC8130AB** Side steps - black rubber Pair

**Range Rover P38**  
**STC8505AA** Side steps Pair  
**Note** - Include mudflaps

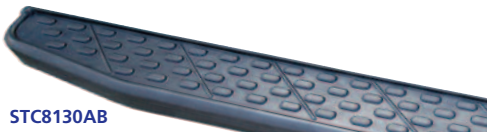

**Range Rover L322**  
**VUB001230** Stainless steel side protection tubes Pair  
**VUB002510** Black steel side protection tubes Pair  
**Note** - Can be fitted with or without front mudflaps  
**VUB503660** Side steps Pair  
 Including front mudflaps with EPDM (synthetic rubber) top and hard plastic trimming  
**VUB001300** Right hand side Single  
 Side step replacement insert moulding for VUB503660  
**VUB001310** Left hand side Single  
 Side step replacement insert moulding for VUB503660



**Range Rover Sport - 2005 - 2013**  
**VTK500020** Side steps Pair  
 With thermo plastic elastomer side step top and a brushed aluminium side trim



**Range Rover Evoque**  
**VPLVP0071** Stainless steel side protection tubes Pair  
**VPLVP0184** **NEW**



You can now find all the latest Britpart news on Facebook!

[facebook.com/britpart](https://facebook.com/britpart)



## Make Your Land Rover A Star!

Here are some of the previous winners...



Here at Britpart we are planning our next Land Rover themed calendar and we'd love to feature the pictures of proud Land Rovers owner's vehicles – whatever model, age or condition of the vehicle.

We'd love to see pictures of Land Rovers in locations stretching from rural UK, right through to vehicles in a foreign urban environment - use your imagination.

Winning entries will all feature in the next Britpart calendar and each one picked will win a great prize.

So get out there with your Land Rover and camera - happy snapping. You can send us as many entries as you would like! **Good luck!**

### Prizes

**There will be 12 prizes awarded –**

**1 x first prize:** £250 cash prize, 10 copies of the calendar with the winning image on the front cover and featured inside the calendar and a large Britpart goodie hamper.

**11 x second prizes:** 5 copies of the calendar and a Britpart goodie hamper.

Details on how to enter and full terms and conditions - [www.britpart.com/calendar](http://www.britpart.com/calendar)

[www.britpart.com](http://www.britpart.com)

## Section contents

Bike racks	24
Bungeeclic load securing system	30
Ladders	24
Roll Cages	29
<b>Roof racks &amp; boxes</b>	
Britpart Expedition	27
Front Runner	26
Galvanised roof rack kits	25
Land Rover	27
Mont Blanc	26
ProSpeed	29
Safety Devices	28
Thule	25

“Got a bigger than usual load to carry?  
We’ve got racks and luggage boxes to suit all  
Land Rovers and all kinds of different loads.”



racks & luggage boxes

## Bike Racks



**DA5022** Westfalia towbar mounted cycle carrier - 2 bikes  
**DA5023** 7-pin to 13-pin adaptor. To use on vehicles with 7-pin towing electric sockets

The Westfalia Cycle Carrier is an innovative and flexible system that allows you to transport your cycles easily, helping make your journey more relaxing and enjoyable. The Cycle Carrier is a highly versatile, foldable, towbar mounted, carrier system. Plenty more information and images at [www.britpart.com/westfalia](http://www.britpart.com/westfalia)



<b>DA4118</b>	Discovery 1 - mount to the spare wheel carrier & are easy to fit	4 Bikes
<b>DA4119</b>	Discovery 2 - mount to the spare wheel carrier & are easy to fit	4 Bikes
<b>DA4121</b>	Freelander 1 - mount to the spare wheel carrier & are easy to fit	3 Bikes
<b>STC50063</b>	Discovery 2/Discovery 3/Discovery 4/Range Rover Sport - 2005 - 2013	2 Bikes
<b>LR006847</b>	Thule cycle carrier. Raised roof rails & crossbar kit required - for more information see Thule page	1 Bike
<b>DA4316</b>	'Scott' - cycle carrier - for more information see Mont Blanc page	1 Bike
<b>DA4317</b>	'Barracuda' - cycle carrier - for more information see Mont Blanc page	1 Bike

## Ladders



Easier access to your roof rack.

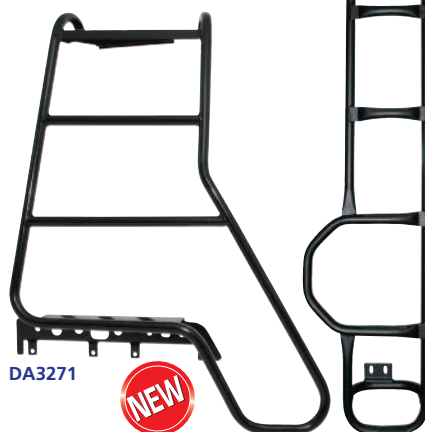

**RBL05265SS**

<b>DA1089</b>	Defender 90/110 Series SWB/LWB	Galvanised
<b>DA3073</b>	Defender 90/110	Grey
<b>DA3073B</b>	Defender 90/110	Black
<b>DA4710</b>	Defender 90/110 Safety Devices' ladder	Black
<b>STC50417</b>	Defender 90/110	Black
<b>STC50134</b>	Discovery 2	Black
<b>DA3271 NEW</b>	ProSpeed ladder	Black
<b>AGP780020LR</b>	Discovery 3/Discovery 4	Black
<b>RBL05265SS</b>	Discovery 3/Discovery 4	Black

A rear ladder mounted from Safety Devices' Defender 90 and 110 roll cage and Defender lower chassis mounting points.



**Roof Racks & Boxes**  
Galvanised Roof Rack Kits



DA1089

**Short Wheel Base Flat Packed Galvanised Roof Racks**  
**DA1093** Defender 90/Series SWB Flat floor  
**DA1091** Defender 90/Series SWB Contour floor  
 Length 1,990mm (78<sup>1</sup>/<sub>2</sub>""); height 420mm (16<sup>1</sup>/<sub>2</sub>"");  
 width 1,460mm (57<sup>1</sup>/<sub>2</sub>""); weight 25kgs

**Long Wheel Base Flat Packed Galvanised Roof Racks**  
**DA1090** Defender 110/Series LWB Flat floor  
**DA1092** Defender 110/Series LWB Contour floor  
 Length 2,800mm (110<sup>1</sup>/<sub>2</sub>""); height 420mm (16<sup>1</sup>/<sub>2</sub>"");  
 width 1,460mm (57<sup>1</sup>/<sub>2</sub>""); weight 30.5kgs

**DA1089** Ladder - for above kits Galvanised

**Note** - Contour racks must **NOT** be used on vehicles fitted with a sunroof.



DA1091

**CONTOUR FLOOR**

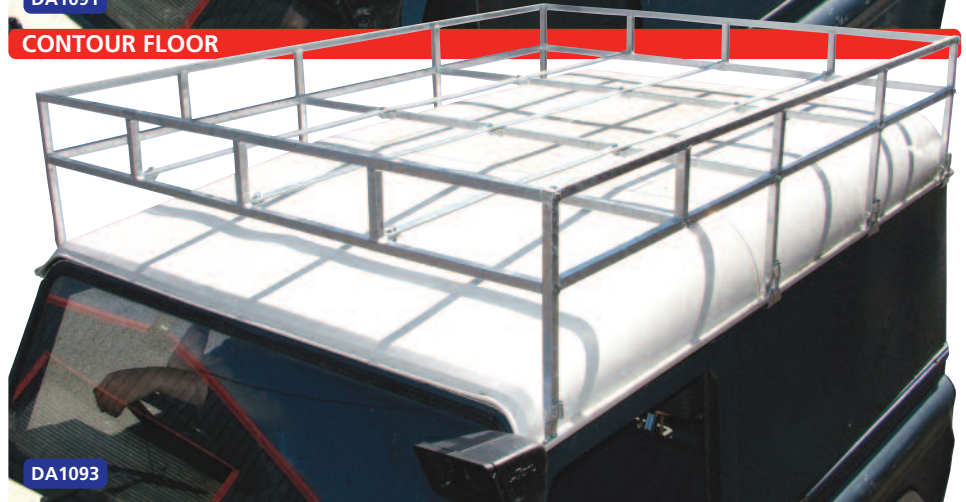

DA1093

**FLAT FLOOR**

**Roof Bars** - with maximum load weight of 80kg and complete with a pair of black square bars.

<b>DA2990</b>	Defender - 90/110	Gutter mount fitment	1,630mm wide
<b>DA2990</b>	Discovery 1	Gutter mount fitment	1,630mm wide
<b>STC7639</b>	Discovery 1	Raised roof rail fitment	1,200mm wide
<b>DA4323</b>	Discovery 2	Raised roof rail fitment	1,350mm wide
<b>DA2991</b>	Discovery 2 - with modified trim	Gutter mount fitment	1,630mm wide
<b>DA4325</b>	Discovery 3	Fixed points fitment	1,270mm wide
<b>DA4324</b>	Discovery 3	Raised roof rail fitment	1,270mm wide
<b>DA4325</b>	Discovery 4	Fixed points fitment	1,270mm wide
<b>DA4329</b>	Freelander 1	Raised roof rail fitment	1,080mm wide
<b>STC7639</b>	Freelander 1	Raised roof rail fitment	1,200mm wide
<b>DA4328</b>	Freelander 1 - 1998 - 2003 - 3-door & 5-door	Clamp style fitment	1,200mm wide
<b>DA4326</b>	Freelander 2	Clamp style fitment	1,350mm wide
<b>DA4327</b>	Freelander 2	Raised roof rail fitment	1,270mm wide
<b>DA3002</b>	Range Rover Classic	Gutter mount fitment	1,500mm wide
<b>DA2993</b>	Range Rover P38	Fixed points fitment	1,200mm wide
<b>DA2996</b>	Range Rover Sport - 2005 - 2013	Clamp style fitment	1,500mm wide
<b>DA4330</b>	Range Rover L322	Clamp style fitment	1,500mm wide
<b>DA4324</b>	Range Rover Evoque - 5-door	Raised roof rail fitment	1,270mm wide

**THULE**  
SWEDEN  
**CAR RACK SYSTEMS**

**Cycle Carrier**  
**LR006847**

- The smartest, most elegant solution for loading and transporting a bike on the roof
- The self-adjusting and upright frame holder into which the bike automatically slides, makes bike loading easy
- Adjusting and securing is done comfortably and quickly, with a turning knob, at roof height
- Quick-release straps, adjustable for different wheel sizes, hold the wheels securely in place
- Light and convenient aluminium design
- Can easily be fitted on either side of the car roof
- Lockable - bike to bike carrier, bike carrier to load carrier
- Fits frame dimensions up to 100mm

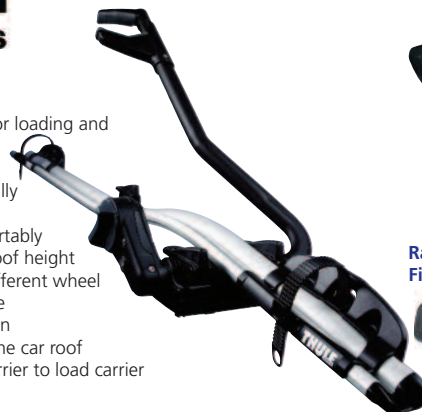

**Thule**



**Gutter Mount Fitment**



**Clamp Style Fitment**



**Fixed Points Fitment**



**Raised Roof Rail Fitment**

Photograph courtesy of Simon Ellingworth

## Mont Blanc



DA4332

### Roof Boxes

<b>DA4332</b>	Vista 540 - full width	540 litres	2,000 x 950 x 420mm (LxWxH)	Weight - 17kg
<b>DA4331</b>	Vista 380 - half width	380 litres	2,000 x 650 x 450mm (LxWxH)	Weight - 15kg

- Lock up struts - new improved design with side opening for ease of loading
- Three point central lock system
- 80mm width fixings to suit most roof bar sizes
- UV resistant, high impact ABS
- Load securing straps included

For full technical specifications and photographs on all roof bars & rails please see [www.britpart.com/montblanc](http://www.britpart.com/montblanc)



DA2311

<b>DA4333</b>	Triton 450	430 litres	1,970 x 830 x 380mm (LxWxH)	Weight - 18kg
---------------	------------	------------	-----------------------------	---------------

- Premium roof box range with modern design for all kind of activities
- Made of UV-resistant ABS plastic with gas struts for soft opening and closing of box
- Three point central locking
- Load securing straps included
- Flexible attachment to the load bar
- Fits both square bars and aluminium bars with C-slots
- Unique quick attachments - the box is attached from the inside

For full technical specifications on all roof boxes please see [www.britpart.com/montblanc](http://www.britpart.com/montblanc)

# MONT BLANC®

### Roof Bars & Rails

- 3 part roof bar kit which is tailored to suit the vehicle and easily fits to the roof with locks included.

<b>DA4312</b>	Discovery 3	Roof bar FlexiKit 3	Max load - 100kg	Weight - 4.5kg
<b>DA4314</b>	Range Rover Sport - 2005 - 2013	Roof bar FlexiKit 3	Max load - 100kg	Weight - 4.5kg
<b>DA4319</b>	Range Rover L322	Roof bar FlexiKit 3	Max load - 100kg	Weight - 4.5kg

- For vehicles with factory fitted roof rails.

<b>DA4311</b>	Freelander 1	Roof bar FlexiKit 2	Max load - 100kg	Weight - 3.3kg
---------------	--------------	---------------------	------------------	----------------

- 2 part roof bar kit which easily fits to the roof.

<b>DA2311</b>	Defender	Classic roof bars	Max load - 100kg	Weight - 5.0kg
<b>DA2315</b>	Range Rover P38	Classic roof bars	Max load - 100kg	Weight - 5.0kg

- Universal fitting for vehicles with standard factory fitted roof rails.

<b>DA2312</b>	Discovery 1	Classic roof bars	Max load - 100kg	Weight - 3.4kg
<b>DA2310</b>	Freelander 1	Classic roof bars	Max load - 100kg	Weight - 3.3kg



DA4314



DA4311



DA2310



DA4316

DA4317

## Front Runner

- All aluminium construction, fully welded
- Powder coated finish
- Patented slat, with grooves to accommodate 8mm bolt
- Modular design – allow accessories to be mounted and removed as need without drilling
- Rail towards the rear, open in the front
- Gutter mount stainless steel clamps

<b>DA3075</b>	Discovery 1/Discovery 2	Short rack	Silver
<b>DA3077</b>	Freelander 1	Full rack	Silver
<b>DA3086</b>	Freelander 1	Full rack - original mountings	Silver



DA3075



DA3077

- **DA4316** 'Scott' - cycle carrier
  - Stable easy-to-use roof mounted cycle holder
  - Takes frame diameters from 30mm up to 80mm
  - Lockable to roof rack as well as bicycle
  - Frame holder with quick attachment for easy fitting without tools
  - Wheels rest in adjustable wheel holders and are fastened with strong securing straps
  - Can be fitted on all standard load bars and aluminium profiles
  - Maximum load - 17kg
- **DA4317** 'Barracuda' - cycle carrier
  - Unique free stand feature enables ease of loading
  - Secured in the frame holder and locks to both bicycle carrier and roof bars
  - Chromium-plated frame holder tube in special steel
  - Base unit made of UV-resistant composite material
  - Takes frame diameters from 20 up to 80 mm
  - Manufactured in accordance with DIN 75302
  - Will fit to both standard and aluminium bars
  - CityCrash approved
  - Maximum load - 15kg



Photograph courtesy of Martin Port



These roof racks are manufactured from aluminium with a smart black powder coated finish. Fully welded, they are extremely strong, versatile and easy to use. The floor plank profiles are orientated longitudinally which results in a reduction in wind noise. There are nut channels on all the extrusions to allow for easy fitment of accessories.

- DA3072**  
Defender 90  
3 feet per side  
Weight - 32kgs  
Dimensions - 2.05m long x 1.50m wide  
Vehicle gutter to top of rack - 265mm
- DA3070**  
Defender 110  
4 feet per side  
Weight - 38kgs  
Dimensions - 2.75m long x 1.50m wide  
Vehicle gutter to top of rack - 265mm
- DA3269**  
Defender 110 Double cab pickup  
Defender 130 Double cab pickup  
3 feet per side  
Weight - 27kgs  
Dimensions - 1.60m long x 1.50m wide  
Vehicle gutter to top of rack - 265mm



DA3070



- DA6537 NEW**  
Discovery 3 & Discovery 4  
4 feet per side  
Weight - 23kgs  
Dimensions - 2.30m long x 1.26m wide  
Roof to top of rack - 120mm  
**Note** - May need roof rail kit (CAB500120PVJ or CAP500090) to be fitted to vehicle prior to roof rack installation.

More images online at [www.britpart.com](http://www.britpart.com)

Extremely strong, versatile and easy to use...

Land Rover

<b>Defender</b>						
<b>VPLDR0063</b>	Defender 90	Roof rack	1,600mm			
<b>VPLDR0064</b>	Defender 110	Roof rack	2,400mm			
<b>STC7582</b>	Defender - all models	Roof bars	Sports			
<b>Discovery</b>						
<b>STC8057AC</b>	Discovery 2	Roof bars	Sports			
<b>VPLAR0001</b>	Discovery 3/Discovery 4	Roof rack cross bars				
<b>LR006848</b>	Discovery 3/Discovery 4	Roof rack luggage carrier				
		Use in conjunction with roof cross bars				
<b>LR006849</b>	Discovery 3/Discovery 4	Roof ski carrier				
		Use in conjunction with roof cross bars				
<b>Freelander</b>						
<b>STC50433</b>	Freelander 1	Roof rack	Expedition			
<b>LR002417</b>	Freelander 2	Roof rack cross bars				
<b>LR006848</b>	Freelander 2	Roof rack luggage carrier				
		Use in conjunction with roof cross bars				
<b>LR006849</b>	Freelander 2	Roof ski carrier				
		Use in conjunction with roof cross bars				
<b>Range Rover</b>						
<b>STC50176AA</b>	Range Rover Classic	Luggage cross bars				
<b>LR006849</b>	Range Rover P38	Roof ski carrier				
<b>CAB500130PMA</b>	Range Rover Sport 2005 - 2013	Roof rack luggage carrier	Expedition			
<b>LR006848</b>	Range Rover Sport 2005 - 2013	Roof rack luggage carrier				
		Use in conjunction with roof cross bars and rails				
<b>VUB502130</b>	Range Rover Sport 2005 - 2013	Roof rack cross bars and rails				
<b>LR006849</b>	Range Rover Sport 2005 - 2013 & 2014 onwards	Roof ski carrier				
<b>CAB500070PMA</b>	Range Rover L322	Roof rack luggage carrier	Expedition			
<b>LR006848</b>	Range Rover L322	Roof rack luggage carrier				
	Range Rover L405	Use in conjunction with roof cross bars				
<b>LR006849</b>	Range Rover L322	Roof ski carrier				
	Range Rover L405	Use in conjunction with roof cross bars				
<b>LR006848</b>	Range Rover Evoque	Roof rack luggage carrier				
		Use in conjunction with roof cross bars				
<b>LR006849</b>	Range Rover Evoque	Roof ski carrier				
		Use in conjunction with roof cross bars				



LR006849



Great gift ideas in the Miscellaneous section...



## Safety Devices Roof Racks



DA4703/DA4704



**Short luggage rail** with rain gutter mount, ideal for side loaded tents.

**Long luggage rail** with rain gutter mount, ideal for front or back loaded tents.



DA4710



DA4722



DA4720/DA4721



DA4718

### Safety Devices Explorer Roof Rack Range

- Heavy-duty steel roof rack.
- Explorer roof racks can be affixed with a system of detachable roof cross rails to the rainwater gutters or with aluminium clamps to fit directly on to the majority of Safety Devices' external roll cages.
- A rain gutter mounted roof rack can be converted in to a roll cage mounted roof rack with the appropriate fitting kit.
- The standard pack includes a steel roof rack, fixing bolts and optional roof cross rails.
- Roof racks are grit blasted, primed with a zinc enriched powder undercoat, and finished with a durable black powder coat.
- Not compatible with a sunroof.
- Tents can normally be affixed to the roof rack without a floor, although a marine ply non-slip floor is also available.
- Additional roof cross rails are available to purchase for use without a roof rack for use as, for example, a roof bar, basic tent support, attaching a roof storage box or to spread additional load on the Safety Devices' roof racks.

#### Defender 90 Hard Top and Station Wagon

3 roof cross rails as standard and can accommodate 2 additional roof cross rails.

<b>DA4702</b>	Short luggage rail	Gutter mount	2.0m x 1.4m	32kgs
<b>DA4712</b>	Short luggage rail	Roll cage mount	2.0m x 1.4m	30kgs
<b>DA4703</b>	Long luggage rail	Gutter mount	2.0m x 1.4m	32kgs
<b>DA4713</b>	Long luggage rail	Roll cage mount	2.0m x 1.4m	30kgs
<b>DA4704</b>	Marine ply floor		2.0m x 1.4m	16kgs

Refer to owners handbook for recommended maximum weight.

#### Defender 110 Hard Top and Station Wagon

4 roof cross rails as standard and can accommodate 3 additional roof cross rails.

<b>DA4705</b>	Short luggage rail	Gutter mount	2.8m x 1.4m	42kgs
<b>DA4714</b>	Short luggage rail	Roll cage mount	2.8m x 1.4m	40kgs
<b>DA4706</b>	Long luggage rail	Gutter mount	2.8m x 1.4m	42kgs
<b>DA4715</b>	Long luggage rail	Roll cage mount	2.8m x 1.4m	40kgs
<b>DA4707</b>	Marine ply floor		2.8m x 1.4m	23kgs

Refer to owners handbook for recommended maximum weight.

#### Defender 110 and 130 Double Cab/Crew Cab Pick-Up

2 roof cross rails as standard and can accommodate 2 additional roof cross rails.

Not compatible with ladders.

<b>DA4708</b>	Short luggage rail	Gutter mount	1.6m x 1.4m	26kgs
<b>DA4709</b>	Marine ply floor		1.6m x 1.4m	12kgs

Refer to owners handbook for recommended maximum weight.

<b>DA4711</b>	Additional roof cross rail			4kgs
<b>DA4710</b>	Roof ladder			6.5kgs

Mounts to rain gutter and cross-member.

For use with DA4702, DA4703, DA4705 & DA4706



DA4711

### Safety Devices 'G4 Expedition' Roof Rack Range NEW

- An 'all in one' rack without detachable parts and a luggage rail which completely surrounds the roof rack.
- The roof rack neatly follows the profile of the roof to provide two floor levels and fixes to the rainwater gutter only. This roof rack cannot be fitted to a vehicle where an external roll cage has been fitted.
- Includes 4 spotlight brackets at the front and 1 spotlight bracket at the rear.
- Heavy duty steel roof rack, grit blasted, primed with a zinc enriched powder undercoat, and finished with a durable black powder coat.
- Does not allow a sunroof to be opened.
- Not compatible with a roof tent.
- Standard pack includes a steel roof rack and rain gutter fixing bolts.

#### Defender 90 Station Wagon or Hard Top

<b>DA4718 NEW</b>	1.9m x 1.2m roof rack with full luggage rail for mounting to rain gutter.	30kgs
	Dimensions refer to the usable loading area.	
<b>DA4719 NEW</b>	Marine ply floor (two floor levels)	12kgs
	Upper section - 1,220mm (w) x 1,405mm (l) x 10mm (h)	
	Lower section - 1,220mm (w) x 540mm (l) x 10mm (h)	
<b>DA4722 NEW</b>	Ladder which mounts to roof rack and chassis.	8kgs
	Only suitable for attaching to DA4718 & DA4720	

#### Defender 110 Station Wagon or Hard Top

<b>DA4720 NEW</b>	2.6m x 1.2m roof rack with full luggage rail for mounting to rain gutter.	40kgs
	Dimensions refer to the usable loading area.	
<b>DA4721 NEW</b>	Marine ply floor (two floor levels)	15kgs
	Upper section - 1,220mm (w) x 2128mm (l) x 10mm (h)	
	Lower section - 1,220mm (w) x 540mm (l) x 10mm (h)	
<b>DA4722 NEW</b>	Ladder which mounts to roof rack and chassis.	8kgs
	Only suitable for attaching to DA4718 & DA4720	

For more Safety Devices roof rack images  
[www.britpart.com/safety-devices-racks](http://www.britpart.com/safety-devices-racks)

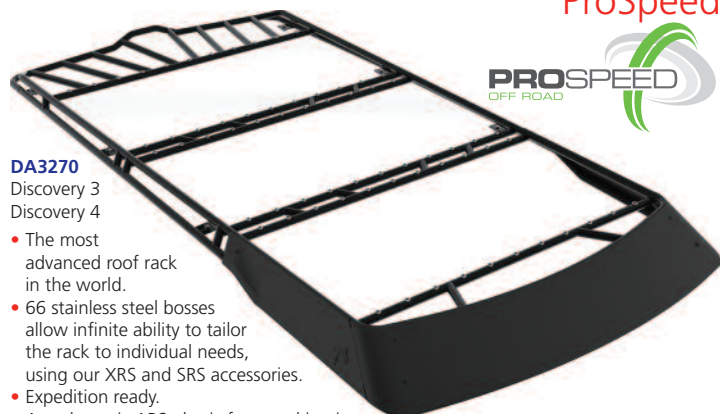
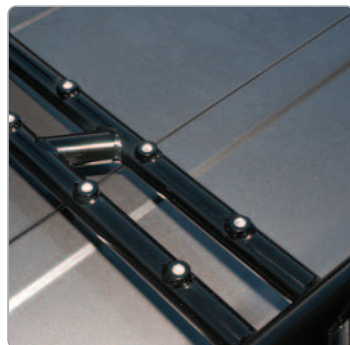

**DA3270**  
Discovery 3  
Discovery 4

- The most advanced roof rack in the world.
  - 66 stainless steel bosses allow infinite ability to tailor the rack to individual needs, using our XRS and SRS accessories.
  - Expedition ready.
  - Aerodynamic ABS plastic front making it tough, silent, fuel efficient, and sleek.
  - It weighs just 21kgs making it the lightest full length roof rack available.
  - 200kgs carrying capacity.
  - Three layer powder coat process for tough corrosion protection.
  - CAD designed for optimum fit and function.
  - CNC manufactured for ultimate precision.
  - Robot welded for maximum strength.
- Note** - May need roof rail kit (CAB500120PVJ or CAP500090) to be fitted to vehicle prior to roof rack installation.

**DA3271 NEW**  
ProSpeed roof access ladder



- Convenient extra step.
- Top step to be used as a platform.
- Strong, sturdy, and safe for anyone to use.

**Roll Cage Applications and Descriptions:**

**RBL1383SSS**

**4 Point external front roll cage**

Defender 90	Station Wagon without bulkhead, 2-door
Defender 90	Station Wagon with bulkhead, 2-door
Defender 110	Station Wagon, 4-door
Defender 110	Crew Cab/Double Cab Pick-up, 4-door

**RBL1387SSS**

**8 Point external front roll cage with internal rear roll cage**

Defender 90	Station Wagon without bulkhead, 2-door
-------------	----------------------------------------

**RBL1087SSS**

**6 Point full external roll cage**

Defender 90 Station Wagon with bulkhead, 2-door  
Models between 1983 - 1988 had three raised ribs on the roof approx 22mm (7/8") tall. This kind of roof does not work with our external roll cages as the hoops will clash with them.

**RBL2137SSS**

**6 Point full external roll cage**

Defender 90	Hard Top without bulkhead, 2-door
Defender 90	Station Wagon without bulkhead, 2-door

**RBL1887SSS**

**8 Point multi-point external/internal bolt-in roll cage**

Defender 90 Soft Top 2-door (1983-present)  
Utilises existing hood which will need modification. Front legs are NAS style.

**RBL2303SSS**

**Full external style bar**

Defender 90	Hard Top with bulkhead, 2-door
Defender 90	Hard Top without bulkhead, 2-door
Defender 90	Station Wagon without bulkhead, 2-door
Defender 90	Station Wagon with bulkhead, 2-door
Defender 110	Hard Top, 2-door
Defender 110	Station Wagon, 4-door
Defender 110	Crew Cab/Double Cab Pick-up, 4-door
Defender 130	Station Wagon, 4-door
Defender 130	High Capacity Crew Cab Double Cab Pick-up, 4-door

**RBL2057SSS NEW**

**8 point multi-point bolt-in full roll cage**

Defender 110 Td5 Double Cab Pickup 4-door (1998-2006)  
With front external roll cage and rear internal roll cage

**RBL1907SSS NEW**

**Full external multi-point bolt-in roll cage**

Defender 110 Hard Top, 2-door  
Made to NAS specification

**RBL1727SSS**

**8 Point full external / internal roll cage**

Defender 110 Station Wagon, 4-door  
The cage will not fit vehicles with the external ribs fitted on the roof, nor will it fit if the rear seat box is stepped in the rear corner. For clarification, see Safety Devices website.

**RBL2427SSS**

**8 Point full external roll cage**

Defender 110 Station Wagon, 4-door  
Models between 1983 - 1988 had three raised ribs on the roof approx 22mm (7/8") tall. This kind of roof does not work with our external roll cages as the hoops will clash with them).

**RBL0526SSS**

**Ladder**

A rear ladder mounted from Safety Devices' Defender 90 and 110 roll cage and Defender lower chassis mounting points.

**Safety Devices®**



Safety Devices are the UK's original designers and manufacturers of roll cages and roof racks for Land Rover. Originally designed for the British Army and the Camel Trophy, today an extensive range of designs are available.

The quality is exceptional - cold drawn seamless steel, grit blasted, zinc primed and black powder coated roll cages and roof racks will stand up to the sort of challenges you expect your Land Rover to cope with.

Safety Devices offer design excellence, unrivalled quality and a huge choice.

Images are available at [www.britpart.com/roll-cages](http://www.britpart.com/roll-cages)



Other Safety Devices roll cages are available - ask for details.  
More information and images can be found at [www.safetydevices.com/expedition/products/roll-cages](http://www.safetydevices.com/expedition/products/roll-cages)



## Bungeeclic Load Securing System



DA5040



DA5041



DA5042

### Starter Kit

#### DA5040

BungeeClic Load Securing Kit

- BungeeClic, a complete system for securing loads and objects.
- It can be customised in a variety of ways to build the correct length ties needed for securing a variety of objects
- It gives you all you need to build and adjust safe custom-length ties to suit your needs and requirements.
- No more unsafe coupling or wrong lengths.
- It can be used to secure loads at work, at home or out camping.
- Min/max working load for all items - 0 - 80kgs.

#### Kit Contents

2 x J Hooks	2 x Locking Hooks
1 x Straight Connector	1 x 90-135cm Bungee Cord
1 x 60-90cm Bungee Cord	1 x 30-45cm Bungee Cord



DA5043



DA5044



DA5045



DA5046



DA5047



DA5048



DA5049



DA5050

*customised in a variety of ways*

*used to secure loads at work, at home or out camping*

### Additional Accessories

#### DA5041

BungeeClic J hooks - twin pack

#### DA5042

BungeeClic Locking hooks - twin pack

#### DA5043

BungeeClic Straight connectors - twin pack

Straight connectors provide precision length for every job.

#### DA5044

BungeeClic Y connector - single pack

Y connectors allow you to build netting shapes

#### DA5045

BungeeClic Wall mounts - twin pack

The Wall mount offers solid and permanent anchoring; inside your Land Rover or behind any door.

#### DA5046

BungeeClic Adjustable hooks - twin pack

The adjustable hooks let you quickly adjust and set the bungee cord the right length and position.

#### DA5047

BungeeClic 30cm cords - twin pack

30cm extends up to 45cm

#### DA5048

BungeeClic 60cm cords - twin pack

60cm extends up to 90cm

#### DA5049

BungeeClic 90cm cords - twin pack

90cm extends up to 135cm

#### DA5050

BungeeClic 120cm cords - twin pack

120cm extends up to 160cm



Photograph courtesy of Armando Pantarotto

## Section contents

<b>Spare wheel carriers</b>		<b>Wheel spacers &amp; adaptors</b>	<b>34</b>
Spare wheel carriers	32	<b>Wheel wrenches</b>	<b>34</b>
Spare wheel strap	32	<b>Wheels</b>	
<b>Tyre monitoring &amp; repair</b>		Alloy	36
Inner tubes	32	MaxXtrac	37
Tyre inflation kit	33	Steel	35
Tyre pressure monitoring system	32	Zu	38
Tyre repair kit & air compressors	32		
<b>Valve caps</b>	<b>33</b>		
<b>Wheel protection</b>			
Locking wheel nuts, keys & caps	33		
Spare wheel covers	34		
Spare wheel protector	34		

“Here’s where you’ll find a fantastic selection of new wheels to freshen up the look of your Land Rover and then secure them with a set of locking wheel nuts.

Don’t get caught out with a flat tyre - we’ve also the kit to keep you going.”



wheels

## Spare Wheel Carriers

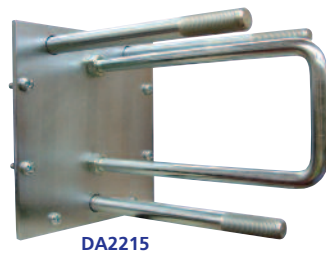
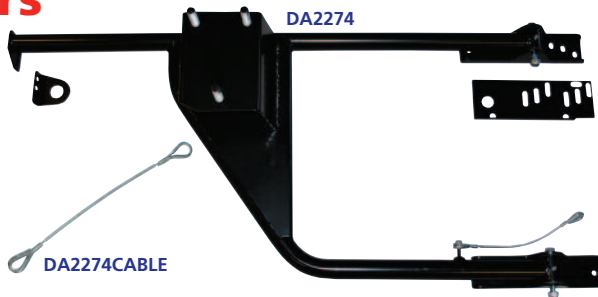

DA2274CABLE

DA2232	Defender - all models/Series	Swing away rear door mount
DA2274	Defender - with half door tailgate	Swing away rear door mount
DA2274CABLE	Spare cable for DA2274	
DA2215	Defender/Series	Fixed rear door mount

## Tyre Monitoring & Repair

### Tyre Pressure Monitoring System



Are your tyres at the right pressure?

**DA4512**  
This system is an advanced monitoring & alert system of tyre conditions. It monitors tyre pressure and temperature then relays the state of each tyre to a display unit. When any abnormalities are detected, the system will display the status of the affected tyre and sound an alarm to ensure you take action to remedy the problem. Keeping your tyres in good condition at the right pressure can extend the life of your tyres, reduce fuel consumption and improve handling.

**Note** - This system will only measure up to a maximum of 3.5 bar.

- Tyres that are at the right pressure will -
- Improve fuel consumption
  - Increase the tyre life span
  - Help enhance vehicle handling & braking
  - Reduce susceptibility to hydroplaning

System contents - 1 x Display; 1 x Receiver; 4 x Tyre sensors; 3 x Display brackets; 2 x 3M stickers & 1 x Instruction manual

### Spare Wheel Strap



**345510**  
Replacement strap for fixing your Series or Military spare wheel to the bonnet.

### Inner Tubes



**DA3000**  
7.50 x 16 Uses TR15 (large) type valve  
**DA3201**  
205 x 16 Uses TR13 (small) type valve

## Tyre Repair Kit & Air Compressors

Don't get caught out with a flat tyre or two!

Pack and leave an easy to use Britpart tyre repair kit in your vehicle\*

**DA2390** - Tyre repair kit in travel case

How It Works

1. Find and remove the item that caused the puncture.
2. Apply rubber solution to the reamer tool then push the reamer into the puncture and work up and down until the reamer moves easily in the hole.
3. Thread one rubber tyre plug in the hook tool.
4. Push the rubber tyre plug into the hole until 1/2" of the tyre plug remains outside the tyre then turn the hook tool a quarter turn and pull out slowly.
5. Cut off the excess tyre plug as close to the tyre as possible.
6. If the puncture is too big have the tyre fixed by a professional.

It's no good being able to repair your tyres if you can't inflate them!

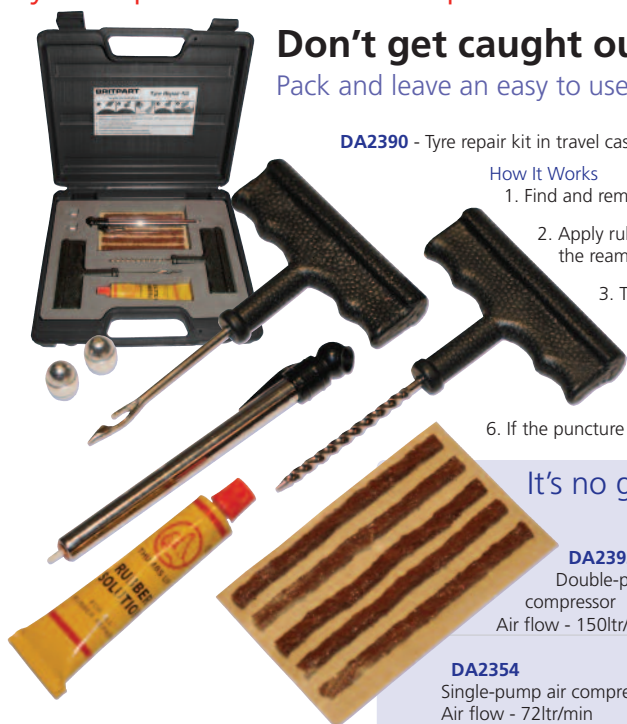

**DA2392**  
Double-pump air compressor  
Air flow - 150ltr/min

**DA2354**  
Single-pump air compressor  
Air flow - 72ltr/min



**DOUBLE PUMP**



**SINGLE PUMP**

DA2354

\*Recommended for off-road use only

See the off-road section for more details on the portable air compressors from Britpart.





Photograph courtesy of Stuart Longair

**Tyre Inflation Kit**

**DA6253**

The ARB tyre inflation kit for air compressors is specially sourced from Japan, providing a unique high-heat tolerant hose for the hi-output compressor (DA4190). The practical kit includes a dust resistant air chuck and an enclosed internal bearing system to prevent dirt ingestion.

- Suitable for camping, touring and off-road applications as well as everyday usage.
- Provides fast, accurate inflation.
- Kit includes
  - 1 x high heat pressure hose.
  - 1 x ARB air chuck with quick press fitting.
  - 1 x ARB T-fitting for use with the ARB air compressor (DA4190) and an assortment of additional fittings to suit various camping and sporting gear such as air mattresses and footballs.



**Valve Caps**



Enhance your wheels with a set of smart aluminium valve caps!

**LR027664**

Red & Blue Union Jack logo Set of 4

**LR027666**

Black & Grey Union Jack logo Set of 4

Locking wheel nuts		Locking wheel nut keys
Code A	STC3410	STC3420
Code B	STC3411	STC3421
Code C	STC3412	STC3422
Code D	STC3413	STC3423
Code E	STC3414	STC3424
Code F	STC3415	STC3425
Code G	STC3416	STC3426
Code H	STC3417	STC3427
Code I	STC3418	STC3428
Code J	STC3419	STC3429

Locking wheel nuts		Locking wheel nut keys
Code A	RRD100520	KBM100450
Code B	RRD100530	KBM100460
Code C	RRD100540	KBM100470
Code D	RRD100550	KBM100480
Code E	RRD100560	KBM100490
Code F	RRD100570	KBM100500
Code G	RRD100580	KBM100510
Code H	RRD100590	KBM100520
Code I	RRD100600	KBM100530
Code J	RRD100610	KBM100540

<b>ANR6094L</b>	Freelander 1	Locking wheel nut cap
<b>KBP10001</b>	Freelander 1	Universal nut cover removal tool
<b>RRD000100</b>	Range Rover L322	Locking wheel nut - 35
<b>RRD000110</b>	Range Rover L322	Locking wheel nut - 36
<b>RRD000120</b>	Range Rover L322	Locking wheel nut - 37
<b>RRD000130</b>	Range Rover L322	Locking wheel nut - 38
<b>RRJ000030</b>	Range Rover L322	Locking wheel nut cap
<b>RRJ100120</b>	Defender Discovery 2 Range Rover P38	Locking wheel nut cap

**Locking wheel nuts & key kits**

<b>STC7623LR</b>	Defender with deep dish alloy wheels	Kit - 5 x nuts; 5 x caps; 1 x key
<b>STC3601</b>	Defender/Discovery1/Range Rover Classic - 1989 - 1994 with alloy wheels	Kit - 5 x nuts; 5 x caps; 1 x key; 1 x black bag for key
<b>RTC9535</b>	Defender/Discovery 1/Range Rover Classic - 1989 - 1994 with steel wheels	Kit - 5 x nuts; 1 x key (black finish)
<b>STC8843AA</b>	Defender/Discovery 1/Range Rover Classic - 1989 - 1994 with alloy wheels (not deep dish)	Kit - 5 x nuts; 5 x caps; 1 x key
<b>RRB100510</b>	Discovery 2 with alloy wheels	Kit - 1 x nut; 1 x cap; 1 x key; 1 x removal tool
<b>STC50080</b>	Discovery 2 - Full set of wheel nuts	Kit - 4 x locking nuts; 4 x spare caps; 18 x normal nuts (inc. caps); 1 x key; 1 x remover tool
<b>ANR6091</b>	Freelander 1	Kit - 5 x nuts; 1 x key; 1 x removal tool
<b>RRB100370</b>	Range Rover P38 with alloy wheels	Kit - 4 x nuts; 4 x caps; 1 x key
<b>RRB500100</b>	Discovery 3/Range Rover Sport - 2005 - 2009 Range Rover L322 - 2005 - 2009	Kit - 4 x nuts; 1 x key



**PROTECT YOUR VALUABLE WHEELS & TYRES WITH A LOCKING WHEEL NUT KIT**

## Spare Wheel Covers



Plain black, easy to fit spare wheel covers.

<b>DA2021</b>	7.5 x 16
<b>DA2022</b>	6.0 x 16
	195 x 80 x 15
<b>DA2026</b>	205 x 16
<b>DA2025</b>	235 x 70 x 16
	255 x 55 x 18
<b>DA2027</b>	235 x 85 x 16

## Spare Wheel Protector



**DA1156**  
The valuable spare wheel on the Discovery 3, Discovery 4 and Range Rover Sport - 2005 - 2013 are very vulnerable to thefts. This spare wheel protector is designed to restrict access to the winching mechanism and makes it almost impossible for anyone to steal the wheel. Easy to fit, with full instructions, to give you peace of mind.

## Wheel Wrenches

<b>LR011870</b>	Wrench size - 15/16"	<b>LR011870 NEW</b>	Wrench size - 27mm
<b>537179</b>	Wrench size - 27mm	<b>LR011870HD</b>	Wrench size - 27mm
<b>NTC7829HD</b>	Wrench size - 27mm	<b>NEW</b>	Heavy-duty
<b>NTC7829HD</b>	Wrench size - 27mm	<b>218508</b>	Starting handle for Series vehicles

## Wheel Spacers & Adaptors

### Wheel Adaptor Kits

Convert your existing stud pattern to allow for fitment of a different style of wheel.



**DA6343** Set of 4  
To fit Range Rover L322 wheels to Discovery 2/Range Rover P38  
To fit Range Rover Sport wheels to Discovery 2/Range Rover P38



To fit Range Rover P38 wheels to Defender/Discovery 1/Range Rover Classic  
Boss height is 66.65mm  
**DA5005** Set of 4  
**DA5005S** Single adaptor

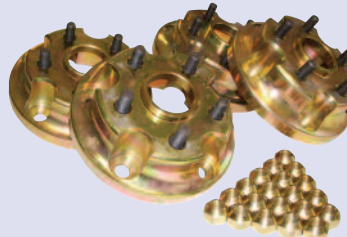

To fit Discovery 2 wheels to Defender/Discovery 1/Range Rover Classic  
Boss height is 58mm  
**DA5006** Set of 4  
**DA5006S** Single adaptor



**Wheel Spacers**  
Improve your Land Rover's appearance, steering lock and handling with a set of wheel spacers.  
Defender/Discovery 1/Range Rover Classic  
30mm thick, steel machine finish complete with wheel nuts and OEM studs  
**DA5004** Set of 4  
**DA5004S** Single spacer



Photograph courtesy of David Sherwood

**Wheels**  
Steel Wheels

ANR3973



ANR4583PM



ANR4583SILVER



ANR4635PM



ANR4636PM



RRC503600PM



Smarten up your Land Rover with a smart new set of wheels.

ANR5593PM



DA3187

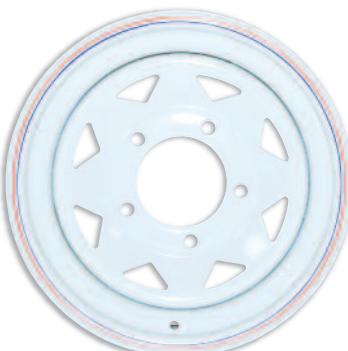

NTC5193PM



RRC114560MUW



<b>Defender</b>				
<b>ANR4583PM</b>	16" x 6.5J	Primed	Wolf style - welded tubeless - use longer studs (FRC7577)	
<b>ANR4583SILVER</b>	16" x 6.5J	Silver	Wolf style - welded tubeless - use longer studs (FRC7577)	
<b>ANR4635PM</b>	16" x 6J	Primed	Ro-style (NTC2165)	
<b>ANR4636PM</b>	16" x 5.5F	Primed	Standard - welded tubed	
<b>ANR5593PM</b>	16" x 6.5J	Primed	Wolf style - welded tubed	
<b>DA3187</b>	16" x 7	White	8-spoked - welded tubeless	
<b>RRC503600PM</b>	16" x 5.5J	Primed	Standard - welded tubeless	Defender - 1987 onwards
<b>Discovery</b>				
<b>DA3187</b>	16" x 7	White	8-spoked - welded tubeless	Discovery 1
<b>NTC5193PM</b>	16" x 7JH	Primed		Discovery 1
<b>RRC114560MUW</b>	16" x 7J	Silver		Discovery 2
<b>Freelander</b>				
<b>ANR3973</b>	15" x 5.5J	Silver		Freelander 1
<b>Range Rover Classic</b>				
<b>ANR4635PM</b>	16" x 6J	Primed	Ro-style (NTC2165)	
<b>DA3187</b>	16" x 7	White	8-spoked - welded tubeless	
<b>Series</b>				
<b>ANR4636PM</b>	16" x 5.5F	Primed	Standard - welded tubed	

## Alloy Wheels

ANR3631MNH



ANR5307MNH



RRC503400MNH



LR023391BLK



LR025862



RRC501470MCM



RRC505360MNH



RRC505370MNH



LR025862

### Defender

<b>ANR3631MNH</b>		16" x 7	Deepdish alloy
<b>ANR5307MNH</b>	TA onwards	16" x 7	Tornado alloy
<b>RRC503400MNH</b>	1994 onwards	16" x 7	Boost alloy
<b>LR023391BLK</b> <b>NEW</b>	1994 onwards	16" x 7	Boost alloy - black gloss
<b>LR025862</b>	1994 onwards	16" x 7	Sawtooth style alloy

### Discovery

<b>ANR3631MNH</b>	Discovery 1	16" x 7	Deepdish alloy
<b>ANR5307MNH</b>	Discovery 1	16" x 7	Tornado alloy
<b>RRC501470MCM</b>	Discovery 2	18" x 8	Hurricane alloy
<b>RRC505360MNH</b>	Discovery 3/Discovery 4	18" x 8	10-spoke alloy - Silver sparkle finish

### Range Rover

<b>RRC501470MCM</b>	Range Rover P38	18" x 8
	Hurricane alloy	
<b>RRC505360MNH</b>	Range Rover Sport - 2005 - 2009	18" x 8
	10-spoke alloy - Silver sparkle finish	
<b>RRC505370MNH</b>	Range Rover Sport - 2005 - 2009	19" x 9
	10-spoke alloy - Silver sparkle finish	

**Note** - Centre caps and wheel nuts not included with any wheels.

**MaxXtrac - Mach 5**



DA2471



DA2472



DA2473

**MaxXtrac Mach 5 alloy wheels**

Defender  
Discovery 1  
Range Rover Classic  
Size - 16" x 8  
Offset - et 10  
Load rating - 1,450kgs  
Engineered in the UK & supplied with 5 standard wheel nuts.

	Wheel	Wheel Centre
Satin Black	DA2471	DA2476
Anthracite	DA2472	DA2478
Silver	DA2473	DA2477

**DA2474**

Set of 5 spare wheel nuts

**DA2475**

Set of 5 locking wheel nuts

DA2476



DA2478



DA2477



DA2474



DA2475



**MaxXtrac - Blindo**



DA2488



DA2489

Defender  
Discovery 1  
Range Rover Classic  
**DA2488** Anthracite  
**DA2489** Black

**Specifications**

Size - 16" x 7"  
PCD - 5 x 165.1  
Offset - et 15  
Weight - 14.3Kg

**MaxXtrac Blindo alloy wheels**

Smart looking, tough, high quality alloy wheels which are ideal for off-road use. Used for rally-road competition vehicles as well as the military these Blindo wheels are TÜV approved and manufactured in Italy.

- Only prime aluminium is used.
- Less silicon is added than cheaper alloy wheels.
- Alloys are heat-treated for improved mechanical properties.
- Metal is de-gassed to remove any small bubbles.
- Low pressure cast to ensure improved metal density.
- Once made each alloy is x-rayed to check for defects, then water tank pressure tested to ensure no leaks.



## Zu Wheels

**ANTHRACITE  
- GLOSS**



**ANTHRACITE  
- MATT**



**BLACK - GLOSS**



**BLACK - MATT**



**HIGH POWER  
SILVER**



**SILVER**



**WHITE**



- Super strong
- Super light
- TÜV approved and meets or exceeds UK - European - U.S. - Canadian - Australian - South African and Japanese wheel manufacturing specifications
- Uses standard Land Rover alloy wheel nuts
- Easy to balance
- Manufactured in the UK



### Defender/Discovery 1/Range Rover Classic 16 x 7 Rims

- 11mm + VE offset
  - 1,400kg rating
  - 10.4kg each
- |        |                    |
|--------|--------------------|
| DA2437 | Anthracite - gloss |
| DA2436 | Black - gloss      |
| DA2439 | Black - matt       |
| DA2435 | Silver             |
| DA2434 | White              |

**Note** - Wheel nuts not included

### ANR2763MMM Alloy wheel nut Defender - up to 2006/Discovery 1/Range Rover Classic

- RRD500560 Alloy wheel nut  
Defender - 2007 onwards

### Discovery 2/Range Rover P38 16 x 8 Rims

- 38mm + VE offset
  - 1,400kg rating
  - 12.0kg each
- |        |                    |
|--------|--------------------|
| DA2433 | Anthracite - gloss |
| DA2432 | Black - gloss      |
| DA2438 | Black - matt       |
| DA2431 | Silver             |
| DA2430 | White              |

### 18 x 8 Rims

- Part number includes wheel adaptor ring
  - 36mm + VE offset
  - 1,400kg rating
  - 12.0kg each
- |        |                    |
|--------|--------------------|
| DA2458 | Anthracite - gloss |
| DA2459 | Anthracite - matt  |
| DA2456 | Black - gloss      |
| DA2457 | Black - matt       |
| DA2461 | High Power Silver  |
| DA2460 | Silver             |

**Note** - Centre caps and wheel nuts not included

- RRD500510 Alloy wheel nut

- RRJ500030MNH Wheel cap

Discovery 2/Range Rover P38

### Discovery 3/Discovery 4\*/Range Rover Sport\* & Range Rover L322\*

#### 18 x 8 Rims

- 36mm + VE offset
  - 1,400kg rating
  - 12.0kg each
- |        |                    |
|--------|--------------------|
| DA2452 | Anthracite - gloss |
| DA2453 | Anthracite - matt  |
| DA2450 | Black - gloss      |
| DA2451 | Black - matt       |
| DA2455 | High Power Silver  |
| DA2454 | Silver             |

**Note** - Centre caps and wheel nuts not included

**\*Important** - Zu rims *will not* fit any Range Rover L322 Supercharged or Range Rover Sport Supercharged fitted with Brembo brake callipers. *Will only* fit Discovery 4 with 2.7ltr engine.

- RRD500590G Alloy wheel nut

- Discovery 3/Discovery 4/Range Rover Sport - 2005 - 2013

- RRD000011 Alloy wheel nut

Range Rover L322

- RRJ500030MNH Wheel cap

- Discovery 3/Discovery 4/Range Rover Sport - 2005 - 2009/

Range Rover L322



# Super strong

# Super light

## Section contents

**Exterior lights**Driving lights **40**Fog lights **41**LED bumper **41**Roo-Lites **41****Light conversion & upgrades**ECE LED headlamps **44**Heater control light upgrade kit **43**Individual lights - LED **42**Individual lights - NAS **42**Light conversion kits **43**Light kits **42**Light upgrade kits **43**Xenon Ultima headlamp bulbs **43**Xenon Ultima headlamp upgrade **43****Light mountings**Light bars **45**Light mounting kits **45****Spare light bulb kits** **44****Work lights**Exterior lights **45**Inspection lamps **46**

"Be seen and light the way with a decent set of driving lamps.

Or convert your existing lights to something more powerful."



lighting equipment

## Exterior Lights

### Driving Lights

<b>DA4088</b>	8" Light - 100 watt	Black	Pair
<b>DA4088C</b>	8" Light - 100 watt	Chrome	Pair
<b>DA4088W</b>	Wipac 8" Light - 100 watt	Black	Pair

Features for the above lights -

- High power halogen lamps
- Easy installation
- Fitted plastic stone guards
- Universal fitting
- Fits all 12 volt vehicles
- Armoured cable
- Excludes wiring kit

**FOR EXTRA LIGHT WHEN NEEDED!**

<b>DA4088BULB</b>	Replacement 100 watt bulb for DA4088; DA4088C & DA4088W		
<b>DA4099</b>	Hella Rallye 3000	Black	Single
<b>PRC8238</b>	Spoiler lamps classic	Black	Pair
<b>STC7644</b>	Hella Rallye 1000 long range	Black	Single
<b>STC8480LR</b>	Safari 5000 - Defender - 1987 - 2006/Discovery 1/Discovery 2/Range Rover Classic - 1992 - 1994/Range Rover P38	Black	Single
<b>XQB500080</b>	Discovery 3	Black	Pair
<b>VUB500870</b>	Freelander 1 - 4A00001 onwards	Black	Pair



**Replacement Light Guards**

<b>DA4088COVER</b>	For DA4088; DA4088C & DA4088W	Black	Mesh	Single
<b>DA4398</b>	For STC7644	White	Solid	Single
<b>DA4399</b>	For STC7644	Black	Mesh	Pair



**Fog Lights**

**RTC8922**

Defender - up to 2006/Range Rover Classic  
Hella Comet 550  
Rectangular Black Pair  
**Note** - 195mm wide x 96mm high x 83mm deep

**STC7643**

Defender - up to 2006/Discovery 1/Discovery 2  
Hella Rallye 1000  
Round Black Single

**DA4398** (for photo see page opposite)  
Replacement guard for STC7643  
Solid White Single

**DA4399** (for photo see page opposite)  
Replacement guard for STC7643  
Mesh Black Pair



**DA1062**

Roo-Lite

- High performance lighting with super strength construction
- 7 1/4" round long range spot lamps with "stone-proof" clear polycarbonate lens
- Super strength housing with an Osram 100 watt Xenophot long life technology bulb
- Variable focus from spot to fog beam pattern
- Lightweight for reduced vibration
- Reflector unit is screw-on for easy bulb change
- 12V - 100W - 8 amps

**Note** - Roo-lites sold individually



**Roo-Lite covers**

**Impact resistant - Plain**

**DA1062AMBER** Amber coloured

**DA1062BLUE** Blue coloured - produces 'Xtra white' light

**Impact resistant - Diffused**

**Suitable for fog/snow conditions**

**DA1062FOGA** Amber coloured

**DA1062FOGW** Blue coloured - produces 'Xtra white' light

**DA1062COVER** Protective cover

**Note** - Roo-Lite covers sold individually

**DA1063** 100W Spare bulb

**DA1064** Harness  
Harness is of a heavy gauge wire to ensure safe operation of high wattage lamps. It includes digital switch, in-line fuse, built-in relay and wiring harness.

**Roo-Lites**



**Exclusive to Britpart!**

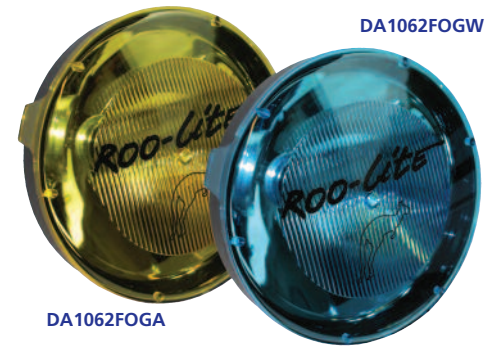

**LED Bumper NEW**

**DA5678 NEW**  
Front bumper with LED lights  
This smart and functional standard fit Defender bumper is equipped with a pair of LED lights for additional lighting in the dark or day light running for safety.

## Light Conversion & Upgrades

### Light Kits

#### Defender & Series Replacement 73mm light kits

<b>DA1077</b>	OEM	Series/Defender - up to 300Tdi
<b>DA1077G</b>	OEM	Series/Defender - up to 300Tdi
<b>DA1080</b>	OEM	Defender - 300Tdi onwards
		Defender - Td5 - up to WA159806
<b>DA1080G</b>	OEM	Defender - 300Tdi onwards
		Defender - Td5 - up to WA159806

#### Defender & Series LED 73mm light kits

<b>DA1191</b>	Clear LED light kit
Contents - 2 x Clear front sidelight; 2 x Clear front indicator; 2 x Clear rear indicator; 2 x Clear stop/tail & 1 x 12v LED flasher unit	
<b>DA1192</b>	LED light kit
Contents - 2 x Clear front sidelight; 2 x Amber front indicator; 2 x Amber rear indicator; 2 x Red stop/tail & 1 x 12v LED flasher unit	

#### Defender North American specification (NAS) LED upgrade kit

**DA1143**  
These stylish and waterproof NAS style LED rear lamps are a brighter alternative to the traditional halogen lighting with the added additional benefits of having a longer life (typical LED life 100,000 hours) with low energy consumption. The complete LED lamp kit includes

- 1 x reverse LED light
- 1 x fog LED light
- 2 x indicator LED lights
- 2 x stop/tail LED lights
- 6 x plinths
- Screws & smart load devices

**DA114424V** 24 volt smart load device kit

**Note** - To use the LED kit (DA1143) on a 24 volt Defender use DA114424V which replaces the 12 volt smart load device.



*Bigger, brighter lights...*

### Individual Lights - LED

#### Defender & Series LED lights

- High quality LED lights
- Multi-voltage 9 - 33V
- 73mm diameter
- Wipac branded
- Waterproof to IP67
- E Marked and SAE Approved
- AMP type connector fitted
- Comes complete with stainless steel screws



**PRC8876LED**

#### Defender - 1987 - 2006 & Series 2 & 3

<b>AMR6514LED</b>	Front side light	Clear	Single
<b>XBD100670LED</b>	Front indicator light	Clear	Single
<b>AMR6515LEDCL</b>	Rear indicator light	Clear	Single
<b>AMR6513LED</b>	Front indicator light	Amber	Single
<b>AMR6515LED</b>	Rear indicator light	Amber	Single
<b>XFD100100LEDCL</b>	Stop/tail light	Clear	Single
<b>XFD100100LED</b>	Stop/tail light	Red	Single

#### Defender - 2007 onwards

<b>XBD500050LED</b>	Front side light	Clear	Single
<b>XBD500010LED</b>	Front indicator light	Clear	Single
<b>XFD500050LEDCL</b>	Rear indicator light	Clear	Single
<b>XBD500040LED</b>	Front indicator light	Amber	Single
<b>XFD500050LED</b>	Rear indicator light	Amber	Single
<b>XFD500040LEDCL</b>	Stop/tail light	Clear	Single
<b>XFD500040LED</b>	Stop/tail light	Red	Single

<b>XFE500010LED</b>	Fog light - 95mm	Red	Single
<b>XFE500010LEDCL</b>	Fog light- 95mm	Clear	Single
<b>XFC100550LED</b>	Number plate light		Single

**PRC8876LED** 12v LED flasher unit  
Upgrade the standard flasher unit to the exclusive Wipac LED version. Manual adjustment to correct flasher rate. Can be used with any combination of LEDs and halogen bulbs - with or without additional loads such as trailers.

#### Defender 95mm Special Edition lights

<b>LR008982</b>	Reverse LED light	Clear	Single
<b>LR009792</b>	Indicator light	Clear	Single
<b>LR008913</b>	Stop/tail LED light	Clear	Single
<b>LR008975</b>	Fog LED light	Clear	Single



**DA4349** Round ABS plastic NAS tail light guard Single



### Individual Lights - NAS

#### Defender North American specification (NAS) lights

<b>AMR6526</b>	Stop/tail light	Red	Single
<b>AMR6527</b>	Indicator light	Amber	Single

**Note** - Supplied without mounting plinth and screws

<b>AMR6528</b>	Reverse light	Clear	Single
----------------	---------------	-------	--------

**Note** - Supplied with mounting plinth but without screws

<b>XFD500010</b>	Reverse light	Clear	Single
<b>XFE500010</b>	Fog light	Red	Single

**Note** - Supplied with mounting plinth and screws

#### Defender NAS LED lights

<b>AMR6526LED</b>	Stop/tail LED light	Red	Single
<b>AMR6527LED</b>	Indicator LED light	Amber	Single
<b>XFD500010LED</b>	Reverse LED light	Clear	Single
<b>XFE500010LED</b>	Fog LED light	Red	Single
<b>XFE500010LEDCL</b>	Fog LED light	Clear	Single

#### Sundry items

<b>AMR3850</b>	Mounting plinth	Single
<b>SE105161L</b>	Screws	Pack of 10
<b>STC1188</b>	Link leads	

2 wire for indicator, side, reverse and fog lamp

**STC4637** Link leads

3 wire for stop and tail lamp

**DA114412V** 12 volt smart load device kit

**DA114424V** 24 volt smart load device kit

**Note** - To use the LED kit (DA1143) on a 24 volt Defender use DA114424V which replaces the 12 volt smart load device.



**Light Conversion Kits**

Get better night time visibility by upgrading your Land Rover's standard headlights to a better halogen headlight.

Crystal halogen headlamp  
Series/Defender/Range Rover Classic

- Clear lenses and profiled back reflector offer brilliant lighting
- Fully E-marked

**RTC4615C**  
Right hand drive  
Pair

**Note** - Bulbs not included  
**589783**  
Bulb - 60/55W H4



Sealed beam to halogen headlamps with bulbs  
Series/Defender/Range Rover Classic

**RTC4615K**  
Right hand drive

**PRC7994K**  
Left hand drive

**589783**  
Replacement bulb  
60/55W H4

Wipac Brand with bulbs  
**RTC4615KW**  
Right hand drive

**RTC4615W**  
Right hand drive

**589783**  
Replacement bulb  
60/55W H4



**Light Upgrade Kits**

**STC50383**

Convert your early Range Rover P38's standard orange indicator lights to the later, more stylish white indicator lights.

**STC50383**  
Range Rover P38  
Right hand drive lamp upgrade kit  
**Note** - Does not include headlamps

**STC50408**

Convert your early Range Rover P38's standard orange indicator lights to the later, more stylish white indicator lights.

**STC50408**  
Range Rover P38  
Left hand drive lamp upgrade kit  
**Note** - Does not include headlamps

**Heater Control Light Upgrade Kit**

**JFC102550B**  
Restore the Range Rover P38's heater control unit back to full brightness with this Britpart kit. Full fitting instructions are included.

**Xenon Ultima Headlamp Bulbs**

**DA5016** H4 fitment Pair  
**DA5024** H7 fitment Pair

- Up to 120% more light on the road.
- 100% Xenon gas and advanced filament technology produce exceptional night driving performance.
- A longer beam pattern enables other road users to be seen more clearly and allows more time to react to potential hazards.
- Better reflections from road markings and signs make for more comfortable and safer night driving.
- Street legal and a simple upgrade from standard bulbs, requiring no changes to vehicle wiring.

**DA5016**

**DA5024**

**Xenon Ultima Headlamp Upgrade**

**DA5016**      **DA5014**

Xenon 7" universal fit headlamp upgrade kit includes Xenon Ultima. Suitable for Defenders, Series and Range Rover Classic.

Xenon Ultima is the first auto bulb to put 120% more light on the road. The lamps have a complex surface to give a superior light distribution. They are E-approved, fully road legal and the kit includes headlamp units and xenon bulbs. 3 year warranty.

**DA5014** Right hand drive kit  
**DA5015** Left hand drive kit  
**DA5016** H4 replacement headlight bulbs for DA5014 & DA5015 - pair

## ECE LED Headlamps

<b>DA6280K</b>	Pair	Right hand drive
<b>DA6281K</b>	Pair	Left hand drive

### Fitment

- Series / Defender / Range Rover Classic

### Features & Benefits

- ECE & ROHS compliant
- LED sealed beam technology with polycarbonate lens and sealed electronics
- Up to 50 x longer life than halogen headlamps, lowering life-cycle costs
- Produces pure white light, nearly identical to daylight that is easy on the eye, unlike harsh blue HID systems
- Includes built-in position lamp with optional wiring
- Offers great forward vision, improved roadside coverage and highly controlled beam patterns, offering glare protection to oncoming traffic
- Dipped/passing beam and main/driving beam functionality
- Ultra-bright output for maximum night visibility
- H4, 3-Blade connector system (main & dipped beam only)
- 3-Year warranty

### Technical Specifications

#### Material

- Hard-coated polycarbonate lens
- eCoat aluminium housing and internal structures
- Metalized reflector
- 1.3mm CSA / 16 gauge wire

#### Light Source

- 2 LED arrays

#### Power

- Multi-volt (9V-33V) design works with both 12V and 24V systems

#### Headlamp

- 1.3A (dipped/passing) @ 13.2V
- 2.3A (main/driving) @ 13.2V
- 0.6A (dipped/passing) @ 26.4V
- 1.1A (main/driving) @ 26.4V

#### Position Lamp

- 0.03A @ 13.2V, 0.03A @ 26.4V

#### Additional Specifications

- Operating temperature range: -40°C to 50°C
- Overvoltage protection to 600V

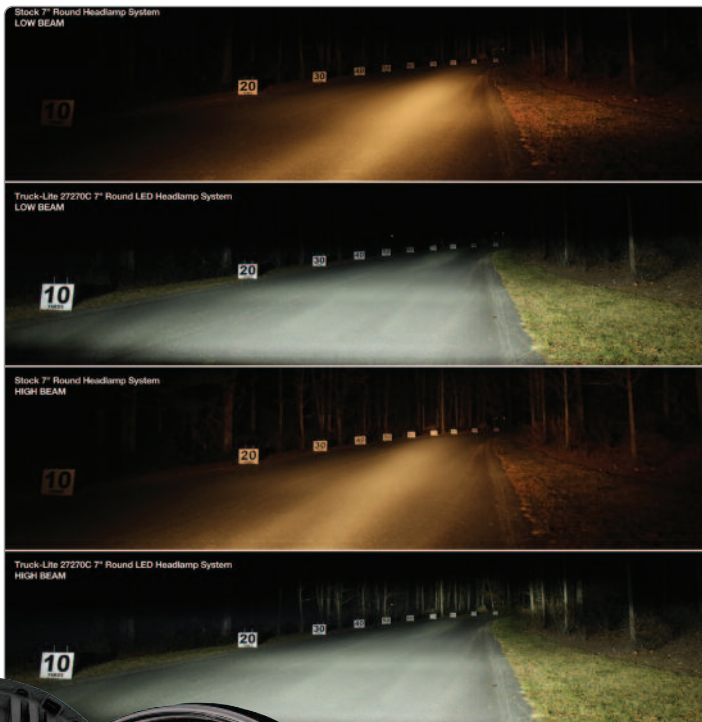

*Up to 50 x longer life than halogen headlamps...*



Side lights



Dipped lights



Main beam

## Spare Light Bulb Kits



**DA5018**  
H1 spare bulb kit



**DA5019**  
H4 spare bulb kit



**DA5020**  
H7 spare bulb kit



**DA5021**  
H11/H7 spare bulb kit

*Handy to keep in your glove box*



You can now find all the latest Britpart news on Facebook!

[facebook.com/britpart](https://www.facebook.com/britpart)

[www.britpart.com](http://www.britpart.com)



Photograph courtesy of Becca Clarkson

**Light Mountings**

Light Bars



DA5624

**DA5624**  
Defender - non-air-con  
Black  
**Note** - Light bar  
excludes lights



STC50243

**STC50243**  
Discovery 2  
Black  
**Note** - Light  
bar excludes  
lights DA4088



Replacement plastic bowls for standard 8" headlight mountings on Defenders & Series.

**DA3010**  
Series/Defender  
8" Headlamp  
Single with chrome bezel

**DA3010B**  
Series/Defender  
8" Headlamp  
Single with black bezel

**DA1158**  
Series/Defender  
8" Headlamp fixing kit - less bowl  
Black bezel  
Single

**STC3018SS**  
Series/Defender  
8" Headlamp mounting bezel.  
Stainless steel  
Single



DA1158

STC3018SS



DA3010B

Light Mounting Kits

**Work Lights**

Exterior Lights

**Verdict**

*"Robust, and gives a useful spread of light."*  
Neil Watterson  
Deputy Editor, LRO



**DA1146**  
3 watt LED exterior work light with smart matt black aluminium housing. Input voltage 10-30 volts. Waterproof to IP67 standards. 85mm diameter with mounting bracket. Incredibly bright and in most cases will not require a relay due to the 3 watt load.



**DA4120**  
Hella Torero 5760 work light  
Long-range illumination H3 work light with handle. Includes universal mount (swivel) with M10 mounting screw for upright or pendant mounting. Prism optics for long-range illumination. The housing is made of black plastic, with a prominent edge to protect the lens. The reflector of steel sheet is bonded to the glass lens. With switch, vibration damper and guard.  
Rated voltage: 12/24 volts  
Recommended inclination angle: 15° - 20°  
Range: 40 m  
Light exit diameter: 120 mm  
Diameter: 152 mm  
Overall height: 239 mm  
Protection: IP5K4K  
Suitable bulb: H3 (Halogen) not included (part no. 12v - 606178)  
Packaging unit: 1

## Inspection Lamps



### DA5026

#### Professional LED Inspection Pocket Lamp

- Rechargeable and cordless for convenient use.
- High powered LEDs provides a bright light output.
- Anti-slip comfortable grip.
- Magnet for hands free use.
- LED torch function for focussed light output.
- Precision reflector provides wide angle light output.
- Tough and robust polycarbonate lens for demanding conditions.
- Lithium ion battery for faster consistent recharging.
- Includes AC mains charging adapter with UK plug.

#### Specifications

Light Output	120 lumens
Battery	3.7v 1200mAh
Mains Adapter	Input 240v - 50/60Hz Output 5v - 300mA
Operating Time	5hrs
Charging Time	5hrs



### DA5027

#### Essential LED Inspection Pocket Lamp

- Magnet for hands free use.
- LED torch function for focussed light output.
- Protective lens for demanding conditions.
- Integral swivel pocket clip.
- Includes batteries.

#### Specifications

Battery	3 x AAA
Operating Time	5hrs



## Section contents

<b>Towing equipment</b>	
All models	48
Defender	49
Discovery	50
Freelander	51
Range Rover	52 - 53
Series	53

"Haul that load - towing equipment for all Land Rover models."



towing equipment

## All Models



DA2123

Britpart have the equipment to get you **hitched** up and **towing**!

### Towing - hitches

201691	All	Ball, jaw & pin - heavy-duty 4 bolt mounted (ball 3 <sup>1</sup> / <sub>2</sub> ton/jaw 5 ton)
DA2123	All	Ball, jaw & pin (RTC8159/LR008244)
DA5100	All	Tow hitch (3 <sup>1</sup> / <sub>2</sub> ton)
KNB100640	All	Towing jaw (3 <sup>1</sup> / <sub>2</sub> ton)
NRC2051	NATO	Tow hitch

### Towing - ancillary parts

67187	All	Pin universal coupling - heavy-duty (201691)
DA2194	All	Replacement pin for DA2123
ANR3635	All	50mm Tow ball cover
579408	All	7-Pin trailer plug
DA5023	All	7-pin to 13-pin adaptor To use on vehicles with 7-pin towing electric sockets
DA5025	All	13-pin to 2 x 7-pin adaptor - 12N/12S Ideal for when vehicles with a 13 pin socket are required to tow caravan/trailer with twin 7 pin plugs.
DA1126	All	Universal towing electrics 12N Rear audible relay kit with pre-wired 2m cable
DA2195	All	Replacement slider bracket - 1-pin
DA2118	All	Replacement slider bracket - 2-pin
RTC8831	All	Saddle slider - fits all Dixon Bates kits
DA2123A	All	Replacement chain, tag & clip
DA2196	All	Replacement slider pin
DA2197	All	Replacement slider pin 'R Clip'



201691



DA5100



KNB100640



NRC2051

### DA2605

#### Autojaw Semi-automatic universal coupling

- Self engaging / semi-automatic disengaging, simple one handed operation
- No loseable / stealable parts
- Compact design for maximum ground clearance and minimum overhang
- Minimum fixing point to towing point centre dimensions to minimise forces applied to both towbar and towing vehicle
- No chains or wires
- EC94/20 Approved (e11 005762)
- Compatible with 30, 40 & 50mm British standard eyes
- Conforms to Road Traffic Act 1281 (1998)



DA2605

### ANR3635



579408



67187



DA2194



DA5023



DA5025



DA1126



DA2195



DA2118



RTC8831



DA2123A



DA2196

DA2197



**Defender**



**TACKLE THE JOB WITH THE RIGHT EQUIPMENT!**



**Towing - hitches**

<b>DA2121</b>	Defender 90/110 - up to WA	Adjustable kit (RTC8828AA)
<b>DA2136</b>	Defender 90 - WA onwards	Towbar assembly (VUB105460) - no electrics
<b>DA2137</b>	Defender 110 - WA onwards	Towbar assembly (VUB105470) - no electrics
<b>LR007221</b>	Defender 90 - Td5 & 2007 onwards	Adjustable tow kit
<b>LR007222</b>	Defender 110 - Td5 & 2007 onwards	Adjustable tow kit
<b>LR007223</b>	Defender 110/130 - 1998 onwards	High capacity pickup adjustable tow kit (STC50257AB)
<b>STC50269AA</b>	Defender 90 - XA onwards	Rear step - includes regulation tow bracket
<b>STC50301</b>	Defender 110 - XA onwards	<b>Note</b> - Does not include drop plate and tow ball
<b>VPLDT0086</b>	Defender 110 - High capacity pickup - 2007 onwards	Rear step - includes regulation tow bracket
<b>242139</b>	Defender - all models	<b>Note</b> - Does not include drop plate and tow ball
<b>RTC8891AA</b>	Defender - all models	Multi-height tow bar with tow ball
		Front towing eye
		50mm Tow ball



**Towing - ancillary parts**

<b>NRC8208</b>	Defender - all models - less High-Cap up to VA138479	Bracket to rear cross member
<b>LR005919</b>	Defender - 2007 onwards - all models	13-pin socket electrics kit
<b>LR005920</b>	Defender - 2007 onwards - all models	'N' Type electrics kit
<b>LR005921</b>	Defender - 2007 onwards - all models	'S' Type electrics kit - front
<b>STC4286</b>	Defender - all models	12N 7-pin socket
<b>YWJ101500</b>	Defender - Td5	'N' Type electrics plug



## Discovery

DA2134



DA2125



DA2138



STC50287AB



STC50289AB



KNB500070



STC50319



LR007484G



### Towing - hitches

DA2134	Discovery 1 - up to 1994	Tow kit - includes electrics (not plug-in) ( STC8816)
DA2125	Discovery 1 - 1994 onwards	Adjustable coupling (RTC8830, STC8060)
RTC8891AA	Discovery 1	50mm Tow ball
DA2138	Discovery 2	Towing kit - includes electrics (not plug-in), excludes tow ball
STC50287AB	Discovery 2	Tow kit - coil suspension - no electrics
STC50289AB	Discovery 2	Tow kit - air suspension - no electrics
STC50319	Discovery 2	Multi-height tow kit (none sliding adjuster) - no electrics
KNB500070	Discovery 3 / Discovery 4	Towing hook assembly - quick disconnect without height adjustment - Less Canada, Mexico & USA
LR007484	Discovery 3	Adjustable tow hook kit - Less Canada, Mexico & USA
LR007484G	Discovery 3	Adjustable tow hook kit - Less Canada, Mexico & USA
LR041041	Discovery 4	Adjustable tow hook kit - Less Canada, Mexico & USA
LR041041G	Discovery 4	Adjustable tow hook kit - Less Canada, Mexico & USA
VPLCT0140 <b>NEW</b>	Discovery Sport	Kit tow bar - flange ball - 5-seat / 7-seat (less spare wheel)
VPLCT0142 <b>NEW</b>	Discovery Sport	Kit tow bar - flange ball - 7-seat (with spare wheel)
VPLCT0147 <b>NEW</b>	Discovery Sport	Kit tow bar - quick release - 5-seat / 7-seat (less spare wheel)
VPLCT0148 <b>NEW</b>	Discovery Sport	Kit tow bar - quick release - 7-seat (with spare wheel)
LR061295 <b>NEW</b>	Discovery Sport	Bumper cover

### Towing - ancillary parts

STC4286	Discovery 1	12N 7-pin socket
STC8875	Discovery 1 - MA081881 onwards	12S socket
YWT10002L	Discovery 1	Electronic flasher unit for towing
STC50081	Discovery 2	'N' Type electrics socket
STC50181	Discovery 2	'N' Type electrics socket - less front fog lamps
STC50389	Discovery 2	Socket - split charge 'S' type post 1999 caravan
STC8919AA	Discovery 3	Tow strap
DA2602	Discovery 3	Tow bar electrics kit - 13-pin (YWJ500160)
YWJ500201	Discovery 3	Tow bar electrics kit 'N' & 'S' type - For Great Britain & Ireland
VPLAT0011	Discovery 4	12N/12S 7-pin electric socket
VPLCT0155 <b>NEW</b>	Discovery Sport	Tow bar electrics - 13-pin/7-seats
VPLCT0132 <b>NEW</b>	Discovery Sport	Tow bar electrics - 13-pin/5-seats

LR041041



RTC8891AA



STC4286



STC50181



STC8875



YWT10002L



STC50081



YWJ500201



STC50389



STC8919AA



DA2602



VPLAT0011



**Freelander**



You can now find all the latest Britpart news on Facebook!

[facebook.com/britpart](https://facebook.com/britpart)



**Towing - hitches**

<b>KNK500060</b>	Freelander 1	Tow bracket kit - European style fixed swan neck
<b>KNK500070</b>	Freelander 1	Tow bracket kit - UK style 50mm ball fitted (VUB501490) <b>Note</b> - This has a plug connection to the vehicle loom - with electrics
<b>STC50391</b>	Freelander 1	Tow bracket kit - includes electrics but not plug-in electrics or tow ball
<b>KNK500080</b>	Freelander 1	Tow bracket kit - swan neck detachable - with plug-in electrics (KNK500080)
<b>VPLFT0120</b>	Freelander 2 - DH000001 onwards	Tow bracket kit - swan neck
<b>VPLFT0118</b>	Freelander 2	Tow bracket kit
<b>VPLFT0119</b>	Freelander 2 - excluding body styling kit	Tow bracket kit - detachable ball tow bar



**Towing - ancillary parts**

<b>STC50459</b>	Freelander 1	Electrical assembly kit - 12S pre-1999 caravan auxiliary electrics
<b>STC50460</b>	Freelander 1	Electrical assembly kit - 12S post-1999 caravan auxiliary electrics
<b>YMZ101030</b>	Freelander 1	Electrical assembly kit - 7-pin 12N lighting
<b>YWJ500070</b>	Freelander 1	Electrical assembly kit - 13-pin auxiliary electrics
<b>YWT10002L</b>	Freelander 1	Electronic flasher unit for towing
<b>VPLFT0001</b>	Freelander 2 - up to DH	Electrical assembly kit - 12N/12S 7-pin socket (LR003106)
<b>VPLFT0105</b>	Freelander 2 - DH onwards	Electrical assembly kit - 12N/12S 7-pin socket
<b>VPLFT0002</b>	Freelander 2 - 9H000001 - BH999999	Electrical assembly kit - 13-pin socket (LR003107)
<b>VPLFT0077</b>	Freelander 2 - CH000001 - CH999999	Electrical assembly kit - 13-pin socket
<b>VPLFT0106</b>	Freelander 2 - DH onwards	Electrical assembly kit - 13-pin socket

## Range Rover



### Towing - hitches

<b>DA2125</b>	Range Rover Classic	Adjustable coupling (RTC8830/STC8060)
<b>DA2134</b>	Range Rover Classic	Tow kit (STC8816) up to 1994 - includes electrics but not plug-in electrics
<b>DA4030</b>	Range Rover P38	Tow kit
<b>KNB500070</b>	Range Rover Sport - 2005 - 2013	Towing hook assembly - quick disconnect without height adjustment - less Canada, Mexico, USA & Australia
<b>LR007484</b>	Range Rover Sport - 2005 - 2009	Adjustable tow hook kit - less Canada, Mexico & USA
<b>LR007484G</b>	Range Rover Sport - 2005 - 2009	Adjustable tow hook kit - less Canada, Mexico & USA
<b>LR041041</b>	Range Rover Sport - 2010 - 2013	Adjustable tow hook kit - less Canada, Mexico & USA
<b>LR041041G</b>	Range Rover Sport - 2010 - 2013	Adjustable tow hook kit - less Canada, Mexico & USA
<b>DA5030</b>	Range Rover L322	Towbar/flange towball - equivalent to VUB000740 & VUB000720
<b>VUB000740</b>	Range Rover L322	Tow bar armature - towing subframe - up to 2006 Europe model
<b>VUB000720</b>	Range Rover L322 - inc. 2010 onwards	Multi-height tow bars and bike carrier
<b>VUB000730</b>	Range Rover L322 - inc. 2010 onwards	Quick release tow bar - less Canada, Mexico & USA
<b>VUB503960</b>	Range Rover L322 - inc. 2010 onwards	Tow bar armature - towing subframe - 6A000001 onwards
<b>VPLGT0082</b>	Range Rover L405	Tow kit bracket - fixed multi-height
<b>VPLVT0065</b>	Range Rover Evoque	Tow kit bracket - swan neck fixed
<b>VPLVT0069</b>	Range Rover Evoque	Tow kit bracket - quick release tow bar
<b>VPLVT0078</b>	Range Rover Evoque	Tow kit bracket - flange ball

**Range Rover - continued**

**Towing - ancillary parts**

<b>YWT10002L</b>	Range Rover Classic - 1992 - 1994	Electronic flasher unit for towing
<b>DA2602</b>	Range Rover Sport - 2005 - 2009	Tow bar electrics kit - 13-pin (YWJ500160)
<b>YWJ500150</b>	Range Rover Sport - 2005 - 2009	Tow bar electrics kit 12'N' & 12'S' type - 7-pin - less Canada, Mexico, USA
<b>STC8919AA</b>	Range Rover Sport - 2005 - 2013 & 2014 onwards	Tow strap
<b>STC8919AA</b>	Range Rover L322	Tow strap
<b>VUH000020</b>	Range Rover L322 - up to 2006	Towing electrics with 13-pin socket, harness & control unit module (YWC000840)
<b>YWC000840</b>	Range Rover L322	Towing electrics control unit module
<b>YWJ500450</b>	Range Rover L322 - 6A000001 onwards	Tow bar electrics kit 12'N' & 12'S' type - 7-pin - less Canada, Mexico & USA
<b>YWJ500460</b>	Range Rover L322 - 6A000001 - up to 2009	Tow bar electric 13-pin socket & harness - less Canada, Mexico & USA
<b>VPLGT0073</b>	Range Rover L405	Tow bar electrics 13-pin socket & harness - less Canada, Mexico, USA & Australia
<b>VPLHT0061</b>	Range Rover Evoque	Tow bar electrics - 13-pin - less Canada, Mexico, USA & Australia
<b>VPLHT0062</b>	Range Rover Evoque	Tow bar electrics - Canada, Mexico, USA



**Series**



**Towing - hitches**

<b>242139</b>	Series - all models	Front towing eye
<b>DA2122</b>	Series - all models	Adjustable tow hitch kit
<b>RTC8891AA</b>	Series - all models	50mm Tow ball
<b>DA2129</b>	Lightweight	Adjustable tow hitch kit

**Towing - ancillary parts**

<b>DA2012</b>	Series - SWB	Drop plate - standard
<b>DA2133</b>	Series - all models	Drop plate - extended



Photography courtesy of David Rogers

## Section contents

<b>Dog guards</b>	<b>56 - 57</b>
<b>Loadspace</b>	
Loadspace mats & protectors	58
Loadspace nets & retention kits	60
Loadspace protectors - premium	59
<b>Mats</b>	
Carpet	60
Premium	62
Rubber	60 - 61
<b>Waterproof seat covers</b>	<b>63 - 64</b>

“Dog guards, loadspace protectors, mats, waterproof seat covers & more - all that you need to protect and keep your Land Rover looking great inside for years to come, no matter what you throw in it.”



interior protection

## Dog Guards

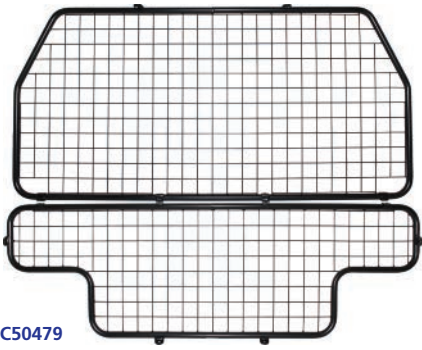

STC50479



STC7555

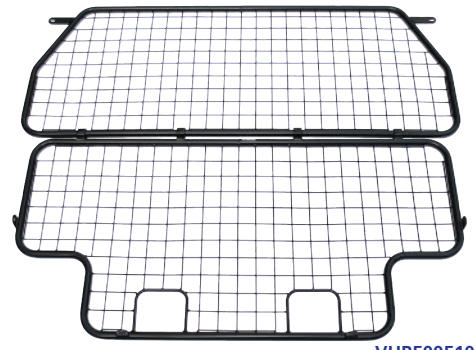

VUB500510

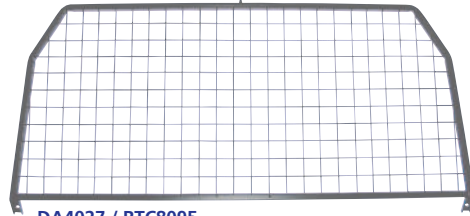

DA4027 / RTC8095

### Defender/Series

<b>DA4027 / RTC8095</b>	Defender 90/110 - 1987 - 2006 & 2007 onwards - hardtop with bulkhead	Half height	Mesh type	Grey
<b>STC50479</b>	Defender 90 - 1987 - 2006 - without bulkhead	Full height	Mesh type	Grey
<b>STC7555</b>	Defender 110 - County Station Wagon - 1987 - 2006	Full height - 1 piece	Mesh type	Grey
<b>VUB500510</b>	Defender 110 - County Station Wagon - 1987 - 2006	Full height - 2 piece	Mesh type	Black
<b>DA5539 NEW</b>	Defender 110 - County Station Wagon & Utility - 2007 onwards	Full height	Mesh type	Grey



DA5539



STC50323



DA5511

### Discovery

<b>STC7570</b>	Discovery 1	Half height	Bar type	Grey
<b>STC8414</b>	Discovery 1	Half height	Mesh type	Grey
<b>STC50323</b>	Discovery 2	Half height	Mesh type	Grey
<b>STC50082AA</b>	Discovery 2	Half height	Bar type	Grey
<b>DA5511</b>	Discovery 3/Discovery 4	Half height	Mesh type	Grey
<b>DA5538</b>	Discovery 3/Discovery 4	Dog guard divider	Mesh type	Grey
<b>VUB501170</b>	Discovery 3/Discovery 4	Full height	Mesh type	Black

### STC7570

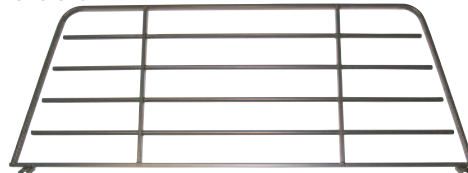

DA5538

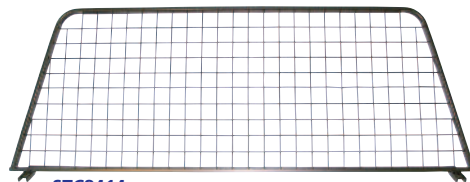

STC8414

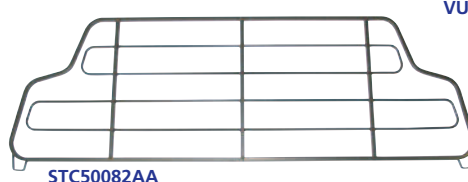

STC50082AA

### VUB501170

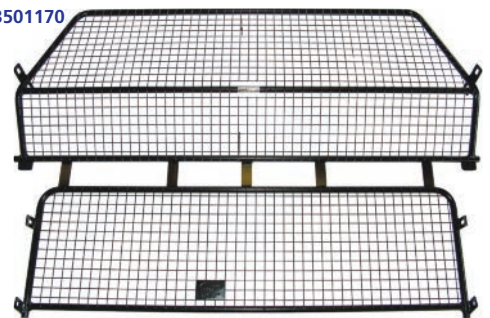

### Freelander

<b>STC7939AB</b>	Freelander 1	Full height	Bar & mesh type	Grey
<b>DA5801</b>	Freelander 2	Half height	Mesh type	Grey
Easy to fit and remove. No vehicle modifications needed.				
<b>LR002521</b>	Freelander 2	Full height/full width	Mesh type	Black



STC7939AB



DA5801



LR002521



**Dog Guards** - continued

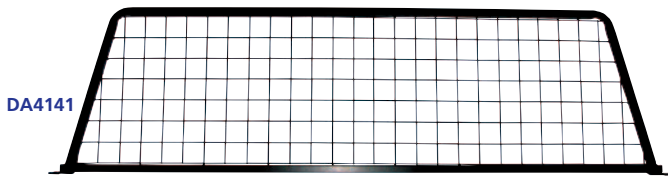

DA4141



STC8524



DA1081



DA1082



VUB002120 / LR007320



DA5810



DA5811



Keep Rover firmly in his place!

**Range Rover**

DA4141	Range Rover Classic - 1986 - 1994	Half height	Mesh type	Black
STC8524	Range Rover P38	Half height	Bar type	Grey
DA1081	Range Rover Sport - 2005 - 2013	Half height	Mesh type	Grey
DA1082	Range Rover Sport - 2005 - 2013 - dog guard divider. Use with DA1081	Half height	Mesh type	Grey
DA5810	Range Rover Sport - 2014 - onwards	Half height	Mesh type	Grey
DA5811	Range Rover Sport - 2014 - onwards - dog guard divider. Use with DA5810	Half height	Mesh type	Grey
VUB002120	Range Rover L322	Half height	Mesh type	Black
LR007320 <b>NEW</b>	Range Rover L322	Half height	Mesh type	Black
DA5806	Range Rover L405	Upper guard	Mesh type	Grey
DA5807	Range Rover L405	Lower guard	Mesh type	Grey
		Can only be used in conjunction with DA5806		
DA5808	Range Rover L405 - dog guard divider. Use with DA5806 & DA5807	Half height	Mesh type	Grey
DA5803	Range Rover Evoque - 5-door	Half height	Mesh type	Grey
DA5804	Range Rover Evoque - 5-door dog guard divider. Use with DA5803	Half height	Mesh type	Grey
DA5805	Range Rover Evoque - 3-door	Half height	Mesh type	Grey



Photograph courtesy of John Redden



DA5806

Note - This is the upper guard only



DA5807

Note - This is the lower guard only



DA5808



DA5803



DA5804



DA5805

## Loadspace

### Loadspace Mats & Protectors



331401



DA4470



LR005615



DA4503

#### Defender/Series

<b>331401</b>	Defender 90/Series SWB	Loadspace mat	Rubber
<b>331670 NEW</b>	Defender 110/Series LWB	Loadspace mat	Rubber
<b>DA4470</b>	Defender 90	Loadspace mat	Rubber
<b>LR005615</b>	Defender 90	Loadspace mat	Rubber
<b>DA4503</b>	Defender 110 - Hard top & truck cab	Loadspace mat	Rubber

5mm rubber with 6mm foam backing - 93 x 198cm

#### Range Rover

<i>Range Rover Sport</i> - 2005 - 2013			
<b>VPLSS0043</b>	Loadspace mat		Rubber
<b>EBF500020</b>	Loadspace protector - 4" deep sides		Semi-rigid
<b>VPLSS0016</b>	Loadspace flexible protector		
<b>Note</b> - Not shown but is similar to image VPLFS0244			
<i>Range Rover L322</i> - all models			
<b>LR003894</b>	Loadspace mat		Rubber
<b>EBF000040</b>	Loadspace protector - 6" deep sides		Semi-rigid
<i>Range Rover L405</i> - all models			
<b>VPLGS0263</b>	Loadspace protector - 2" deep sides		Semi-rigid
<i>Range Rover Evoque</i> - all models			
<b>VPLVS0091</b>	Loadspace mat		Rubber
<b>VPLVS0089</b>	Loadspace protector - 2" deep sides		Semi-rigid
<b>VPLVS0090</b>	Loadspace flexible protector - supplied in a smart Range Rover branded bag. <b>Note</b> - Not shown but is similar to image VPLFS0244		



VPLSS0043



EBF500020

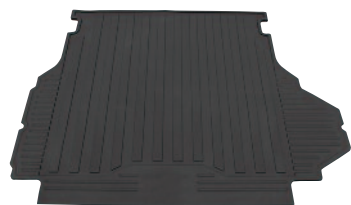

LR003894

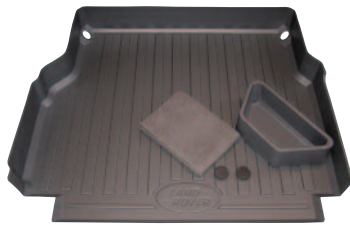

EBF000040



VPLVS0091



VPLVS0089

#### Freelander

<b>STC50434</b>	Freelander 1	Loadspace mat	Rubber
<b>LR002516</b>	Freelander 2	Loadspace mat	Rubber
<b>LR002424</b>	Freelander 2	Loadspace protector - 3" deep sides	Semi-rigid
<b>VPLFS0244</b>	Freelander 2	Loadspace flexible protector	



STC50434



LR002516



LR002424



VPLFS0244

Shown here fitted to a Range Rover Sport



DA4183



STC50050



STC50052AA



STC50053AA



EBF500010

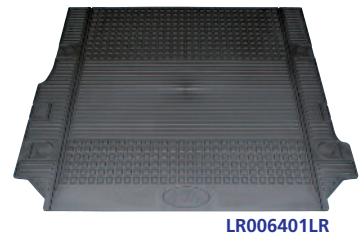

LR006401LR

#### Discovery Sport

<b>VPLCS0279 NEW</b>	Rubber mat - loading compartment
<b>VPLCS0273 NEW</b>	Rubber mat - loading compartment Extension
<b>VPLCS0268 NEW</b>	Semi-rigid liner - loading compartment
Compatible with cargo barrier	
<b>VPLCS0274 NEW</b>	Semi-rigid liner - loading compartment
Not compatible with cargo barrier	



VPLGS0263

#### Discovery

<i>Discovery 1</i>	
<b>DA4183</b>	Loadspace protector - 3" deep sides
Semi-rigid	
<i>Discovery 2</i>	
<b>STC50052AA</b>	Loadspace mat - half length
	Rubber
<b>STC50053AA</b>	Loadspace mat - full length
	Rubber
<b>STC50050</b>	Loadspace protector - 8" deep sides
Semi-rigid	
<b>Note</b> - Trim required for air-con models	
<i>Discovery 3/Discovery 4</i>	
<b>LR006401LR</b>	Loadspace mat - half length
	Rubber
<b>EBF500010</b>	Loadspace protector - 6" deep sides
Semi-rigid	
<b>VPLAS0015</b>	Loadspace flexible protector
<b>Note</b> - Not shown but is similar to image VPLFS0244	

**KEEP DIRT AT BAY WITH LOADSPACE PROTECTION!**

**Loadspace Protectors - Premium**

DA4169



DA5602



DA4171



*She's ready for a lift home, is your Land Rover ready?*

Britpart's **unique premium** loadspace protectors are manufactured from a high-specification material. Designed to be durable with an anti-slip, matt look finish - perfect for muddy passengers!



DA5554



DA4170



DA5555

**Discovery**

DA4169	Discovery 2	Loadspace protector - Premium	3" deep sides	Semi-rigid
DA5602	Discovery 3/Discovery 4	Loadspace protector - Premium	3" deep sides	Semi-rigid

**Freelander**

DA4171	Freelander 1	Loadspace protector - Premium	2" deep sides	Semi-rigid
DA5554	Freelander 2	Loadspace protector - Premium	2" deep sides	Semi-rigid

**Range Rover**

DA4170	Range Rover P38	Loadspace protector - Premium	3" deep sides	Semi-rigid
DA5555	Range Rover Sport - 2005 - 2013	Loadspace protector - Premium	2" deep sides	Semi-rigid
DA5556	Range Rover L322 - all models	Loadspace protector - Premium	2" deep sides	Semi-rigid



DA5556

**These quality protectors will look after your Land Rover's loadspace for years to come!**

Loadspace protectors manufactured from semi-rigid foam with anti-slip finish and 2" deep sides.

**DA5557**

Range Rover Evoque - 3 & 5 door models
DA4825
Range Rover Sport - 2014 onwards
DA4822
Range Rover L405



DA5557



DA4825

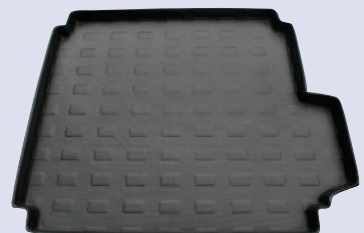

DA4822

## Loadspace Nets & Retention Kits



VUB000700



VPLV50125



LR017770

### Loadspace Retention Kits

Restricts the movement of goods in the rear of the vehicle  
**VUB000700**

Range Rover L322

Contents - 1 x floor net & 2 x ratchet straps

**VUB503130**

Discovery 3/Discovery 4 /Range Rover Sport - 2005 - 2013  
 Range Rover Evoque

Contents - 1 x floor net & 2 x ratchet straps

**VPLV50125**

Range Rover Sport - 2010 - 2013/Range Rover Evoque

Contents - 1 x rear retention bars; 1 x side retention strap  
 & 1 x storage case

**Note** - must be used in conjunction with loadspace  
 luggage rails.

### Loadspace Luggage Rails

**VPLS50138**

Range Rover Sport - 2010 - 2013

**VPLV50102**

Range Rover Evoque

### Loadspace Nets

A convenient way of storing luggage to maximise load  
 space

**LR017770**

Range Rover L322

Contents - 2 x nets

**LR003852**

Freelander 2

Contents - 1 x net

Can be used in two positions within the loadspace

### Umbrella Holder

A convenient way of storing your umbrella

**VPLGS0153**

Range Rover L405

Contents - 2 x holders



VPLV50102

VPLS50138



LR003852

Umbrella not included

POSITION 1



POSITION 2



VPLGS0153

Umbrella not included



## Mats

### Carpet Mat Sets



DA4022BLACK

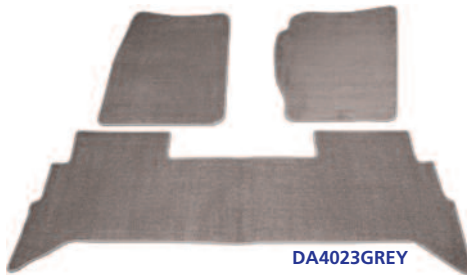

DA4023GREY

**DA4022BLACK** Defender - all models - front only Black

**DA4023BLACK** Discovery 1 Black

**DA4023BLUE** Discovery 1 Blue

**DA4023GREY** Discovery 1 Grey

**Note** - Front and rear carpet sets with rubber backing.

Protect your vehicle interior  
 with a set of smart floor mats...

### Rubber Mat Sets



BTR7895



BTR7896

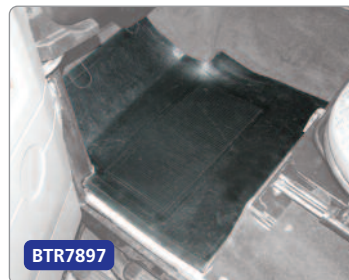

BTR7897



BTR7898

**Individual Mats** - Heavy-duty Defender rubber mats with foam backing

**BTR7895** Defender - LT77 Gearbox Front floor left hand

**BTR7896** Defender - LT77 Gearbox Front floor right hand

**BTR7897** Defender - 1993 onwards Front floor left hand

**BTR7898** Defender - 1993 onwards Front floor right hand

**Mat Sets**

**DA4501** Defender - LT77 Gearbox Front right & left hand

**DA4502** Defender - 1993 onwards Front right & left hand

**STC50172** Defender - from XA159807 Front right & left hand

**LR005039** Defender - up to BA999999 Front right & left hand

**VPLD50147** Defender - from CA000001 Front right & left hand

Contains - BTR7895 & BTR7896

Contains - BTR7897 & BTR7898

No foam backing

No foam backing

No foam backing



DA4422



DA4423



DA4426



DA4427



DA4424



DA4425



DA4802



DA4428



DA4429



DA4800



DA4430



DA4431



DA4804



DA4806



DA4812



DA4808

**Quality fitted rubber over mats**

DA4422	Series 2/Series 3		Front	Pair
DA4423	Defender - all models from XA159807		Front	Pair
DA4426	Discovery 1		Front	Pair
DA4427	Discovery 1		Rear	Pair
DA4424	Discovery 2		Front	Pair
DA4425	Discovery 2		Rear	Pair
DA4802	Discovery 3/Discovery 4	RHD	Front & Rear	Set
DA4803	Discovery 3/Discovery 4	LHD	Front & Rear	Set
DA4428	Freelander 1		Front	Pair
DA4429	Freelander 1		Rear	Pair
DA4800	Freelander 2	RHD	Front & Rear	Set
DA4801	Freelander 2	LHD	Front & Rear	Set
DA4430	Range Rover P38		Front	Pair
DA4431	Range Rover P38		Rear	Pair
DA4804	Range Rover Sport - 2005 - 2013	RHD	Front & Rear	Set
DA4805	Range Rover Sport - 2005 - 2013	LHD	Front & Rear	Set
DA4823	Range Rover Sport - 2014 onwards	RHD	Front & Rear	Set
DA4824	Range Rover Sport - 2014 onwards	LHD	Front & Rear	Set
DA4806	Range Rover L322 - up to 6A999999	RHD	Front & Rear	Set
DA4807	Range Rover L322 - up to 6A999999	LHD	Front & Rear	Set
DA4808	Range Rover L322 - 7A000001 onwards	RHD	Front & Rear	Set
DA4809	Range Rover L322 - 7A000001 onwards	LHD	Front & Rear	Set
DA4820	Range Rover L405 - 2013 onwards	RHD	Front & Rear	Set
DA4821	Range Rover L405 - 2013 onwards	LHD	Front & Rear	Set
DA4812	Range Rover Evoque - 2 & 4 door	RHD	Front & Rear	Set
DA4813	Range Rover Evoque - 2 & 4 door	LHD	Front & Rear	Set



DA4823



With new anti-slip texture design.

For more mat images visit - [www.britpart.com/mats](http://www.britpart.com/mats)

Keep your Land Rover interior clean with a set of mats from Britpart!



DA4820

With new anti-slip texture design.

## Premium Mat Sets



### Carpet With Rubber Backing

VPLFS0245PVJ	Freelander 2	Front & rear contour set	RHD	Ebony black
VPLFS0246PVJ	Freelander 2	Front & rear contour set	LHD	Ebony black
LR002485	Freelander 2	Front & rear contour set	RHD	Alpaca beige
LR002497	Freelander 2	Front & rear contour set	LHD	Alpaca beige
EAH500080PVJ	Discovery 3	Front & rear floor set	LHD	Ebony black
LR006433	Discovery 3	Front & rear contour set	LHD	Alpaca beige
VPLAS0023PVJ	Discovery 3/Discovery 4	Front & rear contour set	LHD	Ebony black
EAH500011LUP	Range Rover Sport - 2005 - 2013	Front & rear floor set	LHD	Aspen
LR006435	Range Rover Sport - 2008 - 2013	Front & rear contour set	RHD	Ebony black
LR006437	Range Rover Sport - 2008 - 2013	Front & rear contour set	LHD	Ebony black
EAH500011PVJ	Range Rover Sport - 2005 - 2013	Front & rear floor set	LHD	Ebony black
EAH500015SMS	Range Rover Sport - 2005 - 2013	Front & rear floor set	LHD	Alpaca beige
EAH000300JMN	Range Rover L322 - up to 6A	Front & rear contour set	RHD	Navy
EAH000310JMN	Range Rover L322 - up to 6A	Front & rear contour set	LHD	Navy
EAH000310LUP	Range Rover L322 - up to 6A	Front & rear contour set	LHD	Aspen
EAH000300PVA	Range Rover L322 - up to 6A	Front & rear contour set	RHD	Jet
EAH000300SUN	Range Rover L322 - up to 6A	Front & rear contour set	RHD	Sand
EAH000310SUN	Range Rover L322 - up to 6A	Front & rear contour set	LHD	Sand
EAH500290LUP	Range Rover L322 - from 7A	Front & rear contour set	LHD	Aspen
EAH500290PVA	Range Rover L322 - from 7A	Front & rear contour set	LHD	Jet
EAH500290SUN	Range Rover L322 - from 7A	Front & rear contour set	LHD	Sand

## Premium protection for your Land Rover...

### Rubber

VPLFS0233	Freelander 2	Front & rear contour set	RHD	Black
VPLFS0234	Freelander 2	Front & rear contour set	LHD	Black
LR006237	Discovery 3/Discovery 4	Front & rear contour set	RHD	Black
LR006238	Discovery 3/Discovery 4	Front & rear contour set	LHD	Black
EAH500100PMA	Discovery 3/Discovery 4	3rd Row floor mat	N/A	Black
EAH500052PMA	Discovery 3	Front & rear floor set	RHD	Black
EAH500050PMA	Discovery 3	Front & rear floor set	LHD	Black
EAH500058PMA	Discovery 3	Front contour set	RHD	Black
EAH500057PMA	Discovery 3	Front contour set	LHD	Black
VPLCS0278 <b>NEW</b>	Discovery Sport	1st & 2nd Row	RHD	Black
VPLCS0281 <b>NEW</b>	Discovery Sport	1st & 2nd Row	LHD	Black
VPLCS0280 <b>NEW</b>	Discovery Sport	3rd row		Black
VPLAS0197	Range Rover Sport - 2005 - 2013	Front & rear contour set	RHD	Black
VPLAS0198	Range Rover Sport - 2005 - 2013	Front & rear contour set	LHD	Black
VPLSS0104	Range Rover Sport - 2005 - 2013	Front & rear floor set	RHD	Black
EAH500051PMA	Range Rover Sport - 2005 - 2013	Front & rear floor set	LHD	Black
EAH500320PMA	Range Rover L322	Front & rear contour set	RHD	Black
EAH500330PMA	Range Rover L322	Front & rear contour set	LHD	Black
EAH000261PMA	Range Rover L322	Front & rear floor set	RHD	Black
EAH000271PMA	Range Rover L322	Front & rear floor set	LHD	Black
LR045096	Range Rover Evoque	Front & rear contour set	RHD	Black
LR045097	Range Rover Evoque	Front & rear contour set	LHD	Black



Photograph courtesy of Kristjan Kristjansson

# Waterproof Seat Covers

## Britpart Seat Covers



DA2815BLACK

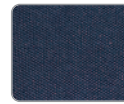

DA2815BLUE



DA2815GREEN



DA2815GREY



DA2815SAND

Colour swatches for illustrative purposes only

### Defender

**Defender - up to 2007** - 3 Seats - Front

Covers in kit - 3 x full seat (excludes headrest covers)

**Defender - 2007 onwards** - Front

Covers in kit - 2 x full seat; 2 x headrest

**Defender 110 Station Wagon - up to 2007** - Forward facing 2nd row - 60/40

Covers in kit - 1 x two-seat back & base; 1 x one-seat back & base. **Note** - Will fit 110 Crew Cab with minor modification to seat covers.

**Defender 110 Station Wagon - up to 2007** - Rear inward facing bench

Covers in kit - 2 x bench-seat back & base. **Note** - For 1,200mm long seat.

**Defender 90/110 - 2007 onwards** - Rear

Covers in kit - 2 x full seat; 2 x headrest

**Defender 110/130 - 2007 onwards** - Rear

Covers in kit - 3 x full seat; 3 x headrest

DA2818BLACK

DA2818GREY

DA2818SAND

DA2816BLACK

DA2816BLUE

DA2816GREY

DA2817BLUE

DA2817GREY

DA2838BLACK

DA2828BLACK

### Discovery

**Discovery 1** - Front

Covers in kit - 2 x full seat. **Note** - Discovery 1 seat covers will not fit vehicles with leather seats and 200Tdi's with pocket on rear seat.

**Discovery 1** - Rear

Covers in kit - 1 x two-seat back & base; 1 x one-seat back & base. **Note** - Discovery 1 seat covers will not fit vehicles with leather seats and 200Tdi's with pocket on rear seat.

**Discovery 1** - Boot

Covers in kit - 2 x full seat. **Note** - Discovery 1 seat covers will not fit vehicles with leather seats and 200Tdi's with pocket on rear seat.

**Discovery 2** - Front

Covers in kit - 2 x full seat; 2 x headrest; 2 x armrest.

**Discovery 2** - Rear

Covers in kit - 1 x full seat; 1 x two-seat back & base; 1 x armrest; 3 x headrest

**Discovery 2** - Boot

Covers in kit - 2 x full seat; 2 x roof headrest.

**Discovery 3** - Front

Covers in kit - 2 x full seat; 2 x headrest; 2 x armrest. **Note** - Suitable for vehicles with side airbags.

**Discovery 3** - Rear - 35/30/35 split

Covers in kit - 3 x full seat; 3 x headrests.

**Discovery 4** - Front

Covers in kit - 2 x full seat; 2 x headrest; 2 x armrest. **Note** - Suitable for vehicles with side airbags.

DA2807BLACK

DA2807BLUE

DA2807GREEN

DA2807GREY

DA2807SAND

DA2808BLACK

DA2808BLUE

DA2808GREEN

DA2808GREY

DA2808SAND

DA2809BLUE

DA2809GREEN

DA2809GREY

DA2800BLACK

DA2800BLUE

DA2800GREEN

DA2800GREY

DA2800SAND

DA2801BLACK

DA2801BLUE

DA2801GREEN

DA2801GREY

DA2802GREEN

DA2802GREY

DA2822BLACK

DA2822SAND

DA2823BLACK

DA2823SAND

DA2832BLACK



DA2815GREY



DA2816GREY



DA2818BLACK



DA2822SAND



DA2808GREY

Plenty more images at [www.britpart.com/seatcovers](http://www.britpart.com/seatcovers)



- An extensive range of quality and stylish waterproof seat cover sets.
- Front and rear sets available with headrests and armrests included in the Range Rover and Freelander range. Rear inward facing sets are also available for the 7-seater Discovery models.
- The hard-wearing washable covers are made from waterproof woven polyester with a PVC backing.
- Snug fit covers available in 5 stylish colours.
- Easy to put on the seats and just as easy to remove again.

*A fantastic way to protect your Land Rover seats with these Britpart waterproof covers...*

## Britpart Seat Covers - continued



DA2810BLACK



DA2811BLACK



DA2813GREEN



DA2810GREY



DA2811GREY

Colour swatches for illustrative purposes only

### Freelander

**Freelander 1** - 3 Door - Front

Covers in kit - 2 x back, base & headrest. **Note** - Not suitable for 2004 onwards facelift models.

**Freelander 1** - 5 Door - Front

Covers in kit - 2 x back, base & headrest. **Note** - Not suitable for 2004 onwards facelift models.

**Freelander 1** - 3 & 5 Door - Rear 60/40 split without armrest

Covers in kit - 1 x two-seat back & base; 1 x one-seat back & base; 3 x headrest. **Note** - Not suitable for 2004 onwards facelift models.

**Freelander 1** - 3 & 5 Door - Rear 60/40 split with armrest

Covers in kit - 1 x two-seat back & base; 1 x one-seat back & base; 3 x headrest. **Note** - Not suitable for 2004 onwards facelift models.

**Freelander 1** - 3 Door Sport - 2 Rear Seats

Covers in kit - 2 x back, base & headrest. **Note** - Not suitable for 2004 onwards facelift models.

**Freelander 2** - Front

Covers in kit - 2 x full seat; 2 x headrest; 2 x armrest. **Note** - Suitable for use with airbags.

**Freelander 2** - Rear

Covers in kit - 1 x two-seat back & base; 1 x one-seat back & base; 3 x headrest & 3 x armrest. **Note** - Not suitable for vehicles with leather seats.

### Range Rover

**Range Rover Classic** - 4 Door - Front

Covers in kit - 2 x back, base, armrest & headrest.

**Range Rover Classic** - 4 Door - Rear

Covers in kit - 1 x two-seat back & base; 1 x one-seat back & base; 3 x armrest.

**Range Rover P38** - Front

Covers in kit - 2 x full seat, headrest & armrest. **Note** - Not suitable for vehicles with rear air bags mounted in the front seats or seats with electric headrests.

**Range Rover P38** - Rear

Covers in kit - 1 x two-seat back & base; 1 x one-seat back & base; 3 x headrest; 1 x armrest.

**Range Rover Sport - 2005 - 2009** - Front

Covers in kit - 2 x full seat; 2 x headrest; 2 x armrest.

**Range Rover Sport - 2005 - 2009** - Front - vehicles with electric headrests

Covers in kit - 2 x full seat; 2 x headrest; 2 x armrest.

**Range Rover Sport - 2005 - 2009** - Rear

Covers in kit - 1 x two-seat back & base; 1 x one-seat back & base; 3 x headrest & 3 x armrest

**Range Rover Sport - 2010 - 2013** - Front

Covers in kit - 2 x full seat, headrest & armrest

**Range Rover L322 - 2007 - 2009** - Front

Covers in kit - 2 x full seat; 2 x headrest; 2 x armrest. **Note** - Non-power assisted headrests only.

**Range Rover L322** - Rear

Covers in kit - 1 x one-seat base; 1 x two-seat base; 2 x back; 1 x middle back; 2 x headrest

DA2803BLACK

DA2803BLUE

DA2803GREY

DA2803SAND

DA2804BLUE

DA2804GREEN

DA2804GREY

DA2804SAND

DA2805GREEN

DA2805GREY

DA2806BLUE

DA2819BLACK

DA2819SAND

DA2825SAND

DA2829BLACK

DA2839BLACK

DA2839SAND

DA2820BLACK

DA2830BLACK

Plenty more images at  
[www.britpart.com/seatcovers](http://www.britpart.com/seatcovers)



DA2813GREEN



DA2821BLACK



DA2803GREY



## Waterproof Seat Covers - Other

### Inka Seat Covers

These stylish seat cover kits also include headrest and armrest covers (where applicable) with a fitting guide. The kits are waterproof, fire retardant and washable.

VPLDS0011	Defender - 2007 onwards	Front	Black
VPLAS0029PVJ	Discovery 4	Front	Black
VPLFS0107PVJ	Freelander 2	Front	Black
LR005059	Freelander 2	Front	Sand
LR005058	Freelander 2	Front	Aspen
VPLSS0026PVJ	Range Rover Sport - 2010 - 2013	Front	Black

### Range Rover Evoque

VPLVS0070PVJ	3-door less rear entertainment	Front	Black
VPLVS0071PVJ	5-door less rear entertainment	Front	Black
VPLVS0072PVJ	2 individual 2nd row seat	Rear	Black
VPLVS0073PVJ	2nd row 60/40 folding with armrests	Rear	Black
VPLVS0077PVJ	2nd row 60/40 folding	Rear	Black

### Range Rover L405

VPLGS0154SVA		Front	Almond
VPLGS0154PVJ		Front	Black
VPLGS0155SVA	60/40 power fold	Rear	Almond
VPLGS0155PVJ	60/40 power fold	Rear	Black

### Range Rover L322 - 2010 - 2012

VPLMS0085SVA	Front	Sand
VPLMS0085PVJ	Front	Black
VPLMS0087SVA	Rear	Sand
VPLMS0087PVJ	Rear	Black



### Land Rover Seat Covers

HBD000320JMN	Range Rover L322 - 2002 - 2006	Front	Navy
HBD000320LUP	Range Rover L322 - 2002 - 2006	Front	Aspen
HBD000320LYR	Range Rover L322 - 2002 - 2006	Front	Charcoal
HBD000320SUN	Range Rover L322 - 2002 - 2006	Front	Sand
VPLCS0291PVJ NEW	Discovery Sport	Front	Black
VPLCS0292PVJ NEW	Discovery Sport	2nd row	Black
VPLCS0293PVJ NEW	Discovery Sport	3rd row	Black
VPLCS0291SVA NEW	Discovery Sport	Front	Almond
VPLCS0292SVA NEW	Discovery Sport	2nd row	Almond
VPLCS0293SVA NEW	Discovery Sport	3rd row	Almond



Photograph courtesy of David Gates



## Section Eight

## Section contents

<b>Bulkhead bars &amp; extended slide seat rails</b>	
Bulkhead bars	67
Extended slide seat rails	67
<b>Cubby boxes &amp; armrests</b>	
Defender & Series	66
Freelander	66
Range Rover Evoque	67
<b>Fume curtain</b>	67
<b>Gear box gaiters</b>	68
<b>Glove boxes</b>	67
<b>Hoods</b>	68
<b>Retrofit insert seat heaters</b>	72
<b>Seats</b>	
Defender - front seats	69
Defender - rear seats	70
Series - front & rear seats	70
Sparco seats	71
Re-trim kits	70
XS style seats	71
<b>Trim</b>	
Chain cover	71
Dash trim kits	71
Door stays	72
Door trims	72

“Saggy old seats? Get a set of smart new ones. We’ve plenty to choose from in a multitude of materials and colours. Also keep your vehicle clutter free with a cubby box.”

seats & trim

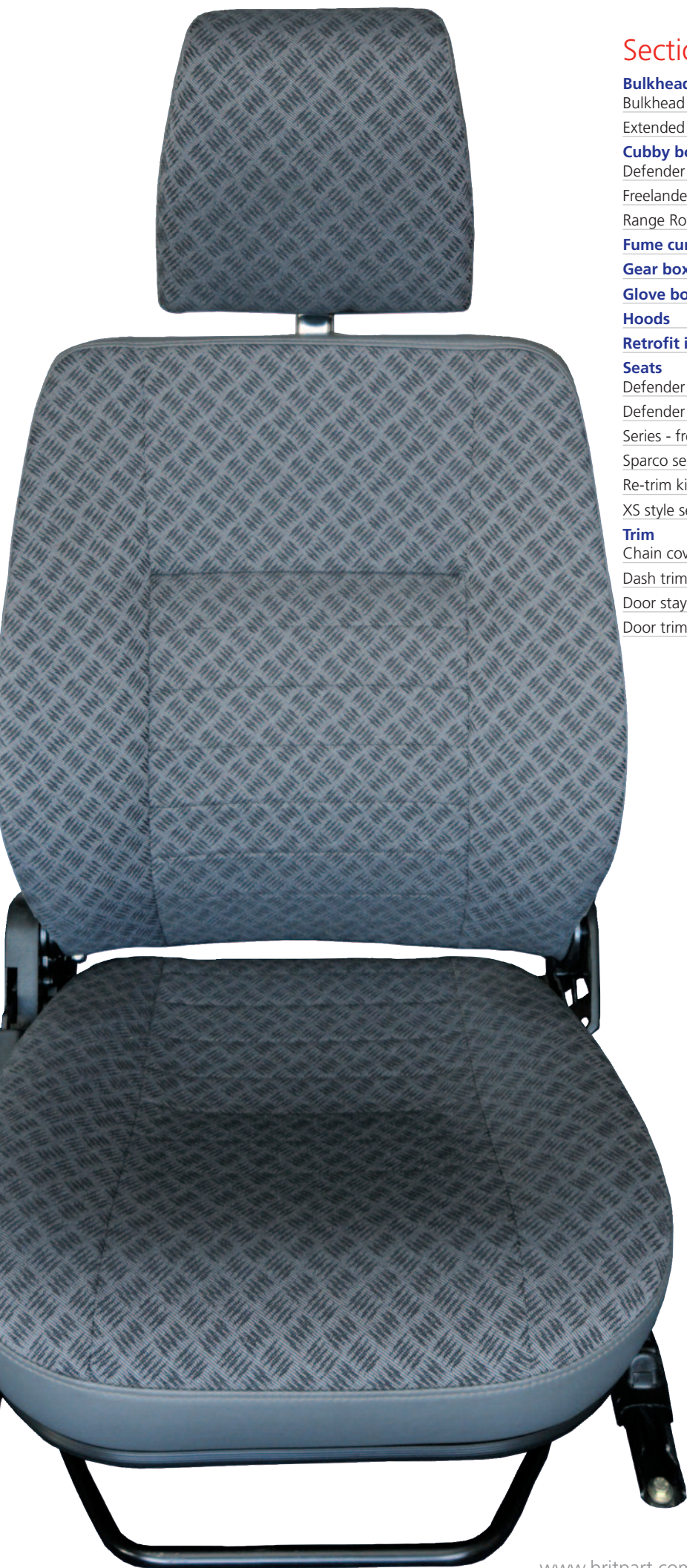

## Cubby Boxes & Armrests

### Defender & Series



DA2035



DA2035LCS

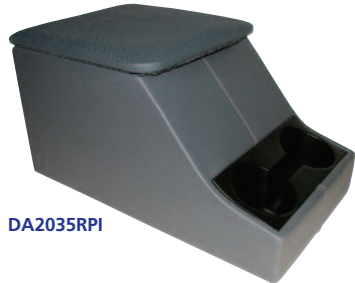

DA2035RPI



DA2035BLUE



DA2035BROWN

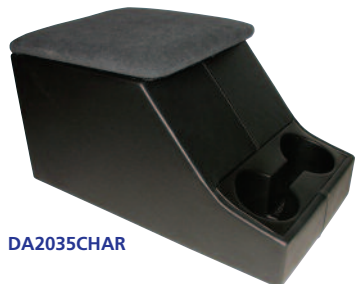

DA2035CHAR

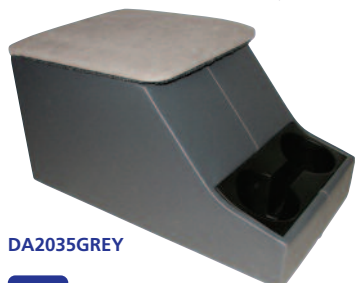

DA2035GREY

DA2035T



DA2149

### KEEP YOUR DEFENDER & SERIES 3 CLUTTER FREE

#### XS Style Cubby Boxes

Hand-built in the UK, these quality XS style cubby boxes are suitable for Defenders and Series 3. Well crafted with precision tools using a hard wearing leatherette outer and velour trim inner. Each box has locking tools using a hard wearing leatherette outer and velour trim inner. Each box has locking stay brass hinges. These XS Style cubby boxes match our range of XS Style seats - see this section. Now with a double cup holder as standard, spilt drinks are a thing of the past.

	Top	Body		Top	Body
DA2035BLUE	Blue	Black	DA2035CHAR	Charcoal	Black
DA2035BROWN	Light brown	Dark brown	DA2035GREY	Light grey	Dark grey

With a Britpart cubby box in your Land Rover you can ensure your vehicle remains clutter free with these handy storage devices. Now with a double cup holder as standard, spilt drinks are a thing of the past. If security is a worry, then peace of mind can be achieved with our cubby box made from metal with a padded lid which is lockable.

	Top	Body
DA2035	Black	Black
DA2035LCS	Grey	Grey
DA2035RPI	Vinyl twill	Grey
DA2035T	Techno	Grey

#### Security Cubby Box

Protect your valuables with this secure powder coated steel cubby box. Includes a lockable slot for radios and CB units. 2 keys & 3 removable cup holders

DA2149	Grey	Black
--------	------	-------

#### Cubby Box Cup Holder

FWJ500020PMA  
Double cup holder for both old and new model Defenders - ideal for holding a Britpart travel mug or two!!  
**Note** - To fit to existing carpet lined cubby box the lining may have to be taken out. Also XS Style cubby boxes. Excludes travel mug - DA8015



### Freelander Cubby boxes & armrests



DA5101



DA5103

- Innovative design.
- Strong ABS storage base.
- Large storage capacity.
- Easy do-it-yourself installation in only 5 minutes in the original point.
- Boxes for vehicles with no factory fitted armrests have adjustable sliding tops.

#### Freelander 2 - up to 2012 - with no factory fitted armrests

DA5101	RHD	Black real leather
DA5102	RHD	Black eco leather
DA5103	RHD	Alpaca leather
DA5113	RHD	Almond leather
DA5104	LHD	Black real leather
DA5105	LHD	Black eco leather
DA5106	LHD	Alpaca leather
DA5114	LHD	Almond leather

Dimensions - 230mm long x 145mm wide x 180mm high

#### Freelander 1 - 2001 - 2006

Add some support to your Freelander with one of these stylish adjustable armrests.

- Innovative design
- Easy do-it-yourself installation

DA5116	Black eco leather
DA5117	Black real leather
DA5118	Smokestone real leather

Dimensions - 290mm long x 170mm wide x 130mm high



DA5113



DA5111



DA5138



DA5139



DA5140

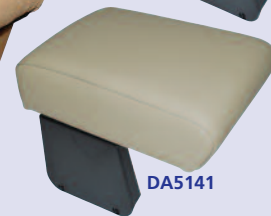

DA5141

#### Freelander 2 - up to 2012 - with factory fitted armrests

DA5115	Black real leather
DA5109	Black eco leather
DA5111	Alpaca leather
DA5112	Almond leather

**Note** - For both RHD & LHD vehicles. Dimensions - 220mm long x 125mm wide x 160mm high

#### Freelander 2 - 2013 onwards - without original armrest in the seat

- Armrest with soft pad and real stitching.
- Simple do-it-yourself fitting in only 5 minutes.

DA5138	Black eco leather
DA5139	Black automotive fabric
DA5140	Black real leather
DA5141	Almond real leather

**Note** - For both RHD & LHD vehicles. Dimensions - 280mm long x 200mm wide x 220mm high



DA5116



DA5118

**Range Rover Evoque**

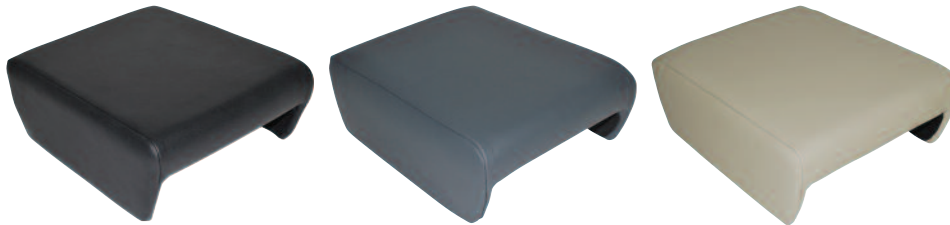

**DA5122** Black      **DA5123** Lunar      **DA5124** Almond



**DA5122**

Improve your driving position in a Range Rover Evoque with an additional armrest.  
 • Manufactured from real leather and simple to fit.  
 • The armrest can easily be moved to suit your driving position and you will still be able to access the cubby box.

**Bulkhead Bars & Extended Slide Seat Rails**

**Bulkhead Bars**

**Extended Slide Seat Rails**



**DA1810**



**DA2351**



**DA2148**

Need more leg room and seat adjustment in your Defender? These bulk head bars alleviate that problem without compromising strength. The bulk head bars allow for extra seat recline and travel on the seat base - giving you a more comfortable seating position and more space in the front foot wells. The bars create a rigid bracing for the front of the Defender tub and as well as the added benefits of extra room in the vehicle due to the seats been more manoeuvrable, access to the rear of the Defender is now not compromised by a higher bulk head. Powder coated and supplied complete with all the necessary fixings and instructions.

**DA1810**  
Defender  
OEM bulkhead  
removal bar kit



**DA2351**  
Defender  
bulkhead  
reduction bar kit



> Ideal for the taller driver  
 > A more practical and comfortable driving position

**DA2148**  
Give your Defender (including 2007 onwards model) seats 3" of extra slide with a pair of these seat rails. Ideal for the taller driver to give a more practical and comfortable driving position. One pair of rails is suitable for one seat.

**Glove Boxes**



**DA2603 - CLOSED**



**DA2603 - OPEN**



**DA2603CF**

Neat storage solution for the new Defender which utilises the available dashboard space. Ideal for storing all the usual small items you carry with you. Robust construction and easy to fit with all the necessary parts supplied.

**DA2603** Defender - 2007 onwards - right and left hand drive models  
**DA2603CF** Defender - 2007 onwards - right and left hand drive models

Facia plate with carbon fibre effect finish

**Fume Curtain**

**MRC3519**  
Defender/Series  
**Note** - Hood stick not included - 330553



Photograph courtesy of Alfred Schleicher

## Gear Box Gaiters



DA5499



FJL101530PMA / FJL101680PMA / FJL101710PMA

Got a Defender, Discovery or Series with a tatty gear box gaiter?

Replace it with a smart new hard wearing one from Britpart!

**DA5498**  
Defender  
Grey

**DA5499**  
Defender  
Black

**DA2466**  
Series  
Black  
Kit contents - handbrake, gearstick and 4-wheel drive selector

For details of the alloy gear stick knobs (DA5500) see the Vehicle Enhancement section.

DA2466



DA5498



**FJL101530PMA**  
Discovery 1/Discovery 2  
High/low lever  
Black



**FJL101680PMA**  
Discovery 1/Discovery 2  
Gear lever  
Black



**FJL101710PMA**  
Discovery 1/Discovery 2  
Handbrake lever  
Black



Photograph courtesy of Claire Borlase

## Hoods

Got a Land Rover with a hood that has seen better days?

Tears? Frayed fixings? Scratched windows?

We'll give your vehicle a quick facelift with a new canvas hood from Britpart.

- Hoods are made from the original 18oz canvas and made to OEM specifications.
- All fittings are brass and made to OEM specifications.
- Webbing is made the same way as the original.
- Polypropylene rope is the same construction as the original rope.
- Ropes are all inserted into the hood to help customers.
- Care instruction are included.

Other hoods available on request - please ask for details.

<b>331110AG</b>	Series - SWB	Full hood	Khaki	Without windows
<b>331113AG</b>	Series - SWB	Full hood	Khaki	With windows
<b>331110SA</b>	Series - SWB	Full hood	Sand	Without windows
<b>331113SA</b>	Series - SWB	Full hood	Sand	With windows
<b>331371AG</b>	Series - SWB	Three quarters hood	Khaki	Without windows
<b>331259AG</b>	Series - LWB	Full hood	Khaki	Without windows
<b>331260AG</b>	Series - LWB	Full hood	Khaki	With windows
<b>331259SA</b>	Series - LWB	Full hood	Sand	Without windows
<b>331260SA</b>	Series - LWB	Full hood	Sand	With windows
<b>331308AG</b>	Series - LWB	Three quarters hood	Khaki	With windows
<b>MUC2437</b>	Series - LWB - V8 High capacity pick-up	Three quarters hood	Khaki	Without windows
<b>MUC4122ABE</b>	Defender 90	Full hood	Sand	With windows



331110SA



331113SA



MUC4122ABE



331259SA



331113AG

**Seats**

**Defender - Front Seats**

<b>Black Seats</b>		
DA4028	Seat cover	Outer base
DA4041	Seat cover	Outer back
DA4589 <b>NEW</b>	Seat cover	Centre base - 1990 onwards
DA4590 <b>NEW</b>	Seat cover	Centre back - 1990 onwards
MWC3302	Seat	Right hand back
MWC3303	Seat	Left hand back
MWC4535	Seat	Outer base
MWC1010	Headrest assembly	

<b>Grey Seats</b>		
DA4029	Seat cover	Outer base
DA4042	Seat cover	Outer back
DA4591 <b>NEW</b>	Seat cover	Centre base - 1990 onwards
DA4592 <b>NEW</b>	Seat cover	Centre back - 1990 onwards
BTR1759LCS	Seat cover with map pocket	Outer back
MWC9844LCS	Seat	Right hand back
MWC9843LCS	Seat	Left hand back
MWC5670LCS	Seat	Outer base
MWC5628LCS	Headrest assembly	

<b>Vinyl Twill Seats</b>		
AWR5701RPI	Seat cover	Outer base
AWR5702RPI	Seat cover	Outer back
DA4593 <b>NEW</b>	Seat cover	Centre base - 1990 onwards
DA4594 <b>NEW</b>	Seat cover	Centre back - 1990 onwards
AWR5698RPI	Seat	Right hand back
AWR5699RPI	Seat	Left hand back
AWR5700RPI	Seat	Outer base
AWR5708RPI	Headrest assembly	
HAD501820RPI	Right hand assembly	Less headrest
HAD501870RPI	Left hand assembly	Less headrest

<b>Techno Style Seats</b>		
HAG100970LOY	Base	
HCA106010LOY	Cover base	
DA4595 <b>NEW</b>	Seat cover	Centre base - 1990 onwards
DA4596 <b>NEW</b>	Seat cover	Centre back - 1990 onwards
HAI101400LOY	Squab assembly - no pockets	Right hand side
HAI101410LOY	Squab assembly - no pockets	Left hand side
HBA106190LOY	Squab cover - no pocket	
HBA106180LOY	Squab cover - with pocket	
HAH103510LOY	Headrest	

<b>Foam, Runners &amp; Finishers</b>		
349943 <b>NEW</b>	Plastic corner capping for standard Defender & Series seat bases	
DA4031	Seat foam	Outer base
DA4055	Seat foam	Outer back
DA4057	Seat foam	Centre base
DA4056	Seat foam	Centre back
MTC9967	Front seat edge finisher	
HHD102280	Runner & sub-frame	Right hand side
HHD102290	Runner & sub-frame	Left hand side



The highly skilled team in the Britpart Trim Shop make a wide range of seats and seat covers for Land Rover vehicles by hand. The material arrives in vast reams and has to be cut with great precision before being stitched together and then assembled into seat bases, seat backs, seat benches etc. In keeping with the Britpart philosophy, all products leaving the Trim Shop are produced to the highest standards and meet with the strictest safety regulations.



For many more pictures of our seats and trim please visit [www.britpart.com/seats](http://www.britpart.com/seats)



## Series - Front Seats

Black Seats		
349967	Seat base	Standard outer
320699	Seat base - adjustable	Standard outer
320726	Seat base	Standard centre
320698	Seat back - bolt fitment - adjustable	Standard outer
MUC1520	Seat back - pin fitment	Standard outer
MUC1520G	Seat back - bolt fitment	Standard outer
MUC1488	Seat back	Standard centre
DA4305	Standard seat kit	
<b>Note</b> - Kit contains - 2 x 349967; 2 x MUC1520; 1 x 320726 & 1 x MUC1488		
MRC6980	Seat base	Deluxe outer
MRC6982	Seat back	Deluxe outer
MRC6982H	Seat back with headrest	Deluxe outer
MRC6985	Seat base	Deluxe centre
MTC3181	Seat back	Deluxe centre
DA4298	Deluxe seat kit	
<b>Note</b> - Kit contains - 2 x MRC6982; 2 x MRC6980; 1 x MTC3181 & 1 x MRC6985		

County Brown Seats		
MRC6980CB	Seat base	Deluxe outer
MRC6982CB	Seat back	Deluxe outer
MRC6985CB	Seat base	Deluxe centre
MTC3181CB	Seat back	Deluxe centre

County Grey Seats		
MRC6980CG	Seat base	Deluxe outer
MRC6982CG	Seat back	Deluxe outer
MRC6985CG	Seat base	Deluxe centre
MTC3181CG	Seat back	Deluxe centre

All products leaving the Trim Shop are produced to the highest standards!



MRC6985CG



MRC6982CB



320737



DA4067



DA4075T

## Re-trim Kits



DA5628

Going off-road? Got a working Land Rover?

Well the chances are your seats won't be in showroom condition, luckily here at Britpart we have the answer - a Defender re-trim kit.

**Online fitting guide** - We have compiled a 25 minute tutorial giving you detailed step-by-step instructions on how to disassemble and assemble your Defender seat and information on the correct use of the included parts. The video can be found at [www.britpart.com/re-trim](http://www.britpart.com/re-trim)

**Outer Seats** - Defender - from VIN AA677964 to 2007 (non-plastic backed front squab)

An outer Britpart re-trim kit includes:

1 x Can of contact adhesive spray	1 x Cushion foam
1 x Squab foam	1 x Cushion cover
1 x Squab cover	1 x Headrest cover
6 x Plastic nails	2 x Metal rods
3 x Cable ties	1 x Rubber retainer

DA5627	Vinyl twill
DA5628	Techno
DA5629	Black
DA5630	Grey
DA5636	XS style - Outer - Black / Inner - Charcoal

### Swatches

Material colours are an approximate match. Sample swatches of the actual material are available on request.



VINYL TWILL



TECHNO

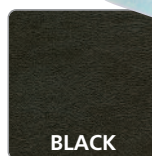

BLACK



GREY



DA5634

## Defender & Series - Rear Seats

Black Seats		
320737	Bench seat (810mm wide)	Rear assembly (inc. full fitting kit)
320647	Bench seat (810mm wide)	Rear back
396739	Bench seat (810mm wide)	Rear back - metal backed
320674	Bench seat (810mm wide)	Rear base
DA3059	Bench seat (1,200mm wide) - LWB	Rear assembly (inc. full fitting kit)
DA4067	Rear seat	Individual inward facing

County Brown Seats		
320737CB	Bench seat (810mm wide)	Rear assembly (inc. full fitting kit)
320647CB	Bench seat (810mm wide)	Rear back
320674CB	Bench seat (810mm wide)	Rear base

County Grey Seats		
320737CG	Bench seat (810mm wide)	Rear assembly (inc. full fitting kit)
320647CG	Bench seat (810mm wide)	Rear back
320674CG	Bench seat (810mm wide)	Rear base

Grey Seats		
320737LCS	Bench seat (810mm wide)	Rear assembly (inc. full fitting kit)
320647LCS	Bench seat (810mm wide)	Rear back
320674LCS	Bench seat (810mm wide)	Rear base
DA3059LCS	Bench seat (1,200mm wide) - LWB	Rear assembly (inc. full fitting kit)
DA4075	Rear seat	Individual inward facing

Techno Style Seats		
320737T	Bench seat (810mm wide)	Rear assembly (inc. full fitting kit)
320647T	Bench seat (810mm wide)	Rear back
320674T	Bench seat (810mm wide)	Rear base
DA3059T	Bench seat (1,200mm wide) - LWB	Rear assembly (inc. full fitting kit)
DA4075T	Rear seat	Individual inward facing

Vinyl Twill Seats		
320737RPI	Bench seat (810mm wide)	Rear assembly (inc. full fitting kit)
320647RPI	Bench seat (810mm wide)	Rear back
320674RPI	Bench seat (810mm wide)	Rear base
DA3059RPI	Bench seat (1,200mm wide) - LWB	Rear assembly (inc. full fitting kit)
DA4075RPI	Rear seat	Individual inward facing

## Centre Seats - Defender - 1990 onwards

A centre Britpart re-trim kit includes:

1 x Can of contact adhesive spray	1 x Cushion foam
1 x Squab foam	1 x Cushion cover
1 x Squab cover	6 x Plastic nails
1 x Metal rods	1 x Rubber retainer
DA5632 Vinyl twill	DA5633 Techno
DA5634 Black	DA5635 Grey

**Sparco Seats NEW**



**DA7301 NEW** Black leatherette



**DA7305 NEW** Black/Red

- Lightweight and compact
- High comfort
- Tubular frame construction
- High quality recline mechanism for smooth and easy adjustment
- Compatible with 3 or 4 fixing point harnesses
- Base mounted - 271 x 345mm

- DA7306 NEW** Seat runners
- DA7307 NEW** Mounting kit - removable
- DA7308 NEW** Mounting kit - fixed

Drawing on decades of racing history, Sparco has created a line of street car seats that offer the ultimate in comfort and performance. The ergonomic designs help cradle and protect the driver against even the most demanding lateral forces.

The R100 is Sparco's latest incarnation of groundbreaking steel-model seats. It features redesigned bolsters for greater support and new padding configurations for improved comfort.

It has been built with comfort and support in mind but it's lower side bolsters and slightly narrower steel frame allow it to fit into vehicles where fitting seats with larger side bolsters may be difficult. The seat features backrest harness slots so that it can be used with a race type harness or normal seatbelts.

The seats can be reclined using the double adjuster lever. Made from a durable fabric, the R100 is available in single tone or duo-tone styles. Duo-tone styles feature contrasting side accenting and stitching to match any interior. The Sparco R100 Seat range is designed to attach using Sparco vehicle specific seat mounts.



**DA7305 NEW** Black/Red



**DA7302 NEW** Black/Blue



**DA7303 NEW** Black/Grey



**DA7304 NEW** Black/Black

**XS Style Seats**



**DA5636**



**DA5615**

Hand-built in the UK, these quality XS style seats are suitable for Defenders. Well-crafted with precision tools using a hard wearing leatherette outer and velour trim inner. Comfort is ensured with injection moulded foam. Seats complete with base, back and headrest but the runners are not included.

	Outer	Inner	Side
<b>DA5610</b>	Dark grey	Light grey	RHS
<b>DA5611</b>	Dark grey	Light grey	LHS
<b>DA5614</b>	Black	Blue	RHS
<b>DA5615</b>	Black	Blue	LHS
<b>DA5616</b>	Dark brown	Light brown	RHS
<b>DA5617</b>	Dark brown	Light brown	LHS
<b>DA5618</b>	Black	Charcoal	RHS
<b>DA5619</b>	Black	Charcoal	LHS
<b>HHD102280</b>	Runner & sub-frame		RHS
<b>HHD102290</b>	Runner & sub-frame		LHS
<b>Re-trim Kit</b>	See re-trim section for full kit details.		
<b>DA5636</b>	Black	Charcoal	



**DA5619**



**DA5617**



**DA5611**

**Chain Cover**



**330422**  
Defender - 1987 - 2006/Series  
Stop your tailgate chain rattling away with this easy to fit chain cover. Single. Requires 2 per side.



**DA2098**

**Put A Stop To The Dreaded Discovery 1 Dash Peel!**

**Discovery 1 kits**

- DA2090** Black
- DA2091** Blue
- DA2096** Grey
- DA2098** Brown

**DA2091**

**Trim Dash Trim Kits**

## Door Trims



DA2441

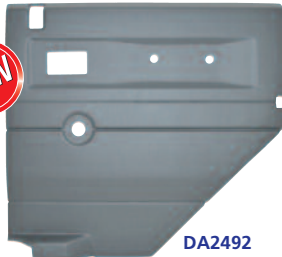

DA2492



MWC1743



DA2030

Replace the tatty old door cards in your Defender or Series with one of these smart plastic replacements. Easy to fit they are also easy to keep clean with a wipe clean finish.

DA2440	Defender - 1987 - 2006	Front casing	Manual window	Black	RHS	DA2480	Defender	Rear casing	Manual window	Black	RHS
DA2441	Defender - 1987 - 2006	Front casing	Manual window	Black	LHS	DA2481	Defender	Rear casing	Manual window	Black	LHS
DA2442	Defender - 1987 - 2006	Front casing	Manual window	Grey	RHS	DA2482	Defender	Rear casing	Manual window	Grey	RHS
DA2443	Defender - 1987 - 2006	Front casing	Manual window	Grey	LHS	DA2483	Defender	Rear casing	Manual window	Grey	LHS
DA2490 <b>NEW</b>	Defender - 1987 - 2006	Front casing	Manual window	Light Grey	RHS	DA2492 <b>NEW</b>	Defender	Rear casing	Manual window	Light Grey	RHS
DA2491 <b>NEW</b>	Defender - 1987 - 2006	Front casing	Manual window	Light Grey	LHS	DA2493 <b>NEW</b>	Defender	Rear casing	Manual window	Light Grey	LHS
DA2444	Defender - 1987 - 2006	Front casing	Electric window	Black	RHS	DA2484	Defender	Rear casing	Electric window	Black	RHS
DA2445	Defender - 1987 - 2006	Front casing	Electric window	Black	LHS	DA2485	Defender	Rear casing	Electric window	Black	LHS
DA2446	Defender - 1987 - 2006	Front casing	Electric window	Grey	RHS	DA2486	Defender	Rear casing	Electric window	Grey	RHS
DA2447	Defender - 1987 - 2006	Front casing	Electric window	Grey	LHS	DA2487	Defender	Rear casing	Electric window	Grey	LHS
DA2494 <b>NEW</b>	Defender - 1987 - 2006	Front casing	Electric window	Light Grey	RHS	DA2496 <b>NEW</b>	Defender	Rear casing	Electric window	Light Grey	RHS
DA2495 <b>NEW</b>	Defender - 1987 - 2006	Front casing	Electric window	Light Grey	LHS	DA2497 <b>NEW</b>	Defender	Rear casing	Electric window	Light Grey	LHS

### Replace your tatty old door cards.

DA2124	Defender/Series	Door trim safari - 2 hinges	Black	Rear
MWC1743	Defender	Door trim safari - 3 hinges	Black	Rear
DA2029	Series	Door trim lower	Black	RHS
DA2030	Series	Door trim lower	Black	LHS

Rear door cards for Defender 1987 - 2006 with wash wipe doors

MXC1992LCS	Defender - FA358393 up to JA910753	<b>NEW</b>	Slate Grey
BTR3793LCS	Defender - JA910754 up to KA929577	<b>NEW</b>	Slate Grey
BTR7959LCS	Defender - KA929578 up to MA965105	<b>NEW</b>	Slate Grey
BTR9712LCS	Defender - MA965106 up to TA99921	<b>NEW</b>	Slate Grey
BTR9712LOY	Defender - MA965106 up to TA99921	<b>NEW</b>	Dark Granite
BTR9712PMA	Defender - MA965106 up to TA99921	<b>NEW</b>	Black

For more images visit [www.britpart.com](http://www.britpart.com)

## Door Stays

Does your Defender's rear door sometimes close on you unexpectedly?

This neat and easily installed gas strut kit will solve that problem and replaces the original door stopper. The gas strut will hold the door in place when open - even with a spare wheel in place - and will assist in the opening of the rear door too with a smoother and more controlled movement. Complete with fittings and instructions.

DA1204	Defender - up to 2002
DA1203	Defender - 2002 onwards



DA1204

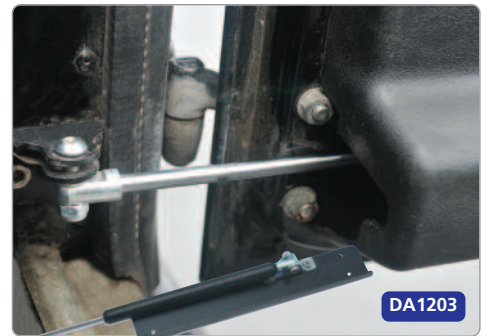

DA1203



## Retrofit Insert Seat Heaters

### DA5717

- Complete set for two seats.
- Extra comfort with 2 heating levels - stage I = pleasant permanent heat & stage II = heat-up.
- Installation kit for driver's seat and front passenger's seat with four heating elements.
- Pre-assembled cable set with switching relay and two illuminated switches for universal use.
- Integrated temperature guard.
- Heating elements made of extremely flexible coated wires.
- For seats with removable covers.
- Fitting materials & instructions.

Enjoy comfortable seat heating in a matter of seconds with these retrofit insert seat heaters. Highly flexible, coated heating elements for seat base and back are placed between the upholstery and seat cover without altering the shape of the seats. The heater is connected to the 12V on-board power supply using a ready-made cable set with switches for the drivers seat and passengers seat with the heat output able to be set at two stages. Integrated temperature sensors protect against overheating. The seat heater can be fitted in any vehicle with a removable cover.

Operating voltage:	12 volt
Output:	Stage I: 44 watts & Stage II: 90 watts
Dimensions:	Seat: 400 x 280mm & Backrest: 300 x 280mm
Test mark:	e-approved to 95/54/EC (EMC guidelines for vehicles)





## Section contents

<b>Air compressors &amp; tyre repair kit</b>	<b>74</b>
<b>Diff lockers</b>	
ARB	75
Ashcroft Transmissions	76
Detroit	76
Diff lock lever kit	76
LT230 cross pin	76
<b>Emergency equipment</b>	
Emergency hammer	77
Fire extinguishers	77
First aid kits	77
Travel kits	77
<b>Fuel tanks &amp; jerry cans</b>	
Fuel tanks - long range	77
Jerry cans	77
<b>Jacks</b>	
Anti-rattle jack clamps	79
Bottle jack	79
Hi-Lift	78
Jack base	79
Jackall	79
<b>Ladders - sand &amp; bridging</b>	<b>80</b>
<b>Land meters</b>	<b>80</b>
<b>Lift rod kit</b>	<b>80</b>
<b>Portable PowerPacks</b>	<b>81</b>
<b>Raised air intakes</b>	
Other	81
Safari	82

“Be prepared for the unexpected when exploring the exotic far flung corners of the globe - or even down your local greenlane. With long range fuel tanks through to raised air intakes, you’ll find products to suit your planned off-road adventures.”

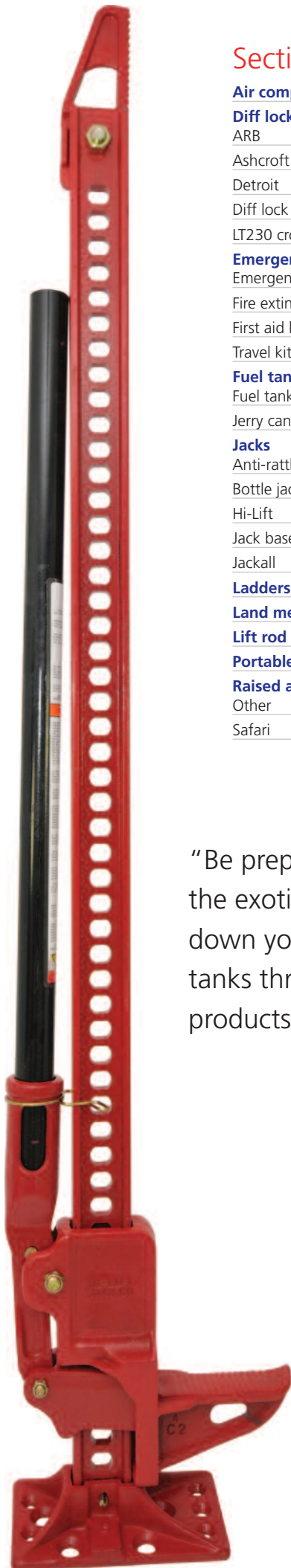

## Air Compressors & Tyre Repair Kit

**DOUBLE PUMP**

DA2392



**DA2392**

Double-pump air compressor

- Air flow - 150ltr/min
- 12 volt / 50 amp

**DA2354**

Single-pump air compressor

- Air flow - 72ltr/min
- 12 volt / 30 amp

Features for both air compressors

- Max. pressure - 150psi
- Automatic cut off to prevent overheating
- 10 metre air hose with heavy-duty gauge and brass fittings
- Integrated sand tray
- Blow moulded carrying case
- Also great for camping and outdoor use

**DA2394**

Replacement cap and filter for DA2392 & DA2354

Ideal for **4x4 use!**

**GREAT FEATURES...**



Heavy-duty gauge



**SINGLE PUMP**



DA2354



3 nozzles

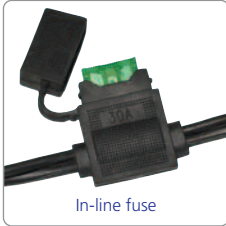

In-line fuse



Screw in air filter - DA2394



Built-in sand tray



Anti-vibration rubber feet



10m coiled hose

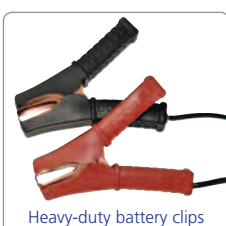

Heavy-duty battery clips



Blow moulded case

**Don't get caught out with a flat tyre or two!**

Pack and leave an easy to use Britpart tyre repair kit in your vehicle.\*



**DA2390**

Tyre repair kit in travel case

See the wheels section for more details on the tyre repair kit from Britpart.

\* Recommended for off-road use only



Photograph courtesy of Kristjan Kristjansson

**Diff Lockers**

ARB

**ARB Diff Lockers**

- Provides 100% traction on demand without affecting on road driveability or driveline wear.
- Vastly improved traction means less reliance on momentum, thus reducing the likelihood of vehicle damage and environmental impact.
- Easy, convenient operation allows the driver to concentrate on the terrain without leaving the comfort and safety of their seat.
- Ultra durable and extremely strong - only the highest quality materials used in construction.
- Incredibly simple yet effective design that employs minimal moving parts, thereby ensuring maximum reliability.
- Thoroughly tested and proven design - trusted and used in over 80 countries around the world.
- Easy installation and maintenance - no special tools, skills or additives required.
- Two year warranty guarantees the Air Locker will be free of defects in materials.

*Air Locker locking differentials allow you to tackle the toughest terrain. As the world's premier traction aid, ARB Air Lockers keep you moving in all conditions. Ultra durable and extremely strong - only the highest quality materials used in construction.*



Part Number	Vehicle/Model	Year	Axle Location	Shaft Description	Shaft Diameter	Spline	Ratio
DA4191 <sup>2,3</sup>	Series 1/Series 2/Series 3	1948 - 1985	Front	Rover type	28.2 (1.11")	10	4.7
DA4191 <sup>2,3</sup>	Series 1/Series 2/Series 3	1948 - 1985	Rear	Rover type	28.2 (1.11")	10	4.7
DA4191 <sup>1</sup>	Defender 90	1984 - 1993	Front	Rover type	28.2 (1.11")	10	3.54
DA4193 <sup>1,5</sup>	Defender 90	1993 onwards	Front	Rover type	31.5 (1.24")	24	3.54
DA4193 <sup>1,6</sup>	Defender 90	2007 onwards	Front	Rover type	31.5 (1.24")	24	3.54
DA4191 <sup>1,2</sup>	Defender 90	1983 - 1993	Rear	Rover type, 4 cyl. petrol & diesel engines	28.2 (1.11")	10	3.54
DA4193 <sup>1,6</sup>	Defender 90	1993 onwards	Rear	Rover type	31.5 (1.24")	24	3.54
DA4344 <sup>6</sup>	Defender 90	2002 onwards	Rear	Rover type, P38A	31.5 (1.24")	24	3.54
DA4193 <sup>1,6</sup>	Defender 90 with 2 pin rear diff	2007 onwards	Rear	Rover type	31.5 (1.24")	24	3.54
DA4344 <sup>6</sup>	Defender 90 with 4 pin rear diff	2007 onwards	Rear	Rover type, P38A	31.5 (1.24")	24	3.54
DA4191 <sup>1</sup>	Defender 110/130	1983 - 1993	Front	Rover type	28.2 (1.11")	10	3.54
DA4193 <sup>1,5</sup>	Defender 110/130	1993 onwards	Front	Rover type	31.5 (1.24")	24	3.54
DA4193 <sup>1,6</sup>	Defender 110/130	2007 onwards	Front	Rover type	31.5 (1.24")	24	3.54
DA4192	Defender 110/130	1983 - 2002	Rear	Salisbury type	31.5 (1.24")	24	3.54
DA4193 <sup>6</sup>	Defender 110/130	2002 onwards	Rear	Rover type	31.5 (1.24")	24	3.54
DA4344 <sup>6</sup>	Defender 110/130	2002 onwards	Rear	Rover type, P38A	31.5 (1.24")	24	3.54
DA4344 <sup>6</sup>	Defender 110/130	2007 onwards	Rear	Rover type, P38A	31.5 (1.24")	24	3.54
DA4191 <sup>1</sup>	Discovery 1	Up to 1993	Front	Rover type	28.2 (1.11")	10	3.54
DA4193 <sup>1,5</sup>	Discovery 1	1993 - 1998	Front	Rover type	31.5 (1.24")	24	3.54
DA4191 <sup>1</sup>	Discovery 1	Up to 1993	Rear	Rover type	28.2 (1.11")	10	3.54
DA4193 <sup>1,5</sup>	Discovery 1	1993 - 1998	Rear	Rover type	31.5 (1.24")	24	3.54
DA4193 <sup>1,5</sup>	Discovery 2	All	Front	Rover type	31.5 (1.24")	24	3.54
DA4193 <sup>6</sup>	Discovery 2	All	Rear	Rover type	31.5 (1.24")	24	3.54
DA4344 <sup>6</sup>	Discovery 2	2002 onwards	Rear	Rover type, P38A	31.5 (1.24")	24	3.54
DA6254	Discovery 3	All	Front	IRS, Clamshell type	31.5 (1.24")	29	All
DA6252	Discovery 3	All	Rear	IRS, Clamshell type	33.6 (1.32")	31	All
DA6254	Discovery 4	All	Front	IRS, Clamshell type	31.5 (1.24")	29	All
DA4191 <sup>1,4</sup>	Range Rover Classic	Up to 1992	Front	Rover type	28.2 (1.11")	10	3.54
DA4193 <sup>1,5</sup>	Range Rover Classic	1993 - 1996	Front	Rover type	31.5 (1.24")	24	3.54
DA4191 <sup>1,4</sup>	Range Rover Classic	Up to 1992	Rear	Rover type	28.2 (1.11")	10	3.54
DA4193 <sup>1,5</sup>	Range Rover Classic	1993 - 1996	Rear	Rover type	31.5 (1.24")	24	3.54
DA4344 <sup>5</sup>	Range Rover P38	1996 - 2002	Front	Rover type, P38A	31.5 (1.24")	24	3.54
DA4344 <sup>5</sup>	Range Rover P38	1996 - 2002	Rear	Rover type, P38A	31.5 (1.24")	24	3.54
DA6254	Range Rover Sport	2005 - 2013	Front	IRS, Clamshell type	31.5 (1.24")	29	All

**Notes** - **1** If vehicle was manufactured during 1993, check spline count. **2** Air Locker not available for vehicles equipped with high load option. **3** Ring gear spacer required. Longer ring gear bolts (not supplied) are also necessary - (Land Rover part no. 576521). **4** When an DA4191 Air Locker is to be installed in Range Rovers manufactured prior to 1980 (approx.), special carrier bearings (No. K11300/K11162) may also be necessary - Land Rover part no. RTC3426. **5** Some vehicles have crown wheel bolts which cannot be reused and must be replaced. Consult service manual. **6** P38A is most commonly found in traction control equipped vehicles. Identify P38A type diff by large 205mm [8.07"] flange diameter. P38A was not used on North American delivered Discoverys - use DA4193.

**ARB Compressor**

**DA4190**

- Compressor assembly 12 volt
- Designed for Air Locker use.
  - High flow, compact 12v compressor.
  - Sealed for moisture and dust resistance.
  - Hard anodised cylinder bore and Teflon impregnated carbon fibre piston seal for reduced friction and maximum trouble free life.
  - Heavy-duty maxi-fuse equipped for professional in-line circuit protection.
  - Quality components for quiet operation and extra long life.
  - Anodised mounting brackets dissipates motor heat and allows compressor to be repositioned by 180°.
  - Constructed entirely of lightweight, high strength engineering grade materials.
  - Over-pressure safety valve equipped.
  - Motor is internally thermal protected against extreme temperature damage.

**ARB Tyre Inflation Kit**

**DA6253**

- The ARB tyre inflation kit for air compressors is specially sourced from Japan, providing a unique high-heat tolerant hose for the hi-output compressor (DA4190). The practical kit includes a dust resistant air chuck and an enclosed internal bearing system to prevent dirt ingestion.
- Suitable for camping, touring and off-road applications as well as everyday usage.
  - Provides fast, accurate inflation.
  - Kit includes - 1 x high heat pressure hose, 1 x ARB air chuck with quick press fitting, 1 x ARB T-fitting for use with the ARB air compressor (DA4190) and an assortment of additional fittings to suit various camping and sporting gear such as air mattresses and footballs.



DA4190



DA6253



DA4194



DA4360



DA4361



DA4362

- DA4194** Dash switch for compressor and lockers  
**Dash switch covers**  
**DA4360** Front locker  
**DA4361** Rear locker  
**DA4362** Compressor

## Ashcroft Transmissions



### DA1224

Defender - 1993 onwards	Front & Rear
Discovery 1 - 1993 - 1998	Front & Rear
Discovery 2	Front & Rear
Range Rover Classic - 1993 - 1996	Front & Rear

### DA1224SN

Defender 110 - 2002 onwards (Wolf)	Rear
Range Rover P38	Front & Rear

### Features

- A unique non-rotating annular piston locking actuator is designed to eliminate air leaks sometimes found with rotating seals.
- The annular piston is also designed to eliminate the oil blow back in the air exhaust line.
- The large piston area give maximum hold-in force to reduce the possibility of jumping out of lock.
- Locking ring gives full 6mm positive engagement with side gear, again reducing the possibility of jumping out of lock.
- Gears have been redesigned for maximum strength and durability.
- The lock ring is made from high spec 300m steel to provide ultimate strength and ability to withstand shock loads.
- Locking actuator cage made from steel to withstand shock loading caused by power locking.
- Locker body turned from billet 817M40T (EN24T) to give optimum strength.
- Only change necessary to fit the locker is drill and tap the diff housing 1/4" bsp for the air feed fitting.
- No changes to the axle case.
- Requires on board air supply - not supplied. (DA4190 - ARB compressor assembly 12 volt)



## Detroit

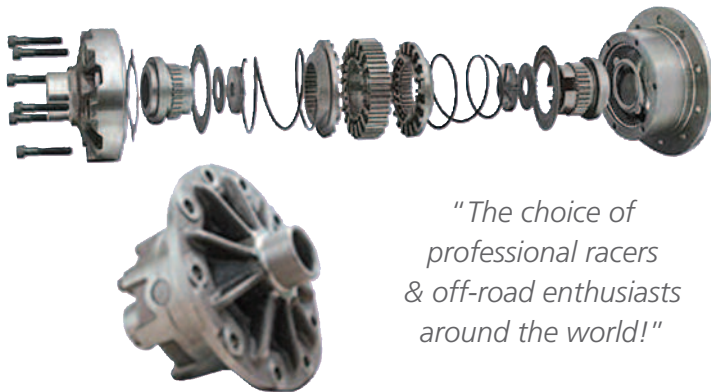

*"The choice of professional racers & off-road enthusiasts around the world!"*

### Detroit Locker

- 100% locking differential
- Legendary traction
- Ultimate performance

The legendary Detroit Locker began the revolution in performance differentials and still leads the industry today as an Eaton brand. The Detroit Locker is the most durable and dependable locking differential available.

The Detroit Locker maximises traction by delivering 100% of the torque to both drive wheels. It is engineered to keep both wheels in a constant drive mode, and has the ability to automatically allow wheel speed differentiation when required.

No other performance differential has the reputation for delivering traction in mud, snow, rocks and on the track. The choice of professional racers and off-road enthusiasts around the world!

The durability of the Detroit Locker is unmatched!

DA5700	Series 3/Defender/Discovery 1/Range Rover Classic	Detroit Locker	24 spline	Rear
DA5701	Series 3/Defender/Discovery 1/Range Rover Classic	Detroit Locker	10 spline	Rear
DA5704	Defender - Salisbury axle	Detroit Locker	24 spline	Rear

### Detroit Truetrac

- Smooth operation
- Performs open until needed
- Fully automatic limited slip

*"Recognised for its toughness as well as its smooth & quiet operation."*

The Detroit Truetrac was the first helical gear differential ever introduced into the automotive aftermarket as an Eaton brand. It remains the leading helical gear-type limited slip differential in the industry. Detroit Truetrac's proven helical gear design eliminates the need for wearable parts, resulting in maintenance free traction.

Recognised not only for its toughness but also its smooth and quiet operation. Engineered to work efficiently in front and rear axles, semi-floating (C-clip axles) and transfer cases. Power transfer is so smooth, it literally goes unnoticed by the driver - even in front wheel drive axles.

Proven design, low cost and effective performance, all make the Detroit Truetrac limited slip differential the ideal choice for a wide variety of vehicle applications.

No maintenance - just traction!



DA5705	Series 3/Defender/Discovery 1/Range Rover Classic	Detroit Truetrac	10 spline	Rear
DA5706	Series 3/Defender/Discovery 1/Discovery 2/Range Rover Classic	Detroit Truetrac	10 spline	Front
DA5709	Series 3/Defender/Discovery 1/Discovery 2/Range Rover Classic	Detroit Truetrac	24 spline	Rear
DA5710	Series 3/Defender/Discovery 1/Discovery 2/Range Rover Classic	Detroit Truetrac	24 spline	Front
DA5711	Defender - Salisbury axle	Detroit Truetrac	24 spline	Rear

### IMPORTANT

When fitting a metric diff centre with metric bearings into an imperial casing you will require the additional following parts. Diffs went from imperial to metric in approximately 1983, take a look at one of the heads of the four large journal end cap bolts, if '8.8' is on the head it is metric, if not then it is imperial. Parts are required for fitting to both Truetrac or Detroit lockers.

DA5712	Spacer ring
DA5713	Imperial bearing sleeves
RTC3095	Bearings

**Note** - 2 x bearings are required

Fitting a Detroit Truetrac to the rear of a late Defender 110 will require the spacer ring DA5712. Ten longer bolts are needed too 576521 is a pack of 10.

## Diff Lock Lever Kit

DA1178  
Diff lock lever kit  
Discovery 2

Early Discovery 2's were not supplied with a centre diff lock function for the LT230 transfer case although the vehicles still have the centre diff lock installed in the transfer case. To get the diff lock function to work it just needs connecting. The linkage is easy to fit, cable operated and very neat. You attach the existing high/low stud to this new lever assembly. This kit will only work on transfer cases with serial numbers starting with either 41D or 42D.



## LT230 Cross Pin



### DA1225

Ashcroft Transmissions cross pin  
The standard LT230 transfer boxes have a two piece cross pin in the centre diff, this is two shafts with a cut out in the centre so they can overlap. This one piece heavy-duty cross pin is much stronger.



**Emergency Equipment**

**Fire Extinguishers**

**STC8138AB**

- 2kg kit
- Long-life - 100% polyester resin coated fire extinguisher
- Safe handling & crash proof fastening
- Readiness to operate displayed by manometer
- Precision brass valve

**STC8529AA**

- 1kg kit
- One-handed operation fire extinguisher
- High rating
- Checkable & re-chargeable
- With crash-tested bracket
- Attractive design
- Controlled discharge



STC8529AA

STC8138AB

**Emergency Hammer**

Life Hammer - The Original



DA6500

- Double-sided steel hammer for shattering windows quickly and easily for a safe and quick exit from any vehicle.
- Razor sharp blade cuts through seatbelts to ease escape.
- Fluorescent button allows hammer to be located in the dark.
- Installation mounting bracket ensures hammer is accessible when you most need it.

**Fuel Tanks & Jerry Cans**  
Fuel Tanks - Long Range

**Defender 90**

**DA4547**

Defender 90 - Td5 & Tdci - up to 8A

**DA4548**

Defender 90 - Tdci - from 8A

- 30 litres\* plastic flow tank
- Lightweight
- Supplied as kit
- Easy to install & use
- Requires no pumps or added fillers
- Does not interfere with storage or clearance
- Compatible with standard Defender fuel filler cap

\*approximately

DA4545



DA4546



**Defender 110**

**DA4545**

Defender 110 - up to 1999 (pre-Td5 models)

- Rear arch metal spare fuel tank - right hand side
- 45 litres
- Supplied with all the necessary fittings to install and use

**DA4546**

Defender 110 - 1999 onwards (Td5 & Puma models)

- Rear arch metal spare fuel tank - right hand side
- 45 litres
- Supplied with all the necessary fittings as well as a replacement filler neck and specifically engineered bulkhead fitting for the balance pipe, having these makes the fitting of the tank quicker and easier as well as it working better too.

**Note** - Both above tanks are not suitable for use in a Defender 130.  
Additional bracket required for 7 seater.



DA4547 / DA4548

*The best way of getting more fuel into your Defender without using valuable space or complex pumping systems!*



DA2170



DA2171



DA2166



DA2182

Jerry can not included

**Jerry Cans**



DA2172

*"Don't get caught short!"*

**DA2166**

Jerry can - 20ltr

**DA2170**

Jerry can - 20ltr stainless steel

**DA2171**

Jerry can - 10ltr stainless steel

**DA2172**

Jerry can stainless steel spout

**DA2182**

Jerry can holder for 20ltr cans

**First Aid Kits**



**DA5031**

**Compact First Aid Kit**

Lightweight, compact carry case. Great for people on the move and ideal for treating minor injuries. Contents are CE certified.



**DA5032**

**Standard First Aid Kit**

Comprehensive range of essential items in a handy case. Contents are CE certified and are in conjunction with DIN13164.

For first aid & travel kit contents details [www.britpart.com/safety](http://www.britpart.com/safety)



**STC7642**

To DIN 13164, the industry standard first aid kit solution.

**Travel Kits**



**DA5033**

**Essential Emergency Travel Kit**

Essential items for emergencies on the roadside. Compact carry case. Ideal size to store in front of the vehicle for easy access.



**DA5028**

**European Travel Kit**

Includes essential items when travelling to Europe. All products are manufactured to UK required standards where applicable.



**DA5029**

**Glovebox Travel Kit**

Ideal size to fit into your glove compartment, contains essential everyday items for in & around the vehicle.

## Jacks

### Hi-Lift

**RUGGED,  
HIGHLY  
VERSATILE  
JACKS**



DA2243 48" Jack (4ft)  
DA3120 60" Jack (5ft)

The Hi-Lift jack is a rugged, highly versatile jack that puts you in command of situations requiring lifting, pushing, pulling, winching, and clamping. Although light in weight and easy to manoeuvre, the Hi-Lift jack offers a rated lifting capacity of 2<sup>1/3</sup> tons (2,114kgs).



#### Specifications

- Approximate weight: 30lbs (14 kg).
- 4,660lbs (2,113kgs) rated capacity.
- Climbing pins of specially processed steel with 125,000psi tensile strength and 100,000psi yield.
- Steel bar is manufactured of specially rolled extra high carbon steel with 80,000lbs minimum tensile and carbon 0.69 to 0.82.
- Steel handle of 14-gauge high-yield structural tubing with minimum yield of 55,000psi - 1<sup>5/16</sup>" diameter x 30" long.

#### Features

- Every jack comes complete with an adjustable top clam clevis for use in clamping and winching.
- For speedy disengaging, lifting unity automatically drops away when load is removed.
- 4<sup>1/2</sup>" (11cm) long lifting nose for positive contact with load.
- Safety bolt is designed to shear at 7,000lbs (3,175 kg).
- Steel bar can be reversed for extra long life.
- Low pickup of 4<sup>1/2</sup>" (11cm).
- 28" square base plate.

#### DA2243EYE



#### DA2174



#### DA2248



#### DA4350



#### DA4351



#### DA4354



#### DA4353



#### DA4355



DA4356



DA4357 / DA4358

#### DA4352



#### Accessories

DA2174	Off-road base plate	Alleviates jack sinkage on soft surfaces - suits both models
DA2243EYE	Jacking eye	Spare jacking eye
DA2244	Jacking point adaptor	Allows the use of the jack with the standard jacking points on a Defender
DA2248	Fix-it-kit	The maintenance kit contains all the key components for servicing all Hi-Lift jacks
DA4350	4XRAC	Heavy-duty mounting system for the serious off-roader
DA4351	Loc-Rac	Conveniently mounts and locks your Hi-Lift jack. Includes lock and suits all models
DA4352	Jack protector	The jack protector vinyl bag protects your jack from the elements - one size fits all
DA4353	Lift mate	Designed to provide a lift point from most wheels for quick and easy lifting. Lifting capacity is 5,000lbs/2,273kgs
DA4354	Off-road kit	The Hi-Lift winching kit includes a winch attachment, winch tensioner, tree strap, d-ring shackle, Hi-Lift gloves and gear bag. Winch time is reduced significantly using the winch attachment and tensioner together.
DA4355	Bumper lift	Designed to fit curved steel bumpers. Rugged design of the bumper lift has a lifting capacity of 3,000lbs/1,361kgs
DA4356	Neoprene jack cover	This jack cover offers a level of mud and dirt protection for the main lifting mechanism of the jack when not in use. It zips on easily over the foot of the jack and provides a tight fit.

#### Adjustable tube jack mounts

Designed for mounting a Hi-Lift jack to round and square tube bumpers, bull bars, roll cages and roof racks, this accessory allows for easy and adjustable mounting on tubes from 1" to 3" in diameter

DA4357	Small set	Is for use on tubes from 1 to 2" in diameter, which works on many roof racks. It can also be used on ATV/UTV bars, bumpers and roll cages
DA4358	Large set	Is intended for tubes from 2 to 3" in diameter that will work on most vehicle bull bars and roll cages

**RUGGED &  
POW'R-FUL JACKS!**



Jackall

Built with a patented 'Safety Link', the Maasdam Jackall is the 'Jack with More'! Larger base for greater stability. 'Safety Link' mechanism that prevents abuse, misuse and makes operations safer. Jacks come with a lifetime warranty and are built to current ANSI/ASME specifications. When safety and dependability matter most, continue to rely on Jackall.

**Features & Benefits**

- Patented "safety link" mechanism which prevents abuse and misuse.
- Heavy ribbed, extra large base which provides strength and greater load stability.
- Cast components assures long life, trouble free operation.
- Hot roll-formed, alloy steel beam which is strong and reliable.
- Steel handle locks against beam for convenient storage.
- Powder coated through and through which reduces scratching, greater corrosive resistance.

- DA3121** 48" Jack (4ft) - 8,000lbs capacity
- DA3122** 60" Jack (5ft) - 8,000lbs capacity
- DA3130** Top clamp
- DA4058** Maintenance kit
- DA4059** Jacking point adaptor
- DA4061** Mounting kit jack rack



DA3130



DA4061

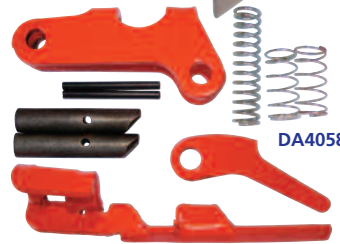
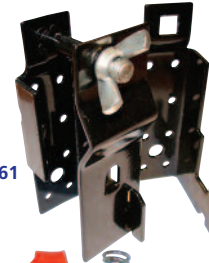

DA4058

**Anti-rattle Jack Clamps**



**Anti-rattle jack clamps**

- DA3153** Red
- DA3154** Black
- DA3155** Yellow

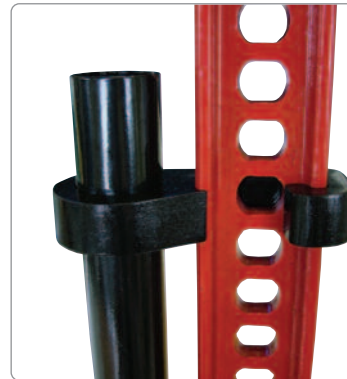

DA3122

DA3121



*"Be prepared for all eventualities...."*

Photograph courtesy of Rudi Thoelen

**Bottle Jack**

**Jack Base**



- ANR4489** Bottle jack kit (KAJ100571 & KAH000050)
- KAJ100571** Bottle jack
- KAH000050** Handle for bottle jack (KAJ100571)
- Note** - Defender only

- ANR4489** (kit)
- KAJ100571 & KAH000050** (individual)

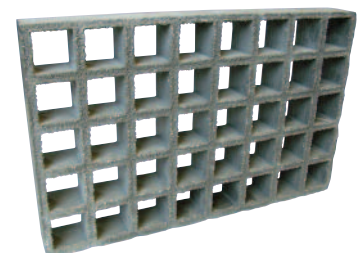

- DA5607** Jack base 310 x 195 x 38mm Grey



## Ladders - Sand & Bridging



DA2231



DA5600

<b>DA2231</b>	Sandtrack	Aluminium	Pair
1,500 long x 390 wide x 4mm thick			
<b>DA5600</b>	Bridging ladders	Fibreglass	Pair
1,220 long x 260 wide x 50mm deep			
<b>DA5601</b>	Bridging ladders	Fibreglass	Pair
1,220 long x 270 wide x 38mm deep			
<b>DA4587</b>	Recovery tracks	Plastic	Pair
1,210 long x 325 wide x 60mm deep			
Max load - 3.5 tons			

DA5601



## Lift Rod Kit



DA4587

**GREAT FOR  
ADDED TRACTION**



**Fully adjustable suspension lift rod kit.**

*"The ease of changing the ride height is what separates these rods from others in the marketplace."*

DA7531

Discovery 3/Discovery 4/Range Rover Sport - 2005 - 2013  
These adjustable rods replace the plastic and rubber parts Land Rover supply on the vehicle. Made from aluminium with an industrial heavy grade rubber bushing, the aluminium parts are anodised black to help with corrosion protection and blending in when in the garage for work.

The lift rods have two settings; standard and off-road. With the vehicle set to normal driving height the shortened rods will give you off-road height. If you select off-road height the vehicle will be in the 'super extended' position as standard if you use the 'shortened' settings. The ease of changing the ride height is what separates these rods from others in the marketplace.

No tools are required and should take no more than 2 minutes to do all four rods. Access to the front is over the front wheels and for the back is through the rear wishbones (blanket required!)

**Note** - If run for a long time in off-road position then wheels may need realigning.

## Land Meters



DA1003



DA1004

- Independent twin meter.
- Convenient for seeing the pitching and rolling of the vehicle body or terrain.
- Transparent illumination for easy-to-see readings at night.

<b>DA1003</b>	Double incline land meter	Black
<b>DA1004</b>	Double incline land meter	Carbon fibre effect



Photograph courtesy of Jundio Salvador



**PowerPacks NEW**

# XS PowerPack

**MULTI-FUNCTION JUMP STARTER**



Pack contents...



**& charger for electronic products...**



**DA1239 NEW**

**Technical Specifications**

Size: 230 x 87 x 27mm  
 Weight: 615g  
 Output: 5V = 2A (smart phone/tablet fast charge)  
 12V = 10A  
 19V = 3.5A (lap tops/notebooks)  
 Input: 14V = 1A  
 Peak current: 600A

**Battery volume: 18,000mAh**  
**Starting current: 300A**

- Small and lightweight high capacity nano lithium polymer portable power pack with the latest battery technology.
- Supports fast charging with low self-discharge cycle.
- Charging cycles can reach more than 1,000 times.
- Supports 12V jump starts as well as back up charging or many brands of mobile phones, laptops, tablets, portable refrigerators etc.
- Support 3 different types of charging modes.
- Built in redundant electronic control safety protection for jump starter over-charging and over-discharging.



# XD PowerPack

**MULTI-FUNCTION JUMP STARTER**



Pack contents...



**& charger for electronic products...**



**DA1238 NEW**

**Technical Specifications**

Size: 131 x 75 x 25mm  
 Weight: 300g  
 Output: 5V = 2A (smart phone/tablet fast charge)  
 Input: 14V = 1A  
 Peak current: 400A

**Battery volume: 9,000mAh**  
**Starting current: 200A**

- Small and lightweight portable power pack with the latest nano lithium battery technology.
- High capacity, high power special battery.
- Supports fast charging with low self-discharge cycle.
- Charging cycles can reach more than 1,000 times.
- Supports 12V jump starts as well as back up charging for many brands of mobile phones, tablets etc.



## Raised Air Intakes

Raised Air Intakes - Other

If your likely to be driving your Land Rover in circumstances which could mean wading deep water or driving in very dusty conditions then you should consider fitting a raised air intake to your vehicle.

This version from Britpart is a classic mushroom-top snorkel for Defender. Featuring heavy-duty metal pipe work, cyclone pre-cleaner and a durable attractive matt black finish.

<b>DA2225</b>	Defender - 300Tdi/Td5
<b>PHD500340</b>	Defender - 2007 onwards
<b>NRC6920</b>	Raised air intake cleaner for DA2225 & LR008383
	Inside diameter - 64mm
<b>VPLAP0018</b>	Discovery 3/Discovery 4

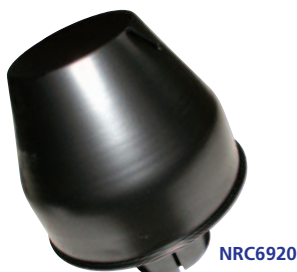

## Raised Air Intakes - Safari



Pioneered in Australia in the early 1980's, Safari Snorkels were born out of a need to protect 4WD engines from the hazards of dust and water commonly encountered in touring and off road applications.

Safari snorkels are manufactured to the highest standards in durable, UV stable, cross linked polyethylene material, using stainless steel hardware where appropriate. Each system includes quality fixtures and fittings, which offer superior sealing, presentation and long-term durability.

In arguably the best, if not toughest environment, Safari Snorkel Systems are thoroughly researched, tested and tooled for each model of Land Rover. The Safari Snorkel delivers a continuous and cooler supply of air for maximum engine performance. It is positively sealed as well to ensure the best protection against deep water crossings and dust.



DA3024



DA3069

Defender	Snorkel fitment side	Discovery	Snorkel fitment side
<b>DA3024</b> Defender - 200Tdi - 1990 - 1994	LHS	<b>DA3015</b> Discovery 1 - 200Tdi - 1990 - 1994	LHS
<b>DA3025</b> Defender - V8 - 1984 - 1994	RHS	<b>DA3018</b> Discovery 1 - V8 - 1990 - 1994	LHS
<b>DA3026</b> Defender - 300Tdi - 1994 - 1999	RHS	<b>DA3020</b> Discovery 1 - 300Tdi (non-EGR) Discovery 1 - V8 - 1994 - 1999 (non-ABS)	LHS
<b>DA3069</b> Defender - Td5 - 1999 onwards Defender - 2007 onwards	RHS	<b>DA3022</b> Discovery 1 - 300Tdi (non-EGR) Discovery 1 - V8 - 1994 - 1999 (ABS)	LHS
<b>DA2374</b> Stainless steel air ram grille (shown attached to air ram - grille only) <b>Note</b> - Will not fit DA3069 snorkel		<b>DA3023</b> Discovery 2 - Td5 Discovery 2 - V8 - 1999 onwards	LHS
<b>DA3141</b> 3" replacement air ram for DA3024		<b>DA3021</b> Discovery 3 - TdV6 SE/Discovery 4 - TdV6	RHS
<b>DA3142</b> 3 1/2" replacement air ram for DA3025, DA3026, DA3027, DA3027LH, DA3069 <b>Note</b> - Fitment from seated internal view - RHS - right hand side and LHS - left hand side.		<b>DA2374</b> Stainless steel air ram grille (shown attached to air ram - grille only) <b>DA3141</b> 3" replacement air ram for DA3015, DA3018, DA3020, DA3022, DA3023 <b>DA3142</b> 3 1/2" replacement air ram for DA3021 <b>Note</b> - Fitment from seated internal view - RHS - right hand side and LHS - left hand side.	



DA3021



DA2374



DA3141 / DA3142

For more Safari Snorkel pictures visit - [www.britpart.com/safari](http://www.britpart.com/safari)

Safari snorkels are manufactured to the highest standards in durable, UV stable, cross linked polyethylene material.

## Section contents

**Batteries**

Alternator upgrade kits	85
Battery charger	85
Microprocessor controlled dual battery management system	86
Optima batteries	84
Replacement batteries	84

**Britpart Pulling Power Winches**

DB12000i winches	88
DB9500i winches	88
DB9000C winches	89
DB8000 winch	89
DB6000 winch	89
DB2000 winch	90
Winch spare parts	90

**Winch bumpers**

Winch bumper kits	91
Winch bumpers	92

**Winching accessories & kits**

Winching accessories	92 - 94
Winching accessory kits	94

“Never get stuck again with a Britpart Pulling Power electric winch and winching accessories - we've all you need to get out of that sticky situation.”



## Batteries

### Optima Batteries



With its patented Spiralcell® Technology, Optima batteries offer **15 times the vibration resistance** and **up to twice the life** of ordinary batteries. The Optima is like no other battery found in today's market. Optima's unique patented Spiralcell® design offers the best technology by providing a strong and clean power source that far surpasses any of today's traditional lead acid batteries. With Optima as your choice, you can count on a longer lasting battery.



#### Yellow Top

Demand more from your vehicle? Then get more from your battery. Optima Yellow Top batteries are made for the extremes. If your vehicle is designed to take the abuse of off-road driving, you need increased performance and reliability from your battery.

Optima batteries combine patented Spiralcell® Technology to deliver that performance. The deep cycle characteristics of this technology coupled with its extreme resistance to vibration provides performance vehicles with the repetitive power they need, packaged in a spill-proof compact design.

If your vehicle is fitted with high drain accessories such as additional lighting, tracking devices, ICE systems, winches, hydraulics etc, then this ultimately demands more from your battery. Optima Yellow Top batteries provide the extra performance and deep cycling capability that your vehicle demands.

#### Red Top Batteries

Voltage - 12v  
Capacity - 50Ah  
Cold Cranking Amps (CCA) - 815  
**DB1019** Top terminals  
**DB1021** Top & side terminals

#### Yellow Top Batteries

Voltage - 12v  
Capacity - 55Ah  
Cold Cranking Amps (CCA) - 765  
**DB1018** Top terminals  
**DB1020** Top & side terminals

#### Red Top

Optima Red Top batteries are built to withstand the abuse 4x4's experience on and off-road. Spiralcell® Technology immobilises the internal components of the battery, enabling Optima batteries to withstand incredible amounts of vibration.

Vehicles modified for improved engine performance demand more from a battery. Optima batteries withstand the high engine bay temperatures associated with these performance vehicles. The sealed construction makes the battery spill-proof, even if you install it on its side! This prevents external gassing and leaking which can damage engine components and reduce battery performance.

If your battery is used in applications that demand extra reliability endurance and performance, or if you just take pride in getting the best performance out of your vehicle, Optima Red Top batteries deliver the performance you demand.

## Replacement Batteries

- Batteries are manufactured on the same equipment as OE batteries and use the same components to give consistent quality and performance.
- Original equipment (OE) quality standards, giving assurance that the batteries will not let the user down.
- Batteries are recyclable, helping to protect the environment.



LR038128

	Capacity	CCA*
<b>STC4757</b>	70Ah	500
<b>YGD500100</b>	70Ah	640
<b>LR038128</b>	80Ah	770
<b>LR032525</b>	95Ah	855
<b>LR033179</b>	95Ah	855
<b>LR030213</b>	95Ah	855
<b>LR038341</b>	95Ah	855
<b>YGD500130</b>	95Ah	855
<b>YGD100860</b>	100Ah	1000mCA
<b>STC8587</b>	110Ah	750
<b>YGD000271</b>	110Ah	920

\*Cold Cranking Amps



You can now find all the latest Britpart news on Facebook!

[facebook.com/britpart](https://www.facebook.com/britpart)



**DA3185**

**Universal battery charger**

MULTI XS 7000 is a charger that provides complete battery care for those needing to charge normal size and slightly larger batteries, for example, in caravans, boats and cars.

It is fully-automatic with unique 8-step charging that supplies 7A and which is suitable for 12V batteries between 14-150Ah and is suitable for maintenance charging up to 225Ah.

The MULTI XS 7000 analyses whether the battery can accept and retain the charge, it removes harmful lead sulphate crystals, charges quickly and efficiently and automatically switches to maintenance charging when the battery is fully charged.

It also has a practical Recond mode that balances the acid concentration in deep discharged batteries. It features a special cold mode to give optimal charging on cold winter days and to demanding AGM batteries (type Optima).



Supply mode allows the charger to be used as a power supply if you need to disconnect batteries from the vehicle. It is fully protected from producing voltages that can damage the vehicle's electronics. It is also non-sparking and features reverse polarity and short circuit protection.

Input voltage	220 - 240VAC, 50 - 60Hz
Output voltage	14.4V, 14.7V, 13.6V/Supply, 15.8V/Recond
Charging current	7A
Ripple	Max 150mV rms, 0.3A
Ambient temperature	-20°C to +50°C, output power is reduced automatically at higher temperatures
Charger type	Eight step, fully automatic switch mode with pulse maintenance
Batteries	12V lead-acid batteries (Wet, MF, AGM, Calcium/Calcium and GEL)
Battery size	14 - 150Ah (14 - 225Ah maintenance charging)
Dimensions	191mm long x 89mm wide x 48mm high
Insulation	IP 65
Weight	0.8kg



**Alternator Upgrade Kits**

**DA1195**

**DA1196**

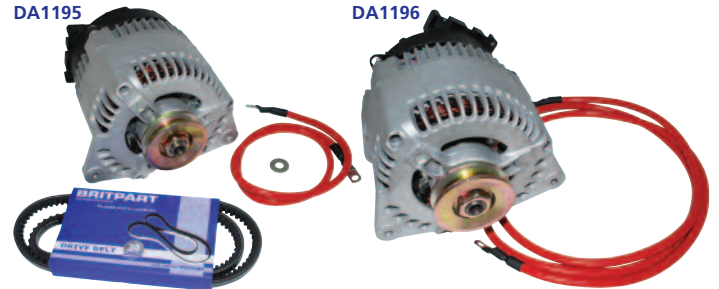

200Tdi alternator upgrade kits. Kits include uprated cable.

<b>DA1195</b>	Defender - 200Tdi	Upgrade the 45A alternator to 120A
<b>DA1196</b>	Discovery 1 - 200Tdi	Upgrade the alternator to 120A

## Microprocessor Controlled Dual Battery Management System



### DA1174

#### Microprocessor Controlled Dual Battery Management System

This fully automatic Microprocessor Controlled Dual Battery Management System separates the starter battery from auxiliary battery if the vehicle has stopped and links them while the car is running. All systems are equipped with a 200A power relay. For emergency situation all systems are equipped with the manual override function (link). This manual linking function (called load sharing) is very helpful for jump starting or when using high current appliances such as an electrical recovery winch, power inverter or compressor. The kit includes a 4.7m wiring loom with sealed automotive plug, battery and crimp terminals for easy installation.

The battery monitor is installed in the vehicle (dash) and informs the driver about the charge level of both batteries, the charging voltage from the alternator or an additionally installed solar system and the relay link status. The system offers low battery alarm on both batteries and a link failure alarm. Includes a manual link for 30 and 120 minutes with automatic return.

#### Functions

##### Display of Battery Voltage (Energy Level)

###### LED indicators:

Green: Batteries are in the safe working range

Yellow: Check batteries

Red: Batteries should be charged

The LED's show the energy level if all loads are switched off:

12.6V = 100%

12.4V = 75%

12.2V = 50%

12.0V = 25%

11.0V = flashing and beeping indicates low battery situation

This function is called by pressing the display button for about 30 seconds.

##### Display of Charge Voltage while charging

###### LED indicators:

Red: >14.5V: High loading of batteries, may be present at cold ambient temp. for a longer time.

Yellow: >14.0V: Proper charge mode.

Green: <14.0V: Save charge mode, no damage to batteries.

##### Bi-directional Automatic Battery link

While the engine is running the main and auxiliary batteries are linked together for parallel charging from the alternator (green LED linked is on). If the engine is stopped, the two batteries will be disconnected automatically with some delay. Appliances as fridges, lights, compressors, inverters are now safely fed from the auxiliary battery. With the additional charge by solar equipment, battery charger or generator is sufficient for charging, the starter battery will be charged automatically with auxiliary battery together (green LED "link" lights).

##### Manual Battery "link"

In an emergency situation (defective or empty main battery) or in case of higher power consumption the two batteries (main & auxiliary) may be connected together by activating the link button (red LED manually linked is on) After a laps of time of 30 minutes (or immediately after activating the auto button), the system returns to the automatic mode. When using an electric winch, the battery connection can be activated for 120 minutes by pressing twice the link button. In this mode sounds every 30 seconds a beep to remind this status (auto return after time expired). The load sharing function with the manual battery connection reduces the load on the alternator, the wiring and the batteries in the use of the winch.

##### Alarm functions:

###### Low battery alarm

If the battery voltage of one or both of the batteries, is for a longer period below 12V, the sound low battery with "Beep" and the LED "Low Battery" of the corresponding battery (main and / or auxiliary) flashes. With the display button, the "Beep" is switched off. The blinking LED "Low Battery" is reset if the battery voltage is exceeding 12V.

###### Link failure alarm

The monitor monitors the charge on both batteries. When fitting charge (from alternator, solar, charger) no charge to the other battery is detected, the link error alarm with flashing green LED "linked" and the "Beep" sounds. If this error occurs, check immediately the wiring of the power cables to (relay, battery terminals, crimp contacts, control relays). After bug fixes, alarm will automatically reset.

###### Deactivation of automatic and manual battery dual link function

Is there a problem with the auxiliary battery (aux) as short circuit of cells, short circuit or defective battery housing, leading to damage of the generator (alternator). In an emergency situation the battery system can be operated in the vehicle in the basic configuration (alternator, starter battery without additional charge to auxiliary battery). By pressing the link button for 6 seconds (until the sound of the beep), the link is deactivated. In this mode, no manual and automatic battery connection is possible. This feature can after solving the battery problem of the auxiliary battery by pressing the auto button for 6 seconds to be reset. Now the system is working again with all the functions.



#### Winch application

Connect an electrical recovery winch to the main battery as shown in the wiring diagram.

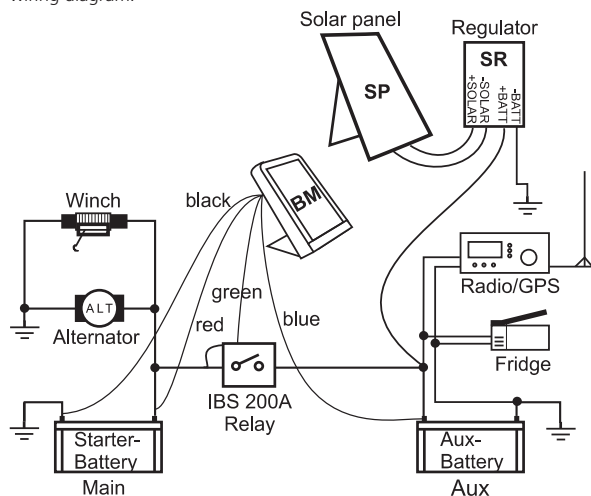

#### Specifications

Supply voltage	4 - 16V
System voltage	12V
Measuring range (sense wire blue)	8 - 16V
Display range (battery voltage)	11.0V - 12.8V
Alarm level main and aux	12.0V
Display range (charge)	13.0V - 14.5V
Accuracy	+/-1%
Consumption monitor	1mA
Consumption max. display active (30 sec)	20mA
Isolator link-on/off threshold	13.1V/13.0V
Consumption on-state (relay)	0.6A
Relay continuous load current	200A
Relay current inrush	500A
Relay contact material	Silver (AG SnO2)
Free combination of batteries possible?	Yes
Operating temperature	-40°C - +80°C
Housing	ABS black
Sealing level	IP40
Size, dimensions	100 x 65 x 24mm
Weight	800g
Cabling	Red - Supply/sense (main battery) Black - GND (main battery) Blue - Sense (aux battery) Green - Control relay (open collector)
Protected against	Against wrong polarity Against overload of solenoid driving circuit on PC Board with SMD electronically security devices, no fuses have to be replaced.

#### Mounting Options



DA1174GM

Mounting plate with flexible arm

DA1174SM

Mounting plate with swivel mount

DA1174HM

Mounting plate with swivel arm



**BRITPART**  
**PULLING POWER**

If you are serious about off-roading then a winch is an essential piece of kit. They are indispensable when getting yourself and others out of tricky situations. The Britpart Pulling Power range of powerful and reliable electric winches all feature a planetary gear system for fast line speed, free spooling, power in & power out and low electric current. Now with the larger winches you have a choice of having the traditional steel cable fitted or dyneema rope.

A full range of winching equipment is also available from Britpart - including; safety gear, bumpers, chocks, hooks, shackles & ropes. Together with the winches you'll be able to 'Get to where you want to go!'

**Features**

	<b>DB12000i</b>	<b>DB9500i</b>	<b>DB9000C</b>	<b>DB8000</b>	<b>DB6000</b>	<b>DB2000</b>
Motors	3.6Kw (4.8Hp) heavy-duty series wound DC motor	3.6Kw (4.8Hp) heavy-duty series wound DC motor	3.3Kw (4.5Hp) permanent magnetic DC motor	3.0Kw (4.1Hp) permanent magnetic DC motor	2.7Kw (3.6Hp) permanent magnetic DC motor	1.0Kw (1.5Hp) permanent magnetic DC motor
Models available	12 volts & 24 volts	12 volts & 24 volts	12 volts	12 volts	12 volts	12 volts
Steel cable or dyneema rope	Steel cable & dyneema rope	Steel cable & dyneema rope	Steel cable & dyneema rope	Steel cable	Steel cable	Steel cable
Weather* and dustproof contactor controls for longer life and improved amperage draw	✓	✓	✓	✓	✓	
Planetary gear system for fast line speed	✓	✓	✓	✓	✓	✓
Automatic load-holding brake	✓	✓	✓	✓	✓	
Free spooling	✓	✓	✓	✓	✓	✓
Power in and power out	✓	✓	✓	✓	✓	✓
Low electric current	✓	✓	✓	✓	✓	✓
Hardened drum	✓	✓	✓	✓		
Tension plate to prevent rope entanglement						✓

**Specifications**

	<b>DB12000i</b>	<b>DB9500i</b>	<b>DB9000C</b>	<b>DB8000</b>	<b>DB6000</b>	<b>DB2000</b>
Rated line pull - single line	<b>5,443kgs</b> 12,000lbs	<b>4,309kgs</b> 9,500lbs	<b>4,082kgs</b> 9,000lbs	<b>3,632kgs</b> 8,000lbs	<b>2,722kgs</b> 6,000lbs	<b>907kgs</b> 2,000lbs
Gear reduction ratio	294:1	212:1	212:1	210:1	210:1	153:1
Motor size	<b>3.6Kw</b> 4.8Hp	<b>3.6Kw</b> 4.8Hp	<b>3.3Kw</b> 4.5Hp	<b>3.0Kw</b> 4.1Hp	<b>2.7Kw</b> 3.6Hp	<b>1.0Kw</b> 1.5Hp
Drum size - D x L	<b>67 x 228mm</b> 2.64 x 9"	<b>67 x 228mm</b> 2.64 x 9"	<b>63 x 228mm</b> 2.5 x 9"	<b>63 x 228mm</b> 2.5 x 9"	<b>63 x 140mm</b> 2.5 x 5.51"	<b>32 x 71mm</b> 1.26 x 2.8"
Steel cable - size	<b>9.53mm x 30.5m</b> 0.38" x 100'	<b>9.53mm x 30.5m</b> 0.38" x 100'	<b>9.53mm x 30.5m</b> 0.38" x 100'	<b>9.53mm x 30.5m</b> 0.38" x 100'	<b>7.94mm x 26m</b> 0.31" x 85'	<b>4mm x 15.2m</b> 0.16" x 50'
Dyneema rope - size	<b>11mm x 28m</b> 0.43" x 91.9'	<b>11mm x 28m</b> 0.43" x 91.9'	<b>11mm x 28m</b> 0.43" x 91.9'	N/A	N/A	N/A
Overall dimensions - L x W x H	<b>548 x 167 x 299mm</b> 21.57 x 6.57 x 11.77"	<b>548 x 167 x 299mm</b> 21.57 x 6.57 x 11.77"	<b>560 x 160 x 280mm</b> 22.0 x 6.3 x 11.0"	<b>570 x 180 x 280mm</b> 22.4 x 7.0 x 11.0"	<b>438 x 158 x 185mm</b> 17.24 x 6.22 x 7.28"	<b>320 x 105 x 110.5mm</b> 12.6 x 4.13 x 4.35"
Steel cable - net weight	<b>43.0Kgs</b> 94.8lbs	<b>43.0Kgs</b> 94.8lbs	<b>38.0Kgs</b> 84.0lbs	<b>36.0Kgs</b> 80.0lbs	<b>31.8Kgs</b> 70.0lbs	<b>6.6Kgs</b> 14.6lbs
Dyneema rope - net weight	<b>33.0Kgs</b> 72.8lbs	<b>33.0Kgs</b> 72.8lbs	<b>31.0Kgs</b> 68.3lbs	N/A	N/A	N/A
Mounting bolt pattern	<b>254 x 114.3mm</b> 10 x 4.5"	<b>254 x 114.3mm</b> 10 x 4.5"	<b>254 x 114.3mm</b> 10 x 4.5"	<b>254 x 114.3mm</b> 10 x 4.5"	<b>166 x 114.3mm</b> 6.54 x 4.5"	<b>48 x 76mm</b> 1.89 x 3"

## Winches - continued

### DB12000i - 12 & 24 volt winches

## DB12000i

DB12000iR



**IMPORTANT**  
When fitting a winch to a Defender don't forget to order the extended winch wiring kit with cut-off switch. Part number DB1014

DB12000i / DB12000i24



Galvanised aircraft cable with break force 14,400lbs

**DB12000i**

Britpart 12,000lbs winch 12 volt

**DB12000i24**

Britpart 12,000lbs winch 24 volt

Dyneema rope with break force 25,800lbs

**DB12000iR**

Britpart 12,000lbs winch 12 volt

#### Performance of 1st Layer

Line Pull		Line Speed				Motor Current	
		12 volt		24 volt		12 volt	24 volt
Lbs	Kgs	Fpm	Mpm	Fpm	Mpm	Amp	Amp
0	0	14.0	4.2	16.8	5.1	90	68
4,000	1,816	9.2	2.8	11.3	3.5	190	140
6,000	2,724	7.9	2.4	9.5	2.9	230	165
8,000	3,632	6.9	2.1	8.4	2.5	260	190
10,000	4,540	6.5	2.0	7.8	2.4	300	220
12,000	5,448	5.9	1.8	7.0	2.2	330	245

#### Line Pull & Rope Capacity by Layer

Rope Layer	Rated Line Pull		Rope Capacity			
			Steel Cable		Dyneema Rope	
	Lbs	Kgs	Feet	Metres	Feet	Metres
1	12,000	5,448	15.0	5.0	13.8	4.2
2	10,200	4,631	38.0	11.5	31.2	9.5
3	8,400	3,814	64.0	19.5	51.5	15.7
4	7,300	3,314	95.0	29.0	76.4	23.3
5	6,500	2,950	100.0	30.5	91.9	28.0

### DB9500i - 12 & 24 volt winches

## DB9500i



DB9500iR



Galvanised aircraft cable with break force 14,400lbs

**DB9500i**

Britpart 9,500lbs winch 12 volt

**DB9500i24**

Britpart 9,500lbs winch 24 volt

Dyneema rope with break force 25,800lbs

**DB9500iR**

Britpart 9,500lbs winch 12 volt

#### Performance of 1st Layer

Line Pull		Line Speed				Motor Current	
		12 volt		24 volt		12 volt	24 volt
Lbs	Kgs	Fpm	Mpm	Fpm	Mpm	Amp	Amp
0	0	19.0	5.8	22.5	6.9	110	85
4,000	1,816	12.5	3.8	14.8	4.5	210	145
6,000	2,724	10.5	3.2	12.5	3.8	260	190
8,000	3,632	8.6	2.6	10.5	3.2	300	220
9,500	4,313	7.9	2.4	9.2	2.8	350	275

#### Line Pull & Rope Capacity by Layer

Rope Layer	Rated Line Pull		Rope Capacity			
			Steel Cable		Dyneema Rope	
	Lbs	Kgs	Feet	Metres	Feet	Metres
1	9,500	4,309	15.0	5.0	13.8	4.2
2	7,500	3,402	38.0	11.5	31.2	9.5
3	6,200	2,812	64.0	19.5	51.5	15.7
4	5,300	2,404	95.0	29.0	76.4	23.3
5	4,630	2,100	100.0	30.5	91.9	28.0



**Winches** - continued  
DB9000C - 12 volt winches

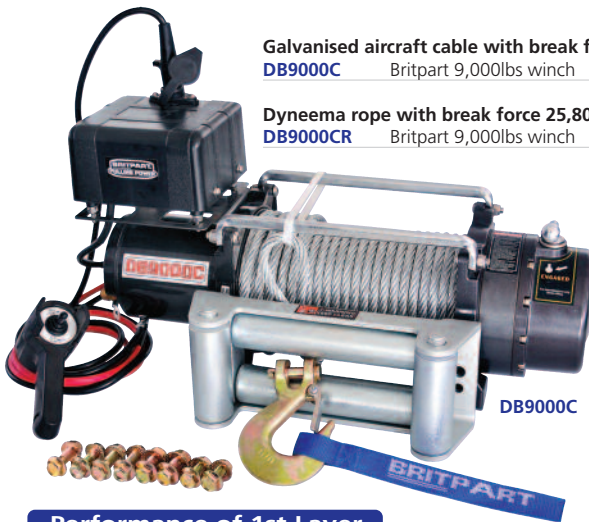

Galvanised aircraft cable with break force 14,400lbs  
**DB9000C** Britpart 9,000lbs winch 12 volt

Dyneema rope with break force 25,800lbs  
**DB9000CR** Britpart 9,000lbs winch 12 volt



DB9000CR

**DB9000C**

**Performance of 1st Layer**

Line Pull		Line Speed		Motor Current
Lbs	Kgs	Fpm	Mpm	Amp
0	0	9.8	3.0	50
2,000	907	9.8	3.0	120
4,000	1,814	8.9	2.7	170
6,000	2,722	8.2	2.5	225
8,000	3,629	7.2	2.2	275
9,000	4,086	6.1	1.9	300

**Line Pull & Cable Capacity by Layer**

Rope Layer	Rated Line Pull		Rope Capacity			
	Lbs	Kgs	Steel Cable		Dyneema Rope	
			Feet	Metres	Feet	Metres
1	9,000	4,309	15.0	5.0	12.8	3.9
2	7,500	3,402	38.0	11.5	29.2	8.9
3	6,200	2,812	64.0	19.5	49.0	15.0
4	5,300	2,404	95.0	29.0	71.9	21.9
5	4,630	2,100	100.0	30.5	91.9	28.0



**IMPORTANT**

When fitting a winch to a Defender don't forget to order the extended winch wiring kit with cut-off switch.  
Part number DB1014

**Performance of 1st Layer**

Line Pull		Line Speed		Motor Current
Lbs	Kgs	Fpm	Mpm	Amp
0	0	8.2	2.5	35
2,000	900	7.8	2.4	100
4,000	1,810	7.2	2.2	180
6,000	2,710	6.5	2.0	230
8,000	3,620	5.0	1.5	300

Galvanised aircraft cable with break force 14,400lbs  
**DB8000** Britpart 8,000lbs winch 12 volt

**Line Pull & Cable Capacity by Layer**

Cable Layer	Rated Line Pull		Cable Capacity	
	Lbs	Kgs	Feet	Meters
1	8,000	3,620	15	5.0
2	6,335	2,876	38	11.5
3	5,243	2,380	64	19.5
4	4,473	2,030	95	29.0
5	3,900	1,770	100	30.5

DB8000 - 12 volt winch

**DB8000**



DB8000

DB6000 - 12 volt winch

Galvanised aircraft cable with break force 10,000lbs  
**DB6000** Britpart 6,000lbs winch 12 volt winch

**Important**  
Winch suitable for small vehicle and trailer applications only.

**DB6000**

**Performance of 1st Layer**

Line Pull		Line Speed		Motor Current
Lbs	Kgs	Fpm	Mpm	Amp
0	0	15.0	4.6	30
1,000	454	11.5	3.5	80
3,000	1,361	9.0	2.7	120
5,000	2,268	7.0	2.0	170
6,000	2,722	4.9	1.5	210

**Line Pull & Cable Capacity by Layer**

Cable Layer	Rated Line Pull		Cable Capacity	
	Lbs	Kgs	Feet	Meters
1	6,000	2,722	12.7	3.87
2	5,000	2,268	27.5	8.38
3	4,250	1,928	44.0	13.41
4	3,720	1,687	64.0	19.51
5	3,330	1,497	85.0	25.91

## Winches - continued

### DB2000 - 12 volt winch



**Cable with break force 4,000lbs  
DB2000**

Britpart Pulling Power  
2,000lbs 12 volt winch

**Important**  
Winch suitable for small vehicle  
and trailer applications only.

# DB2000

#### Performance of 1st Layer

Line Pull		Line Speed		Motor Current
Lbs	Kgs	Fpm	Mpm	Amp
0	0	14.0	4.3	14
1,000	454	9.0	2.7	60
1,500	680	7.5	2.3	90
2,000	907	5.9	1.8	115



Britpart DB2000 fitted  
to a working model of  
a Land Rover

#### Line Pull & Cable Capacity by Layer

Cable Layer	Rated Line Pull		Cable Capacity	
	Lbs	Kgs	Feet	Meters
1	2,000	907	6.0	1.8
2	1,636	742	13.0	4.0
3	1,385	628	22.0	6.7
4	1,200	544	33.0	10.0
5	1,059	480	44.0	13.4
6	947	430	50.0	15.2

## Winch Spare Parts

Part	DB12000i	DB9500i	DB9000C	DB8000	DB6000	DB2000
Winch motor	DB1300	DB1300	DB1332	DB1301	DB1337	N/A
Solenoid assembly	DB1303	DB1303	DB1302	DB1302	DB1336	N/A
Brake service kit	DB1304	DB1304	DB1304	N/A	DB1338	N/A
Roller fairlead	DB1307 - 180mm aperture	DB1307 - 180mm aperture	DB1307 - 180mm aperture	DB1307 - 180mm aperture	DB1341 - 105mm aperture	N/A
Remote control	DB1327 - 20mm socket DB1334 - 20mm socket	DB1327 - 20mm socket DB1334 - 20mm socket	DB1327 - 20mm socket DB1334 - 20mm socket	DB1327 - 20mm socket DB1334 - 20mm socket	DB1334	DB1343
Winch cable	DB1328	DB1328	DB1328	DB1328	DB1339	Winch cable & hook DB1354
Winch cable hook	DB1328H	DB1328H	DB1328H	DB1328H	N/A	
Brush and holder set	DB1330	DB1330	DB1331	DB1331	DB1340	N/A
Remote control socket upgrade kit. From 15mm to 20mm with remote control.	DB1352	DB1352	DB1352	DB1352	DB1352	N/A
Remote control socket upgrade/repair. From 15mm to 20mm.	DB1352R Can also be used to repair existing 20mm socket	DB1352R Can also be used to repair existing 20mm socket	DB1352R Can also be used to repair existing 20mm socket	DB1352R Can also be used to repair existing 20mm socket	DB1352R Can also be used to repair existing 20mm socket	N/A



For more images of the  
winch spare parts please visit  
[www.britpart.com/winchparts](http://www.britpart.com/winchparts)



**Winch Bumpers**  
Winch Bumper Kits



*The only kits you need...*

DB1320

*...to get winching!*

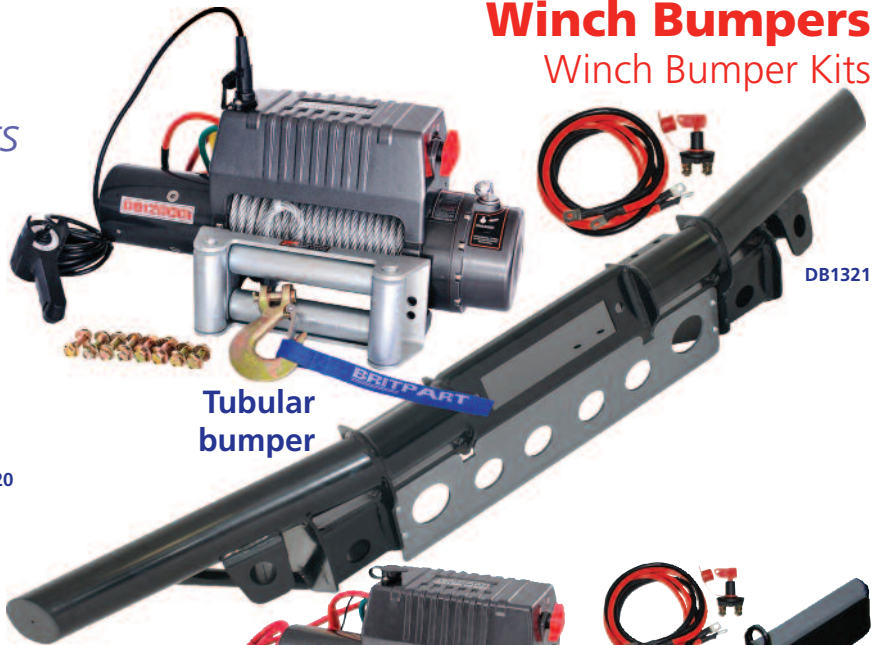

**Tubular bumper**

DB1321

Defender winch bumper kits all include the extended wiring kit including safety cut-off switch kit (DB1014)

Steel Cable **Dyneema Rope**

Standard winch bumpers

DB1313	DB1313R	Defender - non air-con	DB12000i winch
DB1344	DB1344R	Defender - air-con	DB12000i winch
DB1310	DB1310R	Defender - non air-con	DB9500i winch
DB1345	DB1345R	Defender - air-con	DB9500i winch
DB1313-24V		Defender - non air-con	DB12000i winch - 24 volt

Galvanised standard winch bumpers

DB1313GALV	DB1313RGALV	Defender - non air-con	DB12000i winch
DB1310GALV	DB1310RGALV	Defender - non air-con	DB9500i winch

Tubular winch bumpers

DB1319	DB1319R	Defender - non air-con	DB12000i winch
DB1321	DB1321R	Defender - air-con	DB12000i winch
DB1348	DB1348R	Defender - non air-con	DB9500i winch
DB1349	DB1349R	Defender - air-con	DB9500i winch

Standard winch bumpers

DB1325	DB1325R	Discovery 1/Range Rover Classic	DB12000i winch
<b>Note</b> - For vehicles without air-con and/or without transmission oil coolers fitted			
DB1324	DB1324R	Discovery 1/Range Rover Classic	DB9500i winch
<b>Note</b> - For vehicles without air-con and/or without transmission oil coolers fitted			
DB1346	DB1346R	Discovery 2	DB12000i winch
DB1347	DB1347R	Discovery 2	DB9500i winch

Tubular winch bumper

DB1320	DB1320R	Discovery 1	DB12000i winch
<b>Note</b> - Grille needs trimming for fitment to air-con & automatic vehicles			
DB1350	DB1350R	Discovery 1	DB9500i winch
<b>Note</b> - Grille needs trimming for fitment to air-con & automatic vehicles			

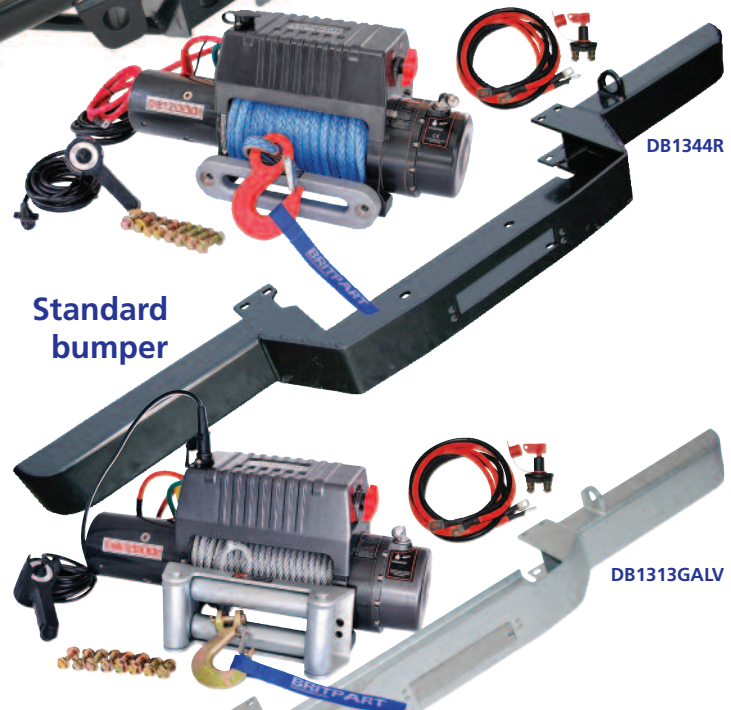

**Standard bumper**

DB1344R

DB1313GALV

**Galvanised standard bumper**



DB1324 / DB1325

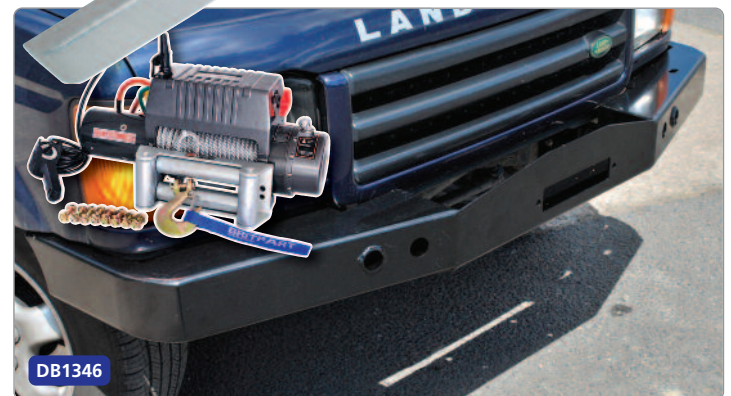

DB1346



## Tubular winch bumpers

- Stylish tubular steel space-frame construction for strength
- Extremely close fitting for maximum approach angle
- Compatible with many steering guards
- Built-in high-lift jacking points
- Integral rock guard
- Supplied with full fitting kit

**Note** - Grille will need modifying

**DA5609** Defender - air-con  
Suitable for DB12000i, DB9500i, DB9000C & DB8000 winches

**DA5622** Defender - non air-con  
Suitable for DB12000i, DB9500i, DB9000C & DB8000 winches

**DA5604** Discovery 1  
Suitable for DB12000i, DB9500i, DB9000C & DB8000 winches

**Note** - Grille needs trimming for fitment to air-con & automatic vehicles

## Standard winch bumpers

- Heavy-duty steel winch bumpers

**DA5620** Defender - non air-con Black

**DA5681** Defender - non air-con Galvanised

Suitable for DB12000i, DB9500i, DB9000C & DB8000 winches

**DA5623** Defender - air-con

Suitable for DB12000i, DB9500i, DB9000C & DB8000 winches

**DA5643** Defender - air-con

Suitable for Warn 9000 and 9.5 Series winches

**DA5621** Discovery 1/Range Rover Classic

**Note** - For vehicles without air-con and/or without transmission oil coolers fitted

Suitable for DB12000i, DB9500i, DB9000C & DB8000 winches

**DA5645** Discovery 2

Suitable for DB12000i, DB9500i, DB9000C & DB8000 winches

- One piece bumper manufactured from 5mm steel with wrap around sides to protect the wings

- Fixed to standard mounting points with provisions for 2 swivel recovery points and 2 Hi-Lift jacking points

**Note** - Grille needs trimming to fit winch

## Discreet winch bumpers

- Suitable for any low line winch

- Made from 6mm and 8mm steel

- Discreetly fits behind the existing bumper

- Bolts directly onto the front cross member using existing holes

- Modifications to bumper are required, includes instructions

- Excludes fairlead

**DA7537** Discovery 3 - TdV6/Discovery 4 - TdV6/Range Rover Sport - TdV6

**DA7538** Range Rover Sport - 3.6 TdV8, 4.2 V8 Supercharged, 4.4 V8



**DA1171**  
A pair of Defender bumper fixing plates. Easier fitment plates which replace the standard fitted spring clip style plates. Can be used on standard bumpers too.

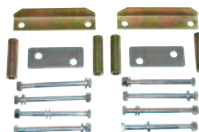

**DA5621K**  
Discovery 1/Range Rover Classic Replacement fitting kit for winch bumper - DA5621

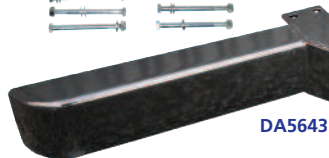

**DA5643**



**DA5609**



**DA5622**



**DA5604**



**DA5699**

Universal number plate mounting bracket  
405mm wide x 110mm deep



Number plate not included

**A range of winch bumpers to suit your vehicle!**

## Standard winch bumpers



**DA5623**



**DA5681**



**DA5621**

Winch not included



**DA5620** Winch and A bar not included



**DA5645**



**DA7537**

## Fairleads

### 255mm Mounting holes

<b>DB1003</b>	Hawse fairlead	Steel	215mm aperture
<b>DB1004</b>	Hawse fairlead	Steel	130mm aperture
<b>DB1315</b>	Hawse fairlead	Aluminium	205mm aperture
<b>DB1317</b>	Hawse fairlead	Stainless steel	205mm aperture
<b>DB1316</b>	Roller fairlead	Stainless steel	180mm aperture
<b>DB1307</b>	Roller fairlead	Zinc coated	180mm aperture
<b>DB1341</b>	Roller fairlead	Zinc coated	105mm aperture

### 125mm Mounting holes

<b>DB1005</b>	Hawse fairlead	Steel	80mm aperture
---------------	----------------	-------	---------------



**DB1317**



**DB1315**



**DB1003**



**DB1004**

**DB1005**

## Winch Accessories & Kits

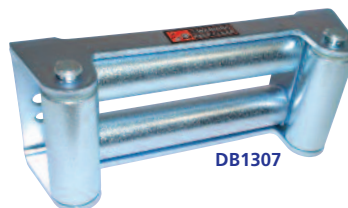

**DB1307**



**DB1316**

**Winch Accessories & Kits** - continued

**Ropes & Straps**

DA3032	Tree strop	1.5t SP	3m x 90mm
DA3033	Tree strop	1.5t SP	4m x 90mm
DA3034	Tree strop	1.5t SP	6m x 90mm
DB1007	Tree strop	4t SP	1.6m x 120mm
DA2246	Tow strap	2t WLL	5m x 60mm
DB1006	Tow strap	8t WLL	9m x 60mm
DB1011	High elasticity tow sling	8t WLL	9m x 60mm
DA3028	Rope - polypropylene	8t MBL	5m x 24mm
DA3029	Rope - nylon	12t MBL	5m x 24mm
DA3030	Kinetic recovery rope - octoplat	12t MBL	5m x 24mm
DA3031	Kinetic recovery rope - octoplat	12t MBL	8m x 24mm

Note - SP = straight pull WLL = working load limit, MBL = maximum breaking load

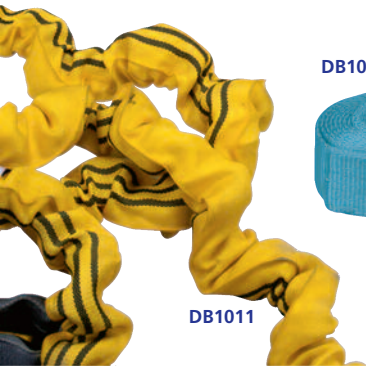

DB1011



DB1006



DA3028



DA3030

DA3034



DB1007

More product images at [www.britpart.com](http://www.britpart.com)

**Shackles & Pulleys**

DA3160	Swivel recovery eye - stainless steel - 36mm diameter & shackle (3.25 tons)
Note - Not suitable for standard Land Rover bumpers	
DA3160A	Replacement shackle for DA3160
DB1002	Snatch block High quality tempered steel. Maximum head load - 9,000kgs.
DB1008	Pulley hook - SWL loads - Pulling - 1,500kgs / Lifting - 750kgs
DB1009	Shackle - 1.4 ton
DB1353	'D' shackle - 1.4 ton
DB1012	Shackle - 4.7 ton
DB1322	Swivel shackle
DB1323	Non-forged jate ring
DB1329	Forged jate ring



DB1008



DB1002



DB1323

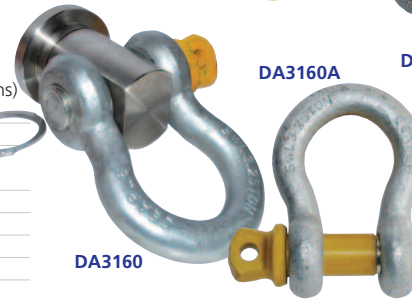

DA3160

DA3160A

DB1012



DB1353

DB1009

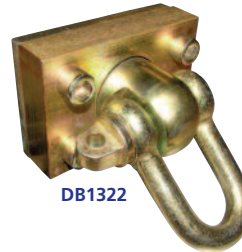

DB1322



DB1329



DB1010

DB1308

DA3156

**Safety Equipment**

DA2037	Universal battery isolator switch
DA2037KY	Replacement isolator switch key for DA2037
DA3156	Winch In Safety - A5 guide from Land Rover
DB1000	Wheel chocks - pair
DB1010	Gloves - for protection winch operation
DB1016	Winch blanket - manufactured from heavy-duty vinyl, the blanket will absorb most of the recoil in the unlikely event of the cable breaking. It's also very useful to kneel on in the mud!

DB1308 12 volt remote DB1308-24V 24 volt remote  
Winch remote control - operate your winch from a safe distance with this wireless remote control

- High frequency circuit using SMD design for reliability
- The transmitter uses FM technology for frequency stability and greater control distance
- Receiver output is protected against voltage spikes

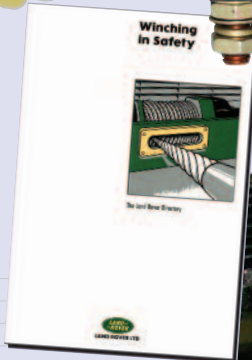

DB1000

DA2037



DA2037KY

**Winch with safety in mind!**



DB1016

## Winch Accessories & Kits - continued



DB1309



DB1001



DB1014



DB1328



DB1318



DB1314



**Ooops!...**  
*"Glad I've got that Britpart winch"*

### Other Essential Winching Accessories

<b>DB1001</b>	Winch bag - a heavy-duty black and green bag
<b>DB1014</b>	Extended winch wiring kit - 1 x red, 1 x black wire, each 1.8m in length with end connectors and cut-off switch for Defender vehicles
<b>DB1309</b>	'Dyneema Bowrope' 12 strand synthetic fibre replacement winch rope - 11mm x 28m Breaking point - 25,800lbs <ul style="list-style-type: none"> <li>• For use with DB9000C, DB9500i and DB12000i winches</li> <li>• Very light</li> <li>• Easily spliced</li> <li>• Highly visible</li> <li>• Less effort in use</li> <li>• Very strong</li> <li>• Does not curl</li> <li>• Compact</li> <li>• Safety in use</li> <li>• Easy to handle</li> <li>• Floats</li> <li>• Does not kink</li> </ul>
<b>DB1314</b>	Ground anchor set - 600mm pins
<b>DB1318</b>	Ground anchor bag set - 2 x Pulling Power bags <b>Note</b> - ground anchor not included (DA1314)
<b>DB1328</b>	Replacement winch cable with hook - 30.5m x 9.5mm Galvanised aircraft cable with break force - 14,400lbs



DB1015

### Winching Accessory Kits

- DB1015**
- 1 x DB1000 Wheel chocks (pair)
  - 1 x DB1001 Winch kit bag
  - 1 x DB1002 Snatch block - 9,000kgs
  - 1 x DB1006 Tow strap - 8 ton, 60mm x 9m
  - 1 x DB1007 Tree stop
  - 1 x DB1010 Winching gloves
  - 1 x DB1011 Snatch tow sling - 8 ton
  - 2 x DB1012 Alloy bow shackle - 4.75 ton
  - 1 x DB1016 Winching blanket



DB1017

- DB1017**
- 1 x DB1001 Winch kit bag
  - 1 x DB1002 Snatch block - 9,000kgs
  - 1 x DB1006 Tow strap - 8 ton, 60mm x 9m
  - 1 x DB1007 Tree stop
  - 1 x DB1010 Winching gloves
  - 2 x DB1012 Alloy bow shackle - 4.75 ton



DB1017P

- DB1017P**
- 1 x DB1001 Winch kit bag
  - 1 x DB1002 Snatch block - 9,000kgs
  - 1 x DB1007 Tree stop
  - 1 x DB1010 Winching gloves
  - 2 x DB1012 Alloy bow shackle - 4.75 ton
  - 2 x DB1329 Jate rings

Britpart Pulling Power winching recovery kits come with all the basic items needed to ensure your winch can be used to the best effect. There is a choice of a starter or professional kit depending on your needs.

## Section contents

**Braking**

Anti-squeal shims	96	Tunit	105
Brake discs - Britpart Performance	96	Turbo boost box	105
Brake discs & pads - EBC	97 - 98	Upgrade chip	105
Brake hose kits	99	Weber carburettors	105
Brake lubrication	96		
Handbrake conversion kits	99		

**Engine**

Air filters - Britpart Performance	101	Double 'S' stainless steel exhausts - sports systems	107
Air filters - K&N	102	Double 'S' stainless steel exhausts - standard systems	106
EGR blanking & silicone hose kits	100	Front downpipes	107
EGR blanking kits & tubes	100	Stainless steel exhaust	108
Filter guards	100	Utility link & rear silencers	107
Intercoolers - performance	102		
PSI power tuning products	104		
Silicone turbo hoses	103		

"Upgrade your Land Rover from its standard spec into something a bit more special with upgrades for the braking system and engines."

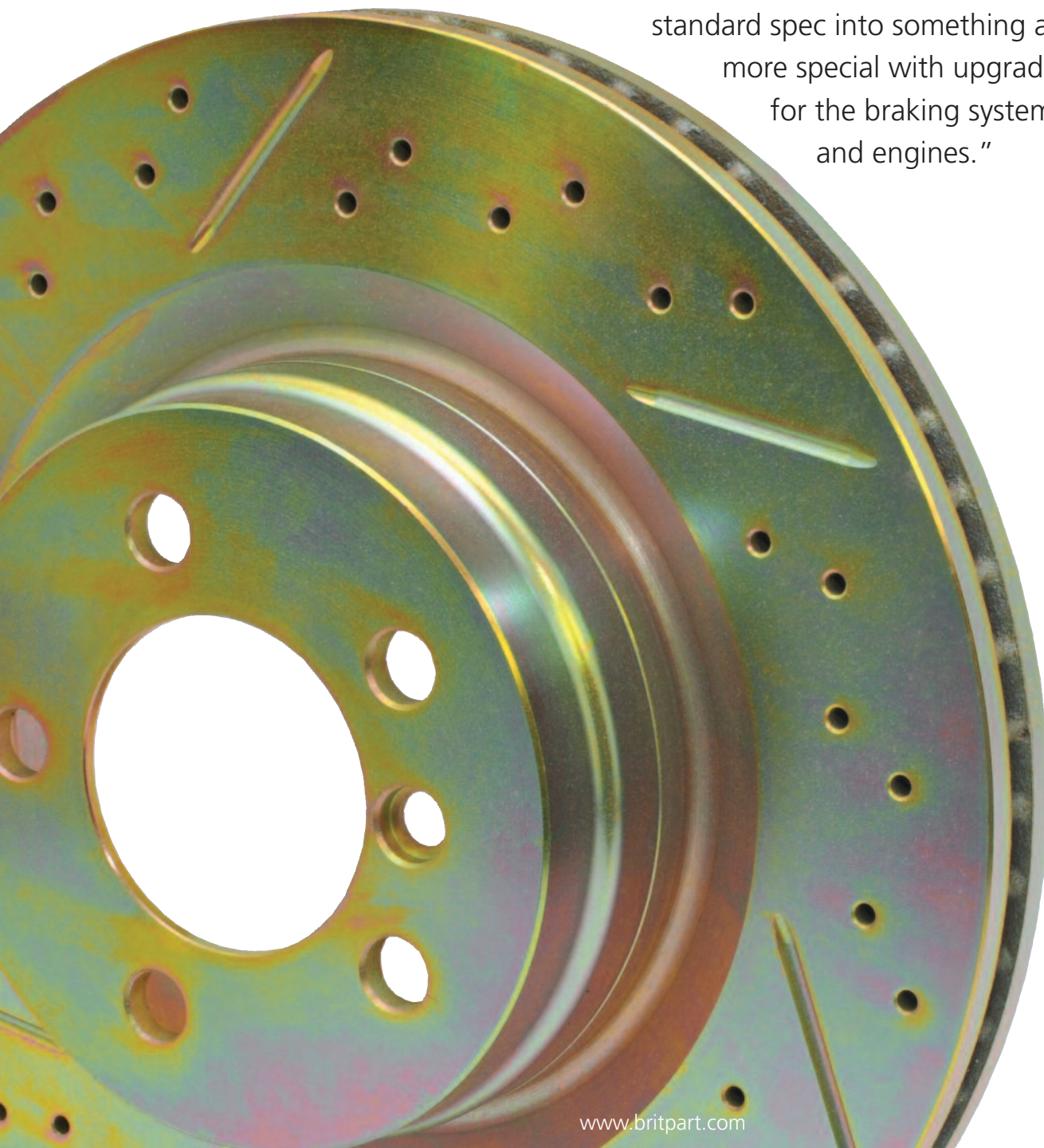

## Braking

### Anti-squeal shims

Universal self adhesive noise dampening shims



DA1141

The shims are manufactured from wolverine and cut to shape and applied to the backing plate of the Brake pads prior to fitting to help eliminate any noise issues (should the pad be unshimmed). When used in conjunction with Mintex CeraTec silicon based lubricant, most brake noise related issues will be eradicated. Pack quantity 4.

#### IMPORTANT BRAKE INFORMATION

For exact change over points with vehicle applications please contact your local Britpart distributor with the full chassis number for the correct application. These references are intended as a guide only.

## Brake Lubrication

### Cera-Tec Advanced Lubricant

Mintex Cera TEC is an advanced non-metallic universal lubricant that provides many benefits over traditional copper-based grease.



DA2389

- Non-metallic content - ABS and ESP friendly
- Operates to a high temperature (1,000°C)
- Non-conductive
- Free of copper and acid
- More effective at reducing any brake squeal
- Protects against corrosion and dirt
- Neutral colour prevents any visible residue or staining



## Brake Discs - Britpart Performance

- Slotted design to increase braking efficiency by reducing dust, debris, water and gas on the disc.
- To improve brake cooling, reduce weight and to offer an escape route for dirt and gasses these performance discs are drilled with rows of holes.
- Excellent upgrade for your Land Rover to aid braking, especially under a heavy load.
- Ideal for off-road use.
- Manufactured to British Standard BS1452 Grade 220 and DIN1691 GG20.
- Supplied in pairs.



# BRITPART

Quality  
performance  
brake  
discs!

Defender	Corresponds to			
DA4600	LR017951/FRC7329	Defender - 1987 - 2006 & 2007 onwards	Front	Solid
DA4602	LR017952/FTC902	Defender - 1987 - 2006 & 2007 onwards	Front	Vented
DA4601	LR017953/FTC1381	Defender - 1987 - 2006 & 2007 onwards	Rear	Solid
DA4605	LR018026/SDB000330	Defender - 1987 - 2006 & 2007 onwards	Rear	Solid
Discovery				
DA4600	LR017951/FRC7329	Discovery 1	Front	Solid
DA4602	LR017952/FTC902	Discovery 1	Front	Vented
DA4601	LR017953/FTC1381	Discovery 1	Rear	Solid
DA4606	SDB000380	Discovery 2	Front	Vented
DA4604	SDB000470	Discovery 2	Rear	Solid
DA4611	SDB000614	Discovery 3	Front	Vented
DA4612	SDB000604	Discovery 3	Front	Vented
DA4613	SDB000646	Discovery 3	Rear	Vented
DA4614	SDB000636	Discovery 3	Rear	Vented
DA4624	SDB000624	Discovery 4	Front	Vented
DA4612	SDB000604	Discovery 4	Front	Vented
DA4613	SDB000646	Discovery 4	Rear	Vented
DA4614	SDB000636	Discovery 4	Rear	Vented
Freelander				
DA4607	SDB100830	Freelander 1 - up to YA999999	Front	Solid
DA4608	SDB101070	Freelander 1 - 1A000001 onwards	Front	Vented
DA4617	LR000470/LR027107	Freelander 2 - petrol	Front	Vented
DA4615	LR001019	Freelander 2 - petrol	Rear	Vented
DA4618	LR007055	Freelander 2 - diesel	Front	Vented
DA4616	LR001018	Freelander 2 - diesel	Rear	Solid
Range Rover				
DA4600	LR017951/FRC7329	Range Rover Classic - 1986 - 1991	Front	Solid
DA4602	LR017952/FTC902	Range Rover Classic - 1986 - 1994	Front	Vented
DA4601	LR017953/FTC1381	Range Rover Classic - 1986 - 1994	Rear	Solid
DA4603	NTC8780	Range Rover P38 - 1995 - 2002	Front	Vented
DA4604	SDB000470	Range Rover P38 - 1995 - 2002	Rear	Solid
DA4611	SDB000614	Range Rover Sport - 2005 - 2009	Front	Vented
DA4612	SDB000604	Range Rover Sport - 2005 - 2009	Front	Vented
DA4624	SDB000624	Range Rover Sport - 2005 - 2013	Front	Vented
DA4613	SDB000646	Range Rover Sport - 2005 - 2013	Rear	Vented
DA4614	SDB000636	Range Rover Sport - 2005 - 2009	Rear	Vented
DA4609	SDB000201	Range Rover L322	Front	Vented
DA4619	SDB500182	Range Rover L322	Front	Vented
DA4622	LR031843/SDB500193	Range Rover L322	Front	Vented
DA4610	SDB000211	Range Rover L322	Rear	Solid
DA4623	LR017804/LR031844	Range Rover L322	Rear	Vented
	SDB500202/SDB500201			
DA4625	LR011591	Range Rover L322 - 2010 - 2012	Front	Vented
DA4627	LR016176	Range Rover L322 - 2010 - 2012	Front	Vented
DA4626	LR011891/LR031846	Range Rover L322 - 2010 - 2012	Rear	Vented



**IMPORTANT BRAKE INFORMATION**

For exact change over points with vehicle applications please contact your local Britpart distributor with the full chassis number for the correct application. These references are intended as a guide only.

# EBC BRAKES

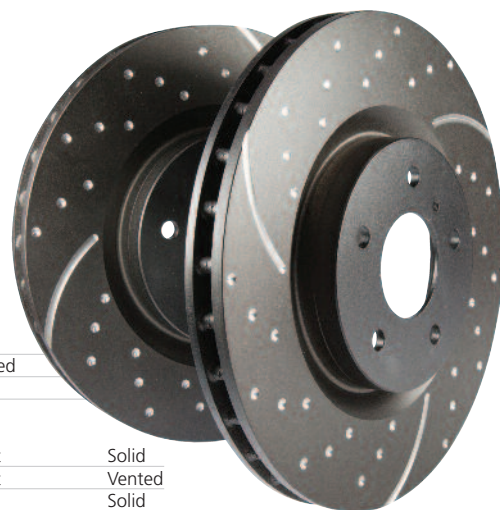

**EBC Brake Discs - Pairs**

Defender	Corresponds to			
DA4165	LR017951/FRC7329	Defender - 1987 - 2006 & 2007 onwards	Front	Solid
DA4151	LR017952/FTC902	Defender - 1987 - 2006 & 2007 onwards	Front	Vented
DA4152	LR017953/FTC1381	Defender - 1987 - 2006 & 2007 onwards	Rear	Solid

**Discovery**

DA4165	LR017951/FRC7329	Discovery 1	Front	Solid
DA4151	LR017952/FTC902	Discovery 1	Front	Vented
DA4152	LR017953/FTC1381	Discovery 1	Rear	Solid
DA4158	SDB000380	Discovery 2	Front	Vented
DA4148	SDB000470	Discovery 2	Rear	Solid
DA4187	SDB000614	Discovery 3	Front	Vented
DA4475	SDB000604	Discovery 3	Front	Vented
DA4188	SDB000646	Discovery 3	Rear	Vented
DA4473	SDB000636	Discovery 3	Rear	Vented
DA4496	SDB000624	Discovery 4	Front	Vented
DA4475	SDB000604	Discovery 4	Front	Vented
DA4188	SDB000646	Discovery 4	Rear	Vented
DA4473	SDB000636	Discovery 4	Rear	Vented

**Freelander**

DA4477	SDB101070	Freelander 1 - 1996 from 1A000001	Front	Vented
DA4551	LR000470/LR027107	Freelander 2 - petrol	Front	Vented
DA4549	LR001019	Freelander 2 - petrol	Rear	Vented
DA4552	LR007055	Freelander 2 - diesel	Front	Vented
DA4550	LR001018	Freelander 2 - diesel	Rear	Solid

**Range Rover**

DA4165	LR017951/FRC7329	Range Rover Classic - 1986 - 1991	Front	Solid
DA4151	LR017952/FTC902	Range Rover Classic - 1986 - 1994	Front	Vented
DA4152	LR017953/FTC1381	Range Rover Classic - 1986 - 1994	Rear	Solid
DA4147	NTC8780	Range Rover P38 - 1995 - 2002	Front	Vented
DA4148	SDB000470	Range Rover P38 - 1995 - 2002	Rear	Solid
DA4187	SDB000614	Range Rover Sport - 2005 - 2009	Front	Vented
DA4475	SDB000604	Range Rover Sport - 2005 - 2009	Front	Vented
DA4496	SDB000624	Range Rover Sport - 2005 - 2009 & 2010 - 2013	Front	Vented
DA4188	SDB000646	Range Rover Sport - 2005 - 2013	Rear	Vented
DA4473	SDB000636	Range Rover Sport - 2005 - 2009	Rear	Vented
DA4474	SDB000201	Range Rover L322	Front	Vented
DA4476	SDB500193	Range Rover L322	Front	Vented
DA4472	SDB000211	Range Rover L322	Rear	Solid
DA4488	LR017804/LR031844	Range Rover L322	Rear	Vented
	SDB500202/SDB500201	<b>Note</b> - not dimpled or slotted		

- 100% British cast and machined high quality product.
- Wide aperture slots that draw cool air under the pad surface.
- Slots that expel all dirt dust and debris from the braking area.
- Blind drilled dimples that eliminate cracking common with through drilled sport rotors whilst helping maintain perfect pad contact.

**EBC Yellow Stuff Performance Race Brake Pads - Sets**

Defender	Corresponds to		
DA4560	SFP000260	Defender 90 - from 1991	Front
DA4560	SFP000260	Defender 110 - from 1986	Front

**Discovery**

DA4336	SFP500150/SFP000210	Discovery 2	Front
DA4339	SFP500130/SFP100470	Discovery 2	Rear
DA4335	LR019618/SFP500010	Discovery 3/Discovery 4	Front
DA4340	LR019627/LR021316	Discovery 3/Discovery 4	Rear
	SFP500140		

**Range Rover**

DA4336	SFP500120/SFP100460	Range Rover P38 - 1995 - 2002	Front
DA4339	SFP500130/SFP100470	Range Rover P38 - 1995 - 2002	Rear
DA4335	LR019618/SFP500010	Range Rover Sport - 2005 - 2009	Front
DA4337	SFP500070	Range Rover Sport - 2005 - 2009	Front
DA4340	LR019627/LR021316	Range Rover Sport - 2005 - 2013	Rear
	SFP500140		
DA4335	LR019618/SFP500010	Range Rover L322	Front
DA4337	SFP500070	Range Rover L322	Front
DA4338	SFC500080/SFC500050	Range Rover L322	Front
DA4341	SFP500210	Range Rover L322	Rear
DA4340	LR019627/LR021316	Range Rover L322	Rear
	SFP500140		

- High friction compound which is effective from cold up to high heat.
- Effective brake upgrade for heavy-duty braking.
- Long lasting powerful brakes.
- Shims, edge chamfers and slots for silent braking.

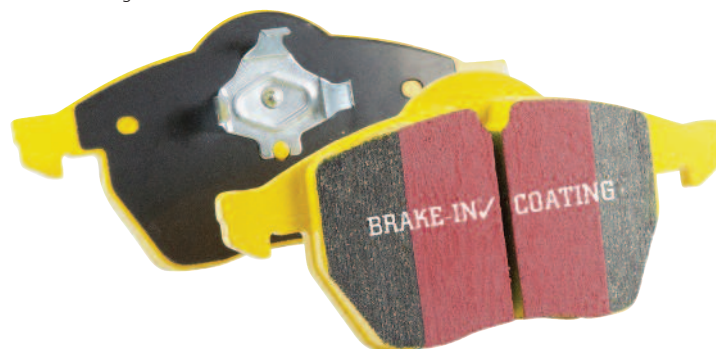

EBC Yellowstuff brake pads are British made and contain Aramid fibres. These are man-made high performance fibres, used widely for their light-weight, high strength, abrasion resistance and thermal stability. These properties provide advantages over cheaper steel fibre based products. Not only high in friction from first application when brakes are cold but extremely effective at higher brake temperatures as encountered in faster driving and towing/trailing. These pads are a favourite with the military and are used on armoured vehicles in several countries to handle the higher loads and heat and offer a good brake upgrade. Fitted with shims chamfers, centre slots and the unique EBC Brake in coating for fast bedding in of new brakes these pads are also long lasting and silent in operation.

## Brake Discs & Pads - EBC - continued

# GREEN STUFF

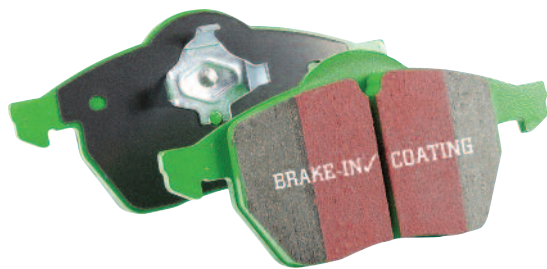

- 100% British design and manufacture.
- Superb gloss powder coat paint finish to reduce corrosion.
- Unique engineering finish with noise reduction slots and edge chamfers.
- Extra high friction compounds for better stops, these pads will improve your stopping power by up to three vehicle lengths.
- Special compound ingredients that prevent "Outline Etching" eliminating brake stiction onto the rotor in damp conditions.
- Unique "Brake-In" surface coating to accelerate pad bed in after installing new pads which also guarantees brake efficiency from install.
- Super quiet braking with rubber-steel-rubber noise reduction shims on the reverse, this dampens all possible noise.
- Extra heavy duty compound lasts longer than low cost standard pads.
- Fully ECE R 90 approved and legal for road and off road use.

### EBC Green Stuff High Performance Brake Pads - Sets

Defender	Corresponds to		
DA4153	SFP500220/STC9187/STC9186	Defender 90 - up to 1986	Front
DA4157	SFP500160/STC9191	Defender 90 - 1986 - 1991	Front
DA4159	SFP000260/STC2952	Defender 90 - from 1991	Front
DA4154	SFP500200/STC9189	Defender 90 - from 1994	Rear
DA4485	SFP000270	Defender 90 - from 1994	Rear
DA4159	SFP000260/STC2952	Defender 110 - from 1986	Front
DA4185	SFP000280/SFP000160/STC1601	Defender 110 - from 1994	Rear

#### Discovery

DA4156	SFP500180/STC9190	Discovery 1	Front
DA4157	SFP500160/STC9191	Discovery 1 - from 1994	Front
DA4154	SFP500200/STC9189	Discovery 1 - with sensor	Rear
DA4155	SFP500200	Discovery 1 - with sensor	Rear
DA4485	SFP000270	Discovery 1 - without sensor	Rear
DA4149	SFP500150/SFP000210	Discovery 2	Front
DA4150	SFP500130/SFP100470	Discovery 2	Rear
DA4481	LR019618/SFP500010	Discovery 3/Discovery 4	Front
DA4484	LR019627/LR021316/SFP500140	Discovery 3/Discovery 4	Rear

#### Freelander

DA4478	LR021899/SFP500100	Freelander 1 - 1996 - from 1A000001	Front
DA4479	SFP100360	Freelander 1 - 1996 - up to YA999999	Front
DA4486	LR004936	Freelander 2	Front
DA4487	LR003657/LR023888	Freelander 2	Rear

#### Range Rover

DA4153	SFP500220/STC9187/STC9186	Range Rover Classic - up to 1986	Front
DA4156	SFP500180/STC9190	Range Rover Classic - 1986 - 1996 - with sensor	Front
DA4154	SFP500200/STC9189	Range Rover Classic - up to 1985	Rear
DA4155	SFP500200	Range Rover Classic - from 1986	Rear
DA4485	SFP000270	Range Rover Classic - up to 1985	Rear
DA4149	SFP500120/SFP100460	Range Rover P38 - 1995 - 2002	Front
DA4150	SFP500130/SFP100470	Range Rover P38 - 1995 - 2002	Rear
DA4481	LR019618/SFP500010	Range Rover Sport - 2005 - 2009	Front
DA4482	SFP500070	Range Rover Sport - 2005 - 2009	Front
DA4484	LR019627/LR021316/SFP500140	Range Rover Sport - 2005 - 2013	Rear
DA4481	LR019618/SFP500010	Range Rover L322	Front
DA4482	SFP500070	Range Rover L322	Front
DA4480	SFC500080/SFC500050	Range Rover L322	Front
DA4484	LR019627/LR021316/SFP500140	Range Rover L322	Rear
DA4483	SFP500210/SFP000120	Range Rover L322	Rear

### EBC Ultimax Heavy-duty Brake Pads - Sets

Defender	Corresponds to		
DA3307	SFP500220/STC9187/STC9186	Defender 90 - up to 1986	Front
DA3311*	SFP500160/STC9191	Defender 90 - 1986 - 1991	Front
DA3310*	SFP000260/STC2952	Defender 90 - from 1991	Front
DA3318	SFP000270	Defender 90 - from 1994	Rear
DA3308*	STC2950	Defender 110 - up to 1986	Front
DA3310*	SFP000260/STC2952	Defender 110 - from 1986	Front
DA3313*	SFP000280/SFP000160/STC1601	Defender 110 - from 1994	Rear

#### Discovery

DA3309*	SFP500220/STC9187	Discovery 1 - up to 1993	Front
DA3311*	SFP500160/STC9191	Discovery 1 - from 1994	Front
DA3312*	SFP500180/STC9190	Discovery 1	Front
DA3318	SFP000270	Discovery 1 - without sensor	Rear
DA3319*	SFP500200/STC9189	Discovery 1 - with sensor	Rear
DA3300	SFP500150/SFP000210	Discovery 2	Front
DA3314	SFP500130/SFP100470	Discovery 2	Rear
DA3304	LR019618/SFP500010	Discovery 3/Discovery 4	Front
DA3316	LR019627/LR021316/SFP500140	Discovery 3/Discovery 4	Rear

#### Freelander

DA3301	LR021899/SFP500100	Freelander 1 - 1996 - from 1A000001	Front
DA3302	SFP100360	Freelander 1 - 1996 - up to YA999999	Front
DA3306	LR004936	Freelander 2	Front
DA3317	LR003657/LR023888	Freelander 2	Rear

#### Range Rover

DA3307	SFP500220/STC9187/STC9186	Range Rover Classic - up to 1986	Front
DA3309*	SFP500220/STC9187	Range Rover Classic - 1986 - 1991	Front
DA3312*	SFP500180/STC9190	Range Rover Classic - 1986 - 1996 - with sensor	Front
DA3318	SFP000270	Range Rover Classic - up to 1985	Rear
DA3319*	SFP500200/STC9189	Range Rover Classic - from 1986	Rear
DA3300	SFP500120/SFP100460	Range Rover P38 - 1995 - 2002	Front
DA3314	SFP500130/SFP100470	Range Rover P38 - 1995 - 2002	Rear
DA3304	LR019618/SFP500010	Range Rover Sport - 2005 - 2009	Front
DA3316	LR019627/LR021316/SFP500140	Range Rover Sport - 2005 - 2013	Rear
DA3303	SFC500080/SFC500050	Range Rover L322	Front
DA3304	LR019618/SFP500010	Range Rover L322	Front
DA3315	SFP500210/SFP000120	Range Rover L322	Rear
DA3316	LR019627/LR021316/SFP500140	Range Rover L322	Rear

# Ultimax



- New AF42/66 friction material which completely eliminates brake judder and produces a high friction long lasting brake pad.
- Unique powder coat finish to both pad and back plate gives lifetime resistance to corrosion and prevents moisture ingress.
- Unique Brake-In surface coating provides instant brake efficiency on installation and conditions the brake rotor removing glaze, black spotting etc from disc surface.
- All pads feature centre line slot which prevents heat expansion cracks and reduces brake noise.
- All pads feature edge chamfers which have major technical benefits;
  - Significant reduction in brake noise
  - Prevents 'edge lifting' under left and right extremities of pad which can cause corrosion ingress and eventual pad de-bond
  - Can extend pad life by virtue of improved pad efficiency
- Most pads in the Ultimax range features factory fitted noise reduction shims.

**Brake Hose Kits**

	Britpart			Goodridge	
	Standard	Plus 40mm	Plus 150mm	Standard	Plus 40mm
<b>Defender</b>					
90 - 1984 - 1998 (WA159806)	DA2400S	DA240040S	DA2400150S		
110 - 1983 - 1998 (WA159806)	DA2402S	DA240240S	DA2402150S		
90/110 - metric - ABS & non-ABS 1999 (XA159807) - 2004 (4A683087)	DA2401S	DA240140S	DA2401150S		
<b>Discovery 1</b>					
1989 - 1992 (JA034313)	DA2410S	DA241040S	DA2410150S		
1992 (KA034314) - 1995 (LA081991)	DA2411S	DA241140S	DA2411150S		
1995 (from MA018992) - 1999 - Non-ABS	DA2412S	DA241240S	DA2412150S		
1995 (from MA018992) - 1999 - ABS	DA2413S	DA241340S	DA2413150S	DA2413	
<b>Discovery 2</b>					
ABS	DA2414S	DA241440S			
<b>Range Rover Classic</b>					
Up to 1981 - imperial - Non-ABS		DA240340S			
1981 - 1990 - metric - Non-ABS		DA240440S			
1990 - 1992 - metric - ABS		DA240640S			
1992 - metric - ABS		DA240740S			
107" - imperial - Non-ABS					DA240540
<b>Range Rover P38</b>					
1995 - up to TA	DA2409S	DA240940S			
<b>Series 2/Series 3</b>					
SWB - 1960 - 1979 - imperial	DA2418S	DA241840S			
SWB - 1980 - 1984 - metric	DA2419S	DA241940S		DA2419	
LWB - 1971 - 1979 approx - imperial	DA2420S*	DA242040S			
LWB - 1980 - 1984 - metric	DA2421S	DA242140S		DA2421	DA242140

**INCREASE YOUR BRAKING EFFICIENCY**



**BRITPART**

These brakelines are constructed from the finest quality hose, consisting of a PTFE inner and stainless steel overbraid.

- Eliminates sponginess under heavy braking.
- Increases braking efficiency.
- Abrasion and corrosion resistant.
- Britpart hoses available at plus 150mm lengths - ideal for use with our Plus 5" suspension products.



**GOODRIDGE**



\*Note - Front hoses fit directly into the wheel cylinders replacing brake pipe 537763

**Handbrake Conversion Kits**

Driving off-road you'll know how easy it is for the standard Land Rover hand brake to get bunged up with dirt and once the mechanism gets clogged up it doesn't work as efficiently as it should. Britpart now offer a solution to that problem - a drum to disc conversion kit. These kits use powerful callipers whose mechanism is sealed to prevent the access of mud. Parts are supplied coated with a tough corrosion resistant coating of gold zinc passivate to ensure a long life. Fitting is easy requiring only simple tools. Full fitting instructions are included as well as advice on adjustment and use.

**Defender/Discovery/Range Rover Classic**

The disc transmission brake uses a state of the art monster sized mechanical caliper designed for agricultural vehicles and earth moving equipment - so using it on a Land Rover is easy work for it. The mechanism is sealed so it will not seize up due to ingress of mud or water and it uses special 'sintered' pads which are resistant to abrasion from mud as well as providing greater friction against the disc than a standard pad. The disc has been specially designed for Land Rovers and manufactured from tough 10mm thick steel. It has a smaller diameter than a standard drum and so does not dangle below the transfer box which helps it to protect it from whatever you are driving over. The caliper mechanism sits in a well protected area at the top, away from most of the mud and water.

- DA5513** Defender 90 & 110  
For anything post 1993 (300Tdi, Td5 & Puma) you need to change the cable - NRC5088.
- DA5526** Discovery 1/Discovery 2/Range Rover Classic - will not fit a Borg Warner or LT95 transfer box.
- XDISC** Replacement disc for DA5513 & DA5526
- XPAD** Replacement pads for DA5513 & DA5526

**Series**

This will fit any Land Rover fitted with a standard Series transfer box, including those fitted with PTO's, under or overdrive units. The new brake replaces the original transmission brake drum. It is supplied with a new adjustable actuator rod which connects from your original handbrake lever, direct to the caliper, reducing the amount of slack in the linkages. The disc transmission brake uses an industrial open-frame caliper with simple adjustment and easy cleaning. The new caliper is mounted on a laser cut steel back-plate with a folded gusset for added strength and incorporating a built in skid plate to protect the disc which is manufactured from robust 10mm thick mild steel plate and which bolts directly to your original gearbox output flange with six new bolts (supplied). The system is very light weight, offering a saving of almost 10kg compared to an original drum brake.

**BEEF UP YOUR  
HANDBRAKE!**

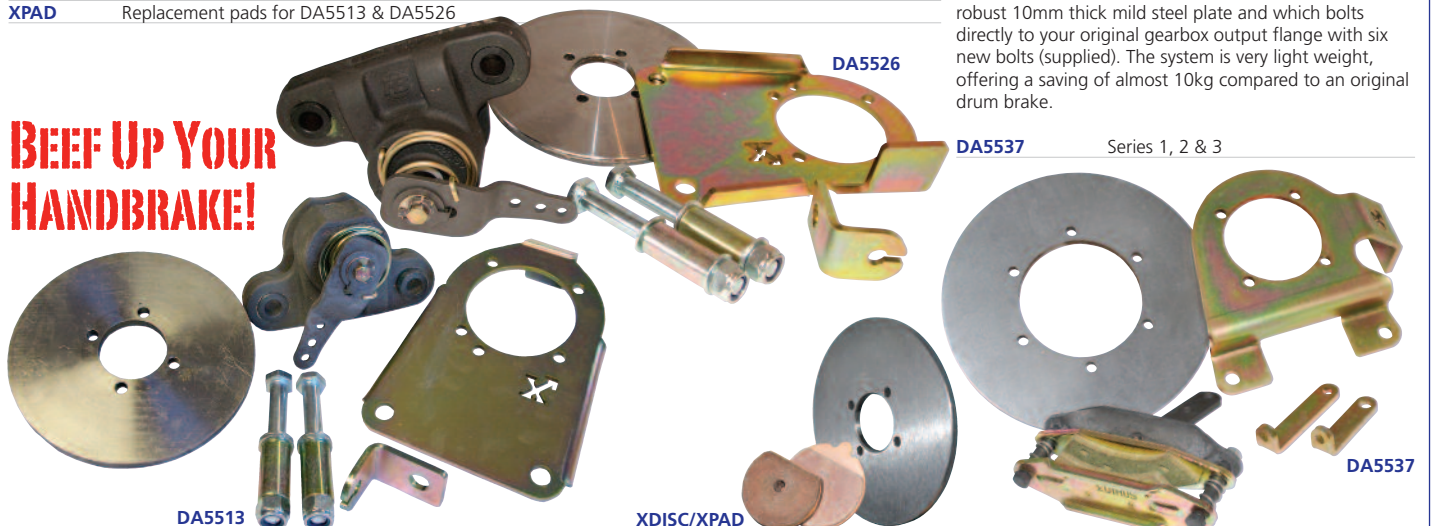

## Engine

### E.G.R. Blanking Kits & Tubes

A Britpart EGR (exhaust gas recirculation) blanking kit enables you to remove the original mechanical EGR from the vehicle resulting in better fuel economy and improved performance.

<b>DA1108</b>	Defender - 300Tdi engine Discovery 1 - 300Tdi engine Range Rover Classic - 300Tdi engine	
<b>DA1109</b>	Defender - Td5 engine Discovery 2 - Td5 engine	
<b>DA1112</b>	Discovery 3 - TdV6 up to 7A (not EU4) engine Range Rover Sport - TdV6 up to 7A (not EU4) engine	<b>DA1087/DA1088</b>
<b>DA1088</b>	Range Rover L322 - Td6 engine - tube only	
<b>DA1087</b>	Freelander 1 - Td4 engine - tube only	

better fuel economy



DA1108

DA1112

DA1109

improved performance



DA1108



DA1109

### Filter Guards

*Britpart Filter Guard removes potential engine damaging metal particles from your oil.*

**Clean oil works better than dirty oil with reduced friction and less wear.**

Britpart's Filter Guard is an inexpensive way of removing the harmful contaminants that conventional oil filters can miss. The contaminants are fine metal particles which act like an abrasive on the fast moving parts in your vehicle's engine - dramatically shortening engine life.

Filter Guard works by magnetic filtration technology resulting in cleaner oil which your engine will thank you for by running better now and in years to come. The Filter Guard will never clog or restrict the all important oil flow.

**Note** - Filter not included with Filter Guard  
**DA6081**



Improves fuel economy!

- Improves fuel economy
- Extends engine life
- No vehicle modification needed
- Added protection for stop & go driving and towing
- Cleans engine oil for 50,000 miles/80,000kms
- Does not effect your Land Rover's warranty

Added protection for your engine!

Part Number	Filter Guard (Diameter x height)	Thread/Insert
<b>DA6080</b>	95mm x 30mm	3/4" x 16
Fits filters - AEU2218L & ERR3340 Defender/Discovery 1/Discovery 2/Range Rover Classic/Range Rover P38		
<b>DA6081</b>	95mm x 30mm	13/16" x 16
Fits filter - RTC3186 Range Rover Classic		
<b>DA6082</b>	77mm x 30mm	13/16" x 16
Fits filters - LPW100180L, LPW100230, STC974 & CDU1268 Discovery 1/Freelander 1		
<b>DA6084</b>	77mm x 30mm	1.0" x 12
Fits filter - LR007160 Discovery 3/Range Rover Sport - 2005 - 2009/Range Rover L322		

**Important** - Please check that there is sufficient room for the addition of the filter guard.

### E.G.R. Blanking & Silicone Hose Kits



**DA1108TDI**  
Defender - 300Tdi engine  
Discovery 1 - 300Tdi engine  
Range Rover Classic - 300Tdi engine

**DA1109DEF**  
Defender - Td5 engine

**A full range of silicone hoses can be found in this section.**



**DA1109DIS**  
Discovery 2 - Td5 engine

**DA1087FL**  
Freelander 1 - Td4 engine



Photograph courtesy of Captain Philip Pearce-Smith MBE

**Air Filters - Britpart Performance**

Britpart Part No.	Corresponds To		
<b>Series 3</b>			
DA3138		4-cylinder - fits Zenith and Weber carbs	
DA4274	605191	LWB - 3.5 V8 - 2 filters required	1979 - 1982
<b>Defender - 90/110/130</b>			
DA4269	NRC9238	2.5 petrol	1983 - 1990
DA4269	NRC9238	2.5 D & Td	1983 - 1990
DA4270	NTC6660	2.5 200Tdi	1990 - 1993
DA4262	NTC1435	2.5 300Tdi	1994 - 1997
DA4262	ESR2623	2.5 300Tdi	1994 - 1997
DA4260	ESR4238	Td5	1999 - 2007
DA4379	PHE500060	Puma	2007 -
<b>Discovery 1</b>			
DA4274	605191	3.5 V8 carb - 2 filters required	1989 - 1990
DA4262	NTC1435	2.5 200Tdi	1989 - 1992
DA4262	ESR2623	2.5 200Tdi	1989 - 1992
DA4268	RTC4683	3.5i V8 Efi	1990 - 1993
DA4264	ESR1049	2.5 200Tdi	1992 - 1994
DA4261	ESR1445	2.0i Mpi petrol	
DA4261	ESR1445	2.5 300Tdi	1994 - 1997
DA4261	ESR1445	3.9i V8	1994 - 1997
<b>Discovery 2</b>			
DA4260	ESR4238	Td5	1999 - 2004
DA4260	ESR4238	4.0i	1999 - 2004
<b>Discovery 3</b>			
DA3139	PHE000112	2.7 V6 diesel, 4.0 V6 petrol & 4.4 V8 petrol	
<b>Discovery 4</b>			
DA3139	PHE000112	2.7 V6 diesel, 3.0 V6 diesel & 4.0 V6 petrol	
DA4376	LR011593	5.0 V8 - nat. asp.	
<b>Discovery Sport</b>			
DA4637 NEW	LR029078	2.0 petrol & 2.2 diesel	
<b>Freelander 1</b>			
DA4267	ESR4103	1.8 16v	1997 - 2000
DA4267	ESR4103	2.0i Tcie diesel (Rover engine)	1997 - 2000
DA4263	PHE100500L	2.0 Td4 (BMW engine)	2001 - 2006
DA4260	ESR4238	V6 petrol	
<b>Freelander 2</b>			
DA4375	LR005816	Petrol & diesel	
DA4637 NEW	LR029078	from CH000001 - 2.0 petrol	

Britpart Part No.	Corresponds To		
<b>Range Rover Classic</b>			
DA4274	605191	3.5 V8 carb - 2 filters required	1972 - 1986
DA4272		3.5 carb V8 - cone type off-road extreme power filter	
		2 filters required	
DA4266		3.5 carb V8 - cone type - replaces 605191	
		2 filters required	
DA4268	RTC4683	3.5i V8 Efi	1985 - 1989
DA4262	NTC1435	2.4D VM Turbo	1986 - 1992
DA4262	ESR2623	2.4D VM Turbo	1986 - 1992
DA4262	NTC1435	2.5D VM Turbo	1986 - 1992
DA4262	ESR2623	2.5D VM Turbo	1986 - 1992
DA4268	RTC4683	3.9i	1989 - 1994
DA4265	ESR341	4.0i V8	1990 - 1995
DA4265	ESR341	4.2i V8	1990 - 1995
DA4265	ESR341	4.6i V8	1990 - 1995
DA4264	ESR1049	2.5 200Tdi	1991 - 1993
DA4261	ESR1445	2.5 300Tdi	1993 - 1995
DA4261	ESR1445	3.9i V8 Efi	1992 - 1994
<b>Range Rover P38</b>			
DA4265	ESR341	Diesel up to TA346793	
DA4265	ESR341	Petrol up to TA346793	
DA4260	ESR4238	Diesel from TA346794 up to VA376579	
DA4260	ESR4238	Petrol from VA346794 up to VA376579	
DA4260	ESR4238	Diesel from WA376580	
DA4260	ESR4238	Petrol from WA385949 up to WA410481	
DA4265	ESR341	Petrol from WA376580 up to WA385948	
DA4260	ESR4238	Petrol from XA410482	
<b>Range Rover Sport</b>			
DA3139	PHE000112	2.7 V6 diesel, 4.0 V6 petrol & 4.4 V8 petrol	2005 - 2013
DA4376	LR011593	5.0 V8 nat. asp. & supercharged	2010 - 2013 2014 -
<b>Range Rover L322</b>			
DA4378	PHE000050	4.4 V8 (BMW engine)	2002 - 2005
DA4377	PHE500021	4.4 V8 nat. asp.	2006 - 2009
DA4377	PHE500021	4.2 V8 supercharged	2006 - 2009
DA4377	PHE500021	3.6 Td8	2007 - 2009
DA4259	PHE000040	Td6	2002 - 2009
DA4376	LR011593	4.4 Td8	2010 - 2012
DA4376	LR011593	5.0 V8 nat. asp. & supercharged	2010 - 2012
<b>Range Rover Evoque</b>			
DA4637 NEW	LR029078	2.0 petrol & 2.2 diesel	

A breath of **fresh air** for your Land Rover

"breathing efficiency for your engine means more power or better fuel mileage"



To see an image of each filter go to [britpart.com/filters](http://britpart.com/filters)

- A range of performance filters tailored to fit your Land Rover.
- Maximum breathing efficiency for your engine means more power or better fuel mileage.
- No compromise on quality - the engine gets more air but the dirt particles are trapped by the quality filters.
- No need to replace as easy cleaning means maximum performance guaranteed.
- Easy fit, directly replaces standard air filter.
- Ideal for use in hot dusty conditions to reduce engine wear.
- Compatible with snorkels, ideal for use in conjunction with other performance modifications.
- Filters don't need pre-oiling and if the filter gets dirty there is no need to use a cleaner to clear the dirt on the filter - just use air, water or detergent.



## Air Filters - K&N



- Designed to increase horsepower and acceleration.
- Washable and reusable.
- Easy high performance add-on.



DA4273	Range Rover Classic - 3.9i Efi 1989 - 1992		Cone type, includes hose & fixing kit
DA4375KN	Freelander 2	LR005816	Petrol & diesel
DA4376KN	Discovery 4	LR011593	5.0 V8 - nat. asp.
	Range Rover Sport		5.0 V8 nat. asp. & s. charged - 2010 - 2013 & 2014 - 4.4 Td8 - 2010 - 2012
	Range Rover L322		5.0 V8 nat. asp. & s.charged
DA4377KN	Range Rover L322	PHE500021	4.4 V8 nat. asp. - 2006 - 2009
			4.2 V8 supercharged - 2006 - 2009
			3.6 Td8 - 2007 - 2009
DA4378KN	Range Rover L322	PHE000050	4.4 V8 (BMW engine) - 2002 - 2005
DA4275	K&N Dirt retention lubricating oil		200ml aerosol
DA3136	K&N Cleaning solution		1ltr bottle
DA3137	K&N Cleaning kit		200ml cleaning fluid & 200ml lubricating oil



## Intercoolers - Performance

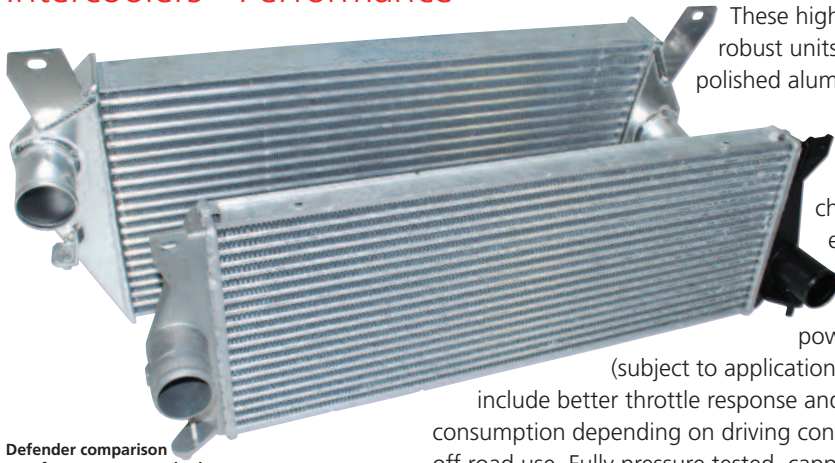

These high performance and robust units are constructed from polished aluminium and are 30% larger than the standard intercooler. As a result air has a chance to cool before entering the engine.

This cooler air can increase engine power by up to 25bhp

(subject to application). Other benefits include better throttle response and reduction in fuel consumption depending on driving conditions. Ideal for on or off road use. Fully pressure tested, capped and sealed.



You can now find all the latest Britpart news on Facebook!

[facebook.com/britpart](https://www.facebook.com/britpart)

Defender comparison - performance vs standard

DA4630	Defender 90/110 - Td5 - 1998 - 2006 inc. air-con vehicles	60mm deep x 300mm high
DA4634	Defender 90/110 - 2007 onwards inc. air-con vehicles	60mm deep x 300mm high
DA4631	Discovery 2 - Td5 - automatic/manual with transmission oil cooler - 1999 - 2004	60mm deep x 235mm high
DA4632	Discovery 2 - Td5 - manual without transmission oil cooler - 1999 - 2004	60mm deep x 300mm high
DA4633	Range Rover P38 - DSE	60mm deep x 280mm high

Note - Dimensions for main intercooler body only. If you have a winch fitted please check clearance before fitment.

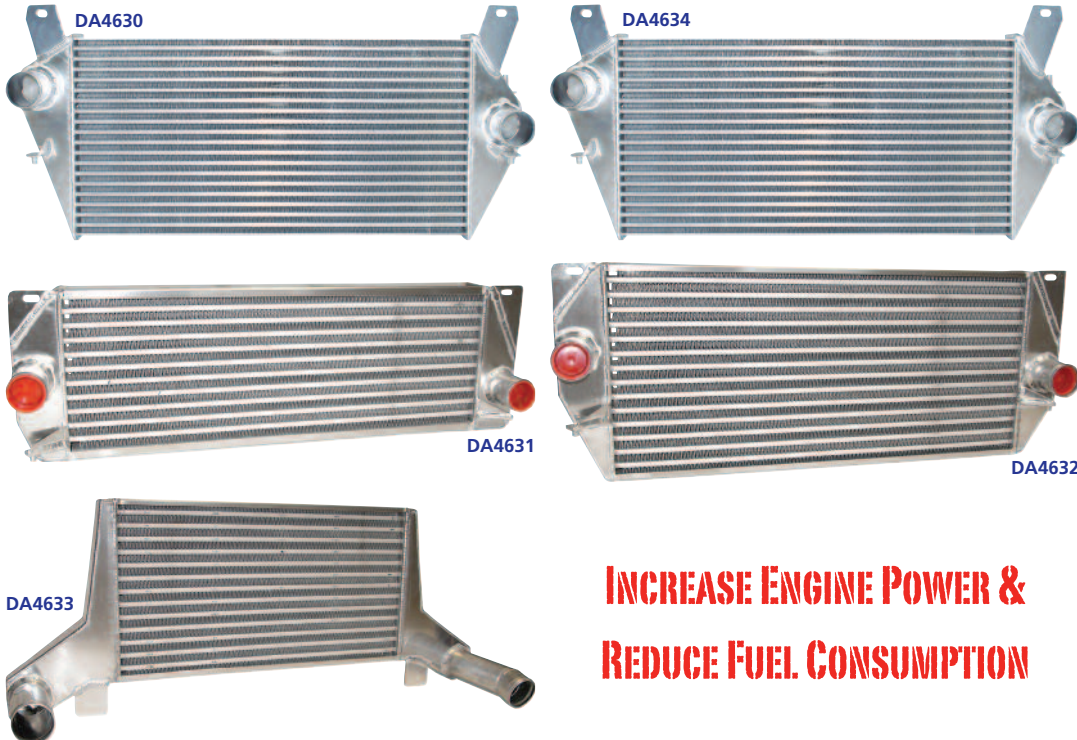

**DA4635**  
Discovery 3 - 2.7 TdV6  
Range Rover Sport - 2.7 TdV6  
The original Land Rover intercooler design can have problems due to the blocking up of the core with mud when the vehicles are used off road, as the intercooler is mounted at the lowest point in the front of the vehicle. This intercooler is designed to be easier to clean and less prone to blockage due to the courser, less dense fin design whilst dramatically improving flow, performance and economy, even without any further tuning. Tests have shown a minimum improvement in fuel economy of 12-15%. Power and throttle response in the lower and mid-range engine revs particularly are noticeably improved. The intercooler is designed to be simple to install without major modifications to the vehicle. The performance intercooler makes full use of the space available behind the bumper. It is designed with an integral fan cowl extension to ensure no loss of cooling efficiency and is supplied with mounting brackets and fitting guide.



**INCREASE ENGINE POWER & REDUCE FUEL CONSUMPTION**

**Silicone Turbo Hoses**

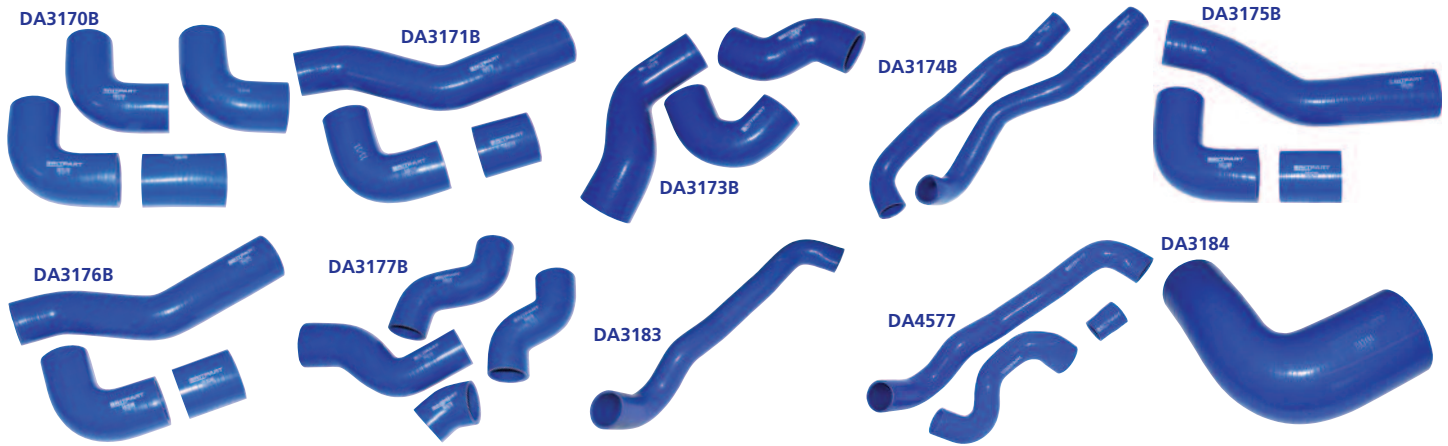

**Britpart Silicone Hoses**

- Quality silicone hoses are designed to operate at a higher temperature than the original hoses.
- Will not rot or perish like rubber hoses.
- Fit with both standard and performance intercoolers.

**WILL NOT ROT OR PERISH!**

<b>DA3170B</b>	Defender - 200Tdi	4 piece kit	Intercooler hose kit
<b>DA3171B</b>	Defender - 300Tdi	3 piece kit	Intercooler hose kit
<b>DA3173B</b>	Defender - Td5	3 piece kit	Intercooler hose kit
<b>DA3174B</b>	Defender - 2.4Tdc	2 piece kit	Intercooler hose kit
<b>DA3175B</b>	Discovery 1 - 200Tdi	3 piece kit	Intercooler hose kit
<b>DA3176B</b>	Discovery 1 - 300Tdi	3 piece kit	Intercooler hose kit
<b>Note</b> - Remove EGR valve and pipe			
<b>DA3177B</b>	Discovery 2 - Td5	4 piece kit	Intercooler hose kit
<b>DA3183</b>	Discovery 3/Discovery 4/Range Rover Sport - 2.7 TdV6	1 piece	Intercooler to duct hose (PNH500025)
<b>DA4577</b>	Discovery 3/Discovery 4/Range Rover Sport - 2.7 TdV6	3 piece kit	Intercooler hose kit
<b>DA3184</b>	Freelander 1 - Td4	1 piece	Intercooler to turbo hose (PNH101811)
<b>DA3182B</b>	Freelander 1 - Td4	2 piece kit	Intercooler hose kit
<b>DA4582</b>	Freelander 1 - Td4	3 piece kit	Intercooler hose kit



## PSI Power Tuning Products



DA4419

The Power Box houses a digital microprocessor which intercepts the fuelling signals being transmitted from the ECU to the fuel pump; it then modifies them to ensure the exact amount of diesel required for enhanced performance. Such efficient use of the fuel optimises consumption, reduces smoke emissions and there is less engine stress, enhancing engine life in many cases.

The Power Box improves torque enabling the vehicle to change gears earlier and hold higher gears at lower speeds, making driving more pleasurable.

The unit fits using the original manufacturers plugs; these existing plugs are opened and the Power Box is secured in between. Full fitting instructions are included with every unit.

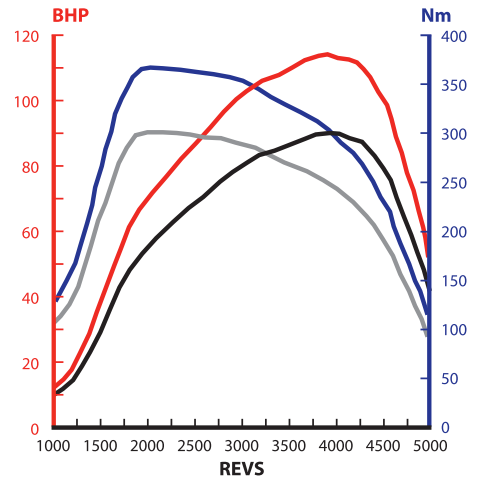

Performances for Defender Td5:

Standard: 121 HP 90 Kw 300 Nm  
**PSI: 158 HP 118 Kw 374 Nm**

### Features

- Plug-in unit
- No intervention with the original ECU
- TUV approval
- Compact size
- Shock resistant & waterproof
- Competitively priced

### Benefits

- Can be removed prior to sale or used as a selling point
- Traceless
- Peace of mind
- Quality product which is legal & safe
- Unobtrusive in interior of vehicle
- No worries off road
- A good investment

### Performance improvement - (before / after)

			Power - HP	Power - Kw	Torque - Nm
<b>DA4418</b>	Freelander 1 - Td4	2000 - 2006	110 / <b>135</b>	82 / <b>101</b>	260 / <b>309</b>
<b>DA4419</b>	Range Rover P38 - 2.5Td	1995 - 1999	134 / <b>162</b>	100 / <b>121</b>	268 / <b>319</b>
<b>DA4420</b>	Range Rover P38 - 2.5Td	2000 - 2001	134 / <b>162</b>	100 / <b>121</b>	268 / <b>319</b>
<b>DA4421</b>	Range Rover L322 - Td6	2002 onwards	175 / <b>204</b>	130 / <b>152</b>	390 / <b>449</b>
<b>DA4433</b>	Defender/Discovery 2 - Td5	1999 - 2007	121 / <b>158</b>	90 / <b>118</b>	300 / <b>374</b>
<b>DA4436</b>	Defender - 2.4TdcI	2007-2011	121 / <b>153</b>	90 / <b>114</b>	360 / <b>424</b>
<b>Note</b> - Will not override speed restrictor					
<b>DA4434</b>	Discovery 3/Range Rover Sport - 2.7 TdV6		188 / <b>220</b>	140 / <b>164</b>	440 / <b>519</b>
<b>DA4435</b>	Discovery 4/Range Rover Sport - 3.0 TdV6		252 / <b>286</b>	188 / <b>213</b>	600 / <b>677</b>

Improves **torque**

Improves **m.p.g**





## Tunit

DA4437

Freelander 2 - 2.2 Td4 - 2007 onwards

**Performance improvement** (before / after)

Power - HP    Power - Kw    Torque - Nm  
152 / **177**    112 / **130**    295 / **325**

**Tunit Diesel Performance** - The Diesel Tunit has been forged from many years of experience to bring a world class unbeatable range of diesel performance solutions.

**Tunit Features** - Tunit possesses many advantageous features not seen in other tuning solutions such as chips, eprom serial reprogramming (flashing) or other types of fixed map devices. It is interchangeable between vehicles and able to be upgraded. External to the ECU or 'Plug and play' as it is often called means no interference with the original manufacturers engine equipment. Its option to adjust power and performance provides easy manual adjustment for the novice or finer electronic alterations for the more dedicated tuner. Tunit is backed up by an outstanding after sales service, part exchange program and class beating three year warranty.

**Fuel Savings** - Tunit has become advantageous in reducing fuel costs for a variety of applications; not just improving performance but now helping with saving fuel costs.

**Installation** - The Tunit is normally connected to original plugs on the vehicle and can either be self-installed or by a professional mechanic.



Photograph courtesy of Sean Lannan

## Turbo Boost Box

DA4667

The Td5 engine fitted in Defenders and Discovery's is one of the most 'tuneable' engines available and it responds well to modifications including a PSI power tune box, larger intercooler, EGR removal kit and decat pipes. However the turbo will only boost to 14.7psi in standard form and this will quickly limit the potential from the modifications you have made. The ECU will cut fuel to the engine if it detects an over boosting situation, but there is a solution.

**Turbo Boost Box!** This intelligent box allows the Td5 engine to run with a higher boost pressure after adjusting the waste gate in accordance with the instructions. This allows increase turbo boost pressure without the engine going into limp home mode. You will feel the benefits of fitting the Turbo Boost Box as soon as you drive. At the lower rpm's the vehicle will feel more responsive whilst at the same time giving you a much smoother spread of power through the rpm range. An added benefit is a reduction of exhaust smoke.



*You will feel the benefits of fitting the Turbo Boost Box as soon as you drive!*

Fitting the Turbo Boost Box is an easy 3 wire installation. The box is manufactured from extruded aluminium and easy to fit as it uses the original Land Rover connectors. The box is 99% water resistant - ideal for most off-road uses.

This product must be fitted by a competent mechanic in accordance with the included instructions, incorrect waste gate adjustment can lead to engine damage.

## Upgrade Chip

DA4497 Range Rover P38

Replacement ECU chip to improve power and economy on the GEMS engine 4.0 and 4.6 in the Range Rover P38. Fitting this chip will increase economy by approx 15% and power by 10%. Once fitted, it helps make a big difference to the driveability of the vehicle by improving throttle response and mid-range pull.

### Accelerate technology

Limitations and restrictions exist which prevent your vehicle from achieving optimal performance. The manufacturer's emissions test is extremely rigorous due to inclusion of all parts of the driving cycle, especially warm up and full load operation, which is where problem emissions are at a maximum. To meet these they compromise performance and efficiency of the engine - this chip helps redress that balance.

### Off roaders in the driving seat

Your requirements are met through a stable and predictable idle quality, good engine braking and an engine which has plenty of midrange torque. Perfect idle control for hill descents and winching, with no possibility of stalling. Total reliability ensures you never lose control.

### Greater expectations

By comparison we know climate conditions and fuel quality your vehicle experiences and can therefore improve efficiency by reducing fuel consumption and optimising the engine to get its best performance on full load, which is less than 10% of the time.



No trade off between fuel economy and increased power!

## Weber Carburettors



DA3049

V8 4-Barrel conversion kit including manifold

The Weber 4 barrel replacement carburettor kit is a direct replacement for the twin Stromberg or SU carbs fitted to the Rover V8. Calibrated to work perfectly on the 3.5 and 3.9 engines, the Weber kit is the most complete on the market and features a Webcon modified Weber 4 barrel 500cfm carburettor, intake manifold, air filter and every single nut, bolt, washer, gasket and hose that could possibly be needed. The kit adds up to 20bhp at the wheels and transforms the driveability and economy. Starting becomes instant either hot or cold and with no balance adjustment to worry about with twin carbs, the engine is simply superbly smooth as indeed a V8 should be.

DA3049AF Replacement air filter for DA3049

DA3049KD Weber kick down kit for use with DA3049 on automatic vehicles.

DA2126 Series carburettor - to replace Solex use also STC541 adaptor

DA2206 Service kit for DA2126 & ERC2886W

DA2126A Choke cable for DA2126

ERC2886W Series - replacements for the Zenith 361V

Available for LHD, RHD, with or without fuel shut off solenoid, the Weber range of carburettor kits to replace the Zenith 361V offer the optimum balance of power and economy together with the legendary quality and reliability of Weber. Shipped as complete turnkey solutions, all kits are supplied with every nut, bolt, washer and gasket required and comprehensive, easy to follow instructions ensure that installation can be carried out with no specialist carburettor knowledge.

DA4538 Twin choke performance carburettor kit for Land Rover 2.25ltr engines.

The kit is fitted with Webcon's new Sync Link kit allowing synchronous opening of the Weber 32/36 DGV throttle butterflies. This greatly enhances low speed driveability and torque, essential for off-road driving. This kit will fit all engines fitted with a tubular exhaust manifold. If the original exhaust manifold is still fitted, a simple 4-hole blanking plate will need to be fabricated to block the aperture left when the OE intake manifold is removed.

DA3049

Part of the conversion kit

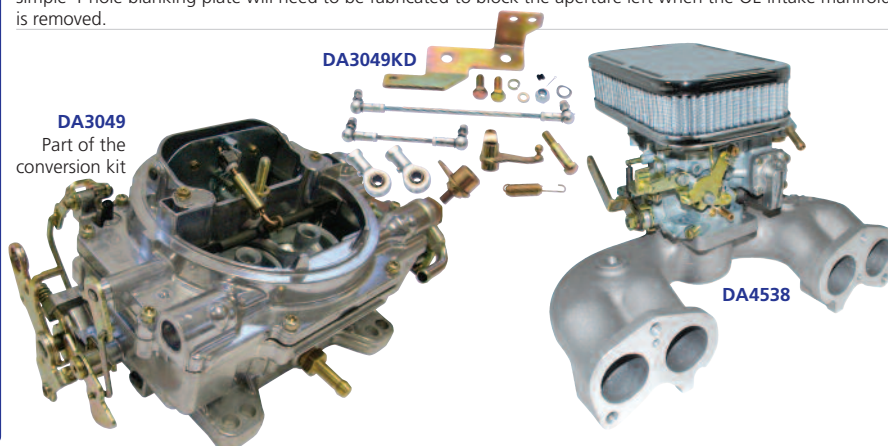

## Exhaust Systems

### Double 'S' Stainless Steel Exhausts

Double 'S' is recognised as one of Europe's leading manufacturers of stainless steel automotive components with a wide selection of systems for off-road.

Using only the finest austenitic and ferritic stainless steels and employing the latest in CNC mandrel and empty tube bending, measuring and inspection equipment, means increasingly high levels of product quality.

All Double 'S' exhaust systems carry a lifetime guarantee. Double 'S' will replace or repair any part of their Stainless Steel Exhaust Systems found defective through corrosion during the period that the system remains the property of the original owner. Provided that the system is inspected by a garage or exhaust fitting centre annually to ensure that the rubber and other mountings are in good condition.



DA4395

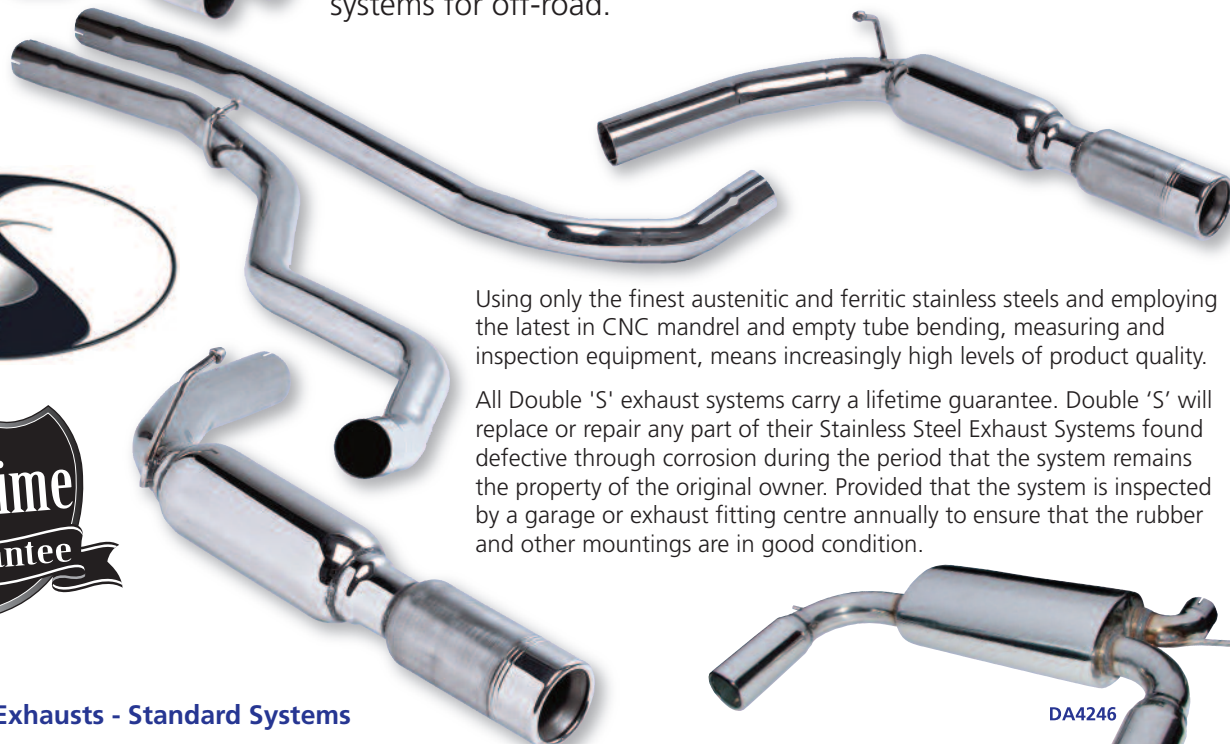

#### Stainless Steel Exhausts - Standard Systems

##### Series

DA4540	Series 1 - 88"		Front pipe / link pipe / rear silencer
DA4251	Series 3 - SWB	2.25 Diesel - 3 stud manifold exit	Front pipe / link pipe / rear silencer
DA4528	Series 3 - SWB	2.25 Petrol	Front pipe / link pipe / rear silencer

##### Defender

DA4231	Defender 90	200Tdi	Front pipe / centre box / rear silencer
DA4232	Defender 90 - 1994 - 1995	300Tdi	Front pipe / centre box / rear silencer
DA4233	Defender 90 - 1995 - 1997	300Tdi	Front pipe / centre box / rear silencer
DA4234	Defender 90 - 1997 - onwards	300Tdi	Centre box / rear silencer
DA4235	Defender 90	Td5	Centre box / rear silencer
DA4244	Defender 110	Td5	Centre box / rear silencer
DA4228	Defender 110	200Tdi	Front pipe / centre box / rear silencer
DA4229	Defender 110	300Tdi	Front pipe / centre box / rear silencer

##### Discovery

DA4221	Discovery 1	2.5Td & 200Tdi Manual	Front pipe / centre box / rear silencer
DA4222	Discovery 1	200Tdi Automatic	Centre box / rear silencer
DA4223	Discovery 1	300Tdi	Centre box / rear silencer
DA4224	Discovery 2	2.5 Td5	Centre box / rear silencer
DA4397	Discovery 3	TdV6	Twin tail exhaust

##### Freelander

DA4226	Freelander 1	1.8 Petrol - up to YA999999	Centre box / rear silencer
DA4246	Freelander 1	1.8 Petrol - up to YA999999	Transplex rear silencer (2 x 3" roll tailpipe)
DA4227	Freelander 1	2.0 Diesel - up to YA999999	Link pipe / rear silencer

##### Range Rover

DA4237	Range Rover Classic - cat & non-cat	3.9 V8 from catalyst to back	Centre box / rear silencer
DA4238	Range Rover P38	2.5 BMW diesel single tailpipe	Centre box / rear silencer
DA4239	Range Rover P38	4.0/4.6 single tailpipe	Centre box / rear silencer
DA4240	Range Rover P38	4.0/4.6 twin tailpipe	Centre box / silencers - rhs & lhs
DA4241	Range Rover P38	2.5 BMW twin tailpipe	Centre box / silencers - rhs & lhs
DA4395	Range Rover Sport	4.2 V8 Supercharged	Centre box / link pipes - rhs & lhs / rear silencers - rhs & lhs



DA4528



DA4233

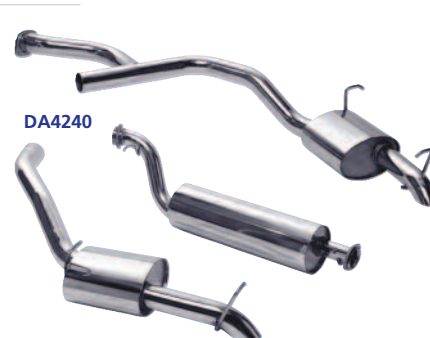

DA4240

Double 'S' Stainless Steel Exhausts - continued

**Stainless Steel Exhausts - Sports Systems**

**Defender**

<b>DA4236</b>	Defender 90	3.5 V8 sports system	Manifolds - rhs & lhs / Y-Pipe / rear silencer / tailpipe / fitting bracket & kit
<b>DA4249</b>	Defender 90	Td5 sports system	Sports centre link pipe / rear silencer
<b>DA4230</b>	Defender 110	3.5 V8 sports system	Manifolds - rhs & lhs / Y-Pipe / extension pipe / centre box / tailpipe / fitting bracket & kit

**Discovery**

<b>DA4225</b>	Discovery 1	3.9 V8 Japanese spec sports system	Centre box / link pipe / rear silencer
---------------	-------------	------------------------------------	----------------------------------------

**Range Rover**

<b>DA4242</b>	Range Rover Classic	3.5 V8 Efi sports system with tubular manifold	Manifolds - rhs & lhs / Y-Pipe / centre box / rear silencer
<b>DA4243</b>	Range Rover Classic	3.9 V8 Efi sports system with tubular manifold	Manifolds - rhs & lhs / Y-Pipe / link pipe / centre box / rear silencer
<b>DA4243EXT</b>	Range Rover Classic	Extension piece for DA4243 for use on long wheel base Range Rover Classic LSE models	
<b>DA4245</b>	Range Rover P38	4.0/4.6 sports system with twin tailpipe	Rear silencers - rhs & lhs / Y-Pipe / centre box
<b>DA4247</b>	Range Rover P38	2.5 diesel sports system with twin tailpipe	Rear silencers - rhs & lhs / Y-Pipe / centre box

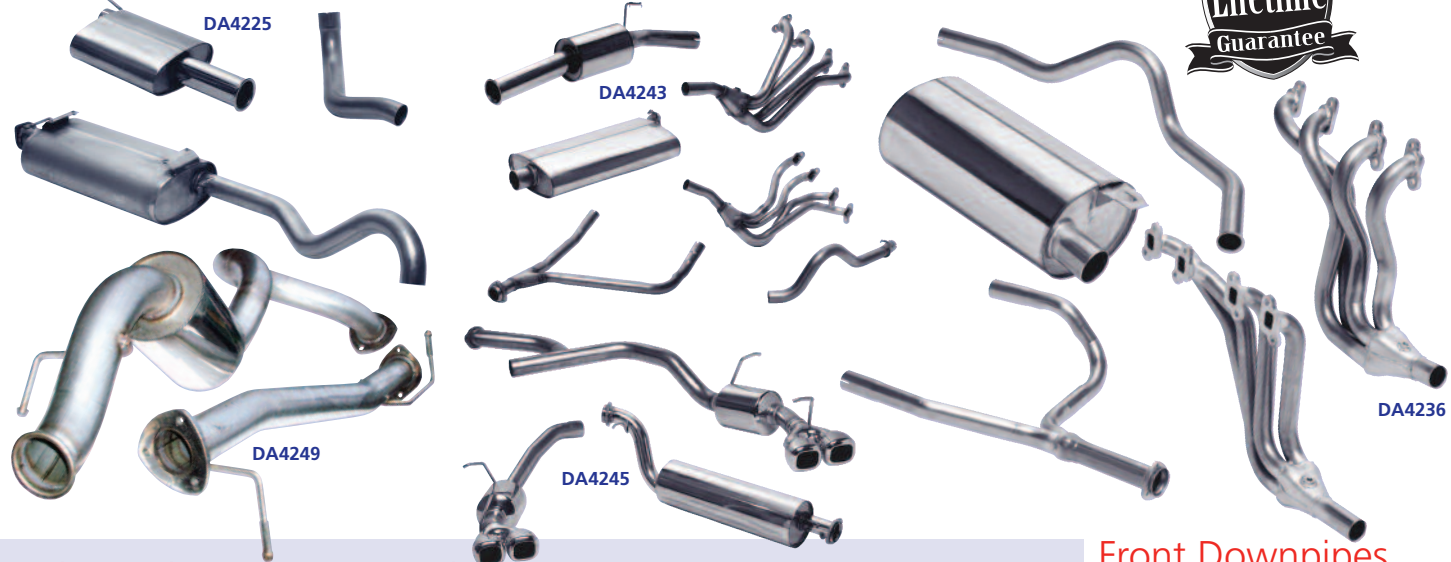

**Utility Link Pipes & Rear Silencers**

**Britpart Link Pipe Part No.**

**Defender**

Part No.	Vehicle	Model
<b>DA4371</b>	Defender 90	2007 onwards
<b>DA4292</b>	Defender 90	Td5
<b>DA4294</b>	Defender 90	300Tdi 1994 - 1995
<b>DA4294</b>	Defender 90	300Tdi 1995 - 1997
<b>DA4304</b>	Defender 90	300Tdi 1997 - 1999
<b>DA4295</b>	Defender 90	200Tdi
<b>DA4372</b>	Defender 110	2007 onwards
<b>DA4293</b>	Defender 110	Td5
<b>DA4302</b>	Defender 110	300Tdi
<b>DA4306</b>	Defender 110	200Tdi

**Discovery**

<b>DA4291</b>	Discovery 1	300Tdi
<b>Note</b> - Will only fit with Double 'S' rear silencer (DA3258)		
<b>DA4303</b>	Discovery 1	200Tdi
<b>DA4290</b>	Discovery 2	Td5

**Sport system kits**

<b>DA42235</b>	Discovery 1	300Tdi
<b>Note</b> - Kit includes Double 'S' rear silencer (DA3258)		
<b>ESR23915</b>	Discovery 1	300Tdi
<b>Note</b> - Not stainless steel		

**Freelander**

<b>DA4537</b>	Freelander 1	Td4	Rear silencer
---------------	--------------	-----	---------------

**Double 'S' Rear silencer Part No.**

These are stainless steel exhaust silencer replacement pipes. They are designed to directly replace the front silencer in your exhaust system.

Once replaced the pipe will give your vehicle more power or reduced fuel consumption with only a small increase in cabin noise. CNC mandrel formed for a perfect fit with laser cut flanges, the pipes have a sateen finish, deep lustre appearance. Quick and easy to install.



**Front Downpipes**

**DA3262**

Defender 300Tdi - downpipe less cat  
Equivalent to ESR2297

**DA4348**

Defender 90 - Equivalent to WCD000960  
Discovery 2 - Equivalent to WCD000500  
Td5 - downpipe less cat - mild steel

**DA4359**

Defender 90 - 2.4 EU4  
2007 onwards - downpipe less cat  
Equivalent to LR020683

**ESR2740**

Discovery 1  
Range Rover Classic  
300Tdi - downpipe less cat  
Equivalent to ESR2440

**DA4396**

Discovery 3  
TdV6 - downpipe less cat  
Equivalent to WCD500433  
**Note** - Fitting downpipe may then require vehicle needing engine re-map by a specialist.

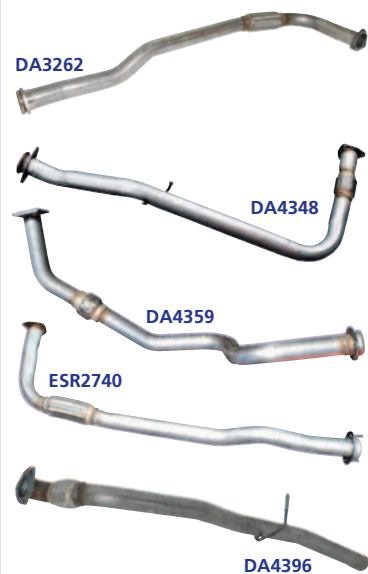

**Reduced fuel consumption**

**Quick and easy to install with more power**

For more images visit [www.britpart.com/pipes](http://www.britpart.com/pipes)

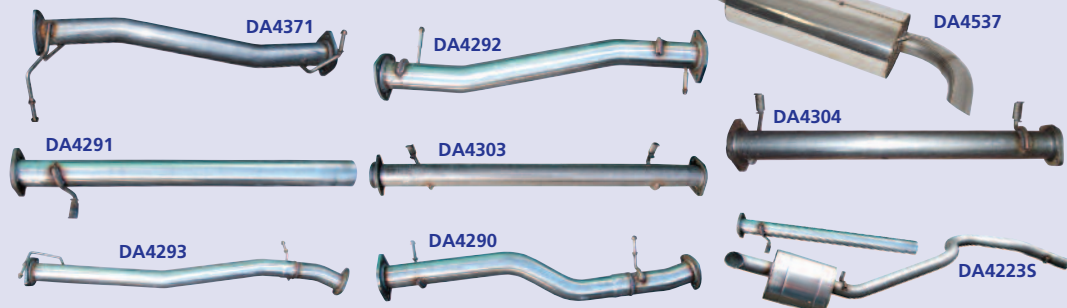

## Stainless Steel Exhaust **NEW**

DA3340

Discovery 4 - 3 litre diesel with DPF

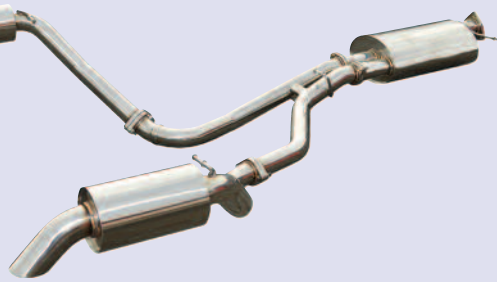

## Section contents

<b>Air suspension compressors</b>	<b>116</b>	Bush sets - Britpart	<b>114</b>
<b>Air suspension control</b>	<b>119</b>	Bush sets - Britpart polyurethane	<b>115</b>
<b>Axle</b>		Bush sets - Polybush	<b>114</b>
Anti-roll bar kits	<b>110</b>	<b>Propshafts</b>	
Bush kits	<b>111</b>	Propshaft kit	<b>123</b>
Castor corrected swivel housings	<b>111</b>	Propshaft spacer kit	<b>123</b>
Front suspension arm & bolt kits	<b>111</b>	Wide angle propshafts	<b>123</b>
Fulcrum brackets	<b>110</b>	<b>Shock absorbers</b>	
Heavy-duty drive flanges	<b>110</b>	Britpart Cellular Dynamic	<b>117</b>
Panhard rods	<b>110</b>	Britpart heavy-duty	<b>119</b>
Radius arms	<b>111</b>	Britpart Super Gaz	<b>118</b>
Suspension bolt kits	<b>111</b>	Britpart XD Remote Reservoir	<b>116</b>
<b>Brackets, mounts &amp; ancillary products</b>		Delphi De Carbon	<b>119</b>
Adjustable ball joint	<b>112</b>	<b>Springs</b>	
Dislocation cones	<b>112</b>	Air lift kits	<b>119</b>
Lift rod kit	<b>113</b>	Air spring conversion kits	<b>120</b>
Rear spring seats	<b>113</b>	Leaf spring castor correction wedges	<b>121</b>
Shock absorber brackets & turrets	<b>112</b>	Springs - air	<b>121</b>
Spring retainers	<b>112</b>	Springs - coil	<b>122</b>
Spring spacer blocks	<b>112</b>	Springs - leaf	<b>121</b>
Turret rings	<b>112</b>	Springs - lowered coil	<b>121</b>
<b>Bushes</b>		Springs - parabolic	<b>121</b>
Bump stops	<b>113</b>	XD handling kit	<b>121</b>
Bush fitting tool	<b>114</b>	<b>Steering</b>	
Bush set - Watts linkage	<b>114</b>	Steering arms - heavy-duty	<b>123</b>
		Steering dampers	<b>123</b>
		<b>Suspension kits</b>	<b>124</b>
		<b>Shock absorber &amp; suspension kits matrix</b>	<b>125</b>

“Firm up your ride with some new shock absorbers & springs or raise your game with a lifted suspension kit. Britpart have plenty of suspension upgrade options depending on how you use your Land Rover.”

suspension & axle equipment

## Axle Anti-Roll Bar Kits

Stiffen up your vehicle!

Front and rear kits complete with fitting instructions. Only suitable for vehicles with the chassis and axle brackets fitted.

**STC8156AA**  
Defender 90, 110 & 130/Discovery 1/Range Rover Classic  
Black anti-roll bar kit with rubber bushes

**STC8156APY**  
Defender 90, 110 & 130/Discovery 1/Range Rover Classic  
Yellow anti-roll bar kit with Britpart yellow polyurethane bushes

**Note** - To fit these anti-roll bars to the rear of a Defender 90 Td5 - onwards 2 x EGP1661L & 2 x EGP1889 are required  
Defender 110/130 Td5 - onwards 2 x NRC5674 & 2 x 592773 are required

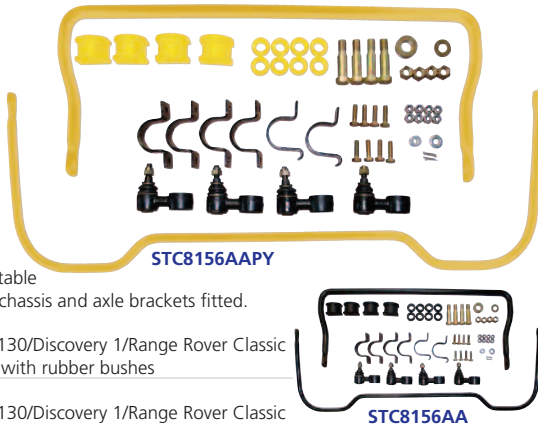

## Panhard Rods

If your Land Rover has raised suspension it is wise to use an adjustable panhard rod to correct the axle position which will in turn maintain and restore the steering geometry.



**DA1130**  
Defender  
Td5 & 2007 onwards  
**RBX101340PY** or  
**RBX101340YELLOW**  
Polyurethane bushes to fit DA1130

**DA1110**  
Defender - up to 2002  
Discovery 1  
Range Rover Classic  
Complete with yellow polyurethane bush set

## Fulcrum Brackets

Fulcrum brackets  
Defender/Discovery 1/Range Rover Classic  
**DA1129**  
With ball joint assembly (ANR1799)  
**DA1129G**  
With OEM ball joint assembly (ANR1799G)  
**DA1129ADJ**  
With adjustable ball joint assembly (ANR1799A)  
**DA1129KIT NEW**  
Fitting kit for all fulcrum brackets



**DA1129KIT**  
**NEW**  
**DA1129ULTRA**  
Fulcrum bracket with high articulation  
Defender/Discovery 1/Range Rover Classic

One of the major factors limiting the rear suspension movement on vehicles fitted with an A-frame is the standard ball joint. We have developed this part to provide significantly more articulation than the standard and most aftermarket joints. Others claim more articulation yet in reality they offer very little over the standard 30°. This exclusive ball joint offers 45° movement in all directions. It is easily adjustable with a regular hex spanner and has a grease nipple for convenient regular maintenance. It is supplied fitted ready to bolt to your Land Rover.

## Heavy-Duty Drive Flanges



These heavy-duty drive flange kits have been engineered to outperform many of the inferior products available on the market. Manufactured from 5140 steel to they are much stronger than an OE drive flange. Complete with hex head bolts and screw on caps with integral seal.

<b>DA1148</b>	Defender - from LA/Discovery 1 - from JA Range Rover Classic - ABS and front from JA	Pair
<b>DA1149</b>	Defender - up to KA	Pair
<b>DA1148CAP</b>	Replacement drive flange cap with rubber seal for DA1148 & DA1149	Single
<b>DA1128</b>	Replacement drive flange bolt set for DA1148 & DA1149	Qty 10

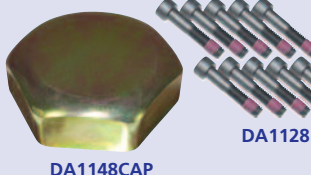

**Radius Arms**

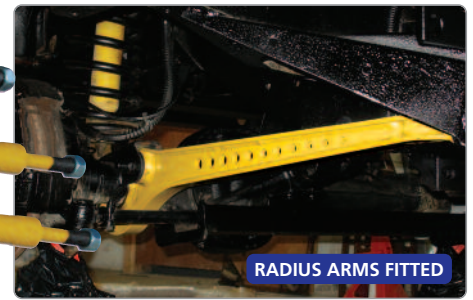

- Designed for Defender/Discovery 1/Range Rover Classic with an extended 1 to 3" lift.
- Front radius arms correct castor alignment which in turn ensures safe driving.
- Rear radius arms provide full rear axle articulation.
- Fitting the radius arms will contribute to much better off-road capability for your vehicle by fully utilising your spring and shock absorber set.
- Zinc passivated with a yellow heavy-duty powder coating finish to complement each component and the Britpart coil springs.

<b>DA5505</b>	3° Heavy-duty	Narrow	Use with NTC7307 & DA2353 bushes	38mm
<b>DA5506</b>	3° Heavy-duty	Wide	Use with NTC6781 & DA2353 bushes	45mm
<b>DA5510</b>	2" Lift rear radius arm			



See the end of this section for full details

**Bush Kits NEW**



<b>DA1242 NEW</b>	Range Rover Classic - up to 1985	Front bush kit
<b>DA1243 NEW</b>	Range Rover Classic - up to 1985	Rear bush kit
<b>DA1244 NEW</b>	Defender - up to KA	Front bush kit
<b>DA1245 NEW</b>	Defender - from LA up to VA130784/Range Rover Classic - from 1986 onwards	Front bush kit
<b>DA1246 NEW</b>	Defender - from VA130785 up to 2A626645	Front bush kit
<b>DA1247 NEW</b>	Defender - from 2A626646 onwards	Front bush kit
<b>DA1248 NEW</b>	Defender to 9A768936/Discovery 1/Range Rover Classic from 1986 on	Rear bush kit
<b>DA1249 NEW</b>	Defender from 9A768937	Rear bush kit

Front bush kits include bushes for radius arms and panhard rods. Rear bush kits include bushes for top & bottom links.

**Suspension Bolt Kits**



<b>DA7202</b>	Defender - up to KA930455	Front suspension
<b>DA7200</b>	Defender - LA930456 to WA159806	Front suspension
<b>DA7203</b>	Defender - XA159807 to 2A626645	Front suspension
<b>DA7204</b>	Defender - 2A625546 onwards	Front suspension
<b>DA7201</b>	Defender - up to YA185790	Rear suspension
<b>DA7208</b>	Defender - YA185791 onwards	Rear suspension
<b>DA7205</b>	Discovery 3/Discovery 4/Range Rover Sport - 2005 - 2012	Front lower Suspension arm
<b>DA7207</b>	Discovery 3/Discovery 4/Range Rover Sport - 2005 - 2012	Rear upper Suspension arm
<b>DA7206</b>	Discovery 3/Discovery 4/Range Rover Sport - 2005 - 2012	Rear lower Suspension arm

**Castor Corrected Swivel Housings NEW**

**DA3203 NEW**  
Defender - from LA up to WA  
Normally the only way to correct the castor angle on a beam axle vehicle is to fit castor corrected radius arms or go through the lengthy process of repositioning the brackets on the axle. Something which takes considerable time and skill.

Britpart offer you an alternative. These castor corrected swivel housings come as a handed pair. They are a direct replacement for vehicles normally using the FRC7065 swivel housing but they have the mounting holes positioned to give 3 degrees of additional castor.



The swivel housings are from the OEM supplier and then machined to our specification.

Kit contents - Swivel housings; swivel pin bearings; gaskets; seals; plates; shims; joint washers; swivel pin uppers - non-ABS & swivel housing grease sachets.

**Front Suspension Arm & Bolt Kits**

Have all the parts you need with one easy part number when you have to change a front suspension arm. Kit contains suspension arm and bolts.\*

Britpart Kit	OEM Kit	No Bushes or bolts*		
<b>LR028245K</b>	<b>LR028245GK</b>	<b>LR028245NB NEW</b>	Discovery 3	RHS
<b>LR028249K</b>	<b>LR028249GK</b>	<b>LR028249NB NEW</b>	Discovery 3	LHS
<b>LR025610K</b>	<b>LR025610GK</b>		Discovery 4	RHS
<b>LR025613K</b>	<b>LR025613GK</b>		Discovery 4	LHS
<b>LR029303K</b>	<b>LR029303GK</b>		Range Rover Sport - 2005 - 2009	RHS
<b>LR029304K</b>	<b>LR029304GK</b>		Range Rover Sport - 2005 - 2009	RHS
<b>LR029305K</b>	<b>LR029305GK</b>		Range Rover Sport - 2005 - 2009	LHS
<b>LR029306K</b>	<b>LR029306GK</b>		Range Rover Sport - 2005 - 2009	LHS

\*Supplied with ball joint.



## Brackets, Mounts & Ancillary Products

### Shock Absorber Brackets & Turrets



**DA1164**  
Heavy-duty, plus 30mm, front turrets for Discovery 2. Finished in heavy-duty powder coating. Complete with nuts and bolts.



**DA1186**  
Defender/Discovery 1/Range Rover Classic Galvanised standard height front shock turrets with fitting kit.

*Sometimes off-road conditions can be serious enough to test the standard equipment on your Land Rover...*



Kit includes nuts, bolts & washers



**DA6337**



**DA6322**



**DA6323**



**DA6322L**



**DA6323L**

Sometimes off-road conditions can be serious enough to test the standard equipment on your Land Rover to its maximum. One of the critical components that takes most of the abuse is the suspension system. When using the standard single shock absorber configuration it is not unknown for the shock absorber to break the factory fitted turret mount. These shock absorber turrets from Britpart give you confidence that your vehicles suspension will tackle the terrain you take it through with greater ease.

The single shock absorber turret is manufactured from heavy-duty steel and replaces the existing turret mount which is susceptible to corrosion by allowing a build up of dirt inside which is hard to clean thoroughly. The new design is harder wearing and easier to clean.

The twin shock absorber turret is manufactured from the same quality steel as the single shock absorber turret but allows for the fitment of an additional shock absorber. The benefits of having extra shock absorbers fitted to your Land Rover is that any extreme force encountered is divided between the two shock absorbers for a more comfortable ride for you and your passengers. Using twin shocks is also beneficial when carrying loads both on and off-road as it improves the load carrying ability of the vehicle. An additional benefit is that when changing shock absorbers there is no need to remove the turrets.

**Note** - Rear brackets involve some welding to fit.

<b>DA6322</b>	Defender/Discovery 1/Range Rover Classic*	Twin shock turrets	Front	Standard height
<b>DA6322L</b>	Defender/Discovery 1/Range Rover Classic*	Twin shock turrets	Front	2" Lift
<b>DA6323</b>	Defender/Discovery 1/Range Rover Classic*	Single shock turrets	Front	Standard height
<b>DA6323L</b>	Defender/Discovery 1/Range Rover Classic*	Single shock turrets	Front	2" Lift
<b>DA6324</b>	Defender/Discovery 1/Range Rover Classic*	Twin shock brackets - kit	Rear	
<b>DA6337</b>	Defender/Discovery 1/Range Rover Classic*	Long travel rear shocker absorber mounting kit		

Laser cut, jigged and computer welded with zinc plated and powder coated finish

The standard pin and eye shock absorbers don't have the necessary articulation for extreme off road conditions and the answer is to use pin and pin shock absorbers. If you use our Cellular Dynamic Plus 5 shock absorbers they offer better articulation. To be used in conjunction with DC6000LL. On Defender Td5 the fuel filter must be moved.

**\*Note** - Fitting shock absorber brackets may require some vehicle modification, please ask distributor for full details.

### Spring Retainers

Defender/Discovery 1/Range Rover Classic

In some situations the vehicle's springs can get dislodged from their setting, these heavy-duty spring retainers ensure the springs are kept in the correct position.

**DA2362** Front **DA2363** Rear



**DA2362**

**DA2363**

### Adjustable Ball Joint

**ANR1799A**

Defender/Discovery 1/Range Rover Classic  
An adjustable A-frame ball joint  
Single



### Dislocation Cones

These clever products ensure your springs relocate correctly when using your Land Rover in extreme conditions. Manufactured from stainless steel. Use in conjunction with spring retainers.

**DA2186** Defender 90/Discovery 1  
Rear Pair  
**DA1962** Defender 110  
Rear Pair



**DA2186**

**DA1962**

### Spring Spacer Blocks

**Defender/Discovery 1 & Range Rover Classic**

These 50mm spring spacer blocks are manufactured from 6mm plate with a powder coated finish. The spacers fit between the axle and the spring seats on the front and rear to give you that extra 50mm of lift you need.

**DA6344** Front pair  
**DA6345** Rear pair



**DA6344**

**DA6345**

**Discovery 2**

These 40mm spring spacer blocks are machined from high quality aluminium and anodised deep blue.

**DA6341** Front pair

With this kit you are able to retain the standard springs and shock absorbers. Use in conjunction with DA6342.

**DA6342** Rear pair

This kit enables you to retain your air springs yet give your vehicle the desired 40mm lift. We recommend that this kit be fitted in conjunction with DA6341, DA4198 or DA4199. Please look at the shock absorbers suitable for this vehicle and at 40mm braided brake hoses. Use in conjunction with DA6341.

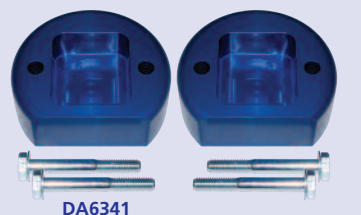

**DA6341**



**DA6342**

### Turret Rings

**DA6338**

Defender  
Discovery 1  
Range Rover Classic

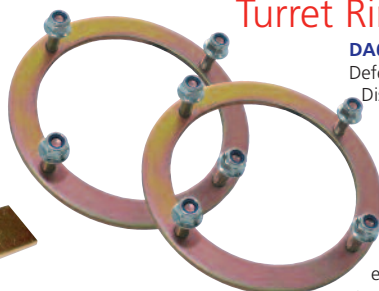

These robust & heavy-duty front shock absorber turret rings are made to replace the existing standard turret rings.



## Lift Rod Kit

### DA7531

Discovery 3/Discovery 4/Range Rover Sport - 2005 - 2013  
 These adjustable rods replace the plastic and rubber parts Land Rover supply on the vehicle. Made from aluminium with an industrial heavy grade rubber bushing, the aluminium parts are anodised black to help with corrosion protection and blending in when in the garage for work. The lift rods have two settings; standard and off-road. With the vehicle set to normal driving height the shortened rods will give you off-road height. If you select off-road height the vehicle will be in the 'super extended' position as standard if you use the 'shortened' settings. The ease of changing the ride height is what separates these rods from others in the marketplace.

No tools are required and should take no more than 2 minutes to do all four rods. Access to the front is over the front wheels and for the back is through the rear wishbones (blanket required!)

**Note** - If run for a long time in off-road position then wheels may need realigning.

### Fully adjustable suspension lift rod kit



*"The ease of changing the ride height is what separates these rods from others in the marketplace."*



Photograph courtesy of Claire Borlase

### DA1233

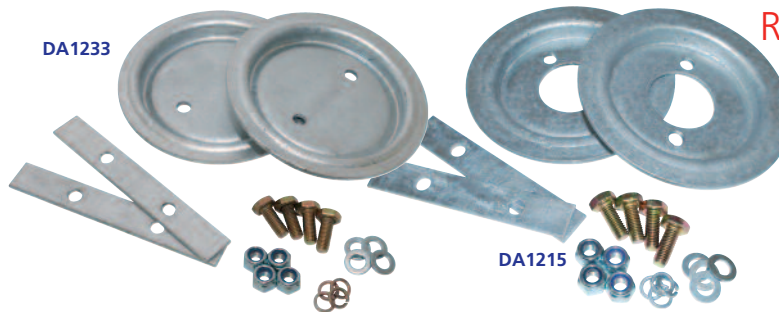

### Rear Spring Seats

Galvanised rear spring seat fitting kits  
**DA1215**  
 Defender - 90  
 Discovery 1  
 Range Rover Classic  
**DA1233**  
 Defender - 110 & 130

### DA1215

## Bushes Bump Stops

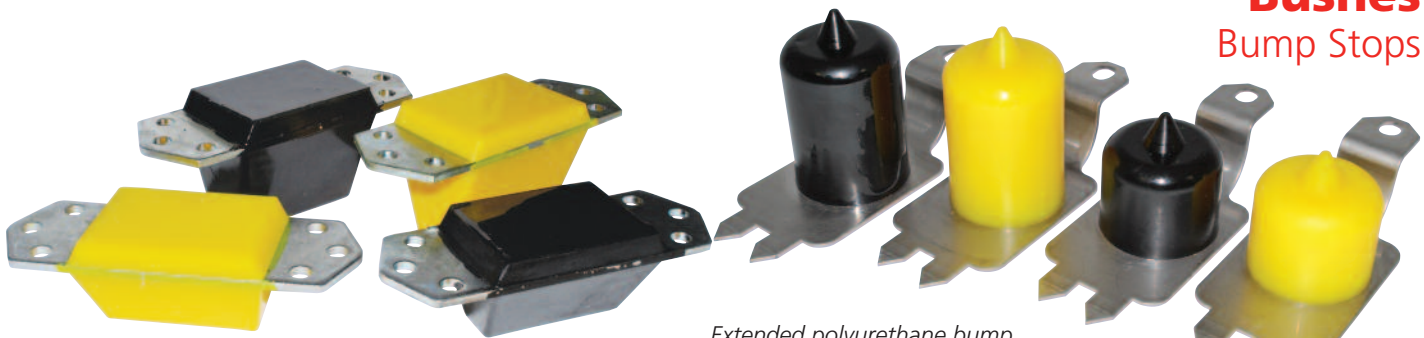

*Extended polyurethane bump stops should be used on vehicles with raised suspension to prevent the shock absorbers from bottoming out.*

<b>ANR4188PY</b>	Defender/Discovery 1	Front	Standard	Black
<b>ANR4188PY-YELLOW</b>	Defender/Discovery 1	Front	Standard	Yellow
<b>ANR4189PY</b>	Defender/Discovery 1	Rear	Standard	Black
<b>ANR4189PY-YELLOW</b>	Defender/Discovery 1	Rear	Standard	Yellow
<b>ANR4188PYE</b>	Defender/Discovery 1	Front	Extended	Black
<b>ANR4188EYELLOW</b>	Defender/Discovery 1	Front	Extended	Yellow
<b>ANR4189PYE</b>	Defender/Discovery 1	Rear	Extended	Black
<b>ANR4189EYELLOW</b>	Defender/Discovery 1	Rear	Extended	Yellow

**Note** - All sold individually. Standard height - 56mm high, extended height - 80mm high.

<b>DC7112</b>	Discovery 2	Front/Rear	Standard	Black
<b>DC7012</b>	Discovery 2	Front/Rear	Standard	Yellow
<b>DC7113</b>	Discovery 2	Front/Rear	Extended	Black
<b>DC7013</b>	Discovery 2	Front/Rear	Extended	Yellow

**Note** - Set of 4 stops. Standard height - 60mm high, extended height - 90mm high.



## Bush Sets - Britpart

### Polyurethane Bush Sets

**DA4035BLUE**  
Defender - 90/110/130 up to 1993 with drum brakes

**DA4036BLUE**  
Defender - 1994 onwards  
Discovery 1/Range Rover Classic - 1986 onwards

### Rubber Bush Set

Front radius arm to chassis kit  
Defender - 1987 - 1997/Discovery 1/  
Range Rover Classic - 1986 - 1994

**DA2353** - Britpart  
**DA2353G** - OEM



## Bush Set - Watts Linkage

### RGX100960K

Discovery 2  
Watts rear linkage bush set contains bushes to replace centre bearing, top & bottom bush links and axle end links.

### DA1199 NEW

Discovery 2  
This replacement pivot for the rear suspension is complete with bushes fitted which makes an awkward job easier.



## Bush Sets - Polybush

### DA3144

Full Polybush Dynamic Orange kit for Discovery 3 & Discovery 4

Kit contains -  
Front lower wishbone - front & rear bushes; front upper wishbone bushes; rear lower wishbone - front & rear bushes; rear upper wishbone - front & rear bushes

Individual Polybush Dynamic Orange kits for Discovery 3 & Discovery 4

<b>RBX000571PY</b>	Front anti-roll bar clamp kit
<b>RGX500060PY</b>	Rear anti-roll bar clamp kit
<b>RBX500301PY</b>	Front upper wishbone kit
<b>LR056964PY NEW</b>	Front upper wishbone kit
<b>RBX500311PY</b>	Front lower wishbone - front kit
<b>LR051585PY NEW</b>	Front lower wishbone - front kit
<b>RBX500291PY</b>	Front lower wishbone - rear kit
<b>LR025159PY</b>	Front lower wishbone - rear kit
<b>LR051586PY</b>	Front lower wishbone - rear kit
<b>RGX500101PY</b>	Rear lower wishbone - front kit
<b>RGX500290PY NEW</b>	Rear lower wishbone - front kit
<b>RGX500111PY</b>	Rear lower wishbone - rear kit
<b>LR054831PY NEW</b>	Rear lower wishbone - rear kit
<b>RGX500121PY</b>	Rear upper wishbone - rear kit
<b>RGX500131PY</b>	Rear upper wishbone - front kit
<b>RGX500300PY NEW</b>	Rear upper wishbone - front kit
<b>LR051621PY NEW</b>	Rear upper wishbone - front kit
<b>ROA000022PY</b>	Damper kit

### DA6049

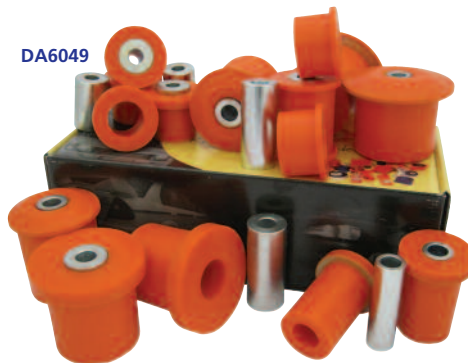

### DA8899

Full Polybush Dynamic Orange kit for Freelander 2

Kit contains -  
Front wishbone - front & rear bushes; rear trailing arm - inner & outer (hub end) bushes; rear forward track arm - inner & outer bushes; rear rear track arm - inner & outer bushes

Individual Polybush Dynamic Orange kits for Freelander 2

<b>LR005649PY</b>	Front anti-roll bar bush kit
<b>LR005648PY</b>	Rear anti-roll bar bush kit

### DA6049

Full Polybush Dynamic Orange kit for Range Rover Sport - 2005 - 2013

Kit contains -  
Front lower wishbone - front & rear bushes; front upper wishbone bushes; rear lower wishbone - front & rear bushes; rear upper wishbone - front & rear bushes

### DA8897 NEW

Full Polybush Dynamic Orange kit for Range Rover L322

Kit contains -  
Front - front wishbone arm inner & rear wishbone arm inner; Rear - upper wishbone inner front and rear; lower wishbone inner front & lower wishbone inner rear

### DA2220

Polybush Classic Red - Suspension bush set - wide bushes  
Defender 90 & 110 - 1994 onwards

Discovery 1  
Range Rover Classic - 1986 onwards

Kit contains -  
Axle - front radius arm/rear radius arm & panhard rod.  
Chassis - front radius arm & rear radius arm



Other Polybush sets available from Britpart - full details supplied on request.

### DA2198 NEW

Defender 2002 on

Kit contents - Front radius arm/axle; front radius arm/chassis; panhard rod; rear radius arm/axle; rear radius arm/chassis

### DA2204 NEW

Discovery 2

Kit contents - Front radius arm to axle; front radius arm to chassis; front panhard rod; rear axle - watts link to chassis bush; rear radius arm to chassis; rear radius arm to axle

### DA2200 NEW

Freelander 1

Kit contents - Anti roll bar clamp; rear radius arm to chassis; rear radius arm to hub carrier; rear lower wishbone rear arm - inner and outer and front arm outer; rear lower wishbone front arm inner; front wishbone front bush; front lower wishbone - rear bush; front lower wishbone - rear retaining washer

### DA2202 NEW

Range Rover P38 1994 on

### DA2203 NEW

Range Rover P38 1994 on

Kit contents - Front radius arm to axle; front radius arm to chassis; panhard rod; rear radius arm to chassis

Red

Orange Dynamic

Orange Dynamic

Orange Dynamic

Blue Comfort

## Bush Fitting Tool

### LRT-60-004

Land Rover special tool  
Fitting new front radius arm bushes (part number ANR3332) for the Range Rover P38 is impossible to do without using the Land Rover special tool.



## Bush Sets - Britpart Polyurethane

548205PY	Shackle & spring
548205PY-YELLOW	Shackle & spring
552818PY	Shock absorber
552818PY-YELLOW	Shock absorber
552819PY	Shock absorber
552819PY-YELLOW	Shock absorber
568858PY	Steering damper
568858PY-YELLOW	Steering damper
569746PY	Rear chassis
569746PY-YELLOW	Rear chassis
572068PY	Radius arm to chassis - outer
572068PY-YELLOW	Radius arm to chassis - outer
572180PY	Bottom link to chassis
572180PY-YELLOW	Bottom link to chassis
575580PY	Panhard rod
575580PY-YELLOW	Panhard rod
90577434PY	Rear chassis
90577434YELLOW	Rear chassis
ANR1721PY	Damper mounting
ANR1721PY-YELLOW	Damper mounting
ANR2563PY	Radius arm to chassis
ANR2563PY-YELLOW	Radius arm to chassis
ANR3285PY	Trailing arm rear suspension
ANR3285PY-YELLOW	Trailing arm rear suspension
ANR3305PY	Anti-roll bar
ANR3305PY-YELLOW	Anti-roll bar
ANR3332PY	Radius arm to axle
ANR3332PY-YELLOW	Radius arm to axle

ANR3410PY	Panhard rod
ANR3410PY-YELLOW	Panhard rod
ANR6947PY	Radius arm to axle
ANR6947PY-YELLOW	Radius arm to axle
NRC4514PY	Radius arm to chassis
NRC4514PY-YELLOW	Radius arm to chassis
NRC5593PY	Damper mounting
NRC5593PY-YELLOW	Damper mounting
NTC1772PY	Lower arm
NTC1772PY-YELLOW	Lower arm
NTC1773PY	Upper link
NTC1773PY-YELLOW	Upper link
NTC1775PY	Steering damper
NTC1775PY-YELLOW	Steering damper
NTC6781PY	Radius arm to axle
NTC6781PY-YELLOW	Radius arm to axle
NTC6860PY	Radius arm to axle
NTC6860PY-YELLOW	Radius arm to axle
NTC6828PY	Anti-roll bar
NTC6828PY-YELLOW	Anti-roll bar
NTC7307PY	Radius arm to axle
NTC7307PY-YELLOW	Radius arm to axle
NTC7394PY	Anti-roll bar
NTC7394PY-YELLOW	Anti-roll bar
RBX101240PY	Anti-roll bar
RBX101240PY-YELLOW	Anti-roll bar
RBX101340PY	Panhard rod
RBX101340PY-YELLOW	Panhard rod

RBX101680PY	Radius arm to chassis
RBX101680YELLOW	Radius arm to chassis
RBX101690PY	Anti-roll bar
RBX101690YELLOW	Anti-roll bar
RBX101730PY	Radius arm to chassis & axle
RBX101730PY-YELLOW	Radius arm to chassis & axle
RBX101780PY	Lower arm
RBX101780YELLOW	Lower arm
RBX101790PY	Lower arm
RBX101790YELLOW	Lower arm
RDB100080PY	Lower arm control buffer
RDB100080YELLOW	Lower arm control buffer
RGX100970PY	Transverse link
RGX100970YELLOW	Transverse link
RGX101000PY	Trailing link
RGX101000YELLOW	Trailing link
RGX101010PY	Hub
RGX101010YELLOW	Hub
RGX101020PY	Bottom link - outer
RGX101020YELLOW	Bottom link - outer
RGX101440PY	Bottom link - inner
RGX101440YELLOW	Bottom link - inner
RNF100090PY	Shock absorber - lower
RNF100090YELLOW	Shock absorber - lower
STC618PY	Mounting lower link
STC618PY-YELLOW	Mounting lower link

**Note** - Part numbers without yellow as a suffix indicate the bush colour is black.

### Britpart Black Suspension Bush Sets

DC7103	Series 1, 2 & 3 - excluding 3 LWB (see DC7104)
DC7104	Series 3 - LWB
DC7109	Defender - up to 1993
DC7110	Defender - 1994 - 1999
DC7108	Defender - 1999 - 2007
DC7111	Defender - 2007 onwards
DA2426	Defender - steering damper bush set
DC7100	Discovery 1
DC7101	Discovery 2/**
DC7102	Freelander 1
DC7105	Range Rover Classic - up to 1986
DC7106	Range Rover Classic - 1986 - 1994
DC7107	Range Rover P38**

### Britpart Yellow Suspension Bush Sets

DC7003	Series 1, 2 & 3 - excluding 3 LWB (see DC7004)
DC7004	Series 3 - LWB
DC7009	Defender - up to 1993
DC7010	Defender - 1994 - 1999
DC7008	Defender - 1999 - 2007
DC7011	Defender - 2007 onwards
DA2425	Defender - steering damper bush set
DC7000	Discovery 1
DC7001	Discovery 2/**
DC7002	Freelander 1
DC7005	Range Rover Classic - up to 1986
DC7006	Range Rover Classic - 1986 - 1994
DC7007	Range Rover P38**

**Notes** \*Kit includes front anti-roll bar bushes but these bushes aren't suitable for vehicles with ACE fitted.

\*\*Excludes shock absorber bushes

**All bushes are manufactured using the latest Vulkollan™ polyurethane technology**



- Britpart are proud to present an exclusive range of Yellow and Black polyurethane bushes.
- Manufactured exclusively for Britpart using the latest Vulkollan™ polyurethane technology.
- Machined to exact tolerances once cast to produce the highest finish available.
- Produced in both yellow and black they are both the same compound which gives similar ride characteristics to the standard rubber bushes, but they offer improved articulation, vibration damping and last longer.
- The black bushes are ideal for replacing individual bushes as they can be fitted without a press.
- The DC range of kits include shock absorber and A-frame bushes.

bush sets also available in **black**



## Air Suspension Compressors



At last, a cost effective and easy way to replace the OE air suspension compressor. These compressors are a direct replacement fit for the OE compressors that were fitted by the factory. They are made in Japan by Hitachi. By using the original brackets and pipes they are easy to install. The relay, which is included, must be changed. No need to reprogram the ECU (fault codes may need to be cleared).

- Direct replacement fit
- No need to reprogram the air suspension ECU
- Cost effective
- Uses all original mounting & pipework

**LR015303 & LR023964**

Discovery 3 - up to 9A513325

Range Rover Sport - up to 9A215622

**LR015089 & LR025111**

Range Rover L322 - from 6A198058 up to CA393639

**LR044034**

Discovery 4 - from 9A513325 / Range Rover Sport - from 9A215622

A direct replacement compressor for all non-Hitachi vehicles. Manufactured by the OE company in Germany. The relay which is included must be changed.

**LR061888 NEW** Compressor, relay, fixings and bracket

**LR045444** Compressor, relay and fixings

**LR044034 NEW** Bracket only

## Shock Absorbers

### Britpart XD Remote Reservoir **NEW**

Britpart have developed this range of remote reservoir shock absorbers for users wanting the extra benefits of a remote reservoir shock absorber on a vehicle that is used on the road as well as off it. The remote reservoir allows the shock to remain cooler under more extreme conditions and hence reduces the possibility of fade. Unlike most remote reservoir shock absorbers on the market the Britpart XD remote reservoir shock absorbers use conventional rubber bushings instead of ball joints. This is because ball joints have a very short life span when used on a road vehicle and are more suited to an all out competition vehicle.



Nitrogen filled remote reservoir shock absorbers with zinc plated steel body and anodised fittings.

**Note** - Will require extra fabrication to fit.

Application - Defender 90 & 110/Discovery 1/Range Rover Classic

Body diameter - 51mm

Shaft diameter - 20mm

Hydraulic hose length - 600mm

**DC8000 NEW**

Front pair

Open length - 716mm

Closed length - 462mm

**DC8001 NEW**

Rear pair

Open length - 717mm

Closed length - 463mm

**NEW**

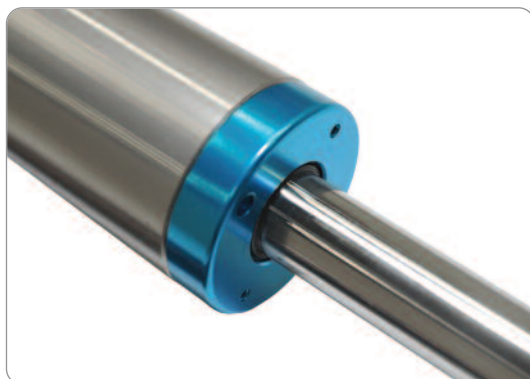
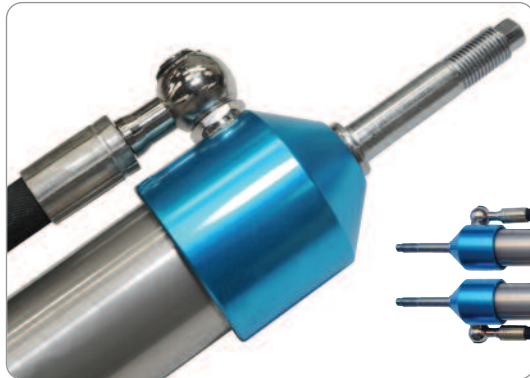

**DC8001**

Part Number	Application	Lift	Fitment	Open/Closed Dimensions**
DC6000	Defender/Discovery 1/Range Rover Classic		Front	600/380mm
DC6001	Defender/Discovery 1/Range Rover Classic		Rear	590/375mm
DC6000L	Defender/Discovery 1/Range Rover Classic	50mm/2"	Front	665/425mm
DC6001L	Defender/Discovery 1/Range Rover Classic	50mm/2"	Rear	625/385mm
DC6000LL	Defender/Discovery 1/Range Rover Classic	125mm/5" (see note***)	Front	765/455mm
DC6001LL	Defender/Discovery 1/Range Rover Classic	125mm/5" (see note***)	Rear	750/440mm
DC6010	Discovery 2		Front	590/370mm
DC6011	Discovery 2		Rear	585/365mm
DC6002	Range Rover P38 - air suspension		Front	560/365mm
DC6003	Range Rover P38 - air suspension		Rear	505/340mm
DC6004	Defender		Steering Damper	
DC6005	Discovery 1/Range Rover Classic/Series		Steering Damper	
DC6009	Discovery 2		Steering Damper	
DC6006	Range Rover P38		Steering Damper	
DC6007	Replacement gaiter for DC6000LL & DC6001LL		Single	



The Britpart Cellular Dynamic Shock Absorber represents a significant advance in Land Rover suspension systems. It features a cellular foam insert instead of a normal nitrogen gas or air, this is to stop the oil from boiling. The foam takes up less room which means more room for oil, 50% more, which offers maximum heat dispersion. This heat dispersion translates to a very subtle but controlled ride that will not fade no matter how hard you push them. They are ideal for a driver who needs more control to complement performance improvements or to enhance a standard vehicle. The unique design ensures ride comfort and cornering ability is maximised and of course they are superb off-road.



- Cellular technology tube
- Sintered 18mm rod
- Piston diameter 41mm
- Polyurethane bush
- Teflon piston with multi-lip seal
- Single piece eye ring

**Notes**

\*Terms & conditions apply

\*\* Dimensions are +/- 5mm

\*\*\* The Plus 5" Cellular Dynamic Shock Absorbers are specialist suspension products and to install them additional fabrication work or brackets may be required. Please ensure that they are fitted by a competent expert.

## Britpart Super Gaz

Part Number	Application	Lift	Fitment	Open/Closed Dimensions**
DC5002	Defender/Discovery 1/Range Rover Classic		Front	605/385mm
DC5003	Defender/Discovery 1/Range Rover Classic		Rear	590/375mm
DC5002L	Defender/Discovery 1/Range Rover Classic	50mm/2"	Front	655/405mm
DC5003L	Defender/Discovery 1/Range Rover Classic	50mm/2"	Rear	640/400mm
DC5000	Discovery 2		Front	590/370mm
DC5001	Discovery 2		Rear	585/365mm
DC5000L	Discovery 2	50mm/2"	Front	640/400mm
DC5001L	Discovery 2	50mm/2"	Rear	635/390mm
DC5004	Defender		Steering damper	
DC5005	Discovery 1/Range Rover Classic/Series		Steering damper	

*"vast improvement in ride quality  
& damping performance"*

**24 month / 50,000 mile Warranty\***



Britpart

Super Gaz Shock

Absorbers offer a

35mm bore tube filled

with Fuchs shock absorber

fluid, using the best seal available,

single piece eye rings, polyurethane bush

mounts and a very durable powder coated

finish. These offer a vast improvement in ride

quality and damping performance. They are ideal for

use with either of the Britpart Yellow Spring range or

standard Land Rover Springs.



### Notes

\*Terms & conditions apply

\*\* Dimensions are +/- 5mm

Delphi De Carbon



**Shock Absorbers**

<b>DA4162</b>	Series - LWB/SWB	Front
<b>DA4163</b>	Series - SWB	Rear
<b>DA4090</b>	Defender - up to 1999/Discovery 1 - up to 1994/Range Rover Classic - inc. air suspension	Front
<b>DA4092</b>	Discovery 1 - 1994 - 1999	Rear
<b>DA4181</b>	Defender - up to 1999/Discovery 1 - to 1994/Range Rover Classic	Front +2"

**Note** - Boxed as a pair, priced individually

**Steering Dampers**

<b>DA4160</b>	Series/Discovery 1/Range Rover Classic
---------------	----------------------------------------



Britpart Heavy-duty

<b>DA4211</b>	Defender 90/110	Front
<b>DA4210</b>	Defender 90/110	Rear
<b>RTC4234</b>	Series 2/2A/3 SWB	Front
<b>RTC4235</b>	Series 2/2A/3 SWB	Rear
<b>RTC4484</b>	Series 2/2A/3 LWB	Front
<b>RTC4236</b>	Series 2/2A/3 LWB	Rear



Heavy-duty oil filled shock absorbers

**Air Suspension Control**

**EASCONTROL**

For full details on **Bluetooth connectivity** please see refer to Diagnostics section of this catalogue.



**Electronic Air Suspension Control**

Re-programme your air suspension's height settings to raise or lower your vehicle in minutes – without getting your hands dirty!

The EASControl is an easy to use tool that allows fast, simple adjustments to the EAS suspension height settings. It also contains full diagnostic functions for the electronic air suspension system.

*Raise or lower your vehicle:* Height adjustment in front, rear or both.

*No installation or additional equipment required:* the EASControl is plugged into the OBD port and the easy to use, intuitive menu is displayed on the cluster message centre (or compatible Bluetooth device – EASControl BT models only). No wires to cut, holes to drill and no crawling under the car.

*Restore and save functions:* Original ECU settings backed up and 3 memory slots available to save your favourite settings.

**Raise, lower or repair your Land Rover's electronic air suspension like a pro!**

**EASControl**

Discovery 3	
Discovery 4	
Range Rover Sport - 2005 - 2009	
Range Rover Sport - 2010 - 2013	
Range Rover L322 - 2002 - 2005 (up to 5A999999)	
Range Rover L322 - 2006 - 2009 (from 6A000001)	
EASControl unlock code	

**Standard**

<b>DA6425</b>	
<b>DA6426</b>	<b>DA6428</b>
<b>DA6423</b>	
<b>DA6424</b>	<b>DA6429</b>
<b>DA6420</b>	
<b>DA6421</b>	
<b>DA6427</b>	<b>DA6427</b>

**Bluetooth**

**Springs**  
Air Lift Kits

**Adjustable Air Helper Springs**

The load and towing problem solver

Air adjustability is the difference! Stiff steel factory suspensions must compromise between ride comfort and load hauling capacity. Smooth ride suspensions can't carry heavy loads; heavy springs ride rough, especially when the vehicle is unloaded. Air Lift adjustable air springs solve these problems by allowing you to tune your suspension under all load and road conditions. Just add air when towing or hauling and then remove air for a softer ride when unloaded.

**Features and benefits of Air Lift 1000**

- Improve ride, handling and stability by reducing roll, sway and "bottoming out"
- Fits open coil springs, front or rear
- Up to 1,000lbs of levelling capacity
- Tough long-lasting moulded polyurethane construction
- Quick connecting easy-to-use engineered polymer air fittings

**Air Lift 1000**



DA5012



DA5010 / DA5011

**DA5010**

Defender 110 /130

**DA5011**

Defender 90/Discovery 1/Range Rover Classic

**DA5012**

**Load Controller II**

The economical, popular, basic on board air system.

This system controls the rear bags equally. All kits include wiring harness for fast, easy installation.

To eliminate the major cause of air spring failure, the low pressure sensor automatically activates if pressure falls below the minimum safe level.

## Air Spring Conversion Kits

### Discovery 2

It is a sad fact that it's likely the air suspension on your Discovery 2 will fail - probably at the most inconvenient time possible. You then have a choice to make.

Do you replace it with a new air spring system which is comfortable but not so comfortable on your wallet or replace with an equally comfortable but much more affordable and reliable coil spring system?

Well Britpart have the complete kit for air to coil spring conversion making your decision that little bit easier.

<b>DA5136</b>	Standard ride height Rear kit - black springs
<b>DA5137</b>	2" lift ride height Rear kit - yellow springs
<b>DA5007</b>	2" lift ride height - <b>heavy-duty</b> Front & rear kit - yellow springs Ideal if winch is fitted
<b>DA5008</b>	2" lift ride height Front & rear kit - yellow springs



DA5137

### Discovery 3

#### DA5034 **NEW**

Coil conversion kit with module

Does the complexity of having air suspension on your Discovery 3 worry you?

This comprehensive kit contains everything you need to convert to conventional coil spring suspension. Kit comprises four strut units and module to prevent the air suspension lights from being illuminated.



DA5034



DA5007

Air to coil spring conversion kits from Britpart - get a reliable and maintenance-free ride for your Land Rover!



### Range Rover

The EAS (Electronic Air Suspension) System found on Range Rover 4.0 and 4.6 vehicles can present expensive, recurring maintenance problems. If you've had an air spring failure before, you know this first hand. Britpart now has a coil spring conversion kit for Range Rover 4.0 and 4.6 that makes switching to coil springs seamless and error-free. Conversion to coil springs provides a better, maintenance-free ride that will save you significant money over time. The EAS Override Module suppresses all typical false dashboard display errors and buzzers seen when converting to coil springs. Any mechanic or Range Rover owner can install this coil spring conversion kit without having to go to a Land Rover dealer or Autologic-equipped repair shop to eliminate false dash warning light errors.

The kit features:

- Detailed step-by-step instructions.
- The EAS Override Module overrides all typical computer errors seen when converting to coil springs.
- Eliminates the need for a costly shop visit.
- Aluminium spring perch adapters.

- Britpart custom made coil springs provide standard ride height and maximum articulation.
- Affordable alternative to expensive, recurring air suspension failures.
- Trip computer compatibility - maintains operation of your vehicle's trip computer.
- Kit provides everything needed to complete a professional installation.

<b>DA4136</b>	Range Rover P38 - 1995 - 2002	Petrol models and diesel light duty
<b>DA4136HD</b>	Range Rover P38 - 1995 - 2002	Heavy-duty 1" lift including diesel models Kit with black springs
<b>DA4136BUSH</b>	Britpart yellow polyurethane bush kit for DA4136 & DA4136HD	
<b>BL4136BUSH</b>	Britpart black polyurethane bush kit for DA4136 & DA4136HD	
<b>DA4136FR</b>	Pair of replacement front coil springs for DA4136	
<b>DA4136RR</b>	Pair of replacement rear coil springs for DA4136	
<b>DA4136HDFR</b>	Pair of replacement front coil springs for DA4136HD	
<b>DA4136HRRR</b>	Pair of replacement rear coil springs for DA4136HD	
<b>DA4136EAS</b>	Range Rover P38 - 1995 - 2002	EAS Override module EAS override module suppresses all typical false dashboard display errors and buzzers seen when converting to coil springs
<b>DA4180</b>	Range Rover Classic - 1" lift - no module	
<b>DA4179</b>	Range Rover Classic - no module	



DA4136HD



DA4136EAS



DA4180



**Springs - Air**



Air springs can be susceptible to air leaks due to the fact the rubber seals dry out. Why not firm up your suspension and replace them with these quality air springs from Britpart?

<b>RKB101200</b>	Discovery 2	Rear
<b>NTC9819</b>	Range Rover Classic	Front
<b>NTC9820</b>	Range Rover Classic	Rear
<b>DA2372</b>	Range Rover P38	Front
<b>DA2373</b>	Range Rover P38	Rear
<b>REB101740</b>	Range Rover P38	Front
<b>RKB101460</b>	Range Rover P38	Rear

**Note** - All sold individually.

**Springs - Leaf**

For many years Land Rover road springs have been difficult to obtain to the correct OE specification. To remedy this, Britpart commissioned the same Spanish factory that produces our Santana parabolic springs to reproduce a comprehensive range of springs for Land Rover Series vehicles. The springs are constructed from the correct grade alloy steel 60SiCr8, heat treated consisting of hardening & tempering and set as Land Rover engineers specified and therefore will give years of service with the correct ride comfort.

<b>241283</b>	SWB	Petrol	Front	9 Leaf	O/S
<b>242863</b>	SWB	Petrol	Front	9 Leaf	N/S
<b>265627</b>	SWB & LWB	Diesel	Front	11 Leaf	O/S
<b>264563</b>	SWB & LWB	Diesel	Front	11 Leaf	N/S
<b>517588</b>	SWB		Rear	11 Leaf	O/S
<b>517589</b>	SWB		Rear	11 Leaf	N/S
<b>243123</b>	SWB		Rear	Single main leaf	O/S & N/S
<b>279678</b>	LWB		Rear	10 Leaf	O/S
<b>279679</b>	LWB		Rear	10 Leaf	N/S
<b>535173</b>	LWB - 1 Ton		Rear	9 Leaf	O/S & N/S
<b>562631</b>	Lightweight		Rear	7 Leaf	O/S
<b>562632</b>	Lightweight		Rear	7 Leaf	N/S



265627

*"quality you would expect from an OEM supplier.."*



279678

**Springs - Parabolic**

The Britpart range of high quality OEM parabolic springs are made to the exacting specifications as fitted to Santana specification vehicles. Manufactured in Spain to the standard and quality you would expect from an OEM supplier. The correct grade alloy steel 60SiCr8 is used, heat treated consisting of hardening & tempering and springs are shot peened before painting. These parabolic springs will bring a comfortable ride and improved handling to your Series vehicle. **Note** - Includes 'U' bolts and nuts.

<b>DA4106</b>	Series - SWB/LWB	2 Leaf	Front kit pair
<b>DA4107</b>	Series - SWB	3 Leaf	Rear kit pair
<b>DA2003</b>	Series - LWB	4 Leaf	Rear kit pair



DA4107



DA4106

**Leaf Spring Castor Correction Wedges**

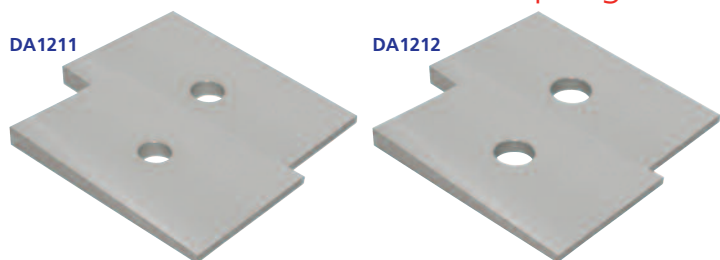

DA1211

DA1212

Can be used to correct castor or diff pin angle on leaf sprung vehicles by 3 degrees.

<b>DA1211</b>	Castor correction wedges - pair
	Small pin - 13mm
<b>DA1212</b>	Castor correction wedges - pair
	Large pin - 16mm

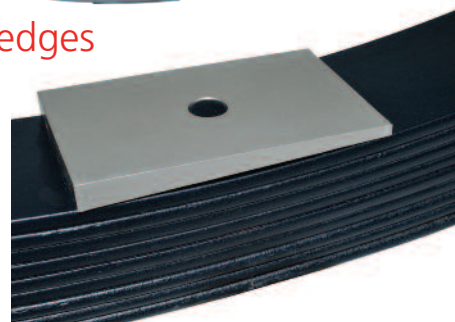

**Springs - Lowered Coil**

Reduce the ride height of your Land Rover by 1" (25mm) by fitting these lowered springs.

By lowering your vehicle it will help reduce body roll as well as giving your vehicle a more sporty squat stance.

The springs are designed in line with the standard spring rate specification.

Finished in powered coated orange paint.

Defender 90/Discovery 1		
Range Rover Classic		
<b>DA4563</b>	Front springs	Pair
<b>DA4564</b>	Rear springs	Pair



<b>DA1234 NEW</b>	Defender 90 / Discovery 1
	Range Rover Classic with axle brackets

Reduce the ride height of your Land Rover by 1" (25mm). By lowering your vehicle it will help reduce body roll as well as giving your vehicle a more sporty squat stance and improve handling. The springs are designed in line with the standard spring rate specification and are finished in powered coated orange paint to match the anti-roll bars and shock absorbers.

**XD Handling Kit NEW**



Kit contains - Britpart lowered coil springs, Britpart Cellular Dynamic shock absorbers, anti-roll bars, turret rings, straps, ball joint assemblies, bushes, nuts, bolts and washers

## Springs - Coil

### Britpart Performance - Lifted Springs

Britpart performance springs are high quality, versatile and competitively priced - the right choice when replacing the old sagging original springs.

Developed by one of the world's top spring manufacturers these high quality, powder coated yellow springs have been designed with the needs of today's Land Rover owners in mind. Britpart performance lifted springs have the added benefit of improving your vehicles approach and departure angles which in turn allows you to overcome more obstacles when off-roading.

As Land Rovers are often working vehicles as well as the family car, uprated springs must offer the ability to carry loads, handle off-road terrain and provide a good ride on road. The progressive springs offer a compliant ride when lightly loaded, but firm up as the load increases.

**Note** - Spring quantity 1 = 1 pair



The right choice when replacing the old sagging original springs!

Defender			Lift	Load	Bar Diameter	Rate lbs/in	Free Height
DA4201	Defender 90/110	Front	25mm	25kg	16mm	200	420mm
DA4202	Defender 90/110/130	Front	40mm	50kg	16mm	230	390mm
DA4203	Defender 90	Rear	40mm	Light	17mm	220	435mm
DA4204	Defender 90	Rear	50mm	100kg	18mm	300 - 340	425mm
DA4205	Defender 90	Rear	50mm	200kg	19mm	360	430mm
DA4206	Defender 110	Rear	40mm	100kg	17mm	270 - 295	445mm
DA4208	Defender 110/130	Rear	50mm	500kg	21mm	420	445mm
<b>Discovery</b>							
DA4201	Discovery 1	Front	25mm	25kg	16mm	200	420mm
DA4202	Discovery 1	Front	40mm	50kg	16mm	230	390mm
DA4199	Discovery 2	Front	40mm	20 - 50kg	15mm	180	390mm
DA4198	Discovery 2	Front	40mm	50 - 100kg	16mm	220	390mm
DA4203	Discovery 1/Discovery 2	Rear	40mm	Light	17mm	220	435mm
DA4197	Discovery 2	Rear	40mm	Medium	18mm	290	430mm
DA4204	Discovery 1	Rear	50mm	100kg	18mm	300 - 340	425mm
DA4205	Discovery 1/Discovery 2	Rear	50mm	200kg	19mm	360	430mm
<b>Range Rover</b>							
DA4201	Range Rover Classic	Front	25mm	25kg	16mm	200	420mm
DA4202	Range Rover Classic	Front	40mm	50kg	16mm	230	390mm
DA4203	Range Rover Classic	Rear	40mm	Light	17mm	220	435mm
DA4204	Range Rover Classic	Rear	50mm	100kg	18mm	300 - 340	425mm
DA4205	Range Rover Classic	Rear	50mm	200kg	19mm	360	430mm

### Britpart Performance - Standard Height Springs

Britpart yellow springs are designed for the enthusiast who wants a performance spring without having to raise the vehicle. They offer a firmer ride with less body roll, ideal for a vehicle with uprated performance or one used for carrying heavy loads. The springs are designed to offer full articulation off-road with a compliant ride. Developed by one of the world's top spring manufacturers these high quality, powder coated yellow springs have been designed with the needs of today's Land Rover owners in mind.

**Note** - Spring quantity 1 = 1 pair

Defender			Bar Diameter	Rate lbs/in	Free Height
DA4277	Defender 90/110	Front	16mm	225	390mm
DA4278	Defender 90	Rear	18mm	285	385mm
DA4279	Defender 110	Rear	19mm	330	415mm
<b>Discovery</b>					
DA4277	Discovery 1	Front	16mm	225	390mm
DA4278	Discovery 1	Rear	18mm	285	385mm
<b>Range Rover</b>					
DA4277	Range Rover Classic	Front	16mm	225	390mm
DA4278	Range Rover Classic	Rear	18mm	285	385mm



**Propshafts**  
Propshaft Spacer Kit

**DA6355**

Defender/Discovery 1/Range Rover Classic

- 300Tdi models onwards.
- Double cardan extreme use front propshaft with flange and fitting kit.
- For vehicles with L230 transfer boxes.
- Ideal for use with lifted vehicles.
- Helps to reduce driveline vibration where diff and transfer flanges are not in-line.

**Note** - Flange must be fitted to transfer box.



**Propshaft Kit**

**DA6339**

Defender/Discovery 1/Range Rover Classic

15mm propshaft spacer kit machined from billet aluminium and anodised deep blue. When suspension lift kit is fitted it increases the distance between the transfer box flange and the diff flange. This increased distance can cause the propshaft to run out of spline travel. Fitting this 15mm prop spacer helps return the propshaft to its normal operating length therefore allowing full spline travel which also helps reduce the characteristic "binding" of the yokes when a propshaft is over extended.



**Wide Angle Propshafts**

<b>DA6350</b>	Front	Defender - from MA - 300Tdi & Td5/Discovery 1/Range Rover Classic - 1986 - 1991	FRC8386
<b>DA6352</b>	Front	Defender - up to LA (1993)	FRC8390/FRC5566
<b>DA6351</b>	Rear	Defender 90 - 4 cylinder	FRC8392
<b>DA6353</b>	Rear	Defender 90 - V8 - up to 2007 & diesel from MA	FRC8393
<b>DA6354</b>	Rear	Discovery 1 - 1989 - 1994 & V8 from 1997	FRC8387
<b>DA6356</b>	Replacement heavy-duty universal joint for wide angle propshafts		
<b>DA1123</b>	Nut & bolt kit - each kit contains 4 nuts - for transfer box end & 4 nuts & bolts - for diff end Enough nuts & bolts to make propshaft repair out in the field. Suitable for DA6350; DA6351; DA6352, DA6353 & DA6354		

If your Land Rover has raised suspension or been modified for extreme axle articulation then the joints on the existing propshaft will become strained. This will cause the propshaft to lock up or vibrate and wear the universal joints prematurely. Dropping the axle further away from the chassis is great for looks, articulation and off-road performance - a neat solution is to fit a wide angle propshaft. This allows drivetrain angles of up to 32 degrees which reduces vibration, universal joint 'bind-up' and premature wear on the joints. These wide angle shafts have greasable universal joints which are more desirable where longer life is required.



**Steering**

**Steering Arms - Heavy-Duty**

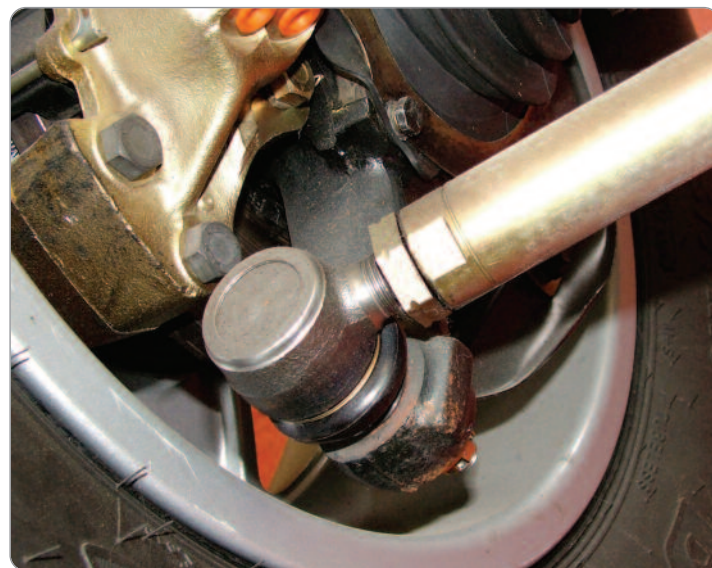

<b>DA5501</b>	Series	4 track rod ends
<b>DA5502</b>	Defender 90/110	3 track rod ends
<b>DA5503</b>	Discovery 1/Range Rover Classic	3 track rod ends
<b>DA5504</b>	Discovery 1	4 track rod ends
<b>DA5509</b>	Discovery 2	4 track rod ends

- All OEM track rod ends
- Solid heavy-duty arms which are suitable for off-road use
- Improves steering response
- Zinc plate finish to increase corrosion resistance

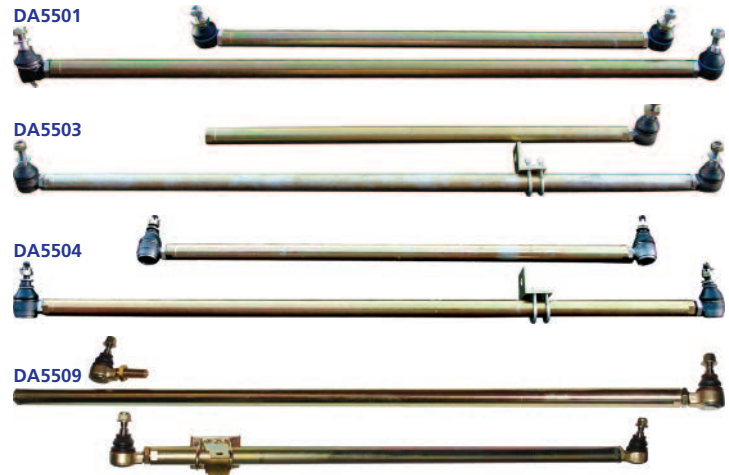

Improves steering response



**Steering Dampers**

**Britpart Cellular Dynamic**

<b>DC6004</b>	Defender
<b>DC6005</b>	Discovery 1/Range Rover Classic/Series
<b>DC6009</b>	Discovery 2
<b>DC6006</b>	Range Rover P38

**Delphi De Carbon**

<b>DA4160</b>	Discovery 1/Range Rover Classic/Series
---------------	----------------------------------------

**Britpart Super Gaz**

<b>DC5004</b>	Defender
<b>DC5005</b>	Discovery 1/Range Rover Classic/Series



## Suspension Kits

### Britpart Super Gaz Suspension Kits

#### Shock Absorber & Spring Kits

DA4284	Defender 90/Discovery 1/Range Rover Classic	Heavy-duty	Standard height
DA4301	Defender 90/Discovery 1/Range Rover Classic	Light-duty	25mm Lift
DA4286	Defender 90/Discovery 1/Range Rover Classic	Light-duty	40mm Lift
DA4286MD	Defender 90/Discovery 1/Range Rover Classic	Medium-duty	40mm Lift
DA4286HD	Defender 90/Discovery 1/Range Rover Classic	Heavy-duty	40mm Lift
DA4285	Defender 110	Heavy-duty	Standard height
DA4287	Defender 110	Heavy-duty	40mm Lift

#### Full Suspension Kits

DA4288	Defender 90 - up to 1994/Range Rover Classic - up to 1986	Narrow bush	Light-duty	40mm Lift
DA4288MD	Defender 90 - up to 1994/Range Rover Classic - up to 1986	Narrow bush	Medium-duty	40mm Lift
DA4288HD	Defender 90 - up to 1994/Range Rover Classic - up to 1986	Narrow bush	Heavy-duty	40mm Lift
DA4289	Defender 90 - 1994 onwards/Discovery 1/Range Rover Classic - 1986 onwards	Wide bush	Light-duty	40mm Lift
DA4289MD	Defender 90 - 1994 onwards/Discovery 1/Range Rover Classic - 1986 onwards	Wide bush	Medium-duty	40mm Lift
DA4289HD	Defender 90 - 1994 onwards/Discovery 1/Range Rover Classic - 1986 onwards	Wide bush	Heavy-duty	40mm Lift
DA4299	Defender 110 - up to 1994	Narrow bush	Heavy-duty	40mm Lift
DA4300	Defender 110 - 1994 onwards	Wide bush	Heavy-duty	40mm Lift

Britpart offers you a **COMPLETE OR PARTIAL SUSPENSION PACKAGE** suitable for whatever you intend to use your Land Rover for.



CELLULAR DYNAMIC - FULL SUSPENSION KIT



SUPER GAZ - SHOCK ABSORBER & SPRING KIT

#### Suspension kit contents - Shock absorber & spring kits

- Springs - front & rear
- Shock absorbers - front & rear

#### Full suspension kits

- Springs - front & rear
- Shock absorbers - front & rear
- Radius arms - front & rear
- Spring retainers - front & rear
- Bush sets



### Britpart Cellular Dynamic Suspension Kits

#### Shock Absorber & Spring Kits

DA4284C	Defender 90/Discovery 1/Range Rover Classic	Heavy-duty	Standard height
DA4301C	Defender 90/Discovery 1/Range Rover Classic	Light-duty	25mm Lift
DA4286C	Defender 90/Discovery 1/Range Rover Classic	Light-duty	40mm Lift
DA4286CMD	Defender 90/Discovery 1/Range Rover Classic	Medium-duty	40mm Lift
DA4286CHD	Defender 90/Discovery 1/Range Rover Classic	Heavy-duty	40mm Lift
DA4363	Defender 90/Discovery 1/Range Rover Classic	Light-duty	Plus 5" Shock*
DA4285C	Defender 110	Heavy-duty	Standard height
DA4287C	Defender 110	Heavy-duty	40mm Lift
DA4364	Defender 110	Heavy-duty	Plus 5" Shock*

#### Full Suspension Kits

DA4288C	Defender 90 - up to 1994/Range Rover Classic - up to 1986	Narrow bush	Light-duty	40mm Lift
DA4288CMD	Defender 90 - up to 1994/Range Rover Classic - up to 1986	Narrow bush	Medium-duty	40mm Lift
DA4288CHD	Defender 90 - up to 1994/Range Rover Classic - up to 1986	Narrow bush	Heavy-duty	40mm Lift
DA4365	Defender 90 - up to 1994/Range Rover Classic - up to 1986	Narrow bush	Medium-duty	Plus 5" Shock*
DA4289C	Defender 90 - 1994 onwards/Discovery 1/Range Rover Classic - 1986 onwards	Wide bush	Light-duty	40mm Lift
DA4289CMD	Defender 90 - 1994 onwards/Discovery 1/Range Rover Classic - 1986 onwards	Wide bush	Medium-duty	40mm Lift
DA4289CHD	Defender 90 - 1994 onwards/Discovery 1/Range Rover Classic - 1986 onwards	Wide bush	Heavy-duty	40mm Lift
DA4366	Defender 90 - 1994 onwards/Discovery 1/Range Rover Classic - 1986 onwards	Wide bush	Medium-duty	Plus 5" Shock*
DA4299C	Defender 110 - up to 1994	Narrow bush	Heavy-duty	40mm Lift
DA4367	Defender 110 - up to 1994	Narrow bush	Heavy-duty	Plus 5" Shock*
DA4300C	Defender 110 - 1994 onwards	Wide bush	Heavy-duty	40mm Lift
DA4368	Defender 110 - 1994 onwards	Wide bush	Heavy-duty	Plus 5" Shock*

\*Note - The Plus 5" Cellular Dynamic Shock Absorbers are specialist suspension products and to install them additional fabrication work or brackets may be required.

Please ensure that they are fitted by a competent expert. Open and closed dimensions - DC6000LL - 765-455mm & DC60001LL - 750-440mm.

## Shock Absorber &amp; Suspension Kits Matrix

	Defender 90	Defender 110	Discovery 1	Discovery 2	Range Rover Classic	Range Rover P38	Series
<b>Super Gaz Shock Absorbers</b>							
<b>Front</b>							
Standard	DC5002	DC5002	DC5002	DC5000	DC5002		
50mm lift	DC5002L	DC5002L	DC5002L	DC5000L	DC5002L		
<b>Rear</b>							
Standard	DC5003	DC5003	DC5003	DC5001	DC5003		
50mm lift	DC5003L	DC5003L	DC5003L	DC5001L	DC5003L		
<b>Steering damper</b>							
Standard	DC5004	DC5004	DC5005		DC5005		DC5005
50mm lift	DC5004	DC5004	DC5005		DC5005		DC5005
<b>Super Gaz Shock Absorber Suspension Kits</b>							
<b>Shock Absorber &amp; Spring Kits</b>							
Standard - heavy-duty kit	DA4284	DA4285	DA4284		DA4284		
25mm lift - light-duty kit	DA4301		DA4301		DA4301		
40mm lift - light-duty kit	DA4286		DA4286		DA4286		
40mm lift - medium-duty kit	DA4286MD		DA4286MD		DA4286MD		
40mm lift - heavy-duty kit	DA4286HD	DA4287	DA4286HD		DA4286HD		
40mm lift - no winch - kit				DA5008			
40mm lift - with winch - kit				DA5007			
<b>Full Suspension Kits</b>							
40mm lift - narrow bush - light-duty kit	DA4288				DA4288		
40mm lift - narrow bush - medium-duty kit	DA4288MD				DA4288MD		
40mm lift - narrow bush - heavy-duty kit	DA4288HD	DA4299			DA4288HD		
40mm lift - wide bush - light-duty kit	DA4289		DA4289		DA4289		
40mm lift - wide bush - medium-duty kit	DA4289MD		DA4289MD		DA4289MD		
40mm lift - wide bush - heavy-duty kit	DA4289HD	DA4300	DA4289HD		DA4289HD		
<b>Cellular Dynamic Shock Absorbers</b>							
<b>Front</b>							
Standard	DC6000	DC6000	DC6000	DC6010	DC6000	DC6002	
50mm lift	DC6000L	DC6000L	DC6000L		DC6000L		
Plus 5" shock absorber	DC6000LL	DC6000LL	DC6000LL		DC6000LL		
<b>Rear</b>							
Standard	DC6001	DC6001	DC6001	DC6011	DC6001	DC6003	
50mm lift	DC6001L	DC6001L	DC6001L		DC6001L		
Plus 5" shock absorber	DC6001LL	DC6001LL	DC6001LL		DC6001LL		
<b>Steering damper</b>							
Standard	DC6004	DC6004	DC6005	DC6009	DC6005	DC6006	DC6005
50mm lift	DC6004	DC6004	DC6005		DC6005		
Plus 5" shock absorber	DC6004	DC6004	DC6005		DC6005		
<b>Cellular Dynamic Shock Absorber Suspension Kits</b>							
<b>Shock Absorber &amp; Spring Kits</b>							
Standard height - heavy-duty kit	DA4284C	DA4285C	DA4284C		DA4284C		
25mm lift - light-duty kit	DA4301C		DA4301C		DA4301C		
40mm lift - light-duty kit	DA4286C		DA4286C		DA4286C		
40mm lift - medium-duty kit	DA4286CMD		DA4286CMD		DA4286CMD		
40mm lift - heavy-duty kit	DA4286CHD	DA4287C	DA4286CHD		DA4286CHD		
Plus 5" shock absorber - light-duty kit	DA4363		DA4363		DA4363		
Plus 5" shock absorber - heavy-duty kit		DA4364					
<b>Full Suspension Kits</b>							
40mm lift - narrow bush - light-duty kit	DA4288C				DA4288C		
40mm lift - narrow bush - medium-duty kit	DA4288CMD				DA4288CMD		
40mm lift - narrow bush - heavy-duty kit	DA4288CHD	DA4299C			DA4288CHD		
Plus 5" shock - narrow bush - medium-duty kit	DA4365				DA4365		
Plus 5" shock - narrow bush - heavy-duty kit		DA4367					
40mm lift - wide bush - light-duty kit	DA4289C		DA4289C		DA4289C		
40mm lift - wide bush - medium-duty kit	DA4289CMD		DA4289CMD		DA4289CMD		
40mm lift - wide bush - heavy-duty kit	DA4289CHD	DA4300C	DA4289CHD		DA4289CHD		
Plus 5" shock absorber - wide bush - medium-duty kit	DA4366		DA4366		DA4366		
Plus 5" shock absorber - wide bush - heavy-duty kit		DA4368					



## Section contents

Calibration Tools	137
Electronic Air Suspension Control	128
Integrated Interface Diagnostics Tool	128 - 129
Lynx Diagnostic Interface	130 - 137

## Section Thirteen

## vehicle diagnostics

Finding and rectifying common electrical faults has never been easier with a selection of diagnostic tools from Britpart.



## Integrated Interface Diagnostics Tool & Electronic Air Suspension Control

### EASCONTROL

#### Electronic Air Suspension Control

Re-programme your air suspension's height settings to raise or lower your vehicle in minutes – without getting your hands dirty!

The EASControl is an easy to use tool that allows fast, simple adjustments to the EAS suspension height settings. It also contains full diagnostic functions for the electronic air suspension system.

**Raise or lower your vehicle:** Height adjustment in front, rear or both.

**No installation or additional equipment required:** the EASControl is plugged into the OBD port and the easy to use, intuitive menu is displayed on the cluster message centre (or compatible Bluetooth device – EASControl BT models only). No wires to cut, holes to drill and no crawling under the car.

**Restore and save functions:** Original ECU settings backed up and 3 memory slots available to save your favourite settings.

**Raise, lower or repair your Land Rover's electronic air suspension like a pro!**



### IIDTOOL

#### Integrated Interface Diagnostics Tool

Self contained diagnostic system with integrated interface or Bluetooth/PC/Mac controller app.

Despite its size and price, the IIDTool is a fully featured diagnostic system offering diagnostic functionality otherwise only found in systems costing many, many times more.

**The IIDTool offers the following unique advantages:**

**Speed and ease of use:** an easy to use, intuitive menu system provides all commonly used diagnostic functionality much more quickly than PC based systems.

**Portability:** no power supplies, cables, or additional equipment necessary - simply plug in and use; can be used at the roadside or in the middle of the desert.

**Restore to default:** upon first use on a vehicle, the IIDTool saves the configuration and settings to allow a restore from backup at any time.

**Covers all vehicle systems:** from ABS, airbags, and BCM, through engine, instrument pack, and LCM, to steering angle, TPMS, transfer case and transmission – all systems covered.

**Enhanced diagnostic functions:** includes component / system calibration, CCF (car configuration file) editing, and ECU flash functions.

**Includes all EASControl functions:** raise and lower the EAS electronic air suspension settings in minutes – without dirty hands!

And much, much more...

**From simple fault finding and clearing to complex changes in the vehicle's car configuration file, the IIDTool does it all - despite its size!**

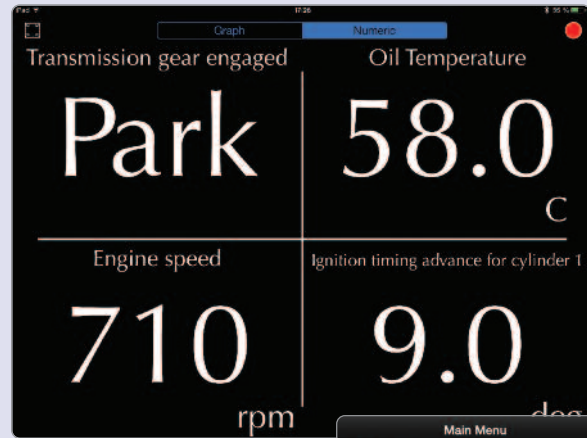

For something so small these tools are packed with big features...



#### Even more features with App V2.0 and firmware V3.0.

- Multiple vehicle type supported in a single unit (IIDTool BT only)
- Fault list export via e-mail (IIDTool BT only)
- Up to 8 live values displayed at once (IIDTool BT only), on numerical and graph scales. The logs can be saved and recalled
- PC based interface now supported
- More ECU soft ware updates i.e. AMK compressor
- Component system and calibration
- Nav On Move enablement (destination entry while on the move, L322, L319 and L320 up to 2009 only)



	Standard	Bluetooth
<b>IIDTool</b>		
Defender - 2007 onwards		DA6415 <b>NEW</b>
Freelander 2		DA6419 <b>NEW</b>
Discovery 3	DA6405	DA6410
Discovery 4	DA6406*	DA6408
Range Rover Sport - 2005 - 2009	DA6403	DA6411
Range Rover Sport - 2010 - 2013	DA6404	DA6409
Range Rover Sport - 2014 onwards		DA6416 <b>NEW</b>
Range Rover L322 - 2002 - 2005 (up to 5A999999)	DA6400	DA6413
Range Rover L322 - 2006 - 2009 (from 6A000001)	DA6401	DA6412
Range Rover L322 - 2010 - 2012 (from AA000001)		DA6414 <b>NEW</b>
Range Rover L405		DA6417 <b>NEW</b>
Range Rover Evoque		DA6418 <b>NEW</b>
IIDTool unlock code	DA6407	DA6407
2m USB cable. Optional extra needed to download updates.	DA6399	DA6399
<b>EASControl</b>	<b>Standard</b>	<b>Bluetooth</b>
Discovery 3	DA6425	
Discovery 4	DA6426	DA6428
Range Rover Sport - 2005 - 2009	DA6423	
Range Rover Sport - 2010 - 2013	DA6424	DA6429
Range Rover L322 - 2002 - 2005 (up to 5A999999)	DA6420	
Range Rover L322 - 2006 - 2009 (from 6A000001)	DA6421	
EASControl unlock code	DA6427	DA6427

	IIDTool	IIDTool Bluetooth	EASControl	EASControl Bluetooth
Multiple vehicle type support (from V3.0, see list)		•		•
Integrated interface	•	•	•	•
Alternate interface for iOS (iPhone 4S, 5 and up, iPad 3rd gen and up, iPad Mini, iPod Touch 5 and up)		•		•
Alternate Interface for Android (devices fitted with a Bluetooth 4.0 transceiver and on OS 4.3 or higher)		•		•
Alternate interface with PC over USB	•	•	•	•
Updatable via USB	•	•	•	•
<b>Standard diagnostic functions (free of charge, from V3.0)</b>				
Faults read / clear on all vehicle systems	•	•		
Faults read / clear - suspension	•	•	•	•
Faults list export via e-mail	•	•		•
Service routines	•	•		
Service routines - suspension	•	•	•	•
Live data	•	•		
Live data - suspension	•	•	•	•
Manual components activation (output control)	•	•		
Manual components activation - suspension	•	•	•	•
<b>Enhanced functions (VIN locked, 1 free VIN)</b>				
Car configuration / personalisation (CCF editing)	•	•		
Control modules software updates (re-flashing)	•	•		
Component and system calibration	•	•		
Height adjustment, front, rear or all	•	•	•	•
Individual corner calibration (needed after a repair)	•	•	•	•
Original (default) values backed-up on first use	•	•	•	•
3 personalised height profiles memory slots	•	•	•	•



Integrated Interface Diagnostics Tool - Pro **NEW**

**IIDTOOL PRO**

**VIN UNLOCKED FOR ALL THESE...**

**Supported Vehicles**

- Defender - 2007 onwards
- Freelander 2
- Discovery 3
- Discovery 4
- Range Rover Sport - 2005 - 2013
- Range Rover Sport - 2014 onwards
- Range Rover L322
- Range Rover L405
- Range Rover Evoque
- Additional vehicles will be added in time.

*A professional diagnostic system tailored to the independent Land Rover garage.*

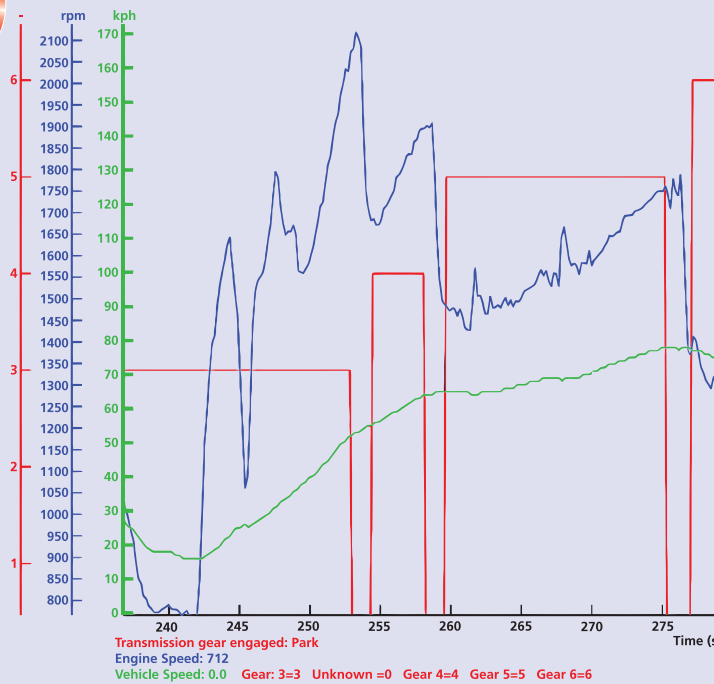

VIN unlocked

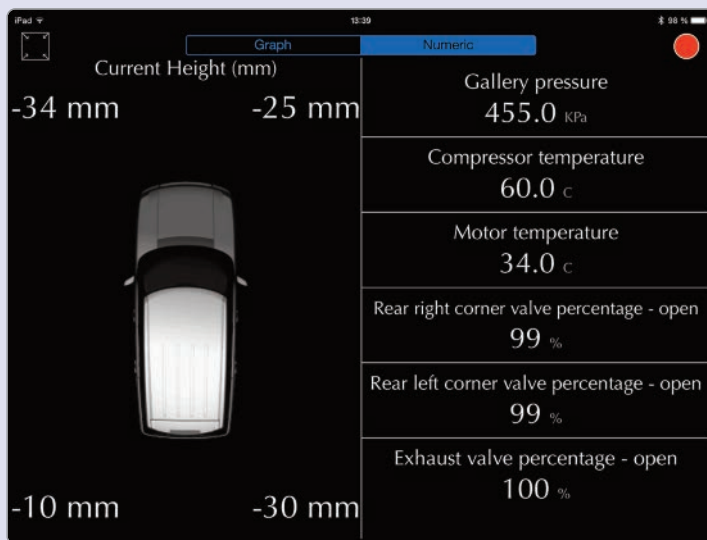

The IIDTool Pro will work on an iPad Mini, iPad 3rd gen and up, iPhone 4S, 5 and up, iPod Touch 5 and up, Android devices fitted with a Bluetooth 4.0 transceiver and running on OS 4.3 or higher (except for low cost Chinese devices). Please contact us for more details.

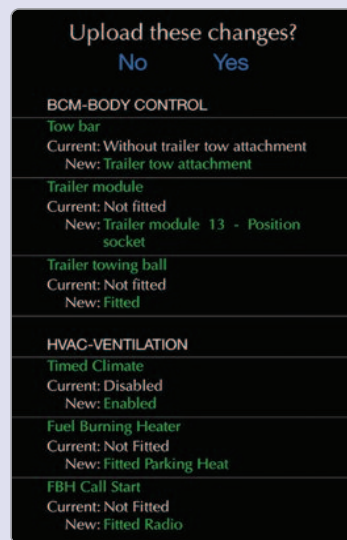

**DA6439 NEW**

**Completes multiple diagnostic tasks quickly and easily.**

- VIN unlocked
- Innovative mobile interface (app)
- Easy-to-use with no or minimal training required
- Reduces diagnostic time significantly
- Simple, compact design (no PC, cables etc) and with unparalleled support
- Fault list export via e-mail, all under 1 minute
- Up to 8 live values displayed at once on numerical and graph views.
- Logs can be saved, recalled and exported (PDF, CSV)
- ECU software updates embedded in the tool's memory
- Key programming
- Component system and sensor calibrations
- Vehicle personalisation including park heat activation, nav on move enablement (Discovery 3 & 4, Range Rover Sport - up to 2009 & Range Rover L322)
- And much, much more...

*Designed for the professional Land Rover technician yet it's easy-to-use with no or minimal training required.*

**GAP Diagnostic subscription package for the IIDTool Pro**

Updates are free for a period of one year after the date of purchase. Afterwards, IIDTool Pro firmware updates will be available for an annual fee. The IIDTool Pro firmware will be continually improved through the addition of new service routines, vehicle enhancements options (modified ECU firmware's etc), convenience features, new vehicle coverage and many more items. The annual fee will be adjusted once the product has matured and updates become less frequent. This annual fee is not mandatory; if you decide not to partake in this offer the tool will continue to function normally even without the latest firmware additions. For more information contact [www.gap-diagnostic.com](http://www.gap-diagnostic.com)

To see the functionality for each Land Rover model supported by the IIDTool Pro  
[www.britpart.com/iid-pro](http://www.britpart.com/iid-pro)

	All vehicles
<b>Multiple interface capability</b>	
iOS interface for mobile devices	•
Android interface for mobile devices	•
Integrated interface (cruise control buttons and instrument cluster screen - when available)	•
<b>Functions</b>	
Faults read/clear and export on all vehicle systems	•
Service routines (service reminder reset, EPB functions etc)	•
Live data on a digital and graphical scale. Can be exported - CSV & PDF	•
Manual components activation (output control)	•
Car configuration/personalisation (CCF editing)	•
Control modules software updates (re-flashing)	•
Component and system calibration	•
Air suspension height adjustment - front, rear or all	•
Air suspension individual corner calibration (needed after a repair)	•
Original (default) values backed-up on first use	•

*The IIDTool Pro - Fast..., Easy..., Comprehensive...*

## Lynx Diagnostics Interface

### What is Lynx?

Finding and rectifying common Land Rover electrical faults has never been easier. Britpart have worked closely with Omitec to design and build a highly advanced Land Rover diagnostic tool. As well as the multi-model professional version, a single Land Rover model home use version is available too.

The Lynx interface is Windows\* based and when running diagnostics on a Windows laptop or Windows tablet, far more information can be displayed to the user than on a hand held device. Being Windows based there is familiarity and flexibility with the interface and navigation is much more intuitive.

*Your complete Land Rover diagnostics tool!*

### What does Lynx do?

- Read fault codes
- Clear fault codes
- Read live data
- Record & play back live data
- Test actuators
- Special functions - see coverage chart
- Programming - such as alarm settings, key fobs etc.
- Service reset

### What do you get with Lynx?

- Windows compatible software
- Vehicle Communication Interface box (VCI)
- USB to VCI lead
- VCI to OBD II lead
- Quick start booklet
- Activation form
- Unlock code booklet
- Carry case with foam insert

**See opposite for full Lynx model coverage...**

### More about Lynx

As Lynx is Windows based, the system is future proofed due to your laptop or tablet's hard disk drive which allows for 'many more' numbers of updates compared to hand held devices. Lynx is powered by Omitec who build the T4 - Official Land Rover diagnostics tool. Live data can also be displayed using graphics; making it easier to read time based events. Live data can be recorded for a comparison, a great advantage over hand held diagnostic tools as they do not usually have storage memory. The Windows based tool allows simultaneous access to the vehicle diagnostics and consultation of circuit diagrams and other technical information. Lynx will also allow you to access the internet if you are connected to it whilst diagnosing a vehicle and other such programs you might need to use in a garage environment. Lynx is supplied in a hard wearing carry case with foam insert to protect it when not in use. For the enthusiast home user, using Lynx will mean no more trips to your local main dealer to clear any faults on your Land Rover.

### What do I need?

#### Multi-model professional version

Unlocked for all Land Rover models in Lynx range. See overleaf for full Lynx model coverage.

DA6431	English	DA6431ESP	Spanish
DA6431GER	German	DA6431FRA	French

#### Single model home user version

Unlocked for one Land Rover model only. Upgradable for extra Land Rover models at a later date.

DA6430	English	DA6430ESP	Spanish
DA6430GER	German	DA6430FRA	French
DA6434	Home user additional Land Rover model unlock code		

#### Extras

DA6432	14CUX lead - for use with hot wire V8 Efi vehicles
DA6433	Upgrade lead - power cable for use with firmware updates
DA6433EU	Upgrade lead - European 2-pin power cable for use with firmware updates



Developed in conjunction with Omitec



View live data with intuitive interface



Unlock codes available for home users



*For the workshop and home user...*

See Lynx in action and a FAQ section at -



[www.lynx-diagnostics.com](http://www.lynx-diagnostics.com)

Now compatible with Windows 8.1



Also available - Software Update...

Now released for all existing Lynx users.

[www.lynx-diagnostics.com/upgrade](http://www.lynx-diagnostics.com/upgrade)



\*Microsoft Windows based PC or tablet with - Microsoft Windows XP, Windows Vista, Windows 7 & Windows 8.1 operating system. DVD drive. 500MB available hard disk space (minimum). 1024 x 768 screen resolution (minimum). Administrative rights - only required for software installation.

**Lynx Vehicle Coverage**

Key  
 Version 2.6.2  
 ● Existing feature  
 ● Enhanced feature  
 ● New feature

Vehicle Model	Years	System	System Name	Read Fault Codes	Clear Fault Codes	Live Data	ECM Data	Actuators	Programming	Maintenance
Defender	1999 - 2007	Diesel EMS	TD5	●	●					
Defender	1994 - 2007	Petrol EMS	14CUX	●	●	●		●		
Defender	1994 - 1995	Petrol EMS	GEMS	●	●	●		●	●	●
Defender	1999 - 2007	ABS	WABCO D ABS	●	●	●	●	●	●	●
Defender	1996 - 2007	Security	10AS			●			●	
Defender	2007 - 2010	Drive - Diesel EMS	Diesel Engine Management System	●	●	●	●			●
Defender	2007 - 2010	Chassis - ABS	WABCO D ABS	●	●	●	●	●	●	●
Defender	2007 - 2010	Body - Instruments	IPC - Instrument Panel Control Module	●	●	●	●			
Defender	2007 - 2010	Body - Security	10AS			●			●	
Defender	2011	Drive - Diesel EMS	Diesel Engine Management System	●	●	●	●			●
Defender	2011	Chassis - ABS	ABS	●	●	●	●			
Defender	2011	Body - Instruments	IPC - Instrument Panel Control Module	●	●	●	●			
Defender	2011	Body - Security	10AS			●			●	
Defender	2012 -	Drive - Diesel EMS	PCM - Powertrain Control Module (Diesel)	●	●	●	●			●
Defender	2012 -	Chassis - ABS	ABS	●	●	●	●			
Defender	2012 -	Body - Instruments	IPC - Instrument Panel Control Module	●	●	●	●			
Defender	2012 -	Body - Security	10AS			●				●
Freelander 1	1998 - 2001	EMS - Diesel EMS	Bosch EDC 1.3.1	●	●	●	●	●		
Freelander 1	2001 - 2006	EMS - Diesel EMS	Bosch DDE4	●	●	●		●		
Freelander 1	1998 - 2001	EMS - Petrol EMS	MEMS 1.9	●	●	●		●		
Freelander 1	2001 - 2006	EMS - Petrol EMS	MEMS 3	●	●	●	●	●		
Freelander 1	2001 - 2006	EMS - Petrol EMS	Siemens EMS2000	●	●	●	●	●		
Freelander 1	2001 - 2006	EMS - Petrol EMS	Siemens MS43	●	●	●	●	●		
Freelander 1	1998 - 2006	Transmission	Jatco	●	●	●	●			
Freelander 1	1998 - 2001	ABS	WABCO D ABS	●	●	●	●	●	●	●
Freelander 1	2000 - 2001	ABS	TEVES MK20	●	●	●				
Freelander 1	2002 - 2006	ABS	TEVES MK25	●	●	●				
Freelander 1	1998 - 2002	Airbag	Autoliv ACU 4	●	●		●			
Freelander 1	2003 - 2006	Airbag	Siemens SRE Smart	●	●		●			
Freelander 1	1998 - 2001	Security	27VT - CCU			●		●	●	
Freelander 1	2000 - 2002	Security	EWS 3D	●	●	●		●	●	
Freelander 1	2000 - 2002	FFH	Fuel Fired Heater	●	●	●		●		●
Freelander 2	2007 - 2010	Drive - Diesel EMS	PCM - Power Train Control Module (Diesel)	●	●	●	●			●
Freelander 2	2007 - 2010	Drive - Petrol EMS	PCM - Power Train Control Module (Petrol)	●	●	●	●			
Freelander 2	2007 - 2010	Drive - Transmission	TCM - Transmission Control Module	●	●	●	●			●
Freelander 2	2007 - 2010	Drive - Transmission	RDCM - Rear Differential Control Module	●	●		●			
Freelander 2	2007 - 2010	Chassis - ABS/DSC	ABS / DSC - Antilocking brake System / Dynamic Stability Control	●	●	●	●			●
Freelander 2	2007 - 2010	Chassis - Steering Angle	SASM - Steering Angle Sensor Module	●	●	●	●			●
Freelander 2	2007 - 2010	Chassis - ATCM	ATCM - All Terrain Control Module	●	●		●			
Freelander 2	2007 - 2010	Body - Airbag	RCM - Restraints Control Module	●	●	●	●			●
Freelander 2	2007 - 2010	Body - Airbag	OCS - Occupancy Classification System	●	●	●	●			
Freelander 2	2007 - 2010	Body - Climate Control	HVAC - Heating, Ventilation and Air Conditioning	●	●	●	●			
Freelander 2	2007 - 2010	Body - Body Controller	BCM - Body Control Module	●	●	●	●			●
Freelander 2	2007 - 2010	Body - Instruments	IPC - Instrument Panel Control Module	●	●		●			●
Freelander 2	2007 - 2010	Body - Lighting Control	HCM - Headlamp Control Module	●	●		●			
Freelander 2	2007 - 2010	Body - Parking Aid	PAM - Parking Aid Module	●	●	●	●			
Freelander 2	2007 - 2010	Body - Fuel Fired Heater	FFH - Fuel Fired Heater	●	●	●	●			
Freelander 2	2007 - 2010	Body - Seating	DSM - Drivers Seat Module	●	●		●			
Freelander 2	2007 - 2010	Body - Doors	DDM - Drivers Door Module	●	●		●			
Freelander 2	2007 - 2010	Body - Doors	PDM - Passengers Door Module	●	●		●			
Freelander 2	2007 - 2010	Body - Trailer Module	TRM - Trailer Module	●	●		●			
Freelander 2	2007 - 2010	Infotainment - ICM	ICM - Infotainment Control Module	●	●		●			
Freelander 2	2007 - 2010	Service Function - Service Reset	IPC - Instrument Panel Control Module							●
Freelander 2	2007 - 2010	Global Function - Clear DTCs	High Speed CAN Clear DTCs		●					
Freelander 2	2007 - 2010	Global Function - Clear DTCs	Medium Speed CAN Clear DTCs		●					
Freelander 2	2007 - 2010	Global Functions - ECU Reset	High Speed CAN ECU Reset							●
Freelander 2	2007 - 2010	Global Functions - ECU Reset	Medium Speed CAN ECU Reset							●
Freelander 2	2011 -	Drive - Diesel EMS	PCM - Power Train Control Module (Diesel)	●	●	●	●			●
Freelander 2	2011 -	Drive - Petrol EMS	PCM - Power Train Control Module (Petrol)	●	●	●	●			
Freelander 2	2011 -	Drive - Transmission	TCM - Transmission Control Module	●	●	●	●			●
Freelander 2	2011 -	Drive - Transmission	RDCM - Rear Differential Control Module	●	●		●			
Freelander 2	2011 -	Chassis - ABS/DSC	ABS / DSC - Antilocking brake System / Dynamic Stability Control	●	●	●	●			●
Freelander 2	2011 -	Chassis - Steering Angle	SASM - Steering Angle Sensor Module	●	●	●	●			●
Freelander 2	2011 -	Chassis - ATCM	ATCM - All Terrain Control Module	●	●		●			
Freelander 2	2011 -	Body - Airbag	RCM - Restraints Control Module	●	●	●	●			●
Freelander 2	2011 -	Body - Airbag	OCS - Occupancy Classification System	●	●	●	●			
Freelander 2	2011 -	Body - Climate Control	HVAC - Heating, Ventilation and Air Conditioning	●	●	●	●			●
Freelander 2	2011 -	Body - Body Controller	BCM - Body Control Module	●	●	●	●			●
Freelander 2	2011 -	Body - Instruments	IPC - Instrument Panel Control Module	●	●		●			●
Freelander 2	2011 -	Body - Lighting Control	HCM - Headlamp Control Module	●	●		●			
Freelander 2	2011 -	Body - Parking Aid	PAM - Parking Aid Module	●	●	●	●			
Freelander 2	2011 -	Body - Fuel Fired Heater	FFH - Fuel Fired Heater	●	●	●	●			
Freelander 2	2011 -	Body - Seating	DSM - Drivers Seat Module	●	●		●			
Freelander 2	2011 -	Body - Doors	DDM - Drivers Door Module	●	●		●			
Freelander 2	2011 -	Body - Doors	PDM - Passengers Door Module	●	●		●			
Freelander 2	2011 -	Body - Trailer Module	TRM - Trailer Module	●	●		●			
Freelander 2	2011 -	Infotainment - ICM	ICM - Infotainment Control Module	●	●		●			
Freelander 2	2011 -	Service Function - Service Reset	Service Reset							●
Freelander 2	2011 -	Global Function - Clear DTCs	High Speed CAN Clear DTCs		●					

## Lynx Vehicle Coverage - continued

Key  
 Version 2.6.2  
 ● Existing feature  
 ● Enhanced feature  
 ● New feature

Vehicle Model	Years	System	System Name	Read Fault Codes	Clear Fault Codes	Live Data	ECM Data	Actuators	Programming	Maintenance
Freelander 2	2011 -	Global Function - Clear DTCs	Medium Speed CAN Clear DTCs		●					
Freelander 2	2011 -	Global Functions - ECU Reset	High Speed CAN ECU Reset							●
Freelander 2	2011 -	Global Functions - ECU Reset	Medium Speed CAN ECU Reset							●
Discovery 1	1996 - 1998	EMS - Diesel EMS	Bosch EDC 1.3.1	●	●	●	●	●		
Discovery 1	1995 - 1998	EMS - Petrol EMS	14CUX	●	●	●	●	●		
Discovery 1	1996 - 1998	EMS - Petrol EMS	GEMS	●	●	●	●	●	●	●
Discovery 1	1993 - 1998	EMS - Petrol EMS	MEMS 1.9	●	●	●	●	●		
Discovery 1	1995 - 1996	ABS	WABCO C ABS	●	●	●		●		
Discovery 1	1995 - 1996	Airbag	TRW MPS	●	●					
Discovery 1	1996 - 1998	Airbag	TRW SPS	●	●		●			
Discovery 1	1996 - 1998	Security	10AS			●			●	
Discovery 2	1998 - 2005	Diesel EMS	TD5	●	●	●		●	●	
Discovery 2	1998 - 2005	Petrol EMS	Bosch M5.2.1	●	●	●	●	●		●
Discovery 2	1998 - 2005	Transmission	GS 8.87.X	●	●	●	●		●	●
Discovery 2	1998 - 2005	ABS	WABCO D ABS/SLABS	●	●	●	●	●	●	●
Discovery 2	1998 - 2005	Airbag	TRW Generation 4	●	●		●			
Discovery 2	1998 - 2005	Security	Valeo BCU			●		●	●	
Discovery 2	1998 - 2005	Chassis	ACE - Suspension (ROCK/ARC)	●	●	●	●	●	●	
Discovery 2	1998 - 2005	Chassis	WABCO D ABS/SLABS - Suspension	●	●	●	●	●	●	●
Discovery 3	2005 - 2009	Drive - Diesel EMS	PCM - Power Train Control Module (Diesel)	●	●	●	●	●		●
Discovery 3	2005 - 2009	Drive - Petrol EMS	PCM - Power Train Control Module (Petrol)	●	●	●	●			●
Discovery 3	2005 - 2009	Drive - Transmission	TCM - Transmission Control Module	●	●	●	●			●
Discovery 3	2005 - 2009	Drive - Transmission	RDCM - Rear Differential Control Module	●	●	●	●			
Discovery 3	2005 - 2009	Drive - Transfer Case	TCCM - Transfer Case Control Module	●	●	●	●			
Discovery 3	2005 - 2009	Drive - Adaptive Cruise Control	CCM - Cruise Control Module	●	●	●	●			
Discovery 3	2005 - 2009	Chassis - ABS / DSC	ABS / DSC - Antilocking brake System / Dynamic Stability Control	●	●	●	●			●
Discovery 3	2005 - 2009	Chassis - Steering Angle	SASM - Steering Angle Sensor Module	●	●	●	●			●
Discovery 3	2005 - 2009	Chassis - Park Brake	PBM - Park Brake Module	●	●	●	●			●
Discovery 3	2005 - 2009	Chassis - TPMS	TPMS - Tyre Pressure Monitoring System	●	●	●	●			●
Discovery 3	2005 - 2009	Chassis - ATCM	ATCM - All Terrain Control Module	●	●	●	●			
Discovery 3	2005 - 2009	Chassis - Suspension	RLM - Ride Level Control Module	●	●	●	●			●
Discovery 3	2005 - 2009	Body - Airbag	RCM - Restraints Control Module	●	●	●	●			
Discovery 3	2005 - 2009	Body - Climate Control	HVAC - Heating Ventilation Air Conditioning Control Module	●	●	●	●			
Discovery 3	2005 - 2009	Body - Body Control	BCM - Body Control Module	●	●	●	●			
Discovery 3	2005 - 2009	Body - Instruments	IPC - Instrument Panel Control Module	●	●	●	●			●
Discovery 3	2005 - 2009	Body - Lighting Control	FLM - Front Lighting Module	●	●	●	●			
Discovery 3	2005 - 2009	Body - Parking Aid	PAM - Parking Aid Module	●	●	●	●			
Discovery 3	2005 - 2009	Body - Fuel Fired Heater	FFH - Fuel Fired Heater	●	●	●	●			
Discovery 3	2005 - 2009	Infotainment - Audio and Visual	AAM - Audio Amplifier Module	●	●	●	●			
Discovery 3	2005 - 2009	Infotainment - Audio and Visual	ACM - Audio Control Module	●	●	●	●			
Discovery 3	2005 - 2009	Infotainment - Audio and Visual	FEM - Front Electronic Module	●	●	●	●			
Discovery 3	2005 - 2009	Infotainment - Audio and Visual	DACMC - Digital Audio Control Module 'C'	●	●	●	●			
Discovery 3	2005 - 2009	Infotainment - Audio and Visual	SRM - Satellite Audio Unit Module	●	●	●	●			
Discovery 3	2005 - 2009	Infotainment - Audio and Visual	TVM - Television Module	●	●	●	●			
Discovery 3	2005 - 2009	Infotainment - REM	REM - Rear Entertainment Control Module	●	●	●	●			
Discovery 3	2005 - 2009	Infotainment - TEL	TEL - Cellular Telephone Control Module	●	●	●	●			
Discovery 3	2005 - 2009	Infotainment - TMC	TMC - Traffic Message Channel Module	●	●	●	●			
Discovery 3	2005 - 2009	Service Functions - Service Reset	IPC - Instrument Panel Control Module							●
Discovery 3	2005 - 2009	Global Function - Clear DTCs	High Speed CAN Clear DTCs		●					
Discovery 3	2005 - 2009	Global Function - Clear DTCs	Medium Speed CAN Clear DTCs		●					
Discovery 3	2005 - 2009	Global Functions - ECU Reset	High Speed CAN ECU Reset							●
Discovery 3	2005 - 2009	Global Functions - ECU Reset	Medium Speed CAN ECU Reset							●
Discovery 4	2010 - 2011	Drive - Diesel EMS	PCM - Power Train Control Module (Diesel V6 2.7)	●	●	●	●			●
Discovery 4	2010 - 2011	Drive - Diesel EMS	PCM - Power Train Control Module (Diesel V6 3.0)	●	●	●	●			●
Discovery 4	2010 - 2011	Drive - Petrol EMS	PCM - Power Train Control Module (Petrol V6)	●	●	●	●			
Discovery 4	2010 - 2011	Drive - Petrol EMS	PCM - Power Train Control Module (Petrol V8)	●	●	●	●			
Discovery 4	2010 - 2011	Drive - Transmission	TCM - Transmission Control Module (Diesel V6 2.7)	●	●	●	●			
Discovery 4	2010 - 2011	Drive - Transmission	TCM - Transmission Control Module (Diesel V6 3.0)	●	●	●	●			
Discovery 4	2010 - 2011	Drive - Transmission	TCM - Transmission Control Module (Petrol V6)	●	●	●	●			
Discovery 4	2010 - 2011	Drive - Transmission	TCM - Transmission Control Module (Petrol V8)	●	●	●	●			
Discovery 4	2010 - 2011	Drive - Transmission	RDCM - Rear Differential Control Module	●	●	●	●			
Discovery 4	2010 - 2011	Drive - Transfer Case	TCCM - Transfer Case Control Module	●	●	●	●			
Discovery 4	2010 - 2011	Drive - Adaptive Cruise Control	CCM - Cruise Control Module	●	●	●	●			
Discovery 4	2010 - 2011	Chassis - ABS / DSC	ABS / DSC - Antilocking brake System / Dynamic Stability Control	●	●	●	●			●
Discovery 4	2010 - 2011	Chassis - Steering Angle	SASM - Steering Angle Sensor Module	●	●	●	●			●
Discovery 4	2010 - 2011	Chassis - Park Brake	PBM - Park Brake Module	●	●	●	●			●
Discovery 4	2010 - 2011	Chassis - ATCM	ATCM - All Terrain Control Module	●	●	●	●			
Discovery 4	2010 - 2011	Chassis - Suspension	RLM - Ride Level Control Module	●	●	●	●			●
Discovery 4	2010 - 2011	Body - Airbag	RCM - Restraints Control Module	●	●	●	●			
Discovery 4	2010 - 2011	Body - Airbag	OCS - Occupancy Classification System	●	●	●	●			
Discovery 4	2010 - 2011	Body - Climate Control	HVAC - Heating Ventilation Air Conditioning Control Module	●	●	●	●			
Discovery 4	2010 - 2011	Body - Body Controller	BCM - Body Control Module	●	●	●	●			●
Discovery 4	2010 - 2011	Body - Instruments	IPC - Instrument Panel Control Module	●	●	●	●			●
Discovery 4	2010 - 2011	Body - Lighting Control	HCM - Headlamp Control Module	●	●	●	●			
Discovery 4	2010 - 2011	Body - Lighting Control	HCMB - Headlamp Control Module 'B'	●	●	●	●			
Discovery 4	2010 - 2011	Body - Parking Aid	PAM - Parking Aid Module	●	●	●	●			
Discovery 4	2010 - 2011	Body - Immobiliser	Immobiliser	●	●	●	●			
Discovery 4	2010 - 2011	Body - Fuel Fired Heater	FFH - Fuel Fired Heater	●	●	●	●			
Discovery 4	2010 - 2011	Body - Seating	DSM - Drivers Seat Module	●	●	●	●			
Discovery 4	2010 - 2011	Body - Doors	DDM - Drivers Door Module	●	●	●	●			

**Lynx Vehicle Coverage - continued**

Key  
 Version 2.6.2  
 ● Existing feature  
 ● Enhanced feature  
 ● New feature

Vehicle Model	Years	System	System Name	Read Fault Codes	Clear Fault Codes	Live Data	ECM Data	Actuators	Programming	Maintenance
Discovery 4	2010 - 2011	Body - Doors	PDM - Passengers Door Module	●	●					
Discovery 4	2010 - 2011	Body - KVM	KVM - Keyless Vehicle Module	●	●		●			
Discovery 4	2010 - 2011	Infotainment - Audio and Visual	AAM - Audio Amplifier Module	●	●		●			
Discovery 4	2010 - 2011	Infotainment - Audio and Visual	ACM - Audio Control Module	●	●		●			
Discovery 4	2010 - 2011	Infotainment - Audio and Visual	FEM - Front Electronic Module	●	●		●			
Discovery 4	2010 - 2011	Infotainment - Audio and Visual	FCDIM - Front Control / Display Interface Module	●	●		●			
Discovery 4	2010 - 2011	Infotainment - Audio and Visual	FCIM - Front Control Interface Module	●	●		●			
Discovery 4	2010 - 2011	Infotainment - Audio and Visual	FCIMB - Front Control Interface Module 'B'	●	●		●			
Discovery 4	2010 - 2011	Infotainment - Audio and Visual	DABM - Digital Audio Broadcast Module	●	●		●			
Discovery 4	2010 - 2011	Infotainment - Audio and Visual	DACMC - Digital Audio Control Module 'C'	●	●		●			
Discovery 4	2010 - 2011	Infotainment - Audio and Visual	SRM - Satellite Audio Unit Module	●	●		●			
Discovery 4	2010 - 2011	Infotainment - Audio and Visual	TVM - Television Module	●	●		●			
Discovery 4	2010 - 2011	Infotainment - APIM	APIM - Accessory Protocol Interface Module	●	●		●			
Discovery 4	2010 - 2011	Infotainment - REM	REM - Rear Entertainment Control Module	●	●		●			
Discovery 4	2010 - 2011	Infotainment - TEL	TEL - Cellular Telephone Control Module	●	●		●			
Discovery 4	2010 - 2011	Infotainment - SPRM	SPRM - Speech Recognition Control Module	●	●		●			
Discovery 4	2010 - 2011	Infotainment - IPMB	IPMB - Image Processing Module 'B'	●	●		●			
Discovery 4	2010 - 2011	Service Functions - Service Reset	IPC - Instrument Panel Control Module							●
Discovery 4	2010 - 2011	Global Function - Clear DTCs	High Speed CAN Clear DTCs		●					
Discovery 4	2010 - 2011	Global Function - Clear DTCs	Medium Speed CAN Clear DTCs		●					
Discovery 4	2010 - 2011	Global Functions - ECU Reset	High Speed CAN ECU Reset							●
Discovery 4	2010 - 2011	Global Functions - ECU Reset	Medium Speed CAN ECU Reset							●
Discovery 4	2012 -	Drive - Diesel EMS	PCM - Power Train Control Module (Diesel V6 2.7)	●	●	●	●			●
Discovery 4	2012 -	Drive - Diesel EMS	PCM - Power Train Control Module (Diesel V6 3.0)	●	●	●	●			●
Discovery 4	2012 -	Drive - Petrol EMS	PCM - Power Train Control Module (Petrol)	●	●	●	●			
Discovery 4	2012 -	Drive - Transmission	TCM - Transmission Control Module (Diesel V6 2.7)	●	●	●	●			
Discovery 4	2012 -	Drive - Transmission	TCM - Transmission Control Module (Diesel V6 3.0)	●	●	●	●			
Discovery 4	2012 -	Drive - Transmission	TCM - Transmission Control Module (Petrol)	●	●	●	●			
Discovery 4	2012 -	Drive - Transmission	GSM - Gear Shift Module	●	●		●			
Discovery 4	2012 -	Drive - Transmission	RDCM - Rear Differential Control Module	●	●		●			
Discovery 4	2012 -	Drive - Transfer Case	TCCM - Transfer Case Control Module	●	●		●			
Discovery 4	2012 -	Chassis - ABS / DSC	ABS / DSC - Antilocking brake System / Dynamic Stability Control	●	●	●	●			●
Discovery 4	2012 -	Chassis - Steering Angle	SASM - Steering Angle Sensor Module	●	●		●			●
Discovery 4	2012 -	Chassis - Park Brake	PBM - Park Brake Module	●	●	●	●			●
Discovery 4	2012 -	Chassis - ATCM	ATCM - All Terrain Control Module	●	●		●			
Discovery 4	2012 -	Chassis - Suspension	RLM - Ride Level Control Module	●	●	●	●			●
Discovery 4	2012 -	Body - Airbag	RCM - Restraints Control Module	●	●	●	●			
Discovery 4	2012 -	Body - Airbag	OCS - Occupancy Classification System	●	●	●	●			
Discovery 4	2012 -	Body - Climate Control	HVAC - Heating Ventilation Air Conditioning Control Module	●	●		●			
Discovery 4	2012 -	Body - Body Controller	BCM - Body Control Module	●	●	●	●			●
Discovery 4	2012 -	Body - Instruments	IPC - Instrument Panel Control Module	●	●		●			●
Discovery 4	2012 -	Body - Lighting Control	HCM - Headlamp Control Module	●	●		●			
Discovery 4	2012 -	Body - Lighting Control	HCMB - Headlamp Control Module 'B'	●	●		●			
Discovery 4	2012 -	Body - Parking Aid	PAM - Parking Aid Module	●	●	●	●			
Discovery 4	2012 -	Body - Immobiliser	Immobiliser	●	●		●			
Discovery 4	2012 -	Body - Fuel Fired Heater	FFH - Fuel Fired Heater	●	●	●	●			
Discovery 4	2012 -	Body - Doors	DDM - Drivers Door Module	●	●		●			
Discovery 4	2012 -	Body - Doors	PDM - Passengers Door Module	●	●		●			
Discovery 4	2012 -	Body - KVM	KVM - Keyless Vehicle Module	●	●		●			
Discovery 4	2012 -	Infotainment - Audio and Visual	FCDIM - Front Control / Display Interface Module	●	●		●			
Discovery 4	2012 -	Infotainment - Audio and Visual	FCIM - Front Control Interface Module	●	●		●			
Discovery 4	2012 -	Infotainment - Audio and Visual	FCIMB - Front Control Interface Module 'B'	●	●		●			
Discovery 4	2012 -	Infotainment - IPMB	IPMB - Image Processing Module 'B'	●	●		●			
Discovery 4	2012 -	Service Functions - Service Reset	IPC - Instrument Panel Control Module							●
Discovery 4	2012 -	Global Function - Clear DTCs	High Speed CAN Clear DTCs		●					
Discovery 4	2012 -	Global Function - Clear DTCs	Medium Speed CAN Clear DTCs		●					
Discovery 4	2012 -	Global Functions - ECU Reset	High Speed CAN ECU Reset							●
Discovery 4	2012 -	Global Functions - ECU Reset	Medium Speed CAN ECU Reset							●
Range Rover Classic	1990 - 1995	Petrol EMS	14CUX	●	●	●		●		
Range Rover P38	1995 - 2002	Diesel EMS	Bosch EDC 1.3.1	●	●	●	●	●		
Range Rover P38	1999 - 2002	Petrol EMS	Bosch M5.2.1	●	●	●	●	●		●
Range Rover P38	1995 - 1999	Petrol EMS	GEMS	●	●	●	●	●	●	●
Range Rover P38	1998 - 2002	Transmission	GS 2.38	●	●	●	●			
Range Rover P38	1998 - 2002	Transmission	GS 8.87.X	●	●	●	●		●	●
Range Rover P38	1995 - 1999	ABS	WABCO C ABS	●	●	●	●	●		
Range Rover P38	1999 - 2002	ABS	WABCO D ABS	●	●	●	●	●	●	
Range Rover P38	1995 - 1999	Airbag	TRW MPS	●	●					
Range Rover P38	1995 - 2002	Airbag	TRW SPS	●	●		●			
Range Rover P38	1998 - 2002	Airbag	TRW Gen 4	●	●		●			
Range Rover P38	1998 - 2002	Climate Control	HVAC - Heating Ventilation Air Conditioning Control Module	●	●					
Range Rover P38	1995 - 2002	Chassis	Air Suspension	●	●	●		●		●
Range Rover P38	1995 - 2002	Body Electrics	BeCM	●	●	●		●	●	●



*Your complete Land Rover diagnostics tool!*

## Lynx Vehicle Coverage - continued

Key  
 Version 2.6.2  
 ● Existing feature  
 ● Enhanced feature  
 ● New feature

Vehicle Model	Years	System	System Name	Read Fault Codes	Clear Fault Codes	Live Data	ECM Data	Actuators	Programming	Maintenance
Range Rover L322	2002 - 2005	Drive - Diesel EMS	Bosch DDE4	●	●	●	●	●		
Range Rover L322	2002 - 2005	Drive - Petrol EMS	Bosch ME7.2	●	●	●	●	●		
Range Rover L322	2002 - 2005	Drive - Transmission	GM5 / EGS 20	●	●	●	●	●		
Range Rover L322	2002 - 2005	Drive - Transmission	ZF / EGS 8602	●	●	●	●	●		
Range Rover L322	2002 - 2005	Chassis - ABS / DSC	Bosch 5.7	●	●					
Range Rover L322	2002 - 2005	Chassis - Steering Angle	Steering Angle	●	●					●
Range Rover L322	2002 - 2005	Chassis - Air Suspension	EHC2	●	●	●	●	●		●
Range Rover L322	2002 - 2005	Body - Airbag	MRS 4	●	●		●			
Range Rover L322	2002 - 2005	Body - Climate Control	HVAC - Heating Ventilation Air Conditioning Control Module	●	●					
Range Rover L322	2002 - 2005	Body - Body Electrics	GM3	●	●	●	●			
Range Rover L322	2002 - 2005	Body - Security	EWS3	●	●	●	●			
Range Rover L322	2002 - 2005	Body - Fuel Fired Heater	Fuel Fired Heater	●	●	●	●	●		
Range Rover L322	2002 - 2005	Infotainment - Audio and Video	AAM - Audio Amplifier Module	●	●		●			
Range Rover L322	2002 - 2005	Infotainment - Audio and Video	ACM - Audio Control Module	●	●		●			
Range Rover L322	2002 - 2005	Infotainment - Audio and Video	FEM - Front Electronic Module	●	●		●			
Range Rover L322	2002 - 2005	Infotainment - Audio and Video	CDP - Compact Disc Player	●	●		●			
Range Rover L322	2002 - 2005	Infotainment - Audio and Video	SRM - Satellite Audio Unit Module	●	●		●			
Range Rover L322	2002 - 2005	Infotainment - Audio and Video	TVM - Television Module	●	●		●			
Range Rover L322	2002 - 2005	Infotainment - REM	REM - Rear Entertainment Control Module	●	●		●			
Range Rover L322	2002 - 2005	Infotainment - TEL	TEL - Cellular Telephone Control Module	●	●		●			
Range Rover L322	2002 - 2005	Infotainment - TMC	TMC - Traffic Message Channel Module	●	●		●			
Range Rover L322	2002 - 2005	Service Function - Service Reset	Service Reset							●
Range Rover L322	2006	Drive - Diesel EMS	Bosch DDE4	●	●	●	●	●		
Range Rover L322	2006	Drive - Petrol EMS	Denso PAN PAG	●	●	●	●			●
Range Rover L322	2006	Drive - Transmission (Diesel)	GM5 / EGS 20	●	●	●	●	●		
Range Rover L322	2006	Drive - Transmission (Petrol)	TCM - Transmission Control Module	●	●	●	●			●
Range Rover L322	2006	Drive - Transmission	TCCM - Transfer Case Control Module	●	●		●			
Range Rover L322	2006	Chassis - ABS (Diesel)	Bosch 5.7	●	●		●			
Range Rover L322	2006	Chassis - ABS (Petrol)	Bosch 8	●	●	●	●			
Range Rover L322	2006	Chassis - Steering Angle (Diesel)	SASM - Steering Angle Sensor Module	●	●					●
Range Rover L322	2006	Chassis - Steering Angle (Petrol)	SASM - Steering Angle Sensor Module	●	●					●
Range Rover L322	2006	Chassis - TPMS	TPMS - Tyre Pressure Monitoring System	●	●	●	●			
Range Rover L322	2006	Chassis - Air Suspension	RLM - Ride Level Control Module	●	●	●	●	●		●
Range Rover L322	2006	Body - Airbag	MRS 4	●	●		●			
Range Rover L322	2006	Body - Climate Control	HVAC - Heating Ventilation Air Conditioning Control Module	●	●					
Range Rover L322	2006	Body - Body Electrics	GM3	●	●	●	●			
Range Rover L322	2006	Body - Instruments	IPC - Instrument Panel Control Module	●	●		●			●
Range Rover L322	2006	Body - Lighting Control	FLM - Front Lighting Module	●	●		●			
Range Rover L322	2006	Body - Security	Body Controller	●	●		●			
Range Rover L322	2006	Body - Fuel Fired Heater	Fuel Fired Heater	●	●	●	●	●		
Range Rover L322	2006	Body - RDUM	RDUM - Remote Driver Utility Module	●	●		●			
Range Rover L322	2006	Infotainment - Audio and Video	AAM - Audio Amplifier Module	●	●		●			
Range Rover L322	2006	Infotainment - Audio and Video	ACM - Audio Control Module	●	●		●			
Range Rover L322	2006	Infotainment - Audio and Video	FEM - Front Electronic Module	●	●		●			
Range Rover L322	2006	Infotainment - Audio and Video	CDP - Compact Disc Player	●	●		●			
Range Rover L322	2006	Infotainment - Audio and Video	SRM - Satellite Audio Unit Module	●	●		●			
Range Rover L322	2006	Infotainment - Audio and Video	TVM - Television Module	●	●		●			
Range Rover L322	2006	Infotainment - REM	REM - Rear Entertainment Control Module	●	●		●			
Range Rover L322	2006	Infotainment - TEL	TEL - Cellular Telephone Control Module	●	●		●			
Range Rover L322	2006	Infotainment - TMC	TMC - Traffic Message Channel Module	●	●		●			
Range Rover L322	2006	Service Function - Service Reset	Service Reset							●
Range Rover L322	2007 - 2009	Drive - Diesel EMS	PCM - Power Train Control Module (Diesel)	●	●	●	●			●
Range Rover L322	2007 - 2009	Drive - Petrol EMS	PCM - Power Train Control Module (Petrol)	●	●	●	●			●
Range Rover L322	2007 - 2009	Drive - Transmission	TCM - Transmission Control Module	●	●	●	●			●
Range Rover L322	2007 - 2009	Drive - Transmission	RDCM - Rear Differential Control Module	●	●		●			
Range Rover L322	2007 - 2009	Drive - Transfer Case	TCCM - Transfer Case Control Module	●	●		●			
Range Rover L322	2007 - 2009	Chassis - ABS / DSC	ABS / DSC - Antilocking brake System / Dynamic Stability Control	●	●	●	●			
Range Rover L322	2007 - 2009	Chassis - Steering Angle	SASM - Steering Angle Sensor Module	●	●					●
Range Rover L322	2007 - 2009	Chassis - Parking Brake	PBM - Park Brake Module	●	●	●	●			●
Range Rover L322	2007 - 2009	Chassis - TPMS	TPMS - Tyre Pressure Monitoring System	●	●	●	●			
Range Rover L322	2007 - 2009	Chassis - ATCM	ATCM - All Terrain Control Module	●	●		●			
Range Rover L322	2007 - 2009	Chassis - Suspension	RLM - Ride Level Control Module	●	●	●	●	●		●
Range Rover L322	2007 - 2009	Body - Airbag	RCM - Restraints Control Module	●	●	●	●			
Range Rover L322	2007 - 2009	Body - Airbag	OCS - Occupancy Classification System	●	●	●	●			
Range Rover L322	2007 - 2009	Body - Climate Control	HVAC - Heating Ventilation Air Conditioning Control Module	●	●					
Range Rover L322	2007 - 2009	Body - Climate Control	RHVAC - Rear Heating Ventilation Air Conditioning Control Module	●	●		●			
Range Rover L322	2007 - 2009	Body - Body Electrics	GM3	●	●	●	●			
Range Rover L322	2007 - 2009	Body - Instruments	IPC - Instrument Panel Control Module	●	●		●			●
Range Rover L322	2007 - 2009	Body - Lighting Control	FLM - Front Lighting Module	●	●		●			
Range Rover L322	2007 - 2009	Body - Security	Immobiliser	●	●		●			
Range Rover L322	2007 - 2009	Body - Fuel Fired Heater	FFH - Fuel Fired Heater	●	●	●	●			
Range Rover L322	2007 - 2009	Body - Seating	DCSM - Drivers Climate Seat Module	●	●		●			
Range Rover L322	2007 - 2009	Body - RBM	RBM - Running Board Control Module	●	●		●			
Range Rover L322	2007 - 2009	Body - RDUM	RDUM - Remote Driver Utility Module	●	●		●			
Range Rover L322	2007 - 2009	Infotainment - Audio and Video	AAM - Audio Amplifier Module	●	●		●			
Range Rover L322	2007 - 2009	Infotainment - Audio and Video	ACM - Audio Control Module	●	●		●			
Range Rover L322	2007 - 2009	Infotainment - Audio and Video	FEM - Front Electronic Module	●	●		●			
Range Rover L322	2007 - 2009	Infotainment - Audio and Video	CDP - Compact Disc Player	●	●		●			
Range Rover L322	2007 - 2009	Infotainment - Audio and Video	SRM - Satellite Audio Unit Module	●	●		●			
Range Rover L322	2007 - 2009	Infotainment - Audio and Video	TVM - Television Module	●	●		●			
Range Rover L322	2007 - 2009	Infotainment - REM	REM - Rear Entertainment Control Module	●	●		●			

**Lynx Vehicle Coverage - continued**

Key  
 ● Existing feature  
 ● Enhanced feature  
 ● New feature

Vehicle Model	Years	System	System Name	Read Fault Codes	Clear Fault Codes	Live Data	ECM Data	Actuators	Programming	Maintenance
Range Rover L322	2007 - 2009	Infotainment - TEL	TEL - Cellular Telephone Control Module	●	●					
Range Rover L322	2007 - 2009	Infotainment - TMC	TMC - Traffic Message Channel Module	●	●		●			
Range Rover L322	2007 - 2009	Service Functions - Service Reset	IPC - Instrument Panel Control Module							●
Range Rover L322	2010 - 2012	Diesel - V8 3.6 - Engine	PCM - Power Train Control Module (Diesel)	●	●	●	●			●
Range Rover L322	2010 - 2012	Diesel - V8 3.6 - Transmission	TCM - Transmission Control Module	●	●	●	●			
Range Rover L322	2010 - 2012	Diesel - V8 3.6 - Transmission	RDCM - Rear Differential Control Module	●	●		●			
Range Rover L322	2010 - 2012	Diesel - V8 3.6 - Transfer Case	TCCM - Transfer Case Control Module	●	●	●	●			
Range Rover L322	2010 - 2012	Diesel - V8 3.6 - Adaptive Cruise Control	CCM - Cruise Control Module	●	●	●	●			
Range Rover L322	2010 - 2012	Diesel - V8 4.4 - Engine	PCM - Power Train Control Module (Diesel)	●	●	●	●			●
Range Rover L322	2010 - 2012	Diesel - V8 4.4 - Transmission	TCM - Transmission Control Module	●	●	●	●			
Range Rover L322	2010 - 2012	Diesel - V8 4.4 - Transmission	GSM - Gear Shift Module	●	●	●	●			
Range Rover L322	2010 - 2012	Diesel - V8 4.4 - Transmission	RDCM - Rear Differential Control Module	●	●		●			
Range Rover L322	2010 - 2012	Diesel - V8 4.4 - Transfer Case	TCCM - Transfer Case Control Module	●	●	●	●			
Range Rover L322	2010 - 2012	Diesel - V8 4.4 - Adaptive Cruise Control	CCM - Cruise Control Module	●	●		●			
Range Rover L322	2010 - 2012	Petrol - Engine	PCM - Power Train Control Module (Petrol)	●	●	●	●			
Range Rover L322	2010 - 2012	Petrol - Transmission	TCM - Transmission Control Module	●	●	●	●			
Range Rover L322	2010 - 2012	Petrol - Transmission	RDCM - Rear Differential Control Module	●	●		●			
Range Rover L322	2010 - 2012	Petrol - Transfer Case	TCCM - Transfer Case Control Module	●	●	●	●			
Range Rover L322	2010 - 2012	Petrol - Adaptive Cruise Control	CCM - Cruise Control Module	●	●	●	●			
Range Rover L322	2010 - 2012	Chassis - ABS / DSC	ABS / DSC - Antilocking brake System / Dynamic Stability Control	●	●	●	●			
Range Rover L322	2010 - 2012	Chassis - Steering Angle	SASM - Steering Angle Sensor Module	●	●		●			●
Range Rover L322	2010 - 2012	Chassis - Parking Brake	PBM - Park Brake Module	●	●	●	●			●
Range Rover L322	2010 - 2012	Chassis - Suspension	RLM - Ride Level Control Module	●	●	●	●			●
Range Rover L322	2010 - 2012	Chassis - Suspension	ADCM - Adaptive Damping Control Module	●	●		●			
Range Rover L322	2010 - 2012	Chassis - Chassis	ATCM - All Terrain Control Module	●	●		●			
Range Rover L322	2010 - 2012	Body - Airbag	RCM - Restraints Control Module	●	●	●	●			
Range Rover L322	2010 - 2012	Body - Airbag	OCS - Occupancy Classification System	●	●	●	●			
Range Rover L322	2010 - 2012	Body - Climate Control	HVAC - Heating Ventilation Air Conditioning Control Module	●	●		●			
Range Rover L322	2010 - 2012	Body - Climate Control	RHVAC - Rear Heating Ventilation Air Conditioning Control Module	●	●		●			
Range Rover L322	2010 - 2012	Body - Body Controller	BCM - Body Control Module	●	●	●	●			●
Range Rover L322	2010 - 2012	Body - Instruments	IPC - Instrument Panel Control Module	●	●	●	●			●
Range Rover L322	2010 - 2012	Body - Lighting Control	HCM - Headlamp Control Module	●	●		●			
Range Rover L322	2010 - 2012	Body - Lighting Control	HCMB - Headlamp Control Module 'B'	●	●		●			
Range Rover L322	2010 - 2012	Body - Parking Aid	PAM - Parking Aid Module	●	●	●	●			
Range Rover L322	2010 - 2012	Body - Object Detection	SODL - Side Object Detection Module Left	●	●		●			
Range Rover L322	2010 - 2012	Body - Object Detection	SODR - Side Object Detection Module Right	●	●		●			
Range Rover L322	2010 - 2012	Body - Immobiliser	Immobiliser	●	●		●			
Range Rover L322	2010 - 2012	Body - Fuel-Fired Heater	FFH - Fuel Fired Heater	●	●	●	●			
Range Rover L322	2010 - 2012	Body - Seating	DSM - Drivers Seat Module	●	●		●			
Range Rover L322	2010 - 2012	Body - Seating	PSM - Passengers Sear Module	●	●		●			
Range Rover L322	2010 - 2012	Body - Seating	DCSM - Drivers Climate Seat Module	●	●		●			
Range Rover L322	2010 - 2012	Body - Seating	RDCSM - Rear Climate Seat Module	●	●		●			
Range Rover L322	2010 - 2012	Body - Doors	DDM - Drivers Door Module	●	●		●			
Range Rover L322	2010 - 2012	Body - Doors	PDM - Passengers Door Module	●	●		●			
Range Rover L322	2010 - 2012	Body - KVM	KVM - Keyless Vehicle Module	●	●		●			
Range Rover L322	2010 - 2012	Body - RBM	RBM - Running Board Control Module	●	●		●			
Range Rover L322	2010 - 2012	Body - RDUM	RDUM - Remote Driver Utility Module	●	●		●			
Range Rover L322	2010 - 2012	Infotainment - Audio and Video	AAM - Audio Amplifier Module	●	●		●			
Range Rover L322	2010 - 2012	Infotainment - Audio and Video	ACM - Audio Control Module	●	●		●			
Range Rover L322	2010 - 2012	Infotainment - Audio and Video	FEM - Front Electronic Module	●	●		●			
Range Rover L322	2010 - 2012	Infotainment - Audio and Video	CDP - Compact Disc Player	●	●		●			
Range Rover L322	2010 - 2012	Infotainment - Audio and Video	DABM - Digital Audio Broadcast Module	●	●		●			
Range Rover L322	2010 - 2012	Infotainment - Audio and Video	DACMC - Digital Audio Control Module 'C'	●	●		●			
Range Rover L322	2010 - 2012	Infotainment - Audio and Video	SRM - Satellite Audio Unit Module	●	●		●			
Range Rover L322	2010 - 2012	Infotainment - Audio and Video	TVM - Television Module	●	●		●			
Range Rover L322	2010 - 2012	Infotainment - APIM	APIM - Accessory Protocol Interface Module	●	●		●			
Range Rover L322	2010 - 2012	Infotainment - REM	REM - Rear Entertainment Control Module	●	●		●			
Range Rover L322	2010 - 2012	Infotainment - TEL	TEL - Cellular Telephone Control Module	●	●		●			
Range Rover L322	2010 - 2012	Infotainment - IPMB	IPMB - Image Processing Module 'B'	●	●		●			
Range Rover L322	2010 - 2012	Service Functions - Service Reset	IPC - Instrument Panel Control Module							●
Range Rover L322	2010 - 2012	Global Function - Clear DTCs	High Speed CAN Clear DTCs		●					
Range Rover L322	2010 - 2012	Global Function - Clear DTCs	Medium Speed CAN Clear DTCs		●					
Range Rover L322	2010 - 2012	Global Functions - ECU Reset	High Speed CAN ECU Reset							●
Range Rover L322	2010 - 2012	Global Functions - ECU Reset	Medium Speed CAN ECU Reset							●
Range Rover Sport	2005 - 2009	Drive - Diesel EMS	PCM - Power Train Control Module (Diesel)	●	●	●	●	●		●
Range Rover Sport	2005 - 2009	Drive - Petrol EMS	PCM - Power Train Control Module (Petrol)	●	●	●	●			
Range Rover Sport	2005 - 2009	Drive - Transmission	TCM - Transmission Control Module	●	●	●	●			●
Range Rover Sport	2005 - 2009	Drive - Transmission	RDCM - Rear Differential Control Module	●	●		●			
Range Rover Sport	2005 - 2009	Drive - Transfer Case	TCCM - Transfer Case Control Module	●	●	●	●			
Range Rover Sport	2005 - 2009	Drive - Adaptive Cruise Control	CCM - Cruise Control Module	●	●	●	●			
Range Rover Sport	2005 - 2009	Chassis - ABS / DSC	ABS / DSC - Antilocking brake System / Dynamic Stability Control	●	●	●	●			●
Range Rover Sport	2005 - 2009	Chassis - Steering Angle	SASM - Steering Angle Sensor Module	●	●		●			●
Range Rover Sport	2005 - 2009	Chassis - Parking Brake	PBM - Park Brake Module	●	●	●	●			●
Range Rover Sport	2005 - 2009	Chassis - TPMS	TPMS - Tyre Pressure Monitoring System	●	●	●	●			
Range Rover Sport	2005 - 2009	Chassis - ARCM	ARCM - Dynamic Response Module	●	●		●			
Range Rover Sport	2005 - 2009	Chassis - ATCM	ATCM - All Terrain Control Module	●	●		●			
Range Rover Sport	2005 - 2009	Chassis - Suspension	RLM - Ride Level Control Module	●	●	●	●			●
Range Rover Sport	2005 - 2009	Body - Airbag	RCM - Restraints Control Module	●	●	●	●			
Range Rover Sport	2005 - 2009	Body - Climate Control	HVAC - Heating Ventilation Air Conditioning Control Module	●	●		●			
Range Rover Sport	2005 - 2009	Body - Body Controller	BCM - Body Control Module	●	●	●	●			●
Range Rover Sport	2005 - 2009	Body - Instruments	IPC - Instrument Panel Control Module	●	●		●			●

## Lynx Vehicle Coverage - continued

Key  
 Version 2.6.2  
 ● Existing feature  
 ● Enhanced feature  
 ● New feature

Vehicle Model	Years	System	System Name	Read Fault Codes	Clear Fault Codes	Live Data	ECM Data	Actuators	Programming	Maintenance
Range Rover Sport	2005 - 2009	Body - Lighting Control	FLM - Front Lighting Module	●	●		●			
Range Rover Sport	2005 - 2009	Body - Parking Aid	PAM - Parking Aid Module	●	●	●	●			
Range Rover Sport	2005 - 2009	Body - Fuel Fired Heater	FFH - Fuel Fired Heater	●	●	●	●			
Range Rover Sport	2005 - 2009	Infotainment - Audio and Video	AAM - Audio Amplifier Module	●	●		●			
Range Rover Sport	2005 - 2009	Infotainment - Audio and Video	ACM - Audio Control Module	●	●		●			
Range Rover Sport	2005 - 2009	Infotainment - Audio and Video	FEM - Front Electronic Module	●	●		●			
Range Rover Sport	2005 - 2009	Infotainment - Audio and Video	DACMC - Digital Audio Control Module 'C'	●	●		●			
Range Rover Sport	2005 - 2009	Infotainment - Audio and Video	SRM - Satellite Audio Unit Module	●	●		●			
Range Rover Sport	2005 - 2009	Infotainment - Audio and Video	TVM - Television Module	●	●		●			
Range Rover Sport	2005 - 2009	Infotainment - REM	REM - Rear Entertainment Control Module	●	●		●			
Range Rover Sport	2005 - 2009	Infotainment - TEL	TEL - Cellular Telephone Control Module	●	●		●			
Range Rover Sport	2005 - 2009	Infotainment - TMC	TMC - Traffic Message Channel Module	●	●		●			
Range Rover Sport	2005 - 2009	Service Functions - Service Reset	IPC - Instrument Panel Control Module							●
Range Rover Sport	2005 - 2009	Global Function - Clear DTCs	High Speed CAN Clear DTCs		●					
Range Rover Sport	2005 - 2009	Global Function - Clear DTCs	Medium Speed CAN Clear DTCs		●					
Range Rover Sport	2005 - 2009	Global Functions - ECU Reset	High Speed CAN ECU Reset							●
Range Rover Sport	2005 - 2009	Global Functions - ECU Reset	Medium Speed CAN ECU Reset							●
Range Rover Sport	2010 - 2011	Drive - Diesel EMS	PCM - Power Train Control Module (Diesel V6)	●	●	●	●			●
Range Rover Sport	2010 - 2011	Drive - Diesel EMS	PCM - Power Train Control Module (Diesel V8)	●	●	●	●			●
Range Rover Sport	2010 - 2011	Drive - Petrol EMS	PCM - Power Train Control Module (Petrol)	●	●	●	●			
Range Rover Sport	2010 - 2011	Drive - Transmission	TCM - Transmission Control Module (Diesel V6)	●	●	●	●			
Range Rover Sport	2010 - 2011	Drive - Transmission	TCM - Transmission Control Module (Diesel V8)	●	●	●	●			
Range Rover Sport	2010 - 2011	Drive - Transmission	TCM - Transmission Control Module (Petrol)	●	●	●	●			
Range Rover Sport	2010 - 2011	Drive - Transmission	RDCM - Rear Differential Control Module	●	●		●			
Range Rover Sport	2010 - 2011	Drive - Transfer Case	TCCM - Transfer Case Control Module	●	●		●			
Range Rover Sport	2010 - 2011	Drive - Adaptive Cruise Control	CCM - Cruise Control Module	●	●		●			
Range Rover Sport	2010 - 2011	Chassis - ABS / DSC	ABS / DSC - Antilocking brake System / Dynamic Stability Control	●	●	●	●			●
Range Rover Sport	2010 - 2011	Chassis - Steering Angle	SASM - Steering Angle Sensor Module	●	●		●			●
Range Rover Sport	2010 - 2011	Chassis - Parking Brake	PBM - Park Brake Module	●	●	●	●			●
Range Rover Sport	2010 - 2011	Chassis - ARCM	ARCM - Dynamic Response Module	●	●		●			
Range Rover Sport	2010 - 2011	Chassis - ATCM	ATCM - All Terrain Control Module	●	●		●			
Range Rover Sport	2010 - 2011	Chassis - Suspension	RLM - Ride Level Control Module	●	●	●	●			●
Range Rover Sport	2010 - 2011	Chassis - Suspension	ADCM - Adaptive Damping Control Module	●	●		●			
Range Rover Sport	2010 - 2011	Body - Airbag	RCM - Restraints Control Module	●	●	●	●			
Range Rover Sport	2010 - 2011	Body - Airbag	OCS - Occupancy Classification System	●	●	●	●			
Range Rover Sport	2010 - 2011	Body - Climate Control	HVAC - Heating Ventilation Air Conditioning Control Module	●	●		●			
Range Rover Sport	2010 - 2011	Body - Body Controller	BCM - Body Control Module	●	●	●	●			●
Range Rover Sport	2010 - 2011	Body - Instruments	IPC - Instrument Panel Control Module	●	●		●			●
Range Rover Sport	2010 - 2011	Body - Lighting Control	HCM - Headlamp Control Module	●	●		●			
Range Rover Sport	2010 - 2011	Body - Lighting Control	HCMB - Headlamp Control Module 'B'	●	●		●			
Range Rover Sport	2010 - 2011	Body - Parking Aid	PAM - Parking Aid Module	●	●	●	●			
Range Rover Sport	2010 - 2011	Body - Immobiliser	Immobiliser	●	●		●			
Range Rover Sport	2010 - 2011	Body - Fuel Fired Heater	FFH - Fuel Fired Heater	●	●	●	●			
Range Rover Sport	2010 - 2011	Body - Seating	DSM - Drivers Seat Module	●	●		●			
Range Rover Sport	2010 - 2011	Body - Doors	DDM - Drivers Door Module	●	●		●			
Range Rover Sport	2010 - 2011	Body - Doors	PDM - Passengers Door Module	●	●		●			
Range Rover Sport	2010 - 2011	Body - KVM	KVM - Keyless Vehicle Module	●	●		●			
Range Rover Sport	2010 - 2011	Infotainment - Audio and Video	AAM - Audio Amplifier Module	●	●		●			
Range Rover Sport	2010 - 2011	Infotainment - Audio and Video	ACM - Audio Control Module	●	●		●			
Range Rover Sport	2010 - 2011	Infotainment - Audio and Video	FEM - Front Electronic Module	●	●		●			
Range Rover Sport	2010 - 2011	Infotainment - Audio and Video	FCIM - Front Control Interface Module	●	●		●			
Range Rover Sport	2010 - 2011	Infotainment - Audio and Video	FCIMB - Front Control Interface Module 'B'	●	●		●			
Range Rover Sport	2010 - 2011	Infotainment - Audio and Video	DABM - Digital Audio Broadcast Module	●	●		●			
Range Rover Sport	2010 - 2011	Infotainment - Audio and Video	SRM - Satellite Audio Unit Module	●	●		●			
Range Rover Sport	2010 - 2011	Infotainment - Audio and Video	TVM - Television Module	●	●		●			
Range Rover Sport	2010 - 2011	Infotainment - APM	APIM - Accessory Protocol Interface Module	●	●		●			
Range Rover Sport	2010 - 2011	Infotainment - REM	REM - Rear Entertainment Control Module	●	●		●			
Range Rover Sport	2010 - 2011	Infotainment - TEL	TEL - Cellular Telephone Control Module	●	●		●			
Range Rover Sport	2010 - 2011	Infotainment - IPMB	IPMB - Image Processing Module 'B'	●	●		●			
Range Rover Sport	2010 - 2011	Service Functions - Service Reset	IPC - Instrument Panel Control Module							●
Range Rover Sport	2010 - 2011	Global Function - Clear DTCs	High Speed CAN Clear DTCs		●					
Range Rover Sport	2010 - 2011	Global Function - Clear DTCs	Medium Speed CAN Clear DTCs		●					
Range Rover Sport	2010 - 2011	Global Functions - ECU Reset	High Speed CAN ECU Reset							●
Range Rover Sport	2010 - 2011	Global Functions - ECU Reset	Medium Speed CAN ECU Reset							●
Range Rover Sport	2012 - 2013	Drive - Diesel EMS	PCM - Power Train Control Module (Diesel)	●	●	●	●			●
Range Rover Sport	2012 - 2013	Drive - Petrol EMS	PCM - Power Train Control Module (Petrol)	●	●	●	●			
Range Rover Sport	2012 - 2013	Drive - Transmission	TCM - Transmission Control Module (Diesel V6)	●	●	●	●			
Range Rover Sport	2012 - 2013	Drive - Transmission	TCM - Transmission Control Module (Diesel V8)	●	●	●	●			
Range Rover Sport	2012 - 2013	Drive - Transmission	TCM - Transmission Control Module (Petrol)	●	●	●	●			
Range Rover Sport	2012 - 2013	Drive - Transmission	GSM - Gear Shift Module	●	●		●			
Range Rover Sport	2012 - 2013	Drive - Transmission	RDCM - Rear Differential Control Module	●	●		●			
Range Rover Sport	2012 - 2013	Drive - Transfer Case	TCCM - Transfer Case Control Module	●	●		●			
Range Rover Sport	2012 - 2013	Drive - Adaptive Cruise Control	CCM - Cruise Control Module	●	●		●			
Range Rover Sport	2012 - 2013	Chassis - ABS / DSC	ABS / DSC - Antilocking brake System / Dynamic Stability Control	●	●	●	●			●
Range Rover Sport	2012 - 2013	Chassis - Steering Angle	SASM - Steering Angle Sensor Module	●	●		●			●
Range Rover Sport	2012 - 2013	Chassis - Parking Brake	PBM - Park Brake Module	●	●	●	●			●
Range Rover Sport	2012 - 2013	Chassis - ARCM	ARCM - Dynamic Response Module	●	●		●			
Range Rover Sport	2012 - 2013	Chassis - ATCM	ATCM - All Terrain Control Module	●	●		●			
Range Rover Sport	2012 - 2013	Chassis - Suspension	RLM - Ride Level Control Module	●	●	●	●			●
Range Rover Sport	2012 - 2013	Chassis - Suspension	ADCM - Adaptive Damping Control Module	●	●		●			
Range Rover Sport	2012 - 2013	Body - Airbag	RCM - Restraints Control Module	●	●	●	●			



**Lynx Vehicle Coverage - continued**

Key  
 ● Existing feature  
 ● Enhanced feature  
 ● New feature

Vehicle Model	Years	System	System Name	Read Fault Codes	Clear Fault Codes	Live Data	ECM Data	Actuators	Programming	Maintenance
Range Rover Sport	2012 - 2013	Body - Airbag	OCS - Occupancy Classification System	●	●	●	●			
Range Rover Sport	2012 - 2013	Body - Climate Control	HVAC - Heating Ventilation Air Conditioning Control Module	●	●	●	●			
Range Rover Sport	2012 - 2013	Body - Body Controller	BCM - Body Control Module	●	●	●	●			●
Range Rover Sport	2012 - 2013	Body - Instruments	IPC - Instrument Panel Control Module	●	●	●	●			●
Range Rover Sport	2012 - 2013	Body - Lighting Control	HCM - Headlamp Control Module	●	●	●	●			
Range Rover Sport	2012 - 2013	Body - Lighting Control	HCMB - Headlamp Control Module 'B'	●	●	●	●			
Range Rover Sport	2012 - 2013	Body - Parking Aid	PAM - Parking Aid Module	●	●	●	●			
Range Rover Sport	2012 - 2013	Body - Immobiliser	Immobiliser	●	●	●	●			
Range Rover Sport	2012 - 2013	Body - Fuel Fired Heater	FFH - Fuel Fired Heater	●	●	●	●			
Range Rover Sport	2012 - 2013	Body - Seating	DSM - Drivers Seat Module	●	●	●	●			
Range Rover Sport	2012 - 2013	Body - Doors	DDM - Drivers Door Module	●	●	●	●			
Range Rover Sport	2012 - 2013	Body - Doors	PDM - Passengers Door Module	●	●	●	●			
Range Rover Sport	2012 - 2013	Body - KVM	KVM - Keyless Vehicle Module	●	●	●	●			
Range Rover Sport	2012 - 2013	Body - RGTM	RGTM - Rear Gate/Trunk Module	●	●	●	●			
Range Rover Sport	2012 - 2013	Infotainment - Audio and Video	FCDIM - Front Control/Display Interface Module	●	●	●	●			
Range Rover Sport	2012 - 2013	Infotainment - Audio and Video	FCIM - Front Control Interface Module	●	●	●	●			
Range Rover Sport	2012 - 2013	Infotainment - Audio and Video	FCIMB - Front Control Interface Module 'B'	●	●	●	●			
Range Rover Sport	2012 - 2013	Infotainment - IPMB	IPMB - Image Processing Module 'B'	●	●	●	●			
Range Rover Sport	2012 - 2013	Service Functions - Service Reset	IPC - Instrument Panel Control Module							●
Range Rover Sport	2012 - 2013	Global Function - Clear DTCs	High Speed CAN Clear DTCs		●					
Range Rover Sport	2012 - 2013	Global Function - Clear DTCs	Medium Speed CAN Clear DTCs		●					
Range Rover Sport	2012 - 2013	Global Functions - ECU Reset	High Speed CAN ECU Reset						●	
Range Rover Sport	2012 - 2013	Global Functions - ECU Reset	Medium Speed CAN ECU Reset						●	
Range Rover Evoque	2012 -	Drive - Diesel EMS	PCM - Power Train Control Module (Diesel)	●	●	●	●			●
Range Rover Evoque	2012 -	Drive - Petrol EMS	PCM - Power Train Control Module (Petrol)	●	●	●	●			
Range Rover Evoque	2012 -	Drive - Transmission	TCM - Transmission Control Module	●	●	●	●			●
Range Rover Evoque	2012 -	Drive - Transmission	GSM - Gear Shift Module	●	●	●	●			
Range Rover Evoque	2012 -	Drive - Transmission	GSMB - Gear Shift Module 'B'	●	●	●	●			
Range Rover Evoque	2012 -	Drive - Transmission	RDCM - Rear Differential Control Module	●	●	●	●			
Range Rover Evoque	2012 -	Chassis - ABS/DSC	ABS / DSC - Antilocking brake System / Dynamic Stability Control	●	●	●	●			
Range Rover Evoque	2012 -	Chassis - Steering Angle	SASM - Steering Angle Sensor Module	●	●	●	●			
Range Rover Evoque	2012 -	Chassis - Parking Brake	PBM - Park Brake Module	●	●	●	●			●
Range Rover Evoque	2012 -	Chassis - Power Steering	PSCM - Power Steering Control Module	●	●	●	●			
Range Rover Evoque	2012 -	Chassis - Suspension	ADCM - Adaptive Damping Control Module	●	●	●	●			
Range Rover Evoque	2012 -	Chassis - ATCM	ATCM - All Terrain Control Module	●	●	●	●			
Range Rover Evoque	2012 -	Body - Airbag	RCM - Restraints Control Module	●	●	●	●			
Range Rover Evoque	2012 -	Body - Airbag	OCS - Occupancy Classification System	●	●	●	●			
Range Rover Evoque	2012 -	Body - Climate Control	HVAC - Heating Ventilation Air Conditioning Control Module	●	●	●	●			
Range Rover Evoque	2012 -	Body - Body Controller	BCM - Body Control Module	●	●	●	●			●
Range Rover Evoque	2012 -	Body - Instruments	IPC - Instrument Panel Control Module	●	●	●	●			●
Range Rover Evoque	2012 -	Body - Lighting Control	HCM - Headlamp Control Module	●	●	●	●			
Range Rover Evoque	2012 -	Body - Lighting Control	HCMB - Headlamp Control Module 'B'	●	●	●	●			
Range Rover Evoque	2012 -	Body - Parking Aid	PAM - Parking Aid Module	●	●	●	●			
Range Rover Evoque	2012 -	Body - Object Detection	SODL - Side Object Detection Control Module - Left	●	●	●	●			
Range Rover Evoque	2012 -	Body - Object Detection	SODR - Side Object Detection Control Module - Right	●	●	●	●			
Range Rover Evoque	2012 -	Body - Immobiliser	BCM - Body Control Module	●	●	●	●			
Range Rover Evoque	2012 -	Body - Fuel-Fired Heater	FFH - Fuel Fired Heater	●	●	●	●			
Range Rover Evoque	2012 -	Body - Seating	DSM - Drivers Seat Module	●	●	●	●			
Range Rover Evoque	2012 -	Body - Seating	PSM - Passenger Seat Module	●	●	●	●			
Range Rover Evoque	2012 -	Body - Doors	DDM - Drivers Door Module	●	●	●	●			
Range Rover Evoque	2012 -	Body - Doors	PDM - Passengers Door Module	●	●	●	●			
Range Rover Evoque	2012 -	Body - KVM	KVM - Keyless Vehicle Module	●	●	●	●			
Range Rover Evoque	2012 -	Body - RGTM	RGTM - Rear Gate/Trunk Module	●	●	●	●			
Range Rover Evoque	2012 -	Infotainment - Audio and Video	AAM - Audio Amplifier Module	●	●	●	●			
Range Rover Evoque	2012 -	Infotainment - Audio and Video	ACM - Audio Control Module	●	●	●	●			
Range Rover Evoque	2012 -	Infotainment - Audio and Video	FCDM - Front Control / Display Interface Module	●	●	●	●			
Range Rover Evoque	2012 -	Infotainment - Audio and Video	FCIMB - Front Control Interface Module 'B'	●	●	●	●			
Range Rover Evoque	2012 -	Infotainment - Audio and Video	DABM - Digital Audio Broadcast Module	●	●	●	●			
Range Rover Evoque	2012 -	Infotainment - Audio and Video	SRM - Satellite Audio Unit Module	●	●	●	●			
Range Rover Evoque	2012 -	Infotainment - Audio and Video	TVM - Television Module	●	●	●	●			
Range Rover Evoque	2012 -	Infotainment - REM	REM - Rear Entertainment Module	●	●	●	●			
Range Rover Evoque	2012 -	Infotainment - IPMB	IPMB - Image Processing Module 'B'	●	●	●	●			
Range Rover Evoque	2012 -	Service Function - Service Reset	IPC - Instrument Panel Control Module							●
Range Rover Evoque	2012 -	Global Function - Clear DTCs	High Speed CAN Clear DTCs		●					
Range Rover Evoque	2012 -	Global Function - Clear DTCs	Medium Speed CAN Clear DTCs		●					
Range Rover Evoque	2012 -	Global Functions - ECU Reset	High Speed CAN ECU Reset							●
Range Rover Evoque	2012 -	Global Functions - ECU Reset	Medium Speed CAN ECU Reset							●

**Calibration Tools**

To help with air suspension calibration we also offer these calibration blocks which can be used in conjunction with our Lynx diagnostics kit.

- LRT-64-003** Discovery 2
- LRT-60-003** Range Rover P38



**LRT-60-003**

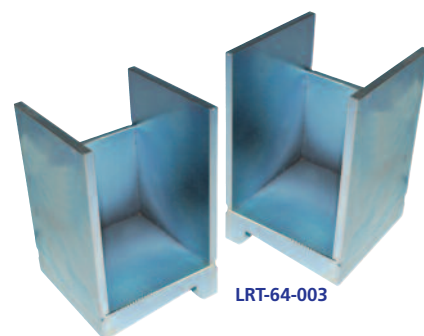

**LRT-64-003**



## Section contents

## Repair &amp; Service Parts

## Axle/Steering/Suspension

Air suspension compressors	140
Front hub, bearing & upright assembly	141
Steering box repair kit	140
Steering rack ball joint repair kits	140
Stub axle kits	140
Suspension ball joint repair kits	140
Suspension bolt kits	140
Swivel housing kits	140
Swivel pin kits	140
Wheel bearing kits	141
Wheel hub & bearing	141

## Braking

Anti-squeal shims	141
Brake fitting kit	141
Brake lubrication	141
Brake kits	141
Brake pipe sets	143
Britpart XD Brake Pads	142
Britpart XS Brake Pads	143
Parking brake spring kits	141
Stainless steel brake caliper pistons	142

## Electrics

Alternator upgrade kits	144
Electronic conversion kits	144
Ignition lead sets	144
Ignition module & link lead	144
V8 ignition module kit	144
Wiper relay - programmable	144

## Engine

Bleed screws	146
Cylinder head ancillaries	145
Cylinder heads	145
Cylinder liner kit	145
Engines	146
Filters - bulk	145
Fuel filter holder	147
Heater plug upgrade kit	146
Injector pipe sets	146
Injector washer kits	147
Main bearing sets	146
Manifold inlet seal	147
Oil cooler repair kit	147
Oil pump gear set	147
Pressure relief valve kit	147
Td5 Short oil filter	146
Timing kits	147
Top hat liner set	147

## Heating

Heater blower motor kit & resistor kit	148
Heater matrixes	148

## Transmission

Automatic transmission service kits	148
Clutch kits	150
CV joint kits	149
Damper kit	149
Detent repair springclip	151
Diff coupling shaft	149
Diff overhaul kits	151
Diff rebuild kit	151
Diff repair pans	149
Gear boxes	151
Gear change kits	151
IRD repair kit	151
Propshaft bearings	151
Rear diff & carrier	152
Transfer box	152

## Chassis &amp; body Components

Chassis - complete galvanised frames	153
Chassis & body components	
Defender	154
Discovery 1	155
Discovery 2	156
Range Rover Classic	157
Series 2 & 3	158
Other	159
Door hinge kits	159
Fuel latch repair kit	159
Galvanised products	153
Window kits	159

## Service Kits

Automatic transmission fluid change kits	163
Defender	161
Discovery	162
Freelander	161
Range Rover	162 - 163
Series	161

## Consumables

Bearing grease	165
Brake cleaner	165
Castrol Classic oils	166
Clips, clamps & nipples	165
Hylomar sealants & compounds	165
Land Rover genuine consumables	165
Loctite consumables	169
Ravenol oils	167
Swivel housing grease	170
Touch up paint pens	170
Trade tack stab	170
Workshop fluids	168

## Tools

Automatic transmission flush & fill machine	173
Calibration tools	171
Timing tools	171
Workshop tools	171 - 173

## Section Fourteen

## repair &amp; service

"From a new complete chassis to a jubilee clip - we've got the lot."



# Axle/Steering/Suspension

## Swivel Housing Kits



DA3165



**Corroded, worn or leaking swivel housings?**  
These ten swivel housing kits from Britpart are a convenient way to ensure you have all the quality parts needed to replace a Land Rover's swivel housing.

**DA3203 NEW** Defender castor corrected swivel housings  
These are a direct replacement for vehicles normally using the FRC7065 swivel housing but they have the mounting holes positioned to give 3 degrees of additional castor. Full details in the suspension section.

**NOTE** Blue part numbers  
Red part numbers  
Green part numbers  
**DA3163G NEW**

<b>DA3163</b>	<b>DA3163P</b>	<b>DA3163G NEW</b>	Full kit with swivel housing
<b>DA3164</b>	<b>DA3164P</b>	<b>DA3164G NEW</b>	Repair kit without swivel housing
<b>DA3165</b>	<b>DA3165P</b>	<b>DA3165G NEW</b>	Kit is for one side only. For full details of each kit list - <a href="http://www.britpart.com/swivelkits">www.britpart.com/swivelkits</a>
<b>DA3166</b>	<b>DA3166P</b>	<b>DA3166G NEW</b>	Full kit with swivel housing & OEM seals
<b>DA3167</b>	<b>DA3167P</b>	<b>DA3167G NEW</b>	Discovery 1 - up to JA32850 - with 12mm seals
<b>DA3178</b>	<b>DA3178P</b>	<b>DA3178G NEW</b>	Range Rover Classic - up to JA624516 - with 12mm seals
<b>DA3179</b>	<b>DA3179P</b>	<b>DA3179G NEW</b>	Discovery 1 - up to JA32850 - with 8mm seals
<b>DA3180</b>	<b>DA3180P</b>	<b>DA3180G NEW</b>	Range Rover Classic - up to JA624516 - with 8mm seals
<b>DA3181</b>	<b>DA3181P</b>	<b>DA3181G NEW</b>	Discovery 1 - JA32851 onwards - non-ABS
<b>DA3182</b>	<b>DA3182P</b>	<b>DA3182G NEW</b>	Range Rover Classic - JA624517 onwards - non-ABS
<b>DA3183</b>	<b>DA3183P</b>	<b>DA3183G NEW</b>	Discovery 1 - with ABS
<b>DA3184</b>	<b>DA3184P</b>	<b>DA3184G NEW</b>	Range Rover Classic - with ABS
<b>DA3185</b>	<b>DA3185P</b>	<b>DA3185G NEW</b>	Defender - up to KA930455
<b>DA3186</b>	<b>DA3186P</b>	<b>DA3186G NEW</b>	Defender - from LA up to WA
<b>DA3187</b>	<b>DA3187P</b>	<b>DA3187G NEW</b>	Defender - XA onwards - non-ABS
<b>DA3188</b>	<b>DA3188P</b>	<b>DA3188G NEW</b>	Defender - XA onwards - with ABS
<b>DA3189</b>	<b>DA3189P</b>	<b>DA3189G NEW</b>	Series 2
<b>DA3190</b>	<b>DA3190P</b>	<b>DA3190G NEW</b>	Series 2A/Series 3

## Stub Axle Kits

Handy kits when changing your Land Rover's stub axle!

### Front Kits

<b>DA3190</b>	Defender - up to KA
<b>DA3191</b>	Defender - from LA
<b>DA3192</b>	Defender - from 2007 onwards
<b>DA3193</b>	Discovery 1 - up to JA032850
<b>DA3194</b>	Discovery 1 - from JA032851
<b>DA3195</b>	Range Rover Classic - from JA624517

### Rear Kits

<b>DA3198</b>	Defender 90 - from LA
<b>DA3199</b>	Defender - from LA with Salisbury axle
<b>DA3196</b>	Discovery 1 - up to JA032850/Range Rover Classic - up to JA032850
<b>DA3197</b>	Discovery 1 - from JA032851/Range Rover Classic - from JA032851



DA3191

## Steering Rack Ball Joint Repair Kits

Steering rack ball joint repair kits

<b>LR010673</b>	Range Rover Sport - 2005 - 2013- M14 ball joints
<b>LR010674</b>	Range Rover Sport - 2005 - 2009 - M12 ball joints



LR010673

## Steering Box Repair Kit

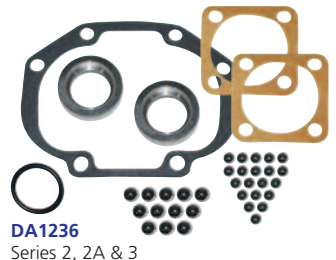

**DA1236**  
Series 2, 2A & 3



LR061888

## Air Suspension Compressors



LR025111

At last, a cost effective and easy way to replace the OE air suspension compressor. These compressors are a direct replacement fit for the OE compressors that were fitted by the factory. They are made in Japan by Hitachi. By using the original brackets and pipes they are easy to install. The relay, which is included, must be changed. No need to reprogram the ECU (fault codes may need to be cleared).

- Direct replacement fit
- Cost effective
- No need to reprogram the air suspension ECU
- Uses all original mounting & pipework

<b>LR015303</b> & <b>LR023964</b>	Discovery 3 - up to 9A513325
<b>LR015089</b> & <b>LR025111</b>	Range Rover Sport - up to 9A215622
<b>LR015089</b> & <b>LR025111</b>	Range Rover L322 - from 6A198058 up to CA393639



LR023964

## Suspension Ball Joint Repair Kits



Suspension arm not included.

Using these replacement ball joint kits is now a cost effective way to repair the Freelander front suspension arm.

<b>RB102920/930BJ</b>	Freelander 1 - up to 5A999999
<b>RB102920/930BJG</b>	- OEM
<b>RB102920/930BJG</b>	Freelander 1 - from 6A000001
<b>RB102920/930BJG</b>	- OEM
<b>LR007205-6BJ</b>	Freelander 2
<b>LR007205-6BJ</b>	Ball joint for LR007205 & LR007206

RB102920/930BJG

LR007205-6BJ

## Suspension Bolt Kits



DA7202

DA7205

More images in the suspension section

<b>DA7202</b>	Defender - up to KA930455	Front suspension
<b>DA7200</b>	Defender - LA930456 to WA159806	Front suspension
<b>DA7203</b>	Defender - XA159807 to 2A626645	Front suspension
<b>DA7204</b>	Defender - 2A625546 onwards	Front suspension
<b>DA7201</b>	Defender - up to YA185790	Rear suspension
<b>DA7208</b>	Defender - YA185791 onwards	Rear suspension
<b>DA7205</b>	Discovery 3/Discovery 4/Range Rover Sport - 2005 - 2012	Suspension arm
<b>DA7207</b>	Discovery 3/Discovery 4/Range Rover Sport - 2005 - 2012	Suspension arm
<b>DA7206</b>	Discovery 3/Discovery 4/Range Rover Sport - 2005 - 2012	Suspension arm

Discovery 4 - from 9A513325  
Range Rover Sport - from 9A215622  
A direct replacement compressor for all non-Hitachi vehicles. Manufactured by the OE company in Germany. The relay which is included must be changed.

<b>LR061888 NEW</b>	Compressor, relay, fixings and bracket
<b>LR045444</b>	Compressor, relay and fixings
<b>LR044034 NEW</b>	Bracket only

## Swivel Pin Kits



<b>532268</b>	Series 2 - conversion
<b>DA2178</b>	Series 3
<b>DA2211</b>	Defender - up to KA930455
<b>DA2210</b>	Defender - LA930456 onwards - non-ABS



DA2211

**Front Hub, Bearing & Upright Assembly**



Freelander 2  
Replacement front hub, bearing & upright complete assembly. Offers a quick and cheaper alternative to replacing wheel bearing or hub as separate items, saving time and money.  
**DA1213** Right hand side  
**DA1214** Left hand side

**Wheel Hub & Bearing**



**LR014147**  
Wheel hub & bearing assembly kit - front  
Discovery 3/Discovery 4  
Range Rover Sport - 2005 - 2013

Britpart Kits	OEM Kits		
<b>RTC3534</b>		Series 2/Series 3 - SWB/LWB up to 1980 - imperial	Front & rear
<b>RTC3537</b>		Series 3 - SWB/LWB - 1980 onwards - metric	Front & rear
<b>DA2379</b>	<b>DA2379G</b>	Defender - up to KA	Front
<b>DA2380</b>	<b>DA2380G</b>	Defender - up to KA	Rear
<b>DA2381</b>	<b>DA2381G</b>	Defender - LA onwards	Front & rear
<b>DA2382</b>	<b>DA2382G</b>	Discovery 1 - up to JA032850	Front & rear
<b>DA2383</b>	<b>DA2383G</b>	Discovery 1 - JA032851 onwards	Front & rear
<b>DA2385</b>	<b>DA2385G</b>	Range Rover Classic - non-ABS - up to JA624516	Rear
<b>DA2384</b>	<b>DA2384G</b>	Range Rover Classic - non-ABS - JA624517 onwards	Rear
<b>DA2386</b>	<b>DA2386G</b>	Range Rover Classic - ABS	Rear
<b>DA2387</b>	<b>DA2387G</b>	Range Rover Classic - ABS	Front
<b>DA2388</b>	<b>DA2388G</b>	Range Rover Classic - non-ABS	Front
<b>FTC1507</b>		Range Rover P38 <b>Note</b> - Bearing only	Front & rear

**RTC3534**



**DA2386G**



You can now find all the latest Britpart news on Facebook!

[facebook.com/britpart](https://facebook.com/britpart)

**Series - SWB**

<b>DA6042</b>	Front	Up to June 1980
<b>DA6043</b>	Rear	Up to June 1980
<b>DA6044</b>	Front	July 1980 onwards
<b>DA6046</b>	Rear	July 1980 onwards

**Series - LWB**

<b>DA6044</b>	Front	4 cylinder except 1 ton
<b>DA6045</b>	Front	6 cylinder & 109 V8 Stage 1
<b>DA6047</b>	Rear	Including V8

Kits include - Brake shoes, wheel cylinders, brake springs & screws (where applicable)

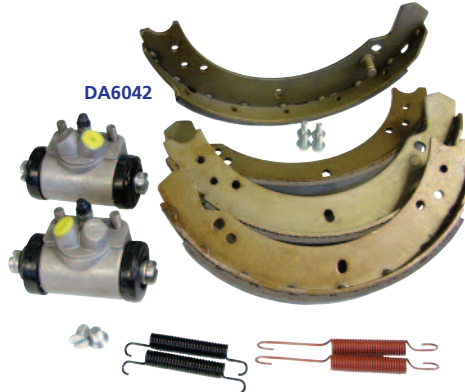

**DA6042**



**DA6047**

**Braking Brake Kits**

**Anti-squeal shims**



Universal self adhesive noise dampening shims

**DA1141**

The shims are manufactured from wolverine and cut to shape and applied to the backing plate of the Brake pads prior to fitting to help eliminate any noise issues (should the pad be unshimmed). When used in conjunction with Mintex CeraTec silicon based lubricant, most brake noise related issues will be eradicated. Pack quantity 4.



**Cera-Tec Advanced Lubricant**

Mintex Cera TEC is an advanced non-metallic universal lubricant that provides many benefits over traditional copper-based grease.

**DA2389**

- Non-metallic content - ABS and ESP friendly
- Operates to a high temperature (1,000°C)
- Non-conductive
- Free of copper and acid
- More effective at reducing any brake squeal
- Protects against corrosion and dirt
- Neutral colour prevents any visible residue or staining



**Brake Lubrication**

**Brake Fitting Kit**

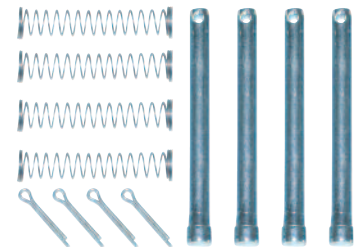

**DA4105**

Defender - 1987 - 2006  
Rear  
Brake fitting kit for brake pads STC1601 & SFP00280

**Parking Brake Spring Kits NEW**



**LR031947KIT NEW**

Discovery 4  
Range Rover Sport - 2010 - 2013

**SF5500012KIT NEW**

Discovery 3/Discovery 4  
Range Rover Sport - 2005 - 2013



## Britpart XD Brake Pads



The Britpart range of XD Brake Pads gives you the opportunity of fitting a much higher quality brake pad than the price would indicate. Britpart has tested many different brake pads over the last 5 years and have found this brake pad specification offers Land Rover owners the best possible performance at this price level.

The XD Brake Pads are manufactured to an exact tolerance using only the best European friction materials to OEM specifications ensuring long life and low noise.

All raw materials are analysed in-house using a fully equipped quality laboratory with, for example, an atomic absorption device. After analysis the raw materials are mixed and pressed using several different methods to achieve the best brake pad for each application. Each part number is tailored to the application it is intended for. The XD Brake Pad range has been thoroughly tested on dynamometers and noise measuring rigs before being put through their paces on test tracks and extended operations tests to ensure a perfect and effective operation every time.

All pads are covered by the worldwide Britpart warranty and Britpart recommends they are fitted with the Britpart standard or performance brake discs.

## XD Brake Pads

Manufactured to OEM specifications ensuring long life and low noise.

Manufactured in a TS16949 & ISO14021 approved factory.

Asbestos, lead & CR6 free material.

The XD Brake Pad range meet all official legislation for quality and safety and are compliant with European ECE R90.

All XD Brake Pads are produced with an underlayer material designed to dampen vibrations to prevent noise and to reduce heat transfer to the brake fluid.

### IMPORTANT BRAKE INFORMATION

For exact change over points with vehicle applications please contact your local Britpart distributor with the full chassis number for the correct application. These references are intended as a guide only.

### Defender

STC2952	1987 - 2006	Front
SFP000260	1987 - 2006 & 2007-	Front
SFP000280	1987 - 2006	Rear
STC1601	1987 - 2006	Rear
SFP000250	1987 - 2006 & 2007-	Rear
SFP000270	1987 - 2006 & 2007-	Rear
LR032954	2007-	Rear

### Discovery

<b>Discovery 1</b>		
SFP500180		Front
STC9190		Front
SFP500160		Front
SFP500190		Rear
SFP500200		Rear
STC9189		Rear

### Discovery 2

SFP500150		Front
SFP500130		Rear

### Discovery 3

SFP500010		Front
LR019618		Front
LR019627		Rear
LR055454		Rear

### Discovery 4

SFP500010		Front
LR019618		Front
LR021253		Front
LR051626		Front
LR021316		Rear
LR019627		Rear
LR055454		Rear
LR015519		Rear
LR055455		Rear

### Freelander

<b>Freelander 1</b>		
SFP100360		Front
LR021899		Front
<b>Freelander 2</b>		
LR004936		Front
LR003657		Rear
LR023888		Rear
LR043285		Rear

### Range Rover

#### Range Rover Classic

SFP500180	1986 - 1994	Front
SFP500200	1986 - 1994	Rear

#### Range Rover P38

SFP500120	1994 - 2001	Front
SFP500130	1994 - 2001	Rear

#### Range Rover L322

SFC500080	2002 - 2009	Front
SFP500010	2002 - 2009	Front
LR019618	2002 - 2009	Front
SFP500070	2002 - 2009	Front
SFP500210	2002 - 2009	Rear
LR019627	2002 - 2009	Rear
LR055454	2002 - 2009	Rear
LR026221	2010 - 2012	Front
LR020362	2010 - 2012	Front
LR064181 <b>NEW</b>	2010 - 2012	Front
LR025739	2010 - 2012	Rear
LR015519	2010 - 2012	Rear
LR032903	2010 - 2012	Rear

#### Range Rover L405

LR020362	2013 -	Front
LR064181 <b>NEW</b>	2013 -	Front
LR036574	2013 -	Rear
LR065492 <b>NEW</b>	2013 -	Rear

#### Range Rover Sport

SFP500010	2005 - 2009	Front
LR019618	2005 - 2009	Front
SFP500070	2005 - 2009	Front
LR019627	2005 - 2009	Rear
LR055454	2005 - 2009	Rear
LR021253	2010 - 2013	Front
LR020362	2010 - 2013 & 2014 -	Front
LR064181 <b>NEW</b>	2010 - 2013 & 2014 -	Front
LR051626	2010 - 2013 & 2014 -	Front
LR019627	2010 - 2013	Rear
LR055454	2010 - 2013	Rear
LR025739	2010 - 2013	Rear
LR015519	2010 - 2013	Rear
LR055455	2010 - 2013	Rear
LR036574	2014 -	Rear
LR065492 <b>NEW</b>	2014 -	Rear

#### Range Rover Evoque

LR027309		Front
LR027129		Rear
LR043714		Rear

## Stainless Steel Brake Caliper Pistons & Kits



DA1165	Defender - up to HA701009/ Discovery 1/Range Rover Classic	Front
DA1166	Defender - HA701010 onwards	Front
DA1167	Defender - 90/Discovery 1 Range Rover Classic	Rear
DA1172	Defender - 110/130	Rear

Stainless steel brake caliper piston kits. Each kit is one complete axle, either front or rear as stated. The kit includes OEM repair kit and grease sachet.

### Single Stainless Steel Pistons

606683S <b>NEW</b>		Front
Defender - up to HA701009/ Discovery 1/Range Rover Classic		
606696S <b>NEW</b>		Rear
Defender - 90/Discovery 1/Range Rover Classic		
STC201S <b>NEW</b>		Front
Defender - HA701010 onwards		Front
Defender - 110/130		Rear

**Britpart XS Brake Pads**

<b>Defender</b>		
STC2952G	1987 - 2006	Front
SFP000260G	1987 - 2006 & 2007-	Front
SFP000280G	1987 - 2006	Rear
STC1601G	1987 - 2006	Rear
SFP000250G	1987 - 2006 & 2007-	Rear
SFP000270G	1987 - 2006 & 2007-	Rear
LR032954G	2007-	Rear

<b>Discovery</b>		
<b>Discovery 1</b>		
SFP500180G		Front
STC9190G		Front
SFP500160G		Front
SFP500190G		Rear
SFP500200G		Rear
STC9189G		Rear

<b>Discovery 2</b>		
SFP500150G		Front
SFP500130G		Rear
<b>Discovery 3</b>		
SFP500010G		Front
LR019618G		Front
LR019627G		Rear
LR055454G		Rear

<b>Discovery 4</b>		
SFP500010G		Front
LR019618G		Front
LR021253G		Front
LR051626G		Front
LR021316G		Rear
LR019627G		Rear
LR055454G		Rear
LR015519G		Rear
LR055455G		Rear

<b>Freelander</b>		
<b>Freelander 1</b>		
SFP100360G		Front
LR021899G		Front
<b>Freelander 2</b>		
LR004936G		Front
LR003657G		Rear
LR023888G		Rear
LR043285G		Rear

**XS Brake Pads**

The Britpart range of XS Brake Pads offers you the opportunity to have the exact factory production line specification of brake pad at an affordable price.

These pads offer the best possible combination of long life, pedal feel and noise suppression.

All the pads in the range use the same friction material specification that your Land Rover was originally made with.

The XS range of pads are all produced in one of the world's premium brake pad facilities where production procedures are carefully monitored to ensure a consistently good product.

The facility has both in-house testing and access to OE testing facilities to ensure all pads meet the exact specification required.

Britpart XS Brake Pads are ideal for high mileage or heavy-duty applications.

*The exact performance material specification of production line brake pads.*



**Range Rover**

<b>Range Rover Classic</b>		
SFP500180G	1986 - 1994	Front
SFP500200G	1986 - 1994	Rear

<b>Range Rover P38</b>		
SFP500120G	1994 - 2001	Front
SFP500130G	1994 - 2001	Rear

<b>Range Rover L322</b>		
SFC500080G	2002 - 2009	Front
SFP500010G	2002 - 2009	Front
LR019618G	2002 - 2009	Front
SFP500070G	2002 - 2009	Front
SFP500210G	2002 - 2009	Rear
LR019627G	2002 - 2009	Rear
LR055454G	2002 - 2009	Rear
LR026221G	2010 - 2012	Front
LR020362G	2010 - 2012	Front
LR064181G <b>NEW</b>	2010 - 2012	Front
LR025739G	2010 - 2012	Rear
LR015519G	2010 - 2012	Rear
LR032903G	2010 - 2012	Rear

<b>Range Rover L405</b>		
LR020362G	2013 -	Front
LR064181G <b>NEW</b>	2013 -	Front
LR036574G	2013 -	Rear
LR065492G <b>NEW</b>	2013 -	Rear

<b>Range Rover Sport</b>		
SFP500010G	2005 - 2009	Front
LR019618G	2005 - 2009	Front
SFP500070G	2005 - 2009	Front
LR019627G	2005 - 2009	Rear
LR055454G	2005 - 2009	Rear
LR021253G	2010 - 2013	Front
LR020362G	2010 - 2013 & 2014 -	Front
LR064181G <b>NEW</b>	2010 - 2013 & 2014 -	Front
LR051626G	2010 - 2013 & 2014 -	Front
LR019627G	2010 - 2013	Rear
LR055454G	2010 - 2013	Rear
LR025739G	2010 - 2013	Rear
LR015519G	2010 - 2013	Rear
LR055455G	2010 - 2013	Rear
LR036574G	2014 -	Rear
LR065492G <b>NEW</b>	2014 -	Rear

<b>Range Rover Evoque</b>		
LR027309G		Front
LR027129G		Rear
LR043714G		Rear

**IMPORTANT BRAKE INFORMATION**

For exact change over points with vehicle applications please contact your local Britpart distributor with the full chassis number for the correct application. These references are intended as a guide only.

DA7443	Series 1	<b>NEW</b>	RHD	80 inch
DA7442	Series 1	<b>NEW</b>	RHD	86 inch
DA7400	Series 2	SWB	RHD	1958 - 1961. From chassis 141900105 to suffix F inclusive 4-cylinder
DA7428	Series 2	SWB	LHD	1958 - 1969 suffix F. 4-cylinder from chassis 141900105 to suffix F
DA7429	Series 2A	SWB	LHD	1969 4-cylinder to suffix G
DA7401	Series 2A	SWB	RHD	4-cylinder up to 1969 suffix G
DA7402	Series 2A	LWB	RHD	09/1961 - 01/1969 4-cylinder up to suffix F
DA7405	Series 2A	LWB	RHD	6-cylinder with servo up to 1969 to suffix F
DA7406	Series 2A	LWB	RHD	From 04/1969 suffix G. No servo 6-cylinder from suffix G.
DA7403	Series 3	SWB	RHD	Single line 4-cylinder & 6-cylinder
DA7407	Series 3	SWB	RHD	Dual lightweight up to 07/1980
DA7409	Series 3	SWB	RHD	Dual to early 1980
DA7412	Series 3	SWB	RHD	Lightweight dual up to 1975 with servo to chassis 95102970A
DA7413	Series 3	SWB	RHD	Dual up to 07/1980. Civilian body metric & imperial system
DA7430	Series 3	SWB	LHD	No servo
DA7432	Series 3	SWB	LHD	Dual system
DA7404	Series 3	LWB	RHD	4-cylinder & 6-cylinder single line
DA7408	Series 3	LWB	RHD	From 07/1980 & air portable lightweight from July 1980 onwards & 1981 V8 dual
DA7410	Series 3	LWB	RHD	Up to 06/1980 dual. 4-cylinder up to 06/1980 & V8 up to 09/1980
DA7431	Series 3	LWB	LHD	Single line 4-cylinder & 6-cylinder
DA7411	Defender	90	RHD	1985 - 1991 to VIN HA
DA7418	Defender	90	RHD	With front brake valve less ABS LA930456 - WA159806
DA7441	Defender	90	RHD	Less front brake valve less ABS LA930456 - WA159806
DA7439	Defender	90	LHD	1992 onwards from JA up to 2004
DA7420	Defender	110	RHD	1983 - 1987
DA7414	Defender	110	RHD	1988 - 1991 VIN HA90219
DA7438	Defender	110	RHD	CSW from VIN KA & LA models from 1993
DA7419	Defender	130	RHD	CSW from 1994 VIN LA
DA7415	Discovery 1	200Tdi	RHD	Up to VIN JA 1992
DA7416	Discovery 1	200Tdi	RHD	From VIN JA 1993
DA7417	Discovery 1	300Tdi	RHD	From 1994 non-ABS
DA7433	Discovery 1	300Tdi	LHD	From 1994 with ABS
DA7422	Range Rover Classic		RHD	Early models
DA7421	Range Rover Classic		RHD	From 1979 with rear valve
DA7434	Range Rover Classic		LHD	From 1979 with rear valve
DA7423	Range Rover Classic		RHD	Non-ABS from 1987 VIN DA274121 (2-door) & DA273923 (4-door) OSF valve
DA7424	Range Rover Classic		RHD	ABS 1986 up to VIN CA274120 (2-door) & CA273922 (4-door) front valve & bypass pipe
DA7435	Range Rover Classic		LHD	From 1987 non-ABS from VIN DA274121 (2-door) & DA273923 (4-door) front valve & bypass pipe
DA7436	Range Rover Classic		LHD	ABS front valve & bypass pipe 1986. 1983 up to VIN CA274120 (2-door) & CA273922 (4-door) 1986 onwards
DA7425	Range Rover Classic		RHD	ABS 1990 - 1991 VIN HA
DA7426	Range Rover Classic		RHD	ABS 1992 VIN JA
DA7427	Range Rover Classic		RHD	1993 VIN KA air suspension
DA7437	Range Rover Classic		LHD	Up to 1992 VIN HA with Clayton Dewandre Wabco 4-channel ABS

**Brake Pipe Sets**

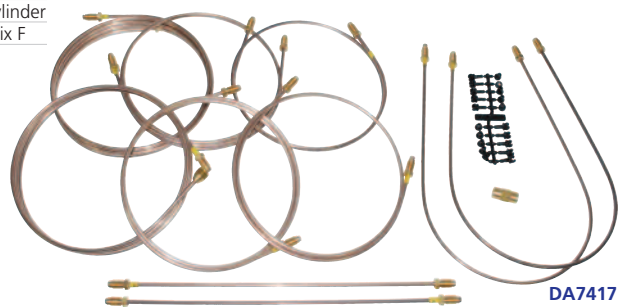

Ready made brake pipe sets...

- Easily fitted
- Will not rust

More brake pipe kits available on request.

Copper nickel brake pipe sets manufactured in the UK. Each set is for a complete specific Land Rover model. Pipes are cut to the correct length, fitted with solid brass unions and marked clearly to indicate the correct location on the Land Rover. Pipe fitting clips and brass in-line connectors are supplied where necessary.



**DA7440**  
Brake pipe bending tool  
Can be used with all Britpart brake pipe kits.

## Electrics

### Alternator Upgrade Kits



200Tdi alternator upgrade kits. Kits include uprated cable.

<b>DA1195</b>	Defender - 200Tdi	Upgrade the 45A alternator to 120A
<b>DA1196</b>	Discovery 1 - 200Tdi	Upgrade the alternator to 120A

### Electronic Conversion Kits



#### ETC5835K

The Britpart electronic conversion kit replaces the existing points and condenser with a new reliable electronic module. For 4-cylinder petrol engines the Britpart electronic ignition module has been developed to work with the standard ignition coil and provides service free and accurate ignition timing. The kit can be easily fitted to standard points type 45D4 distributors without having to fit a new electronic ignition coil. We'd recommend fitting a new coil at the same time - PRC9858. Also available a new distributor with points to which this kit can be fitted - ETC5835.

#### ERC4536K

This electronic conversion kit is for V8 points and has built in dwell adjustment with rpm protection when not running.

### Ignition Lead Sets

<b>DA4102</b>	<b>DA4104RED</b>	<b>STC9124</b>	<b>DA4102</b>	Grey leads Red leads
<b>RTC6551RED</b>	<b>NGC103740/810</b>	<b>NGC500370/410</b>	<b>DA4104</b>	Grey leads Red leads
			<b>DA4104RED</b>	Grey lead
			<b>STC9124</b>	King lead with protective & waterproof rubber coil cover
			<b>RTC6551</b>	Grey leads Red leads
			<b>RTC6551RED</b>	Grey lead
			<b>NGC103740/810</b>	Grey leads Red leads
			<b>NGC103740/810RED</b>	Grey lead
			<b>NGC500370/410</b>	Grey leads Red leads

These silicone HT lead sets are designed to meet or exceed the original equipment specification. The silicon cable has minimal interference with maximum suppression, it is also resistant to water, oils, chemicals and high temperatures. High quality with ISO 3808 class noise suppression performance.

### V8 Ignition Module Kit



**STC1856**  
Discovery 1 & Range Rover Classic  
This kit extends the ignition module on a V8 engine away from the distributor to make it more reliable in wet conditions.



### Ignition Module & Link Lead



**STC1184K**  
Module for V8 distributor  
Kit to convert 3-pin to 2-pin applications

### Wiper Relay - Programmable

#### AMR2341DELAY

*Fed up with your Defender's intermittent wipers not being intermittent enough? Does it drive you mad when you give the screen a quick spray and it wipes for ages?*



Fit this new relay in place of the standard AMR2341 to your vehicle to solve this problem. Once fitted you press the stalk down so that the wiper wipes and then back off again, now count/wait till you want another wipe, switch the stalk down and leave it on, this timing will now remain constant till you set another timing the same way or turn off the ignition at which point the relay reverts to a standard 6 second wipe interval. Another bonus is that the wipers will now only wipe once following a short burst of washer fluid or 3 times after a long burst.

This will work on all Defenders with the latching intermittent wiper stalk PRC7370 or AMR6106 HA onwards (stays down when pressed) but it will also work on 300Tdi and Td5 although on post 2002 Td5s the relay AMR2341 is located behind the speedo. Will not work with early stalk PRC3900 up to GA models.



Complete 300Tdi cylinder heads. Supplied with valves and head bolts, pressure tested and with heat tell tale stickers on.

**Cylinder Heads**

**Engine Cylinder Liner Kit**



ERR5027COM



LDF500180COM

**Note** - This head has additional waterways for improved cooling. Use multi-leaf metal head gasket (LVB500220 - 3-hole) with this head.



LCJ000050LKIT  
Liner and piston for 1.8 litre K-series engines.

**Head & Bottom Gasket Kits**

DA2112	Td5	Head set	No head gasket
DA2112-1	Td5	Head set	1-hole gasket
DA2112-2	Td5	Head set	2-hole gasket
DA2112-3	Td5	Head set	3-hole gasket
DA2113	Td5	Bottom set	
DA2112G-EARLY	Td5	Elring head set	No head gasket
Defender - up to 1A622423 & Discovery 2 - up to 1A736339			
DA2112G-LATER	Td5	Elring head set	No head gasket
Defender - 1A622424 onwards & Discovery 2 - 2A736340 onwards			
DA2508 <b>NEW</b>	Defender - Puma 2.4	Head set	No head gasket
DA2114	Freelander 1 - 1.8 16v	Head set	Inc. head gasket
DA2115	Freelander 1 - 1.8 16v	Bottom set	
DA3143	Freelander 1 - 2.5KV6	Head set	Inc. head gasket
DA3145	Freelander 1 - 2.0 diesel L series	Head set	No head gasket

**Cylinder Head Ancillaries**

**Head Gasket Kits & Head Bolt Sets**

STC1172B	200Tdi	No head gasket
STC2802B	300Tdi	No head gasket
DA2112B	Td5	No head gasket
DA2114B	Freelander 1 - 1.8 16v	Inc. head gasket

**Head Bolt Sets**

DA2006	200Tdi	DA2505	Defender - Puma 2.4
DA2005	300Tdi	DA2506	Defender - Puma 2.2
DA2141	4.0/4.6 V8 ten bolt heads		

DA2112

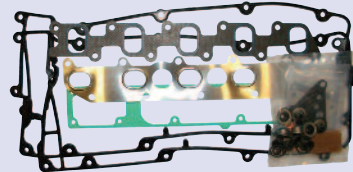

DA2113

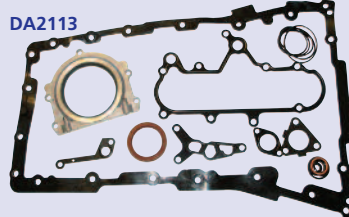

STC1172B



STC2802B



More images available online...

DA2112G-EARLY

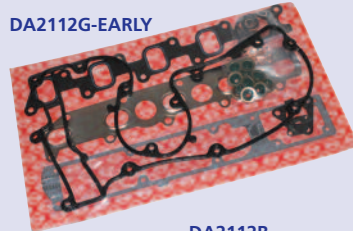

DA2112G-LATER

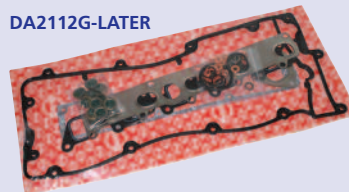

DA3143

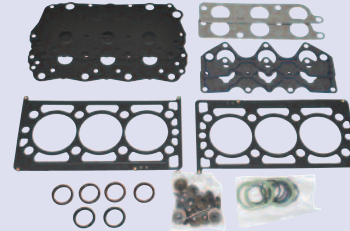

DA3145

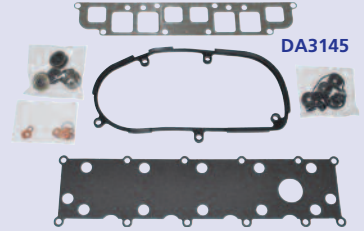

DA2112B

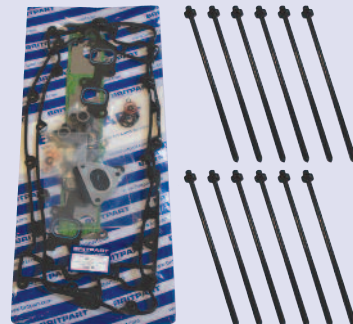

DA2114B



DA2006



DA2141



DA2005

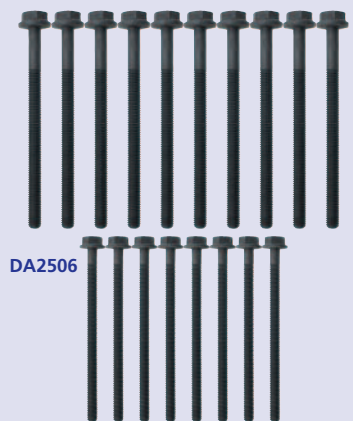

DA2506

**Filters - Bulk**



AEU2147LX

Minimum order quantity - 50 filters

ESR4238X	Air
Defender - 1987 - 2006	
Discovery 2 - 1998 - 2004/Freelander 1	
Range Rover P38	
AEU2147LX	Fuel
Defender/Discovery 1	
Range Rover Classic - 1986 - 1994	
ESR4686X	Fuel
Defender/Discovery 2	
ERR3340X	Oil
Defender/Discovery 1/Discovery 2	
Range Rover Classic/Range Rover P38	
JKR500020X	Pollen - odour & particles
Discovery 3/Discovery 4	
Range Rover Sport - 2005 - 2013	
ERR6299X	Rotor
Defender/Discovery 2	

## Engines

### Complete Engines

Include fuel pump, injectors, injector pipes, timing assembly and bell housing. Complete engines are tested prior to despatch. Once tested the flywheel and manifolds are removed and the engine is packed without these parts. Outer timing covers, pulleys, manifolds, flywheel and turbo charger are not included.

### Stripped Engines

Include sump, block, cylinder head, rocker cover, inner timing cover, camshaft and crankshaft gear.

### Short Engines

Consist of block, crank, con-rods and pistons only.

### Engines - New

<b>STC4723N</b>	Defender/Discovery 1/Range Rover Classic	300Tdi	Stripped
<b>DA1182</b>	Defender	2.4 Puma	Stripped
<b>DA1228</b>	Discovery 4/Range Rover Sport	3.0 TdV6	Stripped
<b>DA2039</b>	Freelander 1	1.8K	Complete



STC4723N

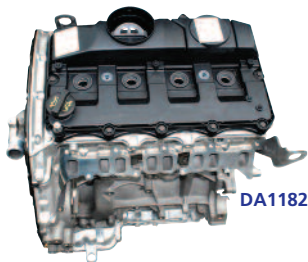

DA1182



DA2039



STC4723E

### Re-conditioned Engines

These engines have been through the following rigorous processes:

- Complete strip down
- Removal of all core plugs
- Thorough cleaning in environmentally-friendly, solvent-free washing machines
- Removal of all parts subject to wear
- Inspection of casings for signs of damage and corrosion
- Crack-testing of camshafts before and after re-grinding
- Re-boring of blocks and machining of decks to the correct surface finishes
- Fitting of perfectly-balanced, machined con-rods in accordance with manufacturers recommended piston protrusions
- Meticulous re-building of engines in individual, contaminant-free workstations
- Renewal of all bearings and gaskets throughout the engine
- Renewal/overhaul of oil pumps
- Replacement of all core plugs
- Dyno-testing of complete engines
- Final inspection
- Wrapping in cellophane and fitting into rigid, steel transportation frames

### Engines - Reconditioned

Please enquire on availability for all these reconditioned engines.

<b>STC4723E</b>	Defender/Discovery 1/Range Rover Classic	300Tdi	Stripped
<b>DA4250DIS</b>	Discovery 1	200Tdi	Complete

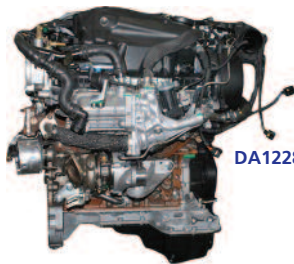

DA1228

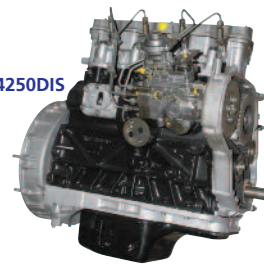

DA4250DIS

## Td5 Short Oil Filter **NEW**

Save time & effort with this easier to fit filter



### LPX100590XD **NEW**

Td5 oil filter. Shorter than the standard filter which makes this one much easier to fit and remove.



## Bleed Screws

Smart replacement anodised aluminium bleed screws for the top hose on a Td5 engine.

<b>PYP10008BLUE</b>	Blue
<b>PYP10008RED</b>	Red



## Heater Plug Upgrade Kit



DA1057

### DA1057

Series - 2.25 diesel engine

### DA1057PLUG

Replacement heater plug set for DA1057

### DA1057PLUG



## Injector Pipe Sets

Set of 4 injector pipes per kit

### 563165/6/7/8

Series - 2.25 diesel/Defender - 2.25 diesel

### ETC4291/2/3/4

Defender 2.5 diesel & 2.5 diesel turbo

### STC793/4/5/6

Defender - 200Tdi

### RTC6732/3/4/5

Discovery 1/Range Rover Classic - 200Tdi

### STC1694/5/6/7

Defender/Discovery 1/Range Rover Classic - 300Tdi - Less EDC

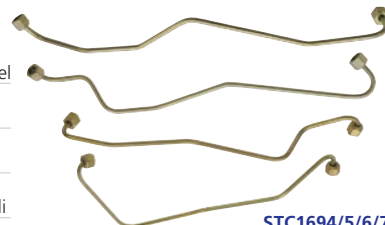

STC1694/5/6/7

## Main Bearing Sets



DA5120

Standard size set  
Freelander 1 - K-Series 1.8 engine



### DA5121

Defender - 2.4 Puma  
Standard size set

### DA5121AE

Defender - 2.4 Puma  
Standard size Glyco brand set



### DA5714

Discovery 3 - 2.7 TdV6  
Range Rover Sport - 2.7 TdV6  
Undersize 0.5mm main bearing set and big ends



Photograph courtesy of Mark Harrison

**Fuel Filter Holder**



**DA1159**  
Defender - 2007 onwards  
Replacement fuel filter holder

**Oil Cooler Repair Kit**



**DA1127**  
Td5 oil cooler repair kit, to replace leaking oil cooler found in all Td5 engines, part of PBC500230 assembly. Replace just the faulty cooler and not the casting which normally is perfectly serviceable, includes all hardware required. All manufactured to exactly OEM specification.

**Oil Pump Gear Set**



**DA4189**  
Oil pump gear set for V8 engines  
Discovery 1/Discovery 2/Range Rover P38

Contents - Timing belt tensioner; timing belt - OEM; gaskets & seals



**DA1200G**  
200Tdi engines - OEM kit

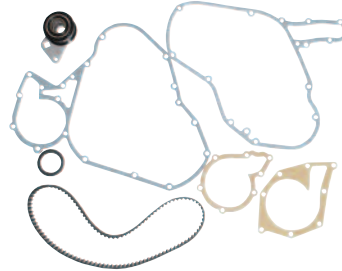

**DA1200**  
200Tdi engines



**DA1301**  
300Tdi engines - up to VA117353

**Timing Kits**



**DA1300**  
300Tdi engines - VA117354 onwards

**Injector Washer Kits**

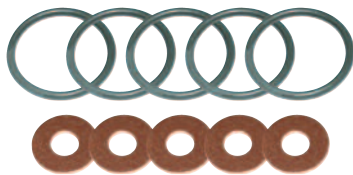

**DA2479LR**

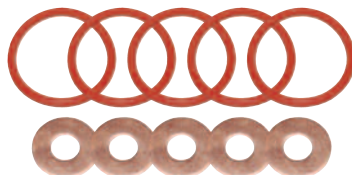

**DA2479G**

Td5 injector washer kits with O-rings and washers

<b>DA2479LR</b>	Genuine set
<b>DA2479G</b>	OEM set
<b>DA2479</b>	Britpart set

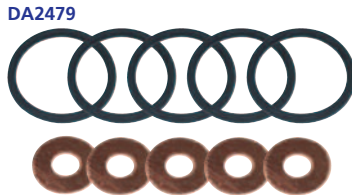

**DA2479**

**DA1185**  
This flanged repair liner is suitable for damaged/porous 3.9/4.0/4.2/4.6 Rover V8 blocks. The block will require reboring and flange recess machining before fitting. This liner is the complete solution for fixing these blocks. The liner can be bored to 96.00mm for over-bored versions of the V8 engine, taking it to 5.0 litres. Semi finished bore 94.00mm (less 1.00mm for final finishing in bore).

**Dimensions**  
Inside diameter - 94.00mm; outside diameter - 99.06mm; length - 135.64mm; flange - diameter - 105.23mm; flange depth - 5.33mm

**Top Hat Liner Set**



**Manifold Inlet Seal**

**LR004404S**  
Defender - Puma  
Manifold inlet seal. This is not available as a separate part from Land Rover.



**Pressure Relief Valve**

**DA2376**  
300Tdi oil pump relief valve kit for Range Rover Classic Defender Discovery 1



## Heating

### Heater Blower Motor Kit & Resistor Kit

#### DA4178

Range Rover Classic - 1990 - 1994 - 200Tdi with air con  
Discovery 1 - 200Tdi with air con  
Atlantic British has developed this all inclusive kit designed and engineered to replace failed heater motors. The kit includes heater blower motor, blower wheel, motor mounting bracket and mounting screws, heater assembly seals, nylon ties, solder, shrink tubing (for soldered connections) and complete instructions. **Note** - When replacing the heater blower motor the vehicle's resistor must be upgraded to DA4178RESISTOR

#### DA4178RESISTOR

The air con blower motor resistor controls the speed of the blower motor and the force of the airflow out of the dash vents, it features a thermal-sink aluminium mounting plate that dissipates circuit heat effectively.

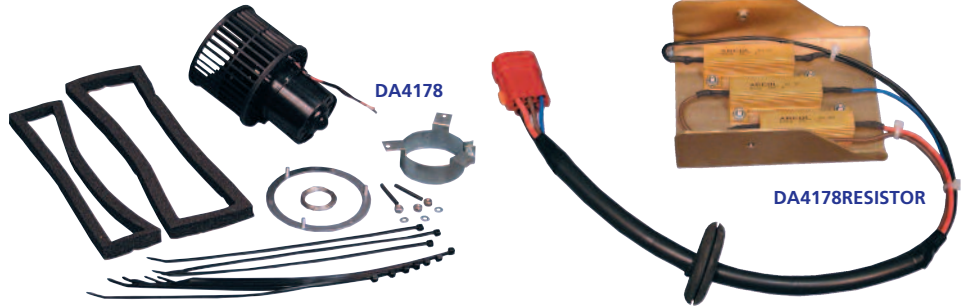

### Heater Matrixes

#### DA2155

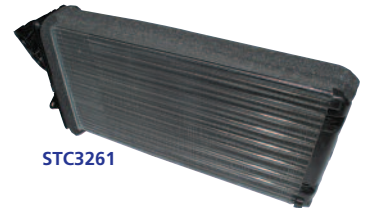
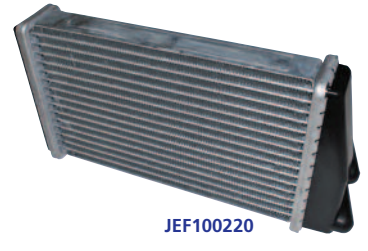

DA2155	Series 3
AAP817	Defender - downward facing pipes
UTP1725	Defender - horizontal inlet/outlet pipes
JEF100220	Defender - LHD - XA159807 onwards

STC250	Discovery 1/Range Rover Classic - 1986 - 1994
STC3135	Discovery 1/Range Rover Classic - 1992 - 1994
JEF100150	Freelander 1 - up to YA999999
STC3261	Range Rover P38

## Transmission

### Automatic Transmission Service Kits

**Degradation in oil can lead to judder, noise and a deterioration in gear change quality. ZF recommend oil and filter changes after 50,000 to 75,000 miles on automatic gearboxes to ensure optimum performance.**

This is an easy change filter conversion kit for all vehicles using the ZF 6HP26 automatic transmission - Discovery 3, Discovery 4, Range Rover Sport - 2005 - 2013 and Range Rover L322 models. From the factory a fluid and filter change on this transmission is a very lengthy process. The sump and filter are normally one piece and fitting involves jacking the engine up and unbolting the mounts, plus the removal of the exhaust.

**The fitting of this kit is far easier.** Once the fluid has been drained from the transmission simply remove the bolts from the old unit. Cut the old plastic sumps filter tube with a hacksaw. Slide the old sump out and remove the other end of the sawn off filter tube. The new separate filter can then be fitted and the new sump pan slides into place and is bolted up with the new gasket supplied. Once secure the transmission can be filled as per manufacturer's instructions. The new sump pan also has the added benefit that it is manufactured in durable steel rather than the plastic of the original item - LR007474. Also see DA6085 & DA6085G in service kit section. 7ltrs needed for oil change.

DA2142G	Filter conversion kit - OEM	DA2142	Filter conversion kit
DA2143G	Replacement filter - OEM	DA2143	Replacement filter
DA2144G	Replacement gasket - OEM	DA2144G	Replacement gasket - OEM
TYK500050G	ZF Lifeguard fluid - 1ltr	TYK500050	Ravenol fluid - 1ltr

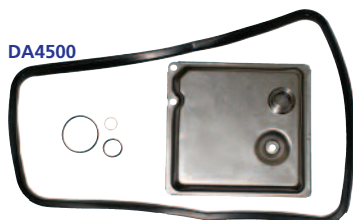
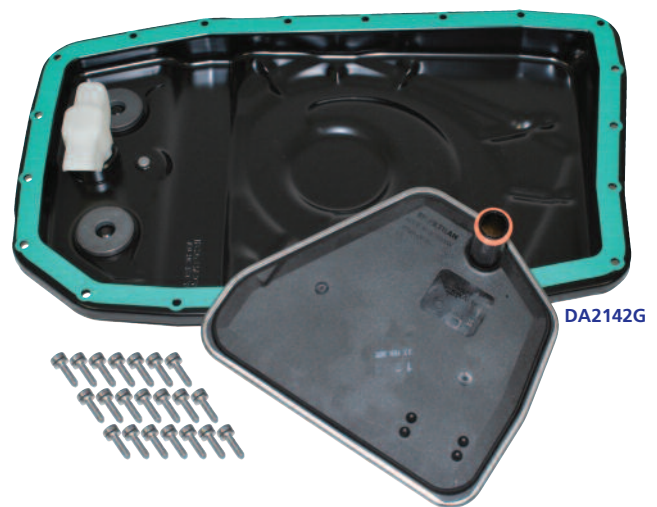

**DA4500**  
Service kit for 4-speed gearbox.  
Kit comprises of oil screen, seals, o-rings and sealing washer.  
  
Defender - up to 2007  
Discovery 1  
Discovery 2  
Range Rover Classic  
Range Rover P38

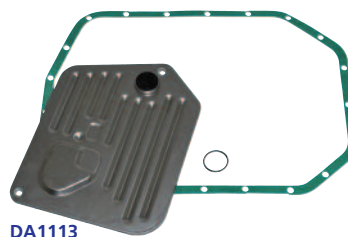

**DA1113**  
Service kit for 5-speed gearbox.  
Kit comprises of oil screen, seal & o-ring.  
  
Range Rover L322 - 4.4 V8

Britpart has put together these boxed kits to help the fitter have all the necessary parts to do the job in one hit, saving time and money trying to find the necessary parts to do the job. These kits are also helpful to pass over the trade counter instead of having to hunt for the individual parts. One kit does one CV joint.

Save **time** and **money** with a Britpart CV Joint kit

**DA6050**

Range Rover Classic - up to 1985

**DA6051**

Range Rover Classic - 1986 up to 1988 non-ABS axle suffix A up to EA305589

**DA6052**

Range Rover Classic - 1989 up to 1991 non-ABS axle suffix B from EA305590 up to HA610293

Range Rover Classic - 1992 on non-ABS up to JA624755

**DA6053**

Range Rover Classic - 1986 up to 1991 with ABS up to HA610293

**DA6054** **Note** - 10 spline on half shaft to diff end

Range Rover Classic - 1992 on non-ABS from KA624756 up to P38

Range Rover Classic - 1992 on with ABS up to P38

**DA6055** **Note** - 24 spline on half shaft to diff end

Range Rover Classic - 1992 on non-ABS from KA624756 up to P38

Range Rover Classic - 1992 on with ABS to P38

**DA6056**

Range Rover P38 - 1995 up to 2002

**DA6057** **Note** - 10 splines axle shaft to diff end

Defender - non-ABS with 23 internal splines

**CV Joint Kits**



**DA6058**

Defender - 1986 on non-ABS with 32 internal splines

**DA6059**

Defender - non-ABS and ABS models from LA up to 2007

**DA6060**

Discovery 1 - non-ABS up to JA32850

**DA6061**

Discovery 1 - non-ABS JA032851 onwards

**DA6062**

Discovery 1 - non-ABS - JA032851 onwards

Discovery 1 - ABS models - JA032851 onwards

**DA6063**

Discovery 2

**DA6064**

Freelander 1 - up to YA999999 TCIE diesel and 1.8 petrol

**Note** - 10 splines axle shaft to diff end

**Note** - 24 splines axle shaft to diff end

**Note** - 24 splines axle shaft to diff end

**Damper Kit**



**DA2352**

Freelander 1 - up to 2006 4-cylinder

Not all viscous coupling problems are the fault of the unit itself, sometimes the damper is at fault, this kit prevents buying the whole coupling, just to replace the damper.

We are now able to offer a cheaper alternative!

**DA2355**

The Range Rover L322 - 2002 onwards, suffer from a common problem with the coupling shaft spline wearing between the front propshaft and front differential, thus losing drive to the differential. The problem purely relates to the coupling shaft and the differential itself is not affected. Currently the only solution offered by Land Rover is to replace the propshaft and the whole complete front differential assembly - a very expensive option! Using this new coupling shaft will enable you to replace just the propshaft and coupling shaft and leave the differential in place, therefore reducing both time (the differential need not be removed from the vehicle) and cost.

**Diff Coupling Shaft**



**Diff Repair Pans**



**DA1043**



**DA1044**



**DA1045**

**DA1043**

Front - includes filler plug Defender/Discovery 1/Range Rover Classic/ Series

**DA1044**

Rear - includes filler plug Defender 90/Discovery 1/ Range Rover Classic/ Series

**DA1045**

Front & rear - excludes filler plug Series - early models



Photograph courtesy of Liam Davison

# Changing your clutch?

Clutch Kits

Then demand your dealer uses a clutch kit from Britpart!

- Extensive testing determined the ultimate specification
- Premier friction material gives longer life
- Self centring bearing provides smooth operation
- Intense quality control ensure fit first time

### Heavy-duty Clutches & Parts

<b>DA5551</b>	Defender/Discovery 1/Range Rover Classic - 200/300Tdi Heavy-duty clutch kit	Plate, cover & bearing
<b>DA5551G NEW</b>	Defender/Discovery 1/Range Rover Classic - 200/300Tdi OEM Heavy-duty clutch kit	Plate, cover & bearing
<b>DA5551KIT</b>	Defender/Discovery 1/Range Rover Classic - 200/300Tdi Heavy-duty clutch kit	Plate, cover, heavy-duty bearing & heavy-duty clutch fork
<b>DA5552</b>	Defender/Discovery 1/Range Rover Classic - 200/300Tdi Heavy-duty clutch kit	Plate, cover, less bearing
<b>DA2357HD</b>	Britpart kit / <b>DA2357HDG</b> - AP Driveline kit Defender/Discovery 2 - Td5	Heavy-duty clutch kit Plate, cover, heavy-duty flywheel & bearing



DA5551

Heavy-duty one-piece dual mass replacement flywheel designed to outlast the original. Kit also includes modified release bearing.

**Note** - Fitment of this kit will increase gearbox noise.

<b>DA2357CP</b>	Replacement clutch kit for DA2357HD	Heavy-duty clutch kit	Plate & cover
<b>PSD103470BRG</b>	Replacement clutch release bearing for DA2357HD	Clutch release bearing - heavy-duty	
<b>FTC2957HD</b>	Various applications - Defender/Discovery 1/Range Rover Classic	Clutch fork - heavy-duty	
<b>FTC2957HDKIT</b>	Various applications - Defender/Discovery 1/Range Rover Classic - diesel only/non-V8	Clutch fork installation kit - heavy-duty	
<b>FTC5200HD</b>	Defender - 1987 - 2006/Discovery 1/Discovery 2/Range Rover P38	Includes heavy-duty clutch fork, slipper pads, bush, staple & clip	
		Clutch release bearing - heavy-duty	

FTC5200HD



DA2357HD



FTC2957HDKIT



DA5551KIT



For many more clutch product pictures go to [www.britpart.com/clutches](http://www.britpart.com/clutches)

### Standard Clutches & Parts

<b>DA5550</b>	Defender/Discovery 2 - Td5	Clutch kit	Plate, cover & bearing
<b>DA5550G</b>	Defender/Discovery 2 - Td5	Clutch kit - OEM	Plate & cover less bearing
<b>DA2357</b>	Defender/Discovery 2 - Td5	Clutch kit	Plate, cover, flywheel & bearing
<b>DA2357G NEW</b>	Defender/Discovery 2 - Td5	Clutch kit - Valeo	Plate, cover & flywheel
<b>STC8358</b>	Defender - diesel (non-Td5)/Discovery 1 - diesel/Range Rover Classic	Clutch kit	Plate, cover & bearing
<b>LR012199</b>	Defender - 2007 onwards	Clutch kit	Plate & cover
<b>LR012199C</b>	Defender - 2007 onwards	Clutch cover	
<b>LR012199P</b>	Defender - 2007 onwards	Clutch plate	
<b>STC8363</b>	Series 3	Clutch kit	Plate, cover & bearing
<b>DA2369</b>	Series 2A	Clutch kit (9")	Plate & cover
<b>DA2370</b>	Series 2A	Clutch kit (9 1/2")	Plate & cover
<b>EST110075/76KIT</b>	Santana - 2.8 Anibal PS10 <b>NEW</b>	Clutch kit - Borg & Beck	Plate, cover & bearing
<b>URB500060</b>	Freelander 1 - 1.8 petrol	Clutch kit	Plate, cover & bearing
<b>DA6250</b>	Freelander 1 - 2.0 Td4	Dual mass flywheel conversion kit	
<b>DA6250G</b>	Freelander 1 - 2.0 Td4	OEM Dual mass flywheel conversion kit	

The flywheel conversion kit can be used to replace the dual mass flywheel using a solid metal flywheel and a heavy duty clutch kit. Kit contains - solid mass flywheel, replacement clutch cover & replacement clutch plate. The one piece flywheel will not break up like the dual mass one so it is highly likely you will never need to change it again which means - lower cost, ease of fitment & potentially eliminating any future flywheel failures.

**Note** - This kit will make the gearbox more audible in the car at tick over and the kit doesn't include the release bearing - UUB000070.

<b>DA6251</b>	Service kit for DA6250		Plate & cover
<b>DA5558</b>	Freelander 2 - 2.2 diesel	Clutch kit	Plate, cover & concentric slave cylinder
<b>LR008556</b>	Freelander 2 - up to AH999999	Clutch kit	OEM Plate & cover
<b>DA5559</b>	Freelander 2 - BH000001 onwards/Range Rover Evoque	OEM Clutch kit	Plate, cover & concentric slave cylinder

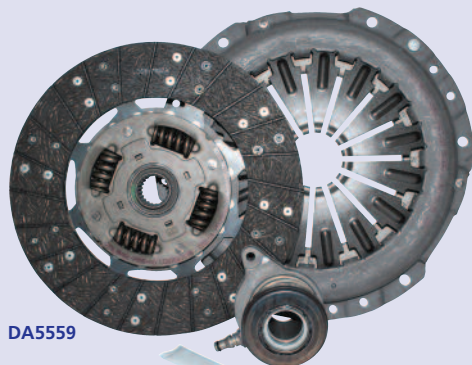

DA5559

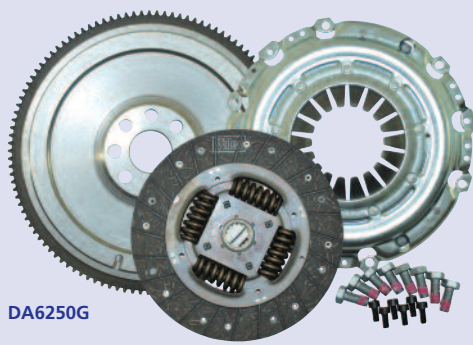

DA6250G

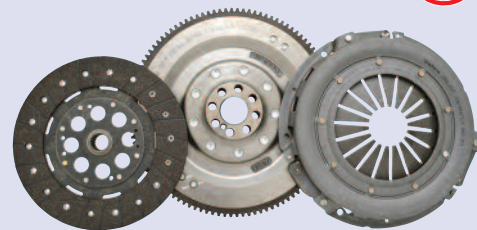

DA2357G



**Gear Boxes**

**Gear Boxes - New**

<b>TRC103150</b>	Defender	LT77 - 50A suffix L
<b>TRC103270</b>	Discovery 2	V8 efi
<b>TRC102900</b>	Freelander 1	Petrol 1.8K16

**Gear Boxes - Reconditioned**

<b>DA3050</b>	Defender	4-cylinder up to 200Tdi	LT77/S	50G/H
<b>DA3051</b>	Defender	200Tdi	LT77/S	56G/H
<b>TRC103160E</b>	Defender	300Tdi	R380	56J
<b>DA3058</b>	Defender	Td5	R380	68A
<b>LR039149</b>	Defender	2007 onwards	6-speed	
<b>DA3052</b>	Discovery 1	200Tdi	LT77/S	55G/H
<b>DA3054</b>	Discovery 1	300Tdi	R380	55J
<b>TRC103350E</b>	Discovery 2	Diesel - less oil cooler		
<b>DA3055</b>	Range Rover P38	Diesel	R380	65J

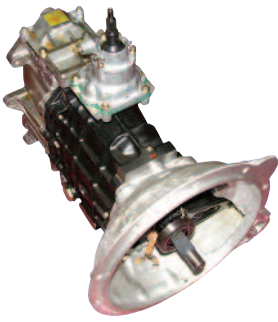

**Gear Change Kits**

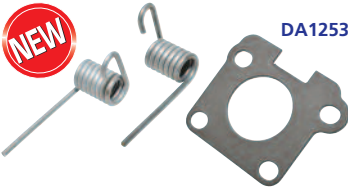

**DA1252 NEW**  
LT77 gearbox  
Range Rover Classic - up to LA  
Discovery 1 - up to LA

**DA1253 NEW**  
R380 gearbox  
Range Rover Classic - MA onwards  
Discovery 1 - MA onwards  
Discovery 2

**Diff Overhaul Kits NEW**



**DA5039 NEW**  
Front diff overhaul kit  
4 bearings & 3 main oil seals  
Discovery 3/ Discovery 4/  
Range Rover Sport - 2005 - 2013



**DA5035 NEW**  
Rear non-locking diff overhaul kit  
6 bearings & 3 main oil seals  
Discovery 3/ Discovery 4/  
Range Rover Sport - 2005 - 2013



**DA5038 NEW**  
Rear locking diff overhaul kit  
5 bearings & 3 main oil seals  
Discovery 3/ Discovery 4/  
Range Rover Sport - 2005 - 2013

**Diff Rebuild Kit**



**DA7211**  
Freelander 2  
Rear diff rebuild kit  
Customers may report excessive noise, either humming, a rumble or high pitched whine coming from the rear diff. This OEM kit will repair the pinion tail bearing which may cause the noise.

**Detent Repair Springclip NEW**



**DA6247 NEW**  
Detent repair springclip to fit Discovery 3 & 4 manual gearboxes. Experiencing problems engaging reverse gear? To save expensive gearbox repairs or replacements it may just be this simple clip has broken. It is easily checked and replaced without any removal of the gearbox itself.

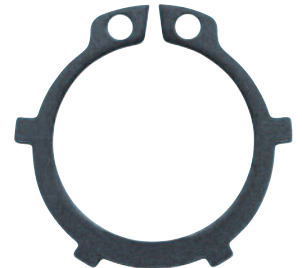

**IRD Repair Kit**

**DA6440**  
Freelander 1  
Repair kit for intermediate reduction drive assembly (TAG000230)



**Propshaft Bearings**

**DA2395**  
Discovery 3/Discovery 4 - TVB500360  
**DA2428**  
Range Rover L322 - TVB500400  
**DA2427**  
Range Rover Sport - 2005 - 2013 - TVB500390

Centre bearing assembly for rear propshafts

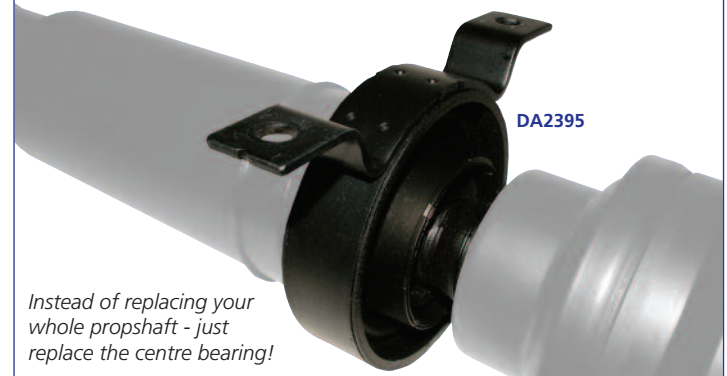

*Instead of replacing your whole propshaft - just replace the centre bearing!*

Rear Diff & Carrier



**DA1216HALDEX NEW**  
Freelanders 2/Range Rover Evoque  
Generation 4 Haldex unit



**DA1241 NEW**  
Range Rover Evoque - EH000001 onwards  
Dynamic Driveline rear diff carrier to  
replace LR052118



**DA1216DIFF NEW**  
Freelanders 2/Range Rover Evoque  
Complete rear universal diff



**DA1216ECU NEW**  
Freelanders 2/Range Rover Evoque  
ECU unit. Please check VIN number with  
supplier.

Transfer Boxes

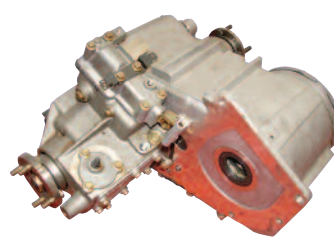

**IAB500104E**  
Defender  
Prefix 57D Td5 from 3A

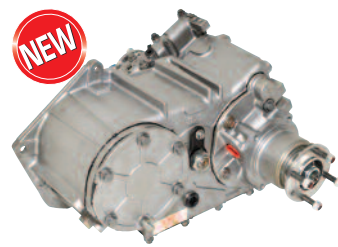

**LR052756 NEW**  
Defender - 2007 onwards





**Chassis - Complete Galvanised Frames**

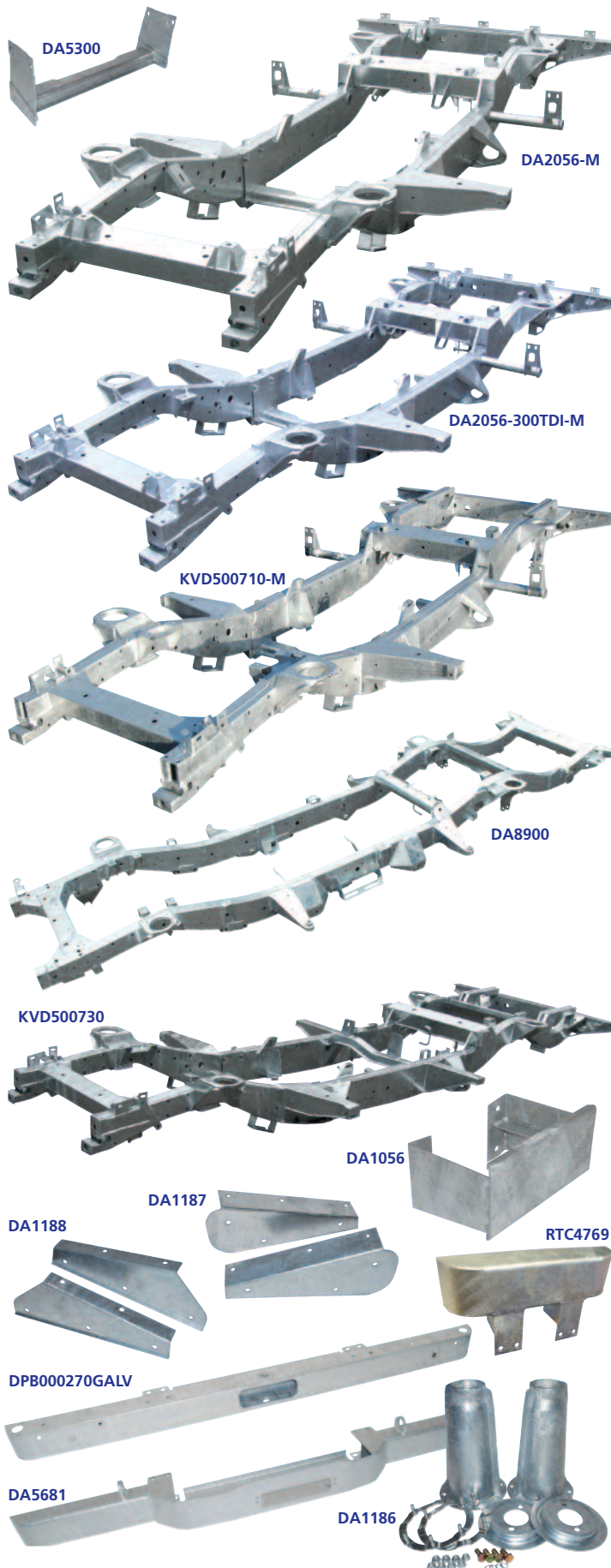

**Defender**

<b>DA2056-M</b>	Defender 90	Nat. asp./2.5 Td/200Tdi	Marsland chassis
<b>DA2056-300TDI-M</b>	Defender 90	300Tdi	Marsland chassis
<b>KVD500710-M</b>	Defender 90	Td5	Marsland chassis
<b>DA2057*</b>	Defender 110	Nat. asp./2.5 Td/200Tdi	Marsland chassis
<b>DA2057-300TDI*</b>	Defender 110	300Tdi	Marsland chassis
<b>KVD500730</b>	Defender 110	Td5	Marsland chassis
<b>DA5300</b>	Defender 90 & 110	Bolt on crossmember - galvanised with fittings	

\*suitable for pick-up and station wagons

**Discovery**

<b>DA8900</b>	Discovery 2 - Td5	Up to 3A	Richards chassis
---------------	-------------------	----------	------------------

**Series**

<b>NRC4642G</b>	Series SWB		Richards chassis
<b>NRC4356</b>	Series LWB		Richards chassis

**Marsland Chassis**

Chassis have bolt on gear box crossmember as standard with anti-roll bar brackets front and rear. The main legs are in pressed pieces as original made from 2mm steel with 3mm stiffeners fitted and spotwelded internally for added strength where outriggers and suspension mounting points are fitted, effectively giving you 5mm of material where most needed. Bolt on rail for rear tub mountings and LH & RH steering damper bracket welded on as standard. All tapped holes redrilled and tapped, excess galv removed with riv nuts fitted for front & rear mud flaps, power steering pipe clips and step. Rear suspension upper link bush (A-frame) fitted with new M16 bolt and sleeve to fit old level bush.

**Richards Chassis**

All Richards chassis are manufactured in the UK, using locally sourced materials and locally based machine shops. They are located close to the steel city, Sheffield, and therefore optimise the use of local steel, ensuring that all their chassis are formed from 2.5mm British steel which are all galvanised as standard. All profiling is done 'in house' using their own laser machine, enabling them to have greater control over the quality of parts used and the materials that they are formed from. The chassis are made using 2.5mm side rails which are 25% heavier than the standard 2.0mm rails. Overall this gives a small increase in the vehicle weight but has a massive effect on the long term durability of the chassis. Bolt on crossmembers are not supplied with Richards chassis but are available separately - see **DA5300** above.

**IMPORTANT**

This page is a selection of the chassis' that we do. Please enquire if the chassis you require is not listed here.

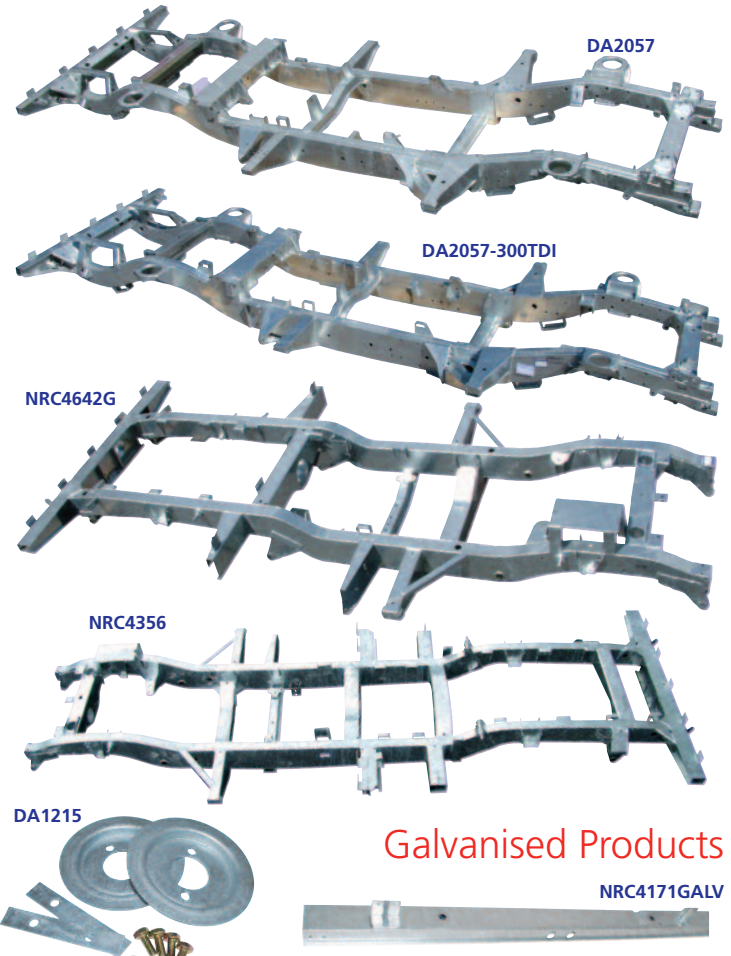

**Galvanised Products**

<b>DA5681</b>	Heavy-duty steel winch bumper	Defender - non air-con	Suitable for DB12000i, DB9500i, DB9000C & DB8000 winches
<b>DPB000270GALV</b>	Military front bumper	Defender	
<b>RTC4769</b>	Front bumperette - single	Defender/Series	
<b>DA1188</b>	Front mud flap brackets - pair	Defender 90 & 110	Equivalent to MTC3000 & MTC3001
<b>DA1187</b>	Rear mud flap brackets - pair	Defender 90	Equivalent to MUC3986 & MUC3987
<b>DA1056</b>	Military style bumperette - single	Lightweight	
<b>DA1186</b>	Standard height front shock turrets with fitting kit	Defender/Discovery 1/Range Rover Classic	
<b>DA1215</b>	Rear spring seat fitting kit	Defender - 90/Discovery 1/Range Rover Classic	
<b>DA1233</b>	Rear spring seat fitting kit	Defender - 110 & 130	
<b>NRC4171GALV</b>	Bolt-on centre crossmember	Defender Station wagon & crew cab	

## Defender - Chassis & Body Components

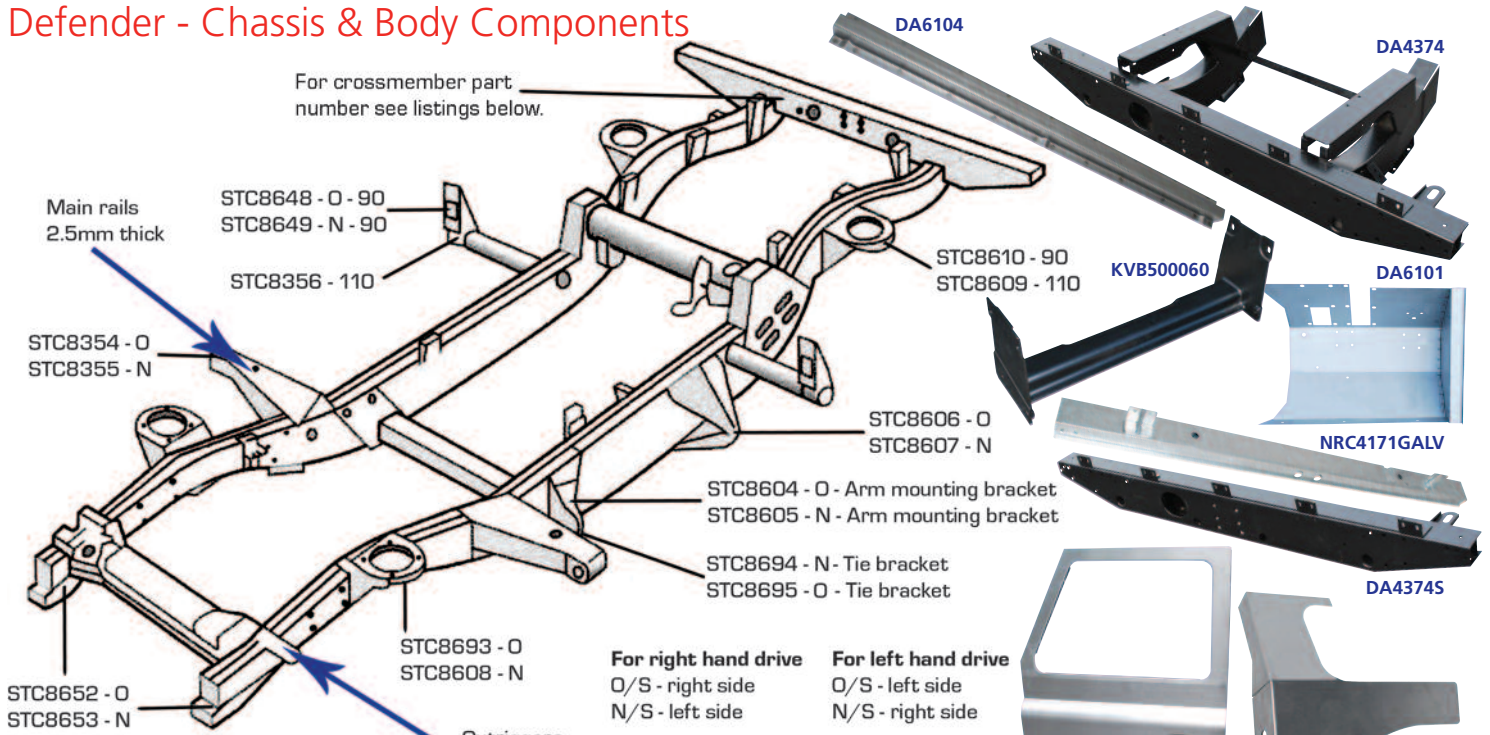

Bodywork				
Bodywork - Bulkhead				
DA40650	90/110	Bulkhead upper repair panel		RHS
DA4065N	90/110	Bulkhead upper repair panel		LHS
Bodywork - Doors				
ALR6852	90/110	Rear door - less spare wheel carrier From MA939976 up to 1A622423		
BIC710260	90/110	Rear door - 1 piece		
CQB000140	90/110	Glass for BIC710250		
LR031526	90/110	Heated glass for BIC710250		
CVW500010	90/110	Glazing rubber for BIC710250		
DA2026O		Door pillar repair - bulkhead/bracket		RHS
DA2026N		Door pillar repair - bulkhead/bracket		LHS
DA2024	90/110	Safari rear door skin		
DA4143	90/110	Front door skin - push button handle		RHS
DA4144	90/110	Front door skin - push button handle		LHS
STC542	90/110	Front door assembly - lift handle		RHS
STC543	90/110	Front door assembly - lift handle		LHS
DA5130	110/130	2nd row door skins - up to 5A689036		RHS
DA5131	110/130	2nd row door skins - up to 5A689036		LHS
RTC6247	90/110	Safari rear door - unglazed with spare wheel		
RTC6248	90/110	Safari rear door - glazed without spare wheel		
RTC6248NG	90/110	Safari rear door - unglazed without spare wheel		
STC1424	90/110	Rear door - less spare wheel carrier From AA242000 up to KA929577		
DA4086	90/110	Rear door bottom repair section		
DA6104	90/110	Side door bottom repair section		
DA1070	90/110	Front door hinge kit - torx head bolts kit		
DA1131	90/110	Front door hinge kit - aluminium hinges		
DA1240 <b>NEW</b>	90/110	Rear end door hinge kit - stainless steel fitting kit		
Bodywork - Floor				
DA6101	90/110	Footwell - right hand drive		RHS
DA6100	90/110	Footwell - right hand drive		LHS
DA6103	90/110	Footwell - left hand drive		RHS
DA6102	90/110	Footwell - left hand drive		LHS
ALR1742	90/110	Floor panel - front - Tdi/Td5/V8		RHS
ALR1743	90/110	Floor panel - front - Tdi/Td5/V8		LHS
Bodywork - Windows				
DA4032	90/110	Window kit - standard	Pair	Clear
DA4032GREY	90/110	Window kit - standard	Pair	Grey tinted
DA4033	90/110	Window kit - deluxe	Pair	Clear
DA4033GREEN	90/110	Window kit - deluxe	Pair	Green tinted
DA4033GREY	90/110 <b>NEW</b>	Window kit - deluxe	Pair	Grey tinted
DA4033BRONZE	90/110	Window kit - deluxe	Pair	Bronze tinted
DA4033CATCH		Replacement catch for deluxe window kit		Single
DA4032-3SEAL		Replacement window seal for above part numbers. One seal per kit.		
Bodywork - Wings				
ALR6122	90/110	Front outer wing panel		RHS
ALR6121	90/110	Front outer wing panel		LHS
ASB710260	90/110	Front outer wing panel		RHS
ASB710270	90/110	Front outer wing panel		LHS
ALR6678	90/110	Front outer wing panel		RHS
ALR6677	90/110	Front outer wing panel		LHS
RTC6351	90/110	Front outer wing panel		RHS
RTC6350	90/110	Front outer wing panel		LHS
RTC6352	90/110	Front outer wing panel		LHS
<i>ABS plastic front outer wing panels</i>				
DA2397	90/110	Replacement for ALR6678, ASB710280 & RTC6351		RHS
DA2399	90/110	Replacement for ALR6122 & ASB710260		RHS
DA2396	90/110	Replacement for RTC6352, ALR6677 & ASB710290		LHS
DA2398	90/110	Replacement for RTC6350, ALR6121 & ASB710270		LHS

Chassis				
Chassis - Axle				
STC8604	90/110	Front radius arm mount		RHS
STC8605	90/110	Front radius arm mount		LHS
STC8606	90/110	Rear radius arm mount		RHS
STC8607	90/110	Rear radius arm mount		LHS
Chassis - Bulkhead				
STC8354	90/110	Bulkhead outrigger		RHS
STC8355	90/110	Bulkhead outrigger		LHS
STC8695	90/110	Tie bracket from bulkhead rigger		RHS
STC8694	90/110	Tie bracket from bulkhead rigger		LHS
Chassis - Crossmembers				
ANR2056	90/110	Rear crossmember no extensions - pre-Td5		
DA4019	90*	Rear crossmember plus extensions - pre-Td5		
DA4020	110*	Rear crossmember plus extensions - pre-Td5		
DA4373	90*	Rear crossmember plus extensions - Td5		
DA4374	110*	Rear crossmember plus extensions - Td5		
DA4373S	90	Rear crossmember with short extensions - Td5		
DA4374S	110	Rear crossmember with short extensions - Td5		
KVB500060	90/110	Bolt on crossmember		
DA5300	90/110	Bolt on crossmember - galvanised with fittings		
*With long extensions and body brackets - see website for pictures.				
KVB500230	110	Crossmember assembly - 2nd row seats Defender - 2007 onwards - crew cab		
KVB000290	90/110	Rear crossmember no extensions - 2A627496 onwards		
NRC4171GALV	110	Station wagon & crew cab galvanised bolt-on centre crossmember		
Chassis - General				
DA4516	90/110	Rear tie bar mounting bracket - single		
STC8356	110	Rear outrigger		RHS/LHS
STC8648	90	Rear tubular outrigger		RHS
STC8649	90	Rear tubular outrigger		LHS
STC8652	90/110	Front chassis leg		RHS
STC8653	90/110	Front chassis leg		LHS
Chassis - Suspension Mounts				
DA4509	90/110	Front axle spring mount - 40mm lift		RHS
DA4508	90/110	Front axle spring mount - 40mm lift		LHS
DA4514	90/110	Front axle spring mount - standard		RHS
DA4513	90/110	Front axle spring mount - standard		LHS
DA4515	90/110	Rear shock absorber bracket - pair		
DA4518	90/110	Rear axle spring mount - 40mm lift		
DA4527	90/110	Rear axle spring mount - standard		
STC8693	90/110	Front spring seat		RHS
STC8608	90/110	Front spring seat		LHS
STC8610	90	Rear spring seat		RHS/LHS
STC8609	110	Rear spring seat		RHS/LHS

For many more body & chassis product pictures go to [www.britpart.com/chassis](http://www.britpart.com/chassis)



**Discovery 1 - Chassis & Body Components**

**Bodywork**

**Bodywork - Doors**

<b>ALR5822</b>	Door outer skin - MA163103 onwards	Front	RHS
<b>ALR5823</b>	Door outer skin - MA163103 onwards	Front	LHS
<b>ALR8576</b>	Door outer skin - TA163104 onwards	Front	RHS
<b>ALR8577</b>	Door outer skin - TA163104 onwards	Front	LHS
<b>ALR8572</b>	Door outer skin - TA163104 onwards	Rear	RHS
<b>ALR8573</b>	Door outer skin - TA163104 onwards	Rear	LHS
<b>MWC9084</b>	Door outer skin - MA112622 onwards	Rear	RHS
<b>MWC9085</b>	Door outer skin - MA112622 onwards	Rear	LHS

**Bodywork - Floor**

<b>ASR1186</b>	Rear floor plate		
<b>ASR1594</b>	Floor panel		RHS
<b>ASR1595</b>	Floor panel		LHS

**Bodywork - General**

<b>MWC4840</b>	Wheel arch panel	5-Door	RHS
<b>MWC4841</b>	Wheel arch panel	5-Door	LHS
<b>DA4008O</b>	Battery carrier		RHS
<b>DA4008N</b>	Battery carrier		LHS
<b>MWC6702</b>	Bonnet assembly		

**Bodywork - Sills**

<b>MWC9060</b>	Inner sill	3/5-Door	RHS
<b>MWC9061</b>	Inner sill	3/5-Door	LHS
<b>STC2814</b>	Outer sill	3-Door	RHS
<b>STC2813</b>	Outer sill	3-Door	LHS
<b>STC2816</b>	Outer sill	5-Door	RHS
<b>STC2815</b>	Outer sill	5-Door	LHS

**Bodywork - Wings**

<b>MWC6754</b>	Wing - up to LA081991	Front	RHS
<b>ALR6682</b>	Wing - MA onwards	Front	RHS
<b>ALR6681</b>	Wing - MA onwards	Front	LHS
<b>ALR9878</b>	Wing - VA onwards	Front	RHS
<b>ALR9877</b>	Wing - VA onwards	Front <td LHS	
<b>DA4586O</b>	Inner wing repair section	Front	RHS
<b>DA4586N</b>	Inner wing repair section	Front	LHS

**Chassis**

**Chassis - Bulkhead**

<b>ALR6272</b>	Bulkhead - MA081991 onwards	Front
----------------	-----------------------------	-------

**Chassis - Crossmembers**

<b>ALR8519</b>	Front floor crossmember	
<b>ALR8520</b>	Rear crossmember	
<b>ASR1187</b>	Rear floor crossmember	
<b>DA4530</b>	Rear crossmember end repair panels for crossmember STC1066	Pair
<b>STC1066</b>	Crossmember assembly rear floor	

**Chassis - General**

<b>DA4516</b>	Rear tie bar mounting bracket	Single
<b>DA4519</b>	Rear body mount	

**Chassis - Suspension Mounts**

<b>DA4509</b>	Front axle spring mount - 40mm lift	RHS
<b>DA4508</b>	Front axle spring mount - 40mm lift	LHS
<b>DA4514</b>	Front axle spring mount - standard	RHS
<b>DA4513</b>	Front axle spring mount - standard	LHS
<b>DA4515</b>	Rear shock absorber bracket	Pair
<b>DA4518</b>	Rear axle spring mount - 40mm lift	
<b>DA4527</b>	Rear axle spring mount - standard	

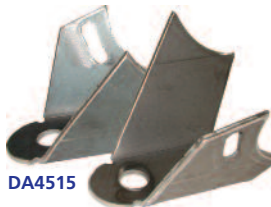
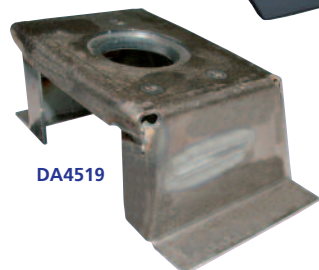
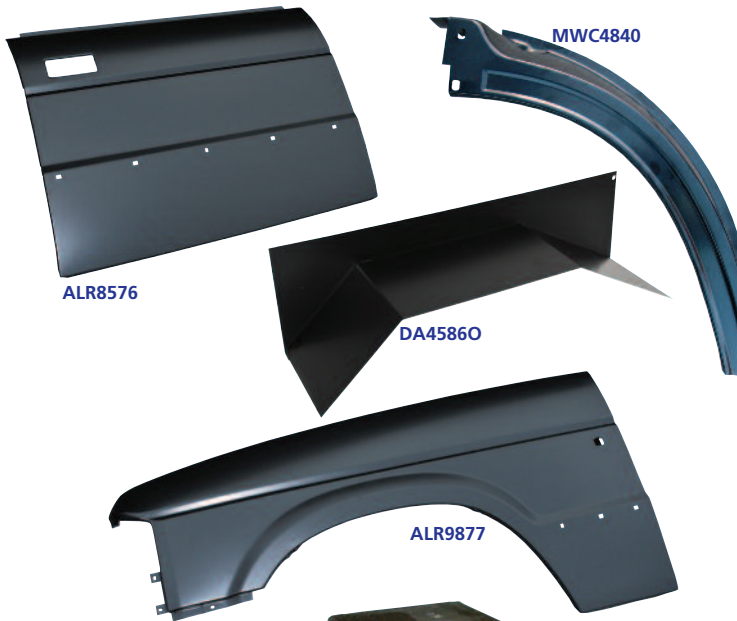
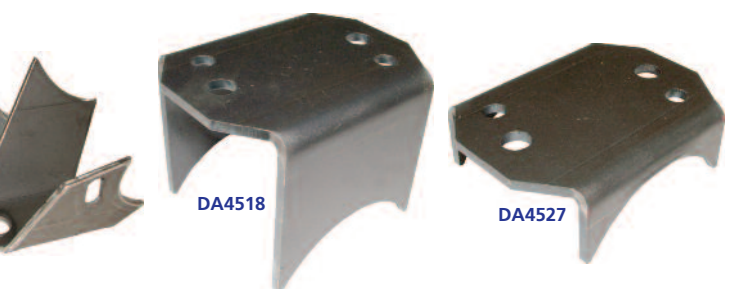
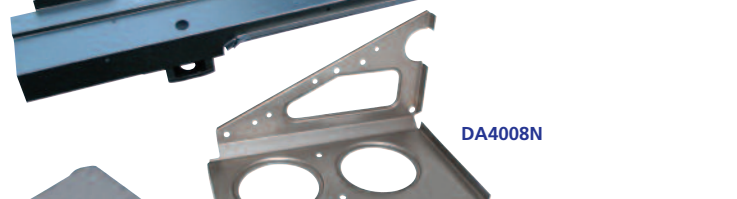
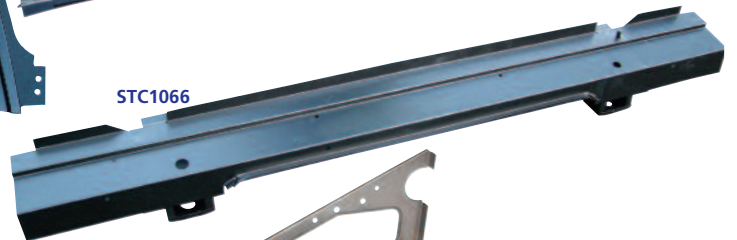

For many more body & chassis product pictures go to [www.britpart.com/chassis](http://www.britpart.com/chassis)

## Discovery 2 - Chassis & Body Components



DA8902O



DA8902N



DA8903

DA8902O	Rear chassis leg	RHS
DA8902N	Rear chassis leg	LHS
DA8903 <b>NEW</b>	Rear quarter chassis	



**Range Rover Classic - Chassis & Body Components**

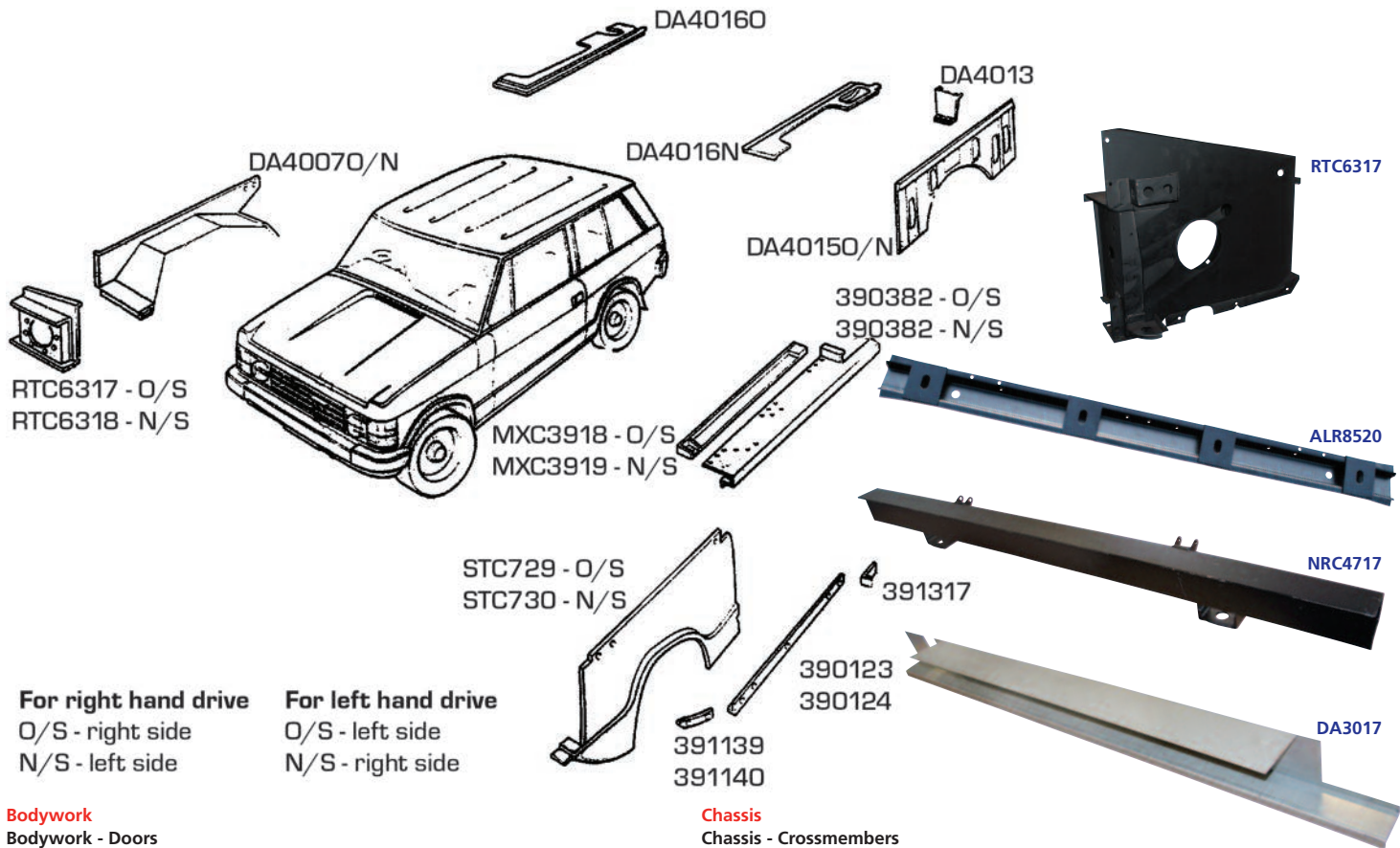

**For right hand drive**  
O/S - right side  
N/S - left side

**For left hand drive**  
O/S - left side  
N/S - right side

**Bodywork**

**Bodywork - Doors**

<b>MXC2064</b>	Door outer skin - front	4-door	RHS
<b>MXC2063</b>	Door outer skin - front	4-door	LHS

**Bodywork - General**

<b>DA40130</b>	Rear arch extension - rear		RHS
<b>DA4013N</b>	Rear arch extension - rear		LHS
<b>RTC6204</b>	Light panel - rear		LHS
<b>RTC6317</b>	Headlamp box		RHS
<b>RTC6318</b>	Headlamp box		LHS
<b>DA40080</b>	Battery carrier		RHS
<b>DA4008N</b>	Battery carrier		LHS
<b>DA6367 NEW</b>	Rear quarter window seal	4-door	Pair

**Bodywork - Sills**

<b>390381</b>	Complete sill - outer, no mounts	2-door	RHS
<b>390382</b>	Complete sill - outer, no mounts	2-door	LHS
<b>DA3016</b>	Outer sills	2-door	RHS
<b>DA3017</b>	Outer sills	2-door	LHS
<b>DA41200</b>	Half sill (repair) - outer	4-door	RHS
<b>DA4120N</b>	Half sill (repair) - outer	4-door	LHS
<b>MXC3918</b>	Sill inner	2-door	RHS
<b>MXC3919</b>	Sill inner	2-door	LHS
<b>STC1136</b>	Outer sills	4-door	RHS
<b>STC1135</b>	Outer sills	4-door	LHS

**Bodywork - Wings**

<b>DA40070</b>	Inner wing		RHS
<b>DA4007N</b>	Inner wing		LHS
<b>DA40160</b>	Rear inner wing - floor section		RHS
<b>DA4016N</b>	Rear inner wing - floor section		LHS
<b>DA40150</b>	Rear inner wing - side panel		RHS
<b>DA4015N</b>	Rear inner wing - side panel		LHS
<i>ABS plastic front outer wing panels</i>			
<b>DA2468</b>	Replacement for STC729 - up to 1988		RHS
<b>DA2467</b>	Replacement for STC730 - up to 1988		LHS
<b>DA2469</b>	Replacement for MXC1408 - 1989 onwards		RHS
<b>DA2470</b>	Replacement for MXC1409 - 1989 onwards		LHS

**Chassis**

**Chassis - Crossmembers**

<b>ALR8520</b>	Rear crossmember - 1990 onwards
<b>NRC4717</b>	Tailgate crossmember - rear

**Chassis - General**

<b>DA4516</b>	Rear tie bar mounting bracket - single
---------------	----------------------------------------

**Chassis - Suspension Mounts**

<b>DA4509</b>	Front axle spring mount - 40mm lift	RHS
<b>DA4508</b>	Front axle spring mount - 40mm lift	LHS
<b>DA4514</b>	Front axle spring mount - standard	RHS
<b>DA4513</b>	Front axle spring mount - standard	LHS
<b>DA4515</b>	Rear shock absorber bracket - pair	
<b>DA4518</b>	Rear axle spring mount - 40mm lift	
<b>DA4527</b>	Rear axle spring mount - standard	



For many more body & chassis product pictures go to [www.britpart.com/chassis](http://www.britpart.com/chassis)

## Series 2 & 3 - Chassis & Body Components

DA2099 - 1/2 chassis - SWB

NRC236 - Cross member - no ext

NRC236E - Cross member - with ext

DA4017 - 1/4 chassis - SWB

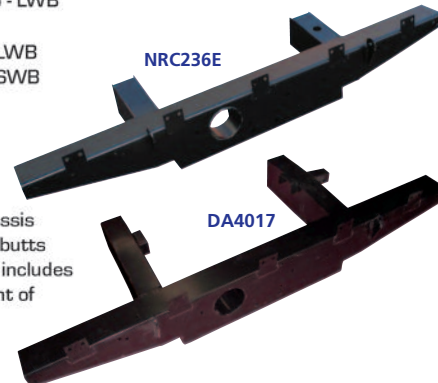
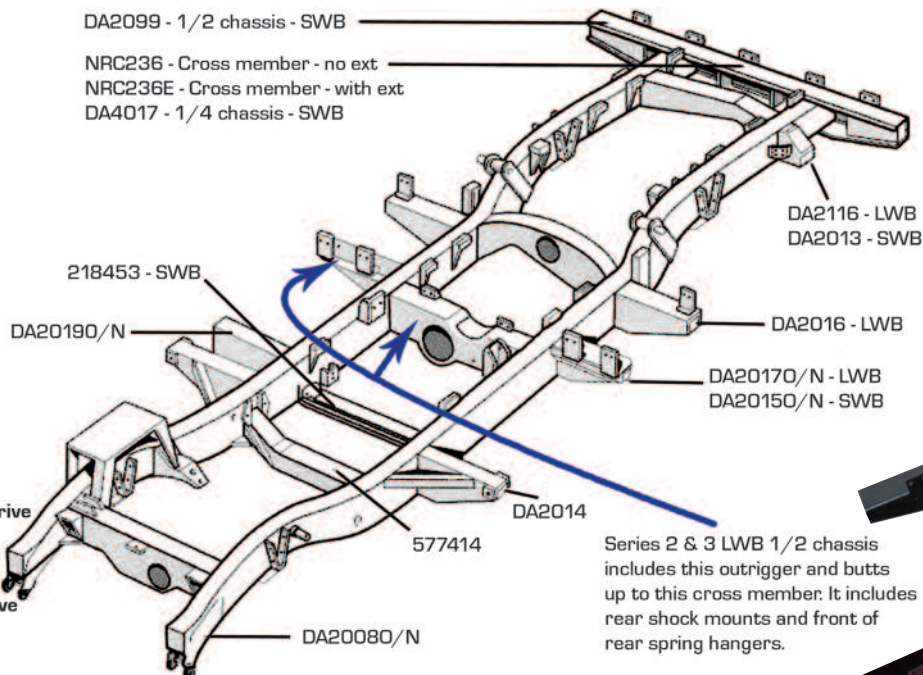

**For right hand drive**  
O/S - right side  
N/S - left side

**For left hand drive**  
O/S - left side  
N/S - right side

Series 2 & 3 LWB 1/2 chassis includes this outrigger and butts up to this cross member. It includes rear shock mounts and front of rear spring hangers.

### Bodywork

#### Bodywork - Bulkhead

DA4065O	SWB/LWB	Bulkhead upper repair panel	RHS
DA4065N	SWB/LWB	Bulkhead upper repair panel	LHS

#### Bodywork - Doors

395529	SWB/LWB	Door bottom	RHS
395530	SWB/LWB	Door bottom	LHS
DA2007	SWB/LWB	Door rubber	30m roll
DA2024	SWB/LWB	Safari rear door - skin	
RTC6247	SWB/LWB	Safari rear door - unglazed with spare wheel	
RTC6248	SWB/LWB	Safari rear door - glazed without spare wheel	
RTC6248NG	SWB/LWB	Safari rear door - unglazed without spare wheel	
DA2026O	SWB/LWB	Door pillar repair - bulkhead/bracket	RHS
DA2026N	SWB/LWB	Door pillar repair - bulkhead/bracket	LHS
DA4054	SWB/LWB	Bracket for DA2026N/DA2026O - pair	RHS/LHS
DA2023O	SWB/LWB	Door skin	RHS
DA2023N	SWB/LWB	Door skin	LHS
MTC5382	SWB/LWB	Door top - unglazed	RHS
MTC5383	SWB/LWB	Door top - unglazed	LHS
MTC5382G	SWB/LWB	Door top - glazed	RHS
MTC5383G	SWB/LWB	Door top - glazed	LHS
DA4086	SWB/LWB	Rear & side door bottom repair section	
DA2156	SWB/LWB	Glazing kit - door top	Series 3
DA1070	SWB/LWB	Front door hinge kit - torx head bolts kit	
DA1131	SWB/LWB	Front door hinge kit - aluminium hinges	

#### Bodywork - Footwells

DA2001O	SWB/LWB	Footwell	RHD	RHS
DA2001N	SWB/LWB	Footwell	RHD	LHS
DA4018N	SWB/LWB	Footwell	LHD	RHS
DA4018O	SWB/LWB	Footwell	LHD	LHS

#### Bodywork - Windows

DA2002	SWB/LWB	Window channel		2m length
DA4032	SWB/LWB	Window kit - standard	Pair	Clear
DA4032GREY	SWB/LWB	Window kit - standard	Pair	Grey tinted
DA4033	SWB/LWB	Window kit - deluxe	Pair	Clear
DA4033GREEN	SWB/LWB	Window kit - deluxe	Pair	Green tinted
DA4033GREY	SWB/LWB	Window kit - deluxe <b>NEW</b>	Pair	Grey tinted
DA4033BRONZE	SWB/LWB	Window kit - deluxe	Pair	Bronze tinted
DA4033CATCH	SWB/LWB	Replacement catch for deluxe window kit		Single
DA4032-3SEAL	SWB/LWB	Replacement window seal for above part numbers. One seal per kit.		

#### Bodywork - Wings

##### Aluminium front outer wing panels

330426	Series 2 & 2A - right & left hand drive	RHS with no hole
330427	Series 2 & 2A - right & left hand drive	LHS with no hole

##### ABS plastic front outer wing panels

DA2463	Series 2 & 2A - right & left hand drive	RHS with no hole
	Series 3 - right hand drive	
DA2462	Series 2 & 2A - right & left hand drive	LHS with no hole
	Series 3 - left hand drive	
DA2464	Series 3 - right hand drive	LHS with hole
DA2465	Series 3 - left hand drive	RHS with hole



### Chassis

#### Chassis - Crossmembers

218453	SWB	Gearbox crossmember - weld on
559822	Military	Rear crossmember
DA4017	SWB	Rear crossmember / 1/4 chassis - with extensions and hangers
NRC236	SWB/LWB	Rear crossmember - no extensions
NRC236E	SWB/LWB	Rear crossmember - with extensions, no hangers

#### Chassis - General

DA2008O	SWB/LWB	Chassis leg - front	RHS
DA2008N	SWB/LWB	Chassis leg - front	LHS
DA2009	SWB/LWB	Extension piece (2 x 'U' shape sections) - for rear crossmember	
DA2014	SWB/LWB	Bulkhead outrigger	
DA2015O	SWB	Rear tank outrigger	RHS
DA2015N	SWB	Rear tank outrigger	LHS
DA2017O	LWB	Rear tank outrigger	RHS
DA2017N	LWB	Rear tank outrigger	LHS
DA2019O	SWB	Front tank outrigger	RHS
DA2019N	SWB	Front tank outrigger	LHS
DA2099	SWB	1/2 Chassis	

#### Chassis - Suspension Mounts

DA2013	SWB	Spring hanger
DA2016	LWB	Spring hanger - front
DA2116	LWB	Spring hanger - rear

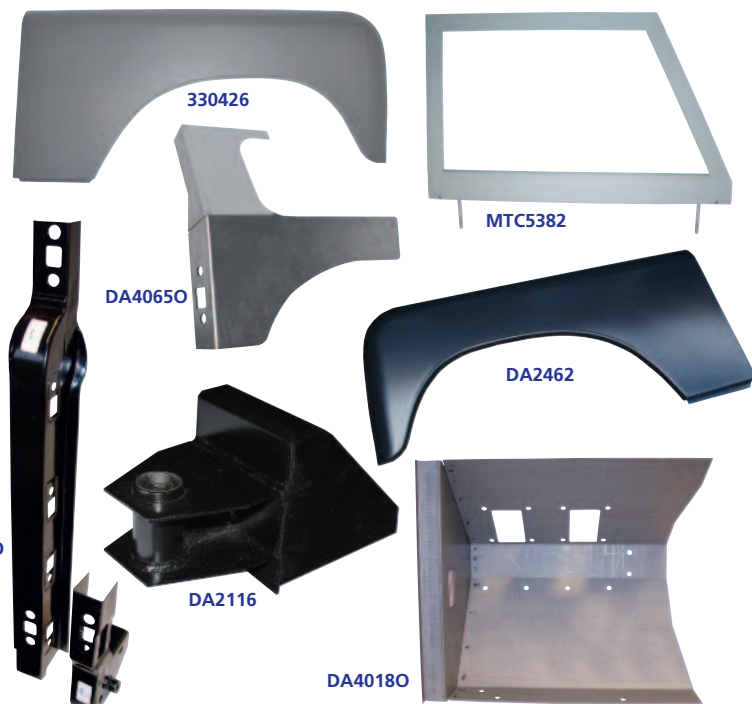

For many more body & chassis product pictures go to [www.britpart.com/chassis](http://www.britpart.com/chassis)

Other - Chassis & Body Components



**Freelander 1**  
**ALR8710** Bulkhead front assembly



**Freelander 2**  
**DA5671** Bumper  
With headlamp power wash, front parking aid & front fog lamps.



**Discovery 3**  
**DA5672** Bumper  
With headlamp power wash & front parking aid

Door Hinge Kits



DA1131 - front



DA1131 - rear

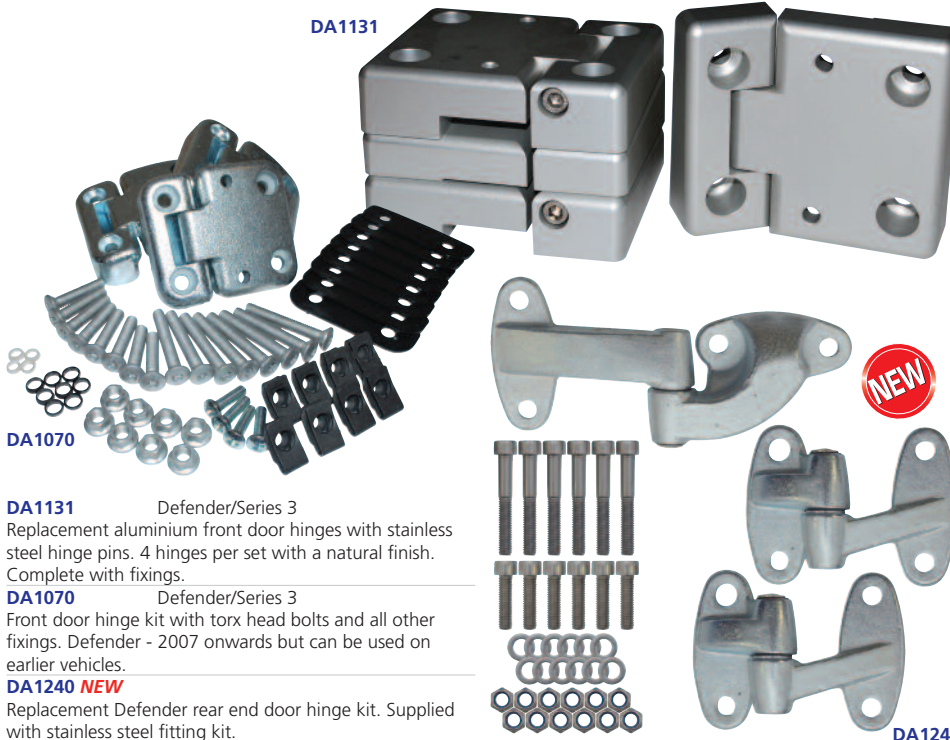

DA1131

DA1070

**DA1131** Defender/Series 3  
Replacement aluminium front door hinges with stainless steel hinge pins. 4 hinges per set with a natural finish. Complete with fixings.

**DA1070** Defender/Series 3  
Front door hinge kit with torx head bolts and all other fixings. Defender - 2007 onwards but can be used on earlier vehicles.

**DA1240 NEW**  
Replacement Defender rear end door hinge kit. Supplied with stainless steel fitting kit.

NEW

DA1240

**Standard - Defender & Series**  
Standard kits have a metal catch. Pair.  
**DA4032** Clear  
**DA4032GREY** Grey tinted



DA4032GREY



DA4033GREEN

DA4032-3SEAL

DA4033CATCH

Replacement window seal for both standard and deluxe windows. Each kit does one window.

Replacement catch for deluxe window kit Single

Fuel Latch Repair Kit



**DA1114**  
Discovery 3/Discovery 4  
Range Rover Sport - 2005 - 2013  
This handy little OEM kit is used to repair the temperamental fuel latch.

Defender stainless steel fixings - See vehicle enhancement section for full details.

Window Kits

**Deluxe - Defender & Series**  
Deluxe kits have rubber mounting strips to cover rivets and a plastic catch. Pair.  
**DA4033** Clear  
**DA4033GREEN** Green tinted  
**DA4033GREY NEW** Grey tinted  
**DA4033BRONZE** Bronze tinted



DA4033GREY



DA4032-3SEAL

DA4033CATCH



DA4033





*"Servicing a Land Rover just got a whole lot easier with Britpart!"*

**Britpart Service Kits**  
Quality service parts manufactured to O.E. specification and competitively priced.

[www.britpart.com/servicekits](http://www.britpart.com/servicekits)

Ever started servicing a Land Rover and then suddenly realised you haven't ordered a filter or forgot the sump plug washers?

Well now thanks to Britpart with one simple part number you can order your Land Rover service kit safe in the knowledge that all the parts you need will be there for you to complete the job.

No more frustrating half finished services!

Service kits -  
**Blue part number**  
Britpart filters & spark/heater plugs  
**Red part number ending in 'P'**  
OEM filters & spark/heater plugs  
**Green part number ending in 'LR'**  
Genuine filters & spark/heater plugs

**Land Rover Service Kits**  
Wide range of service kits using genuine filters & spark/heater plugs



**Alternative Brand Service Kits**  
Britpart stock a wide range of alternative brand service kits with OEM brands including Coopers, Mann, Mahle, Champion & NGK.

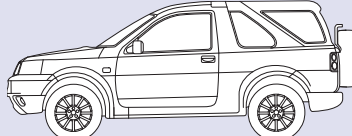
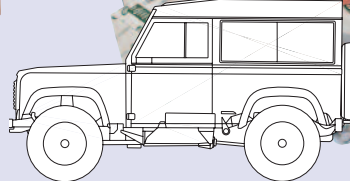

Pictures for illustrative purposes only

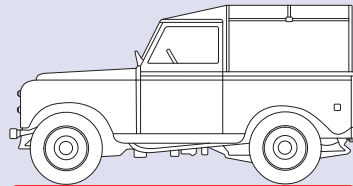

**Defender**

- DA6000**  
Defender - 2<sup>1/2</sup> petrol 7:1 compression ratio
- 1 x ERR3340 Oil filter
  - 1 x NRC9238 Air filter
  - 1 x JS660L Fuel filter
  - 1 x 243959 Sump plug washer
  - 1 x FRC4808 Sump plug washer
  - 4 x RTC3571 Spark plugs

**Freelander**

- FREELANDER 1**
- DA6011**  
Freelander 1 - 1.8 petrol - up to YA999999
- 1 x CDU1268 Oil filter
  - 1 x ESR4103 Air filter
  - 1 x JKR100200 Pollen filter
  - 1 x ALU1403L Sump plug washer
  - 4 x NLP100290L Spark plugs
- DA6012**  
Freelander 1 - 1.8 petrol - 1A000001 onwards
- 1 x CDU1268 Oil filter
  - 1 x ESR4103 Air filter
  - 1 x JKR100280 Pollen filter
  - 1 x ALU1403L Sump plug washer
- DA6013** **DA6013P**  
Freelander 1 - 2.0 diesel TCIE
- 1 x ERR5542 Oil filter
  - 1 x ESR4103 Air filter
  - 1 x WJN10046 Fuel filter
  - 1 x JKR100200 Pollen filter
  - 1 x ALU1403L Sump plug washer
- DA6014** **DA6014P** **DA6014LR**  
Freelander 1 - Td4 - up to 2A209830
- 1 x LRF100150L Oil filter
  - 1 x PHE100500L Air filter
  - 1 x JKR100280 Pollen filter
  - 1 x ALU1403L Sump plug washer
  - 1 x MUN000010 Fuel filter
- DA6015** **DA6015P** **DA6015LR**  
Freelander 1 - Td4 - 2A209831 onwards
- 1 x LRF100150L Oil filter
  - 1 x PHE100500L Air filter
  - 1 x JKR100280 Pollen filter
  - 1 x ALU1403L Sump plug washer
  - 1 x WJN000080 Fuel filter

- DA6001** **DA6001P**  
Defender - Turbo D
- 1 x ERR3340 Oil filter
  - 1 x NRC9238 Air filter
  - 1 x RTC6079 Fuel filter
  - 1 x FRC4808 Sump plug washer
- DA6002** **DA6002P**  
Defender - 200Tdi
- 1 x ERR3340 Oil filter
  - 1 x NTC6660 Air filter
  - 1 x AEU2147L Fuel filter
  - 1 x 213961L Sump plug washer
  - 1 x ETC7398 Sump plug washer
- DA6003** **DA6003P**  
Defender - 300Tdi
- 1 x ERR3340 Oil filter
  - 1 x ESR2623 Air filter
  - 1 x AEU2147L Fuel filter
  - 1 x UAM2857L Sump plug washer
  - 1 x ALU1403L Sump plug washer
- DA6004** **DA6004P** **DA6004LR**  
Defender - Td5
- 1 x LPX100590 Oil filter
  - 1 x ESR4238 Air filter
  - 1 x ERR6299 Rotor filter
  - 1 x ESR4686 Fuel filter
  - 1 x CDU1001L Sump plug washer
- DA6040** **DA6040P** **DA6040LR**  
Defender - 2007 onwards
- 2.4 & 2.2 - up to DA444246**
- 1 x LR004459 Oil filter
  - 1 x WJ1500040 Fuel filter
  - 1 x PHE500060 Air filter
  - 1 x 1013938 Oil drain plug inc. rubber seal
- DA6109** **DA6109P** **DA6109LR**  
Defender - 2007 onwards
- 2.2 - DA444247 onwards**
- 1 x LR058104 Oil filter
  - 1 x WJ1500040 Fuel filter
  - 1 x PHE500060 Air filter
  - 1 x 1013938 Oil drain plug inc. rubber seal

- Series**
- DA6032**  
Series 2<sup>1/4</sup> petrol - 1964 onwards  
- Lucas ignition (fixed points)
- 1 x RTC3184 Oil filter
  - 1 x 606168 Fuel filter (in-line)
  - 4 x RTC3570 Spark plugs
  - 1 x RTC3270 Points (fixed)
  - 1 x RTC3472 Condenser
  - 1 x 243959 Sump plug washer
- DA6033**  
Series 2<sup>1/4</sup> petrol - 1964 onwards  
- Lucas ignition (sliding points)
- 1 x RTC3184 Oil filter
  - 1 x 606168 Fuel filter (in-line)
  - 4 x RTC3570 Spark plugs
  - 1 x RTC364 Points (sliding)
  - 1 x RTC3288 Points (sliding)
  - 1 x RTC6621 Condenser
  - 1 x 243959 Sump plug washer
- DA6034**  
Series 2<sup>1/4</sup> petrol - 1964 onwards  
- (Ducellier ignition)
- 1 x RTC3184 Oil filter
  - 1 x 606168 Fuel filter (in-line)
  - 4 x RTC3570 Spark plugs
  - 1 x RTC6625 Points
  - 1 x RTC6620 Condenser
  - 1 x 243959 Sump plug washer

"all the parts you need will be there for you to complete the job"



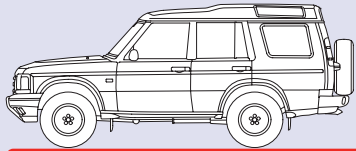

"Servicing a Land Rover just got a whole lot easier with Britpart!"

## Discovery

### DISCOVERY 1

**DA6005 DA6005P**  
Discovery 1 - 200Tdi - up to JA018272

1 x ERR3340	Oil filter
1 x NTC1435	Air filter
1 x AEU2147L	Fuel filter
1 x 213961L	Sump plug washer

**DA6006 DA6006P**  
Discovery 1 - 200Tdi - JA018273 onwards

1 x ERR3340	Oil filter
1 x ESR1049	Air filter
1 x AEU2147L	Fuel filter
1 x 213961L	Sump plug washer

**DA6007 DA6007P**  
Discovery 1 - 300Tdi

1 x ERR3340	Oil filter
1 x ESR1445	Air filter
1 x AEU2147L	Fuel filter
1 x UAM2857L	Sump plug washer
1 x ALU1403L	Sump plug washer

**DA6008**  
Discovery 1 - 3.5 Efi

1 x ERR3340	Oil filter
1 x RTC4683	Air filter
8 x ERR3799	Spark plugs
1 x ESR4065	Fuel filter (in-line)
1 x 213961L	Sump plug washer

**DA6009**  
Discovery 1 - 3.9 Efi

1 x ERR3340	Oil filter
1 x ESR1445	Air filter
1 x ESR4065	Fuel filter
1 x ETC7398	Sump plug washer

### DISCOVERY 2

**DA6004 DA6004P DA6004LR**  
Discovery 2 - Td5

1 x LPX100590	Oil filter
1 x ESR4238	Air filter
1 x ERR6299	Rotor filter
1 x ESR4686	Fuel filter
1 x CDU1001L	Sump plug washer

**DA6010 DA6010P DA6010LR**  
Discovery 2 - V8 4.0

1 x ERR3340	Oil filter
1 x ESR4238	Air filter
8 x NLP100320	Spark plugs
1 x ALU1403L	Sump plug washer

### DISCOVERY 3

**DA6035 DA6035P DA6035LR**  
Discovery 3 - 2.7 diesel - up to 6A999999

1 x 1311289	Oil filter
1 x PHE000112	Air filter
1 x LRO10075	Fuel filter
1 x JKR500020	Cabin filter
1 x 1013938	Oil drain plug inc. rubber seal

**DA6041 DA6041P DA6041LR**  
Discovery 3 - 2.7 diesel - 7A onwards

1 x 1311289	Oil filter
1 x PHE000112	Air filter
1 x JKR500020	Cabin filter
1 x LRO09705	Fuel filter
1 x 1013938	Oil drain plug inc. rubber seal

**DA6037 DA6037P DA6037LR**  
Discovery 3 - 4.4 petrol

1 x LRO07160	Oil filter
1 x PHE000112	Air filter
8 x LRO05253	Spark plugs
1 x JKR500020	Cabin filter
1 x 1013938	Oil drain plug inc. rubber seal

**DA6087 DA6087P DA6087LR**  
Discovery 3 - 4.0 V6 petrol

1 x 4454116	Oil filter (vehicles with engine oil cooler)
1 x PHE000112	Air filter
1 x JKR500020	Cabin filter
6 x LRO00604	Spark plugs
1 x 1013938	Oil drain plug inc rubber seal

### DISCOVERY 4

**DA6041 DA6041P DA6041LR**  
Discovery 4 - 2.7 diesel

1 x 1311289	Oil filter
1 x PHE000112	Air filter
1 x JKR500020	Cabin filter
1 x LRO09705	Fuel filter
1 x 1013938	Oil drain plug inc. rubber seal

**DA6086 DA6086P DA6086LR**  
Discovery 4 - 3.0 V6 diesel

1 x LRO13148	Oil filter
1 x PHE000112	Air filter
1 x JKR500020	Cabin filter
1 x LRO09705	Fuel filter
1 x 1013938	Oil drain plug inc rubber seal

**DA6087 DA6087P DA6087LR**  
Discovery 4 - 4.0 V6 petrol

1 x 4454116	Oil filter (vehicles with engine oil cooler)
1 x PHE000112	Air filter
1 x JKR500020	Cabin filter
6 x LRO00604	Spark plugs
1 x 1013938	Oil drain plug inc rubber seal

**DA6088 DA6088P DA6088LR**  
Discovery 4 - 5.0 V8 petrol

1 x LRO11279	Oil filter
2 x LRO11593	Air filters
1 x JKR500020	Cabin filter
8 x LRO32080	Spark plugs
1 x 4594914	Oil drain plug

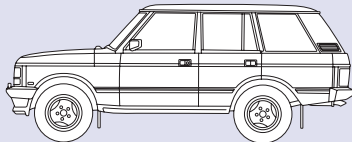

## Range Rover

### RANGE ROVER CLASSIC

**DA6016**  
Range Rover Classic - 3.5 - 1970 - 1975

1 x RTC3186	Oil filter
2 x 605191	Air filters
1 x JS660L	Fuel filter
8 x RTC3573	Spark plugs
1 x 213961L	Sump plug washer
2 x 603330	Flame traps
1 x RTC6623	Points (fixed)
1 x RTC3472	Condenser

**DA6017**  
Range Rover Classic - 3.5 - 1975 - 1982

1 x ERR3340	Oil filter
2 x 605191	Air filters
1 x JS660L	Fuel filter
8 x RTC3573	Spark plugs
1 x 213961L	Sump plug washer
2 x 603330	Flame traps
1 x RTC6623	Points (fixed)
1 x RTC3472	Condenser

**DA6018**  
Range Rover Classic - 3.5 - 1982 - 1983

1 x ERR3340	Oil filter
2 x 605191	Air filters
1 x JS660L	Fuel filter
8 x RTC3570	Spark plugs
1 x 213961L	Sump plug washer
2 x 603330	Flame traps
1 x RTC6626	Points (sliding)
1 x RTC3472	Condenser

**DA6019**  
Range Rover Classic - 3.5 - 1984 - 1986

1 x ERR3340	Oil filter
2 x 605191	Air filters
1 x JS660L	Fuel filter
8 x RTC3570	Spark plugs
1 x 213961L	Sump plug washer
2 x 603330	Flame traps

**DA6020**  
Range Rover Classic - 3.5 carb - 1986 - 1991

1 x ERR3340	Oil filter
2 x 605191	Air filters
1 x JS660L	Fuel filter
8 x RTC3812	Spark plugs
1 x 213961L	Sump plug washer
2 x 603330	Flame traps

**DA6021**  
Range Rover Classic - 3.5/3.9 Efi 1986 - 1991 up to GA464553

1 x ERR3340	Oil filter
1 x RTC4683	Air filter
1 x NTC5958	Fuel filter
1 x 213961L	Sump plug washer

**DA6022**  
Range Rover Classic - 3.9 Efi 1986 - 1994 from HA464554 up to LA647644

1 x ERR3340	Oil filter
1 x RTC4683	Air filter
1 x ESR4065	Fuel filter
1 x 213961L	Sump plug washer

**DA6023**  
Range Rover Classic - 3.9 Efi 1992 - 1994 - MA647645 onwards

1 x ERR3340	Oil filter
1 x ESR1445	Air filter
1 x ESR4065	Fuel filter
8 x ETC7244	Spark plugs
1 x 213961L	Sump plug washer

**DA6024**  
Range Rover Classic - 4.2 - 1992 - 1994

1 x ERR3340	Oil filter
1 x ESR1445	Air filter
1 x ESR4065	Fuel filter
8 x ERR3799	Spark plugs
1 x 213961L	Sump plug washer

**DA6006 DA6006P**  
Range Rover Classic - 200Tdi 1 x ERR3340 Oil filter  
1 x ESR1049 Air filter  
1 x AEU2147L Fuel filter  
1 x 213961L Sump plug washer

**DA6007 DA6007P**  
Range Rover Classic - 300Tdi 1 x ERR3340 Oil filter  
1 x ESR1445 Air filter  
1 x AEU2147L Fuel filter  
1 x UAM2857L Sump plug washer  
1 x ALU1403L Sump plug washer

### RANGE ROVER P38

**DA6025**  
Range Rover P38 - 4.0/4.6 up to TA346793 & from WA376580 up to WA385948

1 x ERR3340	Oil filter
1 x ESR341	Air filter
1 x ESR4065	Fuel filter
8 x ERR3799	Spark plugs
2 x BTR8037	Pollen filters
1 x UAM2857L	Sump plug washer
1 x ALU1403L	Sump plug washer

**DA6026**  
Range Rover P38 - 4.0/4.6 from VA346794 up to VA376579 & from WA385949 onwards

1 x ERR3340	Oil filter
1 x ESR4238	Air filter
1 x ESR4065	Fuel filter
8 x ERR3799	Spark plugs
2 x BTR8037	Pollen filters
1 x UAM2857L	Sump plug washer
1 x ALU1403L	Sump plug washer

**DA6027 DA6027P**  
Range Rover P38 - 2.5 DT to engine no. 33978348 up to (Dec 1995) type A oil filter

1 x STC2180	Oil filter type A
1 x ESR341	Air filter
1 x STC2827	Fuel filter
2 x BTR8037	Pollen filters
1 x VYX000040	Sump plug washer

**DA6028 DA6028P**  
Range Rover P38 - 2.5 DT from engine no. 33988348 from (Dec 1995) up to TA346793 type B oil filter

1 x STC3350	Oil filter type B
1 x ESR341	Air filter
1 x STC2827	Fuel filter
2 x BTR8037	Pollen filters
1 x VYX000040	Sump plug washer

**DA6029 DA6029P**  
Range Rover P38 - 2.5 DT from engine no. 33988348 from (Dec 1995) from TA346794 type B oil filter

1 x STC3350	Oil filter type B
1 x ESR4238	Air filter
1 x STC2827	Fuel filter
2 x BTR8037	Pollen filters
1 x VYX000040	Sump plug washer

### RANGE ROVER L322

**DA6030 DA6030P DA6030LR**  
Range Rover L322 - 3.0 diesel

1 x LP2000020	Oil filter
1 x PHE000040	Air filter
1 x WFL000070	Fuel filter
1 x JMO000010	Pollen filter
1 x VYX000040	Sump plug washer

**DA6031 DA6031P DA6031LR**  
Range Rover L322 - 4.4 V8 M62

1 x LPW500030	Oil filter
1 x PHE000050	Air filter
1 x JMO000010	Pollen filter
1 x VYX000040	Sump plug washer
8 x NLP000030	Spark plugs

**DA6065 DA6065P DA6065LR**  
Range Rover L322 - 4.4 V8 AJ petrol & 4.2 Supercharged

1 x LRO07160	Oil filter
1 x PHE500021	Air filter
1 x JMO000010	Cabin filter
8 x LRO05253	Spark plugs
1 x 1013938	Oil drain plug inc rubber seal

**DA6066 DA6066P DA6066LR**  
Range Rover L322 - 3.6 V8 diesel

1 x LRO02338	Oil filter
1 x PHE500021	Air filter
1 x JMO000010	Cabin filter
1 x WJ500030	Fuel filter
1 x 1013938	Oil drain plug inc rubber seal

**DA6067 DA6067P DA6067LR**  
Range Rover L322 - 4.4 V8 diesel

1 x LRO22896	Oil filter
2 x LRO11593	Air filters
1 x JMO000010	Cabin filter
1 x LRO29098	Fuel filter element
1 x 4594914	Oil drain plug

**DA6068P DA6068LR**  
Range Rover L322 - 5.0 V8 petrol

1 x LRO11279	Oil filter
2 x LRO11593	Air filters
1 x JMO000010	Cabin filter
8 x LRO32080	Spark plugs
1 x 4594914	Oil Drain plug

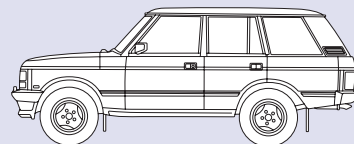

**Range Rover - continued**

**RANGE ROVER L405**

**DA6095 DA6095P DA6095LR**

- Range Rover - 3.0 V6 diesel**
- 1 x LR013148 Oil filter
  - 2 x LR011593 Air filter
  - 1 x LR041978 Fuel filter
  - 1 x LR036369 Cabin filter
  - 1 x 1013938 Oil drain plug inc. rubber seal

**DA6096P DA6096LR**

- Range Rover - 4.4 V8 diesel**
- 1 x LR022896 Oil filter
  - 2 x LR011593 Air filter
  - 1 x LR029098 Fuel filter
  - 1 x LR036369 Cabin filter
  - 1 x 4594914 Oil drain plug inc. rubber seal

**DA6097 DA6097P DA6097LR**

**Range Rover - 3.0 V6 petrol - up to EA128397**

- 1 x LR011279 Oil filter
- 2 x LR011593 Air filter
- 1 x LR036369 Cabin filter
- 6 x LR041664 Spark plugs
- 1 x 4594914 Oil drain plug inc. rubber seal

**DA6098 DA6098P DA6098LR**

**Range Rover - 3.0 V6 petrol - EA128398 onwards**

- 1 x LR011279 Oil filter
- 2 x LR011593 Air filter
- 1 x LR036369 Cabin filter
- 6 x LR050998 Spark plugs
- 1 x 4594914 Oil drain plug inc. rubber seal

**DA6099 DA6099P DA6099LR**

**Range Rover - 5.0 V8 petrol naturally aspirated & supercharged - 2014 MY**

- 1 x LR011279 Oil filter
- 2 x LR011593 Air filter
- 1 x LR036369 Cabin filter
- 8 x LR032080 Spark plugs
- 1 x 4594914 Oil drain plug inc. rubber seal

**RANGE ROVER SPORT**

**DA6035 DA6035P DA6035LR**

**Range Rover Sport - 2.7 diesel up to 6A999999**

- 1 x 1311289 Oil filter
- 1 x PHE000112 Air filter
- 1 x LR010075 Fuel filter
- 1 x JKR500020 Cabin filter
- 1 x 1013938 Oil drain plug inc. rubber seal

**DA6048 DA6048P DA6048LR**

**Range Rover Sport - 2.7 diesel from 7A000001**

- 1 x 1311289 Oil filter
- 1 x PHE000112 Air filter
- 1 x LR009705 Fuel filter
- 1 x JKR500020 Cabin filter
- 1 x 1013938 Oil drain plug inc. rubber seal

**DA6036 DA6036P DA6036LR**

**Range Rover Sport - 3.6 diesel**

- 1 x LR002338 Oil filter
- 1 x PHE000112 Air filter
- 1 x LR009705 Fuel filter
- 1 x JKR500020 Cabin filter
- 1 x 1013938 Oil drain plug inc. rubber seal

**DA6037 DA6037P DA6037LR**

**Range Rover Sport - 4.2/4.4 petrol**

- 1 x LR007160 Oil filter
- 1 x PHE000112 Air filter
- 8 x LR005253 Spark plugs
- 1 x JKR500020 Cabin filter
- 1 x 1013938 Oil drain plug inc. rubber seal

**DA6086 DA6086P DA6086LR**

**Range Rover Sport - 3.0 V6 diesel**

- 1 x LR013148 Oil filter
- 1 x PHE000112 Air filter
- 1 x JKR500020 Cabin filter
- 1 x LR009705 Fuel filter
- 1 x 1013938 Oil drain plug inc. rubber seal

**DA6088 DA6088P DA6088LR**

**Range Rover Sport - 5.0 V8 petrol**

- 1 x LR011279 Oil filter
- 2 x LR011593 Air filters
- 1 x JKR500020 Cabin filter
- 8 x LR032080 Spark plugs
- 1 x 4594914 Oil drain plug

**DA6095 DA6095P DA6095LR**

**Range Rover Sport - 3.0 V6 diesel - EA000001 onwards**

- 1 x LR013148 Oil filter
- 2 x LR011593 Air filter
- 1 x LR041978 Fuel filter
- 1 x LR036369 Cabin filter
- 1 x 1013938 Oil drain plug inc. rubber seal

**DA6096P DA6096LR**

**Range Rover Sport - 4.4 V8 diesel - BA000001 onwards**

- 1 x LR022896 Oil filter
- 2 x LR011593 Air filter
- 1 x LR029098 Fuel filter
- 1 x LR036369 Cabin filter
- 1 x 4594914 Oil drain plug inc. rubber seal

**DA6097 DA6097P DA6097LR**

**Range Rover Sport - 3.0 V6 petrol - up to EA301262**

- 1 x LR011279 Oil filter
- 2 x LR011593 Air filter
- 1 x LR036369 Cabin filter
- 6 x LR041664 Spark plugs
- 1 x 4594914 Oil drain plug inc. rubber seal

**DA6098 DA6098P DA6098LR**

**Range Rover Sport - 3.0 V6 petrol - EA301263 onwards**

- 1 x LR011279 Oil filter
- 2 x LR011593 Air filter
- 1 x LR036369 Cabin filter
- 6 x LR050998 Spark plugs
- 1 x 4594914 Oil drain plug inc. rubber seal

**DA6099 DA6099P DA6099LR**

**Range Rover Sport - 5.0 V8 petrol naturally aspirated & supercharged - 2014 MY**

- 1 x LR011279 Oil filter
- 2 x LR011593 Air filter
- 1 x LR036369 Cabin filter
- 8 x LR032080 Spark plugs
- 1 x 4594914 Oil drain plug inc. rubber seal

**RANGE ROVER EVOQUE**

**DA6089 DA6089P DA6089LR**

**Range Rover Evoque - 2.0 petrol without pollution sensor**

- 1 x LR025306 Oil filter
- 1 x LR029078 Air filter
- 1 x LR019192 Cabin filter
- 4 x LR025605 Spark plugs
- 1 x LR025048 Oil drain plug

**DA6090 DA6090P DA6090LR**

**Range Rover Evoque - 2.0 petrol with pollution sensor**

- 1 x LR025306 Oil filter
- 1 x LR029078 Air filter
- 1 x LR019589 Cabin filter
- 4 x LR025605 Spark plugs
- 1 x LR025048 Oil drain plug

**DA6091 DA6091P DA6091LR**

**Range Rover Evoque - 2.2 diesel without pollution sensor**

- 1 x LR001247 Oil filter
- 1 x LR029078 Air filter
- 1 x LR019192 Cabin filter
- 1 x LR001313 Fuel filter
- 1 x LR004304 Oil drain plug
- 1 x LR006295 Oil drain plug seal

**DA6092 DA6092P DA6092LR**

**Range Rover Evoque - 2.2 diesel with pollution sensor**

- 1 x LR001247 Oil filter
- 1 x LR029078 Air filter
- 1 x LR019589 Cabin filter
- 1 x LR001313 Fuel filter
- 1 x LR004304 Oil drain plug
- 1 x LR006295 Oil drain plug seal

“all the parts you need will be there for you to complete the job”



**Automatic Transmission Fluid Change Kits**

*Degradation in oil can lead to judder, noise and a deterioration in gear change quality. It is recommended that oil and filters are changed after 50,000 to 75,000 miles on automatic gearboxes to ensure optimum performance.*

**DA6085** Britpart pan with Ravenol oil  
**DA6085G** ZF pan with ZF oil  
 Automatic transmission fluid change kit for vehicles with either a 6HP26 or 6HP28 ZF 6-speed automatic gearbox. Ideal for high mileage vehicles and towing vehicles. Kit comprises of pan assembly, transmission fluid, screws, sleeve & plugs.  
 Suitable for -  
 Discovery 3 & Discovery 4  
 Range Rover Sport - 2005 - 2013  
 Range Rover L322

**DA6106** Britpart pan with ZF oil  
 Automatic transmission fluid change kit for vehicles with ZF 8HP70 8-speed automatic gearbox. Ideal for high mileage vehicles and towing vehicles. Kit comprises of pan assembly, transmission fluid, screws & plug.  
 Suitable for -  
 Discovery 4  
 Range Rover L322 - 2010 - 2012  
 Range Rover Sport - 2010 - 2013 & 2014 onwards

Also see DA2142 & DA2142G in transmission section.





Photograph courtesy of Mike Ragsdale

**Clips, Clamps & Nipples**



**Exhaust Clamps**

DA4062	45mm	Qty 1
DA4186 <b>NEW</b>	54mm	Qty 1
DA4063	60mm	Qty 1
DA4064	65mm	Qty 1



**Jubilee Clips**

CN100208L	20mm	Qty 10
CN100508L	32 - 52mm	Qty 5
CN100909	70 - 90mm	Qty 1

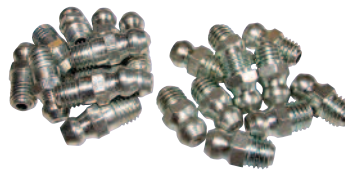

**Grease Nipples**

234532	Short thread	Qty 10
TYL100030	Long thread	Qty 10

**Brake Cleaner**



**STC8972**

500ml aerosol TRW brake cleaner

Cleans & degreases brake and clutch parts. Evaporates quickly. Simplifies dismantling and assembly. Removes dust, oil, grease & brake fluid. Sprays from any angle.

**Bearing Grease**



**DA2391**

Multi-pack of bearing grease 10 x 20ml sachets



Photograph courtesy of Marco Simola

**Hylomar Sealants & Compounds**

**RTC3347**

**Hylomar Universal Blue - gasket & jointing compound - 100g**

Non setting universal jointing compound that is resistant to fuels, coolants and lubricants. Use on gaskets and machined metal surfaces. High temperature capability up to 250°C with unlimited assembly time. Easy disassembly for service maintenance and allows for differential thermal expansion of components. Excellent vibration resistance.



**STC4404**

**Hylomar 607 Silicone Sealant - 300ml**

Engineering grade with excellent gap filling properties. Forms any size or shape of gasket instantly and remains flexible and will not shrink. Bonds to metal, glass, ceramics, plastics, fibres and wood. Resists most solvents. Good fluid resistance - not petrol or diesel. Electrical insulator with maximum constant operating temperature 250°C. Neutral curing. Tolerant of some oil and grease, ensure surfaces are clean.



**DA6441**

**Hylosil 100 Series Instant Gasket - 85g**

Engineering grade amine curing RTC silicone sealant with a proven performance in aftermarket applications. Non corrosive. Forms any size or shape of gasket instantly. Remains flexible, will not shrink. Bonds to metal, glass, ceramics, plastics, fibres and wood. Resists most solvents. Electrical insulator. Ensure surfaces are clean and dry before use.



**RTC3254**

**Hylomar 101 Silicone Sealant - gasketing, sealing & bonding compound - 85g**

Engineering grade which forms any size or shape of gasket instantly and remains flexible and will not shrink. Bonds to metal, glass, ceramics, plastics, fibres and wood. Resists most solvents. Electrical insulator. Maximum constant operating temperature 250°C with neutral curing. Ensure surfaces are free from oil and grease.



**STC4600**

**Hylomar 3400 Anaerobic Gasket Compound - 300ml**

Excellent resistance to automotive fluids including fuels with an operating temperature -40°C to 150°C. Machined metal to metal surface only, not suitable for pressed steel. No gap filling. Latest generation anaerobic gasket compound. Single part product. Suitable for K-series engines. Ensure surfaces are free of oil and grease.

**Land Rover Genuine Consumables**

**Anti-freeze**

PDA500300	Anti-freeze	1 litre
PDA500310	Anti-freeze	5 litres

**Cleaners**

STC50543	General purpose/brake cleaner	200ml
STC50544	General purpose/brake cleaner	400ml
STC50549	Paint and resin hand cleaner	400ml
LR023889	Leather & vinyl cleaner - Contents - 1 x 150ml leather protection cream; 1 x 150ml leather soft cleaner & 1 x sponge and cloth	

**Fluids & Oils**

SIJ500030	Brake fluid	500ml
SIJ500040	Brake fluid - Dot 4	1 litre
STC50531LR	Automatic transmission fluid 402	1 litre
STC4861	Transmission fluid - transfer box	500ml
STC9157	Manual transmission fluid 94	5 litres
STC9158	Manual transmission fluid 94	1 litre
STC50519LR	Power assisted steering fluid/ACE	1 litre
VYK000010	Gear oil - MTF94	1 litre

**Miscellaneous**

STC4676	De-icer	500ml
STC4672	Screen wash	250ml
STC4687	Screen wash	500ml
STC9155	Specialised lubricant	250ml
STC50550	Loctite 5900 gasket adhesive	50ml
STC50551	Flexible adhesive sealant	300ml
CE5500020	Glass repair kit	

**Paints \*Contains paint stick and clear lacquer**

RTC6870VT	Touch up kit*	Alpine white
STC2864VT	Touch up kit*	Oxford blue
STC2828VT	Touch up kit*	Rioja red
STC1774VT	Touch up kit*	Epsom green
STC4235VT	Touch up kit*	Blenheim silver
STC4596VT	Touch up kit*	Oslo blue
STC2862A	Aerosol - 150ml	Monza red
RTC6401VA	Aerosol - 150ml	Windjammer blue



## Castrol Classic Oils

A conventional multi-grade engine oil of good all round performance for pre-1980 modern classic cars.

**DA6260** Classic XL 20W-50 - 1 gallon tin

**DA6261** Classic XL 20W-50 - 1 litre tin

Mineral based, multi-grade, crankcase lubricant. Designed to facilitate running-in of new and reconditioned diesel and petrol engines.

**DA6262** Running In Oil No. 2 - 1 gallon tin

Castrol R40 provides the ultimate in lubrication.

**DA6263** R40 - 1 litre bottle

Originally specified grade for Series steering boxes and relays.

**DA6264** EP140 Extreme Pressure API GL4 - 1 litre tin

Extreme pressure multi-purpose gear oil for hypoid and non-hypoid applications.

**DA6265** EP90 Extreme Pressure API GL4 - 1 litre tin

### **Castrol Classic Oils, total care and protection for your classic vehicle.**

For much more information on each product and images visit [www.britpart.com/castrol](http://www.britpart.com/castrol)

Lead replacement fuel additive for use with lead-free fuel. Protects engine against valve seat recession under all driving conditions.

**DA6266** Valvemaster Lead Replacement Additive - 250ml bottle

Castrol Valvemaster Plus provides an octane boost to unleaded fuel, reducing pinking, knocking or the need to retune.

**DA6267** Valvemaster Plus Octane Boost - 250ml bottle

Transmission fluid for automatic gearboxes, incorporating additives to provide wear, oxidation and corrosion resistance.

**DA6268** TQF - 1 litre tin

A special, rubber compatible grease for use on hydraulic brake and clutch components where hardening or swelling of rubber must be avoided. Useful in assembly of rubber components for brake, clutch and suspension units.

**DA6269** Red Rubber Grease - 500g pot



### **Castrol Classic Oils Merchandise**

Drink your tea in a nostalgic way with this large tin mug.

**DA6270** Castrol Tin Mug

Use either to decorate your workshop or study or to accurately measure lubricant quantities shown in imperial measures in vehicle handbooks.

**DA6271** Castrol Pouring Jug - Half pint

**DA6272** Castrol Pouring Jug - Pint

**DA6273** Castrol Pouring Jug - Quart (two pints)

Smart green baseball cap with embroidered Castrol logo.

**DA6274** Baseball Cap - One-size fits all

Never forget to change your oil with this self-cling window sticker with Castrol logo on one side and Change Due boxes on the other.

**DA6275** Window Service Sticker - 3" diameter





<b>TYK500010</b>	VSG 75W-90 Transmission oil	1 litre
<b>TYK500010-20L</b>	VSG 75W-90 Transmission oil <b>NEW</b>	20 litres
A high performance full synthetic oil. Offers highest possible levels of protection & performance.		
<b>TYK500030</b>	MTF-2 75W-80 Gear oil	1 litre
Fully synthetic gear oil. Low friction characteristics, exceptional high load capabilities.		
<b>TYK500050</b>	ATF 6HP Fluid	1 litre
<b>TYK500050-20L</b>	ATF 6HP Fluid <b>NEW</b>	20 litres
Specially developed for use in ZF 6HP series high performance automatic transmissions.		
<b>STC50531</b>	ATF JF 506E Fluid	1 litre
Specially developed for use in JATCO 5-speed automatic transmissions.		
<b>LR002748</b>	ATF T-IV Fluid	1 litre
Primarily designed for use in latest Aisin Warner automatic transmissions.		
<b>STC4862 NEW</b>	ATF Dexron III H Fluid	1 litre
Universal ATF for all transmissions with and without controlled torque converter lockup clutch.		
<b>STC4863</b>	ATF 5/4 HP Fluid	1 litre
Special additives and inhibitors enable a smooth and reliable function of the auto transmission.		
<b>IYK500010</b>	Transfer Fluid TF-0870	1 litre
Fully synthetic gear lubricant for the latest generation of electronically controlled active transfer cases.		
<b>STC50519</b>	SSF Power steering fluid	1 litre
High performance central hydraulic fluid designed for use from -40°C to +100°C.		
<b>LR019727</b>	Multi-disc locking differentials semi-synthetic lubricant	1 litre
Developed specifically for use in lamella limited slip differentials.		
<b>LR003156 NEW</b>	EPX SAE 80W-90 GL 5	1 litre
Multi-range oil for synchronised and non-synchronised manual transmissions.		



<b>DA6286</b>	5 litres	<b>DA6288</b>	5 litres
<b>DA6287</b>	1 litre	<b>DA6289</b>	1 litre
Ravenol Full Synthetic FEL LOW SAPS Engine Oil 5W-30. Fully synthetic, fuel economy, low friction motor oil with CleanSynto® technology based on PAO Poly-alpha-Olefin synthetic base stocks and low SAPS technology for latest petrol and diesel passenger cars with and without turbo charging in passenger cars and light vans with normal or extended oil change intervals.		Ravenol SFE Super Fuel Economy 5W-20. Fully synthetic fuel-efficient low friction engine oil with CleanSynto® technology formulated with the highest quality Poly-alpha-Olefin base stocks and a special balanced additive package to provide both improved low emission performance and fuel economy under all driving conditions.	



Much more information on each of the oils at [www.britpart.com/ravenol](http://www.britpart.com/ravenol)

**Anti-Freeze/Coolant**

**DA6293 NEW** - 1.5 litres / **DA6294 NEW** - 5 litres

Ravenol OTC Organic Technology Coolant Concentrate is an eco-friendly 1.2- Ethanediol (monoethylene glycol) based silicate, borate, nitrite and phosphate-free coolant for cooling circuits in combustion engines which provides maintenance-free corrosion and frost protection. This product is formulated based on a proven inhibitor development by combining silicates with the organic additive technology OAT as an extended life coolant. The quality of an anti-freeze is no longer just determined by the anti-freeze effect (which automatically exists in an ethylene-glycol based product), but by the rust protection. That is why automakers subject anti-freeze to lengthy corrosion and cavitation tests. Ravenol OTC Organic Technology Coolant Concentrate protects the cooling system from rust, frost, and in summer, from overheating.

**Characteristics:**

- Excellent for aluminium alloy engines.
- Good reserve alkalinity.
- Premium corrosion additives for optimal rust protection for all metals and metal alloys used in cooling systems, including aluminium.
- Prevents sediments and foaming in the cooling system.
- Compatible with elastomers used in automotive radiators.
- Can be mixed with other coolant types.



**DA6294**



**TYK500050-20L**



**Transmission Oils**

Ravenol high performance transmission oils offer extra protection against wear and help to reduce vibration - especially at higher speeds.

**Engine Oils**

Ravenol high performance engine oils with the unique CleanSynto® technology were developed for the fast lane. Ultimate protection with maximum fuel efficiency - when you need it most!



**DA6291 NEW** 5 litres  
**DA6292 NEW** 1 litre

Ravenol FO 5W-30 is a modern high performance low friction fully synthetic Multigrade Engine Oil with Ravenol Patented CleanSynto® technology, which ensures a high viscosity index through the formulation with special base oils. Carefully selected and highly effective additives ensure excellent lubrication characteristics and provide optimal lubrication in the cold-running phase after start-up. The noticeable fuel economy of Ravenol FO 5W-30 contributes the reduction of pollutant emissions and environmental protection.

## Workshop Fluids

### DA1122

#### SLX Professional Fuel Saver

Castrol - 1 litre - A1 5W-20. Co-engineered in partnership with Land Rover for new engine applications. Over the full service interval it keeps the engine clean and provides outstanding fuel economy.



### DA6287G

#### Castrol EDGE Professional C1 5W-30

Castrol EDGE Professional C1 5W-30 is proven in tests to deliver outstanding oil strength. Micro-filtered and with its signature fluorescent colour it is your guarantee of professional quality. It is suitable for use in automotive petrol and diesel engines where the manufacturer recommends an ACEA C1 5W-30 lubricant.



### LR003156G

#### Differential EPX

Castrol - 1 litre - SAE 80W-90. Mineral based multi-grade extreme pressure gear oil for the lubrication of spiral bevel and hypoid differentials. The product is also suitable for the lubrication of manual transmissions where the manufacturer recommends the use of an oil to API GL5.



### LR019727LR

#### Differential SAF Carbon Mod Plus

Castrol - 1 litre - SAE 75W-90. Fully synthetic gear oil which can be used for axles with limited slip differentials.



### STC4862G

#### Texamatic 7045E

Automatic transmission fluid - 1 litre. Provides top-tier protection to all applications where Dexron III G type products are specified, offering excellent protection to automatic transmission and power steering systems.



### STC4863G

#### ATF LT 71141

Mobil - 1 litre. Automatic transmission fluid. Suitable for use in automatic transmissions and power steering systems.



#### Extended life coolant concentrate

Havoline with 5 year/250,000Km protection.  
**STC50529** - 1 litre  
**STC50530** - 5 litres



### TYK500010G

#### Differential SAF-XO

Castrol - 1 litre - SAE 75W-90. Fully synthetic final drive lubricant recommended for most passenger car final drives.



### TYK500050G

#### High performance full synthetic oil for automatic transmissions

ZF Lifeguard Fluid - 1 litre. This transmission fluid has been exclusively developed and approved for ZF automatic transmissions only.







The Loctite® brand, is renowned for the excellence of its adhesives and sealants. Since the original development of a unique anaerobic technology more than fifty years ago, Loctite® products have become vital components in many of the machines and products that are at the core of everyday life.

**Body Repairs**

<b>DA6310</b>	<b>Freeze &amp; Release</b>	400ml aerosol
Shock freezing (-43°C) is a quick and convenient method for releasing seized and corroded parts.		
<b>DA6312</b>	<b>Chemical Metal</b>	Mini blister pack
The original rock-hard multi-purpose repair paste.		
<b>DA6313</b>	<b>Leak Fix</b>	Mini blister pack
Seals and repairs leaks in petrol tanks, radiators and sumps.		
<b>DA6316</b>	<b>Terodicht Elastic Window Sealant</b>	310ml cartridge
Ideal for re-sealing rubber mounted windscreens.		
<b>DA6317</b>	<b>Terolan Special Sealant</b>	1.4kg can & brush
Vehicle body sealant for application with special brush.		
<b>DA6319</b>	<b>Teroson Etch Primer</b>	500ml aerosol
Provides excellent adhesion to steel, galvanised steel and aluminium.		
<b>DA6326</b>	<b>Zinc Spray</b>	400ml aerosol
Sprayable anti-corrosion primer paint for vehicle body repairs. Electrically conductive (wet and dry). Allow to cure for 8-12 hours before over painting.		
<b>DA6327</b>	<b>Terotex HV 350</b>	1 litre bottle
A solvent containing anticorrosive agent based on waxes, polymers and anti-corrosive additives. Contains high percentage of rust-proofing additives. Good creeping qualities. Penetrates to a depth of >35mm. Mild odour.		
<b>DA6328</b>	<b>Terotex Record 2000</b>	1 litre bottle
Non-bituminous coating material for permanently flexible corrosion protection of under bodies. To complement factory-applied under body sealant coats. For coating replacement parts like bumpers or wheel arch.		



DA6312



DA6313



DA6317



DA6310



DA6316



DA6319



DA6326



DA6327



DA6328



DA6366



DA6363



DA6364



DA6365



DA6311

**Gasket Repairs** (see website for full application details & technical specifications)

<b>DA6311</b>	<b>Quick Gasket</b>	200ml aerosol
Permanently flexible flange sealant for non-rigid flanges and for plastic-to-plastic and metal-to-metal assemblies.		
<b>DA6363</b>	<b>Premium Silicone Black 5910</b>	80ml tube
For flanges with permanent oil contact. Can be used for metal, plastic and painted parts. Low odour, non corrosive.		
<b>DA6364</b>	<b>Premium Silicone Grey 5660</b>	100ml tube
For flanges with permanent water/glycol contact. Can be used for metal, plastic and painted parts. Low odour, non corrosive.		
<b>DA6365</b>	<b>Premium Silicone Copper 5920</b>	80ml tube
For flanges exposed to high temperatures and high performance engines. Can be used for metal, plastic and painted parts. Low odour, non corrosive.		
<b>DA6366</b>	<b>Silicone Blue 5926</b>	40ml tube
Multi purpose flexible silicone sealant. For flanges of any size or shape. Can be used for metal, plastic and painted parts.		



DA6300



DA6301



DA6303



DA6304



DA6306



DA6309



DA6314



DA6318

**Glues & Adhesives**

<b>DA6300</b>	<b>Super Glue</b>	3g tube
High performance instant adhesive with thousands of applications.		
<b>DA6301</b>	<b>Super Glue Brushable</b>	5g bottle
Brushable version for extra accuracy and greater coverage.		
<b>DA6303</b>	<b>Repair Express Power Putty</b>	Blister pack
Fills, sticks, seals and re-builds thousands of items without tools.		
<b>DA6304</b>	<b>Rear View Mirror Bonder</b>	1 shot tube
Unique bonding system for rear view mirrors, car telephone aerials and all window mounted material.		
<b>DA6306</b>	<b>Stud 'N' Bearing Fit</b>	24ml bottle
Locks and seals studs into position. Seals against leaks and vibration.		
<b>DA6309</b>	<b>Instant Adhesive 401</b>	20g tube
Surface insensitive formulation creates a permanent bond with virtually any material.		
<b>DA6314</b>	<b>Super Steel Epoxy-Weld</b>	2 x 25g tube
Sets like steel. Seals, repairs, bonds, fixes and replaces.		
<b>DA6318</b>	<b>Fast Set Epoxy 3430</b>	24ml syringe
Two part general purpose epoxy adhesive.		



DA6305



DA6307

**Thread Lockers**

<b>DA6305</b>	<b>Lock 'N' Seal</b>	24ml bottle
Fast acting thread lock and sealant. Replaces traditional locking methods.		
<b>DA6307</b>	<b>Lock 'N' Seal 243</b>	50ml bottle
Fast-acting thread lock and sealant. Prevents bolts, screws & nuts from vibrating loose.		

## Touch Up Paint Pens

- TUPP single stage paint pen is ergonomic, light and easy to use.
- It allows quick, one-step repairs of small scratches and nicks that may appear on any painted surface.
- It will meet the highest colour matching expectations.
- The patented valve mechanism and gravity action of the paint pen will give you an even flow of all components assuring the same particularities and brightness of the original finish.
- An edged polyester fibre tip allows accuracy and can be removed to be cleaned or replaced.
- The paint pen has a closed opaque container preventing accidental spills, hardening of the paint and colour change due to light exposure before the application.

**The Pen** - Paint is held in a barrel and automatically dispensed through a fine felt tip, providing the user unparalleled control over their painting instrument.

**The Paint** - High quality urethane paint is used which is the same as your vehicles manufacturer. The paint provides the user with a much closer colour match than other companies which primarily use lacquer paints.

**The Results** - The best you can get without refinishing the damaged areas.

More details and FAQs can be found at [www.britpart.com/paintpens](http://www.britpart.com/paintpens)

Exclusive to Britpart  
in the UK!!

The best you can get  
without repainting!



Part Number	Colour	Code(s)	Part Number	Colour	Code(s)	Part Number	Colour	Code(s)
DA6217	Adriatic Blue	731	DA6210	Chawton White	603	DA6227	Rimini Red	889
DA6237	Alaska White	909	DA6244	Cobar Blue	624 (JAV)	DA6206	Rioja Red	601
DA6202	Alpine White	456 (NUC)	DA6204	Epsom Green	961	DA6207	Rutland Red	607
DA6212	Alveston Red	696	DA6218	Giverny Green	734	DA6259	Santorini Black	820
DA6226	Arctic Frost	962	DA6232	Icelandic Blue Mica	621 (JEL)	DA6234	Silver Sparkle	MNH
DA6223	Atacama Sand	916	DA6242	Ipanema Sand	GAQ		<i>Ideal for touching up alloy wheels</i>	
DA6233	Atlantis Blue	632 (JYW)	DA6211	Java Black	697	DA6235	Stornoway Grey	907 (LEL)
DA6230	Belize Green	756	DA6239	Kent Green	647	DA6238	Tangiers Orange	761
DA6200	Beluga Black	416 (PUE)	DA8044 NEW	Keswick Green	799 (HFU)	DA6222	Tonga Green	904
DA6236	Biarritz Blue	965	DA6231	Kinver Sand	609 (EAB)	DA6224	Vesuvius Orange	811
DA6245	Blenheim Silver	642	DA6241	Lucerne Green	966	DA6215	Vienna Green	751
DA6214	Bonatti Grey	659	DA6219	Maya Gold	846	DA6208	White Gold	618
DA6243	Borrego Yellow	757 (FUQ)	DA6228	Narvik Black	921	DA6209	Woodcote Green	623 (HPE)
DA6203	British Racing Green	617	DA6240	Niagara Grey	574	DA6216	Zambezi Silver	737
DA6220	Buckingham Blue	588 (796)	DA6213	Oslo Grey	644	DA6225	Zermatt Silver	798
DA6221	Cairns Blue	849	DA6205	Oxford Blue	602			
DA6229	Caledonia Blue	507	DA6201	Portofino Red	390 (CUF)			

## Swivel Housing Grease

- Formulated for all Land Rover models with ball type swivel housings.
- Lubricates swivel pins and housing seals, protects spheres.
- A semi-fluid grease designed to withstand shock loading in oscillating joints.
- Reinforced with solid lubricants, highly resistant to water and salt corrosion.
- Better lubrication while driving, less leaks while standing.
- One shot gives 'filled for life' protection.



STC3435 370gm bottle  
STC3435S 370ml sachet

## Trade Tack Stab

DA6348

Super bond spray adhesive.

- High strength
  - Variable spray
  - Quick
  - Clean
  - High tack/long tack
  - Very fast set
  - 250ml aerosol
- Ideal for bonding and laminating of polyurethane foam, polystyrene foam, fibres, fabrics & felts etc to themselves.





Got a great looking Land Rover?  
Then why not enter the  
Britpart calendar competition?



**LRT-60-003**  
Air suspension calibration blocks for Range Rover P38. To be used in conjunction with Lynx diagnostics kit.

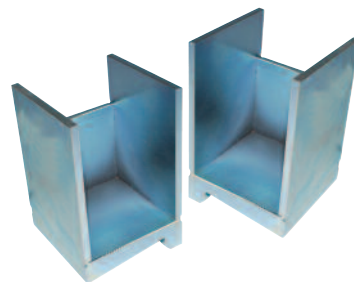

**LRT-64-003**  
Air suspension calibration blocks for Discovery 2. To be used in conjunction with Lynx diagnostics kit.

**Calibration Tools**



**DA1115**  
Timing kit  
Freelander 2 - 2.2 diesel  
Land Rover tool part numbers -  
303-1277 - Camshaft pulley timing pin  
303-1270/303-1059 - Flywheel locking  
timing pin  
303-1272 - Flywheel/ring gear locking tool  
adaptor

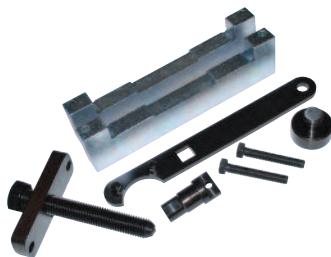

**DA1116**  
Timing kit  
Discovery 3 - 4.4 V8 - from 2005  
Range Rover Sport - 4.2 V8 Supercharged -  
up to 2010 & 4.4 V8 up to 2010  
Range Rover L322 - 4.2 V8 Supercharged -  
2005 - 2010 & 4.4 V8 - 2005 - 2010  
Jaguar 4.2 & 4.4 V8 engines with codes  
4PN & 428PS



**DA1120**  
Flywheel locking tools & camshaft timing  
pins  
Discovery 3 - 2.7 TdV6  
Range Rover Sport - 2.7 TdV6

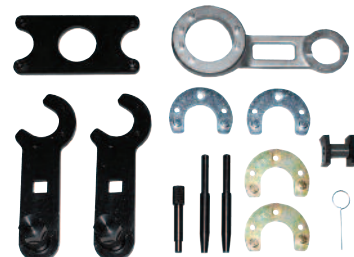

**DA1121**  
Timing tool kit for Land Rover KV6 engines  
The Land Rover KV6 quad cam engine has  
one front and two rear camshafts and  
these tools cover the replacement of all  
three belts

**Timing Tools**



**DA1162**  
Flywheel locking tool  
Defender - 2007 onwards  
Land Rover tool part number - 303-698



**DA3140**  
Timing kit - 2.5D/Tdi - 12 piece



**LRT-12-058**  
Timing pin (short) - Td5



**LRT-12-158**  
Timing pin (long) - Td5

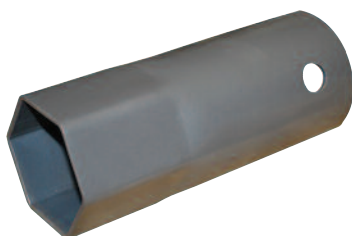

**606435**  
Hub nut spanner



**DA1111**  
Viscous fan coupling spanner  
Two sizes - 32 & 36mm



**DA1117**  
Td5 oil filter spanner



**DA1118**  
52mm deep socket - 1/2" drive  
Socket for adjusting hub nuts

**Workshop Tools**



**DA5026**

**DA5027**

**DA5026**  
**Professional LED Inspection Pocket Lamp**  
• Rechargeable & cordless for convenient use.  
• High powered LEDs provides a bright light output.  
**DA5027**  
**Essential LED Inspection Pocket Lamp**  
• Magnet for hands free use.  
• LED torch function for focussed light output.  
*Full details in the lighting section.*



**DA1235**  
Defender - Puma  
Locking tool to restrain the fuel injector sprocket during a fuel pump removal/installation.





**DA1176**  
36mm oil filter socket - 3/8" drive  
Designed to protect the corners of the filter from damage.  
Defender - Puma 2.2 & 2.4  
Freelander 1 - Td4  
Range Rover L322  
- 2002 - 2009 - M57 3.0 diesel  
Range Rover L322  
- 2002 - 2009 - M62 4.4 V8 petrol

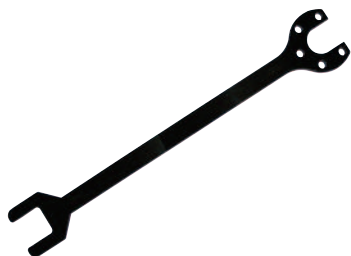

**LRT-12-093**  
Viscous coupling holding tool  
V8 petrol  
Td5 diesel  
2.5 Td diesel  
300Tdi diesel



**LRT-12-094**  
Viscous fan coupling wrench  
V8 petrol  
Td5 diesel  
V6 2.7 diesel  
2.5 Td diesel  
Td6 diesel  
300Tdi diesel



**DA1147**  
Clutch tool  
Defender - 2007 onwards  
Discovery 3 - TdV6 manual  
Replace two tools for one with this cost effective clutch tool. One end is the Land Rover 308-419 clutch alignment tool which is used to align the clutch disc and pressure plate on installation. The other end of the tool is Land Rover 303-1096 aligner/installer tool which is used to align the clutch drive plate and install the spigot bearing.

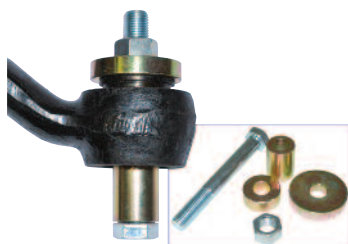

**DA1125**  
Ball joint remover tool kit.  
Fit & remove RBG000010 to a Defender drop arm without having to remove the arm from the vehicle.

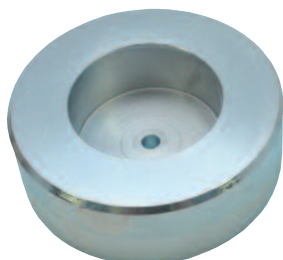

**DA1160**  
Engine front casing alignment tool  
Defender - 2007 onwards  
Land Rover tool part number - 303-682



**DA1161**  
Crankshaft front seal remover/installer tool  
Defender - 2007 onwards  
Land Rover tool part number - 303-679

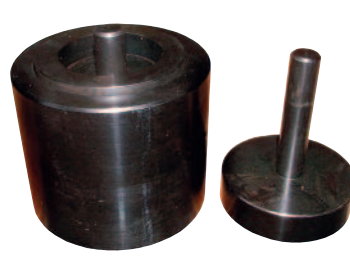

**LRT-60-004**  
Bush fitting tool  
For front radius arm bushes (part number ANR3332) for the Range Rover P38A - impossible to do without using this Land Rover special tool.

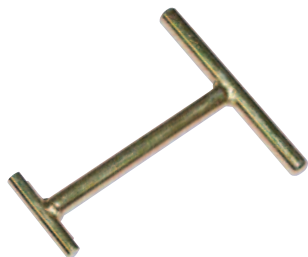

**DA1173**  
Oil filter remover for the paper element from the canister. Prevents damage to the filter housing.  
Discovery 3 - TdV6  
Discovery 4 - TdV6  
Range Rover Sport - TdV6  
Land Rover tool part number - 303-1128



**DA1155**  
Panel popper tool kit  
12 piece set designed to aid in the easy removal of door trim panels, trim fasteners and mouldings inside or outside the vehicle. Tools manufactured from a tough & durable engineering plastic to minimise panel damage. Includes an additional metal clip tool. Supplied in roll-up fabric case.



**DA1189**  
For removing and installing oil filters on diesel models of the Freelander 2 and Range Rover Evoque. 27mm combination spanner with flexi head. 400mm long. Manufactured from Chrome Vanadium. Fully polished with ratchet. Manufactured to Ansi standards.



**DA1209 NEW**  
For easy removal of the fuel tank metal locking ring (ESR3808) on the Defender - 2002 onwards, Discovery 1, Discovery 2, Freelander 1, Range Rover P38 and Range Rover L322



**DA1153**  
Brake caliper rebuild tool kit  
Anyone who has ever tried to rebuild a set of Land-Rover brake callipers will know that the most difficult part is fitting the dust seal after the pistons have been fitted. This extremely awkward task can now be made much easier with the seal fitting tools in this kit. The kit is supplied with a tool to fit 41mm and 44mm pistons and comes complete with a heavy-duty piston spreader to allow the seals to be pushed into place evenly.

**DA7460**  
Heavy-duty piston spreader only.





**DA5631**

Protect your Defender's wings with a pair of these sturdy easy to fit wing protectors.

**Prop shaft fastener tools**

Specialist socket for prop shaft fasteners on most Land Rovers. The 9/16" socket end is a perfect hexagon with rounded tip profiles to ensure the whole turning power is transferred onto the flanks of the nuts instead of on the corners. The socket's slim wall construction and wine glass profile, coupled to an integral slimline extension means it fits perfectly between the UJ yokes and over the prop shaft nuts without fouling. The 9/16" AF nuts are common to Series Land Rovers, Defenders (90 & 110 up to latest vehicles), Discoverys (up to and including Discovery 2) and Range Rovers (up to and including P38).



- Size: 9/16" 6 point (hexagon)
- Total length: 150mm
- Outside diameter: 20mm

**DA1065** Drive - 3/8" square drive  
**DA1119** Drive - 1/2" square drive

**Automatic Transmission Flush & Fill Machine**

**Need a fast, effective, efficient and easy way to change automatic transmission fluid?**

A standard automatic transmission drain and re-fill will only change about 40% of the contaminated fluid. Wynn's TranServe™ will change about 90% of the contaminated fluid in around 20 minutes. Wynn's TranServe™ is a automatic transmission flush and fill machine which flushes the oil system of automatic gearboxes and which changes the ATF in a simple and effective way.

**Properties**

- Easy connection to the transmission oil cooler lines.
- Cleans the oil system of automatic gearboxes with the product Wynn's Automatic Transmission Flush.
- Removes the old contaminated ATF and replaces it with fresh fluid. Up to 90% ATF is being changed (with the conventional method, up to 60% can remain behind).
- Always replaces the same fluid volume as it removes.
- No mixing of old and new fluid due to separate circuits and automatic switch to closed circuit after change.
- The built in flow rectifier will compensate for reverse connections.
- Operates on the vehicle's battery (12V).
- Booster pump makes change of low-pressure systems possible.
- Addition of the product Wynn's Automatic Transmission Treatment:
  - > Provides supplementary protection of the gear parts.
  - > Smoothens gear changes and improves kick-down response time.
  - > Extends life of the transmission fluid.
  - > Revitalises seals and O-rings, ensuring that leaks are prevented.

**Applications**

- Recommended when changing ATF of automatic gearboxes or when experiencing shifting problems.
- For all types of cars.
- Not to be used on high-pressure systems of buses, trucks, bulldozers, etc.

**Technical Data**

**DA6800**

Wynn's TranServe™  
 Power source - 12 V D.C.  
 Dimensions - 105 x 37 x 46 cm  
 Weight - 31 kg  
 Double worm gear pump  
 Booster pump for low pressure systems  
 Solenoid valve for automatic loop systems  
 Flow rectifier system  
 Adapter set for most cars



**Automatic Transmission Service Kits**



Use the Wynn's TranServe™ in conjunction with the range of automatic service kits from Britpart.

**DA6085**

For full kit details see the relevant pages in the service kit and transmission sections in the repair and service part of the catalogue.



**DA6800**

**DA6801**

Wynn's Automatic Transmission Flush  
 Size - 325ml x 24 bottles  
 An oil soluble treatment developed to clean automatic gearboxes and restore their optimal operation.

- Safely removes varnish deposits.
- Prepares transmission for new fluid.
- Cleans all internal transmission components.
- Smoothens and quiets gear changes.
- Prolongs component life.
- Restores optimal gear shifting.
- Only to be used with TranServe machine.



**DA6802**

Automatic Transmission Treatment  
 Size - 325ml x 24 cans  
 An oil soluble supplement developed to stop and prevent leaks and ease shifting.

- Stops and prevents leaks.
- Rejuvenates rubber seals and O-rings.
- Cleans and protects the system by means of detergents and dispersants.
- Eases shifting.
- Prevents ageing and oxidation of automatic transmission fluids.
- Prolongs component life.
- 1 can of 325 ml treats up to 6.5 litres automatic transmission fluid.



Photograph courtesy of Darren Whiley



Photograph courtesy of Bruno Dragon

## Section contents

## Vehicle enhancements

Defender	184 - 188
Discovery 3 & Discovery 4	180 - 181
Freelander 2	182
Range Rover Evoque	183
Range Rover L322	176 - 177
Range Rover L405	177
Range Rover Sport	178 - 179

“Give your Land Rover that extra special look and make it stand out from the crowd with some accessories from Britpart.”



vehicle enhancements

## Range Rover L322



### DA4663

#### Heated Leather Steering Wheel

Range Rover L322 Vogue - 2002 onwards.

Many of early L322 Range Rovers (Vogue shape) still look as good as new with only a few tell tale signs of their age and mileage but steering wheels on some models have gone all shiny and have lost the leather appearance and also steering wheels have started to sag. Range Rover improved the specification of the wheels on later models so they are much more durable. This wheel has the grained leather surface - not the smooth leather as used on the 2010 models. Please note that the spoke covers are not supplied with this steering wheel. You retain your original airbag/switch assembly - this is just the steering wheel frame as shown in the picture.

Enhance the look of your Range Rover L322...





**Range Rover L322 - continued**



VUB002510



VUB503660



JAK500300LQV / JAK500310LQV



LR005239

DA1071	Rear bumper cover		Stainless steel	Single
DA1072	Oval rear badge surround		Metal - chrome finish	Single
DA1073	Lower sill step covers - front & rear		Brushed finish	Pair
DA5108	Replacement grille - same as DHB500550LQV but with Brunel outer and chrome inner from VIN 6A			Single
DA5653	Door handle cover - up to 2010		Plastic - chrome finish	Set of 4
DA5654	Door handle surround		Plastic - chrome finish	Set of 4
DA5655	Fog light bezels - 2002 - 2009 (from 6A000001)		Plastic - chrome finish	Pair
JAK500300LQV	Air intake grille		Right hand side	Single
JAK500310LQV	Air intake grille		Left hand side	Single
VUB503650	Air intake grille		Plastic - chrome finish	Pair
VUB503880MMM	Wing mirror covers (5A onwards) - top (adhesive <b>STC50551</b> )		Plastic - chrome finish	Pair
LR003905	Wing mirror covers (5A onwards) - bottom (adhesive <b>STC50551</b> )		Plastic - chrome finish	Pair
LR005239	A Bar - moulded plastic includes spot lamp brackets		Black	Single
VUB001070	Lamp guard - up to 2006 - not compatible with wraparound protection bar	Front	Black	Pair
VUB502610	Lamp guard - 2006 onwards	Front	Black	Pair
VUB001080LR	Lamp guard	Rear	Black	Pair
VUB001230	Side protection tubes		Stainless steel	Pair
VUB002510	Side protection tubes <b>Note</b> - Tubes can be fitted with or without front mudflaps		Black steel	Pair
VUB503660	Side step including front mudflaps with EPDM (synthetic rubber) top and hard plastic trimming			Pair
VUB001300	Side step replacement insert moulding for VUB503660		Right hand side	Single
VUB001310	Side step replacement insert moulding for VUB503660		Left hand side	Single

**Range Rover L405**



Photograph courtesy of Mike Goodbun



DA4822



VPLGS0153

DA4822	Loadspace protector	Semi-rigid foam with anti-slip finish and 2" deep sides	Single
VPLGS0153	Umbrella holders	Excludes umbrella.	Pair

## Range Rover Sport



**DA6349 NEW**  
 Range Rover Sport - 2005 - 2010 2.7 TdV6  
 Range Rover Sport - 2005 - 2009 3.6 TdV8  
 This FBH controller is ideal for warming your engine on cold winter mornings while sat in the comfort of your house, removing the need to go outside and start your engine to defrost the car which is especially handy if you have a car that has faulty glow or heater plugs. You can lock and unlock the vehicle without the heater stopping. It has a 30 min run time to aim for a default water temp of 76C.



Enhance the look of your  
 Range Rover Sport...

For more details visit - [www.britpart.com/DA6349](http://www.britpart.com/DA6349)

[www.britpart.com](http://www.britpart.com)

**Range Rover Sport - continued**



<b>DA1072</b>	Oval rear badge surround	Metal - chrome finish	Single
<b>DA5660</b>	Fog lamp surrounds - 2005 - 2009	Plastic - chrome finish	Pair
<b>DA3350</b>	Air intake grille - left hand side	Plastic - chrome finish	Single
<b>DA3351</b>	Air intake grille - right hand side	Plastic - chrome finish	Single
<b>DA3352</b>	Air intake grille kit (DA3350 & DA3351)	Plastic - chrome finish	Pair
<b>DA5667</b>	Air intake grille kit - 2010 Autobiography style for 2002 - 2009 models	Chrome finish	Pair
<b>DA5668</b>	Air intake grille kit - 2010 Autobiography style for 2002 - 2009 models	Silver finish	Pair
<b>JAK500320WWH</b>	Air intake grille - right hand side	Tungsten/Titan finish	Single
<b>JAK500330WWH</b>	Air intake grille - left hand side	Tungsten/Titan finish	Single
<b>LR006304</b>	Air intake grilles	Metal - chrome finish	Pair
<b>DA2997</b>	Mesh grille insert - lower	Stainless steel with hand polished mirror finish	Single
<b>Note</b>	- 2005 - 2009 models only and not compatible with Adaptive Cruise Control (ACC) System.		
<b>DA5658</b>	Door handle cover	Plastic - chrome finish	Set of 4
<b>DA5659</b>	Door handle bowl	Plastic - chrome finish	Set of 4
<b>Headlight washer jet caps</b>			
<b>DA5661</b>	- Chrome;		Pairs
<b>DA7602</b>	- Zermatt Silver;		Single
<b>VPLAB0025LML</b>	- Primed		Single
<b>DA7610</b>	Indicator lamp with orange bulb	Clear	Single
<b>DA7611</b>	Indicator lamp with orange bulb	Smoked	Single
<b>EBN500040</b>	Side sill tread plate kit - from AA000001 up to AA218728	Stainless steel	Set of 8
<b>VPLS50042</b>	Side sill tread plate kit - AA218729 onwards	Stainless steel	Set of 8
<b>VUB503880MMM</b>	Wing mirror covers - top (adhesive <b>STC50551</b> )	Plastic - chrome finish	Pair
<b>LR003905</b>	Wing mirror covers - bottom (adhesive <b>STC50551</b> )	Plastic - chrome finish	Pair
<b>LR008713</b>	Pedal set	Stainless steel & rubber	Set of 3
<b>VTK500020</b>	Side steps with thermo plastic elastomer side step top and brushed aluminium side trim		Pair
<b>VUB501930</b>	Lamp guards - 2005 - 2009	Black	Front
<b>VUB501920</b>	Lamp guards - 2005 - 2009	Black	Rear
<b>VPLSP0010</b>	Lamp guards - 2010 - 2013	Black	Front
<b>VPLTP0064</b>	Lamp guards - 2010 - 2013	Black	Rear
<b>VUB501980</b>	A Bar - moulded plastic - 2005 - 2009 - includes spot lamp brackets	Grey	Single

**DA6290**

Range Rover Sport - 2005 - 2011

Tailgate conversion trim kit with chrome strip

The rear tailgate on the Range Rover Sport changed in 2012 from a two piece tailgate (with opening top window section) to a one piece tailgate and above the registration plate a new silver strip was added that went the width of the tailgate. If you have a 2005 - 2011 model and want to make it look like the 2012 model from the rear you can fit this clever conversion kit. The kit consists of 3 panels - 1. Underside base - section made from ABS plastic in grey primer finish - you will need to paint this part black. 2.

Top section - supplied in primed ABS plastic ready for painting body colour 3. Strip section - chrome plated plastic. This is a bolt on replacement kit that replaces the existing panels on the upper tailgate. The kit can be fitted with the tailgate on the car and you only need a Torx T20 driver socket and a 8mm socket.

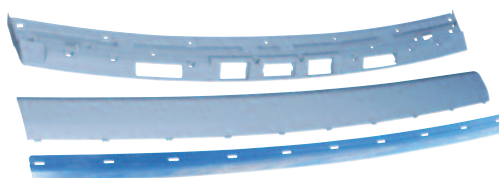

Discovery 3 & Discovery 4



**Discovery 3 & Discovery 4 - continued**



LR008713



VUB501200



VUB501380



VPLAP0008



VTD500020



VPLAP0009



VTK500010



VTD500010

DA7611



**NEW**

**DA6349 NEW**

Discovery 3 - 2.7 TdV6  
This FBH controller is ideal for warming your engine on cold winter mornings while sat in the comfort of your house, removing the need to go outside and start your engine to defrost the car which is especially handy if you have a car that has faulty glow or heater plugs. You can lock and unlock the vehicle without the heater stopping. It has a 30 min run time to aim for a default water temp of 76C.

For more details visit - [www.britpart.com/DA6349](http://www.britpart.com/DA6349)

DA5662	Fog lamp surrounds		Discovery 3	Plastic - chrome finish	Pair
DA5664	Fog lamp surrounds	<b>COMING SOON</b>	Discovery 4	Plastic - chrome finish	Pair
DA5658	Door handle cover		Discovery 3/Discovery 4	Plastic - chrome finish	Set of 4
<b>Headlight washer jet caps</b>					
DA5661	- Chrome;	DA7602 - Zermatt Silver; VPLAB0025LML - Primed	Discovery 3		Pairs
DA7610	Indicator lamp with orange bulb		Discovery 3	Clear	Single
DA7611	Indicator lamp with orange bulb		Discovery 3	Smoked	Single
EBN500041	Side sill tread plate kit		Discovery 3/Discovery 4	Stainless steel	Set of 4
DA5669	Side vent trim - Discovery 4 style		Discovery 3	Plastic - chrome finish	Single
DA5670	Side vent trim - Discovery 4 style		Discovery 3	Plastic - silver finish	Single
JAK000065MMM	Side vent trim		Discovery 3	Plastic - stainless steel finish	Single
VUB503880MMM	Wing mirror covers - top	(adhesive <b>STC50551</b> )	Discovery 3	Plastic - chrome finish	Pair
LR003905	Wing mirror covers - bottom	(adhesive <b>STC50551</b> )	Discovery 3	Plastic - chrome finish	Pair
LR005237LR	A Bar includes spot lamp brackets - moulded rubber		Discovery 3	Black	Single
VPLAP0022	A Bar includes spot lamp brackets - moulded rubber		Discovery 4	Black	Single
LR008713	Pedal set		Discovery 3	Stainless steel	Set of 3
VTD500010	Side protection tubes		Discovery 3/Discovery 4	Black steel	Pair
VTD500020	Side protection tubes		Discovery 3/Discovery 4	Stainless steel	Pair
VTK500010	Side runners with polypropylene side step top and a brushed aluminium side		Discovery 3/Discovery 4		Pair
VPLAP0035					
VUB501200	Lamp guards	Front	Discovery 3	Black	Pair
VUB501380	Lamp guards	Rear	Discovery 3	Black	Pair
VPLAP0008	Lamp guards	Front	Discovery 4	Black	Pair
VPLAP0009	Lamp guards	Rear	Discovery 4	Black	Pair

**Enhance** the look of your Discovery 3 or Discovery 4...

## Freelander 2



Photograph courtesy of Darren Whiley

<b>DA5663</b>	Fog lamp surrounds - pre-facelift models only	Plastic - chrome finish	Pair
<b>DA7610</b>	Indicator lamp with orange bulb	Clear	Single
<b>DA7611</b>	Indicator lamp with smoked lens	Smoked	Single
<b>LR002408</b>	Lamp guards	Black	Pair
<b>LR003685</b>	Lamp guards	Black	Pair
<b>LR002464</b>	Rear spoiler	Easy to fit - no drilling	Single
<b>LR002525</b>	Front and rear sill tread plate kit	Polished stainless steel	Set of 4
<b>LR002773</b>	Body side step with thermo plastic elastomer side step top and a brushed aluminium side trim		Pair
<b>LR003318</b>	Body side step - tube type	Stainless steel	Pair
<b>LR003319</b>	Black bumper styling cover for vehicles with or without parking sensors	No spot lamp brackets	Single
<b>VUB503880MMM</b>	Wing mirror covers - top (adhesive <b>STC50551</b> )	Plastic - chrome finish	Pair
<b>LR003905</b>	Wing mirror covers - bottom (adhesive <b>STC50551</b> )	Plastic - chrome finish	Pair

**Range Rover Evoque**



VPLVP0071



LR026593

LR032305

LR026592

LR026593

LR027486

VPLVP0071



**DA5557**  
Range Rover Evoque -  
3 & 5 door models  
Loadspace protector  
2" deep sides  
Semi-rigid foam with  
anti-slip finish

Sign up to the Britpart newsletter to see future Range Rover Evoque accessories as they are launched - [britpart.com/news](http://britpart.com/news)

<b>LR026593</b>	Bonnet grille for 3-door	Atlas	RHS
<b>LR026596</b>	Bonnet grille for 3-door	Atlas	LHS
<b>LR026592</b>	Bonnet grille for 3-door	Dark Atlas	RHS
<b>LR026595</b>	Bonnet grille for 3-door	Dark Atlas	LHS
<b>LR032305</b>	Bonnet grille for 3-door	Black	RHS
<b>LR032306</b>	Bonnet grille for 3-door	Black	LHS
<b>LR027486</b>	Scuff plate - rear door	Black	Single
<b>VPLVP0071</b>	Side protection tubes	Stainless steel	Pair

**Enhance** the look  
of your Range Rover Evoque...



## Defender

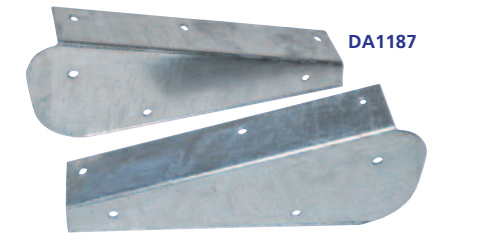
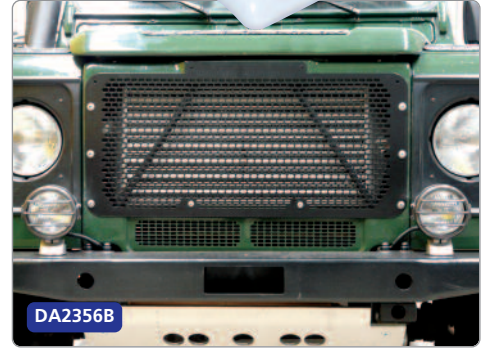



**Exterior Enhancements**

<b>LR008361</b>	Defender SVX style grille and headlight surround - Defender 2007 onwards	<b>Note</b> - Can be fitted to earlier Defenders with some modification.		Kit
<b>VPLDV0001</b>	Defender SVX style lights with manual headlamp levelling		Right hand drive	Kit
<b>VPLDV0003</b>	Defender SVX style lights with manual headlamp levelling		Left hand drive	Kit
<b>DA1157</b>	Front grille and headlight surround kit (grille badge not included)		Brunel grey	Kit
Parts available separately - DHH100780LQV - RHS headlight surround; DHH100790LQV - LHS headlight surround; LR038617 - grille; DAG500160 - black/silver logo grille badge; MXC6402 - green/silver grille badge				
<b>DA2356</b>	Front grille - stainless steel		Natural finish	Single
<b>DA2356B</b>	Front grille - stainless steel		Black finish	Single
<b>STC60713</b>	Heritage grille for non-air-con Defenders. Aluminium with silver/grey powder coated finish.			Single
Made from GRP this Puma bonnet is half the weight of the original Land Rover bonnets and will fit Defender 90 - 1984 onwards/Defender 110 -1983 onwards. The bonnet has return edges on all four sides underneath for strength and to make it more rigid. It has strengthened hinge points and is supplied with stainless steel hinge bolts & screws.				
<b>DA1963</b>	Puma bonnet		White	Single
<b>DA4000</b>	Air intake grille	Left hand side	Steel - black	Single
<b>DA4001</b>	Air intake grille	Right hand side	Steel - black	Single
<b>DA4000SS NEW</b>	Air intake grille - including stainless steel screw kit	Left hand side	Stainless steel	Single
<b>DA4001SS NEW</b>	Air intake grille - including stainless steel screw kit	Right hand side	Stainless steel	Single
<b>DPT100070</b>	Bumper end cap does not include fixings DZM100080		Rubber	Single
<b>DA1131</b>	Replacement aluminium door hinges with stainless steel hinge pins for Defender/Series - complete with fixings		Natural finish	4 hinges per set
Replace your corroded Defender windscreen brackets with a pair of these smart CNC machined aluminium billet brackets which won't tarnish like the standard brackets. Kits include gaskets and bolts. For fitment to vehicles with hinge type windscreen 2 x reinforcement strap LR016671 are required.				
<b>DA1142</b>	Billet windscreen brackets		Silver anodised finish	Pair
<b>DA1142B</b>	Billet windscreen brackets		Black anodised finish	Pair
Replace your corroded Defender bonnet hinges with a pair of these smart CNC machined aluminium billet hinges which won't tarnish like the standard brackets. Kits include hinges, hinge bushes and stainless steel bolts.				
<b>DA1152</b>	Bonnet hinges		Silver anodised finish	Pair
<b>DA1152B NEW</b>	Bonnet hinges		Black anodised finish	Pair
<b>DA1179</b>	Bulkhead vent hinge pin kit		Stainless steel	4 hinge pins
<b>XGB100310L</b>	Indicator lamp with orange bulb	2007 onwards	Clear	Single
<b>DA1188</b>	Front mud flap brackets (equivalent to MTC3000 & MTC3001)	Defender 90 & 110	Galvanised	Pair
<b>DA1187</b>	Rear mud flap brackets (equivalent to MUC3986 & MUC3987)	Defender 90	Galvanised	Pair
<b>DA5699</b>	Universal number plate mounting bracket	405mm wide x 110mm deep	Black finish	Single



**Bleed Screws**

Smart replacement anodised aluminium bleed screws for the top hose on a Td5 engine.

**PYP10008BLUE**

Blue

**PYP10008RED**

Red

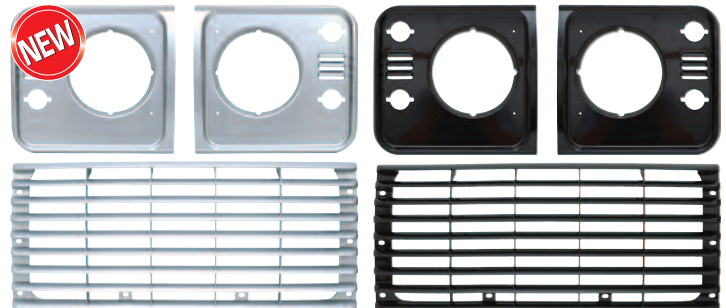

**Indus Silver NEW**

**DA1257** Grille & headlamp surround set

**LR059125** Grille

**LR059126** Headlamp surround - RH

**LR059127** Headlamp surround - LH

**Santorini Black NEW**

**DA1357** Grille & headlamp surround set

**LR051771** Grille

**LR059128** Headlamp surround - RH

**LR059129** Headlamp surround - LH

*Smarten the look of your Defender...*

**Stainless Steel Bolt & Screw Kits**

Using these smart stainless steel replacement bolt and screw kits will prevent rust from spoiling your Defender's bodywork - ideal for smartening up your vehicle or a restoration job.



**DA1145** Bolt kit  
Defender & Series rear door hinge pin kit  
3 x M6 x 60mm bolts; 3 x washers; 3 x cone bush & 3 x door hinge spring



**DA1133** Bolt kit  
Door kit - Front & rear - 4-door  
*The J-clips are carbon and phosphor coated to give 450 salt hour life*  
4 x M8 x 100mm countersunk allen head bolts; 4 x M8 x 80mm countersunk allen head bolts; 8 x M8 x 35mm countersunk allen head bolts; 16 x M8 x 55mm countersunk allen head bolts; 8 x M8 J-clips; 16 x nyloc nuts & 16 x M8 flat washers



**DA1132** Bolt kit  
Door kit - Front - 2-door  
*The J-clips are carbon and phosphor coated to give 450 salt hour life*  
8 x nyloc Nuts; 8 x M8 x 35mm countersunk allen head bolts; 8 x M8 x 55mm countersunk allen head bolts; 8 x M8 J-clips & 16 x M8 flat washers (not pictured)



**DA1134** Bolt kit  
Door kit - Rear - Safari  
6 x M8 x 55mm allen head bolts; 6 x M8 x 30mm allen head bolts; 12 x M8 nyloc nuts & 12 x M8 flat washers



**DA1135** Bolt kit  
Bonnet hinge kit  
6 x bolts; 6 x nyloc nuts & 6 x washers

**BANISH RUSTY BOLTS & SCREW HEADS!**



**DA1139** Bolt kit  
Bumper kit  
4 x M10 x 120mm bolts; 4 x 3mm x 30mm flat washers & 4 x plastic head caps



**DA1136** Bolt kit  
Rear cross member to body kit  
10 x M8 x 25mm socket cap bolts; 10 x M8 nyloc nuts & 10 x M8 flat washers



**DA1138** Screw kit  
Front grill kit  
8 x 6.3 x 19mm self tap pozi screws



**DA1169** Screw kit  
Headlight panel kit  
4 x 8 x 13mm self tap pozi screws

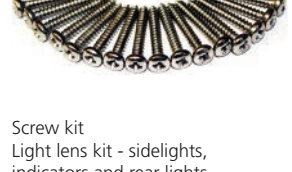

Screw kit  
Light lens kit - sidelights, indicators and rear lights  
**DA1137**  
Defender - up to MA94004  
**DA1168**  
Defender - MA94005 onwards

## Defender - continued



DA5500 WITH DA5499 ALSO FITTED



DA5500

DA6600



DA2610



DA2603



DA2603CF



DA1205



AFP7101205S



DA1204



DA1203



DA1170



DA5717

Retrofit insert seat heaters

- Complete set for two seats
- Extra comfort with 2 heating levels - Stage I = pleasant permanent heat & stage II = heat-up.
- Installation kit for driver's seat and front passenger's seat with four heating elements.
- Pre-assembled cable set with switching relay and two illuminated switches for universal use.
- Integrated temperature guard.
  - Heating elements made of extremely flexible coated wires.
  - For seats with removable covers.
  - Fitting materials & instructions.

Full details in the Seats & Trim section

### Interior Enhancements

DA5498	Replacement gear box gaiter	Grey	Single
DA5499	Replacement gear box gaiter	Black	Single
DA5500	Gear lever and transfer gear lever set for R380 gearbox	Anodised alloy	Pair
DA6600	Gear lever and transfer gear lever set for LT77 gearbox	Anodised alloy	Pair
DA2610	Coin tray for Defender - 1987 - 2006		Single

**Glove box kit**  
Neat storage solution for the new Defender which utilises the available dashboard space. Ideal for storing all the usual small items you carry with you. Robust construction and easy to fit with all the necessary parts supplied. Suitable for right and left hand drive models.

DA2603	Defender - 2007 onwards		Single
DA2603CF	Defender - 2007 onwards	Carbon fibre effect finish fascia plate	Single

**Demister kit**  
Fitting this Defender demister kit will help demist your windscreen better than the standard fitted demister and has the added bonus that it will also demist your side windows too. With full fitting instructions.

DA1205	Defender - up to 2007		
AFP7101205S	Loadspace mat retainer stainless steel strip with stainless steel fixings	Stainless steel	Single

**Rear Door Stays**  
Does your Defender's rear door sometimes close on you unexpectedly? This neat and easily installed gas strut kit will solve that problem and replaces the original door stopper. The gas strut will hold the door in place when open - even with a spare wheel in place - and will assist in the opening of the rear door too with a smoother and more controlled movement. Complete with fittings and instructions.

DA1204	Defender - up to 2002		
DA1203	Defender - 2002 onwards		
DA1170	SVX style cargo tie down point - smart and easy to fit		Single

**Defender - continued**

**KEEP IT COOL**

**Air conditioning kits**

As OE fitment, no drilling required. Once fitted the system is indistinguishable from factory fitted units. Plugs straight into the existing Land Rover wiring loom and fuse board. Easy to install as components are pre-assembled. Kit uses high performance condenser which eliminates need for an extended nose cone. Parts interchangeable with Land Rover parts.

<b>DA2343R</b>	Defender 90/110 - 300Tdi	RHD
<b>DA2342R</b>	Defender 90/110 - Td5	RHD
<b>DA2342L</b>	Defender 90/110 - Td5	LHD
<b>DA2344</b>	Defender 90/110 - 2007 onwards	RHD & LHD

**Electric Window Kit**



**DA4664**  
Defender - 2002 onwards  
Fed up with winding your windows up and down?  
Make life easier, add electric front windows to your Defender with this comprehensive kit. Includes fitting instructions.

**Dual USB Charger**

**DA4679**  
Easy to install in existing 12V DC socket hole providing convenient access for charging mobile devices.

- Compatible with popular mobile devices
- Protective cap
- Easy to use

**Specifications**

Maximum output current - 2.1A DC (total)  
Cut out dimensions - 1 1/8 in (28.58 mm) dia. hole  
Input voltage - 12V  
Output voltage - 5V DC +/- 5%  
Parasitic current draw - 15mA  
USB - 2.0



**Steering Wheels**

<b>DA4650</b>	15" 3-spoke sports wheels Black vinyl	Black centre
<b>DA4654</b>	14" 3-spoke sports wheels Black vinyl	Black centre

**Note** - To fit steering wheel to vehicle you'll need a new boss kit.

**DA4661** 90/110 & Defender up to HA & 1A onwards  
16mm shaft/36 splines - this is drilled and has a contact plate. Pins are spaced at 38mm across, flat centre.

**DA4659** 90/110 & Defender up to HA & 1A onwards  
16mm shaft/36 splines - this is not drilled, pins are spaced at 28mm across, centre of splines casting is raised by 5mm

**DA4660** Defender - JA onwards & Series 2 / 2A / 3  
19mm shaft/48 splines



Shown with boss kit fitted



DA4650 / DA4654



**Roof Console**

**DA4629**

This roof console fits all Defenders except sunroof equipped models. Supplied with interior lamp extension loom and DIN blanking panel. Fitting kit and instructions are also supplied. Finished in grey only.

The console offers a unique storage solution for the Defender in providing additional overhead roof storage as well as a single DIN provision in one unit. The two side sections are designed to hold anything from maps to sunglasses, documents to magazines.

The console is supplied in three separate pieces. The product has been designed with CAD software and the moulding finished off using CNC machinery to ensure an OE level fit and finish to the product.

It is supplied with a DIN blanking panel but the central binnacle will fit any DIN sized accessory such as a stereo, CB/HAM radio or even a digital tachograph. The single DIN aperture will also accept a bank of seven Carling Technologies switches by using the Carling interlocking switch mounts.

**Will the Defender roof console fit my vehicle?**

The console has been designed to fit all post 1983 Defender models without a sunroof and with a factory headlining. The fixing method does not require removal or cutting of the headlining or sun visors. (Some later models will require trimming of the central area of the headlining when fitting a DIN unit). If you have a non-factory headlining it is unlikely it will fit without modification of the headlining. If you have a Series vehicle, again it is unlikely it will fit without modification.



## Section contents

<b>Books, manuals &amp; technical publications</b>	
Catalogues, manuals & more...	190
Haynes books & manuals	190
Land Rover original technical publications	191
Landy books	191
Magbooks	191
Range Rover - The First Fifty	191
<b>Britpart Distributor Merchandise</b>	197
<b>Gifts &amp; merchandise</b>	
Britpart merchandise & clothing	192
Die-cast models	195
Haynes internal combustion engines	195
Land Rover Merchandise	193 - 194
<b>Radiator muffs</b>	196
<b>Starting handle</b>	196
<b>Wiper blades - heavy-duty</b>	196

“This is the section to find all the stuff we couldn’t categorise anywhere else. We have a great range of Britpart merchandise along with plenty of great gift ideas from Land Rover Merchandise. Also you’ll find the workshop books and much much more...”

miscellaneous



## Books, Manuals & Technical Publications

Haynes Books & Manuals



the worldwide market leader in automotive repair manuals

### Defender

<b>DA3035</b>	Owners Workshop Manual	90, 110 & Defender - 1983 - 2007 (up to 56 reg) - Diesel
<b>DA3189</b>	Modifying Manual	A practical guide to upgrades - By Lindsay Porter
<b>DA3040</b>	Restoration Manual	90, 110 & Defender - By Lindsay Porter <b>REDUCED TO CLEAR</b>
<b>DA4558</b>	Restoration Manual <b>NEW</b>	90, 110 & Defender - By Lindsay Porter

### Discovery

<b>DA2093</b>	Haynes Extreme	Discovery - The definitive guide to modifying - By Emmeline Willmott
<b>DA3036</b>	Haynes Service & Repair Manual	Discovery - 1989 - 1998 (G to S reg) - Petrol & Diesel
<b>DA3106</b>	Enthusiast Guide	Discovery - By Dave Pollard
<b>DA4493</b>	Owners Workshop Manual	Discovery - Nov 1998 - July 2004 (S to 04 reg) - Diesel
<b>DA4505</b>	Owners Workshop Manual	Discovery - Aug 2004 - April 2009 (04 to 09 reg) - Diesel

### Freelander

<b>DA4565</b>	Owners Workshop Manual	Freelander - 1997 - Oct 2006 (R to 56 reg) - Petrol & Diesel
	<b>Note</b> - Does not cover models with 2.5ltr V6 petrol engine	
<b>DA4588</b>	Owners Workshop Manual	Freelander - Nov 2006 to 2014 (56 to 64 reg) - Diesel

### Range Rover

<b>DA3042</b>	Restoration Manual	Range Rover Classic - By Dave Pollard
<b>DA3048</b>	Haynes Service & Repair Manual	Range Rover Classic - 1970 - Oct 1992 (up to K reg) - Petrol

### Series

<b>DA4636</b>	Owners Workshop Manual	Series 2, 2A & 3 - 1958 - 1985 (up to C reg) Petrol & Diesel
<b>DA3041</b>	Restoration Manual	Series 1, 2 & 3 - By Lindsay Porter

### General Interest

<b>DA3044</b>	The Off-Road 4-Wheel Drive Book	- Choosing, using and maintaining go anywhere vehicles By Jack Jackson
<b>DA4506</b>	Enthusiast Guide	Military Land Rover 1948 onwards (Series 2, 2A to Defender) An insight into the history, development, production and roles of the British Army's light four-wheel drive vehicle.
<b>DA4566</b>	Off-Road Driving Manual	By Vince Cobley & Dave Phillips. Step-by-step instruction for all terrains. This extensively illustrated step-by-step manual is aimed at all drivers wishing to learn to drive safely and successfully off-road, whether for the occasional trip across a field or to prepare for an off-road expedition in a remote part of the world.

DA4588

DA4558



## Catalogues, Manuals & More...

### Parts Catalogues

<b>RTC9840CC</b>	Series 2A - Bonneted Control
<b>RTC9842CE</b>	2A, 3 & 109 V8 - Optional Equipment
<b>RTC9841CE</b>	Series 3
<b>RTC9863CE</b>	One Ten Covering vehicles up to August 1986
<b>STC9021CC</b>	Defender 90/110/130 Covering 1987 - 2006
<b>RTC9947CF</b>	Discovery 1 Covering 1989 - 1998 - 2.0 Mpi/3.5/3.9 V8 petrol & 200Tdi/300Tdi diesel engines
<b>RTC9846CH</b>	Range Rover Classic - 1970 - 1985
<b>STC9049CA</b>	Discovery 2 - Covering 1999 - 2003
<b>RTC9970CE</b>	Range Rover P38 Covering 1995 - 2001 - 4.0/4.6 petrol & BMW 2.5 diesel engines

### Handbooks

<b>DA3162</b>	Defender 90/110/130 Covering 1991 - February 1994 - 2.5/3.5 V8 petrol & 2.5/200Tdi diesel engines
<b>LRL0087ENG</b>	Defender 90/110/130 Covering March 1994 - 1998 - 2.5/3.5 V8 petrol & 2.5/300Tdi diesel engines
<b>DA3161</b>	Discovery 2 - Covering 1999 - 2004

### Workshop Manuals

<b>DA3157</b>	Defender - Td5 1999 - 2006 Includes workshop manual and electrical manual
<b>DA3147</b>	Freelander 1 - 2001 - 2003 onwards Includes V6 petrol engines
<b>DA3148</b>	Range Rover L322 - 2002 - 2005* Workshop manual
<b>DA3149</b>	Range Rover L322 - 2002 - 2005* Electrical manual Includes electrical library and electrical circuit diagrams

\*Covering BMW 4.4ltr petrol V8 engines & BMW 3.0L diesel engines

### Other Publications

<b>DA3156</b>	Winch In Safety - A5 hand book by Land Rover with pictures throughout.
<b>LRL0178ENG</b>	Replacement service portfolio



**Landy Books**

These charming hardback books, which are beautifully written and illustrated by Veronica Lamond, are an excellent gift idea for any Land Rover fan - whatever their age!

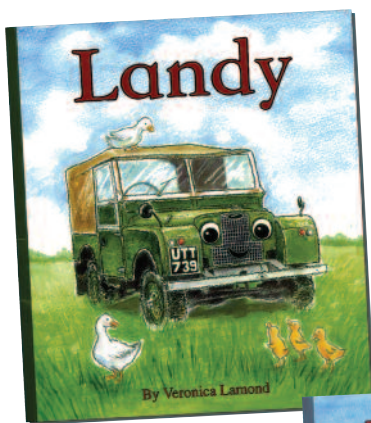

**LANDY**  
*"Landy has been left abandoned for many years until, one day, Jack finds him..."*

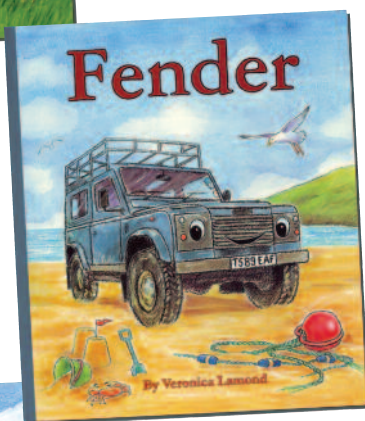

**FENDER**  
*"Scamp races Fender down the track - they have lots of things to do and lots of friends to meet!..."*

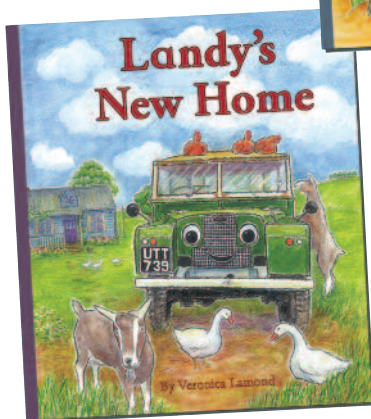

**LANDY NEW HOME**  
*"Jack and Landy are busy setting up their small holding but Landy feels left out. When Fender arrives, Landy realises he hasn't been forgotten after all..."*

**Range Rover - The First Fifty**

**DA3202**  
 Range Rover - The First Fifty Prototypes, YVBs and NXC's - the story of the early Range Rovers. Today, the Range Rover is a legend. The original design lasted in production for more than a quarter of a century. It is those very first Range Rovers which are the subject of this book. Its aim is to record the story of the earliest vehicles before it becomes lost in the mists of legend and distorted by commercial misrepresentation. It looks at three distinct groups of vehicles. These are the Engineering Prototypes (of which there were seven), the Pre-Production Vehicles (of which there were 28, most registered in the YVB-H series), and the Press Launch Vehicles (of which there were 20, all registered in the NXC-H series). The total comes to slightly more than 50 vehicles. With 160 illustrations and 160 pages.

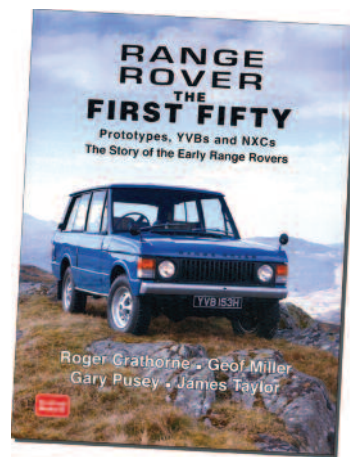

**Magbooks**



**DA3188B**

**DA2988**

**DA3188B** Issue 2  
 From the publishers of Land Rover Monthly a 228 page celebration of the Defender including vehicles through the ages, rebuilds & repairs and buyers guides.  
**DA2988**  
 From the publishers of Land Rover Monthly a 220 page celebration of the Discovery. Buying, restoring, modifying, driving - the ultimate Land Rover Discovery guide.

**Land Rover Original Technical Publications**

Here are the original Land Rover and Range Rover publications needed to run and maintain your classic Land Rover or Range Rover, including parts catalogues, service manuals, technical information and owners literature and more. What's more, with these DVDs you can find information and links to Land Rover, Land Rover Heritage and Original Technical Publications. Discover more about the history of Land Rover, Land Rover and Range Rover models and get the latest Heritage news and information. You can also find links to local Land Rover and Range Rover Clubs, the latest picture galleries, video and media archives - you can even download classic Land Rover and Range Rover wallpaper to personalise your computer.

Original parts books, workshop manuals and handbooks for Land Rovers and Range Rovers have always been greatly sought after, and rightly so: nothing compares, for example, to a Land Rover workshop manual compiled by the car's manufacturer. Now owners and enthusiasts have the opportunity to effortlessly collect all the original publications for their favourite Land Rover or Range Rover, on one handy and cost-effective DVD.

See [www.britpart.com](http://www.britpart.com) for much more in depth information about what is included on each DVD. Far too much to list here!

**Handy and easy to use!**

<b>LTP3001</b>	Series models - 1948 - 1985
<b>LTP3003</b>	Land Rover 90, 110, 127 & Defender 90, 110 & 130 - 1983 - 2006
<b>LTP3004</b>	Discovery 1
<b>LTP3006</b>	Discovery 2
<b>LTP3016</b>	Discovery 3
<b>LTP3017</b>	Discovery 4 - 2009 - 2012
<b>LTP3007</b>	Freelander 1
<b>LTP3002</b>	Range Rover Classic
<b>LTP3005</b>	Range Rover P38
<b>LTP3008</b>	Range Rover L322 - 2002 - 2006
<b>LTP3015</b>	Range Rover Sport - 2005-2009

**System Requirements -**  
**PC** - Windows 2000 or later. DVD Reader, Safeguard Windows PDC viewer. Must have administration rights to allow installation. **Mac** - OS X 10.4 or above. DVD Reader, Safeguard OSX PDC viewer Mac iOS 5.01 and above, Safeguard Mac iOS viewer. **Android** - 4.0 and above, Safeguard Android viewer.  
**Important - Documents are viewable but not printable through Mac OSX or Mac iOS. To print using a Mac you must be running a Windows installation e.g. using PC emulation software.**

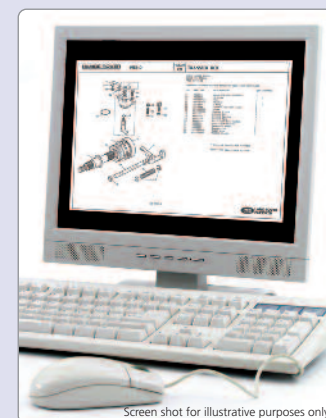
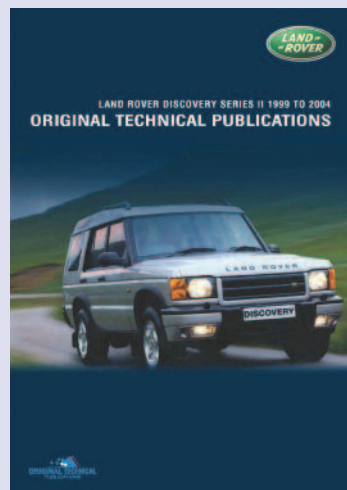

Screen shot for illustrative purposes only

- Product Features**
- Printable - print only the pages you need (Windows & Android only).
  - Viewable - from DVD or via online access (single user license).
  - Searchable - search the entire section in seconds.
  - Zoom - zoom in to see the exact details.
  - Bookmarked - manuals are bookmarked to quickly locate sections.

## Gifts & Merchandise

### Britpart Merchandise & Clothing



DA8000 Mouse & mug mat set



DA8002 Key ring - karabiner style



Note - Picture shows both sides

DA8023 Key ring - plastic



DA8027 Key ring - bottle opener



DA8003 Ball point pen



Note - Picture shows both sides

DA8004 Mug - single



DA8015 Stainless steel travel mug



DA8016 5" Teddy bear



DA8017 Drawstring bag



DA8024 300mm Ruler



DA8025 Ice scraper



DA8026 Calculator



DA8036 Pen pot



DA8037 Pocket LED torch



DA8038 Note book - 190 x 250mm



DA8042 Air freshener - cool wave scent Pack of 5



DA1229 Defender stress toy



DA8043 Credit card wallet

#### Britpart Clothing

DA8045 **NEW** Polo shirt - small

DA8005 Polo shirt - medium

DA8006 Polo shirt - large

DA8007 Polo shirt - x-large

DA8008 Polo shirt - xx-large

DA8029 T-shirt - medium

DA8028 T-shirt - large

DA8020 T-shirt - x-large

DA8046 **NEW** Sweatshirt - small

DA8009 Sweatshirt - medium

DA8010 Sweatshirt - large

DA8011 Sweatshirt - x-large

DA8012 Sweatshirt - xx-large

DA8047 **NEW** Fleece - small

DA8040 Fleece - medium

DA8041 Fleece - large

DA8018 Fleece - x-large

DA8019 Fleece - xx-large

DA8049 **NEW** Fleece body warmer- x-large

DA8013 Ski hat

DA8021 Baseball cap



DA8049



LOGO ON BACK OF POLO & SWEATSHIRT



DA8013



DA8021



POLO SHIRT



SWEATSHIRT



T-SHIRT



FLEECE



Land Rover Merchandise



**LRDCA3EVOQ**  
Range Rover Evoque - 3 Door  
1:43 scale die-cast model.



**LRDCA5EVOQ**  
Range Rover Evoque - 5 Door  
1:43 scale die-cast model.



**LRDCADISCO**  
Discovery 4  
1:43 scale die-cast model.



**LRDCA405**  
Range Rover L405  
1:43 scale die-cast model.



**LRDCA494**  
Range Rover Sport - 2014 onwards  
Chile Red  
1:43 scale die-cast model



**LRDCA494G**  
Range Rover Sport - 2014 onwards  
Corris Grey  
1:43 scale die-cast model

Ideal *birthday* or *Christmas* gifts for any Land Rover enthusiast - whatever their age!



**LRSS12RSPH**  
Premium soft and supple fine and heavy grained black leather iPhone holder with Alcantara lining detail. Suitable for iPhone 3 & 4 with phone and credit card sections.



**LRSS12RLIPH**  
Premium soft and supple fine and heavy grained black leather iPad holder with Alcantara lining detail and magnetic main closing mechanism.



**LRSS12RHW**  
Premium soft and supple fine and heavy grained black leather wallet with Alcantara lining detail and multi-card and note compartments.



**LRSS12RCCW**  
Premium soft and supple fine and heavy grained black leather card holder with Alcantara lining detail and multi-card sections.



NAVY



BLACK



WHITE



<b>LRSPANN</b>	Land Rover	Navy	Small	Hard cover lined 152 page notebook featuring Land Rover or Range Rover Sport branding on the cover and page details. These notebooks also feature an expandable inner pocket.
<b>LRSPANNL</b>	Land Rover	Navy	Large	
<b>LRSPANGS</b>	Land Rover	Black	Small	
<b>LRSPANGL</b>	Land Rover	Black	Large	
<b>LRSPANRRSL</b>	Range Rover Sport	White	Large	Small notebook - 90 x 140mm

**LRSPABCBP**  
Contemporary styled and polished chrome Cross ballpoint pen with subtle Land Rover branding.



**LRKRAHUE**  
Cast metal enamelled alloy keyring taking inspiration from the original licence plate of the Series I, the HUE 166.

**LRCEAHUEW** - White  
**LRCEAHUEG** - Green  
**LRCEAHUEB** - Black  
Stoneware mug with raised embossed HUE 166.



**LRKRALLK**  
Chromium plated keyring with matt finish & double thickness brown and ivory leather loop keyring with pull to twist mechanism.



**LRO 2798**  
The vacuum-insulated Range Rover travel flask helps keep beverages hot or cold.

## Land Rover Merchandise - continued



**LRSS12BC1**  
Outdoor inspired Land Rover Terrain baseball cap with Land Rover iconography.



**LRSS12BC2**  
Subtle branded baseball cap with All-New Range Rover inspired under peak print.



**UMAGBG**  
Manual opening golf umbrella with lightweight fibreglass shaft and windproof system. Indigo polyester single thickness canopy with grey logo print on one panel.



You can now find all the latest Britpart news on Facebook!

[facebook.com/britpart](https://facebook.com/britpart)

Ideal **birthday** or **Christmas** gifts for any Land Rover enthusiast - whatever their age!



Die-cast Models



DA1219



DA1254



DA1223



DA1220



DA1222



DA1221

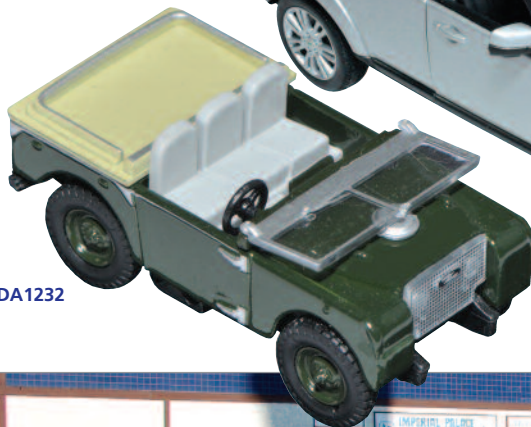

DA1232

**Collectable and detailed die-cast metal 1:18 scale model DA1219** Range Rover Evoque - 2-door Red  
This very detailed die-cast Evoque replica is not a toy and is not suitable for children under 14. The model is 245mm long x 120mm wide x 95mm high. It has detailed engine and interior parts with opening doors, boot and has a button under the chassis to open the bonnet, even the side mirrors fold on this superb scaled replica which is a must for all collectors and enthusiasts.

**Collectable and detailed die-cast metal 1:24 scale models**

<b>DA1223</b>	Defender - 2007 onwards	White
<b>DA1221</b>	Discovery 4	Silver
<b>DA1222</b>	Range Rover Evoque - 2-door	White
<b>DA1220</b>	Range Rover L322	Silver

**Collectable and detailed die-cast metal 1:43 scale models**

<b>DA1254 NEW</b>	Series 1 Export version	Green
-------------------	-------------------------	-------

**Collectable and detailed die-cast metal 1:76 scale models**

<b>DA1232</b>	Series 1 Flat Back	Green
---------------	--------------------	-------



**Haynes Internal Combustion Engines**

**DA4310**

Build a realistic working model of a combustion engine. Includes light and sound features, light up spark plugs, moving pistons, valve gear, fan belt and 'Haynes Manual'.

Finished model size -  
180 x 270 x 140mm  
(H x W x D)

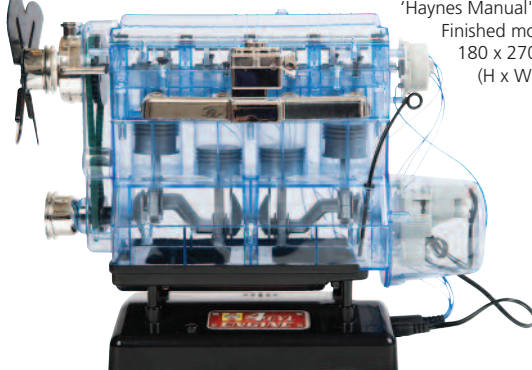

*Build a working model of an engine!*

**DA4817**

Build a fully functional, motorised model of a V8 petrol engine. Features sound recorded from a real V8 and illuminating spark plugs. The kit contains nearly 300 pieces and all that you need to assemble the model. It is supplied with a Haynes style manual giving you clear step-by-step instructions as well as interesting information about real V8 engines.

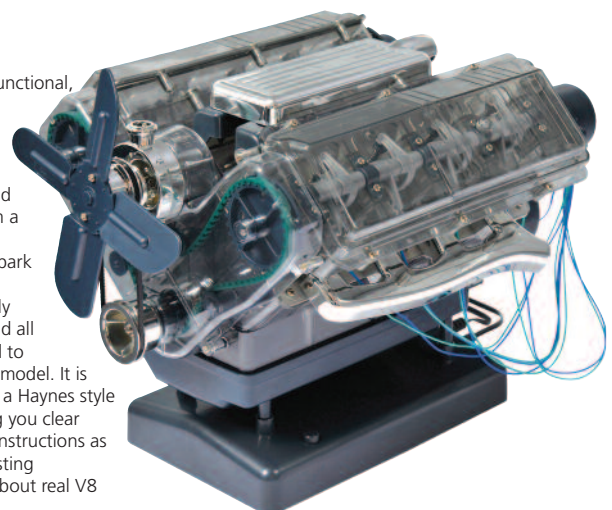

# Radiator Muffs



**Note** - The radiator muffs are black with either black, blue, brown or green coloured edging.

**Series 2/Series 2A - early models**

<b>DA4025BLACK</b>	Black edging
<b>DA4025BLUE</b>	Blue edging
<b>DA4025BROWN</b>	Brown edging
<b>DA4025GREEN</b>	Green edging

**Defender**

<b>DA2161BLACK</b>	Black edging
<b>DA2161BLUE</b>	Blue edging
<b>DA2161BROWN</b>	Brown edging
<b>DA2161GREEN</b>	Green edging

**Discovery** - black edging

<b>DA2153</b>	Discovery 1 - up to LA
<b>DA2157</b>	Discovery 1 - MA onwards
<b>DA2163</b>	Discovery 2
	- square headlights
<b>DA2162</b>	Discovery 2
	- round headlights

**Series 2A - late models/Series 3**

<b>DA2160BLACK</b>	Black edging
<b>DA2160BLUE</b>	Blue edging
<b>DA2160GREEN</b>	Green edging

Control the flow of air into your radiator with a quality British made radiator muff!

## Starting Handle



## Wiper Blades - Heavy-duty

**DKC500010PMD**  
Discovery 2  
Front  
Pair

**VUB500900**  
Freelander 1  
Front  
Pair



Heavy-duty winter wiper blades

**Note** - These winter wiper blades should not be used at high speeds, it is a winter blade designed for harsh conditions.



Photograph courtesy of Stewart Pickering

Britpart Distributor Merchandise



**EXTERIOR STICKER**  
High tack vinyl gloss stickers  
300 x 90mm Qty 20

**INTERIOR STICKER**  
Self-cling window stickers  
220 x 70mm Qty 20

**LOGOBOARD**  
Britpart logo on 3mm foamex board  
900 x 300mm Qty 1



**DEFENDER STICKER**  
Britpart cartoon Defender stickers  
100 x 60mm Qty 20

*Please ask the sales team for details...*



**CARRIER BAG**  
Britpart branded carrier bags  
380 x 470mm Qty 50



**DA8042PACK**  
Britpart branded air fresheners  
Cool wave scent  
100 x 65mm Qty 25



**CATALOGUE**  
Britpart accessory catalogue  
210 x 297mm Qty 5



**SERVICE KIT LEAFLET**  
Britpart service kit leaflet  
99 x 210mm Qty 25



**POSTER SET**  
Britpart A2 poster set  
380 x 470mm Qty 8



**DA8023PACK**  
Britpart key rings Qty 25

Both sides shown



**DA8048 NEW**  
Britpart branded note pads  
A5 with 50 pages per pad  
Qty 10





Photograph courtesy of Ryan Williams

Part No.	Page No.	Part No.	Page No.	Part No.	Page No.	Part No.	Page No.	Part No.	Page No.
67187	48	ALR6272	155	CAT101160	12	DA1145	185	DA1962	112
201691	48	ALR6677	154	CAT101170	12	DA1146	45	DA1963	185
218453	158	ALR6678	154	CAT500010PCL	12	DA1147	172	DA2001N	158
218508	34, 196	ALR6681	155	CAT500060PMA	12	DA1148	110	DA2001O	158
234532	165	ALR6682	155	CAT500070PMA	12	DA1148CAP	110	DA2002	158
241283	121	ALR6852	154	CAT500120PCL	12	DA1149	110	DA2003	121
242139	49, 53	ALR8519	155	CAT500340PMA	12	DA1152	185	DA2004	6
242863	121	ALR8520	155, 157	CAT500350PMA	12	DA1152B	185	DA2005	145
243123	121	ALR8572	155	CAT500360PMA	12	DA1153	172	DA2006	145
264563	121	ALR8573	155	CAT500370PMA	12	DA1155	172	DA2007	158
265627	121	ALR8576	155	CAT500410PMA	12	DA1156	34	DA2008N	158
279678	121	ALR8577	155	CAT500450PMA	12	DA1157	185	DA2008O	158
279679	121	ALR8710	159	CAT500540PMA	12	DA1158	45	DA2009	158
320647	70	ALR9877	155	CATALOGUE	197	DA1159	147	DA2012	53
320674	70	ALR9878	155	CE5500020	165	DA1160	172	DA2013	158
320698	70	AMR2341DELAY	144	CN100208L	165	DA1161	172	DA2014	158
320699	70	AMR3850	42	CN100508L	165	DA1162	171	DA2015N	158
320726	70	AMR6513LED	42	CN100909	165	DA1164	112	DA2015O	158
320737	70	AMR6514LED	42	CQB000140	154	DA1165	142	DA2016	158
330422	71	AMR6515LED	42	CVW500010	154	DA1166	142	DA2017N	158
330426	158	AMR6515LEDCL	42	DA1003	80	DA1167	142	DA2017O	158
330427	158	AMR6526	42	DA1004	80	DA1168	185	DA2019N	158
331401	58	AMR6526LED	42	DA1043	149	DA1169	185	DA2019O	158
331670	58	AMR6527	42	DA1044	149	DA1170	186	DA2021	34
345510	32	AMR6527LED	42	DA1045	149	DA1171	92	DA2022	34
345985	8	AMR6528	42	DA1056	13, 153	DA1172	142	DA2023N	158
349943	69	ANR1721PY	115	DA1057	146	DA1173	172	DA2023O	158
349967	70	ANR1721PY-YELLOW	115	DA1057PLUG	146	DA1174	86	DA2024	154, 158
390381	157	ANR1799A	112	DA1059	14	DA1174GM	86	DA2025	34
390382	157	ANR2056	154	DA1062	41	DA1174HM	86	DA2026	34
395529	158	ANR2563PY	115	DA1062AMBER	41	DA1174SM	86	DA2026N	154, 158
395530	158	ANR2563PY-YELLOW	115	DA1062BLUE	41	DA1176	172	DA2026O	154, 158
396739	70	ANR2763MMMM	38	DA1062COVER	41	DA1178	76	DA2027	34
517588	121	ANR3285PY	115	DA1062FOGA	41	DA1179	185	DA2029	72
517589	121	ANR3285PY-YELLOW	115	DA1062FOGW	41	DA1182	146	DA2030	72
532268	140	ANR3305PY	115	DA1063	41	DA1185	147	DA2035	66
535173	121	ANR3305PY-YELLOW	115	DA1064	41	DA1186	112, 153	DA2035BLUE	66
537179	34	ANR3332PY	115	DA1065	173	DA1187	12, 153, 185	DA2035BROWN	66
559822	158	ANR3332PY-YELLOW	115	DA1070	154, 158, 159	DA1188	12, 153, 185	DA2035CHAR	66
562631	121	ANR3410PY	115	DA1071	177	DA1189	172	DA2035GREY	66
562632	121	ANR3410PY-YELLOW	115	DA1072	177, 179	DA1191	42	DA2035LCS	66
576521	76	ANR3631MNH	36	DA1073	177	DA1192	42	DA2035RPI	66
579408	48	ANR3635	48	DA1077	42	DA1193	11	DA2035T	66
589783	43	ANR3973	35	DA1077G	42	DA1194	11	DA2037	93
606435	171	ANR4188EYELLOW	113	DA1079	8	DA1195	85, 144	DA2037KY	93
320647CB	70	ANR4188PY	113	DA1080	42	DA1196	85, 144	DA2039	146
320647CG	70	ANR4188PYE	113	DA1080G	42	DA1197	11	DA2050	6
320647LCS	70	ANR4188PY-YELLOW	113	DA1081	57	DA1198	11	DA2051	6
320647RPI	70	ANR4189EYELLOW	113	DA1082	57	DA1199	114	DA2052	6
320647T	70	ANR4189PY	113	DA1087	100	DA1200	147	DA2053	6
320674CB	70	ANR4189PYE	113	DA1087FL	100	DA1200G	147	DA2054	6
320674CG	70	ANR4189PY-YELLOW	113	DA1088	100	DA1203	72, 186	DA2056-300TDI-M	153
320674LCS	70	ANR4489	79	DA1089	24, 25	DA1204	72, 186	DA2056-M	153
320674RPI	70	ANR4583PM	35	DA1090	25	DA1205	186	DA2057	153
320674T	70	ANR4583SILVER	35	DA1091	25	DA1209	172	DA2057-300TDI	153
320737CB	70	ANR4635PM	35	DA1092	25	DA1211	121	DA2060	6
320737CG	70	ANR4636PM	35	DA1093	25	DA1212	121	DA2061	6
320737LCS	70	ANR5307MNH	36	DA1108	100	DA1213	141	DA2062	6
320737RPI	70	ANR5593PM	35	DA1108TDI	100	DA1214	141	DA2063	6
320737T	70	ANR6091	33	DA1109	100	DA1215	113, 153	DA2064	6
331110AG	68	ANR6094L	33	DA1109DEF	100	DA1216DIFF	152	DA2065	6
331110SA	68	ANR6947PY	115	DA1109DIS	100	DA1216HALDEX	152	DA2066	6
331113AG	68	ANR6947PY-YELLOW	115	DA1110	110	DA1219	195	DA2067	6
331113SA	68	ASB710260	154	DA1111	171	DA1220	195	DA2068	6
331259AG	68	ASB710270	154	DA1112	100	DA1221	195	DA2069	6
331259SA	68	ASR1186	155	DA1113	148	DA1222	195	DA2070	6
331260AG	68	ASR1187	155	DA1114	159	DA1223	195	DA2071	13
331260SA	68	ASR1594	155	DA1115	171	DA1224	76	DA2090	71
331308AG	68	ASR1595	155	DA1116	171	DA1224SN	76	DA2091	71
331371AG	68	AWR5698RPI	69	DA1117	171	DA1225	76	DA2093	190
345985P	8	AWR5699RPI	69	DA1118	171	DA1227	7	DA2096	71
548205PY	115	AWR5700RPI	69	DA1119	173	DA1228	146	DA2098	71
548205PY-YELLOW	115	AWR5701RPI	69	DA1120	171	DA1229	192	DA2099	158
552818PY	115	AWR5702RPI	69	DA1121	171	DA1232	195	DA2112	145
552818PY-YELLOW	115	AWR5708RPI	69	DA1122	168	DA1233	113, 153	DA2112-1	145
552819PY	115	BIC710260	154	DA1123	123	DA1234	121	DA2112-2	145
552819PY-YELLOW	115	BL4136BUSH	120	DA1125	172	DA1235	171	DA2112-3	145
563165/6/7/8	146	BTR1759LCS	69	DA1126	48	DA1236	140	DA2112B	145
568858PY	115	BTR277	12	DA1127	147	DA1238	81	DA2112G-EARLY	145
568858PY-YELLOW	115	BTR3793LCS	72	DA1128	110	DA1239	81	DA2112G-LATER	145
569746PY	115	BTR7895	60	DA1129	110	DA1240	154, 159	DA2113	145
569746PY-YELLOW	115	BTR7896	60	DA1129ADJ	110	DA1241	152	DA2114	145
572068PY	115	BTR7897	60	DA1129G	110	DA1242	111	DA2114B	145
572068PY-YELLOW	115	BTR7898	60	DA1129KIT	110	DA1243	111	DA2115	145
572180PY	115	BTR7959LCS	72	DA1129ULTRA	110	DA1244	111	DA2116	158
572180PY-YELLOW	115	BTR9712LCS	72	DA1130	110	DA1245	111	DA2118	48
575580PY	115	BTR9712LOY	72	DA1131	154, 158, 159, 185	DA1246	111	DA2121	49
575580PY-YELLOW	115	BTR9712PMA	72	DA1132	185	DA1247	111	DA2122	53
606683S	142	CAB500070PMA	27	DA1133	185	DA1248	111	DA2123	48
606696S	142	CAB500130PMA	27	DA1134	185	DA1249	111	DA2123A	48
90577434PY	115	CARRIER BAG	197	DA1135	185	DA1252	151	DA2124	72
90577434YELLOW	115	CAS000150PMA	12	DA1136	185	DA1253	151	DA2125	50, 52
AAP817	148	CAS100900	12	DA1137	185	DA1254	195	DA2126	105
AEU2147LX	145	CAS100910	12	DA1138	185	DA1257	185	DA2126A	105
AFP710120SS	186	CAS100920	12	DA1139	185	DA1300	147	DA2128	11
AGP780020LR	24	CAS100930	12	DA1140	14	DA1301	147	DA2129	53
ALR1742	154	CAS500010PCL	12	DA1141	96, 141	DA1307	14	DA2130	11
ALR1743	154	CAS500060PMA	12	DA1142	185	DA1308	14	DA2133	53
ALR5822	155	CAS500070PCL	12	DA1142B	185	DA1357	185	DA2134	50, 52
ALR5823	155	CAS500180PMA	12	DA1143	42	DA1810	67	DA2136	49
ALR6121	154	CAS500190PMA	12	DA114412V	42	DA1960	14	DA2137	49
ALR6122	154	CAT000180PMA	12	DA114424V	42	DA1961	14	DA2138	50

# Part Number Finder

Part No.	Page No.	Part No.	Page No.	Part No.	Page No.	Part No.	Page No.	Part No.	Page No.
DA2141	145	DA2385G	141	DA2471	37	DA2823BLACK	63	DA3164G	140
DA2142	148	DA2386	141	DA2472	37	DA2823SAND	63	DA3164P	140
DA2142G	148	DA2386G	141	DA2473	37	DA2825SAND	64	DA3165	140
DA2143	148	DA2387	141	DA2474	37	DA2828BLACK	63	DA3165G	140
DA2143G	148	DA2387G	141	DA2475	37	DA2829BLACK	64	DA3165P	140
DA2144G	148	DA2388	141	DA2476	37	DA2830BLACK	64	DA3166	140
DA2148	67	DA2388G	141	DA2477	37	DA2831BLACK	64	DA3166G	140
DA2149	66	DA2389	96, 141	DA2478	37	DA2832BLACK	63	DA3166P	140
DA2153	196	DA2390	32, 74	DA2479	147	DA2838BLACK	63	DA3167	140
DA2155	148	DA2391	165	DA2479G	147	DA2839BLACK	64	DA3167G	140
DA2156	158	DA2392	32, 74	DA2479LR	147	DA2839SAND	64	DA3167P	140
DA2157	196	DA2394	74	DA2480	72	DA2988	191	DA3169	140
DA2160BLACK	196	DA2395	151	DA2481	72	DA2990	25	DA3169P	140
DA2160BLUE	196	DA2396	154	DA2482	72	DA2991	25	DA3170B	103
DA2160GREEN	196	DA2397	154	DA2483	72	DA2993	25	DA3171B	103
DA2161BLACK	196	DA2398	154	DA2484	72	DA2996	25	DA3173B	103
DA2161BLUE	196	DA2399	154	DA2485	72	DA2997	179	DA3174B	103
DA2161BROWN	196	DA2400150S	99	DA2486	72	DA3000	32	DA3175B	103
DA2161GREEN	196	DA240040S	99	DA2487	72	DA3002	25	DA3176B	103
DA2162	196	DA2400S	99	DA2488	37	DA3010	45	DA3177B	103
DA2163	196	DA2401150S	99	DA2489	37	DA3010B	45	DA3178	140
DA2166	77	DA240140S	99	DA2490	72	DA3015	82	DA3178G	140
DA2170	77	DA2401S	99	DA2491	72	DA3016	157	DA3178P	140
DA2171	77	DA2402150S	99	DA2492	72	DA3017	157	DA3179	140
DA2172	77	DA240240S	99	DA2493	72	DA3018	82	DA3179G	140
DA2174	78	DA2402S	99	DA2494	72	DA3020	82	DA3179P	140
DA2178	140	DA240340S	99	DA2495	72	DA3021	82	DA3180	140
DA2182	77	DA240440S	99	DA2496	72	DA3022	82	DA3180G	140
DA2186	112	DA240540	99	DA2497	72	DA3023	82	DA3180P	140
DA2194	48	DA240640S	99	DA2505	145	DA3024	82	DA3181	140
DA2195	48	DA240740S	99	DA2506	145	DA3025	82	DA3181P	140
DA2196	48	DA240940S	99	DA2508	145	DA3026	82	DA3182B	103
DA2197	48	DA2409S	99	DA2602	50, 53	DA3028	93	DA3183	103
DA2198	114	DA2410150S	99	DA2603	67, 186	DA3029	93	DA3184	103
DA2200	114	DA241040S	99	DA2603CF	67, 186	DA3030	93	DA3185	85
DA2202	114	DA2410S	99	DA2605	48	DA3031	93	DA3187	35
DA2203	114	DA2411150S	99	DA2610	186	DA3032	93	DA3188B	191
DA2204	114	DA241140S	99	DA2800BLACK	63	DA3033	93	DA3189	190
DA2206	105	DA2411S	99	DA2800BLUE	63	DA3034	93	DA3190	140
DA2210	140	DA2412150S	99	DA2800GREEN	63	DA3035	190	DA3191	140
DA2211	140	DA241240S	99	DA2800GREY	63	DA3036	190	DA3192	140
DA2215	32	DA2412S	99	DA2800SAND	63	DA3040	190	DA3193	140
DA2220	114	DA2413	99	DA2801BLACK	63	DA3041	190	DA3194	140
DA2225	81	DA2413150S	99	DA2801BLUE	63	DA3042	190	DA3195	140
DA2228	15	DA241340S	99	DA2801GREEN	63	DA3044	190	DA3196	140
DA2231	80	DA2413S	99	DA2801GREY	63	DA3048	190	DA3197	140
DA2232	32	DA241440S	99	DA2802GREEN	63	DA3049	105	DA3198	140
DA2243	78	DA2414S	99	DA2802GREY	63	DA3049AF	105	DA3199	140
DA2243EYE	78	DA241840S	99	DA2803BLACK	64	DA3049KD	105	DA3201	32
DA2244	78	DA2418S	99	DA2803BLUE	64	DA3050	151	DA3202	191
DA2246	93	DA2419	99	DA2803GREY	64	DA3051	151	DA3203	111
DA2248	78	DA241940S	99	DA2803SAND	64	DA3052	151	DA3250	107
DA2249	15	DA2419S	99	DA2804BLUE	64	DA3054	151	DA3251	107
DA2250B	15	DA242040S	99	DA2804GREEN	64	DA3055	151	DA3252	107
DA2274	32	DA2420S	99	DA2804GREY	64	DA3056	16	DA3253	107
DA2274CABLE	32	DA2421	99	DA2804SAND	64	DA3057	16	DA3254	107
DA2301	11	DA242140	99	DA2805GREEN	64	DA3057GLUE	16	DA3255	107
DA2310	26	DA242140S	99	DA2805GREY	64	DA3058	151	DA3256	107
DA2311	26	DA2421S	99	DA2806BLUE	64	DA3059	70	DA3257	107
DA2312	26	DA2425	115	DA2807BLACK	63	DA3059LCS	70	DA3258	107
DA2315	26	DA2426	115	DA2807BLUE	64	DA3059RPI	70	DA3259	107
DA2342L	187	DA2427	151	DA2807GREEN	63	DA3059T	70	DA3260	107
DA2342R	187	DA2428	151	DA2807GREY	63	DA3069	82	DA3262	107
DA2343R	187	DA2430	38	DA2807SAND	63	DA3070	27	DA3269	27
DA2344	187	DA2431	38	DA2808BLACK	63	DA3072	27	DA3270	29
DA2351	67	DA2432	38	DA2808BLUE	63	DA3073	24	DA3271	24, 29
DA2352	149	DA2433	38	DA2808GREEN	63	DA3073B	24	DA3300	98
DA2353	114	DA2434	38	DA2808GREY	63	DA3075	26	DA3301	98
DA2353G	114	DA2435	38	DA2808SAND	63	DA3077	26	DA3302	98
DA2354	32, 74	DA2436	38	DA2809BLUE	63	DA3081	6	DA3303	98
DA2355	149	DA2437	38	DA2809GREEN	63	DA3086	26	DA3304	98
DA2356	185	DA2438	38	DA2809GREY	63	DA3106	190	DA3306	98
DA2356B	185	DA2439	38	DA2810BLACK	64	DA3120	78	DA3307	98
DA2357	150	DA2440	72	DA2810GREY	64	DA3121	79	DA3308	98
DA2357CP	150	DA2441	72	DA2811BLACK	64	DA3122	79	DA3309	98
DA2357G	150	DA2442	72	DA2811GREY	64	DA3130	79	DA3310	98
DA2357HD	150	DA2443	72	DA2812BLUE	64	DA3136	102	DA3311	98
DA2357HDG	150	DA2444	72	DA2812GREEN	64	DA3137	102	DA3312	98
DA2362	112	DA2445	72	DA2812GREY	64	DA3138	101	DA3313	98
DA2363	112	DA2446	72	DA2813BLACK	64	DA3139	101	DA3314	98
DA2364	14	DA2447	72	DA2813GREEN	64	DA3140	171	DA3315	98
DA2365	14	DA2450	38	DA2813GREY	64	DA3141	82	DA3316	98
DA2366	14	DA2451	38	DA2814BLUE	64	DA3142	82	DA3317	98
DA2369	150	DA2452	38	DA2814GREY	64	DA3143	145	DA3318	98
DA2370	150	DA2453	38	DA2815BLACK	63	DA3144	114	DA3319	98
DA2372	121	DA2454	38	DA2815BLUE	63	DA3145	145	DA3340	108
DA2373	121	DA2455	38	DA2815GREEN	63	DA3147	190	DA3350	179
DA2374	82	DA2456	38	DA2815GREY	63	DA3148	190	DA3351	179
DA2376	147	DA2457	38	DA2816BLACK	63	DA3149	190	DA3352	179
DA2379	141	DA2458	38	DA2816BLUE	63	DA3153	79	DA4000	185
DA2379G	141	DA2459	38	DA2816GREY	63	DA3154	79	DA4000S	185
DA2380	141	DA2460	38	DA2817BLUE	63	DA3155	79	DA4001	185
DA2380G	141	DA2461	38	DA2817GREY	63	DA3156	93, 190	DA4001S	185
DA2381	141	DA2462	158	DA2818BLACK	63	DA3157	190	DA4007N	157
DA2381G	141	DA2463	158	DA2818GREY	63	DA3160	93	DA4007O	157
DA2382	141	DA2464	158	DA2818SAND	63	DA3160A	93	DA4008N	155, 157
DA2382G	141	DA2465	158	DA2819BLACK	64	DA3161	190	DA4008O	155, 157
DA2383	141	DA2466	68	DA2819SAND	64	DA3162	190	DA4013N	157
DA2383G	141	DA2467	157	DA2820BLACK	64	DA3163	140	DA4013O	157
DA2384	141	DA2468	157	DA2821BLACK	64	DA3163G	140	DA4015N	157
DA2384G	141	DA2469	157	DA2822BLACK	63	DA3163P	140	DA4015O	157
DA2385	141	DA2470	157	DA2822SAND	63	DA3164	140	DA4016N	157



Part No.	Page No.	Part No.	Page No.	Part No.	Page No.	Part No.	Page No.	Part No.	Page No.
DA40160	157	DA4148	98	DA4285	124	DA4377KN	102	DA4587	80
DA4017	158	DA4149	98	DA4285C	124	DA4378	101	DA4588	190
DA4018N	158	DA4150	98	DA4286	124	DA4378KN	102	DA4589	69
DA4018O	158	DA4151	97	DA4286C	124	DA4379	101	DA4590	69
DA4019	154	DA4152	97	DA4286CHD	124	DA4395	106	DA4591	69
DA4020	154	DA4153	98	DA4286CMD	124	DA4396	48, 107	DA4592	69
DA4022BLACK	60	DA4154	98	DA4286HD	124	DA4397	106, 107	DA4593	69
DA4023BLACK	60	DA4155	98	DA4286MD	124	DA4398	40, 41	DA4594	69
DA4023BLUE	60	DA4156	98	DA4287	124	DA4399	40, 41	DA4595	69
DA4023GREY	60	DA4157	98	DA4287C	124	DA4400	8	DA4596	69
DA4025BLACK	196	DA4158	97	DA4288	124	DA4404	11	DA4600	96
DA4025BLUE	196	DA4159	98	DA4288C	124	DA4405	11	DA4601	96
DA4025BROWN	196	DA4160	119, 123	DA4288CHD	124	DA4406	11	DA4602	96
DA4025GREEN	196	DA4162	119	DA4288CMD	124	DA4407	11	DA4603	96
DA4026	34	DA4163	119	DA4288HD	124	DA4408	11	DA4604	96
DA4027	56	DA4165	97	DA4288MD	124	DA4409	11	DA4605	96
DA4028	69	DA4169	59	DA4289	124	DA4418	104	DA4606	96
DA4029	69	DA4170	59	DA4289C	124	DA4419	104	DA4607	96
DA4030	52	DA4171	59	DA4289CHD	124	DA4420	104	DA4608	96
DA4031	69	DA4172	9	DA4289CMD	124	DA4421	104	DA4609	96
DA4032	154, 158, 159	DA4173	10	DA4289HD	124	DA4422	61	DA4610	96
DA4032-3SEAL	154, 158, 159	DA4178	148	DA4289MD	124	DA4423	61	DA4611	96
DA4032GREY	154, 158, 159	DA4178RESISTOR	148	DA4290	107	DA4424	61	DA4612	96
DA4033	154, 158, 159	DA4179	120	DA4291	107	DA4425	61	DA4613	96
DA4033BRONZE	154, 158, 159	DA4180	120	DA4292	107	DA4426	61	DA4614	96
DA4033CATCH	154, 158, 159	DA4181	119	DA4293	107	DA4427	61	DA4615	96
DA4033GREEN	154, 158, 159	DA4183	58	DA4294	107	DA4428	61	DA4616	96
DA4033GREY	154, 158, 159	DA4185	98	DA4295	107	DA4429	61	DA4617	96
DA4034	11	DA4186	165	DA4296	6	DA4430	61	DA4618	96
DA4035BLUE	114	DA4187	97	DA4297	6	DA4431	61	DA4619	96
DA4036BLUE	114	DA4188	97	DA4298	70	DA4433	104	DA4622	96
DA4041	69	DA4189	147	DA4299	124	DA4434	104	DA4623	96
DA4042	69	DA4190	75	DA4299C	124	DA4435	104	DA4624	96
DA4049	6	DA4191	75	DA4300	124	DA4436	104	DA4625	96
DA4049B	6	DA4192	75	DA4300C	124	DA4437	105	DA4626	96
DA4049S	6	DA4193	75	DA4301	124	DA4470	58	DA4627	96
DA4054	158	DA4194	75	DA4301C	124	DA4472	97	DA4629	187
DA4055	69	DA4197	122	DA4302	107	DA4473	97	DA4630	102
DA4056	69	DA4198	122	DA4303	107	DA4474	97	DA4631	102
DA4057	69	DA4199	122	DA4304	107	DA4475	97	DA4632	102
DA4058	79	DA4201	122	DA4305	70	DA4476	97	DA4633	102
DA4059	79	DA4202	122	DA4306	107	DA4477	97	DA4634	102
DA4060	18	DA4203	122	DA4310	195	DA4478	98	DA4635	102
DA4061	79	DA4204	122	DA4311	26	DA4479	98	DA4636	190
DA4062	165	DA4205	122	DA4312	26	DA4480	98	DA4637	101
DA4063	165	DA4206	122	DA4314	26	DA4481	98	DA4650	187
DA4064	165	DA4208	122	DA4316	26	DA4482	98	DA4654	187
DA4065N	154, 158	DA4210	119	DA4317	26	DA4483	98	DA4659	187
DA4065O	154, 158	DA4211	119	DA4319	26	DA4484	98	DA4660	187
DA4067	70	DA4221	106	DA4323	25	DA4485	98	DA4661	187
DA4070	18	DA4222	106	DA4324	25	DA4486	98	DA4663	176
DA4070B	18	DA4223	106	DA4325	25	DA4487	98	DA4664	187
DA4071	6	DA4223S	107	DA4326	25	DA4488	97	DA4667	105
DA4071B	6	DA4224	106	DA4327	25	DA4493	190	DA4679	187
DA4072	6	DA4225	107	DA4328	25	DA4496	97	DA4702	28
DA4072B	6	DA4226	106	DA4329	25	DA4497	105	DA4703	28
DA4073	6	DA4227	106	DA4330	25	DA4500	148	DA4704	28
DA4073B	6	DA4228	106	DA4331	26	DA4501	60	DA4705	28
DA4074	6	DA4229	106	DA4332	26	DA4502	60	DA4706	28
DA4075	70	DA4230	107	DA4333	26	DA4503	58	DA4707	28
DA4075RPI	70	DA4231	106	DA4335	97	DA4505	190	DA4708	28
DA4075T	70	DA4232	106	DA4336	97	DA4506	190	DA4709	28
DA4077	8	DA4233	106	DA4337	97	DA4508	154, 155, 157	DA4710	24, 28
DA4086	154, 158	DA4234	106	DA4338	97	DA4509	154, 155, 157	DA4711	28
DA4088	40	DA4235	106	DA4339	97	DA4511	13	DA4712	28
DA4088BULB	40	DA4236	107	DA4340	97	DA4512	32	DA4713	28
DA4088C	40	DA4237	106	DA4341	97	DA4513	154, 155, 157	DA4714	28
DA4088COVER	40	DA4238	106	DA4342	6	DA4514	154, 155, 157	DA4715	28
DA4088W	40	DA4239	106	DA4343	6	DA4515	154, 155, 157	DA4718	28
DA4090	119	DA4240	106	DA4344	75	DA4516	154, 155, 157	DA4719	28
DA4092	119	DA4241	106	DA4348	107	DA4518	154, 155, 157	DA4720	28
DA4099	40	DA4242	107	DA4349	8, 178, 181	DA4519	155	DA4721	28
DA4100	6	DA4243	107	DA4350	78	DA4527	154, 155, 157	DA4722	28
DA4100B	6	DA4243EXT	107	DA4351	78	DA4528	106	DA4800	61
DA4101	18	DA4244	106	DA4352	78	DA4530	155	DA4801	61
DA4102	144	DA4245	107	DA4353	78	DA4531	12	DA4802	61
DA4102RED	144	DA4246	106	DA4354	78	DA4532	12	DA4803	61
DA4104	144	DA4247	107	DA4355	78	DA4533	12	DA4804	61
DA4104RED	144	DA4249	107	DA4356	78	DA4534	12	DA4805	61
DA4105	141	DA4250DIS	146	DA4357	78	DA4535	12	DA4806	61
DA4106	121	DA4251	106	DA4358	78	DA4536	12	DA4807	61
DA4107	121	DA4259	101	DA4359	107	DA4537	107	DA4808	61
DA4118	24	DA4260	101	DA4360	75	DA4538	105	DA4809	61
DA4119	24	DA4261	101	DA4361	75	DA4540	106	DA4810	16
DA4120	45	DA4262	101	DA4362	75	DA4545	77	DA4811	16
DA4120N	157	DA4263	101	DA4363	124	DA4546	77	DA4812	61
DA4120O	157	DA4264	101	DA4364	124	DA4547	77	DA4813	61
DA4121	24	DA4265	101	DA4365	124	DA4548	77	DA4814	18
DA4133	8	DA4266	101	DA4366	124	DA4549	97	DA4817	195
DA4134	8	DA4267	101	DA4367	124	DA4550	97	DA4818	18
DA4136	120	DA4268	101	DA4368	124	DA4551	97	DA4820	61
DA4136BUSH	120	DA4269	101	DA4371	107	DA4552	97	DA4821	61
DA4136EAS	120	DA4270	101	DA4372	107	DA4558	190	DA4822	59, 177
DA4136FR	120	DA4272	101	DA4373	154	DA4560	97	DA4823	61
DA4136HD	120	DA4273	102	DA4373S	154	DA4563	121	DA4824	61
DA4136HDFR	120	DA4274	101	DA4374	154	DA4564	121	DA4825	59
DA4136HRRR	120	DA4275	102	DA4374S	154	DA4565	190	DA5004	34
DA4136RR	120	DA4277	122	DA4375	101	DA4566	190	DA5004S	34
DA4141	57	DA4278	122	DA4375KN	102	DA4577	103	DA5005	34
DA4143	154	DA4279	122	DA4376	101	DA4582	103	DA5005S	34
DA4144	154	DA4284	124	DA4376KN	102	DA4586N	155	DA5006	34
DA4147	97	DA4284C	124	DA4377	101	DA4586O	155	DA5006S	34

# Part Number Finder

Part No.	Page No.	Part No.	Page No.	Part No.	Page No.	Part No.	Page No.	Part No.	Page No.
DA5007	120	DA5558	150	DA6013	161	DA6082	100	DA6253	33, 75
DA5008	120	DA5559	150	DA6013P	161	DA6084	100	DA6254	75
DA5010	119	DA5600	80	DA6014	161	DA6085	163	DA6259	170
DA5011	119	DA5601	80	DA6014LR	161	DA6085G	163	DA6260	166
DA5012	119	DA5602	59	DA6014P	161	DA6086	162, 163	DA6261	166
DA5014	43	DA5604	92	DA6015	161	DA6086LR	162, 163	DA6262	166
DA5015	43	DA5607	79	DA6015LR	161	DA6086P	162, 163	DA6263	166
DA5016	43	DA5609	92	DA6015P	161	DA6087	162, 162	DA6264	166
DA5018	44	DA5610	71	DA6016	162	DA6087LR	162, 162	DA6265	166
DA5019	44	DA5611	71	DA6017	162	DA6087P	162, 162	DA6266	166
DA5020	44	DA5614	71	DA6018	162	DA6088	162, 163	DA6267	166
DA5021	44	DA5615	71	DA6019	162	DA6088LR	162, 163	DA6268	166
DA5022	24	DA5616	71	DA6020	162	DA6088P	162, 163	DA6269	166
DA5023	24, 48	DA5617	71	DA6021	162	DA6089	163	DA6270	166
DA5024	43	DA5618	71	DA6022	162	DA6089LR	163	DA6271	166
DA5025	48	DA5619	71	DA6023	162	DA6089P	163	DA6272	166
DA5026	46, 171	DA5620	92	DA6024	162	DA6090	163	DA6273	166
DA5027	46, 171	DA5621	92	DA6025	162	DA6090LR	163	DA6274	166
DA5028	77	DA5621K	92	DA6026	162	DA6090P	163	DA6275	166
DA5029	77	DA5622	92	DA6027	162	DA6091	163	DA6280K	44
DA5030	52	DA5623	92	DA6027P	162	DA6091LR	163	DA6281K	44
DA5031	77	DA5624	45	DA6028	162	DA6091P	163	DA6286	167
DA5032	77	DA5625	15	DA6028P	162	DA6092	163	DA6287	167
DA5033	77	DA5626	7	DA6029	162	DA6092LR	163	DA6287G	168
DA5034	120	DA5627	70	DA6029P	162	DA6092P	163	DA6288	167
DA5035	151	DA5628	70	DA6030	162	DA6093	16	DA6289	167
DA5038	151	DA5629	70	DA6030LR	162	DA6094	16	DA6290	179
DA5039	151	DA5630	70	DA6030P	162	DA6095	163	DA6291	167
DA5040	30	DA5631	173	DA6031	162	DA6095LR	163	DA6292	167
DA5041	30	DA5632	70	DA6031LR	162	DA6095P	163	DA6293	167
DA5042	30	DA5633	70	DA6031P	162	DA6096LR	163	DA6294	167
DA5043	30	DA5634	70	DA6032	161	DA6096P	163	DA6300	169
DA5044	30	DA5635	70	DA6033	161	DA6097	163	DA6301	169
DA5045	30	DA5636	70, 71	DA6034	161	DA6097LR	163	DA6303	169
DA5046	30	DA5643	92	DA6035	162, 163	DA6097P	163	DA6304	169
DA5047	30	DA5645	92	DA6035LR	162, 163	DA6098	163	DA6305	169
DA5048	30	DA5646	13	DA6035P	162, 163	DA6098LR	163	DA6306	169
DA5049	30	DA5647	13	DA6036	163	DA6098P	163	DA6307	169
DA5050	30	DA5653	177	DA6036LR	163	DA6099	163	DA6309	169
DA5100	48	DA5654	177	DA6036P	163	DA6099LR	163	DA6310	169
DA5101	66	DA5655	177	DA6037	162, 163	DA6099P	163	DA6311	169
DA5102	66	DA5658	179, 181	DA6037LR	162, 163	DA6100	154	DA6312	169
DA5103	66	DA5659	179	DA6037P	162, 163	DA6101	154	DA6313	169
DA5104	66	DA5660	179	DA6038	161	DA6102	154	DA6314	169
DA5105	66	DA5661	179, 181	DA6038LR	161	DA6103	154	DA6316	169
DA5106	66	DA5662	181	DA6038P	161	DA6104	154	DA6317	169
DA5108	177	DA5663	182	DA6039	161	DA6106	163	DA6318	169
DA5109	66	DA5664	181	DA6039LR	161	DA6107	16	DA6319	169
DA5111	66	DA5667	179	DA6039P	161	DA6108	16	DA6322	112
DA5112	66	DA5668	179	DA6040	161	DA6109LR	161	DA6322L	112
DA5113	66	DA5669	181	DA6040LR	161	DA6109P	161	DA6323	112
DA5114	66	DA5670	181	DA6040P	161	DA6200	170	DA6323L	112
DA5115	66	DA5671	159	DA6041	162	DA6201	170	DA6324	112
DA5116	66	DA5672	159	DA6041LR	162	DA6202	170	DA6326	169
DA5117	66	DA5678	7, 41	DA6041P	162	DA6203	170	DA6327	169
DA5118	66	DA5679	40, 41	DA6042	141	DA6204	170	DA6328	169
DA5120	146	DA5681	92, 153	DA6043	141	DA6205	170	DA6337	112
DA5121	146	DA5699	92, 185	DA6044	141	DA6206	170	DA6338	112
DA5121AE	146	DA5700	76	DA6045	141	DA6207	170	DA6339	123
DA5122	67	DA5701	76	DA6046	141	DA6208	170	DA6341	112
DA5123	67	DA5704	76	DA6047	141	DA6209	170	DA6342	112
DA5124	67	DA5705	76	DA6048	163	DA6210	170	DA6343	34
DA5130	154	DA5706	76	DA6048LR	163	DA6211	170	DA6344	112
DA5131	154	DA5709	76	DA6048P	163	DA6212	170	DA6345	112
DA5136	120	DA5710	76	DA6049	114	DA6213	170	DA6348	170
DA5137	120	DA5711	76	DA6050	149	DA6214	170	DA6350	123
DA5138	66	DA5712	76	DA6051	149	DA6215	170	DA6351	123
DA5139	66	DA5713	76	DA6052	149	DA6216	170	DA6352	123
DA5140	66	DA5714	146	DA6053	149	DA6217	170	DA6353	123
DA5141	66	DA5717	72, 186	DA6054	149	DA6218	170	DA6354	123
DA5300	153, 154	DA5801	56	DA6055	149	DA6219	170	DA6355	123
DA5498	68, 186	DA5803	57	DA6056	149	DA6220	170	DA6356	123
DA5499	68, 186	DA5804	57	DA6057	149	DA6221	170	DA6363	169
DA5500	186	DA5805	57	DA6058	149	DA6222	170	DA6364	169
DA5501	123	DA5806	57	DA6059	149	DA6223	170	DA6365	169
DA5502	123	DA5807	57	DA6060	149	DA6224	170	DA6366	169
DA5503	123	DA5808	57	DA6061	149	DA6225	170	DA6367	157
DA5504	123	DA5810	57	DA6062	149	DA6226	170	DA6399	128
DA5505	111	DA5811	57	DA6063	149	DA6227	170	DA6400	128
DA5506	111	DA6000	161	DA6064	149	DA6228	170	DA6401	128
DA5507	15	DA6001	161	DA6065	162	DA6229	170	DA6403	128
DA5507LHD	15	DA6001P	161	DA6065LR	162	DA6230	170	DA6404	128
DA5508	15	DA6002	161	DA6065P	162	DA6231	170	DA6405	128
DA5509	123	DA6002P	161	DA6066	162	DA6232	170	DA6406	128
DA5510	111	DA6003	161	DA6066LR	162	DA6233	170	DA6407	128
DA5511	56	DA6003P	161	DA6066P	162	DA6234	170	DA6408	128
DA5513	99	DA6004	161, 162	DA6067	162	DA6235	170	DA6409	128
DA5526	99	DA6004LR	161, 162	DA6067LR	162	DA6236	170	DA6410	128
DA5537	99	DA6004P	161, 162	DA6067P	162	DA6237	170	DA6411	128
DA5538	56	DA6005	162	DA6068LR	162	DA6238	170	DA6412	128
DA5539	56	DA6005P	162	DA6068P	162	DA6239	170	DA6413	128
DA5540	13	DA6006	162	DA6070	16	DA6240	170	DA6414	128
DA5550	150	DA6006P	162	DA6071	16	DA6241	170	DA6415	128
DA5550G	150	DA6007	162	DA6072	16	DA6242	170	DA6416	128
DA5551	150	DA6007P	162	DA6073	16	DA6243	170	DA6417	128
DA5551G	150	DA6008	162	DA6074	16	DA6244	170	DA6418	128
DA5551KIT	150	DA6009	162	DA6075	16	DA6245	170	DA6419	128
DA5552	150	DA6010	162	DA6076	16	DA6247	151	DA6420	119, 128
DA5554	59	DA6010LR	162	DA6077	16	DA6250	150	DA6421	119, 128
DA5555	59	DA6010P	162	DA6078	16	DA6250G	150	DA6423	119, 128
DA5556	59	DA6011	161	DA6080	100	DA6251	150	DA6424	119, 128
DA5557	59, 183	DA6012	161	DA6081	100	DA6252	75	DA6425	119, 128

Part No.	Page No.	Part No.	Page No.	Part No.	Page No.	Part No.	Page No.	Part No.	Page No.
DA6426	119, 128	DA7536	15	DB1319	91	DC7110	115	KBM100540	33
DA6427	119, 128	DA7537	92	DB1319R	91	DC7111	115	KBP10001	33
DA6428	119, 128	DA7538	92	DB1320	91	DC7112	113	KNB100640	48
DA6429	119, 128	DA7602	179, 181	DB1320R	91	DC7113	113	KNB500070	50, 52
DA6430	130	DA7610	179, 181, 182	DB1321	91	DC8000	116	KNK500060	51
DA6430ESP	130	DA7611	179, 181, 182	DB1321R	91	DC8001	116	KNK500070	51
DA6430FRA	130	DA8000	192	DB1322	93	DEFENDER STICKER	197	KNK500080	51
DA6430GER	130	DA8002	192	DB1323	93	DGJ500020PCL	14	KVB000290	154
DA6431	130	DA8003	192	DB1324	91	DKC500010PMD	196	KVB500060	154
DA6431ESP	130	DA8004	192	DB1324R	91	DPB000270	7	KVB5000230	154
DA6431FRA	130	DA8005	192	DB1325	91	DPB000270GALV	7, 153	KVD500710-M	153
DA6431GER	130	DA8006	192	DB1325R	91	DPT100070	185	KVD500730	153
DA6432	130	DA8007	192	DB1327	90	EAH000261PMA	62	KVL100040	19
DA6433	130	DA8008	192	DB1328	90, 94	EAH000271PMA	62	LANDY	191
DA6433EU	130	DA8009	192	DB1328H	90	EAH000300JMN	62	LANDY NEW HOME	191
DA6434	130	DA8010	192	DB1329	93	EAH000300PVA	62	LCJ000050LKIT	145
DA6439	129	DA8011	192	DB1330	90	EAH000300SUN	62	LDF500180COM	145
DA6440	151	DA8012	192	DB1331	90	EAH000310JMN	62	LOGOBOARD	197
DA6441	165	DA8013	192	DB1332	90	EAH000310LUP	62	LR002408	11, 182
DA6500	77	DA8015	192	DB1334	90	EAH000310SUN	62	LR002417	27
DA6537	27	DA8016	192	DB1336	90	EAH500011LUP	62	LR002424	58
DA6540	15	DA8017	192	DB1337	90	EAH500011PVJ	62	LR002464	182
DA6600	186	DA8018	192	DB1338	90	EAH500015SMS	62	LR002485	62
DA6800	173	DA8019	192	DB1339	90	EAH500050PMA	62	LR002497	62
DA6801	173	DA8020	192	DB1340	90	EAH500051PMA	62	LR002516	58
DA6802	173	DA8021	192	DB1341	90, 92	EAH500052PMA	62	LR002521	56
DA7011	18	DA8023	192	DB1343	90	EAH500057PMA	62	LR002525	182
DA7011SS	18	DA8023PACK	197	DB1344	91	EAH500058PMA	62	LR002748	167
DA7012	18	DA8024	192	DB1344R	91	EAH500080PVJ	62	LR002773	20, 182
DA7012SS	18	DA8025	192	DB1345	91	EAH500100PMA	62	LR003156	167
DA7200	111, 140	DA8026	192	DB1345R	91	EAH500290LUP	62	LR003156G	168
DA7201	111, 140	DA8027	192	DB1346	91	EAH500290PVA	62	LR003318	20, 182
DA7202	111, 140	DA8028	192	DB1346R	91	EAH500290SUN	62	LR003319	7, 182
DA7203	111, 140	DA8029	192	DB1347	91	EAH500320PMA	62	LR003322	12
DA7204	111, 140	DA8036	192	DB1347R	91	EAH500330PMA	62	LR003324	12
DA7205	111, 140	DA8037	192	DB1348	91	EBF000040	58	LR003657	142
DA7206	111, 140	DA8038	192	DB1348R	91	EBF500010	58	LR003657G	143
DA7207	111, 140	DA8040	192	DB1349	91	EBF500020	58	LR003685	11, 182
DA7208	111, 140	DA8041	192	DB1349R	91	EBN500040	179	LR003852	60
DA7211	151	DA8042	192	DB1350	91	EBN500041	181	LR003894	58
DA7301	71	DA8042PACK	197	DB1350R	91	ERC2886V	105	LR003905	177, 179, 181, 182
DA7302	71	DA8043	192	DB1352	90	ERC4536K	144	LR004404S	147
DA7303	71	DA8044	170	DB1352R	90	ERR3340X	145	LR004936	142
DA7304	71	DA8045	192	DB1353	93	ERR5027COM	145	LR004936G	143
DA7305	71	DA8046	192	DB1354	90	ERR6299X	145	LR005039	60
DA7306	71	DA8047	192	DB2000	90	ESR2391S	107	LR005058	64
DA7307	71	DA8048	197	DB6000	89	ESR2740	107	LR005059	64
DA7308	71	DA8049	192	DB8000	89	ESR4238X	145	LR005237LR	7, 181
DA7400	143	DA8897	114	DB9000C	89	ESR4686X	145	LR005239	7, 177
DA7401	143	DA8899	114	DB9000CR	89	EST110075/76KIT	150	LR005615	58
DA7402	143	DA8900	153	DB9500I	88	ETC4291/2/3/4	146	LR005648PY	114
DA7403	143	DA8902N	156	DB9500I24	88	ETC5835K	144	LR005649PY	114
DA7404	143	DA8902O	156	DB9500IR	88	EXTERIOR STICKER	197	LR005919	49
DA7405	143	DA8903	156	DC5000	118	FENDER	191	LR005920	49
DA7406	143	DB1000	93	DC5000L	118	FJL101530PMA	68	LR005921	49
DA7407	143	DB1001	94	DC5001	118	FJL101680PMA	68	LR006237	62
DA7408	143	DB1002	93	DC5001L	118	FJL101710PMA	68	LR006238	62
DA7409	143	DB1003	92	DC5002	118	FTC1507	141	LR006304	179
DA7410	143	DB1004	92	DC5002L	118	FTC2957HD	150	LR006401LR	58
DA7411	143	DB1005	92	DC5003	118	FTC2957HDKIT	150	LR006433	62
DA7412	143	DB1006	93	DC5003L	118	FTC5200HD	150	LR006435	62
DA7413	143	DB1007	93	DC5004	118, 123	FWJ500020PMA	66	LR006437	62
DA7414	143	DB1008	93	DC5005	118, 123	HAD501820RPI	69	LR006847	25
DA7415	143	DB1009	93	DC6000	117	HAD501870RPI	69	LR006848	27
DA7416	143	DB1010	93	DC6000L	117	HAG100970LOY	69	LR006849	27
DA7417	143	DB1011	93	DC6000LL	117	HAH103510LOY	69	LR007205-6BJ	140
DA7418	143	DB1012	93	DC6001	117	HAI101400LOY	69	LR007221	49
DA7419	143	DB1014	94	DC6001L	117	HAI101410LOY	69	LR007222	49
DA7420	143	DB1015	94	DC6001LL	117	HBA106180LOY	69	LR007223	49
DA7421	143	DB1016	93	DC6002	117	HBA106190LOY	69	LR007320	57
DA7422	143	DB1017	94	DC6003	117	HBD000320JMN	64	LR007484	50, 52
DA7423	143	DB1017P	94	DC6004	117, 123	HBD000320LUP	64	LR007484G	50, 52
DA7424	143	DB1018	84	DC6005	117, 123	HBD000320LYR	64	LR008361	185
DA7425	143	DB1019	84	DC6006	117, 123	HBD000320SUN	64	LR008375	18
DA7426	143	DB1020	84	DC6007	117	HCA106010LOY	69	LR008375SS	18
DA7427	143	DB1021	84	DC6009	117, 123	HHD102280	69, 71	LR008379	18
DA7428	143	DB12000I	88	DC6010	117	HHD102290	69, 71	LR008379SS	18
DA7429	143	DB12000I24	88	DC6011	117	IAB500104E	152	LR008556	150
DA7430	143	DB12000IR	88	DC7000	115	INTERIOR STICKER	197	LR008713	179, 181
DA7431	143	DB1300	90	DC7001	115	ISG000040	13	LR008913	42
DA7432	143	DB1301	90	DC7002	115	ISG000050	13	LR008975	42
DA7433	143	DB1302	90	DC7003	115	IYK500010	167	LR008982	42
DA7434	143	DB1303	90	DC7004	115	JAK000065MMM	181	LR009792	42
DA7435	143	DB1304	90	DC7005	115	JAK500300LQV	177	LR010673	140
DA7436	143	DB1307	90, 92	DC7006	115	JAK500310LQV	177	LR010674	140
DA7437	143	DB1308	93	DC7007	115	JAK500320WWH	179	LR011870	34
DA7438	143	DB1308-24V	93	DC7008	115	JAK500330WWH	179	LR011870HD	34
DA7439	143	DB1309	94	DC7009	115	JEF100150	148	LR012199	150
DA7440	143	DB1310	91	DC7010	115	JEF100220	148	LR012199C	150
DA7441	143	DB1310GALV	91	DC7011	115	JFC102550B	43	LR012199P	150
DA7442	143	DB1310R	91	DC7012	113	JAK500020X	145	LR014147	141
DA7443	143	DB1310RGALV	91	DC7013	113	KAH000050	79	LR015089	116, 140
DA7460	172	DB1313	91	DC7100	115	KAJ100571	79	LR015303	116, 140
DA7530	15	DB1313-24V	91	DC7101	115	KBM100450	33	LR015519	142
DA7530B	15	DB1313GALV	91	DC7102	115	KBM100460	33	LR015519G	143
DA7531	80, 113	DB1313R	91	DC7103	115	KBM100470	33	LR017770	60
DA7532	15	DB1313RGALV	91	DC7104	115	KBM100480	33	LR019618	142
DA7533	14, 19	DB1314	94	DC7105	115	KBM100490	33	LR019618G	143
DA7534	14	DB1315	92	DC7106	115	KBM100500	33	LR019627	142
DA7534B	14	DB1316	92	DC7107	115	KBM100510	33	LR019627G	143
DA7535	15	DB1317	92	DC7108	115	KBM100520	33	LR019727	167
DA7535B	15	DB1318	94	DC7109	115	KBM100530	33	LR019727LR	168

# Part Number Finder

Part No.	Page No.	Part No.	Page No.	Part No.	Page No.	Part No.	Page No.	Part No.	Page No.
LR020362	142	LR059127	185	MXC2063	157	RGX500101PY	114	SFP000250G	143
LR020362G	143	LR059128	185	MXC2064	157	RGX500111PY	114	SFP000260	142
LR021253	142	LR059129	185	MXC3918	157	RGX500121PY	114	SFP000260G	143
LR021253G	143	LR061295	50	MXC3919	157	RGX500131PY	114	SFP000270	142
LR021316	142	LR061888	116, 140	MXC5587	12	RGX500290PY	114	SFP000270G	143
LR021316G	143	LR064181	142	MXC6412	12	RGX500300PY	114	SFP000280	142
LR021899	142	LR064181G	143	MXC6413	12	RKB101200	121	SFP000280G	143
LR021899G	143	LR065492	142	NGC103740/810	144	RKB101460	121	SFP100360	142
LR023391BLK	36	LR065492G	143	NGC103740/810RED	144	RNF100090PY	115	SFP100360G	143
LR023888	142	LRCEAHUEB	193	NGC500370/410	144	RNF100090YELLOW	115	SFP500010	142
LR023888G	143	LRCEAHUEG	193	NRC2051	48	ROA000022PY	114	SFP500010G	143
LR023889	165	LRCEAHUEW	193	NRC236	158	ROA100050PY	114	SFP500070	142
LR023964	116, 140	LRDCA3EVOQ	193	NRC236E	158	RRB100370	33	SFP500070G	143
LR025111	116, 140	LRDCA405	193	NRC4171GALV	153, 154	RRB100510	33	SFP500120	142
LR025159PY	114	LRDCA494	193	NRC4356	153	RRB500100	33	SFP500120G	143
LR025610GK	111	LRDCA494G	193	NRC4514PY	115	RRC114560MUW	35	SFP500130	142
LR025610K	111	LRDCA5EVOQ	193	NRC4514PY-YELLOW	115	RRC2970	13	SFP500130G	143
LR025613GK	111	LRDCADISCO	193	NRC4642G	153	RRC2971	13	SFP500150	142
LR025613K	111	LRKRAHUE	193	NRC4717	157	RRC501470MCM	36	SFP500150G	143
LR025739	142	LRKRALLK	193	NRC5593PY	115	RRC503400MNH	36	SFP500160	142
LR025739G	143	LRL0087ENG	190	NRC5593PY-YELLOW	115	RRC503600PM	35	SFP500160G	143
LR025862	36	LRL0178ENG	190	NRC6920	81	RRC505360MNH	36	SFP500180	142
LR026221	142	LRO 2798	193	NRC8208	49	RRC505370MNH	36	SFP500180G	143
LR026221G	143	LRS PABACBP	193	NTC1772PY	115	RRC6681	7	SFP500190	142
LR026592	183	LRS PANGL	193	NTC1772PY-YELLOW	115	RRC6682	7	SFP500190G	143
LR026593	183	LRS PANGS	193	NTC1773PY	115	RRC8443	11	SFP500200	142
LR026595	183	LRS PANNL	193	NTC1773PY-YELLOW	115	RRD000011	38	SFP500200G	143
LR026596	183	LRS PANNS	193	NTC1775PY	115	RRD000100	33	SFP500210	142
LR027129	142	LRS PANRRSL	193	NTC1775PY-YELLOW	115	RRD000110	33	SFP500210G	143
LR027129G	143	LRSS12BC1	194	NTCS193PM	35	RRD000120	33	SFS500012KIT	161
LR027309	142	LRSS12BC2	194	NTC6781PY	115	RRD000130	33	SIJ500030	145
LR027309G	143	LRSS12RCCW	193	NTC6781PY-YELLOW	115	RRD100520	33	SIJ500040	165
LR027486	183	LRSS12RHW	193	NTC6828PY	115	RRD100530	33	STC1066	155
LR027664	33	LRSS12RLIPH	193	NTC6828PY-YELLOW	115	RRD100540	33	STC1135	157
LR027666	33	LRSS12RSPH	193	NTC6860PY	115	RRD100550	33	STC1136	157
LR028245GK	111	LRT-12-058	171	NTC6860PY-YELLOW	115	RRD100560	33	STC1172B	145
LR028245K	111	LRT-12-093	172	NTC7307PY	115	RRD100570	33	STC1184K	144
LR028245NB	111	LRT-12-094	172	NTC7307PY-YELLOW	115	RRD100580	33	STC1188	42
LR028249GK	111	LRT-12-158	171	NTC7394PY	115	RRD100590	33	STC1424	154
LR028249K	111	LRT-60-003	137, 171	NTC7394PY-YELLOW	115	RRD100600	33	STC1601	142
LR028249NB	111	LRT-60-004	114, 172	NTC7829	34	RRD100610	33	STC1601G	143
LR029294KIT	18	LRT-64-003	137, 171	NTC7829HD	34	RRD500510	38	STC1694/5/6/7	146
LR029295/7KIT	18	LTP3001	191	NTC9819	121	RRD500560	38	STC1774VT	165
LR029303GK	111	LTP3002	191	NTC9820	121	RRD500590G	38	STC1856	144
LR029303K	111	LTP3003	191	PDA500300	165	RRJ000030	33	STC2015	142
LR029304GK	111	LTP3004	191	PDA500310	165	RRJ100120	33	STC250	148
LR029304K	111	LTP3005	191	PHD500340	81	RRJ500030MNH	38	STC2802B	145
LR029305GK	111	LTP3006	191	POSTER SET	197	RTC3095	76	STC2813	155
LR029305K	111	LTP3007	191	PRC7994K	43	RTC3254	165	STC2814	155
LR029306GK	111	LTP3008	191	PRC8238	40	RTC3347	165	STC2815	155
LR029306K	111	LTP3015	191	PRC8876LED	42	RTC3534	141	STC2816	155
LR030213	84	LTP3016	191	PSD103470BRG	150	RTC3537	141	STC2828VT	165
LR031526	154	LTP3017	191	PYP10008BLUE	146, 186	RTC4234	119	STC2862A	165
LR031790	13	MRC316	8	PYP10008RED	146, 186	RTC4235	119	STC2864VT	165
LR031812	13	MRC316P	8	RBJ102920/930BJ	140	RTC4236	119	STC2952	142
LR031947KIT	141	MRC3519	67	RBJ102920/930BJG	140	RTC4484	119	STC2952G	143
LR032305	183	MRC6980	70	RBJ500680/690BJ	140	RTC4615C	43	STC3018SS	45
LR032306	183	MRC6980CB	70	RBJ500680/690BJG	140	RTC4615K	43	STC3135	148
LR032525	84	MRC6980CG	70	RBL05265SS	24, 29	RTC4615KW	43	STC3261	148
LR032903	142	MRC6982	70	RBL10875SS	29	RTC4615W	43	STC3410	33
LR032903G	143	MRC6982CB	70	RBL13835SS	29	RTC4685	12	STC3411	33
LR032954	142	MRC6982CG	70	RBL13875SS	29	RTC4769	7, 153	STC3412	33
LR032954G	143	MRC6982H	70	RBL17275SS	29	RTC6204	157	STC3413	33
LR033179	84	MRC6985	70	RBL18875SS	29	RTC6247	154, 158	STC3414	33
LR036574	142	MRC6985CB	70	RBL19075SS	29	RTC6248	154, 158	STC3415	33
LR036574G	143	MRC6985CG	70	RBL20575SS	29	RTC6248NG	154, 158	STC3416	33
LR038128	84	MT3181	70	RBL21375SS	29	RTC6317	157	STC3417	33
LR038341	84	MT3181CB	70	RBL23035SS	29	RTC6318	157	STC3418	33
LR039149	151	MT3181CG	70	RBL24275SS	29	RTC6350	154	STC3419	33
LR041041	50, 52	MTC5083	11	RBX000571PY	114	RTC6351	154	STC3420	33
LR041041G	50, 52	MTC5084	11	RBX101240PY	115	RTC6352	154	STC3421	33
LR043285	142	MTC5217	11	RBX101240YELLOW	115	RTC6401VA	165	STC3422	33
LR043285G	143	MTC5382	158	RBX101340PY	110, 115	RTC6551	144	STC3423	33
LR043714	142	MTC5382G	158	RBX101340YELLOW	110, 115	RTC6551RED	144	STC3424	33
LR043714G	143	MTC5383	158	RBX101680PY	115	RTC6732/3/4/5	146	STC3425	33
LR044034	116, 140	MTC5383G	158	RBX101680YELLOW	115	RTC6820	12	STC3426	33
LR045096	62	MTC9967	69	RBX101690PY	115	RTC6821	12	STC3427	33
LR045097	62	MUC1488	70	RBX101690YELLOW	115	RTC6870VT	165	STC3428	33
LR045444	116, 140	MUC1520	70	RBX101730PY	115	RTC8095	56	STC3429	33
LR051585PY	114	MUC1520G	70	RBX101730YELLOW	115	RTC8831	48	STC3435	170
LR051586PY	114	MUC2344	12	RBX101780PY	115	RTC8860AA	8	STC3435S	170
LR051621PY	114	MUC2437	68	RBX101780YELLOW	115	RTC8891AA	49, 50, 53	STC3580	33
LR051626	142	MUC3990	12	RBX101790PY	115	RTC8922	41	STC3581	33
LR051626G	143	MUC4122ABE	68	RBX101790YELLOW	115	RTC8969	8	STC3582	33
LR051771	185	MWC1010	69	RBX500291PY	114	RTC9479	12	STC3583	33
LR052756	152	MWC1743	72	RBX500301PY	114	RTC9503AA	9	STC3584	33
LR054831PY	114	MWC3302	69	RBX500311PY	114	RTC9505AC	19	STC3585	33
LR055323	12	MWC3303	69	RDB100080PY	115	RTC9535	33	STC3586	33
LR055330	12	MWC4535	69	RDB100080YELLOW	115	RTC9562	12	STC3587	33
LR055331	12	MWC4840	155	REB101740	121	RTC9593AA	19	STC3588	33
LR055332	12	MWC4841	155	RGX100960K	114	RTC9840C	190	STC3589	33
LR055333	12	MWC5628LCS	69	RGX100970PY	115	RTC9841CE	190	STC3601	33
LR055334	12	MWC5670LCS	69	RGX100970YELLOW	115	RTC9842CE	190	STC4235VT	165
LR055339	12	MWC6702	155	RGX101000PY	115	RTC9846CH	190	STC4286	49, 50
LR055340	12	MWC6754	155	RGX101000YELLOW	115	RTC9863CE	190	STC4404	165
LR055454	142	MWC9060	155	RGX101010PY	115	RTC9947CF	190	STC4596VT	165
LR055454G	143	MWC9061	155	RGX101010YELLOW	115	RTC9970CE	190	STC4600	165
LR055455	142	MWC9084	155	RGX101020PY	115	SE105161L	42	STC4637	42
LR055455G	143	MWC9085	155	RGX101020YELLOW	115	SERVICE KIT LEAFLET	197	STC4672	165
LR056964PY	114	MWC9843LCS	69	RGX101440PY	115	SFC500080	142	STC4676	165
LR059125	185	MWC9844LCS	69	RGX101440YELLOW	115	SFC500080G	143	STC4687	165
LR059126	185	MXC1992LCS	72	RGX500060PY	114	SFP000250	142	STC4723E	146

Part No.	Page No.	Part No.	Page No.	Part No.	Page No.	Part No.	Page No.	Part No.	Page No.
STC4723N	146	STC618PY	115	STC9189G	143	VPLFS0245PVJ	62	VUB000730	52
STC4757	84	STC618PY-YELLOW	115	STC9190	142	VPLFS0246PVJ	62	VUB000740	52
STC4861	165	STC7555	56	STC9190G	143	VPLFT0001	51	VUB001070	10, 177
STC4862	167	STC7570	56	TRC102900	151	VPLFT0002	51	VUB001080LR	10, 177
STC4862G	168	STC7582	27	TRC103150	151	VPLFT0077	51	VUB001230	21, 177
STC4863	167	STC7623LR	33	TRC103160E	151	VPLFT0105	51	VUB001300	21, 177
STC4863G	168	STC7631	18	TRC103270	151	VPLFT0106	51	VUB001310	21, 177
STC50026	9	STC7631MT	18	TRC103350E	151	VPLFT0118	51	VUB001320	12
STC50027	9	TYK500010	18	TYK500010	167	VPLFT0119	51	VUB001330	12
STC50030	19	STC7632MT	18	TYK500010-20L	167	VPLFT0120	51	VUB002120	57
STC50032	19	STC7639	25	TYK500010G	168	VPLGP0109	12	VUB002510	21, 177
STC50050	58	STC7642	77	TYK500030	167	VPLGP0110	12	VUB500510	56
STC50052AA	58	STC7643	41	TYK500050	148, 167	VPLGP0111	12	VUB500520	9
STC50053AA	58	STC7644	40	TYK500050-20L	167	VPLGS0153	60, 177	VUB500870	40
STC50063	24	STC7703	12	TYK500050G	148, 168	VPLGS0154PVJ	64	VUB500900	196
STC50064	9	STC793/4/5/6	146	TYL100030	165	VPLGS0154SVA	64	VUB501170	56
STC50080	33	STC7939AB	56	UMAGBG	194	VPLGS0155PVJ	64	VUB501200	9, 181
STC50081	50	STC7978AB	12	URB500060	150	VPLGS0155SVA	64	VUB501380	9, 181
STC50082AA	56	STC8027LR	10	UTP1725	148	VPLGS0263	58	VUB501920	10, 179
STC50134	24	STC8056	8	VPLAB0025LML	179, 181	VPLGT0073	53	VUB501930	10, 179
STC50172	60	STC8057AC	27	VPLAP0008	9, 181	VPLGT0082	52	VUB501980	7, 179
STC50176AA	27	STC8130AB	19, 21	VPLAP0009	9, 181	VPLHT0061	53	VUB502130	27
STC50181	50	STC8138AB	77	VPLAP0013	14	VPLHT0062	53	VUB502610	10, 177
STC50243	45	STC8156AA	110	VPLAP0017	12	VPLMS0085PVJ	64	VUB503130	60
STC50269AA	18, 49	STC8156AAPY	110	VPLAP0018	81	VPLMS0085SVA	64	VUB503650	177
STC50287AB	50	STC8354	154	VPLAP0022	7, 181	VPLMS0087PVJ	64	VUB503660	21, 177
STC50289AB	50	STC8355	154	VPLAP0035	19, 181	VPLMS0087SVA	64	VUB503880MMM	177, 179, 181, 182
STC50290	19	STC8356	154	VPLAR0001	27	VPLPP0060	7	VUB503940	12
STC50301	18, 49	STC8358	150	VPLAS0015	58	VPLPP0061	7	VUB503960	52
STC50319	50	STC8363	150	VPLAS0023PVJ	62	VPLSP0010	10, 179	VUB504110	8
STC50323	56	STC8414	56	VPLAS0029PVJ	64	VPLSP0016	12	VUH000020	53
STC50383	43	STC8453G	9	VPLAS0197	62	VPLSS0016	58	VYK000010	165
STC50389	50	STC8480LR	40	VPLAS0198	62	VPLSS0026PVJ	64	XBD100670LED	42
STC50391	51	STC8503AALR	10	VPLAT0011	50	VPLSS0042	179	XBD500010LED	42
STC50408	43	STC8504ABLR	10	VPLCP0209	19	VPLSS0043	58	XBD500040LED	42
STC50413	7	STC8505AA	21	VPLCP0210	19	VPLSS0104	62	XBD500050LED	42
STC50417	24	STC8524	57	VPLCS0268	58	VPLSS0138	60	XDISC	99
STC50433	27	STC8529AA	77	VPLCS0273	58	VPLTP0064	10, 179	XFC100550LED	42
STC50434	58	STC8535	12	VPLCS0274	58	VPLVP0065	12	XFD100100LED	42
STC50459	51	STC8536	12	VPLCS0278	62	VPLVP0066	12	XFD100100LEDCL	42
STC50460	51	STC8587	84	VPLCS0279	58	VPLVP0069	12	XFD500010	42
STC50479	56	STC8604	154	VPLCS0280	62	VPLVP0070	12	XFD500010LED	42
STC50519	167	STC8605	154	VPLCS0281	62	VPLVP0071	21, 183	XFD500040LED	42
STC50519LR	165	STC8606	154	VPLCS0291PVJ	64	VPLVP0184	21	XFD500040LEDCL	42
STC50529	168	STC8607	154	VPLCS0291SVA	64	VPLVS0070PVJ	64	XFD500050LED	42
STC50530	168	STC8608	154	VPLCS0292PVJ	64	VPLVS0071PVJ	64	XFE500010	42
STC50531	167	STC8609	154	VPLCS0292SVA	64	VPLVS0072PVJ	64	XFE500010LED	42
STC50531LR	165	STC8610	154	VPLCS0293PVJ	64	VPLVS0073PVJ	64	XFE500010LEDCL	42
STC50543	165	STC8648	154	VPLCS0293SVA	64	VPLVS0077PVJ	64	XGB100310L	185
STC50544	165	STC8649	154	VPLCT0132	50	VPLVS0089	58	XPAD	99
STC50549	165	STC8652	154	VPLCT0140	50	VPLVS0090	58	XQB500080	40
STC50550	165	STC8653	154	VPLCT0142	50	VPLVS0091	58	YGD000271	84
STC50551	165	STC8693	154	VPLCT0147	50	VPLVS0102	60	YGD100860	84
STC53075AA	12	STC8694	154	VPLCT0148	50	VPLVS0125	60	YGD500100	84
STC53076AA	12	STC8695	154	VPLCT0155	50	VPLVT0065	52	YGD500130	84
STC53077	20	STC8843AA	33	VPLDR0063	27	VPLVT0069	52	YMW101030	51
STC53078	20	STC8875	50	VPLDR0064	27	VPLVT0078	52	YWC000840	53
STC53157	8	STC8919AA	50, 53	VPLDS0011	64	VPLW0165	12	YWJ101500	49
STC53158	8	STC8972	165	VPLDS0147	60	VPLW0166	12	YWJ500070	51
STC53161	8	STC9021CC	190	VPLDT0086	49	VPLW0167	12	YWJ500150	53
STC53181	9	STC9049CA	190	VPLDV0001	185	VPLW0167	12	YWJ500201	50
STC53193	9	STC9124	144	VPLDV0003	185	VTD500010	19, 181	YWJ500450	53
STC53194	9	STC9155	165	VPLFS0107PVJ	64	VTD500020	19, 181	YWJ500460	53
STC542	154	STC9157	165	VPLFS0233	62	VTK500010	19, 181	YWT10002L	50, 51, 53
STC543	154	STC9158	165	VPLFS0234	62	VTK500020	21, 179		
STC60713	185	STC9189	142	VPLFS0244	58	VUB000700	60		
						VUB000720	52		



Photograph courtesy of John Stokes

A Bars	7	Chassis	153	Fuel tank sender wrench	172
Adjustable ball joint	112	Chassis & body components	154 - 159	Fuel tanks	77
Air compressors	32 & 74	Chassis crossmembers	154 - 155 & 157 - 158	Fulcrum brackets	110
Air compressors & tyre repair kit	74	Chassis leg	156	Fume curtain	67
Air conditioning kits	187	Chequer plate	6	Gaiter kits	16
Air filters	101 - 102	Cleaners	165	Gaiters	68
Air intakes	177, 179 & 185	Clips, clamps & nipples	165	Galvanised products	153
Air lift kits	119	Clothing	192	Galvanised roof rack kits	25
Air spring conversion kits	120	Clutch kits	150	Gasket repairs	169
Air springs	121	Coil springs	121 - 122	Gear box gaiters	68
Air suspension compressor	116 & 140	Coin tray	186	Gear boxes	151
Air suspension compressor bracket	116 & 140	Cones, dislocation	112	Gear change kits	151
Air suspension control	119	Conversion kits, air spring	120	Glove box	67
Alloy bleed screw	146 & 186	Cross pin	76	Glove box kit	186
Alloy wheels	36 - 38	Crossmembers	154 - 155 & 157 - 158	Glues	169
Alternator upgrade kits	85 & 144	Cubby box holder	66	Grease nipples	165
Anti-freeze	165	Cubby boxes	66	Green Stuff brake pads	98
Anti-rattle jack clamps	79	Curtain, fume	67	Grilles	177, 179 & 185
Anti-roll bar kits	110	CV joint kits	149	Guard, diff	15
Anti-squeal shims	96 & 141	Cylinder head ancillaries	145	Guard, fuel cooler	15
ARB diff lockers	75	Cylinder heads	145	Guards, dog	56 - 57
Armrests	66 - 67	Cylinder liner kit	145	Guards, filter	100
Ashcroft Transmission diff locker	76	Damper kit	149	Guards, sump	15
Autojaw coupling	48	Dash trim kits	71	Hammer, emergency	77
Automatic transmission flush & fill	173	Delphi De Carbon shock absorbers	119	Handbooks	190
Automatic transmission service kits	148 & 163	Delphi steering dampers	123	Handbrake conversion kits	99
Axle parts	154	Demister kit	186	Haynes books & manuals	190
Ball joint repair kits	140	Detent repair springclip	151	Haynes internal combustion engine	195
Batteries	84	Detroit diff lockers	76	Head & bottom gasket kits	145
Battery charger	85	Detroit Truetrac	76	Head bolt sets	145
Battery management system	86	Diagnostic tools	128 - 130	Head gasket kits & head bolt sets	145
Bearing grease	165	Diecast models	195	Headlamp surround	185
Bike racks	24	Diff coupling shaft	149	Headlight bulbs	43
Blanking kits	100	Diff guard	15	Heater blower motor kit & resistor kit	148
Bleed screw, alloy	146 & 185	Diff lock lever kit	76	Heater control light upgrade kit	43
Blindo wheels	37	Diff lockers	75 - 76	Heater matrixes	148
Body repair consumables	169	Diff overhaul kits	151	Heater plug set	146
Bodywork	155 & 157	Diff rebuild kit	151	Heater plug upgrade kit	146
Bolt kits	140	Diff repair pans	149	Heavy-duty drive flanges	110
Bonnet	185	Dirt D-fenders	11	Heavy-duty shock absorbers	119
Bonnet grilles	183	Dislocation cones	112	Heavy-duty steering arms	123
Bonnet hinge kits	185	Distributor merchandise	197	Hi-Lift jacks	78
Books, manuals & technical publications	190	Dog guards	56 - 57	Hoods	68
Boost box	105	Door handle covers	177, 179 & 181	Hylomar compounds	165
Boot protection	58 - 59	Door hinge kits	159 & 185	Hylomar sealants	165
Bottle jack	79	Door stays	72	Hylosil instant gasket	165
Boxes, roof	26	Door trims	72	Ignition lead sets	144
Brake anti-squeal pads	96	Doors	154 - 155 & 157 - 158	Ignition module & link lead	144
Brake caliper pistons	142	Drive flanges	110	Ignition module kit	144
Brake cleaner	165	Driving lights	40	IID tool	128 - 129
Brake discs	96 - 97	Dual battery management system	86	Indicator bulbs	179, 181 - 182 & 185
Brake fitting kit	141	Dust caps	33	Injector pipe sets	146
Brake hose kits	99	EAS override module	120	Injector washer kits	147
Brake kits	141	EAS tool	128	Inner tubes	32
Brake lubrication	96 & 141	EBC brake discs	97	Inspection lamp	171
Brake pads	97 - 98 & 142 - 143	EBC brake pads	97 - 98	Inspection lamps	46
Brake pipe tool	143	ECE LED headlamps	44	Instant gasket	165
Brake pipes	143	EGR blanking kits	100	Intercooler silicone hoses	103
Bridging ladders	80	Electric windows	187	Intercoolers	102
Britpart Expedition roof racks	27	Electrical manual	190	Interior roof console	187
Britpart merchandise & clothing	192	Electronic conversion kits	144	Intermediate reduction drive repair kit	151
Britpart XD Remote Reservoir	116	Emergency hammer	77	IRD repair kit	151
Bulk filters	145	Engine chip	105	Isolator switch	93
Bulkhead	158	Engines	146	Jack base	79
Bulkhead bars	67	Exhaust clamps	165	Jack clamps	79
Bulkhead parts	154 - 155	Exhaust front down pipes	107	Jackall jacks	79
Bump stops	113	Exhaust sports systems	107	Jacking equipment	78 - 79
Bumper caps	185	Exhausts	106 - 108	Jerry cans	77
Bumperettes	7 & 13	Extended slide seat rails	67	Jubilee clips	165
Bumpers	7 & 13	Fairleads	92	K&N air filters	102
Bumpers, winch	91 - 92	Filter Guards	100	Ladders	24
Bungeeclic load securing system	30	Filters, bulk	145	Ladders - sand & bridging	80
Bush fitting tool	114	Fire extinguishers	77	Lamp guards	8 - 10
Bush set - Watts linkage	114	First aid kits	77	Land meters	80
Bush sets	114 - 115	Floor bodywork	154 - 155	Land Rover genuine consumables	165
Bushes	111	Floor mats	60 - 62	Land Rover Merchandise	193 - 194
Calibration blocks	137 & 171	Fluids	168	Land Rover models	195
Calibration tools	137 & 171	Fluids & oils	165	Land Rover Original technical publications	191
Caliper rebuild tool kit	172	Fog light surrounds	177 & 181 - 182	Landy books	191
Caliper tool	172	Fog lights	41	Leaf spring castor correction wedges	121
Canvass hoods	68	Footwells	158	Leaf springs	121
Carburettors, Weber	105	Front down pipes	107	LED bumper	7 & 41
Cargo tie down point	186	Front grilles	185	LED daytime lights	40 - 41
Carpet mats	60 & 62	Front hub, bearing & upright assembly	141	LED headlamps	44
Carriers, roof	25 - 26	Front Runner racks	26	LED lights	42
Carry straps	30	Front seats	69 - 70	Lift rod kit	80 & 113
Castor corrected swivel housings	111	Front suspension arm & bolt kits	111	Lifted springs	122
Castor correction wedges	121	Front suspension arms	111	Light bars	45
Castrol oil merchandise	166	Fuel burning heater controller	178 & 181	Light bulb kits	44
Castrol oils	166	Fuel cooler guard	15	Light conversion kits	43
Cellular Dynamic shock absorbers	117	Fuel filter holder	147	Light kits	42
Cellular Dynamic steering dampers	123	Fuel injector locking tool	171	Light mounting kits	45
Chain cover	71	Fuel latch repair kit	159	Light upgrade kits	43

Light upgrades	43	Roof console	187	Tuning products	104 - 105
Lights, driving	40	Roof ladders	24 & 29	Tunit	105
Lights, fog	41	Roof racks	25 - 29	Turbo boost box	105
Lights, LED	42	Roof racks, galvanised	25	Turret rings	112
Lights, NAS	42	Roo-lites	41	Turrets	112
Lights, Roo-lites	41	Ropes & strops	93	Twin tail pipe	106 - 107
Liner set	147	Rubber mats	60 - 62	Tyre inflation kit	33 & 75
Loadspace nets & retention kits	60	Rubbing strips	14	Tyre pressure monitoring system	32
Loadspace protectors	58	Safari raised air intakes	82	Tyre repair kit	32 & 74
Loadspace protectors - premium	59	Safety Devices roof racks	28	Ultimax brake pads	98
Loadspace retention kits	60	Safety equipment	93	Umbrella holder	60 & 177
Locking fuel cap	7	Sand ladders	80	Universal joint silicone sleeves	176
Locking wheel caps	33	Santana clutch kit	150	Upgrade chip	105
Locking wheel keys	33	Scuff plate	183	USB charger	187
Locking wheel nuts	33	Seat covers	63 - 64	Utility link pipes	107
Loctite consumables	169	Seat heater	72	Valve Caps	33
Long range fuel tanks	77	Seat rails	67	Vehicle enhancements	178 - 187
Lowered springs	121	Seats	69 - 71	Vent hinge pin kit	185
Lynx diagnostics interface	130	Sensors, parking	13	Waterproof seat covers	63 - 64
Magbooks	191	Service kits - Alternative Brand	161 - 163	Watts linkage bush set	114
Main bearing sets	146	Service kits - Britpart	161 - 163	Weber carburettors	105
Manifold inlet seal	147	Service kits - Genuine	161 - 163	Wheel adaptor kits	34
Marsland chassis	153	Shackles & pulleys	93	Wheel arch kits	14
Mats	60 - 62	Shock absorber brackets	112	Wheel bearing kits	141
MaxXtrac wheels	37	Shock absorber turrets	112	Wheel carriers	32
Merchandise	192	Shock absorbers	116 - 119	Wheel chocks	93
Mirrors	11	Side steps	14 & 18 - 21	Wheel hub & bearing	141
Model engine	195	Side vent trim	181	Wheel spacers	34
Models	193 & 195	Silencers	107	Wheel strap	32
Mont Blanc racks	26	Silicone hose kits	100	Wheel wrenches	34
Mudflap brackets	12 & 185	Silicone sleeves	16	Wheels, alloy	36 - 38
Mudflaps	12	Silicone turbo hoses	103	Wheels, steel	35
NAS lights	42	Sill tread plate kit	177, 179 & 181 - 182	Wide angle propshafts	123
New engines	146	Sills	155 & 157	Winch bumper fitting kit	92
Number plate mounting bracket	92 & 185	Sparco seats	71	Winch bumper kits	91
Oil cooler repair kit	147	Spare light bulb kits	44	Winch bumpers	92
Oil pump gear set	147	Spare wheel carriers	32	Winch fairleads	92
Oils	166 & 168	Spare wheel covers	34	Winch remote control	93
Optima batteries	84	Spare wheel protector	34	Winch safety equipment	93
Original technical publications	191	Spare wheel strap	32	Winch spare parts	90
Paints	165	Spring kits, parking brake	141	Winches	88 - 90
Panhard rods	110	Spring retainers	112	Winching accessories	92 & 94
Parabolic springs	121	Spring spacer blocks	112	Winching kits	94
Parking brake spring kits	141	Springs, air	121	Wind deflectors	16
Parking sensors	13	Springs, coil	121 - 122	Window bodywork	154 & 158
Parts catalogues	190	Springs, leaf	121	Window kits	159
Peak Performance air filters	101	Springs, parabolic	121	Windscreen brackets	185
Pedal sets	179 & 181	Stainless steel bolts	185	Wing mirror cover	177, 179 & 181 - 182
Performance air filters	101	Stainless steel brake caliper pistons	142	Wing mirrors	11
Performance brake discs	96	Stainless steel exhausts	107 - 108	Wings	154 - 155 & 157 - 158
Performance intercoolers	102	Stainless steel screws	185	Wipac light conversion kit	43
Plate, sump	15	Starting handle	34 & 196	Wiper blades	196
Plate, transmission	15	Steel wheels	35	Wiper relay - programmable	144
Polybush bushes	114	Steering arms, heavy-duty	123	Work light	45
Portable Powerpacks	81	Steering box repair kit	140	Workshop fluids	168
PowerPacks	81	Steering dampers	123	Workshop manual	190
Premium loadspace protectors	59	Steering rack ball joint repair kits	140	Workshop tools	171 - 173
Pressure relief valve	147	Steering wheels	187	XD Brake Pads	142
Propshaft bearings	151	Steps, rear	18	XD handling kit	121
Propshaft kit	123	Steps, side	18 - 21	Xenon headlight bulbs	43
Propshaft spacer kit	123	Strops & ropes	93	Xenon headlight upgrade	43
Propshafts, wide angle	123	Stub axle kits	140	XS Brake Pads	143
ProSpeed ladder	29	Sump guards	15	X5 style seats	71
ProSpeed rack	29	Sump plate	15	Yellow Stuff brake pads	97
PSI power tuning	104	Super Gaz shock absorbers	118	Zu wheels	38
Pulleys & shackles	93	Super Gaz steering dampers	123		
Radiator mufflers	196	Suspension ball joint repair kits	140		
Radius arms	111	Suspension bolt kits	111 & 140		
Raised air intakes	81 - 82	Suspension calibration	137 & 171		
Range Rover book	191	Suspension kits	124		
Ravenol anti-freeze/coolant	167	Suspension mounts	154 - 155 & 157 - 158		
Ravenol oils	167	Swivel housing gaiter kits	16		
Rear 1/4 chassis	156	Swivel housing grease	170		
Rear diffs & carriers	152	Swivel housing kits	111 & 140		
Rear end door hinge kit	154	Swivel pin kits	140		
Rear seats	70	Tailgate chain cover	71		
Rear silencer	107	Tailgate conversion trim kit	179		
Rear spoiler	182	Techno style seats	69		
Rear spring sets	113	Thread locker	169		
Rear steps	18	Thule racks	25		
Reconditioned engines	146	Timing kits	147		
Recovery ladders	80	Timing tools	171		
Remote reservoir shock absorbers	116	Tools	171 - 173		
Replacement batteries	84	Top hat liner set	147		
Replacement rear surround camera	13	Touch up paint pens	170		
Re-trim kits	70	Towing equipment	48 - 53		
Retrofit insert seat heater	72	Trade tack stab	170		
Reversing camera kit	13	Transfer box	152		
Richards chassis	153	Transmission plate	15		
Rock sliders	14	Transmission service kits	148		
Roll cages	29	Travel kits	77		
Roof boxes	26	Trim, dash	71		
Roof carriers	25 - 26	Trim, door	72		



Photograph courtesy of Josh Wanklyn







## United Kingdom Registration Years

### Suffix letter series 1963 - 1983

Letter	From	To
A	1st January 1963	31st December 1963
B	1st January 1964	31st December 1964
C	1st January 1965	31st December 1965
D	1st January 1966	31st December 1966
E	1st January 1967	31st July 1967
F	1st August 1967	31st July 1968
G	1st August 1968	31st July 1969
H	1st August 1969	31st July 1970
J	1st August 1970	31st July 1971
K	1st August 1971	31st July 1972
L	1st August 1972	31st July 1973
M	1st August 1973	31st July 1974
N	1st August 1974	31st July 1975
P	1st August 1975	31st July 1976
R	1st August 1976	31st July 1977
S	1st August 1977	31st July 1978
T	1st August 1978	31st July 1979
V	1st August 1979	31st July 1980
W	1st August 1980	31st July 1981
X	1st August 1981	31st July 1982
Y	1st August 1982	31st July 1983

### Prefix letter series 1983 - 2001

Letter	From	To
A	1st August 1983	31st July 1984
B	1st August 1984	31st July 1985
C	1st August 1985	31st July 1986
D	1st August 1986	31st July 1987
E	1st August 1987	31st July 1988
F	1st August 1988	31st July 1989
G	1st August 1989	31st July 1990
H	1st August 1990	31st July 1991
J	1st August 1991	31st July 1992
K	1st August 1992	31st July 1993
L	1st August 1993	31st July 1994
M	1st August 1994	31st July 1995
N	1st August 1995	31st July 1996
P	1st August 1996	31st July 1997
R	1st August 1997	31st July 1998
S	1st August 1998	28th February 1999
T	1st March 1999	31st August 1999
V	1st September 1999	29th February 2000
W	1st March 2000	31st August 2000
X	1st September 2000	28th February 2001
Y	1st March 2001	31st August 2001

### New style series 2001 - onwards

Year	1st March to 31st August	1st September to 28th February
2001/2002	N/A	51
2002/2003	02	52
2003/2004	03	53
2004/2005	04	54
2005/2006	05	55
2006/2007	06	56
2007/2008	07	57
2008/2009	08	58
2009/2010	09	59
2010/2011	10	60
2011/2012	11	61
2012/2013	12	62
2013/2014	13	63
2014/2015	14	64
2015/2016	15	65
2016/2017	16	66

## Get All The Latest Britpart News

We have two easy ways to keep in touch with all the latest news and product releases.

#### 1. Newsletter

Simply log on to [www.britpart.com](http://www.britpart.com) and register your details in the 'Mailing List' section or simply send an e-mail with newsletter in the subject field to - [marketing@britpart.co.uk](mailto:marketing@britpart.co.uk)

#### 2. Facebook

Go to [www.facebook.com/britpart](http://www.facebook.com/britpart) and click the 'like' button to see all the latest product releases when they happen - no need to wait for the next catalogue release.

## Make Your Land Rover A Star

If you have a great picture of your Land Rover and would like to see it featured in the next Britpart catalogue, then please send it to [marketing@britpart.co.uk](mailto:marketing@britpart.co.uk) with all your details. We look forward to seeing them and each one sent in will automatically be entered into the next Britpart calendar competition. See [www.britpart.com/calendar](http://www.britpart.com/calendar) for more details on the competition. Happy snapping!

## The Small Print

- Britpart is a wholesaler only.  
To purchase parts and for technical questions, contact your local stockist.  
To find yours go to [www.britpart.com/distributors](http://www.britpart.com/distributors)
- Part numbers used for identification purposes only and do not imply or indicate the identity of a manufacturer.
- Genuine Land Rover parts and accessories are for sale in EU countries only.
- Parts are subject to stock and supply.
- Pictures are for reference only and specifications may alter without notice.
- Colour swatches are for reference only - samples are available on request.
- All products available at time of printing and we reserve the right to withdraw any product at any time.
- Land Rover logos and trade names are for reference only.
- No part of this catalogue may be used or reproduced by any means without the express permission of Britpart.
- Product specifications are given but it is up to the end user to ensure that the product is fit for that purpose.
- E&OE

# BRITPART

The quality parts for Land Rovers



Photograph courtesy of Terry Stokes



Photograph courtesy of Bogdan Muscalu

Protecting

Carrying

Towing

Enhancing

Repairing

Lighting

Improving

Winching

Servicing

Upgrading

Off-roading

Available from -



# BRITPART

The quality parts for Land Rovers

[www.britpart.com](http://www.britpart.com)

**Britpart**

The Grove, Craven Arms,  
Shropshire, SY7 8DA UK  
[sales@britpart.com](mailto:sales@britpart.com)