

MONROE

MAXLIFT

GAS CHARGED LIFT SUPPORT

CATALOGUE 2012 GAS SPRINGS

» MASTERING

TECHNOLOGY, PERFORMANCE & SAFETY »»

TENNECO

MONROE®



» MASTERING

COVERAGE AND SUSPENSION TECHNOLOGY

FOR ANY KIND OF VEHICLE »»

European, Japanese,
Korean, US car park



MONROE
MAXLIFT
GAS CHARGED LIFT SUPPORT





Max-Lift is a sealed, gas filled pressure cylinder that exerts an outward force.

This force acts like a spring to lift and hold open hatches, bonnets and boots. An exact replacement fit for most applications.

Features

- Superior rod finish - increased seal durability.
- High strength piston seal - superior sealing strength.
- High pressure gas filled - smooth action.
- Two years warranty.

MAX-LIFT	Typical Part N° Series
GAS SPRING	ML-

Monroe® quality and durability makes Max-Lift™ the only choice.

Monroe® Max-Lift gas charged lift supports are now available as exact replacement fits for most vehicles sold in Europe since 1980.

Max-Lift is the market's premium replacement product. The highest quality, design and durability standards have been applied to their manufacture. And isn't that what your customers have a right to expect?



Max-Lift installation guide

- Always replace both lift supports to ensure top performance and to prevent twisting caused by uneven loading.
- Gas charged Lift Supports typically store a gas charge of over 330 Newton and cannot be compressed by hand
- Gas charge Lift Supports can be installed in minutes with no special tools required.
- Careful inspection of all hinges and connecting points should be made for wear and tear or stress fractures. These should be replaced or repaired before Lift Supports installation.

Installation Instructions:

- Before removing old lift supports, examine any fittings supplied to determine which components must be re-used.
- Have someone hold the hatch, bonnet, boot or rear window open while replacing the lift supports
- The new lift support must be installed in the same position as the old one which was removed.
- Do not remove both lift supports at the same time. Replace one, then remove and replace the second one.
- Gas spring orientation ie. It is important that the gas spring be mounted with the Tube up in the closed position as this ensures lubrication and smooth operation

Important notes:

When ordering a Gas Spring, please consider the following :

- Overall length from centre to centre (Extended)
- Pressure
- Type of end fittings
- Year, Make and Model of vehicle

How to measure a Gas Spring:

- Overall length is measured with strut fully extended and taken between the centre's of the fixing studs.
- Stroke is measured between top of strut barrel and end of shaft fitting.



Standardized car description



HOW TO SELECT THE MONROE® GAS SPRING PRODUCT

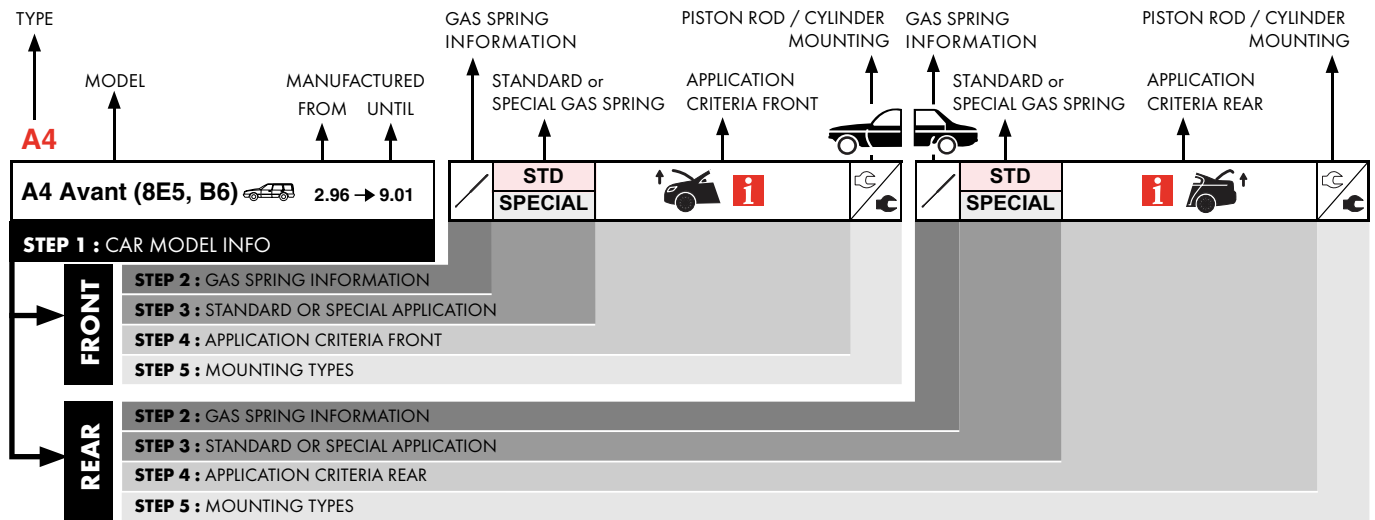

MODEL

(=)	Only used for
(-)	Without
(+)	With
	Berline, Sedan, Saloon, 2/4 doors
	Berline, Sedan, Saloon, 3/5 doors
	Fastback, Hatchback, Liftback
	Coupé, Hardtop
	Break, Estate, Station, Wagon
	Cabriolet, Convertible
	Car derived Van
	Multi Purpose Vehicle (MPV)
	Sport Utility or Activity Vehicle
	Off Road
	Pick up
	Delivery Van
	Minibus
	Cargo
	2-3-4-5 doors
OE n°	Original Equipment number
Ch. n°	Chassis number
	...onwards
	up to...
	Only for Cars sold in Sweden

STANDARD APPLICATIONS

	Gas spring
	Front
	Rear
	Spoiler
	Spoiler with additional stoplight
	Window wiper
	Loudspeaker
	Remote closing
	Warning triangle
	Sunroof
	Left side
	Right side

SPECIAL APPLICATIONS

	Rear window
	Folding table

PARTNUMBER

ML5001	New available partnumber
ML5853°	Part number in process

MOUNTING TYPES

	Piston rod mounting
	Cylinder mounting

Monroe® will only honour gas spring warranties when fitted in pairs.

TIPS FOR EASY READING: 1. Check for car make 2. Check for car model 3. Look at the year 4. Look at the type



ALFA ROMEO

MONROESTD
SPECIALSTD
SPECIAL**ALFA ROMEO****33**

33 (905)	5.83 →				ML5854⁰	→ 12.93	
33 Estate, Sport Wagon (907B)	5.83 →				ML5854⁰	→ 12.93	
					ML5597	1.90 → 9.94 (-)	U/X1

145

145 Hatchback (930)	7.94 → 1.01				ML5335		S1/S1
---------------------	-------------	--	--	--	---------------	--	-------

146

146 Hatchback (930)	12.94 → 1.01				ML5271		U/U
					ML5272	(+)	U/U

147

147 Hatchback (937)	1.01 →	ML5696		P/U	ML5222		S1/U
---------------------	--------	---------------	--	-----	---------------	--	------

155

155 Saloon (167)	1.92 → 12.97	ML5608		N/N	ML5531		S1/T1
					ML5532	(+)	S1/T1

156

156 Saloon (932)	9.97 → 9.05	ML5392		S1/S1	ML5215		S1/S1
156 Estate, Sportwagon (932)	5.00 → 5.06				ML5216	(+)	S1/S1
					ML5442		U/U

159

159 Saloon	9.05 →	ML5697		U/U	ML5698		S1/U
159 Estate, Sportwagon	3.06 →	ML5697		U/U	ML5853⁰		

164

164 Saloon (164)	6.87 → 9.98				ML5274	(+) 1 /	U/U
					ML5273	(+) 2 /	U/U

166

166 Saloon (936)	9.98 →	ML5414		S1/S1	ML5419		S1/S1
------------------	--------	---------------	--	-------	---------------	--	-------

BRERA

BRERA Hatchback	1.06 →	ML5697		U/U			
-----------------	--------	---------------	--	-----	--	--	--

GT

GT Coupe	11.03 →	ML5696		P/U	ML5855⁰		
----------	---------	---------------	--	-----	---------------------------	--	--

MITO

MITO (955)	9.08 →				ML5655		S1/S1
------------	--------	--	--	--	---------------	--	-------

SPIDER

SPIDER Convertible (916S_)	6.95 → 4.05				ML5272		U/U
----------------------------	-------------	--	--	--	---------------	--	-----

ALFA ROMEO



Q5

Q5 (8R)	11.08 →	ML5193		U/U	ML5856°		
					ML5857°	(+)	

Q7

Q7 Closed Off-Road Vehicle	3.06 →	ML5739		U/P	ML5774		T1/P
----------------------------	--------	--------	--	-----	--------	--	------

TT

TT Coupe (8N3)	10.98 → 6.06	ML5135		U/U	ML5277		U/U
TT Convertible, Roadster (8N9)	10.99 → 6.06	ML5135		U/U	ML5449	(+)	U/U
TT Coupe (8J3)	10.06 →	ML5740		S1/U	ML5858°		
TT Convertible, Roadster (8J9)	2.07 →	ML5740		S1/U	ML5859°	(+)	
					ML5753		U/U

80

80 Saloon (89,89Q,8A,B3)	6.86 → 10.91	ML5593		Y1/D	ML5417		S1/S1
80 Saloon (8C,B4)	9.91 → 12.94	ML5333		Y1/D	ML5533	(+)	T1/T1
80 Avant (8C,B4)	9.91 → 7.96	ML5333		Y1/D	ML5376		U/S1
					ML5104	(+)	U/S1
					ML5437		S1/U

COUPE

COUPE Coupe (89,8B)	10.88 → 12.96				ML5534		S1/U
---------------------	---------------	--	--	--	--------	--	------

CABRIOLET

CABRIOLET Convertible (8G7,B4)	5.91 → 8.00	ML5333		Y1/D			
--------------------------------	-------------	--------	--	------	--	--	--

90

90 Saloon (89,89Q,8A,B3)	4.87 → 9.91	ML5593		Y1/D	ML5417		S1/S1
					ML5533	(+)	T1/T1

100

100 Avant (44,44Q,C3)	8.82 → 11.90				ML5428		S1/S1
100 Saloon (4A,C4)	12.90 → 7.94	ML5385		U/U	ML5111		U/U
100 Avant (4A,C4)	12.90 → 7.94				ML5418		U/U

200

200 Avant (44,44Q)	9.83 → 12.91				ML5428		S1/S1
--------------------	--------------	--	--	--	--------	--	-------

AUSTIN

MAESTRO

MAESTRO Hatchback (XC)	3.83 → 9.92				ML5362		U/U
------------------------	-------------	--	--	--	--------	--	-----

METRO

METRO Hatchback	10.80 → 4.90				ML5041		U/U
-----------------	--------------	--	--	--	--------	--	-----

AUTOBIANCHI

A 112

A 112 Hatchback	10.69 → 12.85				ML5017		U/X2
-----------------	---------------	--	--	--	--------	--	------



Y10

Y10 Hatchback	3.85 →				ML5598		S1/S1
---------------	--------	--	--	--	---------------	--	-------

BMW

1

1 Hatchback (E87)	9.04 →	ML5563		S1/S1	ML5691		S1/U
-------------------	--------	---------------	--	-------	---------------	--	------

3

3 Saloon (E30)	9.82 → 1.92	ML5596		Y4/X1			
3 Touring (E30)	7.87 → 6.94	ML5596		Y4/X1	ML5450		U/U
3 Saloon (E36)	9.90 → 2.98	ML5421		Y1/X1	ML5170		U/U
3 Hatchback, Compact (E36)	3.94 → 8.00	ML5421		Y1/X1	ML5260	(+)	U/U
					ML5235	(-)	U/U
3 Coupe (E36)	3.92 → 4.99	ML5422		Y1/X1	ML5237	(+)	U/U
3 Convertible (E36)	3.93 → 4.99	ML5421		Y1/X1	ML5236	(+)	U/U
3 Touring (E36)	1.95 → 10.99	ML5421		Y1/X1	ML5451	3.94 → 9.94	U/U
3 Saloon (E46)	2.98 → 2.05	ML5263		S1/S1	ML5170		U/U
3 Hatchback, Compact (E46)	6.01 → 2.05	ML5263		S1/S1	ML5170		U/U
3 Coupe (E46)	4.99 →	ML5263		S1/S1	ML5436		S1/S1
3 Convertible (E46)	4.00 →				ML5163		S1/S1
3 Touring (E46)	10.99 → 2.05	ML5263		S1/S1	ML5671		U/U
3 Saloon (E90)	1.05 →	ML5689		S1/P	ML5163		S1/S1
3 Touring (E91)	9.05 →	ML5689		S1/P	ML5670		S1/S1
3 Coupe (E92)	6.06 →	ML5689		S1/P	ML5213		S1/S1
3 Convertible (E93)	3.07 →	ML5689		S1/P	ML5694		S1/S1
					ML5692		U/U
					ML5658		S1/S1
					ML5659		S1/S1

5

5 Saloon (E28)	6.81 → 6.90	ML5599		Y1/X1			
5 Saloon (E34)	12.87 → 9.95	ML5522		Y6/D	ML5444		Y1/D
5 Touring (E34)	11.91 → 1.97	ML5522		Y6/D	ML5445	(+)	Y1/D
5 Saloon (E39)	11.95 → 6.03	ML5336		S1/S1	ML5521		T1/Q
5 Touring (E39)	1.97 → 5.04	ML5336		S1/S1	ML5590	→ 5.96	S1/Q
5 Saloon (E60)	7.03 →	ML5562		S1/S1	ML5520	5.96 →	S1/Q
5 Touring (E61)	6.04 →	ML5562		S1/S1	ML5535		Y1/T1

6

6 Coupe (E24)	4.76 → 9.90	ML5600		Y1/D			
6 Coupe (E63)	1.04 →				ML5695		S1/U

7

7 Saloon (E23)	5.77 → 8.86	ML5600		Y1/D			
7 Saloon (E32)	9.86 → 9.94	ML5566		Y1/D			
7 Saloon (E38)	10.94 → 11.01	ML5441		S1/S1	ML5523		S1/Q
7 Saloon (E65,E66)	11.01 →	ML5565		P/S1			

X3

X3 Closed Off-Road Vehicle (E83)	1.04 →	ML5769		U/S1	ML5693		P/S1
----------------------------------	--------	---------------	--	------	---------------	--	------



CITROEN

MONROESTD
SPECIALSTD
SPECIAL**X5**

X5 Closed Off-Road Vehicle (E53)	5.00 →	ML5688	S1/S1	ML5690	S1/S1
----------------------------------	--------	--------	-------	--------	-------

Z3

Z3 Convertible, Roadster	10.95 → 1.03			ML5860 ⁰	
--------------------------	--------------	--	--	---------------------	--

Z4

Z4 Convertible (E85)	2.03 →			ML5861 ⁰	
----------------------	--------	--	--	---------------------	--

CHEVROLET**KALOS**

KALOS Hatchback	3.05 →			ML5714	U/P
-----------------	--------	--	--	--------	-----

LACETTI

LACETTI Hatchback	3.05 →			ML5794	T1/T1
-------------------	--------	--	--	--------	-------

MATIZ

MATIZ Hatchback	9.98 → 3.05			ML5098	P/P
-----------------	-------------	--	--	--------	-----

NUBIRA

NUBIRA Estate	1.05 →			ML5096	U/U
---------------	--------	--	--	--------	-----

REZZO

REZZO, TACUMA MPV	3.05 →			ML5446	T1/T1
-------------------	--------	--	--	--------	-------

CITROEN**AX**

AX Hatchback (ZA-_)	7.86 → 12.98			ML5607	S1/S1
---------------------	--------------	--	--	--------	-------

BERLINGO

BERLINGO MPV (MF)	7.96 →			ML5113	T1/T1
BERLINGO Box (M_)	7.96 →			ML5113	T1/T1

BX

BX Hatchback (XB-_)	10.82 → 6.94			ML5601	→ 10.86 Y1/D
				ML5602	10.86 → 12.89 S1/D
				ML5604	12.89 → S1/D
				ML5603	→ 10.86 GTI Y1/D
				ML5605	1.90 → GTI S1/D
BX Estate, Break (XB-_)	4.83 → 12.94			ML5452	U/U

C-CROSSER

C-CROSSER Closed Off-Road Vehicle	2.07 →			ML5776	U/P
-----------------------------------	--------	--	--	--------	-----

CX

CX I Hatchback	9.74 → 8.85			ML5606	Y1/D
CX I Estate, Break	9.75 → 8.85			ML5609	W/D

CITROËN

CITROEN



	STD				STD			
	SPECIAL							

C1

C1 Hatchback	6.05 →					ML5687		U/U
--------------	--------	--	--	--	--	--------	--	-----

C2

C2 Hatchback	9.03 →					ML5453		U/U
--------------	--------	--	--	--	--	--------	--	-----

C3

C3 Hatchback	2.02 →					ML5151		U/U
--------------	--------	--	--	--	--	--------	--	-----

C3 Picasso

C3 Picasso	2.09 →					ML5862 ^o		
------------	--------	--	--	--	--	---------------------	--	--

C4

C4 Hatchback	11.04 →					ML5668		S1/U
C4 Coupe	11.04 →					ML5782		T1/T1
						ML5824	(+)	S1/S1

C4 Picasso

C4 Picasso MPV	2.07 →					ML5756	(+) Fixed rear window	U/P
						ML5755	(-) Rear window	U/P

C4 Grand Picasso

GRAND C4 PICASSO MPV	10.06 →					ML5783	(+) Fixed rear window	U/P
----------------------	---------	--	--	--	--	--------	-----------------------	-----

C5

C5 Hatchback	3.01 → 8.04		ML5461		S1/S1		ML5391	U/U
C5 Estate, Break	6.01 → 8.04						ML5536	(-) Rear window
C5 Hatchback	9.04 →		ML5461		S1/S1		ML5391	U/U
C5 Estate, Break	9.04 →		ML5461		S1/S1		ML5536	(-) Rear window
C5 (RD_)	2.08 →						ML5652	J/S1

C6

C6 Saloon	9.05 →		ML5822		S1/S1			
-----------	--------	--	--------	--	-------	--	--	--

C8

C8 MPV	7.02 →						ML5344	U/U
--------	--------	--	--	--	--	--	--------	-----

EVASION

EVASION, SYNERGIE MPV (22,U6)	6.94 → 7.02						ML5454	Ricambi → 06944	U/U
							ML5455	Ricambi 07632 →	U/U
							ML5456	Ricambi 06945 → Ricambi → 07631	U/U

JUMPY

JUMPY MPV	1.07 →						ML5841	U/U
-----------	--------	--	--	--	--	--	--------	-----

SAXO

SAXO Hatchback (S0,S1)	2.96 → 4.04						ML5149	U/U
------------------------	-------------	--	--	--	--	--	--------	-----

VISA

VISA Hatchback	9.78 → 3.91						ML5019	Y1/X1
----------------	-------------	--	--	--	--	--	--------	-------



DAEWOO



STD			
SPECIAL			

STD			
SPECIAL			

XANTIA

XANTIA Hatchback (X1) 3.93 → 1.98					ML5503 (+)	T1/T1
XANTIA Estate, Break (X1) 6.95 → 1.98					ML5203 (+)	U/U
XANTIA Hatchback (X2) 1.98 → 4.03					ML5204 (+) (+)	U/U
XANTIA Estate, Break (X2) 1.98 → 4.03					ML5430	U/U
					ML5203 (+)	U/U
					ML5204 (+) (+)	U/U
					ML5430	U/U

XM

XM Hatchback (Y3) 5.89 → 6.94	ML5457			U/U	ML5504	T1/T1
XM Estate, Break (Y3) 5.89 → 7.94	ML5457			U/U	ML5505	T1/T1
XM Hatchback (Y4) 5.94 → 10.00	ML5457			U/U	ML5504	T1/T1
XM Estate, Break (Y4) 5.94 → 10.00	ML5457			U/U	ML5505	T1/T1

XSARA

XSARA Hatchback (N1) 4.97 → 3.05	ML5270 → 9.00			U/U	ML5129	S1/S1
XSARA Estate, Break (N2) 10.97 → 8.05	ML5262 9.00 →			U/U	ML5435	S1/S1
XSARA Coupe (N0) 2.98 → 3.05	ML5270 → 9.00			U/U	ML5129	S1/S1
	ML5262 9.00 →			U/U		
	ML5262 9.00 →			U/U		

XSARA PICASSO

XSARA PICASSO MPV (N68) 12.99 →	ML5270 → 9.00			U/U	ML5162	S1/S1
	ML5262 9.00 →			U/U		

ZX

ZX Hatchback (N2) 3.91 → 10.97					ML5255	U/U
ZX Estate, Break (N2) 10.93 → 2.98					ML5033 (+)	U/U
					ML5506	T1/T1

GS

GS Hatchback 9.70 → 7.86					ML5010	Y1/X1
GS Estate, Break 7.71 → 7.86					ML5011	Y1/X1

DACIA**LOGAN MCV**

LOGAN Estate 2.07 →					ML5863 ⁰	
----------------------	--	--	--	--	---------------------	--

SANDERO

SANDERO 6.08 →					ML5864 ⁰	
-----------------	--	--	--	--	---------------------	--

DAEWOO**KALOS**

KALOS Hatchback (KLAS) 9.02 →					ML5714	U/P
--------------------------------	--	--	--	--	--------	-----

LACETTI

LACETTI Hatchback (KLAN) 2.04 →					ML5794	T1/T1
----------------------------------	--	--	--	--	--------	-------

DAEWOO

DAEWOO



	STD				STD			
	SPECIAL							

LANOS

LANOS Hatchback (KLAT) 5.97 →					ML5087		U/U
--------------------------------	--	--	--	--	--------	--	-----

MATIZ

MATIZ Hatchback (KLYA) 9.98 →					ML5098		P/P
--------------------------------	--	--	--	--	--------	--	-----

NEXIA

NEXIA Hatchback (KLETN) 2.95 → 8.97					ML5031		U/U
--------------------------------------	--	--	--	--	--------	--	-----

NUBIRA

NUBIRA Hatchback (KLAJ) 4.97 →					ML5507	5 (+)	T1/T1
NUBIRA Saloon (KLAJ) 4.97 →					ML5095	(+)	U/U
NUBIRA Estate, Break, Wagon (KLAJ) 4.97 →					ML5096		U/U
NUBIRA Saloon (KLAN) 7.03 →					ML5095	(+)	U/U
NUBIRA Estate, Break, Wagon (KLAN) 7.03 →					ML5096		U/U

REZZO

REZZO, TACUMA MPV (KLAU) 9.00 →					ML5513		T1/T1
----------------------------------	--	--	--	--	--------	--	-------

TICO

TICO Hatchback (KLY3) 2.95 → 12.00					ML5051		S1/E1
-------------------------------------	--	--	--	--	--------	--	-------

FIAT

BRAVA

BRAVA Hatchback (182) 10.95 → 12.02					ML5068		U/U
--------------------------------------	--	--	--	--	--------	--	-----

BRAVO

BRAVO Hatchback (182) 10.95 → 2.02					ML5069		U/U
BRAVO Hatchback 11.06 →					ML5784		U/U

CINQUECENTO

CINQUECENTO Hatchback (170) 7.91 → 7.99					ML5081		U/U
--	--	--	--	--	--------	--	-----

CROMA

CROMA Hatchback (154) 12.85 → 12.96					ML5043		Y1/X1
CROMA Estate (194) 6.05 →					ML5795		U/U

DOBLO

DOBLO MPV (119) 3.01 →					ML5448		U/U
					ML5404	(+) Panoramic	U/U

ELBA

ELBA Estate 4.86 → 12.96					ML5064		U/U
---------------------------	--	--	--	--	--------	--	-----

PUNTO / GRANDE PUNTO

GRANDE PUNTO Hatchback (199) 10.05 →					ML5775		S1/S1
---------------------------------------	--	--	--	--	--------	--	-------



FIAT

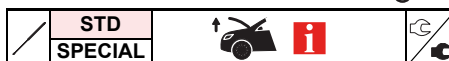

IDEA

IDEA MPV	1.04 →					ML5702		P/S1
----------	--------	--	--	--	--	--------	--	------

MAREA

MAREA Estate, Weekend (185)	9.96 →					ML5078		S1/S1
-----------------------------	--------	--	--	--	--	--------	--	-------

MULTIPLA

MULTIPLA MPV (186)	4.99 →	ML5389			S1/S1	ML5377		U/S1
--------------------	--------	--------	--	--	-------	--------	--	------

PALIO

PALIO Hatchback (178BX)	4.96 →					ML5462		S1/S1
PALIO Estate, Weekend (178DX)	4.96 →					ML5086		S1/S1

PANDA

PANDA Hatchback (141A_)	10.80 → 7.04					ML5016	Ricambi → 6314421, 5370347	Y1/X2
PANDA Hatchback (169)	9.03 →					ML5039	Ricambi 6314422, 5370348 →	Y1/X2
						ML5101		S1/S1

PUNTO

PUNTO Hatchback (176)	9.93 → 9.99					ML5079		U/U
PUNTO Hatchback (188)	9.99 →					ML5164	3	U/U
						ML5165	5	U/U

REGATA

REGATA Estate, Weekend	1.84 → 12.90					ML5041		U/U
------------------------	--------------	--	--	--	--	--------	--	-----

RITMO Bertone

RITMO Bertone Convertible	10.79 → 7.89					ML5055		Y1/X1
---------------------------	--------------	--	--	--	--	--------	--	-------

RITMO

RITMO I Hatchback (138A)	1.78 → 12.87					ML5010		Y1/X1
RITMO II Hatchback (138A)	10.82 → 12.88					ML5011		Y1/X1
						ML5501	(+)	Y2/D

SEDICI

SEDICI Closed Off-Road Vehicle	6.06 →					ML5779		U/U
--------------------------------	--------	--	--	--	--	--------	--	-----

SEICENTO

SEICENTO Hatchback (187)	1.98 →					ML5081		U/U
SEICENTO Box, Van (187)	1.98 →					ML5081		U/U

STILO

STILO Hatchback (192)	10.01 →	ML5038			U/U	ML5280	3	U/U
						ML5281	5	U/U
						ML5538	(+) Fixed rear window	U/U
						ML5443	(+) Opening rear window	U/U
						ML5537	(+)	U/U
STILO Estate, Multi Wagon (192)	1.03 →					ML5387	(-) Rear window	U/U

FIAT

FIAT



TEMPRA

TEMPRA Estate, S.W., SW (159)	3.90 → 8.96					ML5282		U/U
-------------------------------	-------------	--	--	--	--	---------------	--	-----

TIPO

TIPO Hatchback (160)	7.87 → 8.96					ML5066	160.AE	U/U
						ML5013	Ricambi → 43619, 2129639, 2162444, 4075919, 4546776	U/U
						ML5014	Ricambi 43620, 2129640, 2162445, 4075920, 4546777 →	U/U

ULYSSE

ULYSSE MPV (220)	6.94 → 8.02					ML5283		U/U
ULYSSE MPV (179AX)	8.02 →					ML5458		U/U

UNO

UNO Hatchback (146A/E)	1.83 → 8.00					ML5040	→ 8.89	U/U
						ML5065	9.89 →	U/U

126

126 Special Design, Bambino	9.87 → 6.96					ML5006		Y2/X2
-----------------------------	-------------	--	--	--	--	---------------	--	-------

127

127 Hatchback	6.71 → 12.86					ML5010	5	Y1/X1
						ML5009	4.77 → 9.81, 3	Y1/X1
						ML5015	4.77 → 9.81, 3	Y1/X1
						ML5034	9.81 → 3	Y1/X1
127 Estate, Panorama	1.77 → 12.86					ML5015		Y1/X1

128

128 Saloon	3.69 → 12.84					ML5003		U/U
128 Estate, Familiare	10.69 → 10.82					ML5011		Y1/X1

131

131 Estate, Familiare/ Panorama	3.75 → 4.85					ML5042		Y1/X1
---------------------------------	-------------	--	--	--	--	---------------	--	-------

132

132 Saloon	4.72 → 12.82		ML5030		Y1/X1	ML5018		Y1/X1
------------	--------------	--	---------------	--	-------	---------------	--	-------

147

147 Hatchback	10.76 → 12.95		ML5030		Y1/X1	ML5018		Y1/X1
---------------	---------------	--	---------------	--	-------	---------------	--	-------

500

500	10.07 →					ML5785		S1/S1
-----	---------	--	--	--	--	---------------	--	-------

DUCATO

DUCATO Bus, Panorama (280)	7.82 → 8.90					ML5074		F1/Y3
DUCATO Box (280)	1.82 → 8.90					ML5074		F1/Y3
DUCATO Bus, Panorama (290)	6.90 → 5.94					ML5074		F1/Y3
DUCATO Box (290)	3.89 → 5.94					ML5074		F1/Y3

TALENTO

TALENTO Bus (290)	3.89 → 3.94					ML5074		F1/Y3
TALENTO Box (290)	3.89 → 3.94					ML5074		F1/Y3



FORD



STD
SPECIAL



STD
SPECIAL



FORD

ESCORT

ESCORT III Hatchback (GAA) 9.80 → 7.86					ML5463 (-)	S1/S1
					ML5464 (+)	S1/S1
ESCORT III Turnier, Break (AWA)	9.80 → 2.86				ML5173 XR3i	U/U
					ML5285 (-)	U/U
					ML5286 (+)	U/U
ESCORT IV Hatchback (ABFT,AWF,GAF)	10.85 → 10.90				ML5463 (-)	S1/S1
					ML5464 (+)	S1/S1
					ML5201 (+)	F1 (N): 400 U/U
					ML5200 (+)	F1 (N): 415 U/U
					ML5173 XR3i	U/U
ESCORT IV Turnier, Break (AVF,AWF)	10.85 → 10.90				ML5285	U/U
					ML5286 (+)	U/U
ESCORT IV Convertible (ALF)	1.86 → 7.90				ML5173 XR3i	U/U
ESCORT V Hatchback (GAL)	7.90 → 12.92				ML5171 (-)	U/U
					ML5172 (+)	U/U
ESCORT V Turnier, Break (AVL,GAL)	7.90 → 12.92				ML5174	U/U
ESCORT VI Hatchback (GAL)	9.92 → 1.95				ML5252	U/U
					ML5109 (+)	U/U
ESCORT VI Turnier, Break (GAL)	9.92 → 1.95				ML5161	U/U
ESCORT VII Hatchback (AAL,ABL,GAL)	1.95 → 10.98				ML5252	U/U
					ML5109 (+)	U/U
ESCORT VII Turnier, Clipper (ANL,GAL)	1.95 → 2.99				ML5161	U/U

FIESTA

FIESTA II Hatchback (FBD)	9.83 → 11.89				ML5465 (-)	S1/S1
					ML5023 (+)	U/U
FIESTA III Hatchback (GFJ)	1.89 → 1.97				ML5141 → 4.93, (-)	U/U
					ML5142 → 4.93, (+)	U/U
					ML5143 5.93 → 3.96, (-)	U/U
					ML5147 5.93 → 3.96, (+)	U/U
FIESTA IV Hatchback (JA_,JB_)	8.95 → 1.02				ML5147	U/U
FIESTA V Hatchback (JH_)	11.01 →				ML5205 3	U/U
					ML5206 11.01 → 11.02, 5	U/U
					ML5207 12.02 → , 5	U/U
FIESTA VI	10.08 →				ML5651	U/U
FIESTA, Courier Box (JV_)	5.98 →				ML5147	U/U
FIESTA Van	10.03 →				ML5205	U/U
FIESTA Van	1.09 →				ML5651	U/U

FOCUS

FOCUS Hatchback (DAW,DBW)	10.98 → 11.04				ML5415 → 11.02	U/U
					ML5224 12.02 →	U/U
FOCUS Saloon (DFW)	2.99 → 3.05				ML5466	S1/S1
					ML5467	S1/S1
FOCUS Turnier, Clipper (DNW)	2.99 → 1.05				ML5168 (-)	U/U
					ML5169 (+)	U/U
FOCUS II Hatchback	11.04 →				ML5416	U/U
FOCUS II Saloon	4.05 →				ML5786	U/U
FOCUS II Turnier	11.04 →				ML5664	U/U

FORD

FORD



	STD				STD			
	SPECIAL							

FOCUS C-MAX

FOCUS C-MAX MPV	10.03 → 3.07					ML5288		U/U
-----------------	--------------	--	--	--	--	--------	--	-----

C-MAX

C-MAX MPV	2.07 →					ML5288		U/U
-----------	--------	--	--	--	--	--------	--	-----

FUSION

FUSION Turnier (JU_)	8.02 →					ML5289	(+)	U/U
----------------------	--------	--	--	--	--	--------	-----	-----

GALAXY

GALAXY MPV (WGR)	3.95 → 5.06					ML5127		U/U
GALAXY MPV	5.06 →					ML5771		P/P

GT

GT Coupe	6.03 →		ML5696		P/U			
----------	--------	--	--------	--	-----	--	--	--

KA

KA Hatchback (RB_)	9.96 → 11.08					ML5136		U/U
--------------------	--------------	--	--	--	--	--------	--	-----

KUGA

KUGA	3.08 →		ML5650		P/U	ML5654		P/U
------	--------	--	--------	--	-----	--------	--	-----

MONDEO

MONDEO I Hatchback (GBP)	2.93 → 8.96					ML5126		S1/U
MONDEO I Saloon (GBP)	2.93 → 8.96					ML5290		U/U
MONDEO I Turnier, Clipper (BNP)	1.93 → 8.96					ML5431	(+)	U/U
MONDEO II Hatchback (BAP)	9.96 → 11.00					ML5332		U/U
MONDEO II Saloon (BFP)	9.96 → 11.00					ML5176		S1/U
MONDEO II Turnier, Clipper (BNP)	9.96 → 11.00					ML5290		U/U
MONDEO III Hatchback (B5Y)	11.00 → 8.07		ML5330		U/U	ML5373	1.02 → (-)	U/U
						ML5231	→ 12.01 (-)	U/U
						ML5233	(+) Automatic wiper	U/U
						ML5232	(+)	U/U
MONDEO III Saloon (B4Y)	11.00 → 8.07		ML5330		U/U	ML5502		S1/S1
MONDEO III Turnier, Clipper (BWY)	11.00 → 8.07		ML5330		U/U	ML5374		U/U
MONDEO IV Hatchback	3.07 →					ML5797		T1/T1
MONDEO IV Saloon	3.07 →					ML5704		T1/T1
MONDEO IV Turnier	3.07 →					ML5772		T1/P

ORION

ORION I Saloon (AFD)	7.83 → 3.86					ML5611		Y1/D
ORION II Saloon (AFF)	12.85 → 8.90					ML5611		Y1/D

PUMA

PUMA Coupe (EC_)	3.97 →					ML5399		U/U
------------------	--------	--	--	--	--	--------	--	-----

SCORPIO

SCORPIO, GRANADA I Hatchback (GAE, GGE)	4.85 → 9.94					ML5110		U/U
						ML5612	(+) , (+)	U/U
						ML5291	(+)	U/U



F50

MONROE	STD		↑ ↓	i	↺ ↻	STD		i	↑ ↓	↺ ↻
	SPECIAL					SPECIAL				
SCORPIO, GRANADA I Turnier, Break (GGE)	5.88	→ 9.94				ML5388				U/U
SCORPIO II Saloon (GFR,GGR)	10.94	→ 8.98				ML5292				U/U
SCORPIO II Turnier, Break (GGR,GNR)	10.94	→ 8.98				ML5388				U/U

SIERRA

SIERRA Hatchback (GBC)	8.82	→ 2.87				ML5080	(-)			U/U
						ML5253	(+)			U/U
						ML5539	XR4i, (+)	F1 (N): 720		U/U
						ML5614	XR4i, (+)	F1 (N): 780		U/U
SIERRA Hatchback (GBC,GBG)	1.87	→ 3.93				ML5080	(-)			U/U
						ML5253	(+)			U/U
						ML5614	(+)			U/U
SIERRA Turnier, Break (BNG)	1.87	→ 2.93				ML5293	(-)			U/U
						ML5294	(+)			U/U

S-MAX

S-MAX MPV	5.06	→				ML5770				P/P
-----------	------	---	--	--	--	--------	--	--	--	-----

TOURNEO CONNECT

TOURNEO CONNECT MPV	6.02	→				ML5295				U/U
---------------------	------	---	--	--	--	--------	--	--	--	-----

TRANSIT CONNECT

TRANSIT CONNECT Box	6.02	→				ML5295				U/U
---------------------	------	---	--	--	--	--------	--	--	--	-----

TRANSIT

TRANSIT Bus (T_)	11.85	→ 9.92				ML5429	(-)			U/U
						ML5076	(+)			U/U
TRANSIT Box, Van (T_)	9.85	→ 9.92				ML5429				U/U
TRANSIT Bus (FB_ ,FC_ ,FD_ ,FS_ ,FZ_)	1.00	→ 5.06				ML5514				U/U
TRANSIT Bus	7.06	→				ML5514				U/U
TRANSIT Box	7.06	→				ML5514				U/U

F50

POLONEZ

POLONEZ	1.78	→				ML5001	OE n°: 4369120			Y1/X1
						ML5071	OE n°: 21458			Y1/D
POLONEZ ATU	1.95	→ 1.02				ML5058				Y1/X1
POLONEZ CARGO	1.93	→ 1.02				ML5045				U/U
POLONEZ CARO	1.93	→				ML5007	OE n°: 041190, 077187			Y1/X1
						ML5060	OE n°: 77187			Y1/X1
						ML5070	OE n°: 21457			Y1/D
POLONEZ CARO PLUS	1.97	→				ML5075	(+)			Y1/D
POLONEZ COMBI	1.99	→				ML5090				U/U
POLONEZ TRUCK	1.93	→				ML5027	OE n°: 043882, 01171783			U/U
						ML5046	OE n°: 21273			U/U
						ML5052	OE n°: 21331			U/U
						ML5053	OE n°: 21333			U/U
						ML5059	OE n°: 21377			Y2/X2
						ML5062	OE n°: 21406			U/U

HONDA



HONDA

ACCORD

ACCORD VII Hatchback (CH) 12.99 → 12.02			ML5787		T1/T1
--	--	--	---------------	--	-------

CIVIC

CIVIC III Hatchback (EC,ED,EE) 9.87 → 10.93			ML5567	3	S1/S1
CIVIC IV Hatchback (EG) 10.91 → 11.95			ML5568	3	S1/S1
CIVIC IV Hatchback, Fastback (MA,MB) 9.94 → 1.97			ML5405	5	U/U
CIVIC V Hatchback (EJ9,EK1/ 3/4) 10.95 → 2.01			ML5405	5 F1 (N): 425	U/U
			ML5214	5 F1 (N): 460	S1/S1
CIVIC V Estate, Aerodeck (MC) 4.98 → 2.01			ML5122	5	U/U
CIVIC VI Hatchback (EP_,EU_) 1.00 → 9.05			ML5396	3	U/U
			ML5371	5	U/U
			ML5159	5 D14Z5,D16V2	S1/S1
CIVIC VII Hatchback 9.05 →			ML5836		T1/T1

CONCERTO

CONCERTO Hatchback (HW) 8.89 → 10.96			ML5508		T1/T1
			ML5192	(+)	U/U

CR-V

CR-V I Closed Off-Road Vehicle (RD) 10.95 → 2.02				ML5447	(=) Rear window	T1/T1
CR-V II Closed Off-Road Vehicle 3.02 → 9.06				ML5910⁰		
CR-V III 10.06 →				ML5866⁰		

JAZZ

JAZZ Hatchback (GD) 3.02 →			ML5911⁰		
-----------------------------	--	--	---------------------------	--	--

HYUNDAI

ACCENT

ACCENT, PONY Hatchback (X-3) 10.94 → 1.00			ML5157		U/U
--	--	--	---------------	--	-----

COUPE

COUPE Coupe (GK) 8.01 →			ML5814		U/U
			ML5378		U/S1
			ML5379	(+)	U/S1

ELANTRA

ELANTRA Hatchback (XD) 6.00 →			ML5569		S1/S1
			ML5380	(+)	U/S1

GETZ

GETZ Hatchback (TB) 9.02 →			ML5759		T1/T1
-----------------------------	--	--	---------------	--	-------

i10

i10 10.07 →			ML5867⁰		
--------------	--	--	---------------------------	--	--



IZ

	STD				STD			
	SPECIAL							

i20

i20	8.08 →					ML5868 ⁰		
-----	--------	--	--	--	--	---------------------	--	--

i30

i30	10.07 →					ML5869 ⁰		
-----	---------	--	--	--	--	---------------------	--	--

LANTRA

LANTRA II Estate, Break, Wagon (J2)	2.96 →					ML5296		U/U
-------------------------------------	--------	--	--	--	--	--------	--	-----

MATRIX

MATRIX Estate (FC)	6.01 →					ML5616		S1/U
--------------------	--------	--	--	--	--	--------	--	------

SANTA FÉ

SANTA FÉ Closed Off-Road Vehicle (SM)	11.00 →	ML5382		U/S1	ML5381		U/S1
SANTA FÉ Closed Off-Road Vehicle	3.06 →	ML5660		P/U	ML5297	(=) Rear window	U/U

SONATA

SONATA III Saloon (EF)	10.01 → 5.05	ML5570		S1/S1	ML5154		U/U
SONATA V Saloon	1.05 →	ML5758		P/U	ML5761		U/U

TRAJET

TRAJET MPV (FO)	3.00 →					ML5816		T1/T1
-----------------	--------	--	--	--	--	--------	--	-------

TUCSON

TUCSON Closed Off-Road Vehicle (JM)	8.04 →				ML5760		P/U
					ML5762	(=) Rear window	P/U

INNOCENTI**ELBA**

ELBA Estate (146)	8.91 →					ML5064		U/U
-------------------	--------	--	--	--	--	--------	--	-----

MINI

MINI Special Design	5.74 → 2.82					ML5056		Y1/X1
---------------------	-------------	--	--	--	--	--------	--	-------

MILLE

MILLE	1.94 →					ML5040		U/U
-------	--------	--	--	--	--	--------	--	-----

IZ**2126**

2126	1.93 →	ML5114		U/U	ML5024		U/U
------	--------	--------	--	-----	--------	--	-----

2717

2717	1.93 →	ML5114		U/U	ML5024		U/U
------	--------	--------	--	-----	--------	--	-----

JEEP



	STD			STD		
	SPECIAL					

JEEP

CHEROKEE

CHEROKEE Closed Off-Road Vehicle (XJ) 10.96 →					ML5591		U/Q
--	--	--	--	--	--------	--	-----

KIA

CARENS

CARENS II MPV (FJ) 7.02 →					ML5711		U/U
----------------------------	--	--	--	--	--------	--	-----

CARNIVAL

CARNIVAL, SEDONA II MPV 10.01 →	ML5706		P/U	ML5709	7.02 → 9.05		U/U
----------------------------------	--------	--	-----	--------	-------------	--	-----

CEE'D

CEE'D Hatchback 12.06 →					ML5839		U/K
CEE'D Estate 9.07 →					ML5839		U/K

PRO CEE'D

PRO CEE'D (ED) 2.08 →					ML5839		U/K
------------------------	--	--	--	--	--------	--	-----

CERATO

CERATO Hatchback 4.04 →					ML5713		U/U
--------------------------	--	--	--	--	--------	--	-----

MAGENTIS

MAGENTIS Saloon (GD) 5.01 →					ML5710		U/U
------------------------------	--	--	--	--	--------	--	-----

PICANTO

PICANTO Hatchback 4.04 →					ML5708		U/U
---------------------------	--	--	--	--	--------	--	-----

RIO

RIO II Hatchback 3.05 →					ML5712		P/U
--------------------------	--	--	--	--	--------	--	-----

SORENTO

SORENTO Closed Off-Road Vehicle (JC) 8.02 →	ML5705		S1/U	ML5707			U/U
					ML5823	(=) Rear window	S1/S1

SPORTAGE

SPORTAGE Closed Off-Road Vehicle 9.04 →					ML5912 ⁰		
--	--	--	--	--	---------------------	--	--

LADA

110

110 Saloon 1.95 →	ML5298		U/U	ML5025			U/U
	ML5025	→ 1.94	U/U	ML5107			U/U

111

111 Estate 1.95 →	ML5298		U/U	ML5025			U/U
	ML5025	→ 1.94	U/U	ML5107			U/U



LANCIA



STD	
SPECIAL	

STD	
SPECIAL	

112

112 Hatchback 1.95 →	ML5025 → 1.94	U/U	ML5108	U/U
-----------------------	---------------	-----	--------	-----

NADESCHDA

NADESCHDA Estate (2120) 12.97 →			ML5299	U/U
----------------------------------	--	--	--------	-----

NIVA

NIVA Closed Off-Road Vehicle (2121) 12.76 →	ML5114	U/U	ML5025 → 1.94	U/U
			ML5024 1.94 →	U/U

NOVA

NOVA, KALINKA Estate (2104) 9.85 →			ML5298	U/U
-------------------------------------	--	--	--------	-----

SAMARA

SAMARA Hatchback (2108,2109) 1.86 →	ML5114	U/U	ML5024	U/U
--------------------------------------	--------	-----	--------	-----

OKA

OKA 1111 1.90 →	ML5114	U/U	ML5025	U/U
------------------	--------	-----	--------	-----

LANCIA**DEDRA**

DEDRA Saloon (835) 4.89 → 7.99			ML5617	N/N
DEDRA Estate, SW (835) 7.94 → 7.99			ML5300	U/U

DELTA

DELTA I Hatchback (831AB0) 9.79 → 1.94			ML5618	N/N
DELTA II Hatchback (836) 6.93 → 9.99			ML5303	S1/S1
			ML5540 (+)	S2/S2

KAPPA

KAPPA Saloon (838A) 8.94 → 10.01	ML5482	S1/S1	ML5483	S1/S1
KAPPA Estate, SW (838B) 7.96 → 10.01	ML5482	S1/S1	ML5541	S1/S1
KAPPA Coupe (838) 7.96 → 3.01	ML5482	S1/S1		

LYBRA

LYBRA Saloon (839AX) 7.99 →	ML5484	S1/S1	ML5301	U/U
LYBRA Estate, SW (839BX) 7.99 →	ML5484	S1/S1	ML5302	U/U

MUSA

MUSA MPV 10.04 →			ML5702	P/S1
-------------------	--	--	--------	------

PHEDRA

PHEDRA MPV (179) 9.02 →			ML5496	Y1/D
--------------------------	--	--	--------	------

PRISMA

PRISMA Saloon (831AB0) 1.83 → 2.92			ML5619	N/N
-------------------------------------	--	--	--------	-----

Y10

Y10 Hatchback (156) 3.85 → 12.95			ML5139	S1/S1
-----------------------------------	--	--	--------	-------

LANCIA

LANCIA



Y

Y Hatchback (840A) 11.95 → 9.03					ML5159		S1/S1
----------------------------------	--	--	--	--	--------	--	-------

YPSILON

YPSILON Hatchback 10.03 →					ML5703		P/U
----------------------------	--	--	--	--	--------	--	-----

ZETA

ZETA MPV (220) 5.95 → 9.02					ML5305		U/U
-----------------------------	--	--	--	--	--------	--	-----

LAND ROVER

DISCOVERY

DISCOVERY III Closed Off-Road Vehicle 7.04 →		ML5870 ⁰			ML5871 ⁰		
---	--	---------------------	--	--	---------------------	--	--

RANGE ROVER

RANGE ROVER I Closed Off-Road Vehicle 7.70 → 7.94					ML5306		U/U
RANGE ROVER II Closed Off-Road Vehicle (LP) 7.94 → 3.02					ML5649		U/U
RANGE ROVER III Closed Off-Road Vehicle (LM) 3.02 →					ML5872 ⁰		

MAZDA

121

121 III Hatchback (JASM, JBSM) 3.96 →					ML5147		U/U
--	--	--	--	--	--------	--	-----

2

2 Hatchback (B2W) 4.03 →					ML5765		T1/T1
2 (DE) 10.07 →					ML5873 ⁰		

323

323 III Hatchback (BF) 8.85 → 11.91					ML5542	⇄	U/U
					ML5403	⇄	U/U

323 P

323 P V Hatchback (BA) 10.96 →					ML5876 ⁰	⇄	
					ML5877 ⁰	⇄	

323 F

323 F V Coupe (BA) 7.94 → 9.98					ML5874 ⁰	⇄	
					ML5875 ⁰	⇄	
323 F, 323 F/P VI Hatchback (BJ) 9.98 → 5.04					ML5843	⇄	S1/C2
					ML5842	⇄	S1/C1

3

3 Hatchback (BK14) 10.03 →					ML5763		T1/T1
3 Saloon (BK12) 2.04 →					ML5764		U/U

626

626 V Hatchback (GF) 5.97 → 10.02					ML5847	⇄	B2/A2
					ML5848	⇄	B1/A1



MERCEDES-BENZ



STD		
SPECIAL		

STD		
SPECIAL		

6

6 Hatchback (GG) 8.02 →					ML5683		U/U
6 Saloon (GG) 6.02 →					ML5683		U/U
6 Estate, Station Wagon (GY) 8.02 →					ML5684		U/U

MX-5

MX-5 III Convertible (NC) 3.05 →					ML5810		U/U
-----------------------------------	--	--	--	--	--------	--	-----

MERCEDES-BENZ

A-KLASSE

A-CLASS Hatchback (W168) 7.97 → 8.04					ML5186	OE n°: 1689800164	U/U
					ML5187	OE n°: 1689801164	U/U
					ML5188	OE n°: 1689801264	U/U
A-CLASS Hatchback (W169) 9.04 →					ML5717		P/U

B-KLASSE

B-CLASS Hatchback (W245) 3.05 →					ML5718		U/U
----------------------------------	--	--	--	--	--------	--	-----

VANEO

VANEO MPV (414) 2.02 →					ML5543		U/U
-------------------------	--	--	--	--	--------	--	-----

190

190 Saloon (W201) 10.82 → 8.93	ML5102			Y1/V			
---------------------------------	--------	--	--	------	--	--	--

C-KLASSE

C-CLASS T-Model, Break (S202) 6.96 → 3.01					ML5307		U/U
C-CLASS Saloon (W203) 5.00 →	ML5577			U/P			
	ML5560			U/U			
C-CLASS T-Model (S203) 3.01 →	ML5577			U/P	ML5468		S1/S1
	ML5560			U/U			
C-CLASS Coupe, Coupe Sport, Sportcoupe, Sportscoupe (CL203) 3.01 →	ML5577			U/P	ML5673		U/U
	ML5560			U/U			
C CLASS Saloon (W204) 1.07 →	ML5715			U/U			
C-Class T-Model(S204) 8.07 →					ML5719		U/P

CLK

CLK Coupe (C208) 6.97 → 7.02	ML5308			U/U			
CLK Convertible (A208) 3.98 → 3.02	ML5308			U/U			
CLK Convertible (A209) 2.03 →	ML5577			U/P	ML5808		S1/S1
	ML5560			U/U			

KOMBI

KOMBI T-Model, Break (S124) 9.85 → 7.93					ML5913 ^o		
--	--	--	--	--	---------------------	--	--

E-KLASSE

E-CLASS Saloon (W210) 6.95 → 3.02	ML5438			S1/S1			
E-CLASS T-Model, Break (S210) 6.96 → 3.03	ML5438			S1/S1	ML5674		S1/S1

MERCEDES-BENZ

MERCEDES-BENZ



		STD SPECIAL					STD SPECIAL				
E-CLASS Saloon (W211)	3.02 →	ML5309									
E-CLASS T-Model (S211)	3.03 →	ML5309									

S-KLASSE

S-CLASS Saloon (W220)	10.98 → 8.05	ML5620					ML5878⁰				
S-CLASS Saloon (W221)	10.05 →						ML5879⁰				
S-CLASS Coupe (C215)	3.99 → 3.06	ML5561					ML5813				S1/S1

CLS

CLS Coupe (C219)	10.04 →	ML5309									
------------------	---------	---------------	--	--	--	--	--	--	--	--	--

SL

SL Convertible (R230)	10.01 →	ML5811					ML5800	Ch. n° → F 122820			U/U
							ML5801	Ch. n° F 109966 → (-)			U/U
							ML5802	Ch. n° F 109966 → (+)			U/U

SLK

SLK Convertible (R170)	9.96 → 4.04						ML5680				U/U
SLK Convertible (R171)	3.04 →	ML5799					ML5818				U/U
		ML5798									U/U

M-KLASSE

M-CLASS Closed Off-Road Vehicle (W163)	2.98 → 6.05	ML5559					ML5530				U/P
M-CLASS Closed Off-Road Vehicle (W164)	7.05 →						ML5806	(-)			U/P

V-KLASSE

V-CLASS MPV (638/2)	9.96 → 7.03						ML5621	(-)			U/U
							ML5329	(+)			U/U

VIANO

VIANO MPV (W639)	9.03 →						ML5716				U/U
------------------	--------	--	--	--	--	--	---------------	--	--	--	-----

VITO

VITO Bus (638)	2.96 → 7.03						ML5328	(-)			U/U
							ML5329	(+)			U/U
VITO Box (638)	3.97 → 7.03						ML5328	(-)			U/U
							ML5329	(+)			U/U
VITO Bus (W639)	9.03 →						ML5716				U/U
VITO Box (W639)	9.03 →						ML5716				U/U

MG

METRO

METRO Hatchback	5.82 → 9.90						ML5041				U/U
-----------------	-------------	--	--	--	--	--	---------------	--	--	--	-----

MG ZR

MG ZR Hatchback	6.01 →						ML5434				U/U
-----------------	--------	--	--	--	--	--	---------------	--	--	--	-----

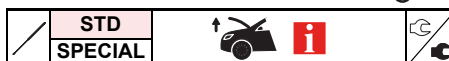
**MG ZS**

MG ZS Hatchback	7.01 →					ML5410		S1/S1
						ML5622	(+)	S1/S1

MG ZT

MG ZT Saloon	6.01 →					ML5411		S1/U
--------------	--------	--	--	--	--	--------	--	------

MG ZT-T

MG ZT- Estate, T	10.01 →					ML5412	(+) Opening rear window	S1/U
						ML5623	(-) Rear window	S1/S1

MINI**MINI**

MINI Hatchback	6.01 →					ML5564		U/P
MINI (R52)	7.04 →					ML5406		U/U
MINI (R56)	10.06 →					ML5406		U/U

MITSUBISHI**CARISMA**

CARISMA Hatchback (DA_)	7.95 → 6.06					ML5278		U/U
						ML5354	(+)	U/U

COLT

COLT IV Hatchback (CA_A)	4.92 → 4.96					ML5587		S1/S1
COLT VI Hatchback	6.04 →					ML5661	3	U/U
						ML5662	5	U/U

GALANT

GALANT IV Saloon (E3_A)	11.87 → 3.93					ML5578		U/U
-------------------------	--------------	--	--	--	--	--------	--	-----

LANCER

LANCER Estate, Kombi	9.03 →					ML5757		U/U
----------------------	--------	--	--	--	--	--------	--	-----

OUTLANDER

OUTLANDER Closed Off-Road Vehicle	5.03 →					ML5757		U/U
OUTLANDER Closed Off-Road Vehicle	11.06 →					ML5776		U/P

SPACE STAR

SPACE STAR MPV (DG0)	6.98 →					ML5353		U/U
----------------------	--------	--	--	--	--	--------	--	-----

MOSKWICZ**2141**

2141	1.86 → 1.98					ML5004		U/U
------	-------------	--	--	--	--	--------	--	-----

2335

2335	1.86 →					ML5004		U/U
------	--------	--	--	--	--	--------	--	-----

NISSAN



NISSAN

ALMERA

ALMERA I Hatchback (N15) 7.95 → 7.00					ML5880°	
ALMERA II Hatchback (N16) 1.00 →					ML5881°	
ALMERA II Saloon (N16) 7.00 →					ML5672	U/U
					ML5672	U/U

ALMERA TINO

ALMERA TINO MPV (V10) 8.00 →					ML5579	S1/S1
-------------------------------	--	--	--	--	--------	-------

KUBISTAR

KUBISTAR MPV (X76) 8.03 →					ML5837	T1/T1
----------------------------	--	--	--	--	--------	-------

MAXIMA QX

MAXIMA QX Saloon (A32) 3.94 → 8.00		ML5624		P/T1		
-------------------------------------	--	--------	--	------	--	--

MICRA

MICRA Hatchback (K11) 1.92 → 2.03					ML5882° (+)	
					ML5883° (+)	
					ML5884° (+)	
					ML5885° (+)	
MICRA Hatchback (K12) 1.03 →					ML5360	U/U

NOTE

NOTE MPV (E11) 3.06 →					ML5701	S1/U
------------------------	--	--	--	--	--------	------

PATHFINDER

PATHFINDER Closed Off-Road Vehicle (R50) 9.97 → 12.04					ML5781	U/S1
					ML5700 (=) Rear window	U/U

PRIMERA

PRIMERA Hatchback (P10) 6.90 → 6.96					ML5317	U/U
					ML5318 (+)	U/U
					ML5324 (+)	U/U
PRIMERA Saloon (P10) 6.90 → 6.96					ML5524	T1/T1
					ML5525 (+)	T1/T1
PRIMERA Estate, Break, Traveller (W10) 7.90 → 3.98					ML5588	S1/S1
PRIMERA Hatchback (P11) 9.96 → 7.02					ML5580 (+)	U/U
					ML5433 9.96 → 12.98	U/U
					ML5423 1.99 →	U/U
PRIMERA Saloon (P11) 6.96 → 12.01					ML5321	U/U
					ML5322 (+)	U/U
PRIMERA Estate, Break, Traveller (WP11) 6.96 → 12.01					ML5581	U/U
PRIMERA Hatchback (P12) 1.02 →					ML5086	S1/S1
PRIMERA Saloon (P12) 1.02 →					ML5352	U/U
PRIMERA Estate, Traveller (WP12) 1.02 →					ML5413	S1/U

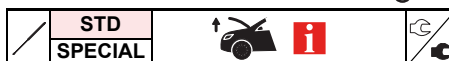

OPEL

**QASHQAI**

QASHQAI MPV 2.07 →					ML5890 ⁰		
---------------------	--	--	--	--	---------------------	--	--

SERENA

SERENA MPV (C23M) 11.92 →					ML5582		U/U
----------------------------	--	--	--	--	--------	--	-----

SUNNY

SUNNY II Estate, Break, Traveller (B12) 1.86 → 6.91					ML5409		U/U
--	--	--	--	--	--------	--	-----

X-TRAIL

X-TRAIL Closed Off-Road Vehicle (T30) 6.01 →					ML5809		S1/S1
---	--	--	--	--	--------	--	-------

PRIMASTAR

PRIMASTAR Bus, Van (X83) 3.01 →					ML5516		T1/T1
PRIMASTAR Box (X83) 9.02 →					ML5516		T1/T1

OPEL**AGILA**

AGILA Estate (H00) 9.00 →					ML5088		E2/E3
					ML5089		E2/E3
AGILA 9.07 →					ML5887 ⁰		
					ML5886 ⁰		

ASCONA

ASCONA C Hatchback (84_,89_) 9.81 → 8.88					ML5390		U/U
					ML5395		U/U
					ML5391		U/U

ASTRA

ASTRA F Hatchback (53_,54_,58_,59_) 9.91 → 1.98					ML5077		U/U
ASTRA F Estate (51_,52_) 9.91 → 1.98					ML5156		U/U
					ML5125		U/U
ASTRA G Hatchback (F08_,F48_) 2.98 → 12.09					ML5166		U/U
ASTRA G Estate (F35_) 2.98 → 12.09					ML5167		U/U
ASTRA H Hatchback 3.04 →				ML5720			U/U
ASTRA H Hatchback, GTC 3.05 →				ML5720			U/U
ASTRA H Saloon 8.04 →				ML5720			U/U
ASTRA H Convertible, TwinTop 9.05 →				ML5720			U/U
					ML5138		U/U
					ML5669		U/U
					ML5805		P/U
					ML5721		U/U
					ML5723		S1/S1

ASTRA F CLASSIC

ASTRA F CLASSIC Hatchback 1.98 → 8.02					ML5077		U/U
ASTRA F CLASSIC Estate 1.98 → 1.05					ML5156		U/U
					ML5125		U/U

ASTRA H

ASTRA H Saloon 2.07 →				ML5720			U/U
------------------------	--	--	--	--------	--	--	-----

OPEL

OPEL



ANTARA

ANTARA Closed Off-Road Vehicle	5.06 →					ML5888 ⁰		
--------------------------------	--------	--	--	--	--	---------------------	--	--

CALIBRA

CALIBRA A Coupe (85_)	6.90 → 7.97					ML5367		U/U
-----------------------	-------------	--	--	--	--	--------	--	-----

CORSA

CORSA A Hatchback (93_,94_,98_,99_)	9.82 → 3.93					ML5585 (-)	F1 (N): 560	O/O
						ML5527 (+)	F1 (N): 620	O/O
						ML5586 (+)	F1 (N): 640	O/O
CORSA B Hatchback (73_,78_,79_,F35_)	3.93 → 9.00					ML5242 3	(-)	U/U
						ML5054 3	(+)	U/U
						ML5144 5		U/U
CORSA C Hatchback (F08,F68)	9.00 →					ML5120		U/U
CORSA D Hatchback	7.06 →					ML5827 3		U/U
						ML5807 5		U/U

FRONTERA

FRONTERA B Closed Off-Road Vehicle (6B_)	10.98 →					ML5825		S1/S1
--	---------	--	--	--	--	--------	--	-------

GT

GT Coupe	9.68 → 8.73		ML5696		P/U			
----------	-------------	--	--------	--	-----	--	--	--

KADETT

KADETT E Hatchback (33_,34_,43_,44_)	9.84 → 8.91					ML5243 (-)		U/U
						ML5031 (+)		U/U
						ML5244 (+)	(+)	U/U
KADETT E Estate (35_,36_,45_,46_)	9.84 → 8.91					ML5528 Ch. n° → J2502492, (+)		M/O
						ML5835 Ch. n° → J2502492, -JE100000, (-)		M/O
						ML5834 Ch. n° → J2502492, -JE100000, (+)		M/O
						ML5407 Ch. n° → J2502493, -JE100001 →		U/U

MERIVA

MERIVA MPV	5.03 → 5.10					ML5119		U/U
------------	-------------	--	--	--	--	--------	--	-----

OMEGA

OMEGA A Saloon (16_,17_,19_)	9.86 → 4.94					ML5366 Ch. n° → N1145948		U/U
						ML5365 Ch. n° N1145949 →		U/U
OMEGA A Estate (66_,67_)	9.86 → 4.94					ML5408 Ch. n° → N1145948		U/U
						ML5365 Ch. n° N1145949 →		U/U
OMEGA B Saloon (25_,26_,27_)	3.94 → 7.03					ML5210		U/U
OMEGA B Estate (21_,22_,23_)	3.94 → 7.03					ML5103		U/U

REKORD

REKORD E Estate (61_,66_,67_)	8.77 → 8.86					ML5398		U/U
-------------------------------	-------------	--	--	--	--	--------	--	-----

SENATOR

SENATOR B Saloon (29_)	9.87 → 9.93					ML5366 Ch. n° → N1145948		U/U
						ML5365 Ch. n° N1145949 →		U/U

SIGNUM

SIGNUM Hatchback	5.03 →		ML5345		U/U	ML5817		P/U
------------------	--------	--	--------	--	-----	--------	--	-----



PEUGEOT

**SINTRA**

SINTRA MPV	11.96 → 4.99					ML5515		U/U
------------	--------------	--	--	--	--	--------	--	-----

TIGRA

TIGRA Coupe (95_)	7.94 → 12.00					ML5369		U/U
-------------------	--------------	--	--	--	--	--------	--	-----

VECTRA

VECTRA A Hatchback (88_,89_)	4.88 → 11.95					ML5032		U/U
VECTRA B Hatchback (38_)	10.95 → 7.03					ML5258	(+)	U/U
VECTRA B Saloon (36_)	9.95 → 4.02					ML5082	Ch. n° → -W5999999, -W7999999, 5	U/U
VECTRA B Estate (31_)	11.96 → 7.03					ML5257	Ch. n° X1000001 →	U/U
VECTRA C Hatchback, GTS	8.02 →					ML5179	Ch. n° X1000001 →	S1/S1
VECTRA C Saloon	4.02 →					ML5424		U/S1
VECTRA C Estate	10.03 →					ML5773		U/U
						ML5345		U/U
						ML5341		U/U
						ML5346		U/U

ZAFIRA

ZAFIRA MPV (F75_)	4.99 → 6.05					ML5137		U/U
ZAFIRA MPV	7.05 →					ML5722		U/U

VIVARO

VIVARO Box, Fourgon	8.01 →					ML5516		T1/T1
---------------------	--------	--	--	--	--	--------	--	-------

PEUGEOT**106**

106 I Hatchback (1A,1C)	8.91 → 4.96					ML5133		U/U
106 II Hatchback (1)	4.96 →					ML5268		U/U
						ML5134		U/U

107

107 Hatchback	6.05 →					ML5687		U/U
---------------	--------	--	--	--	--	--------	--	-----

205

205 I Hatchback (741A/C)	2.83 → 10.87					ML5020		U/U
205 II Hatchback (20A/C)	1.87 → 9.98					ML5020		U/U
205 Kasten	2.83 → 7.90					ML5020		U/U

206

206 Hatchback (2A/C)	8.98 →					ML5146		S1/S1
206 Estate, SW (2E/K)	7.02 →					ML5469		S1/S1
206, 20coeur Convertible, CC (2D)	9.00 →					ML5340	(=) Rear window	U/U
						ML5343		U/U

207

207 Hatchback	2.06 →					ML5731		S1/P
---------------	--------	--	--	--	--	--------	--	------

207 CC

207 CC Convertible	2.07 →					ML5851		S1/S1
--------------------	--------	--	--	--	--	--------	--	-------

PEUGEOT

PEUGEOT



207 SW

207 SW (WK_)	2.07 →
--------------	--------

--	--	--	--

ML5732		S1/S1
ML5733	(=) Rear window	S1/S1

305

305 I Saloon (581A)	11.77 → 9.82
305 I Estate, Break (581D)	8.80 → 9.82
305 II Saloon (581M)	10.82 → 7.90
305 II Estate, Break (581E)	10.82 → 12.88

--	--	--	--

ML5628		U/U
ML5364		U/U
ML5628		U/U
ML5364		U/U

306

306 Hatchback (7A,7C,N3,N5)	4.93 → 5.01
306 Saloon (7B,N3,N5)	4.93 → 5.01
306 Estate, Break (7E,N3,N5)	2.97 → 4.02
306 Convertible (7D,N3,N5)	3.94 → 4.02

ML5267		S1/S1
ML5267		S1/S1
ML5267		S1/S1
ML5267		S1/S1

ML5148		U/U
ML5323		U/U
ML5432		S1/S1

307

307 Hatchback (3A/C)	8.00 →
307 Estate, Break (3E)	3.02 →
307 Estate, SW (3H)	3.02 →

--	--	--	--

ML5160		S1/S1
ML5425		U/U
ML5425		U/U

308

308 (4A_, 4C_)	9.07 →
308 SW	9.07 →

--	--	--	--

ML5734		S1/S1
ML5889⁰		

309

309 I Hatchback (10A,10C)	10.85 → 12.89
309 II Hatchback (3A,3C)	7.89 → 12.93

--	--	--	--

ML5914⁰		
ML5202		U/U
ML5326	GTI	U/U

405

405 I Estate, Break (15E)	4.88 → 8.92
405 II Estate, Break (4E)	8.92 → 10.96

--	--	--	--

ML5426		U/U
ML5426		U/U

406

406 Saloon (8B)	11.95 → 5.04
406 Estate, Break (8E/F)	10.96 → 10.04
406 Coupe (8C)	3.97 → 12.04

ML5470	F1 (N): 200	S1/S1
ML5517	F1 (N): 1100	U/U
ML5470	F1 (N): 200	S1/S1
ML5517	F1 (N): 1100	U/U
ML5517	F1 (N): 1100	U/U

ML5180	→ 3.99 Old model	U/U
ML5183	4.99 → Facelift	U/U
ML5319		U/U
ML5471		S1/S1

407

407 Saloon	5.04 →
407 Estate, SW	5.04 →

--	--	--	--

ML5727		U/U
ML5728		U/U
ML5729	(=) Rear window	U/U

504

504 Estate, Break	4.71 → 7.86
-------------------	-------------

--	--	--	--

ML5067		Y1/X1
---------------	--	-------



RENAULT



STD			
SPECIAL			

STD			
SPECIAL			

505

505 Saloon (551A)	5.79 → 12.93				ML5625		Y1/S1
505 Estate, Break (551D)	4.82 → 12.93				ML5311		U/U

605

605 Saloon (6B)	6.89 → 9.99	ML5583		U/U	ML5316		U/U
-----------------	-------------	--------	--	-----	--------	--	-----

607

607 Saloon (9D,9U)	2.00 →	ML5788		T1/T1	ML5358		U/U
--------------------	--------	--------	--	-------	--------	--	-----

806

806 MPV (221)	6.94 → 8.02				ML5626	→ 11.95	U/U
					ML5363	11.95 → 10.97	U/U
					ML5627	10.97 →	U/U

807

807 MPV (E)	6.02 →				ML5344		U/U
-------------	--------	--	--	--	--------	--	-----

1007

1007 Hatchback	4.05 →				ML5730		U/U
----------------	--------	--	--	--	--------	--	-----

4007

4007 Closed Off-Road Vehicle	2.07 →				ML5776		U/P
------------------------------	--------	--	--	--	--------	--	-----

PARTNER

PARTNER MPV, Combispace (5F)	5.96 →				ML5113		T1/T1
------------------------------	--------	--	--	--	--------	--	-------

PORSCHE

911

911 Targa	9.68 → 11.90	ML5646		Y5/X3	ML5594	(-)	Y5/X3
911 Targa (993)	8.95 → 9.97	ML5646		Y5/X3	ML5595	(+)	Y5/X3
911 Coupe (997)	7.04 →				ML5594	(-)	Y5/X3
					ML5595	(+)	Y5/X3
					ML5804	(-)	U/U
					ML5803	(+)	S1/S1

928

928 Coupe	9.77 → 11.95				ML5676		U/U
-----------	--------------	--	--	--	--------	--	-----

BOXSTER

BOXSTER Convertible	11.04 →				ML5803		S1/S1
---------------------	---------	--	--	--	--------	--	-------

RENAULT

AVANTIME

AVANTIME MPV (DE0_)	9.01 → 5.03				ML5351		U/U
---------------------	-------------	--	--	--	--------	--	-----

CLIO

CLIO I Hatchback (5/357_,B/C57_)	5.90 → 9.98				ML5093		S1/S1
CLIO II Hatchback (BB0/1/2_,CB0/1/2_)	9.98 →				ML5254	Baccara-Williams	U/U
					ML5241		U/U

RENAULT

RENAULT



MONROE	STD			SPECIAL			STD			SPECIAL		
	↑			i			i			↑		
CLIO II Box (SB0/1/2_) 9.98 →							ML5241					U/U
CLIO III Hatchback (BR0/1, CR0/1) 5.05 →							ML5725					S1/S1

CLIO Grandtour

CLIO Grandtour (KR0/1_) 2.08 →							ML5656					P/P
--------------------------------	--	--	--	--	--	--	--------	--	--	--	--	-----

ESPACE

ESPACE I MPV (J11_) 7.84 → 12.92							ML5320	1.88 →				U/U
ESPACE II MPV (J/S63_) 1.91 → 12.96							ML5629	Folding table				R/R
ESPACE III MPV (JE0_) 11.96 → 10.02							ML5313	→ 11.93				U/U
ESPACE IV MPV (JK0/1_) 11.02 →							ML5314	11.93 →				U/U
							ML5546	Folding table				R/R
							ML5228	(+) Fixed rear window				U/U
							ML5229	(+) Opening rear window				U/U
							ML5230	(-) Rear window				S1/S1
							ML5518	(+) Fixed rear window				U/U
							ML5519	(+) Opening rear window				U/U
							ML5551	(-) Rear window				S1/S1
							ML5472	→ 7.04				S1/S1
							ML5473	7.04 →				S1/S1

KANGOO

KANGOO MPV (KC0/1_) 8.97 →							ML5128	3.98 →				S1/S1
KANGOO Box, Express, Rapid (FC0/1_) 8.97 →							ML5128	3.98 →				S1/S1
KANGOO (KW0/1_) 2.08 →							ML5892 ⁰					

LAGUNA

LAGUNA Hatchback (556_B56_) 11.93 → 3.01							ML5545	1, 5 (+)				U/S1
LAGUNA Estate, Grandtour, Nevada (K56_) 9.95 → 3.01							ML5279	5 (+), (-)				S1/U
LAGUNA II Hatchback (BG0/1_) 3.01 →							ML5544	1, 5 (+)				U/S1
LAGUNA II Estate, Grandtour, Sport Tourer (KG0/1_) 3.01 →							ML5383					U/S1
LAGUNA III (BT0/1) 10.07 →							ML5547	(-) Rear window				S1/S1
LAGUNA III Grandtour (KT0/1) 10.07 →							ML5189					S1/S1
							ML5190	(+)				S1/S1
							ML5474	(+) Fixed rear window				S1/S1
							ML5440	(+) Opening rear window				S1/S1
							ML5548	(-) Rear window				S1/S1
							ML5657					S1/S1
							ML5893 ⁰					

MEGANE

MEGANE I Hatchback (BA0/1_) 1.96 →							ML5155	4				U/U
MEGANE Saloon, Classic (LA0/1_) 9.96 →							ML5131	5				U/U
MEGANE Estate, Break, Grandtour (KA0/1_) 3.99 →							ML5182					S1/S1
MEGANE Coupe, Coach, Coupé (DA0/1_) 3.96 → 8.03							ML5158					U/U
MEGANE Convertible, Cabriolet (EA0/1_) 10.96 →							ML5526					S1/Z
MEGANE MPV, Scenic (JA0/1_) 1.97 → 10.99							ML5686					U/U
MEGANE II Hatchback (BM0/1_CM0/1_) 11.02 →							ML5150	(+) Fixed rear window				U/U
MEGANE II Saloon (LM0/1_) 9.03 →							ML5130	(+) Opening rear window				U/U
							ML5212					U/U
							ML5789					U/U



RENAULT

MONROE	STD			SPECIAL			STD			SPECIAL		
MEGANE II Estate, Grandtour, Sport Tourer (KM0/1_)	8.03	→					ML5372	(+) Fixed rear window	U/U			
							ML5828	(+) Opening rear window	U/P			
							ML5812	(=) Rear window	U/U			
MEGANE II Convertible, Coupé-Cabriolet (EM0/1_)	9.03	→					ML5894 ⁰					

MODUS

MODUS Hatchback (F/JP0_)	12.04	→					ML5724		S1/S1		
--------------------------	-------	---	--	--	--	--	--------	--	-------	--	--

RAPID

RAPID, EXTRA, EXPRESS Box, Van (F40_,G40_)	7.85	→ 11.98					ML5315		U/U		
--	------	---------	--	--	--	--	--------	--	-----	--	--

SAFRANE

SAFRANE I Hatchback (B54_)	4.92	→ 7.96				ML5327			U/U		
SAFRANE II Hatchback (B54_)	7.96	→ 12.00				ML5327			U/U		
							ML5554		U/T1		
							ML5555	Baccara	U/T1		
							ML5477	4	S1/S1		
							ML5476	5	S1/S1		

SCÉNIC

SCÉNIC MPV (JA0/1_)	9.99	→ 8.03					ML5152	(+) Fixed rear window	U/U		
							ML5130	(+) Opening rear window	U/U		
							ML5153	(=) Rear window	S1/S1		
SCÉNIC II MPV (JM0/1_)	6.03	→					ML5826	(+) Fixed rear window	T1/T1		
							ML5475	(+) Opening rear window	U/U		
							ML5552	(=) Rear window	S1/S1		

GRAND SCÉNIC

GRAND SCÉNIC MPV	4.04	→					ML5826	(+) Fixed rear window	T1/T1		
							ML5552	(=) Rear window	S1/S1		

TWINGO

TWINGO Hatchback (C06_)	3.93	→					ML5331		U/U		
TWINGO Hatchback	3.07	→					ML5891 ⁰				

SUPER 5

SUPER 5 Hatchback (B/C40_)	10.84	→ 12.96					ML5021		U/U		
							ML5337	Baccara	U/U		

11

11 Hatchback (B/C37_)	3.83	→ 12.88					ML5630		S1/S1		
-----------------------	------	---------	--	--	--	--	--------	--	-------	--	--

19

19 I Hatchback (B/C53_)	1.88	→ 12.92					ML5004		U/U		
							ML5256	(+)	U/U		
19 I Saloon, Chamade (L53_)	1.88	→ 12.92					ML5310		U/U		
19 II Hatchback (B/C53_)	1.92	→ 12.95					ML5094		U/U		
							ML5256	(+)	U/U		
19 II Saloon, Chamade (L53_)	4.92	→ 12.95					ML5553		U/U		

21

21 Hatchback (B48_)	7.89	→ 6.94					ML5631		T1/T1		
21 Estate (K48_)	3.86	→ 9.95					ML5632		Y1/D		

RENAULT



25

25 Hatchback (B29_)	4.84 → 12.93	ML5633	→ 8.86	Y1/D			
		ML5549	9.86 →	T1/D			

TRAFIC II

TRAFIC II Bus (JL)	3.01 →				ML5550		T1/T1
TRAFIC II Box, Van (FL)	3.01 →				ML5550		T1/T1

ROVER

25

25 Hatchback (RF)	9.99 →				ML5434		U/U
-------------------	--------	--	--	--	---------------	--	-----

STREETWISE

STREETWISE Hatchback	8.03 →				ML5815	(-)	U/U
					ML5394	(+)	U/U

45

45 Hatchback (RT)	2.00 →				ML5410		S1/S1
					ML5478	(+)	S1/S1

75

75 Saloon (RJ)	2.99 →				ML5411		S1/U
75 Estate, Tourer (RJ)	8.01 →				ML5412		S1/U

100 (METRO)

100 (METRO) Hatchback (XP)	3.90 → 12.98				ML5208	(-)	U/U
					ML5209	(+)	U/U

200

200 Hatchback (XW)	10.89 → 10.95				ML5192		U/U
					ML5634	GTI	T1/T1
200 Coupe (XW)	10.92 → 6.99				ML5192		U/U
					ML5634	GTI	T1/T1
200 Hatchback (RF)	11.95 → 3.00				ML5434		U/U

400

400 Hatchback (RT)	5.95 → 3.00				ML5410		S1/S1
					ML5478	(+)	S1/S1

800

800 Hatchback	10.86 → 2.99	ML5359		U/U	ML5384	Ricambi → 230966	U/S1
800 Saloon	10.86 → 2.99	ML5359		U/U	ML5338	Ricambi 230967 →	U/U
800 Coupe	8.92 → 2.99	ML5359		U/U			

MAESTRO

MAESTRO Hatchback	9.90 → 1.95				ML5362		U/U
-------------------	-------------	--	--	--	---------------	--	-----

MINI

MINI Hatchback	1.91 →				ML5041		U/U
----------------	--------	--	--	--	---------------	--	-----



SEAT

MONROESTD
SPECIALSTD
SPECIAL**SAAB****9-3**

9-3 Hatchback (YS3D) 2.98 → 9.02	ML5350 (+) 1 / U/U	ML5402 (-) U/U
	ML5349 (+) 2 / U/U	ML5375 (+) , (+) U/U
9-3 Convertible, Cabriolet (YS3D) 2.98 → 8.03	ML5350 (+) 1 / U/U	ML5397 4 , (+) U/U
9-3 Saloon (YS3F) 9.02 →	ML5349 (+) 2 / U/U	
9-3 Convertible (YS3F) 8.03 →	ML5790 P/S1	
9-3 Estate 3.05 →		ML5766 S1/S1
	ML5915⁰	ML5852 G/G
		ML5916⁰

9-3X

9-3X 2.09 →	ML5790 P/S1	
--------------	--------------------	--

9-5

9-5 Saloon (YS3E) 9.97 →	ML5638 → 12.05 U/U	ML5558 U/T1
9-5 Estate (YS3E) 10.98 →	ML5638 → 12.05 U/U	ML5637 O/O

99

99 Hatchback, Combi Coupe 8.68 → 1.84		ML5613 Y1/D
--	--	--------------------

900

900 I Hatchback, Combi Coupe 9.78 → 6.94		ML5613 Y1/D
		ML5635 (+) Y1/D
900 II Hatchback 7.93 → 2.98	ML5636 U/U	ML5400 U/U
		ML5401 (+) U/U

9000

9000 Hatchback 9.84 → 12.98		ML5497 Ch. n° → H1007931, H8000099 F1 (N): 320 Y1/D
		ML5498 Ch. n° → H1007931, H8000099 (+) F1 (N): 345 Y1/D
		ML5499 Ch. n° H1007932, H8000100 → F1 (N): 345 Y1/D
		ML5494 Ch. n° H1007932, H8000100 → (+) F1 (N): 400 Y1/D
		ML5495 Ch. n° H1007932, H8000100 → F1 (N): 610 U/U
9000 Saloon 4.85 → 12.98	ML5556 Y1/X1	ML5496 Y1/D

SEAT**ALHAMBRA**

ALHAMBRA MPV (7V8,7V9) 4.96 → 3.10	ML5480 S1/S1	ML5127 U/U
-------------------------------------	---------------------	-------------------

ALTEA

ALTEA MPV (5P1) 3.04 →		ML5100 S1/S1
-------------------------	--	---------------------

ALTEA XL

ALTEA XL MPV (5P5) 10.06 →		ML5845 U/U
-----------------------------	--	-------------------

AROSA

AROSA Hatchback (6H) 5.97 → 6.04	ML5195 S1/U	ML5284 S1/U
-----------------------------------	--------------------	--------------------

SEAT

SEAT



CORDOBA

CORDOBA Saloon (6K2/C2) 2.93 → 6.99					ML5063		U/U
CORDOBA Estate, Vario (6K5) 8.96 → 6.99					ML5100		S1/S1
CORDOBA Hatchback (6K2) 6.99 → 10.02					ML5259		U/U
CORDOBA Estate, Vario (6K5) 6.99 → 12.02					ML5100		S1/S1
CORDOBA Saloon (6L2) 9.02 →					ML5778		S1/U

IBIZA

IBIZA I Hatchback (021A) 6.84 → 12.93					ML5022		Y1/X1
IBIZA II Hatchback (6K1) 3.93 → 8.99					ML5140		U/U
IBIZA III Hatchback (6K1) 8.99 →					ML5211		U/U
IBIZA IV Hatchback (6L1) 2.02 →					ML5225		S1/U
IBIZA V (6J5) 3.08 →					ML5850		S1/S1

LEON

LEON Hatchback (1M1) 11.99 → 6.06	ML5342			U/U	ML5181		S1/U
LEON Hatchback (1P1) 5.05 →					ML5767		S1/U

MALAGA

MALAGA Saloon (023A) 11.84 → 12.93					ML5639		Y1/D
-------------------------------------	--	--	--	--	--------	--	------

MARBELLA

MARBELLA Hatchback (28) 8.86 → 10.98					ML5016		Y1/X2
---------------------------------------	--	--	--	--	--------	--	-------

PANDA

PANDA Hatchback (141A) 10.80 → 12.86					ML5016		Y1/X2
---------------------------------------	--	--	--	--	--------	--	-------

RITMO

RITMO Hatchback (138) 7.78 → 9.83					ML5010		Y1/X1
------------------------------------	--	--	--	--	--------	--	-------

RONDA

RONDA Hatchback (022A) 6.82 → 11.88					ML5011		Y1/X1
					ML5610	(+)	Y2/D

TOLEDO

TOLEDO I Hatchback (1L) 5.91 → 3.99					ML5124		U/U
TOLEDO II Saloon (1M2) 4.99 → 5.06					ML5193		U/U
TOLEDO III MPV (5P2) 4.04 →					ML5584		S1/U

SKODA

FABIA

FABIA Hatchback (6Y2) 8.99 → 3.08					ML5175		U/U
FABIA Saloon (6Y3) 10.99 → 12.07					ML5135		U/U
FABIA Estate, Combi (6Y5) 4.00 → 12.07					ML5175		U/U
FABIA 12.06 →					ML5681		U/U
FABIA Combi 10.07 →					ML5681		U/U



SSANGYONG



STD		
SPECIAL		

STD		
SPECIAL		

FAVORIT

FAVORIT Hatchback (781) 5.89 → 9.94					ML5048	F1 (N): 420	U/U
FAVORIT Estate, Forman (785) 8.91 → 6.95					ML5044	F1 (N): 450	U/U
FAVORIT Pickup (787) 6.92 → 6.97					ML5005	F1 (N): 420	U/U
					ML5044	F1 (N): 450	U/U
					ML5037	Forman Plus, F1 (N): 325	U/P
					ML5036		Y1/X1
					ML5026	(+) Panoramic	U/U

FELICIA

FELICIA I Hatchback (6U1) 10.94 → 3.98					ML5061		U/U
FELICIA I Estate (6U5) 8.95 → 3.98					ML5061		U/U
FELICIA I Pickup, Fun (797) 10.95 →					ML5099	F1 (N): 220	U/U
FELICIA II Hatchback (6U1) 1.98 → 6.01					ML5057	F1 (N): 325	P/S1
FELICIA II Estate (6U5) 1.98 → 6.01					ML5061		U/U
					ML5061		U/U

OCTAVIA

OCTAVIA Hatchback (1U2) 9.96 →					ML5218	(-)	U/U
OCTAVIA Estate, Combi (1U5) 7.98 →					ML5219	(+)	U/U
OCTAVIA Hatchback (1Z3) 2.04 →					ML5217	4	U/U
OCTAVIA Estate, Combi (1Z5) 2.04 →					ML5220	Sport RS, F1 (N): 550	U/U
					ML5221	Sport RS, F1 (N): 565	U/U
					ML5045		U/U
					ML5665		U/U
					ML5667		U/U

ROOMSTER

ROOMSTER MPV (5J) 5.06 →					ML5682		U/U
---------------------------	--	--	--	--	--------	--	-----

SUPERB

SUPERB Saloon (3U4) 2.02 → 3.08	ML5768		U/U	ML5439		U/U
----------------------------------	--------	--	-----	--------	--	-----

SMART (MCC)

CITY-COUBE

CITY-COUBE Hatchback (MC01) 7.98 → 1.04					ML5640		T1/T1
--	--	--	--	--	--------	--	-------

FORTWO

FORTWO Coupe 1.04 →					ML5640		T1/T1
FORTWO Coupe 1.07 →					ML5640		T1/T1

FORFOUR

FORFOUR Hatchback 1.04 →					ML5895 ⁰		
---------------------------	--	--	--	--	---------------------	--	--

SSANGYONG

REXTON

REXTON Closed Off-Road Vehicle 4.02 →	ML5355		U/U	ML5334	(+) Opening rear window	U/U
				ML5356	(-) Rear window	U/U

SSANGYONG

SUBARU



SUBARU

IMPREZA

IMPREZA Estate (GF) 8.92 →					ML5820		U/U
IMPREZA Estate (GD,GG) 12.00 →					ML5819		U/U

SUZUKI

ALTO

ALTO I Hatchback (SS80) 6.82 → 12.85					ML5589		S1/S1
ALTO II Hatchback (EC) 9.85 → 11.93					ML5589		S1/S1
ALTO III Hatchback (EF) 9.94 →					ML5589		S1/S1

BALENO

BALENO Hatchback (EG) 7.95 → 5.02					ML5896⁰		
					ML5897⁰		

IGNIS

IGNIS (RG, FH, RM) 9.03 →					ML5780		T1/T1
IGNIS II Closed Off-Road Vehicle 9.03 →					ML5780		T1/T1

SAMURAI

SAMURAI Closed Off-Road Vehicle (SJ) 11.88 →		ML5492		Y1/D			
---	--	---------------	--	------	--	--	--

SJ 410

SJ 410 Closed Off-Road Vehicle 9.81 → 12.88		ML5492		Y1/D			
SJ 410 Open Off-Road Vehicle, Cabrio 9.81 → 12.88		ML5492		Y1/D			

SJ 413

SJ 413 Closed Off-Road Vehicle 9.84 → 8.90		ML5492		Y1/D			
---	--	---------------	--	------	--	--	--

SX4

SX4 Closed Off-Road Vehicle 6.06 →					ML5779		U/U
-------------------------------------	--	--	--	--	---------------	--	-----

SWIFT

SWIFT I Hatchback (AA) 10.83 → 12.89		ML5492		Y1/D			
SWIFT II Hatchback (EA,MA) 3.89 → 12.03					ML5091		E4/T2
					ML5092		E4/T2

VITARA

VITARA Closed Off-Road Vehicle (ET,TA) 7.88 → 3.98					ML5493 (+) Panoramic		Y1/D
---	--	--	--	--	-----------------------------	--	------

WAGON R+

WAGON R+ MPV (MM) 5.00 →					ML5088		E2/E3
					ML5089		E2/E3



VAUXHALL

MONROESTD
SPECIALSTD
SPECIAL**TOYOTA****AURIS**

AURIS 10.06 →					ML5900 ⁰		
----------------	--	--	--	--	---------------------	--	--

AVENSIS

AVENSIS Hatchback, Liftback (T22) 9.97 → 2.03					ML5592		S1/S1
AVENSIS Estate, Station Wagon (T22) 9.97 → 2.03					ML5121		S1/S1
AVENSIS Hatchback (T25) 3.03 →					ML5647		P/S1
AVENSIS Estate, Combi (T25) 4.03 →					ML5699		P/S1

AYGO

AYGO Hatchback 7.05 →					ML5687		U/U
------------------------	--	--	--	--	--------	--	-----

COROLLA

COROLLA Hatchback, Compact (E11) 4.97 → 1.02					ML5901 ⁰		
COROLLA Hatchback, Liftback (E11) 4.97 → 1.02					ML5902 ⁰		
COROLLA Hatchback (E12U) 1.02 →					ML5903 ⁰ 5 Ch. GB		
COROLLA Estate, Combi (E12J) 1.02 →					ML5904 ⁰ ,5 Ch. J		
COROLLA MPV, Verso (E12J) 10.01 →					ML5905 ⁰ ,5 Ch. J		
COROLLA Hatchback (E12U) 1.02 →					ML5485		S1/U
COROLLA Estate, Combi (E12J) 1.02 →					ML5486		S1/S1
COROLLA MPV, Verso (E12J) 10.01 →					ML5641		S1/S1
COROLLA MPV, Verso 3.04 →					ML5666		U/U

PRIUS

PRIUS Hatchback 8.03 →					ML5917 ⁰		
-------------------------	--	--	--	--	---------------------	--	--

YARIS

YARIS Hatchback (CP10) 4.99 →					ML5821		S1/U
YARIS Hatchback 1.06 →					ML5777		U/U

UAZ**3160**

3160 1.99 →					ML5025		U/U
--------------	--	--	--	--	--------	--	-----

VAUXHALL**AGILA**

AGILA Estate 2.00 →					ML5088		E2/E3
					ML5089		E2/E3

ASTRA

ASTRA Hatchback 9.84 → 8.91					ML5528 Ch. n° → JZ502492, (+)		M/O
					ML5835 Ch. n° → JE100000, (-)		M/O
					ML5407 Ch. n° JE100001, JZ502492 →		U/U

VAUXHALL

VAUXHALL



MONROE	STD		↑ ↓	i	↺ ↻	STD		i	↺ ↻	↺ ↻
	SPECIAL					SPECIAL				
ASTRA Estate	9.84 → 8.91						ML5528	Ch. n° → J2802492, (+)		M/O
ASTRA Hatchback	9.91 → 2.98						ML5835	Ch. n° → JE100000, (-)		M/O
ASTRA Estate	3.91 → 2.98						ML5407	Ch. n° → JE100001, J2502492 →		U/U
ASTRA Hatchback	2.98 →						ML5077	3 , 5		U/U
ASTRA Estate	2.98 →						ML5156	(-)		U/U
							ML5125	(+)		U/U
							ML5167	3 , (+)		U/U
							ML5166	3 , 5		U/U
							ML5138			U/U

ASTRAVAN

ASTRAVAN Box	8.98 →						ML5138			U/U
--------------	--------	--	--	--	--	--	---------------	--	--	-----

CALIBRA

CALIBRA Coupe	6.90 → 7.97						ML5367			U/U
---------------	-------------	--	--	--	--	--	---------------	--	--	-----

CARLTON

CARLTON Estate	9.77 → 8.88						ML5398			U/U
CARLTON Saloon	9.86 → 3.94						ML5366	Ch. n° → N1145948		U/U
CARLTON Estate	9.86 → 3.94						ML5365	Ch. n° → N1145949 →		U/U
							ML5408			U/U
							ML5366	Ch. n° → N1145948		U/U

CAVALIER

CAVALIER Hatchback	9.81 → 8.88						ML5390	(-)		U/U
CAVALIER Hatchback	9.88 → 11.95						ML5391	(+)		U/U
							ML5032			U/U
							ML5258	(+)		U/U

CORSA

CORSA Hatchback	3.93 → 9.00						ML5242	3 , (-)		U/U
							ML5054	3 , (+)		U/U
							ML5144	5		U/U
CORSA Hatchback	8.00 →						ML5827	3		U/U
							ML5807	5		U/U

FRONTERA

FRONTERA Closed Off-Road Vehicle	10.98 →						ML5825			S1/S1
----------------------------------	---------	--	--	--	--	--	---------------	--	--	-------

MERIVA

MERIVA MPV	1.03 →						ML5119			U/U
------------	--------	--	--	--	--	--	---------------	--	--	-----

NOVA

NOVA Hatchback	5.83 → 3.93						ML5585	(-)		O/O
----------------	-------------	--	--	--	--	--	---------------	-----	--	-----

OMEGA

OMEGA Saloon	1.94 →						ML5210			U/U
OMEGA Estate	2.94 →						ML5103			U/U

SENATOR

SENATOR Saloon	9.87 → 9.93						ML5366	Ch. n° → N1145948		U/U
							ML5365	Ch. n° → N1145949 →		U/U

SIGNUM

SIGNUM Hatchback	1.02 →		ML5345			U/U	ML5817			P/U
------------------	--------	--	---------------	--	--	-----	---------------	--	--	-----



VOLKSWAGEN



SINTRA

SINTRA MPV	11.96 → 4.99					ML5515		U/U
------------	--------------	--	--	--	--	--------	--	-----

SPEEDSTER (VX220)

SPEEDSTER (VX220)	10.03 → 9.06					ML5518		U/U
-------------------	--------------	--	--	--	--	--------	--	-----

TIGRA

TIGRA Coupe	7.94 → 12.00					ML5369		U/U
-------------	--------------	--	--	--	--	--------	--	-----

VECTRA

VECTRA Hatchback	8.95 →					ML5082	Ch. n° → -W5999999, -W7999999, 5	U/U
VECTRA Saloon	8.95 →	ML5085			U/U	ML5257	Ch. n° X1000001- →	U/U
VECTRA Estate	8.95 →	ML5085			U/U	ML5179	Ch. n° X1000001 →	S1/S1
VECTRA Hatchback, GTS	8.02 → 7.08					ML5424		U/S1
VECTRA Saloon	1.00 →	ML5345			U/U	ML5773		U/U
VECTRA Estate	10.03 → 7.08	ML5345			U/U	ML5341		U/U
						ML5346		U/U

VIVARO

VIVARO Box	8.01 →					ML5516		T1/T1
------------	--------	--	--	--	--	--------	--	-------

ZAFIRA

ZAFIRA MPV	11.98 →					ML5137		U/U
ZAFIRA MPV	4.05 →					ML5722		U/U

VOLKSWAGEN

BORA

BORA Saloon (1J2)	10.98 → 7.05	ML5261			S1/U	ML5135		U/U
BORA Variant (1J6)	5.99 → 5.05	ML5261			S1/U	ML5193	(+)	U/U
						ML5132		S1/U

CADDY

CADDY I Pickup (14)	8.82 → 7.92	ML5736			S1/U	ML5572		Y1/U
CADDY III Variant (2KB)	3.04 →	ML5736			S1/U	ML5750		U/U
CADDY III Box (2KA)	3.04 →	ML5736			S1/U	ML5750		U/U

CORRADO

CORRADO Coupe (53I)	9.88 → 12.95					ML5573		U/D
---------------------	--------------	--	--	--	--	--------	--	-----

EOS

EOS Convertible	3.06 →	ML5738			P/U	ML5752		U/U
-----------------	--------	--------	--	--	-----	--------	--	-----

FOX

FOX Hatchback (5Z1)	10.03 →					ML5796		S1/U
---------------------	---------	--	--	--	--	--------	--	------

GOLF

GOLF I Hatchback (17)	4.74 → 7.85					ML5073		Y1/X1
GOLF II Hatchback (19E,1G1)	8.83 → 12.92					ML5574	Ch. n° → 19E780000	U/D
GOLF III Hatchback (1H1)	8.91 → 9.97					ML5038	Ch. n° 19E780001 →	U/U
GOLF III Variant, Variant (1H5)	7.93 → 4.99					ML5049		U/U
						ML5191		U/U

VOLKSWAGEN



MONROE							
	STD	SPECIAL		STD	SPECIAL		
GOLF III Convertible, Cabriolet (1E7)	7.93 → 5.98	ML5264		S1/U	ML5675		U/U
GOLF IV Hatchback (1J1)	8.97 → 10.05	ML5261		S1/U	ML5132		S1/U
GOLF IV Variant, Variant (1J5)	5.99 → 6.06	ML5261		S1/U	ML5132		S1/U
GOLF IV Convertible, Cabriolet (1E7)	6.98 → 6.02	ML5264		S1/U	ML5675		U/U
GOLF V Hatchback (1K1)	10.03 →	ML5735		P/U	ML5742		S1/U
GOLF V Variant	6.07 →	ML5735		P/U	ML5754		U/P
GOLF VI (5K1)	10.08 →	ML5648		P/U	ML5653		S1/U
GOLF VI Variant (AJ5)	7.09 →				ML5754		U/P
GOLF V PLUS Hatchback (5M1)	1.05 →				ML5792		U/P

JETTA

JETTA III Saloon (1K2)	8.05 →	ML5735		P/U	ML5751		T1/T1
------------------------	--------	--------	--	-----	--------	--	-------

LUPO

LUPO Hatchback (6E1,6X1)	9.98 →	ML5287		S1/U	ML5261		S1/U
		ML5195	Ch. n° → 6X1049577 (-) GTI-FSI-TDI	S1/U	ML5199	GTI-FSI-TDI	S1/U
		ML5339	Ch. n° 6X1049578 → (-) GTI-FSI-TDI	S1/U			

NEW BEETLE

NEW BEETLE Hatchback (1C1,9C1)	1.98 →	ML5393		U/U	ML5325		U/U
NEW BEETLE Convertible (1Y7)	9.02 →				ML5791		S1/U

PASSAT

PASSAT Variant, Variant (35I,3A5)	2.88 → 5.97				ML5123		S1/S1
PASSAT Saloon (3B2)	8.96 → 11.00	ML5266		U/U	ML5135		U/U
PASSAT Variant, Variant (3B5)	5.97 → 11.00	ML5266		U/U	ML5193	(+) Δ	U/U
PASSAT Saloon (3B3)	11.00 → 5.05	ML5266		U/U	ML5185		S1/U
PASSAT Variant (3B6)	11.00 → 8.05	ML5266		U/U	ML5439		U/U
PASSAT Saloon (3C2)	3.05 →	ML5829		P/U	ML5132		S1/U
PASSAT Variant (3C5)	8.05 →	ML5829		P/U	ML5830		U/P
					ML5831		U/S1

POLO

POLO Hatchback (80,86C)	10.81 → 9.94				ML5644	10.81 → 4.86	T1/D
POLO Hatchback (6N1)	10.94 → 10.99				ML5177	5.86 → 7.90	U/U
POLO Variant, Variant (6KV5)	5.97 → 9.01				ML5178	8.90 →	U/U
POLO Hatchback (6N2)	10.99 → 10.01	ML5265		U/U	ML5145		U/U
POLO Hatchback (9N_)	10.01 →	ML5491		S1/U	ML5100		S1/S1
POLO Saloon	8.96 →				ML5145		U/U
POLO (6R_)	6.09 →				ML5194	F1 (N): 380	S1/U
					ML5196	F1 (N): 400	S1/U
					ML5748		S1/U
					ML5849		U/U

SCIROCCO

SCIROCCO Coupe (53B)	8.80 → 7.92				ML5677		Y1/T1
----------------------	-------------	--	--	--	--------	--	-------

SHARAN

SHARAN MPV (7M6,7M8,7M9)	9.95 →	ML5480		S1/S1	ML5127		U/U
--------------------------	--------	--------	--	-------	--------	--	-----



VOLVO

MONROESTD
SPECIALSTD
SPECIAL**TIGUAN**

TIGUAN (5N_)	9.07 →				ML5838		P/P
--------------	--------	--	--	--	---------------	--	-----

TOUAREG

TOUAREG Closed Off-Road Vehicle (7LA)	10.02 → 5.10	ML5357		U/U	ML5793		S1/S1
---------------------------------------	--------------	---------------	--	-----	---------------	--	-------

TOURAN

TOURAN MPV	2.03 →	ML5736	→ 12.06	S1/U	ML5743		U/P
------------	--------	---------------	---------	------	---------------	--	-----

VENTO

VENTO Saloon (1H2)	11.91 → 9.98				ML5226		U/S1
--------------------	--------------	--	--	--	---------------	--	------

TRANSPORTER

TRANSPORTER III/T3 Bus	5.79 → 7.92				ML5106		U/D
TRANSPORTER III/T3 Box	5.79 → 7.92				ML5645	M308 - Hydrolift	Y1/U
					ML5106		U/D
					ML5645	M308 - Hydrolift	Y1/U
					ML5246	Ch. n° → 70N151781 (+)	F1 (N): 660 U/U
					ML5245	Ch. n° → 70N151781 (+)	F1 (N): 750 U/U
					ML5247	Ch. n° → 70N151781 (+) "Trim" version,	F1 (N): 830 U/U
TRANSPORTER IV/T4 Bus (70XB,70XC,7DB,7DW)	9.90 → 4.03				ML5105	Ch. n° → 70N151781 (+) , (+) Heat insulating glass,	F1 (N): 910 U/U
TRANSPORTER IV/T4 Box (70XA)	7.90 → 4.03				ML5249	Ch. n° 70N151781 → (-)	F1 (N): 710 U/U
					ML5118	Ch. n° 70N151781 → (+)	F1 (N): 770 U/U
					ML5251	Ch. n° 70N151781 → (+) "Trim" version,	F1 (N): 830 P/P
					ML5250	Ch. n° 70N151781 → (+) , (+) Heat insulating glass,	F1 (N): 910 P/P
					ML5248	Ch. n° 70N151781 → M308 - Hydrolift	U/U
TRANSPORTER T5/V Bus (7HB,7HJ)	4.03 →				ML5832		F1 (N): 360 U/P
					ML5575		F1 (N): 970 U/U
					ML5833		F1 (N): 1080 U/P
TRANSPORTER T5/V Box (7HA,7HH)	4.03 →				ML5832		F1 (N): 360 U/P
					ML5575		F1 (N): 970 U/U
					ML5833		F1 (N): 1080 U/P

MULTIVAN

MULTIVAN T5/V MPV (7HM)	4.03 →				ML5576		U/U
-------------------------	--------	--	--	--	---------------	--	-----

VOLVO**C30**

C30 Hatchback	10.06 →	ML5726		U/U	ML5907^o		
---------------	---------	---------------	--	-----	---------------------------	--	--

S40

S40 I Saloon (VS)	7.95 → 12.03	ML5368		S1/S1	ML5154		U/U
S40 II Saloon	1.04 →	ML5726		U/U	ML5488		S1/S1

V40

V40 Estate (VW)	7.95 → 6.04				ML5184		U/U
-----------------	-------------	--	--	--	---------------	--	-----

V50

V50 Estate	4.04 →	ML5726		U/U	ML5500		S1/S1
------------	--------	---------------	--	-----	---------------	--	-------

VOLVO

VOLVO



	STD			STD		
	SPECIAL					

S60

S60 Saloon	7.00 →	ML5643		S1/S1	ML5481		S1/S1
------------	--------	--------	--	-------	--------	--	-------

S70

S70 Saloon	11.96 → 11.00				ML5908 ⁰	(-)	
					ML5909 ⁰	(+)	

C70

C70 Coupe	3.97 → 9.02				ML5487		S1/S1
C70 Convertible	3.06 →	ML5726		U/U			

V70

V70 I Estate	11.96 → 5.00				ML5529		O/M
V70 II Estate	3.00 →	ML5643		S1/S1	ML5685		M/O
V70 III Estate	8.07 →	ML5663		U/U			

XC70 CROSS COUNTRY

XC70 CROSS COUNTRY, V70 XC Estate	11.97 →	ML5643	9.00 → 8.07	S1/S1	ML5529	→ 8.00	O/M
-----------------------------------	---------	--------	-------------	-------	--------	--------	-----

S80

S80 Saloon	5.98 → 7.06	ML5643		S1/S1	ML5489		S1/S1
					ML5490	(+)	S1/S1

S90

S90 Saloon	11.96 → 10.98				ML5347		U/U
					ML5348	(+)	U/U

V90

V90 Estate	11.96 → 12.98				ML5312		U/U
------------	---------------	--	--	--	--------	--	-----

XC 90

XC 90 Estate	10.02 →	ML5361		U/U	ML5427		S1/U
--------------	---------	--------	--	-----	--------	--	------

340-360

340-360 Hatchback (343,345)	8.75 → 7.91				ML5642	(+)	T1/T1
340-360 Saloon (344)	8.82 → 7.91				ML5642	(+)	T1/T1

440

440 K Hatchback (445)	8.88 → 12.96				ML5571		T1/T1
-----------------------	--------------	--	--	--	--------	--	-------

460

460 L Saloon (464)	9.88 → 7.96				ML5571		T1/T1
--------------------	-------------	--	--	--	--------	--	-------

480

480 E Coupe	4.86 → 7.96				ML5509		T1/T1
-------------	-------------	--	--	--	--------	--	-------

740

740 Saloon (744)	4.83 → 8.92				ML5906 ⁰		
740 Estate, Break, Kombi (745)	5.85 → 8.92				ML5312		U/U

760

760 Estate, Break, Kombi (704,765)	1.82 → 7.92				ML5312		U/U
------------------------------------	-------------	--	--	--	--------	--	-----

**ZAZ**STD
SPECIALSTD
SPECIAL**850**

850 Saloon (LS)	6.91 → 10.97					ML5840		I/H
850 Estate (LW)	8.92 → 10.97					ML5529		O/M

940

940 Saloon (944)	8.90 → 12.98					ML5347		U/U
940 Estate, Break, Kombi (945)	8.90 → 7.95					ML5312		U/U

960

960 Saloon (964)	8.90 → 7.94					ML5347		U/U
960 Estate, Break, Kombi (965)	8.90 → 7.94					ML5312		U/U
960 II Saloon (964)	7.94 → 12.96					ML5347		U/U
960 II Estate (965)	8.94 → 12.96					ML5312		U/U

ZASTAVA**101**

101 Hatchback (1100)	6.73 → 12.93					ML5003		U/U
----------------------	--------------	--	--	--	--	--------	--	-----

YUGO

YUGO Hatchback	4.80 → 6.95					ML5028		U/U
----------------	-------------	--	--	--	--	--------	--	-----

YUGO FLORIDA

YUGO FLORIDA Hatchback	10.88 →					ML5008		Y1/X1
						ML5097	Poly	U/U

ZAZ**TAVRIJA**

TAVRIJA Hatchback	1.89 →					ML5035	1102	U/U
						ML5115	1103	U/U
						ML5072	1105	U/U
						ML5116	11055	U/U

NUMERICAL LISTING

	OE N°:	Ref.
ALFA ROMEO		
ALFA ROMEO	46739202	ML5696
ALFA ROMEO	46771551	ML5222
ALFA ROMEO	60505771	ML5597
ALFA ROMEO	60540532	ML5531
ALFA ROMEO	60564112	ML5608
ALFA ROMEO	60566147	ML5274
ALFA ROMEO	60567794	ML5335
ALFA ROMEO	60583192	ML5532
ALFA ROMEO	60591762	ML5273
ALFA ROMEO	60604174	ML5608
ALFA ROMEO	60604823	ML5271
ALFA ROMEO	60612565	ML5272
ALFA ROMEO	60622424	ML5419
ALFA ROMEO	60651067	ML5215
ALFA ROMEO	60654724	ML5392
ALFA ROMEO	60657685	ML5216
ALFA ROMEO	60658924	ML5414
ALFA ROMEO	60664833	ML5442
ALFA ROMEO	60680087	ML5698
ALFA ROMEO	60688574	ML5697

	OE N°:	Ref.
AUDI		
AUDI	893823360	ML5593
AUDI	893827552	ML5417
AUDI	3B0823239A	ML5266
AUDI	3B0823359	ML5266
AUDI	3B0823359B	ML5266
AUDI	443823359B	ML5420
AUDI	4A0823359C	ML5678
AUDI	4A5827551	ML5428
AUDI	4A5827552	ML5111
AUDI	4A9827552	ML5418
AUDI	4B0823359A	ML5266
AUDI	4B0823359B	ML5266
AUDI	4B0823359C	ML5266
AUDI	4B3823359	ML5385
AUDI	4B5827552A	ML5234
AUDI	4B5827552C	ML5234
AUDI	4B5827552D	ML5234
AUDI	4B5827552F	ML5223
AUDI	4B5827552G	ML5223
AUDI	4B9827552A	ML5238
AUDI	4B9827552C	ML5239
AUDI	4B9827552G	ML5240
AUDI	4B9827552H	ML5510
AUDI	4B9827552J	ML5511
AUDI	4B9827552M	ML5239
AUDI	4B9827552N	ML5512
AUDI	4D0823359F	ML5276
AUDI	4D0823551B	ML5275
AUDI	4D0827551A	ML5275
AUDI	4D0827551B	ML5275
AUDI	4F0823359	ML5737
AUDI	4F0823359A	ML5737
AUDI	4F5827552	ML5744
AUDI	4F5827552B	ML5744
AUDI	4F9827552B	ML5746
AUDI	4F9827552C	ML5746
AUDI	4L0823359	ML5739
AUDI	4L0827552C	ML5774
AUDI	4L0827552F	ML5774
AUDI	893827552A	ML5533
AUDI	895827552A	ML5534
AUDI	8A0823360A	ML5333
AUDI	8A5827552	ML5376
AUDI	8A5827552A	ML5104
AUDI	8A9827552D	ML5437
AUDI	8D0823359	ML5679
AUDI	8D0823359A	ML5679

	OE N°:	Ref.
AUDI	8D0823359B	ML5679
AUDI	8D5827550C	ML5193
AUDI	8D5827550E	ML5193
AUDI	8D5827552	ML5135
AUDI	8D5827552A	ML5135
AUDI	8D5827552B	ML5135
AUDI	8D5827552C	ML5135
AUDI	8D5827552C	ML5193
AUDI	8D5827552D	ML5135
AUDI	8D5827552F	ML5135
AUDI	8D5827552F	ML5193
AUDI	8D9827552	ML5197
AUDI	8D9827552F	ML5198
AUDI	8E0823359A	ML5386
AUDI	8E5827552J	ML5745
AUDI	8E5827552K	ML5745
AUDI	8E9827552E	ML5227
AUDI	8E9827552G	ML5747
AUDI	8E9827552H	ML5747
AUDI	8J0823359C	ML5740
AUDI	8J8827552	ML5753
AUDI	8L0823359	ML5261
AUDI	8N8827552	ML5277
AUDI	8N8827552A	ML5449
AUDI	8N8827552B	ML5449
AUDI	8P0823359	ML5269
AUDI	8P3827552A	ML5459
AUDI	8P3827552D	ML5460
AUDI	8P4827552B	ML5749
AUDI	8T0823359	ML5741
AUDI	8Z0827552A	ML5370
AUDI	8Z0827552B	ML5370
AUDI	D0823354	ML5679

	OE N°:	Ref.
AUSTIN		
AUSTIN	AFP1282	ML5041
AUSTIN	BEP6628	ML5362

	OE N°:	Ref.
AUTOBIANCHI		
AUTOBIANCHI	4480856	ML5017
AUTOBIANCHI	4484653	ML5017
AUTOBIANCHI	5970097	ML5598
AUTOBIANCHI	60617400	ML5598

	OE N°:	Ref.
BMW		
BMW	7060688	ML5691
BMW	11811869147	ML5566
BMW	11811906286	ML5596
BMW	51231868555	ML5599
BMW	51231869147	ML5600
BMW	51231906286	ML5596
BMW	51231907962	ML5599
BMW	51231908465	ML5566
BMW	51231927129	ML5599
BMW	51231944119	ML5522
BMW	51231960852	ML5421
BMW	51233400352	ML5769
BMW	51237008745	ML5562
BMW	51237060550	ML5689
BMW	51237118370	ML5563
BMW	51238119558	ML5422
BMW	51238150077	ML5441
BMW	51238174866	ML5336
BMW	51238202688	ML5263
BMW	51238240596	ML5565
BMW	51238402551	ML5688
BMW	51241934270	ML5444
BMW	51241947096	ML5450
BMW	51241960862	ML5170
BMW	51242231663	ML5445

	OE N°:	Ref.
BMW	51242264448	ML5260
BMW	51242491349	ML5236
BMW	51243400379	ML5693
BMW	51244212802	ML5163
BMW	51244365788	ML5694
BMW	51244394052	ML5694
BMW	51247008764	ML5695
BMW	51247038248	ML5671
BMW	51247060622	ML5691
BMW	51247060623	ML5694
BMW	51247118885	ML5671
BMW	51247127875	ML5692
BMW	51248110327	ML5444
BMW	51248146290	ML5451
BMW	51248149327	ML5521
BMW	51248149328	ML5521
BMW	51248151579	ML5170
BMW	51248159239	ML5520
BMW	51248171158	ML5436
BMW	51248171480	ML5523
BMW	51248190688	ML5535
BMW	51248206652	ML5235
BMW	51248217305	ML5436
BMW	51248220075	ML5163
BMW	51248222913	ML5590
BMW	51248227895	ML5670
BMW	51248230070	ML5237
BMW	51248230369	ML5521
BMW	51248230370	ML5521
BMW	51248232873	ML5213
BMW	51248251547	ML5671
BMW	51248254281	ML5163
BMW	51248402405	ML5690

	OE N°:	Ref.
CHEVROLET		
CHEVROLET	96306833	ML5096
CHEVROLET	96310381	ML5446
CHEVROLET	96314606	ML5098
CHEVROLET	96394240	ML5446
CHEVROLET	96507773	ML5098
CHEVROLET	96518910	ML5098
CHEVROLET	96540939	ML5714
CHEVROLET	96548931	ML5794
CHEVROLET	96557538	ML5096
CHEVROLET	96557539	ML5098
CHEVROLET	96563503	ML5098
CHEVROLET	96598008	ML5098

	OE N°:	Ref.
CITROËN		
CITROËN	8731E0	ML5113
CITROËN	792511	ML5270
CITROËN	792513	ML5262
CITROËN	792514	ML5461
CITROËN	792520	ML5822
CITROËN	873196	ML5503
CITROËN	873197	ML5503
CITROËN	949901	ML5204
CITROËN	5429798	ML5606
CITROËN	5459705	ML5609
CITROËN	5490307	ML5609
CITROËN	8731000	ML5129
CITROËN	75521825	ML5010
CITROËN	87310000	ML5435
CITROËN	95492745	ML5011
CITROËN	95496134	ML5019
CITROËN	95568454	ML5601
CITROËN	95598526	ML5603
CITROËN	95631956	ML5607
CITROËN	95635988	ML5602
CITROËN	95635989	ML5605

NUMERICAL LISTING

	OE N°:	Ref.
CITROËN		
CITROËN	96026964	ML5505
CITROËN	96027543	ML5033
CITROËN	96095456	ML5504
CITROËN	620915680	ML5430
CITROËN	8731E5	ML5455
CITROËN	1401103980	ML5841
CITROËN	1498071080	ML5841
CITROËN	7552182580	ML5010
CITROËN	9556845480	ML5601
CITROËN	9559852680	ML5603
CITROËN	9560649080	ML5452
CITROËN	9563195680	ML5607
CITROËN	9563598880	ML5602
CITROËN	9563598980	ML5605
CITROËN	9563914480	ML5457
CITROËN	9602754380	ML5033
CITROËN	9612212280	ML5506
CITROËN	9612361280	ML5255
CITROËN	9618119180	ML5149
CITROËN	9620677480	ML5435
CITROËN	9621907680	ML5129
CITROËN	9629618980	ML5270
CITROËN	9637509380	ML5262
CITROËN	9639853880	ML5151
CITROËN	9640894580	ML5536
CITROËN	9641721980	ML5453
CITROËN	9647295480	ML5668
CITROËN	9650854180	ML5824
CITROËN	9654433480	ML5756
CITROËN	9654433580	ML5755
CITROËN	9654438680	ML5783
CITROËN	5802A007	ML5776
CITROËN	5802A008	ML5776
CITROËN	689500H020	ML5687
CITROËN	8731A3	ML5454
CITROËN	8731A8	ML5430
CITROËN	8731C0	ML5149
CITROËN	8731C1	ML5456
CITROËN	8731C2	ML5203
CITROËN	8731C3	ML5204
CITROËN	8731F1	ML5162
CITROËN	8731F6	ML5391
CITROËN	8731F7	ML5536
CITROËN	8731G3	ML5151
CITROËN	8731G6	ML5344
CITROËN	8731H8	ML5453
CITROËN	8731J9	ML5824
CITROËN	8731L0	ML5687
CITROËN	8731N9	ML5783
CITROËN	8731P2	ML5756
CITROËN	8731P4	ML5755
CITROËN	8731P5	ML5841
CITROËN	8731Q1	ML5776
CITROËN	8731Q9	ML5841
CITROËN	96472953808731K0	ML5782
CITROËN	C101860033	ML5430
DAEWOO		
DAEWOO	90159607	ML5031
DAEWOO	96298318	ML5095
DAEWOO	96301822	ML5507
DAEWOO	96306157	ML5087
DAEWOO	96310381	ML5513
DAEWOO	96324117	ML5087
DAEWOO	96324119	ML5087
DAEWOO	96394240	ML5513
DAEWOO	96557530	ML5095
DAEWOO	81850A70B02000	ML5051

	OE N°:	Ref.
FIAT		
FIAT	21083	ML5030
FIAT	4297742	ML5015
FIAT	4392129	ML5009
FIAT	4405569	ML5018
FIAT	4418499	ML5042
FIAT	4424045	ML5074
FIAT	4483658	ML5016
FIAT	5993542	ML5012
FIAT	5993542	ML5065
FIAT	7516691	ML5064
FIAT	7550172	ML5039
FIAT	7550938	ML5006
FIAT	7587706	ML5013
FIAT	7636049	ML5040
FIAT	7636049	ML5050
FIAT	7636049	ML5112
FIAT	7671700	ML5014
FIAT	7671700	ML5066
FIAT	7734566	ML5079
FIAT	7769737	ML5068
FIAT	7774707	ML5069
FIAT	39401990	ML5034
FIAT	39481770	ML5501
FIAT	39481770	ML5610
FIAT	46420780	ML5078
FIAT	46453503	ML5081
FIAT	46514867	ML5377
FIAT	46524047	ML5086
FIAT	46524049	ML5086
FIAT	46524051	ML5086
FIAT	46524678	ML5165
FIAT	46530124	ML5462
FIAT	46559850	ML5389
FIAT	46559858	ML5389
FIAT	46744596	ML5164
FIAT	46762434	ML5443
FIAT	46773097	ML5404
FIAT	46783650	ML5068
FIAT	46784590	ML5038
FIAT	46784994	ML5280
FIAT	46784995	ML5281
FIAT	46792437	ML5462
FIAT	46810696	ML5448
FIAT	46812168	ML5387
FIAT	46824070	ML5448
FIAT	46826216	ML5404
FIAT	46827091	ML5101
FIAT	46830389	ML5702
FIAT	46830389	ML5702
FIAT	46835404	ML5081
FIAT	51709681	ML5443
FIAT	51716995	ML5537
FIAT	51716996	ML5538
FIAT	51734960	ML5795
FIAT	51734960	ML5795
FIAT	51736743	ML5443
FIAT	51736744	ML5443
FIAT	51736745	ML5537
FIAT	51736746	ML5538
FIAT	51778432	ML5775
FIAT	51778432	ML5775
FIAT	51785412	ML5785
FIAT	51812267	ML5784
FIAT	71743352	ML5779
FIAT	71743353	ML5779
FIAT	76063040	ML5282
FIAT	82429686	ML5043
FIAT	1489342080	ML5458

	OE N°:	Ref.
FIAT	9622553680	ML5283
FIAT	9626493880	ML5283
FIAT	9630698380	ML5305
FIAT	XO39481770	ML5610
FORD		
FORD	1009060	ML5127
FORD	1025425	ML5136
FORD	1034930	ML5399
FORD	1047212	ML5127
FORD	1070024	ML5224
FORD	1071669	ML5168
FORD	1071732	ML5466
FORD	1072394	ML5466
FORD	1074368	ML5224
FORD	1079800	ML5168
FORD	1088369	ML5399
FORD	1092108	ML5466
FORD	1093705	ML5168
FORD	1094814	ML5127
FORD	1114031	ML5466
FORD	1117046	ML5231
FORD	1117246	ML5502
FORD	1117394	ML5374
FORD	1117690	ML5330
FORD	1119688	ML5232
FORD	1120812	ML5330
FORD	1124003	ML5467
FORD	1136483	ML5169
FORD	1141159	ML5206
FORD	1146649	ML5169
FORD	1150277	ML5224
FORD	1150279	ML5224
FORD	1211497	ML5289
FORD	1212586	ML5289
FORD	1218538	ML5205
FORD	1219986	ML5233
FORD	1224731	ML5207
FORD	1232189	ML5373
FORD	1251915	ML5205
FORD	1252377	ML5288
FORD	1252806	ML5288
FORD	1313218	ML5415
FORD	1321021	ML5416
FORD	1321021	ML5416
FORD	1336159	ML5786
FORD	1336230	ML5664
FORD	1349309	ML5664
FORD	1349309	ML5664
FORD	1376673	ML5786
FORD	1381555	ML5770
FORD	1405189	ML5771
FORD	1434296	ML5770
FORD	1434313	ML5771
FORD	1477988	ML5772
FORD	1484158	ML5704
FORD	1484371	ML5797
FORD	1496865	ML5704
FORD	1650686	ML5285
FORD	1666983	ML5388
FORD	4346105	ML5514
FORD	4378216	ML5295
FORD	6186916	ML5388
FORD	6656800	ML5161
FORD	6656800	ML5174
FORD	6723080	ML5109
FORD	6723080	ML5173
FORD	6885988	ML5161
FORD	6885988	ML5174

NUMERICAL LISTING

	OE N°:	Ref.
FORD		
FORD	6900217	ML5109
FORD	6962811	ML5388
FORD	7245797	ML5292
FORD	7300069	ML5127
FORD	1C15V406A10AD	ML5514
FORD	1C15V406A10EA	ML5514
FORD	1S7116C826AD	ML5330
FORD	1S71A406A10AB	ML5232
FORD	1S71A406A10CD	ML5233
FORD	1S71A406AD10AC	ML5231
FORD	1S71F406AD10AB	ML5502
FORD	1S71N406A10AB	ML5374
FORD	1S71N406A10AC	ML5373
FORD	2N11N406A10AD	ML5289
FORD	2S51B406A10AB	ML5205
FORD	2S51B406A10AC	ML5205
FORD	2S61B406A10AB	ML5206
FORD	2S61B406A10AC	ML5207
FORD	2T14V406A10AB	ML5295
FORD	3M51R406A10AB	ML5288
FORD	4M51A406A10AB	ML5416
FORD	4M51N406A10AA	ML5664
FORD	4M51N406A10AB	ML5664
FORD	5M51F406A10AA	ML5786
FORD	5M51F406A10AB	ML5786
FORD	6M21R406A10AB	ML5770
FORD	6M21R406A10AD	ML5770
FORD	6M21U406A10AB	ML5771
FORD	6M21U406A10AC	ML5771
FORD	7S71A406A10BA	ML5797
FORD	7S71F406A10AF	ML5704
FORD	7S71N406A10AD	ML5772
FORD	81ABD406A10BA	ML5286
FORD	81ABD406A10BB	ML5285
FORD	83BBA406A10AD	ML5080
FORD	83BBA406A10BD	ML5253
FORD	83BBA406A10CD	ML5614
FORD	83BBN406A10AD	ML5293
FORD	83BBN406A10BB	ML5294
FORD	84FBB406A10BB	ML5023
FORD	84FBB406A10CB	ML5465
FORD	85GBA406A10BD	ML5291
FORD	85GBA406A10CD	ML5110
FORD	85GBA406A10DD	ML5612
FORD	86ABB406A10GA	ML5463
FORD	86ABB406A10GA	ML5464
FORD	86ABB406A10HA	ML5200
FORD	86ABF406A10AA	ML5611
FORD	86ABW406A10CA	ML5286
FORD	86BBA406A10AA	ML5539
FORD	86BBA406A10BA	ML5539
FORD	86VBV406A10BA	ML5429
FORD	86VBV406A10CA	ML5076
FORD	88BBA406A10BAD	ML5614
FORD	89ABB406A10HA	ML5201
FORD	89FBB406A10A1C	ML5141
FORD	89FBB406A10B1C	ML5142
FORD	91ABA406A10A1D	ML5171
FORD	91ABA406A10A1E	ML5171
FORD	91ABA406A10C1	ML5172
FORD	91ABA406A10C1E	ML5109
FORD	91ABW406A10A1C	ML5161
FORD	91ABW406A10A1C	ML5174
FORD	91ABW406A10AF	ML5161
FORD	91ABW406A10AG	ML5174
FORD	91ABW406A10AG	ML5174
FORD	91ABW406A10C1C	ML5173

	OE N°:	Ref.
FORD	93ABA406A10B1B	ML5252
FORD	93ABA406A10C1B	ML5109
FORD	93BBA406A10AD	ML5126
FORD	93BBA406A10AE	ML5126
FORD	93BBA406A10BD	ML5176
FORD	93BBF406A10AB	ML5290
FORD	93BBF406A10BB	ML5431
FORD	93BBN406A10AC	ML5332
FORD	93FBB406A10AA	ML5143
FORD	93FBB406A10BA	ML5147
FORD	95GB16C826AB	ML5292
FORD	95VW442K08AE	ML5127
FORD	95VW442K08AG	ML5127
FORD	95VW442K08AH	ML5127
FORD	96GBN406A10AF	ML5388
FORD	97KGB406A10AA	ML5136
FORD	D83ABF406A10BA	ML5611
FORD	V97FBC406A10AB	ML5399
FORD	V97FBC406A10AC	ML5399
FORD	XS41A406A10AE	ML5224
FORD	XS41A406A10AF	ML5224
FORD	XS41F406A10AC	ML5466
FORD	XS41F406A10AD	ML5466
FORD	XS41F406A10AE	ML5466
FORD	XS41F406A10AF	ML5467
FORD	XS41N406A10AD	ML5168
FORD	XS41N406A10AE	ML5168
FORD	XS41N406A10AH	ML5169
FORD	XS41N406A10AJ	ML5169

FSO		
FSO	21273	ML5046
FSO	21331	ML5052
FSO	21333	ML5053
FSO	21377	ML5059
FSO	21406	ML5062
FSO	21457	ML5070
FSO	21458	ML5071
FSO	41190	ML5007
FSO	43882	ML5027
FSO	58084	ML5045
FSO	63397	ML5058
FSO	77187	ML5007
FSO	77187	ML5060
FSO	77763	ML5075
FSO	81768	ML5090
FSO	1171783	ML5027
FSO	4369120	ML5001

HONDA		
HONDA	04741S10000	ML5447
HONDA	04741S6A000	ML5615
HONDA	74820S1CE01	ML5787
HONDA	74820S1CE018	ML5787
HONDA	74820S1EE01	ML5122
HONDA	74820S5SE01	ML5396
HONDA	74820S6DE02	ML5371
HONDA	74820SH3305	ML5567
HONDA	74820SK3E20	ML5192
HONDA	74820SK3E20	ML5508
HONDA	74820SMGE01	ML5836
HONDA	74820SMGE010C1	ML5836
HONDA	74820SMGE02	ML5836
HONDA	74820SMGE021M1	ML5836
HONDA	74820SR3003	ML5568
HONDA	74820ST3E01	ML5214
HONDA	74820ST3E02	ML5214
HONDA	74820ST3E02	ML5405
HONDA	74820ST3E51	ML5214
HONDA	74820ST3E52	ML5214

	OE N°:	Ref.
HONDA	74870S5SE01	ML5396
HONDA	74870S6DE02	ML5371
HONDA	BHE38017	ML5508
HONDA	BHE38025	ML5192
HONDA	GTS120	ML5192
HONDA	GTS122	ML5508

HYUNDAI		
HYUNDAI	817712	ML5760
HYUNDAI	8116126000	ML5382
HYUNDAI	8177017010	ML5616
HYUNDAI	8177017030	ML5616
HYUNDAI	8177022200	ML5157
HYUNDAI	8177126010	ML5381
HYUNDAI	8177129221	ML5296
HYUNDAI	8178022200	ML5157
HYUNDAI	8717126010	ML5297
HYUNDAI	811602B010	ML5660
HYUNDAI	811612C000	ML5814
HYUNDAI	811613D000	ML5570
HYUNDAI	811613K000	ML5758
HYUNDAI	817701C000	ML5759
HYUNDAI	817701C001	ML5759
HYUNDAI	817712C010	ML5378
HYUNDAI	817712C011	ML5378
HYUNDAI	817712C020	ML5379
HYUNDAI	817712C021	ML5379
HYUNDAI	817712D210	ML5569
HYUNDAI	817712D220	ML5380
HYUNDAI	817713A00	ML5816
HYUNDAI	817713A001	ML5816
HYUNDAI	817713D000	ML5154
HYUNDAI	817713D001	ML5154
HYUNDAI	817713D002	ML5154
HYUNDAI	817713K000	ML5761

INNOCENTI		
INNOCENTI	53471007	ML5056

KIA		
KIA	8177007000	ML5708
KIA	8178007000	ML5708
KIA	0K2FB62620	ML5711
KIA	0K2FB62620A	ML5711
KIA	0K2FB62620B	ML5711
KIA	0K2FB63620	ML5711
KIA	0K2FB63620A	ML5711
KIA	0K2FB63620B	ML5711
KIA	0K53Y56620	ML5706
KIA	0K53Y56630	ML5706
KIA	0K53Y62620	ML5709
KIA	0K53Y63620	ML5709
KIA	0K53Z56620	ML5706
KIA	0K53Z56620A	ML5706
KIA	0K53Z56620B	ML5706
KIA	0K53Z56630	ML5706
KIA	0K53Z56630A	ML5706
KIA	0K53Z56630B	ML5706
KIA	0K53Z62620	ML5709
KIA	0K53Z62620A	ML5709
KIA	0K53Z63620	ML5709
KIA	0K53Z63620A	ML5709
KIA	817701G000	ML5712
KIA	817701H510	ML5839
KIA	817702F210	ML5713
KIA	817713C010	ML5710
KIA	817801G000	ML5712
KIA	817801H510	ML5839
KIA	817802F210	ML5713

NUMERICAL LISTING

	OE N°:	Ref.
LADA		
LADA	21086308010	ML5114
LADA	21086308015	ML5024
LADA	21118231010	ML5107
LADA	21118231015	ML5299
LADA	21128231010	ML5108
LADA	21216308010	ML5298
LADA	21216308015	ML5025

LANCIA		
LANCIA	5970097	ML5139
LANCIA	7703325	ML5139
LANCIA	7792951	ML5159
LANCIA	46309135	ML5541
LANCIA	46428438	ML5301
LANCIA	46429507	ML5483
LANCIA	46433702	ML5303
LANCIA	46453835	ML5302
LANCIA	46725028	ML5300
LANCIA	46763101	ML5484
LANCIA	46817935	ML5703
LANCIA	46817935	ML5703
LANCIA	60617400	ML5139
LANCIA	82336687	ML5618
LANCIA	82380453	ML5619
LANCIA	82437256	ML5617
LANCIA	82473205	ML5540
LANCIA	82486283	ML5482
LANCIA	1479303080	ML5304
LANCIA	9618278480	ML5304

LANDROVER		
LANDROVER	ALR1050	ML5649

MAZDA		
MAZDA	B1287F25	ML5403
MAZDA	B1287F26	ML5542
MAZDA	BN8W56930	ML5764
MAZDA	BN8W56930B	ML5764
MAZDA	BP4K62620D	ML5763
MAZDA	BP4K62620F	ML5763
MAZDA	BP4K63620D	ML5763
MAZDA	BP4K63620F	ML5763
MAZDA	DD1062620	ML5765
MAZDA	DD1063620	ML5765
MAZDA	G21B62620A	ML5684
MAZDA	G21B63620A	ML5684
MAZDA	GJ6J62620	ML5683
MAZDA	GJ6J63620	ML5683
MAZDA	NF7956930B	ML5810
MAZDA	NF8056930B	ML5810

MERCEDES		
MERCEDES	9802464	ML5102
MERCEDES	9802564	ML5102
MERCEDES	9803764	ML5102
MERCEDES	19808064	ML5674
MERCEDES	1637400345	ML5530
MERCEDES	1638800029	ML5559
MERCEDES	1647400145	ML5806
MERCEDES	1647400245	ML5806
MERCEDES	1689800164	ML5186
MERCEDES	1689800964	ML5186
MERCEDES	1689801164	ML5187
MERCEDES	1689801264	ML5188
MERCEDES	1697400345	ML5717
MERCEDES	1699800864	ML5718
MERCEDES	1699800964	ML5718
MERCEDES	1707500036	ML5680
MERCEDES	1717500036	ML5818

	OE N°:	Ref.
MERCEDES	1718800129	ML5798
MERCEDES	1719800164	ML5799
MERCEDES	2029800364	ML5307
MERCEDES	2037400045	ML5468
MERCEDES	2038800029	ML5577
MERCEDES	2038800429	ML5560
MERCEDES	2039800164	ML5673
MERCEDES	2047400145	ML5719
MERCEDES	2049800064	ML5715
MERCEDES	2088800029	ML5308
MERCEDES	2099800064	ML5808
MERCEDES	2099800364	ML5808
MERCEDES	2099800464	ML5808
MERCEDES	2099800564	ML5808
MERCEDES	2108800229	ML5438
MERCEDES	2108800429	ML5438
MERCEDES	2118800029	ML5309
MERCEDES	2158800029	ML5561
MERCEDES	2208800329	ML5620
MERCEDES	2217500216	ML5813
MERCEDES	2217500236	ML5813
MERCEDES	2307500036	ML5800
MERCEDES	2308800029	ML5811
MERCEDES	2309800164	ML5801
MERCEDES	2309800264	ML5802
MERCEDES	4149800064	ML5543
MERCEDES	6389800364	ML5329
MERCEDES	6389800464	ML5328
MERCEDES	6389800464	ML5621
MERCEDES	6399800364	ML5716
MERCEDES	A2208800329	ML5620

MG		
MG	BHE140010	ML5410
MG	BHE140020	ML5622
MG	BHE45001	ML5434
MG	BHE450030	ML5434
MG	BHE500050	ML5412
MG	BHE500070	ML5623
MG	BMH500010	ML5411

MINI		
MINI	41626801258	ML5406
MINI	51237175020	ML5564

MINI		
MITSUBISHI	MB926947	ML5578
MITSUBISHI	MB927791	ML5354
MITSUBISHI	MR101555	ML5278
MITSUBISHI	MR138596	ML5587
MITSUBISHI	MR248939	ML5353
MITSUBISHI	MR248940	ML5353
MITSUBISHI	MR959243	ML5661
MITSUBISHI	MR959247	ML5662
MITSUBISHI	MR991807	ML5757
MITSUBISHI	MR991808	ML5757

MOSKOWICZ		
MOSKOWICZ	21416306206	ML5004

NISSAN		
NISSAN	4414419	ML5516
NISSAN	8465124	ML5837
NISSAN	91168256	ML5516
NISSAN	7700303186	ML5837
NISSAN	7700308167	ML5837
NISSAN	6547040U10	ML5624
NISSAN	6547140U10	ML5624
NISSAN	844302F000	ML5322
NISSAN	844302F010	ML5321
NISSAN	8443090J00	ML5524

	OE N°:	Ref.
NISSAN	8443090J10	ML5525
NISSAN	844309F500	ML5321
NISSAN	84430AV600	ML5352
NISSAN	904501W302	ML5781
NISSAN	904501W312	ML5781
NISSAN	9045055A10	ML5409
NISSAN	9045079N02	ML5588
NISSAN	904509U00A	ML5701
NISSAN	90450AX000	ML5360
NISSAN	90450AX610	ML5360
NISSAN	90450BM400	ML5672
NISSAN	90450BM425	ML5672
NISSAN	90450BU000	ML5579
NISSAN	90450BU000	ML5579
NISSAN	90450EQ300	ML5809
NISSAN	90450EQ301	ML5809
NISSAN	90450EQ30A	ML5809
NISSAN	90450EQ31A	ML5809
NISSAN	90450EQ325	ML5809
NISSAN	90450EQ325	ML5809
NISSAN	904519C104	ML5582
NISSAN	90451AX000	ML5360
NISSAN	90451EQ30A	ML5809
NISSAN	90451EQ31A	ML5809
NISSAN	904522F705	ML5433
NISSAN	904522F715	ML5580
NISSAN	904522F725	ML5433
NISSAN	904523F200	ML5318
NISSAN	904523F201	ML5317
NISSAN	904523F202	ML5324
NISSAN	904526F100	ML5433
NISSAN	904526F126	ML5580
NISSAN	904528F825	ML5581
NISSAN	9045298J26	ML5324
NISSAN	904529F725	ML5423
NISSAN	90452AV700	ML5413
NISSAN	904601W301	ML5700
NISSAN	904606W560	ML5700

OPEL/VAUXHALL		
OPEL/VAUXHALL	132532	ML5805
OPEL/VAUXHALL	132670	ML5120
OPEL/VAUXHALL	132674	ML5515
OPEL/VAUXHALL	132675	ML5103
OPEL/VAUXHALL	132677	ML5166
OPEL/VAUXHALL	132681	ML5257
OPEL/VAUXHALL	132682	ML5398
OPEL/VAUXHALL	132691	ML5346
OPEL/VAUXHALL	132694	ML5585
OPEL/VAUXHALL	132695	ML5586
OPEL/VAUXHALL	132696	ML5527
OPEL/VAUXHALL	132701	ML5390
OPEL/VAUXHALL	132702	ML5243
OPEL/VAUXHALL	132703	ML5244
OPEL/VAUXHALL	132706	ML5834
OPEL/VAUXHALL	132708	ML5408
OPEL/VAUXHALL	132709	ML5408
OPEL/VAUXHALL	132710	ML5407
OPEL/VAUXHALL	132712	ML5585
OPEL/VAUXHALL	132713	ML5527
OPEL/VAUXHALL	132714	ML5586
OPEL/VAUXHALL	132715	ML5258
OPEL/VAUXHALL	132716	ML5032
OPEL/VAUXHALL	132717	ML5367
OPEL/VAUXHALL	132718	ML5242
OPEL/VAUXHALL	132719	ML5125
OPEL/VAUXHALL	132720	ML5156
OPEL/VAUXHALL	132721	ML5077
OPEL/VAUXHALL	132724	ML5054
OPEL/VAUXHALL	132725	ML5144

NUMERICAL LISTING

	OE N°:	Ref.
OPEL/VAUXHALL		
OPEL/VAUXHALL	132726	ML5369
OPEL/VAUXHALL	132727	ML5082
OPEL/VAUXHALL	132729	ML5515
OPEL/VAUXHALL	132730	ML5515
OPEL/VAUXHALL	132731	ML5424
OPEL/VAUXHALL	132734	ML5835
OPEL/VAUXHALL	132735	ML5407
OPEL/VAUXHALL	132736	ML5515
OPEL/VAUXHALL	132737	ML5515
OPEL/VAUXHALL	132739	ML5138
OPEL/VAUXHALL	132741	ML5167
OPEL/VAUXHALL	132742	ML5137
OPEL/VAUXHALL	132743	ML5669
OPEL/VAUXHALL	132743	ML5669
OPEL/VAUXHALL	132743	ML5669
OPEL/VAUXHALL	132749	ML5722
OPEL/VAUXHALL	132757	ML5721
OPEL/VAUXHALL	176387	ML5179
OPEL/VAUXHALL	176413	ML5807
OPEL/VAUXHALL	176414	ML5827
OPEL/VAUXHALL	176601	ML5366
OPEL/VAUXHALL	176602	ML5366
OPEL/VAUXHALL	176603	ML5365
OPEL/VAUXHALL	176605	ML5210
OPEL/VAUXHALL	176607	ML5341
OPEL/VAUXHALL	176608	ML5773
OPEL/VAUXHALL	176608	ML5773
OPEL/VAUXHALL	176608	ML5773
OPEL/VAUXHALL	176609	ML5817
OPEL/VAUXHALL	1178224	ML5345
OPEL/VAUXHALL	1180402	ML5085
OPEL/VAUXHALL	1180405	ML5720
OPEL/VAUXHALL	4705436	ML5088
OPEL/VAUXHALL	4705437	ML5089
OPEL/VAUXHALL	4705684	ML5088
OPEL/VAUXHALL	4705685	ML5089
OPEL/VAUXHALL	5132262	ML5119
OPEL/VAUXHALL	9114311	ML5120
OPEL/VAUXHALL	9152393	ML5257
OPEL/VAUXHALL	9177081	ML5341
OPEL/VAUXHALL	9180255	ML5773
OPEL/VAUXHALL	9180256	ML5817
OPEL/VAUXHALL	9209569	ML5088
OPEL/VAUXHALL	9209570	ML5089
OPEL/VAUXHALL	9210307	ML5088
OPEL/VAUXHALL	9210308	ML5089
OPEL/VAUXHALL	10233372	ML5515
OPEL/VAUXHALL	10233373	ML5515
OPEL/VAUXHALL	10324007	ML5515
OPEL/VAUXHALL	10400854	ML5515
OPEL/VAUXHALL	10400855	ML5515
OPEL/VAUXHALL	13101335	ML5346
OPEL/VAUXHALL	13122695	ML5721
OPEL/VAUXHALL	13128759	ML5722
OPEL/VAUXHALL	13182309	ML5807
OPEL/VAUXHALL	13182537	ML5827
OPEL/VAUXHALL	13191401	ML5817
OPEL/VAUXHALL	13220159	ML5805
OPEL/VAUXHALL	13241974	ML5773
OPEL/VAUXHALL	13243589	ML5723
OPEL/VAUXHALL	13247868	ML5817
OPEL/VAUXHALL	24411022	ML5167
OPEL/VAUXHALL	24454473	ML5345
OPEL/VAUXHALL	24463829	ML5669
OPEL/VAUXHALL	24465295	ML5720
OPEL/VAUXHALL	90043132	ML5398
OPEL/VAUXHALL	90119276	ML5585
OPEL/VAUXHALL	90127136	ML5585
OPEL/VAUXHALL	90127137	ML5527

	OE N°:	Ref.
OPEL/VAUXHALL	90127138	ML5586
OPEL/VAUXHALL	90138517	ML5527
OPEL/VAUXHALL	90138518	ML5586
OPEL/VAUXHALL	90159629	ML5834
OPEL/VAUXHALL	90191627	ML5244
OPEL/VAUXHALL	90191920	ML5243
OPEL/VAUXHALL	90195260	ML5390
OPEL/VAUXHALL	90196023	ML5835
OPEL/VAUXHALL	90227934	ML5258
OPEL/VAUXHALL	90227936	ML5032
OPEL/VAUXHALL	90241995	ML5407
OPEL/VAUXHALL	90241996	ML5407
OPEL/VAUXHALL	90246620	ML5408
OPEL/VAUXHALL	90246621	ML5408
OPEL/VAUXHALL	90275073	ML5366
OPEL/VAUXHALL	90275080	ML5366
OPEL/VAUXHALL	90275102	ML5365
OPEL/VAUXHALL	90341282	ML5077
OPEL/VAUXHALL	90341377	ML5156
OPEL/VAUXHALL	90341378	ML5125
OPEL/VAUXHALL	90346469	ML5367
OPEL/VAUXHALL	90379054	ML5210
OPEL/VAUXHALL	90379081	ML5103
OPEL/VAUXHALL	90388707	ML5144
OPEL/VAUXHALL	90463253	ML5179
OPEL/VAUXHALL	90463721	ML5085
OPEL/VAUXHALL	90463749	ML5082
OPEL/VAUXHALL	90463781	ML5424
OPEL/VAUXHALL	90481180	ML5369
OPEL/VAUXHALL	90481269	ML5242
OPEL/VAUXHALL	90481270	ML5054
OPEL/VAUXHALL	90521517	ML5166
OPEL/VAUXHALL	90559245	ML5138
OPEL/VAUXHALL	90579440	ML5137
OPEL/VAUXHALL	93386999	ML5119
PEUGEOT		
PEUGEOT	347040	ML5471
PEUGEOT	792505	ML5583
PEUGEOT	792506	ML5268
PEUGEOT	792507	ML5517
PEUGEOT	792508	ML5470
PEUGEOT	792509	ML5267
PEUGEOT	792510	ML5470
PEUGEOT	792515	ML5160
PEUGEOT	792516	ML5788
PEUGEOT	862214	ML5625
PEUGEOT	862215	ML5628
PEUGEOT	873143	ML5067
PEUGEOT	873148	ML5364
PEUGEOT	873149	ML5364
PEUGEOT	873151	ML5311
PEUGEOT	873178	ML5202
PEUGEOT	873179	ML5326
PEUGEOT	873183	ML5426
PEUGEOT	873185	ML5133
PEUGEOT	873186	ML5133
PEUGEOT	873191	ML5134
PEUGEOT	873193	ML5148
PEUGEOT	51023704	ML5146
PEUGEOT	7920062656	ML5067
PEUGEOT	7920071833	ML5364
PEUGEOT	8731000000	ML5146
PEUGEOT	9252344980	ML5625
PEUGEOT	9255607980	ML5628
PEUGEOT	9256119680	ML5020
PEUGEOT	9601430480	ML5180
PEUGEOT	9601430480	ML5426
PEUGEOT	9602673980	ML5583
PEUGEOT	9603762280	ML5202

	OE N°:	Ref.
PEUGEOT	9603762380	ML5326
PEUGEOT	9605478880	ML5133
PEUGEOT	9605478888	ML5133
PEUGEOT	9610016680	ML5148
PEUGEOT	9612504980	ML5180
PEUGEOT	9612504980	ML5426
PEUGEOT	9617046480	ML5323
PEUGEOT	9619988380	ML5148
PEUGEOT	9622165080	ML5316
PEUGEOT	9624450980	ML5432
PEUGEOT	9626771680	ML5319
PEUGEOT	9628157780	ML5470
PEUGEOT	9629219580	ML5267
PEUGEOT	9630662480	ML5470
PEUGEOT	9636450380	ML5183
PEUGEOT	9637115080	ML5343
PEUGEOT	9638605280	ML5425
PEUGEOT	9642209980	ML5469
PEUGEOT	9642210080	ML5340
PEUGEOT	9647261480	ML5727
PEUGEOT	9647487680	ML5728
PEUGEOT	9647487880	ML5729
PEUGEOT	9649587680	ML5730
PEUGEOT	9656592980	ML5727
PEUGEOT	9656593180	ML5729
PEUGEOT	8731A1	ML5316
PEUGEOT	8731A2	ML5323
PEUGEOT	8731A3	ML5626
PEUGEOT	8731A7	ML5180
PEUGEOT	8731C1	ML5627
PEUGEOT	8731C5	ML5319
PEUGEOT	8731C9	ML5471
PEUGEOT	8731E0	ML5432
PEUGEOT	8731E5	ML5363
PEUGEOT	8731E9	ML5183
PEUGEOT	8731F2	ML5343
PEUGEOT	8731F8	ML5425
PEUGEOT	8731F9	ML5358
PEUGEOT	8731G4	ML5340
PEUGEOT	8731G5	ML5469
PEUGEOT	8731G9	ML5358
PEUGEOT	8731J3	ML5730
PEUGEOT	8731J6	ML5728
PEUGEOT	8731K4	ML5727
PEUGEOT	8731K5	ML5729
PEUGEOT	8731L7	ML5731
PEUGEOT	8731P8	ML5733
PEUGEOT	8731P9	ML5732
PEUGEOT	8731Q0	ML5732
PEUGEOT	8731Q6	ML5734
PORSCHE		
PORSCHE	91151133101	ML5646
PORSCHE	91151233101	ML5595
PORSCHE	91151233102	ML5594
PORSCHE	92851113903	ML5676
PORSCHE	94451135101	ML5846
PORSCHE	99751155101	ML5803
PORSCHE	99751255100	ML5804
RENAULT		
RENAULT	8453460	ML5724
RENAULT	8489348	ML5826
RENAULT	32062565	ML5725
RENAULT	6025001988	ML5629
RENAULT	6025003919	ML5629
RENAULT	6025005935	ML5320
RENAULT	6025006621	ML5320
RENAULT	6025100991	ML5546
RENAULT	6025101952	ML5313
RENAULT	6025106762	ML5314

NUMERICAL LISTING

	OE N°:	Ref.
RENAULT		
RENAULT	6025300735	ML5228
RENAULT	6025305941	ML5229
RENAULT	6025306563	ML5230
RENAULT	6025401711	ML5351
RENAULT	7700272026	ML5093
RENAULT	7700303139	ML5128
RENAULT	7700303186	ML5128
RENAULT	7700413083	ML5476
RENAULT	7700414002	ML5477
RENAULT	7700418621	ML5158
RENAULT	7700421906	ML5155
RENAULT	7700430022	ML5153
RENAULT	7700434465	ML5150
RENAULT	7700434465	ML5152
RENAULT	7700753540	ML5633
RENAULT	7700785587	ML5632
RENAULT	7700786248	ML5256
RENAULT	7700787749	ML5337
RENAULT	7700795698	ML5631
RENAULT	7700795731	ML5631
RENAULT	7700799027	ML5256
RENAULT	7700800311	ML5093
RENAULT	7700807057	ML5315
RENAULT	7700810554	ML5254
RENAULT	7700811019	ML5554
RENAULT	7700811570	ML5310
RENAULT	7700812193	ML5327
RENAULT	7700815135	ML5331
RENAULT	7700818237	ML5094
RENAULT	7700823271	ML5279
RENAULT	7700824817	ML5553
RENAULT	7700828451	ML5131
RENAULT	7700828454	ML5130
RENAULT	7700829764	ML5279
RENAULT	7700829825	ML5555
RENAULT	7700831959	ML5554
RENAULT	7700832534	ML5555
RENAULT	7700838005	ML5383
RENAULT	7700838006	ML5547
RENAULT	7700838487	ML5526
RENAULT	7700838612	ML5182
RENAULT	7700838690	ML5526
RENAULT	7700842152	ML5279
RENAULT	7700842153	ML5279
RENAULT	7700842256	ML5241
RENAULT	7700843698	ML5131
RENAULT	7700846538	ML5383
RENAULT	7700846772	ML5544
RENAULT	7700846773	ML5545
RENAULT	7700848404	ML5686
RENAULT	7700848464	ML5686
RENAULT	7701033344	ML5549
RENAULT	7702144629	ML5021
RENAULT	7702149568	ML5630
RENAULT	7703024021	ML5548
RENAULT	8200000896	ML5548
RENAULT	8200000902	ML5189
RENAULT	8200000903	ML5440
RENAULT	8200003020	ML5190
RENAULT	8200021974	ML5518
RENAULT	8200021975	ML5519
RENAULT	8200025105	ML5551
RENAULT	8200025317	ML5474
RENAULT	8200051750	ML5212
RENAULT	8200091749	ML5472
RENAULT	8200119497	ML5789
RENAULT	8200119498	ML5372
RENAULT	8200119500	ML5475
RENAULT	8200130187	ML5552

	OE N°:	Ref.
RENAULT	8200135264	ML5812
RENAULT	8200162697	ML5550
RENAULT	8200174571	ML5826
RENAULT	8200212598	ML5828
RENAULT	8200219322	ML5724
RENAULT	8200299546	ML5725
RENAULT	8200362400	ML5473
RENAULT	8200377199	ML5826
RENAULT	8200377789	ML5475

ROVER		
ROVER	BHE140020	ML5478
ROVER	BHE38017	ML5634
ROVER	BHE39005	ML5208
ROVER	BHE39006	ML5209
ROVER	BHE41003	ML5384
ROVER	BHE41004	ML5384
ROVER	BHE450030	ML5394
ROVER	BHE450030	ML5815
ROVER	BHE500070	ML5479
ROVER	BHM410040	ML5338
ROVER	BKK41003	ML5359
ROVER	GSA922	ML5208
ROVER	GSA923	ML5209
ROVER	GSA930	ML5634
ROVER	GTS122	ML5634

SAAB		
SAAB	4006060	ML5557
SAAB	4006078	ML5495
SAAB	4323994	ML5636
SAAB	4324307	ML5401
SAAB	4326468	ML5400
SAAB	4699260	ML5637
SAAB	4854717	ML5375
SAAB	4854733	ML5375
SAAB	4855094	ML5558
SAAB	4858627	ML5402
SAAB	5022082	ML5397
SAAB	5117015	ML5558
SAAB	5183017	ML5349
SAAB	5360839	ML5558
SAAB	6956262	ML5498
SAAB	6956270	ML5499
SAAB	6956288	ML5494
SAAB	6976369	ML5496
SAAB	9231796	ML5613
SAAB	9233727	ML5613
SAAB	9253964	ML5497
SAAB	9270240	ML5556
SAAB	9293580	ML5635
SAAB	12785021	ML5790
SAAB	12831543	ML5766
SAAB	127850021	ML5790
SAAB	1012831543	ML5766

SEAT		
SEAT	1L0827550	ML5124
SEAT	1L0827550A	ML5124
SEAT	1M0823359A	ML5342
SEAT	1M6827550A	ML5181
SEAT	1P0827550	ML5767
SEAT	1P0827550A	ML5767
SEAT	5P0827550A	ML5100
SEAT	5P5827550	ML5584
SEAT	6E0827550C	ML5195
SEAT	6K5827550	ML5063
SEAT	6K5827550C	ML5259
SEAT	6K6827550	ML5140
SEAT	6K6827550A	ML5211
SEAT	6L5827550B	ML5778

	OE N°:	Ref.
SEAT	6L6827550B	ML5225
SEAT	6X0827550	ML5284
SEAT	6X0827550A	ML5284
SEAT	7M3827550A	ML5480
SEAT	8L0823359	ML5284
SEAT	SE021526200A	ML5022
SEAT	W06K5827550	ML5063
SEAT	W06K6827550	ML5140
SEAT	W1L0827550	ML5124
SEAT	XO39503120	ML5022
SEAT	XO39507910	ML5022

SKODA		
SKODA	41964420476	ML5048
SKODA	441564420066	ML5036
SKODA	441664420076	ML5037
SKODA	441664420086	ML5057
SKODA	441964420476	ML5061
SKODA	441964420486	ML5044
SKODA	441964920386	ML5005
SKODA	1U6827550	ML5217
SKODA	1U6827550A	ML5217
SKODA	1U6827550B	ML5217
SKODA	1U6827550C	ML5217
SKODA	1U6827550E	ML5218
SKODA	1U6827550F	ML5219
SKODA	1U6827550G	ML5220
SKODA	1U6827550H	ML5221
SKODA	1Z5827550	ML5665
SKODA	1Z5827550B	ML5665
SKODA	1Z5827550C	ML5665
SKODA	1Z5827550D	ML5665
SKODA	1Z5827550E	ML5665
SKODA	1Z5827550F	ML5665
SKODA	1Z9827550	ML5667
SKODA	3B5827550E	ML5439
SKODA	3U0823359	ML5768
SKODA	5J6827550B	ML5681
SKODA	5J7827550	ML5682
SKODA	6U0827551A	ML5061
SKODA	6U0827551B	ML5061
SKODA	6Y0827550A	ML5175

SMART		
SMART	113000013	ML5640
SMART	0000618V007	ML5640

SSANGYONG		
SSANGYONG	7115008100	ML5355
SSANGYONG	7140608100	ML5334
SSANGYONG	7140608110	ML5334
SSANGYONG	7141608100	ML5334
SSANGYONG	7141608110	ML5334
SSANGYONG	7143608100	ML5356

SUBARU		
SUBARU	60315FA010	ML5820
SUBARU	60335FA000	ML5820
SUBARU	60335FA100	ML5820
SUBARU	60335FA120	ML5820
SUBARU	63269FE000	ML5819

SUZUKI		
SUZUKI	8180062831	ML5091
SUZUKI	8180062841	ML5092
SUZUKI	8185062B20	ML5091
SUZUKI	8185086G00000	ML5780
SUZUKI	8185086G00X10	ML5780
SUZUKI	81850M76G20A	ML5589
SUZUKI	8186062B20	ML5092
SUZUKI	8186086G00000	ML5780
SUZUKI	81860A80100	ML5492

NUMERICAL LISTING

	OE N°:	Ref.
SUZUKI		
SUZUKI	81860M70F10000	ML5589
SUZUKI	81860M76G20A	ML5589
SUZUKI	9390085C00	ML5493
TOYOTA		
TOYOTA	6894005072	ML5699
TOYOTA	6895002040	ML5485
TOYOTA	6895005050	ML5121
TOYOTA	6895005060	ML5699
TOYOTA	6895009110	ML5821
TOYOTA	6895009140	ML5647
TOYOTA	6895009140	ML5699
TOYOTA	6895009150	ML5699
TOYOTA	6896002030	ML5485
TOYOTA	6896005050	ML5121
TOYOTA	6896005060	ML5699
TOYOTA	6896005072	ML5699
TOYOTA	6896009050	ML5592
TOYOTA	6896009080	ML5592
TOYOTA	6896009090	ML5647
TOYOTA	6896009090	ML5699
TOYOTA	6896009100	ML5699
TOYOTA	6896009120	ML5821
TOYOTA	689500D020	ML5777
TOYOTA	689500D021	ML5777
TOYOTA	689500D022	ML5777
TOYOTA	689500F010	ML5666
TOYOTA	689500F011	ML5666
TOYOTA	689500F012	ML5666
TOYOTA	689500W101	ML5641
TOYOTA	689500W140	ML5486
TOYOTA	689500W170	ML5485
TOYOTA	689600D010	ML5777
TOYOTA	689600D011	ML5777
TOYOTA	689600D012	ML5777
TOYOTA	689600F010	ML5666
TOYOTA	689600F011	ML5666
TOYOTA	689600F012	ML5666
TOYOTA	689600W091	ML5641
TOYOTA	689600W140	ML5486
TOYOTA	689600W170	ML5485
VOLVO		
VOLVO	819865	ML5368
VOLVO	1355263	ML5312
VOLVO	3344245	ML5642
VOLVO	3436644	ML5509
VOLVO	3436644	ML5571
VOLVO	3470348	ML5571
VOLVO	3470350	ML5509
VOLVO	3470350	ML5571
VOLVO	3509482	ML5529
VOLVO	3512998	ML5840
VOLVO	3526575	ML5347
VOLVO	3529925	ML5348
VOLVO	6846014	ML5312
VOLVO	8600233	ML5481
VOLVO	8650233	ML5481
VOLVO	9154605	ML5643
VOLVO	9187315	ML5529
VOLVO	9483297	ML5489
VOLVO	9483299	ML5489
VOLVO	9483570	ML5726
VOLVO	9485548	ML5529
VOLVO	9485706	ML5487
VOLVO	30634580	ML5427
VOLVO	30649439	ML5490
VOLVO	30649736	ML5361
VOLVO	30674203	ML5488

	OE N°:	Ref.
VOLVO	30674494	ML5685
VOLVO	30674718	ML5500
VOLVO	30674971	ML5488
VOLVO	30716189	ML5500
VOLVO	30803472	ML5184
VOLVO	31218478	ML5726
VW		
VW	147827550	ML5572
VW	251829331	ML5106
VW	251829332	ML5645
VW	333827550	ML5123
VW	533827550	ML5677
VW	867827550	ML5644
VW	1918827550	ML5574
VW	171827550A	ML5073
VW	1C0823359B	ML5393
VW	1C0823359C	ML5393
VW	1C0823359D	ML5393
VW	1C0827550A	ML5325
VW	1C0827550B	ML5325
VW	1C0827550C	ML5325
VW	1C0827550D	ML5325
VW	1E0827550	ML5675
VW	1E0827550B	ML5675
VW	1H5827550A	ML5226
VW	1H5827550B	ML5226
VW	1H6827550	ML5049
VW	1H6827550A	ML5049
VW	1H9827550A	ML5191
VW	1J0823359C	ML5264
VW	1J6827550	ML5132
VW	1K0823359A	ML5735
VW	1K5827550C	ML5751
VW	1K6827550D	ML5742
VW	1K6827550E	ML5742
VW	1K6827550F	ML5742
VW	1K9827550A	ML5754
VW	1Q0823359	ML5738
VW	1Q0827550A	ML5752
VW	1Q0827550B	ML5752
VW	1T0823359	ML5736
VW	1T0823359A	ML5736
VW	1T0827550A	ML5743
VW	1T0827550B	ML5743
VW	1T0827550C	ML5743
VW	1T0827550D	ML5743
VW	1T0827550E	ML5743
VW	1Y0827550B	ML5791
VW	1Y0827550D	ML5791
VW	1Y0827550F	ML5791
VW	251829331A	ML5106
VW	251829331B	ML5645
VW	2K0827550	ML5750
VW	2K0827550A	ML5750
VW	3A9827550	ML5123
VW	3B9827550	ML5185
VW	3C0823359	ML5829
VW	3C0823359A	ML5829
VW	3C5827550A	ML5830
VW	3C5827550B	ML5830
VW	3C5827550C	ML5830
VW	3C9827550	ML5831
VW	3C9827550A	ML5831
VW	533827550A	ML5677
VW	535827550A	ML5573
VW	5M0827550	ML5792
VW	5M0827550A	ML5792
VW	5N0827550A	ML5838

	OE N°:	Ref.
VW	5Z6827550B	ML5796
VW	6E0827550B	ML5199
VW	6N0823359	ML5265
VW	6N0827550A	ML5145
VW	6Q0823359	ML5491
VW	6Q0823359A	ML5491
VW	6Q5827550A	ML5748
VW	6Q5827550B	ML5748
VW	6Q6827550	ML5194
VW	6Q6827550	ML5196
VW	6Q6827550A	ML5196
VW	6X0823359B	ML5287
VW	6X0823359C	ML5339
VW	701829331AB	ML5250
VW	701829331F	ML5246
VW	701829331G	ML5245
VW	701829331H	ML5105
VW	701829331J	ML5247
VW	701829331Q	ML5118
VW	701829331D	ML5249
VW	701829331S	ML5251
VW	701829331T	ML5248
VW	7827550A	ML5644
VW	7H0823359A	ML5832
VW	7H0823359B	ML5832
VW	7H0823359C	ML5832
VW	7H0827550	ML5575
VW	7H0827550B	ML5576
VW	7H0827550C	ML5833
VW	7H0827550D	ML5833
VW	7L6823359B	ML5357
VW	7L6845587	ML5793
VW	7L6845587A	ML5793
VW	867827550C	ML5177
VW	867827550D	ML5178
ZASTAVA		
ZASTAVA	46622166	ML5097
ZASTAVA	46635997	ML5008
ZASTAVA	46636020	ML5028
ZASTAVA	46636021	ML5028
ZASTAVA	46636022	ML5029
ZAZ		
ZAZ	126308506	ML5115
ZAZ	136308506	ML5035
ZAZ	1216308506	ML5072
ZAZ	1326308506	ML5116
ZAZ	11026308016	ML5035

MONROE® MAX-LIFT CROSS REFERENCE

STABILUS

STABILUS	MONROE®	STABILUS	MONROE®	STABILUS	MONROE®	STABILUS	MONROE®	STABILUS	MONROE®
0008SX	ML5206	0789FA	ML5242	1568TV	ML5693	2486ZV	ML5665	3592SV	ML5826
0008SX	ML5207	0789PO	ML5759	1577BL	ML5522	2487ZQ	ML5665	3605KE	ML5277
0009DY	ML5367	0792FC	ML5054	1585BP	ML5422	2512WH	ML5459	3749WN	ML5809
0026DA	ML5258	0792FC	ML5242	1588QV	ML5068	2554NJ	ML5121	3781WC	ML5809
0028DR	ML5032	0793KE	ML5368	1589BV	ML5170	2558NQ	ML5121	3789WQ	ML5809
0028DR	ML5258	0813MK	ML5226	1592BY	ML5019	2561WJ	ML5671	3796WZ	ML5809
0031DT	ML5077	0818MM	ML5241	1598PT	ML5412	2569LN	ML5138	3798NY	ML5134
0033DJ	ML5125	0823NA	ML5129	1617MX	ML5640	2571WD	ML5812	3904PW	ML5239
0046SJ	ML5703	0825MV	ML5123	1628NI	ML5468	2572WZ	ML5552	3915PL	ML5511
0093IH	ML5019	0833HS	ML5436	1646NG	ML5277	2573WU	ML5372	3917NJ	ML5393
0093IH	ML5609	0876YT	ML5269	1702QE	ML5198	2574WP	ML5828	3935ZN	ML5225
0098IZ	ML5411	0895QR	ML5705	1708TQ	ML5460	2584WJ	ML5789	3937AM	ML5649
0101IK	ML5452	0933SV	ML5702	1718NH	ML5511	2586XW	ML5746	3958IA	ML5529
0108IC	ML5601	0953VY	ML5805	1757VK	ML5717	2614KL	ML5166	3958SO	ML5360
0108IC	ML5602	0955HQ	ML5136	1758VF	ML5717	2639KB	ML5120	3975FP	ML5637
0174HL	ML5541	0955QH	ML5434	1759VA	ML5717	2696LD	ML5135	3987SB	ML5687
0187SA	ML5119	0999MG	ML5675	1765QH	ML5699	2697LZ	ML5135	3987SB	ML5730
0197IH	ML5456	0999RN	ML5828	1791BP	ML5285	2697LZ	ML5193	4012LQ	ML5690
0197IH	ML5627	1001MU	ML5675	1793BF	ML5286	2699UG	ML5744	4013VV	ML5391
0224DX	ML5260	1026AW	ML5273	1806BK	ML5171	2705RE	ML5800	4013VV	ML5468
0244HW	ML5336	1036VW	ML5690	1807BF	ML5172	2745GY	ML5624	4027CV	ML5276
0259LC	ML5265	1041VO	ML5688	1808BA	ML5109	2765UK	ML5107	4038KF	ML5195
0287QB	ML5631	1047VL	ML5763	1808BA	ML5172	2765UK	ML5299	4039KA	ML5132
0288RT	ML5799	1057VF	ML5763	1808BA	ML5173	2827RC	ML5721	4043KY	ML5535
0292IZ	ML5325	1087PL	ML5370	1814AT	ML5081	2864UI	ML5780	4044WZ	ML5718
0316QO	ML5800	1114WG	ML5749	1819BQ	ML5252	2874GE	ML5082	4045WU	ML5718
0319VG	ML5699	1128SX	ML5481	1820BB	ML5109	2874GE	ML5257	4047NT	ML5343
0321VN	ML5699	1128TT	ML5366	1873TT	ML5803	2877GQ	ML5085	4081FD	ML5428
0325VU	ML5699	1152RM	ML5168	1875DT	ML5426	2894RC	ML5616	4081FD	ML5678
0326VP	ML5699	1179KU	ML5499	1877BR	ML5170	2928UF	ML5739	4147PE	ML5432
0354KY	ML5159	1187KY	ML5176	1913YB	ML5701	2937ZL	ML5836	4173XB	ML5439
0406IS	ML5312	1193RK	ML5198	1962RE	ML5459	2958GQ	ML5624	4209AR	ML5143
0421NL	ML5672	1194SB	ML5744	1975BU	ML5429	2988TA	ML5394	4214PD	ML5790
0421VG	ML5530	1196MP	ML5061	1976BP	ML5429	3011XI	ML5836	4238RR	ML5357
0424HU	ML5235	1207QO	ML5295	1979BA	ML5080	3061KD	ML5375	4249RG	ML5769
0427HF	ML5235	1232VB	ML5776	1986BJ	ML5294	3062KZ	ML5375	4279NE	ML5270
0438NY	ML5809	1232VW	ML5776	1990BG	ML5080	3063KU	ML5402	4348MY	ML5342
0442NV	ML5809	1263MO	ML5620	1996BD	ML5612	3121TL	ML5747	4411IF	ML5234
0482RI	ML5773	1272PB	ML5297	1997BZ	ML5110	3146ZE	ML5704	4473PM	ML5227
0488KG	ML5127	1275PN	ML5167	1998BU	ML5110	3158TM	ML5164	4495VU	ML5718
0488VQ	ML5559	1276PI	ML5569	2001BC	ML5611	3158TM	ML5165	4535VW	ML5746
0512RQ	ML5345	1277PD	ML5710	2008BV	ML5200	3161YV	ML5809	4546NQ	ML5768
0519FC	ML5178	1293BN	ML5846	2008BV	ML5201	3162TJ	ML5164	4636II	ML5308
0542SV	ML5443	1295BD	ML5142	2010BB	ML5201	3168YN	ML5809	4645NO	ML5218
0552TL	ML5786	1299KB	ML5238	2012BS	ML5464	3169SF	ML5288	4656NO	ML5218
0591PI	ML5186	1308PG	ML5137	2012BS	ML5464	3183TT	ML5442	4657IS	ML5509
0592PD	ML5438	1309PB	ML5210	2014BI	ML5023	3187BR	ML5043	4657IS	ML5571
0593PZ	ML5561	1311PI	ML5257	2038YT	ML5753	3211CY	ML5146	4711UR	ML5765
0623BI	ML5253	1313WY	ML5443	2048RO	ML5637	3211CY	ML5316	4742NW	ML5203
0624KV	ML5184	1325BL	ML5210	2206NX	ML5377	3235YM	ML5508	4742NW	ML5204
0644PQ	ML5577	1358RW	ML5696	2211NP	ML5389	3235YM	ML5634	4751SB	ML5789
0645PL	ML5560	1381MF	ML5263	2232KK	ML5642	3261XS	ML5817	4756UW	ML5779
0648KQ	ML5398	1386BY	ML5111	2239NR	ML5164	3269YB	ML5406	4839QB	ML5194
0681VK	ML5563	1387BT	ML5420	2254ND	ML5198	3277YF	ML5352	4839QB	ML5196
0685VR	ML5691	1393BG	ML5417	2261NM	ML5449	3286GW	ML5523	4932SV	ML5425
0685VR5754UY	ML5691	1396BS	ML5533	2268FJ	ML5517	3286UU	ML5729	4953PQ	ML5223
0691QY	ML5453	1405BQ	ML5376	2275TQ	ML5722	3289YQ	ML5371	4958SG	ML5151
0707VV	ML5695	1406BL	ML5104	2282NW	ML5150	3293GE	ML5441	5001ZR	ML5737
0712PK	ML5670	1431EG	ML5098	2282NW	ML5152	3293UH	ML5664	5011ZL	ML5744
0714FN	ML5093	1431EG	ML5446	2283NR	ML5130	3309RE	ML5764	5037SY	ML5377
0727PG	ML5163	1462BW	ML5599	2291TY	ML5744	3339FH	ML5430	5044SG	ML5377
0744VM	ML5693	1464BM	ML5596	2292NQ	ML5153	3347XU	ML5396	5056KW	ML5183
0745VH	ML5565	1477MB	ML5259	2315TS	ML5749	3401UZ	ML5727	5073BH	ML5338
0751VV	ML5720	1492RV	ML5297	2334BC	ML5421	3402UU	ML5727	5086PL	ML5404
0752VQ	ML5669	1492RV	ML5616	2335QS	ML5154	3442UX	ML5416	5105SS	ML5579
0755VB	ML5088	1501RT	ML5759	2417BT	ML5249	3445FO	ML5261	5114PC	ML5351
0756VX	ML5721	1513BN	ML5600	2426FC	ML5069	3445FO	ML5264	5126VQ	ML5699
0759VI	ML5817	1516RP	ML5707	2435QL	ML5699	3466PL	ML5688	5132VD	ML5699
0762VK	ML5213	1517RK	ML5711	2442PY	ML5179	3474XK	ML5577	5146ZP	ML5488
0763VF	ML5562	1525QS	ML5380	2446TP	ML5248	3477XW	ML5560	5197IV	ML5217
0772VE	ML5769	1529QZ	ML5570	2449RI	ML5782	3489US	ML5806	5204PB	ML5448
0786FP	ML5144	1535NY	ML5370	2449RI	ML5824	3493UP	ML5806	5226IH	ML5215
0786rv	ML5448	1559BN	ML5573	2474LM	ML5161	3587SC	ML5044	5245VC	ML5666
0789FA	ML5054	1567RH	ML5720	2474LM	ML5174	3587SC	ML5061	5253VG	ML5699

CROSS REFERENCE

MONROE® MAX-LIFT CROSS REFERENCE

STABILUS

STABILUS	MONROE®	STABILUS	MONROE®	STABILUS	MONROE®	STABILUS	MONROE®	STABILUS	MONROE®
5262VF	ML5699	6518NI	ML5439	7557HF	ML5314	8413HV	ML5197	9262QU	ML5782
5279QL	ML5766	6541LG	ML5131	7587GS	ML5321	8413LF	ML5487	9262QU	ML5824
5336XP	ML5742	6543LX	ML5131	7587GS	ML5322	8429CF	ML5246	9262UE	ML5810
5353SL	ML5789	6543NP	ML5199	7609LC	ML5217	8429DB	ML5532	9267UG	ML5810
5354SG	ML5799	6553NJ	ML5264	7628LW	ML5132	8432CH	ML5245	9272DM	ML5617
5399SL	ML5345	6553VE	ML5807	7628LW	ML5185	8432DD	ML5531	9274NT	ML5269
5414ZW	ML5740	6556YE	ML5784	7629LR	ML5191	8451RV	ML5309	9278HU	ML5451
5424QZ	ML5728	6559YQ	ML5784	7629LR	ML5265	8453BV	ML5407	9283HM	ML5590
5427ZB	ML5737	6566PH	ML5623	7631LY	ML5275	8453CR	ML5247	9288TU	ML5728
5435DM	ML5317	6576TM	ML5374	7638NI	ML5481	8455LZ	ML5489	9338XA	ML5341
5435ZF	ML5739	6583WJ	ML5699	7656WY	ML5359	8456LU	ML5643	9338XA	ML5773
5449ZG	ML5745	6584WE	ML5699	7656WY	ML5361	8467UA	ML5800	9339XW	ML5345
5537SQ	ML5703	6597DF	ML5553	7691RP	ML5469	8468UW	ML5811	9341XC	ML5119
5538SL	ML5702	6604PT	ML5475	7724AL	ML5546	8478CH	ML5118	9342BE	ML5495
5561UU	ML5742	6615PI	ML5826	7734WM	ML5774	8478UQ	ML5808	9344BV	ML5557
5563IT	ML5506	6624PH	ML5826	7739HU	ML5327	8481CJ	ML5249	9345BQ	ML5557
5593MY	ML5124	6642PF	ML5340	7744HM	ML5315	8482TR	ML5729	9349XQ	ML5817
5674MY	ML5331	6648HH	ML5228	7762HK	ML5319	8487UP	ML5799	9351XX	ML5723
5705XK	ML5223	6649LN	ML5353	7764HA	ML5180	8498UE	ML5798	9354BP	ML5586
5705XK	ML5234	6707DS	ML5375	7795ML	ML5223	8498UE	ML5799	9365BE	ML5595
5724ZW	ML5416	6707DS	ML5402	7815BP	ML5398	8512CM	ML5176	9371BS	ML5676
5725ZR	ML5786	6707DS	ML5636	7818TJ	ML5692	8514CC	ML5126	9372HQ	ML5643
5768ZF	ML5685	6714DA	ML5434	7819BW	ML5041	8516CT	ML5290	9427NR	ML5251
5783VH	ML5786	6736AR	ML5347	7824VP	ML5805	8518CJ	ML5431	9428NM	ML5250
5796HP	ML5521	6740AO	ML5348	7825VK	ML5722	8523CB	ML5332	9429IA	ML5217
5798HF	ML5521	6787DY	ML5400	7856RD	ML5355	8534TD	ML5224	9434HX	ML5520
5806SS	ML5828	6789DO	ML5401	7857RZ	ML5334	8534TD	ML5415	9455ES	ML5445
5821PQ	ML5467	6806LL	ML5234	7858RU	ML5356	8538BB	ML5016	9466IS	ML5217
5904QC	ML5382	6843RF	ML5773	7861DY	ML5145	8539UB	ML5804	9468II	ML5185
5904QC	ML5660	6857LD	ML5217	7865TV	ML5826	8541UI	ML5803	9494KC	ML5674
5905QY	ML5823	6858GS	ML5076	7868TG	ML5475	8542CV	ML5333	9517HN	ML5328
5913QB	ML5814	6886YT	ML5726	7875GN	ML5312	8551UC	ML5808	9517HN	ML5621
6007QP	ML5641	6907AQ	ML5123	7891HR	ML5583	8613YU	ML5827	9568UH	ML5745
6024MH	ML5484	6914LI	ML5148	7893HH	ML5326	8637YP	ML5807	9572UE	ML5745
6052CM	ML5079	6927GH	ML5292	7901GO	ML5068	8642FC	ML5236	9582RK	ML5120
6054BG	ML5049	6927TJ	ML5817	7906GQ	ML5271	8704YO	ML5777	9588FB	ML5103
6061CL	ML5540	6936AD	ML5312	7945HU	ML5457	8711TQ	ML5779	9589NS	ML5481
6062SX	ML5379	6952TQ	ML5689	7958RN	ML5212	8715YD	ML5777	9605KK	ML5325
6108DB	ML5494	7017TQ	ML5280	7959RI	ML5340	8722BX	ML5594	9618PX	ML5699
6124QL	ML5687	7017TQ	ML5281	7961RP	ML5469	8771TH	ML5764	9632TZ	ML5737
6124QL	ML5730	7021TN	ML5038	7969MW	ML5175	8884HA	ML5450	9639BI	ML5244
6181SJ	ML5793	7022TI	ML5280	7998TI	ML5695	8899NR	ML5225	9639UN	ML5813
6241QH	ML5186	7022TI	ML5281	8047NO	ML5386	8906CY	ML5840	9643XZ	ML5414
6241QH	ML5187	7041MC	ML5787	8083GL	ML5471	8926CM	ML5278	9653HC	ML5399
6252QX	ML5673	7042MY	ML5787	8113HP	ML5149	8944BO	ML5407	9668DO	ML5354
6253QS	ML5543	7043MT	ML5787	8123DZ	ML5323	8945NP	ML5266	9669ZC	ML5689
6266QY	ML5552	7075HL	ML5267	8127KE	ML5437	8962NS	ML5679	9673HR	ML5526
6304NV	ML5330	7098VJ	ML5826	8139HA	ML5365	8982NG	ML5343	9677NA	ML5414
6324LR	ML5224	7167YN	ML5785	8159DE	ML5679	8985BM	ML5835	9686IT	ML5470
6325MI	ML5544	7168YI	ML5785	8166CR	ML5311	8986IG	ML5435	9714UQ	ML5777
6341NM	ML5068	7187VN	ML5475	8203KC	ML5216	8986NN	ML5262	9716UG	ML5777
6345QHVI	ML5817	7189MM	ML5231	8205TK	ML5763	8986TQ	ML5800	9759IP	ML5284
6362LD	ML5128	7189MM	ML5232	8218TQ	ML5763	9005XA	ML5810	9762HV	ML5329
6364LU	ML5086	7189MM	ML5233	8235LY	ML5536	9006XW	ML5810	9767FE	ML5686
6371SB	ML5782	7209HT	ML5303	8242LG	ML5536	9046BF	ML5243	9786CJ	ML5094
6371SB	ML5824	7234AA	ML5585	8254BD	ML5023	9093DJ	ML5608	9789CV	ML5256
6389PV	ML5491	7266HZ	ML5140	8306BQ	ML5418	9105EP	ML5444	9829NG	ML5213
6391PB	ML5181	7282MN	ML5240	8310BN	ML5143	9106RM	ML5804	9832NI	ML5163
6402QM	ML5526	7303DE	ML5016	8311BI	ML5147	9153KZ	ML5811	9842NC	ML5263
6415VW	ML5723	7303DE	ML5039	8312BD	ML5388	9168MN	ML5219	9857CP	ML5156
6456QQ	ML5224	7373RO	ML5699	8322RO	ML5205	9169MI	ML5220	9903TR	ML5716
6459QB	ML5467	7374AL	ML5408	8333BN	ML5566	9171HI	ML5423	9914VW	ML5809
6467HO	ML5419	7377TN	ML5709	8337BU	ML5390	9171HI	ML5433	9968G	ML5266
6467QF	ML5169	7378RQ	ML5699	8337BU	ML5395	9171MP	ML5221	9968GI	ML5266
6471QC	ML5558	7378TI	ML5706	8339BK	ML5528	9213WV	ML5773	9991IR	ML5558
6471QC	ML5637	7385RZ	ML5699	8339BK	ML5834	9219XO	ML5729		
6472QY	ML5558	7388RK	ML5699	8342BM	ML5408	9228UZ	ML5827		
6473QT	ML5349	7441FC	ML5228	8345BY	ML5527	9231BW	ML5362		
6473QT	ML5375	7441FC	ML5229	8345BY	ML5585	9234HK	ML5236		
6473QT	ML5402	7443NO	ML5063	8345BY	ML5586	9234HK	ML5260		
6474QO	ML5397	7456RE	ML5729	8355KJ	ML5442	9247ZZ	ML5427		
6479HZ	ML5622	7463NC	ML5182	8358KV	ML5392	9249HG	ML5436		
6482HA	ML5078	7469HX	ML5424	8363KN	ML5335	9254KN	ML5284		
6492TA	ML5727	7509HZ	ML5093	8404DL	ML5593	9262QU	ML5289		

MONROE® MAX-LIFT CROSS REFERENCE

LESJÖFORS

LESJÖFORS	MONROE®	LESJÖFORS	MONROE®	LESJÖFORS	MONROE®	LESJÖFORS	MONROE®	LESJÖFORS	MONROE®
8000701	ML5608	8069701	ML5846	8104226	ML5234	8115625	ML5455	8126143	ML5538
8000702	ML5392	8069702	ML5676	8104227	ML5227	8115626	ML5149	8126144	ML5387
8000703	ML5414	8069704	ML5803	8104229	ML5749	8115627	ML5203	8126145	ML5775
8000704	ML5696	8072900	ML5472	8104230	ML5744	8115628	ML5204	8126148	ML5784
8000705	ML5697	8072901	ML5473	8104231	ML5746	8115629	ML5435	8126150	ML5785
8004200	ML5593	8075700	ML5359	8104232	ML5745	8115630	ML5151	8126151	ML5779
8004201	ML5333	8077601	ML5556	8104233	ML5747	8115631	ML5536	8126152	ML5779
8004206	ML5420	8077800	ML5636	8104234	ML5223	8115632	ML5391	8127500	ML5463
8004209	ML5679	8077801	ML5556	8104237	ML5753	8115633	ML5453	8127501	ML5463
8004210	ML5261	8077802	ML5349	8104247	ML5774	8115634	ML5344	8127501	ML5464
8004210	ML5284	8077803	ML5350	8105800	ML5017	8115637	ML5668	8127503	ML5200
8004211	ML5679	8077804	ML5638	8108401	ML5450	8115638	ML5824	8127503	ML5201
8004212	ML5678	8077805	ML5790	8108402	ML5170	8115639	ML5782	8127504	ML5285
8004214	ML5266	8082900	ML5195	8108403	ML5444	8115642	ML5783	8127505	ML5285
8004215	ML5276	8082901	ML5342	8108404	ML5445	8115645	ML5755	8127505	ML5286
8004216	ML5386	8085700	ML5768	8108405	ML5521	8115647	ML5841	8127506	ML5285
8004217	ML5269	8094602	ML5085	8108406	ML5521	8115648	ML5776	8127506	ML5286
8004218	ML5737	8095000	ML5266	8108409	ML5436	8115649	ML5776	8127507	ML5286
8004220	ML5741	8095001	ML5393	8108410	ML5235	8115652	ML5687	8127508	ML5171
8004222	ML5740	8095003	ML5287	8108410	ML5237	8115653	ML5756	8127509	ML5172
8004225	ML5739	8095005	ML5735	8108410	ML5451	8117700	ML5087	8127510	ML5109
8008400	ML5596	8095006	ML5832	8108411	ML5163	8117701	ML5098	8127510	ML5173
8008401	ML5421	8095007	ML5736	8108412	ML5213	8117702	ML5096	8127511	ML5161
8008402	ML5599	8095010	ML5264	8108414	ML5523	8117703	ML5794	8127511	ML5174
8008403	ML5522	8095011	ML5829	8108416	ML5520	8117706	ML5446	8127512	ML5252
8008404	ML5566	8095012	ML5357	8108416	ML5590	8117706	ML5513	8127513	ML5109
8008404	ML5600	8095014	ML5261	8108417	ML5535	8117708	ML5714	8127517	ML5465
8008405	ML5566	8095014	ML5284	8108418	ML5690	8126101	ML5015	8127518	ML5023
8008406	ML5441	8095019	ML5265	8108420	ML5170	8126104	ML5043	8127519	ML5141
8008407	ML5422	8095801	ML5368	8108421	ML5691	8126105	ML5074	8127520	ML5142
8008408	ML5336	8095802	ML5643	8108423	ML5694	8126106	ML5016	8127521	ML5143
8008409	ML5263	8095803	ML5361	8108424	ML5670	8126106	ML5039	8127522	ML5147
8008410	ML5688	8095805	ML5726	8108425	ML5671	8126107	ML5079	8127524	ML5126
8008412	ML5563	8100702	ML5273	8108428	ML5692	8126111	ML5013	8127525	ML5176
8008413	ML5689	8100705	ML5335	8108429	ML5695	8126111	ML5014	8127527	ML5332
8008414	ML5562	8100706	ML5335	8108430	ML5693	8126111	ML5066	8127529	ML5611
8008416	ML5565	8100707	ML5531	8114200	ML5794	8126112	ML5014	8127531	ML5110
8008417	ML5769	8100708	ML5532	8114203	ML5446	8126112	ML5066	8127532	ML5612
8015600	ML5457	8100709	ML5271	8114204	ML5714	8126113	ML5012	8127533	ML5388
8015601	ML5270	8100710	ML5272	8115600	ML5607	8126113	ML5065	8127534	ML5080
8015602	ML5262	8100711	ML5215	8115601	ML5601	8126114	ML5040	8127535	ML5253
8015603	ML5461	8100712	ML5442	8115602	ML5603	8126114	ML5050	8127536	ML5614
8015604	ML5822	8100713	ML5419	8115603	ML5602	8126114	ML5112	8127537	ML5293
8026100	ML5038	8100714	ML5222	8115603	ML5604	8126118	ML5042	8127538	ML5294
8026102	ML5389	8100715	ML5335	8115604	ML5602	8126119	ML5081	8127539	ML5136
8027500	ML5292	8100719	ML5698	8115604	ML5605	8126120	ML5282	8127542	ML5290
8027501	ML5330	8104203	ML5417	8115605	ML5452	8126121	ML5283	8127543	ML5431
8037201	ML5660	8104204	ML5533	8115606	ML5606	8126122	ML5068	8127544	ML5429
8044200	ML5706	8104205	ML5376	8115607	ML5609	8126123	ML5069	8127545	ML5076
8044201	ML5705	8104206	ML5104	8115608	ML5010	8126125	ML5078	8127546	ML5399
8056800	ML5102	8104207	ML5437	8115611	ML5019	8126126	ML5164	8127547	ML5224
8056802	ML5438	8104209	ML5428	8115612	ML5504	8126127	ML5081	8127548	ML5168
8056803	ML5308	8104210	ML5111	8115613	ML5505	8126128	ML5458	8127549	ML5127
8056804	ML5309	8104211	ML5418	8115614	ML5255	8126129	ML5377	8127550	ML5502
8056805	ML5559	8104214	ML5135	8115615	ML5033	8126130	ML5086	8127551	ML5231
8056806	ML5577	8104214	ML5193	8115616	ML5506	8126131	ML5280	8127551	ML5232
8056807	ML5560	8104215	ML5197	8115617	ML5011	8126131	ML5281	8127551	ML5233
8056810	ML5620	8104216	ML5135	8115618	ML5203	8126132	ML5280	8127552	ML5374
8056812	ML5798	8104216	ML5193	8115618	ML5204	8126132	ML5281	8127553	ML5514
8056813	ML5799	8104217	ML5198	8115618	ML5503	8126134	ML5462	8127554	ML5466
8056822	ML5811	8104218	ML5111	8115619	ML5430	8126135	ML5039	8127554	ML5467
8063402	ML5085	8104219	ML5238	8115620	ML5129	8126136	ML5165	8127555	ML5289
8063403	ML5345	8104219	ML5239	8115622	ML5113	8126137	ML5443	8127556	ML5206
8063404	ML5720	8104221	ML5277	8115623	ML5454	8126138	ML5448	8127556	ML5207
8066700	ML5583	8104223	ML5449	8115623	ML5626	8126139	ML5101	8127557	ML5224
8066701	ML5470	8104224	ML5275	8115624	ML5456	8126140	ML5702	8127557	ML5415
8066702	ML5267	8104225	ML5370	8115624	ML5627	8126141	ML5795	8127558	ML5288
8066703	ML5788	8104226	ML5223	8115625	ML5363	8126142	ML5537	8127559	ML5416

CROSS REFERENCE

MONROE® MAX-LIFT CROSS REFERENCE

LESJÖFORS

LESJÖFORS	MONROE®	LESJÖFORS	MONROE®	LESJÖFORS	MONROE®	LESJÖFORS	MONROE®	LESJÖFORS	MONROE®
8127560	ML5664	8156824	ML5719	8163428	ML5398	8169700	ML5595	8177804	ML5498
8127561	ML5786	8156826	ML5800	8163429	ML5032	8169701	ML5594	8177805	ML5499
8127563	ML5771	8156827	ML5801	8163430	ML5258	8172900	ML5021	8177806	ML5494
8127564	ML5770	8156828	ML5802	8163432	ML5082	8172901	ML5630	8177807	ML5496
8127566	ML5797	8158505	ML5434	8163435	ML5166	8172904	ML5310	8177808	ML5495
8127567	ML5797	8158506	ML5410	8163436	ML5138	8172906	ML5093	8177809	ML5557
8127568	ML5704	8158506	ML5478	8163437	ML5424	8172907	ML5320	8177810	ML5497
8127569	ML5772	8158506	ML5622	8163438	ML5515	8172908	ML5331	8177810	ML5498
8127570	ML5295	8158508	ML5412	8163439	ML5515	8172909	ML5254	8177811	ML5402
8135712	ML5214	8158700	ML5406	8163440	ML5369	8172910	ML5279	8177812	ML5375
8135712	ML5405	8158705	ML5175	8163442	ML5137	8172910	ML5544	8177813	ML5558
8135717	ML5787	8159200	ML5578	8163443	ML5120	8172910	ML5545	8177814	ML5637
8135718	ML5122	8159201	ML5354	8163444	ML5088	8172911	ML5310	8177818	ML5766
8135721	ML5567	8159202	ML5278	8163445	ML5089	8172912	ML5256	8182900	ML5063
8135722	ML5371	8159203	ML5587	8163448	ML5366	8172913	ML5631	8182901	ML5140
8135723	ML5396	8159215	ML5353	8163449	ML5365	8172913	ML5632	8182902	ML5124
8135725	ML5192	8159220	ML5757	8163450	ML5341	8172914	ML5383	8182903	ML5022
8135725	ML5508	8159221	ML5757	8163451	ML5773	8172915	ML5131	8182905	ML5261
8135729	ML5836	8159224	ML5662	8163452	ML5516	8172916	ML5526	8182905	ML5284
8137200	ML5157	8159228	ML5661	8163453	ML5721	8172917	ML5241	8182907	ML5259
8137207	ML5296	8162004	ML5524	8163454	ML5669	8172918	ML5313	8182908	ML5181
8137208	ML5816	8162005	ML5525	8163455	ML5817	8172919	ML5314	8182909	ML5639
8137217	ML5759	8162006	ML5317	8163456	ML5119	8172920	ML5228	8182912	ML5778
8137222	ML5760	8162006	ML5324	8163460	ML5827	8172920	ML5229	8182913	ML5225
8137223	ML5762	8162007	ML5588	8163461	ML5807	8172921	ML5158	8182914	ML5100
8137230	ML5379	8162008	ML5423	8163463	ML5346	8172922	ML5130	8182916	ML5767
8137231	ML5379	8162008	ML5433	8163464	ML5722	8172922	ML5150	8185700	ML5044
8144209	ML5711	8162012	ML5409	8163467	ML5805	8172922	ML5152	8185700	ML5048
8144210	ML5709	8162016	ML5580	8163470	ML5723	8172923	ML5094	8185701	ML5057
8144211	ML5708	8162017	ML5581	8166701	ML5133	8172924	ML5553	8185702	ML5061
8144212	ML5708	8162025	ML5579	8166702	ML5020	8172925	ML5128	8185703	ML5217
8144213	ML5712	8162026	ML5579	8166704	ML5628	8172926	ML5189	8185703	ML5218
8144216	ML5707	8162028	ML5781	8166705	ML5364	8172927	ML5440	8185705	ML5175
8144217	ML5823	8162029	ML5700	8166706	ML5148	8172927	ML5474	8185706	ML5681
8148400	ML5617	8162030	ML5321	8166709	ML5202	8172928	ML5190	8185707	ML5665
8148401	ML5139	8162030	ML5322	8166710	ML5326	8172929	ML5212	8185708	ML5665
8148401	ML5598	8162031	ML5582	8166711	ML5426	8172930	ML5518	8185709	ML5667
8148402	ML5159	8162037	ML5413	8166712	ML5067	8172931	ML5519	8185712	ML5682
8155422	ML5684	8162038	ML5360	8166714	ML5625	8172932	ML5551	8186000	ML5640
8155423	ML5683	8162040	ML5672	8166715	ML5311	8172933	ML5826	8188304	ML5820
8155436	ML5765	8162041	ML5701	8166717	ML5180	8172934	ML5475	8188305	ML5819
8155437	ML5763	8162042	ML5809	8166718	ML5148	8172935	ML5552	8188900	ML5589
8155441	ML5764	8162043	ML5809	8166719	ML5319	8172936	ML5725	8188901	ML5589
8156800	ML5186	8162044	ML5809	8166720	ML5146	8172937	ML5182	8188906	ML5091
8156800	ML5187	8162045	ML5809	8166720	ML5316	8172939	ML5372	8188906	ML5092
8156801	ML5307	8163400	ML5390	8166721	ML5134	8172940	ML5828	8188907	ML5091
8156802	ML5674	8163401	ML5346	8166723	ML5432	8172941	ML5812	8188907	ML5092
8156803	ML5328	8163403	ML5395	8166724	ML5454	8172942	ML5789	8192532	ML5592
8156803	ML5329	8163403	ML5077	8166724	ML5626	8172943	ML5724	8192534	ML5121
8156803	ML5621	8163404	ML5156	8166725	ML5456	8172945	ML5440	8192541	ML5486
8156805	ML5468	8163405	ML5125	8166725	ML5627	8172946	ML5548	8192546	ML5485
8156806	ML5560	8163406	ML5367	8166728	ML5323	8172947	ML5230	8192550	ML5641
8156806	ML5674	8163407	ML5585	8166728	ML5323	8172947	ML5230	8192555	ML5777
8156807	ML5530	8163407	ML5527	8166729	ML5469	8172948	ML5153	8192555	ML5821
8156807	ML5577	8163408	ML5527	8166730	ML5160	8172964	ML5550	8192557	ML5647
8156808	ML5716	8163409	ML5242	8166731	ML5425	8175703	ML5508	8192557	ML5699
8156809	ML5543	8163410	ML5054	8166732	ML5358	8175703	ML5634	8192558	ML5699
8156810	ML5717	8163411	ML5144	8166733	ML5183	8175704	ML5338	8192566	ML5666
8156811	ML5718	8163417	ML5243	8166738	ML5343	8175705	ML5384	8194603	ML5244
8156812	ML5718	8163419	ML5244	8166739	ML5730	8175706	ML5384	8194604	ML5528
8156813	ML5808	8163420	ML5835	8166740	ML5728	8175708	ML5362	8194604	ML5834
8156814	ML5808	8163421	ML5528	8166741	ML5727	8175715	ML5478	8194605	ML5407
8156815	ML5806	8163422	ML5407	8166742	ML5729	8175715	ML5622	8194606	ML5077
8156816	ML5806	8163423	ML5407	8166744	ML5731	8175716	ML5649	8194607	ML5156
8156819	ML5680	8163424	ML5408	8166747	ML5732	8177800	ML5613	8194608	ML5367
8156820	ML5818	8163424	ML5408	8166748	ML5734	8177801	ML5635	8194609	ML5366
8156821	ML5673	8163425	ML5408	8166751	ML5340	8177802	ML5400		
		8163426	ML5210	8166753	ML5733	8177803	ML5401		
		8163427	ML5103	8168700	ML5595	8177804	ML5497		

MONROE® MAX-LIFT CROSS REFERENCE

LESJÖFORS

LESJÖFORS	MONROE®	LESJÖFORS	MONROE®	LESJÖFORS	MONROE®	LESJÖFORS	MONROE®	LESJÖFORS	MONROE®
8194610	ML5408	8194636	ML5138	8195017	ML5178	8195039	ML5132	8195070	ML5576
8194612	ML5032	8194637	ML5424	8195020	ML5677	8195040	ML5261	8195807	ML5642
8194613	ML5258	8194638	ML5515	8195021	ML5677	8195040	ML5284	8195808	ML5571
8194614	ML5054	8194639	ML5515	8195022	ML5106	8195041	ML5199	8195809	ML5509
8194615	ML5144	8194640	ML5369	8195023	ML5246	8195045	ML5742	8195809	ML5571
8194619	ML5585	8194642	ML5137	8195024	ML5245	8195046	ML5575	8195810	ML5509
8194620	ML5527	8194643	ML5120	8195025	ML5118	8195047	ML5743	8195813	ML5312
8194621	ML5103	8195000	ML5572	8195026	ML5249	8195048	ML5194	8195815	ML5840
8194622	ML5082	8195001	ML5573	8195026	ML5250	8195048	ML5196	8195816	ML5529
8194623	ML5398	8195002	ML5073	8195027	ML5226	8195050	ML5750	8195817	ML5347
8194624	ML5390	8195003	ML5574	8195029	ML5106	8195051	ML5796	8195818	ML5348
8194628	ML5407	8195005	ML5049	8195031	ML5145	8195052	ML5675	8195821	ML5184
8194629	ML5125	8195006	ML5191	8195032	ML5675	8195053	ML5792	8195824	ML5489
8194630	ML5408	8195011	ML5123	8195033	ML5132	8195054	ML5754	8195825	ML5685
8194631	ML5242	8195012	ML5123	8195033	ML5185	8195055	ML5751	8195826	ML5481
8194632	ML5210	8195014	ML5644	8195035	ML5135	8195056	ML5831	8195827	ML5427
8194633	ML5243	8195015	ML5644	8195035	ML5193	8195057	ML5793	8195833	ML5487
8194635	ML5166	8195016	ML5177	8195037	ML5325	8195059	ML5830	81592202	ML5757

KILEN

KILEN	MONROE®	KILEN	MONROE®	KILEN	MONROE®	KILEN	MONROE®	KILEN	MONROE®
310001	ML5608	338006	ML5577	412010	ML5111	416006	ML5609	421015	ML5081
310003	ML5414	338007	ML5560	412011	ML5418	416010	ML5019	421021	ML5078
310004	ML5696	338010	ML5620	412014	ML5135	416011	ML5504	421026	ML5164
310005	ML5697	338012	ML5798	412014	ML5193	416017	ML5607	421027	ML5081
312000	ML5593	338013	ML5799	412015	ML5197	416018	ML5204	421028	ML5458
312001	ML5333	338022	ML5811	412019	ML5239	416019	ML5430	421029	ML5377
312005	ML5420	344001	ML5085	412021	ML5277	416023	ML5454	421030	ML5086
312008	ML5679	344003	ML5345	412023	ML5449	416023	ML5626	421031	ML5280
312009	ML5261	344004	ML5720	412024	ML5275	416024	ML5456	421032	ML5281
312009	ML5284	346000	ML5583	412026	ML5234	416024	ML5627	421035	ML5039
312014	ML5266	346001	ML5470	412027	ML5227	416026	ML5149	421036	ML5165
312015	ML5276	346002	ML5267	412029	ML5749	416027	ML5203	421037	ML5443
312016	ML5386	346003	ML5788	412030	ML5744	416028	ML5204	421038	ML5448
312017	ML5269	349001	ML5846	412031	ML5746	416030	ML5151	421039	ML5101
312018	ML5737	349002	ML5676	412032	ML5745	416031	ML5536	421040	ML5702
312020	ML5741	349004	ML5803	412033	ML5747	416032	ML5391	421041	ML5795
312022	ML5740	350000	ML5472	412034	ML5223	416033	ML5453	421042	ML5537
312025	ML5739	350001	ML5473	412037	ML5753	416034	ML5344	421043	ML5538
314000	ML5596	352000	ML5359	412047	ML5774	416037	ML5668	421044	ML5387
314001	ML5421	354000	ML5636	414002	ML5450	416038	ML5824	421045	ML5775
314002	ML5599	354001	ML5556	414003	ML5170	416042	ML5783	421048	ML5784
314003	ML5522	354005	ML5790	414004	ML5444	416045	ML5755	421050	ML5785
314004	ML5566	356000	ML5195	414005	ML5445	416047	ML5841	421051	ML5779
314004	ML5600	356001	ML5342	414006	ML5521	416048	ML5776	421052	ML5779
314005	ML5566	358000	ML5768	414007	ML5521	416049	ML5776	422001	ML5463
314007	ML5422	365002	ML5085	414010	ML5436	416052	ML5687	422001	ML5464
314008	ML5336	366000	ML5266	414011	ML5237	416053	ML5756	422003	ML5285
314009	ML5263	366001	ML5393	414012	ML5213	417000	ML5087	422004	ML5285
314010	ML5688	366010	ML5264	414013	ML5163	417001	ML5098	422006	ML5286
314012	ML5563	366012	ML5357	414014	ML5523	417002	ML5096	422007	ML5171
314013	ML5689	366014	ML5261	414016	ML5590	417003	ML5794	422009	ML5109
314014	ML5562	366014	ML5284	414017	ML5535	417006	ML5446	422009	ML5173
314016	ML5565	366019	ML5265	414018	ML5690	417006	ML5513	422010	ML5161
314017	ML5769	368002	ML5643	414020	ML5170	417008	ML5714	422010	ML5174
316000	ML5457	368003	ML5361	414021	ML5691	421001	ML5015	422011	ML5252
316001	ML5270	368005	ML5726	414023	ML5694	421003	ML5043	422012	ML5109
316002	ML5262	410007	ML5531	414024	ML5670	421004	ML5074	422016	ML5465
316003	ML5461	410008	ML5532	414025	ML5671	421005	ML5016	422017	ML5023
321000	ML5038	410012	ML5442	414028	ML5692	421009	ML5014	422018	ML5141
321002	ML5389	410013	ML5419	414029	ML5695	421009	ML5066	422019	ML5142
322000	ML5292	410014	ML5222	414030	ML5693	421010	ML5014	422020	ML5143
322001	ML5330	410015	ML5335	415000	ML5794	421010	ML5066	422021	ML5147
326001	ML5660	410019	ML5698	415003	ML5446	421011	ML5012	422023	ML5126
331000	ML5706	412003	ML5417	415004	ML5714	421011	ML5065	422024	ML5176
338002	ML5438	412004	ML5533	416000	ML5601	421012	ML5040	422026	ML5332
338003	ML5308	412005	ML5376	416002	ML5602	421012	ML5050	422027	ML5611
338004	ML5309	412006	ML5104	416003	ML5602	421012	ML5112	422029	ML5612
338005	ML5559	412007	ML5437	416005	ML5606	421014	ML5042	422030	ML5388

CROSS REFERENCE

MONROE® MAX-LIFT CROSS REFERENCE

KILEN

KILEN	MONROE®	KILEN	MONROE®	KILEN	MONROE®	KILEN	MONROE®	KILEN	MONROE®
422031	ML5080	438015	ML5806	444060	ML5827	452003	ML5508	465031	ML5242
422032	ML5253	438016	ML5806	444061	ML5807	452003	ML5634	465032	ML5210
422035	ML5294	438019	ML5680	444063	ML5346	452005	ML5384	465033	ML5243
422036	ML5136	438020	ML5818	444064	ML5722	452006	ML5384	465035	ML5166
422039	ML5290	438021	ML5673	444067	ML5805	452015	ML5478	465036	ML5138
422040	ML5431	438024	ML5719	444070	ML5723	452015	ML5622	465037	ML5424
422041	ML5429	438026	ML5800	446004	ML5628	454000	ML5613	465038	ML5515
422042	ML5076	438027	ML5801	446005	ML5364	454001	ML5635	465039	ML5515
422043	ML5399	438028	ML5802	446006	ML5148	454002	ML5400	465040	ML5369
422044	ML5224	439000	ML5406	446009	ML5202	454003	ML5401	465042	ML5137
422045	ML5168	440001	ML5354	446010	ML5326	454004	ML5497	465043	ML5120
422046	ML5127	440002	ML5278	446011	ML5426	454005	ML5499	466000	ML5572
422047	ML5502	440003	ML5587	446012	ML5067	454006	ML5494	466001	ML5573
422049	ML5374	440015	ML5353	446017	ML5180	454007	ML5496	466002	ML5073
422053	ML5514	440020	ML5757	446019	ML5319	454008	ML5495	466005	ML5049
422054	ML5467	440021	ML5757	446020	ML5316	454009	ML5557	466006	ML5191
422055	ML5289	440024	ML5662	446021	ML5134	454010	ML5498	466011	ML5123
422056	ML5206	440028	ML5661	446024	ML5454	454015	ML5766	466012	ML5123
422056	ML5207	442004	ML5524	446024	ML5626	456001	ML5140	466014	ML5644
422057	ML5224	442006	ML5324	446025	ML5456	456003	ML5022	466016	ML5177
422057	ML5415	442007	ML5588	446025	ML5627	456005	ML5261	466017	ML5178
422058	ML5288	442008	ML5433	446028	ML5323	456005	ML5284	466021	ML5106
422059	ML5416	442012	ML5409	446029	ML5469	456007	ML5259	466022	ML5246
422060	ML5664	442017	ML5581	446030	ML5160	456008	ML5181	466023	ML5245
422061	ML5786	442025	ML5579	446031	ML5425	456012	ML5778	466024	ML5118
422063	ML5771	442028	ML5781	446032	ML5358	456013	ML5225	466025	ML5250
422064	ML5770	442030	ML5322	446033	ML5183	456014	ML5100	466026	ML5226
422067	ML5797	442037	ML5413	446038	ML5343	456016	ML5767	466028	ML5106
422068	ML5704	442038	ML5360	446039	ML5730	458002	ML5061	466030	ML5145
422069	ML5772	442040	ML5672	446040	ML5728	458003	ML5218	466031	ML5675
422070	ML5295	442041	ML5701	446041	ML5727	458005	ML5175	466033	ML5132
424012	ML5214	442043	ML5809	446042	ML5729	458006	ML5681	466035	ML5135
424017	ML5787	444000	ML5390	446044	ML5731	458007	ML5665	466035	ML5193
424018	ML5122	444001	ML5346	446047	ML5732	458008	ML5665	466037	ML5325
424021	ML5567	444003	ML5077	446048	ML5734	458009	ML5667	466039	ML5132
424022	ML5371	444004	ML5156	446051	ML5340	458012	ML5682	466040	ML5261
424023	ML5396	444005	ML5125	446053	ML5733	460004	ML5820	466040	ML5284
424025	ML5192	444006	ML5367	449000	ML5595	460005	ML5819	466041	ML5199
424025	ML5508	444007	ML5585	449001	ML5594	462000	ML5589	466046	ML5575
424029	ML5836	444008	ML5527	450008	ML5331	462001	ML5589	466048	ML5194
426000	ML5157	444009	ML5242	450013	ML5632	462006	ML5091	466048	ML5196
426007	ML5296	444010	ML5054	450014	ML5383	462007	ML5092	466052	ML5675
426008	ML5816	444011	ML5144	450015	ML5131	464032	ML5592	466070	ML5576
426017	ML5759	444017	ML5243	450017	ML5241	464034	ML5121	468005	ML5642
426022	ML5760	444019	ML5244	450018	ML5313	464041	ML5486	468007	ML5509
426023	ML5762	444021	ML5528	450019	ML5314	464046	ML5485	468007	ML5571
426030	ML5379	444021	ML5834	450020	ML5229	464050	ML5641	468011	ML5312
426031	ML5379	444022	ML5407	450021	ML5158	464055	ML5777	468013	ML5840
431009	ML5711	444023	ML5407	450022	ML5130	464056	ML5777	468014	ML5529
431010	ML5709	444024	ML5408	450023	ML5094	464057	ML5647	468015	ML5347
431011	ML5708	444025	ML5408	450024	ML5553	464057	ML5699	468016	ML5348
431012	ML5708	444026	ML5210	450025	ML5128	464066	ML5666	468021	ML5184
431013	ML5712	444027	ML5103	450026	ML5189	465003	ML5244	468024	ML5489
431017	ML5823	444028	ML5398	450027	ML5474	465004	ML5528	468025	ML5685
434000	ML5617	444029	ML5032	450028	ML5190	465004	ML5834	468027	ML5427
434002	ML5159	444030	ML5258	450029	ML5212	465005	ML5407	468033	ML5487
436037	ML5763	444032	ML5082	450030	ML5518	465006	ML5077		
436041	ML5764	444035	ML5166	450031	ML5519	465007	ML5156		
437000	ML5434	444036	ML5138	450032	ML5551	465008	ML5367		
437001	ML5410	444037	ML5424	450033	ML5826	465009	ML5366		
437001	ML5478	444038	ML5515	450034	ML5475	465010	ML5408		
437001	ML5622	444039	ML5515	450035	ML5552	465012	ML5032		
437003	ML5412	444040	ML5369	450036	ML5725	465013	ML5258		
438000	ML5187	444042	ML5137	450037	ML5182	465014	ML5054		
438001	ML5307	444043	ML5120	450039	ML5372	465015	ML5144		
438002	ML5674	444044	ML5088	450040	ML5828	465019	ML5585		
438003	ML5329	444045	ML5089	450041	ML5812	465020	ML5527		
438005	ML5468	444048	ML5366	450042	ML5789	465021	ML5103		
438008	ML5716	444050	ML5341	450043	ML5724	465022	ML5082		
438009	ML5543	444051	ML5773	450045	ML5440	465023	ML5398		
438011	ML5718	444053	ML5721	450046	ML5548	465024	ML5390		
438012	ML5718	444054	ML5669	450047	ML5230	465028	ML5407		
438013	ML5808	444055	ML5817	450048	ML5153	465029	ML5125		
438014	ML5808	444056	ML5119	450064	ML5550	465030	ML5408		

MONROE® MAX-LIFT CROSS REFERENCE

LIP (QH)

LIP	MONROE®	LIP	MONROE®	LIP	MONROE®	LIP	MONROE®	LIP	MONROE®
128002	ML5011	128182	ML5720	128349	ML5318	128432	ML5214	128563	ML5218
128003	ML5606	128183	ML5064	128350	ML5524	128433	ML5109	128564	ML5219
128007	ML5015	128185	ML5148	128351	ML5525	128433	ML5173	128565	ML5175
128022	ML5019	128190	ML5266	128352	ML5131	128434	ML5320	128566	ML5165
128024	ML5010	128191	ML5135	128353	ML5145	128435	ML5104	128567	ML5160
128029	ML5042	128223	ML5020	128354	ML5506	128435	ML5376	128568	ML5439
128052	ML5465	128244	ML5311	128356	ML5049	128436	ML5104	128569	ML5222
128053	ML5023	128245	ML5426	128358	ML5244	128436	ML5376	128570	ML5410
128056	ML5601	128249	ML5177	128362	ML5408	128438	ML5533	128571	ML5478
128062	ML5034	128252	ML5642	128363	ML5258	128439	ML5185	128571	ML5622
128066	ML5022	128254	ML5312	128363	ML5721	128440	ML5170	128573	ML5462
128069	ML5009	128255	ML5400	128365	ML5111	128441	ML5384	128575	ML5216
128070	ML5021	128256	ML5401	128366	ML5428	128442	ML5417	128576	ML5215
128071	ML5625	128257	ML5452	128367	ML5144	128444	ML5323	128577	ML5392
128073	ML5252	128261	ML5617	128368	ML5242	128445	ML5132	128580	ML5619
128074	ML5501	128262	ML5618	128369	ML5054	128446	ML5291	128581	ML5391
128075	ML5644	128264	ML5039	128371	ML5315	128447	ML5612	128582	ML5270
128076	ML5585	128272	ML5080	128372	ML5290	128448	ML5110	128583	ML5292
128078	ML5600	128273	ML5253	128373	ML5431	128449	ML5128	128584	ML5374
128083	ML5492	128282	ML5539	128374	ML5176	128450	ML5539	128585	ML5231
128086	ML5603	128283	ML5293	128375	ML5332	128451	ML5493	128586	ML5502
128087	ML5611	128284	ML5294	128376	ML5081	128457	ML5246	128588	ML5134
128088	ML5639	128287	ML5041	128377	ML5103	128458	ML5245	128589	ML5579
128089	ML5463	128288	ML5208	128379	ML5554	128459	ML5247	128591	ML5087
128090	ML5464	128289	ML5286	128380	ML5303	128460	ML5105	128592	ML5507
128092	ML5038	128290	ML5200	128381	ML5505	128498	ML5489	128593	ML5446
128096	ML5632	128291	ML5201	128382	ML5226	128499	ML5450	128593	ML5513
128097	ML5630	128293	ML5306	128383	ML5197	128500	ML5166	128594	ML5098
128098	ML5602	128294	ML5243	128384	ML5210	128501	ML5307	128595	ML5157
128099	ML5605	128295	ML5528	128385	ML5316	128502	ML5138	128596	ML5569
128106	ML5147	128295	ML5834	128387	ML5078	128503	ML5217	128597	ML5296
128108	ML5607	128296	ML5407	128388	ML5136	128504	ML5436	128598	ML5515
128113	ML5016	128297	ML5125	128389	ML5139	128505	ML5195	128599	ML5494
128114	ML5017	128297	ML5156	128389	ML5598	128506	ML5086	128600	ML5257
128118	ML5202	128298	ML5390	128390	ML5159	128507	ML5188	128601	ML5085
128119	ML5631	128299	ML5527	128391	ML5150	128510	ML5146	128602	ML5167
128124	ML5574	128300	ML5073	128391	ML5262	128511	ML5241	128603	ML5190
128131	ML5310	128301	ML5123	128392	ML5082	128512	ML5135	128604	ML5476
128132	ML5093	128302	ML5177	128393	ML5424	128512	ML5193	128605	ML5477
128133	ML5141	128302	ML5178	128394	ML5284	128513	ML5224	128606	ML5229
128134	ML5142	128304	ML5313	128395	ML5100	128514	ML5168	128607	ML5474
128135	ML5033	128305	ML5314	128396	ML5154	128515	ML5466	128608	ML5158
128140	ML5040	128319	ML5429	128397	ML5184	128516	ML5137	128610	ML5155
128140	ML5050	128320	ML5076	128398	ML5321	128517	ML5418	128611	ML5182
128140	ML5112	128321	ML5180	128399	ML5322	128518	ML5162	128612	ML5440
128141	ML5014	128323	ML5149	128401	ML5432	128519	ML5164	128614	ML5152
128141	ML5066	128324	ML5283	128402	ML5319	128520	ML5186	128615	ML5130
128146	ML5255	128324	ML5304	128405	ML5324	128521	ML5234	128616	ML5153
128147	ML5094	128324	ML5454	128406	ML5433	128522	ML5238	128617	ML5189
128148	ML5124	128324	ML5626	128407	ML5580	128524	ML5377	128618	ML5277
128149	ML5140	128325	ML5305	128412	ML5540	128525	ML5120	128619	ML5593
128150	ML5063	128325	ML5456	128413	ML5335	128526	ML5437	128620	ML5480
128152	ML5553	128325	ML5627	128414	ML5272	128527	ML5534	128621	ML5261
128153	ML5331	128327	ML5126	128415	ML5271	128528	ML5223	128622	ML5333
128155	ML5106	128328	ML5679	128416	ML5531	128530	ML5254	128623	ML5677
128156	ML5065	128331	ML5835	128417	ML5532	128531	ML5181	128624	ML5573
128157	ML5032	128335	ML5430	128418	ML5274	128532	ML5388	128625	ML5191
128158	ML5171	128336	ML5143	128419	ML5273	128533	ML5572	128626	ML5420
128159	ML5172	128337	ML5370	128420	ML5434	128534	ML5325	128628	ML5240
128160	ML5161	128338	ML5203	128421	ML5192	128536	ML5411	128630	ML5509
128160	ML5174	128339	ML5204	128422	ML5508	128537	ML5438	128630	ML5571
128161	ML5077	128340	ML5069	128422	ML5634	128538	ML5113	128632	ML5326
128162	ML5133	128341	ML5068	128423	ML5129	128539	ML5481	128633	ML5457
128170	ML5582	128342	ML5544	128424	ML5435	128542	ML5542	128636	ML5067
128178	ML5079	128343	ML5545	128426	ML5386	128543	ML5403	128637	ML5256
128178	ML5814	128344	ML5279	128428	ML5628	128551	ML5301	128638	ML5633
128179	ML5043	128345	ML5383	128430	ML5228	128561	ML5302	128639	ML5549
128180	ML5282	128348	ML5317	128431	ML5614	128562	ML5220	128640	ML5327

MONROE® MAX-LIFT CROSS REFERENCE

LIP (QH)

LIP	MONROE®	LIP	MONROE®	LIP	MONROE®	LIP	MONROE®	LIP	MONROE®
128642	ML5555	128732	ML5468	128815	ML5295	140084	ML5629	140321	ML5519
128643	ML5337	128733	ML5349	128826	ML5543	140114	ML5517	140322	ML5551
128644	ML5338	128734	ML5636	128831	ML5308	140115	ML5471	140324	ML5514
128645	ML5635	128735	ML5351	128833	ML5309	140116	ML5448	140325	ML5575
128654	ML5399	128736	ML5483	128843	ML5588	140121	ML5365	140326	ML5576
128655	ML5330	128737	ML5484	128850	ML5359	140122	ML5366	140326	ML5833
128658	ML5336	128738	ML5482	128851	ML5496	140123	ML5230	140327	ML5584
128659	ML5260	128740	ML5096	128852	ML5495	140124	ML5526	140329	ML5816
128661	ML5840	128741	ML5447	128853	ML5557	140125	ML5686	140334	ML5615
128662	ML5535	128744	ML5297	128854	ML5497	140126	ML5548	840021	ML5556
128663	ML5441	128745	ML5381	128855	ML5498	140127	ML5250	840024	ML5422
128664	ML5263	128746	ML5382	128856	ML5499	140128	ML5675	840025	ML5596
128665	ML5213	128747	ML5570	128859	ML5044	140130	ML5511	840046	ML5504
128667	ML5280	128748	ML5378	128859	ML5048	140131	ML5510	840074	ML5609
128668	ML5281	128749	ML5379	128860	ML5589	140135	ML5118	840075	ML5503
128669	ML5458	128750	ML5380	128862	ML5509	140136	ML5249	840080	ML5546
128670	ML5419	128751	ML5616	128865	ML5645	140137	ML5251	840084	ML5629
128671	ML5414	128752	ML5352	128880	ML5490	140138	ML5248	840116	ML5448
128672	ML5467	128754	ML5413	128881	ML5427	140144	ML5367	840121	ML5365
128673	ML5206	128755	ML5423	128882	ML5361	140145	ML5547	840122	ML5366
128674	ML5169	128756	ML5581	128883	ML5368	140154	ML5237	840123	ML5230
128675	ML5289	128757	ML5353	128884	ML5373	140155	ML5235	840124	ML5526
128675	ML5782	128758	ML5354	128885	ML5470	140156	ML5163	840125	ML5686
128676	ML5151	128759	ML5355	128886	ML5500	140157	ML5444	840126	ML5548
128677	ML5211	128759	ML5729	128887	ML5488	140158	ML5521	840127	ML5250
128678	ML5259	128760	ML5334	128888	ML5387	140165	ML5102	840128	ML5675
128679	ML5341	128761	ML5356	128889	ML5541	140169	ML5674	840130	ML5511
128680	ML5773	128762	ML5357	128890	ML5727	140170	ML5089	840131	ML5510
128681	ML5196	128763	ML5583	128890	ML5743	140171	ML5088	840135	ML5118
128682	ML5225	128764	ML5268	128891	ML5728	140175	ML5685	840136	ML5249
128683	ML5198	128765	ML5267	128892	ML5372	140176	ML5529	840137	ML5251
128684	ML5068	128767	ML5558	128893	ML5812	140177	ML5127	840138	ML5248
128685	ML5207	128768	ML5375	128895	ML5789	140180	ML5421	840144	ML5367
128686	ML5389	128769	ML5397	128896	ML5826	140181	ML5522	840145	ML5547
128687	ML5209	128770	ML5442	128897	ML5475	140183	ML5566	840154	ML5237
128689	ML5183	128771	ML5404	128900	ML5472	140184	ML5445	840155	ML5235
128693	ML5221	128772	ML5702	128901	ML5473	140185	ML5520	840156	ML5163
128694	ML5340	128773	ML5101	128902	ML5744	140186	ML5590	840157	ML5444
128695	ML5205	128774	ML5443	128903	ML5736	140187	ML5523	840158	ML5521
128696	ML5586	128775	ML5538	128904	ML5832	140190	ML5451	840165	ML5102
128697	ML5608	128776	ML5122	128905	ML5735	140191	ML5236	840169	ML5674
128699	ML5227	128777	ML5396	128910	ML5669	140193	ML5179	840176	ML5529
128699	ML5592	128778	ML5371	128911	ML5817	140194	ML5425	840177	ML5127
128701	ML5269	128779	ML5406	128913	ML5559	140197	ML5599	840193	ML5179
128702	ML5342	128782	ML5360	128914	ML5530	140224	ML5842	840194	ML5425
128703	ML5265	128783	ML5119	128917	ML5711	140225	ML5843	840197	ML5599
128704	ML5061	128784	ML5412	128918	ML5683	140228	ML5848	840238	ML5640
128705	ML5491	128785	ML5479	128919	ML5684	140229	ML5847	840239	ML5329
128706	ML5469	128785	ML5623	128920	ML5759	140238	ML5640	840240	ML5328
128707	ML5343	128786	ML5394	128922	ML5765	140239	ML5329	840240	ML5621
128708	ML5344	128786	ML5815	128924	ML5769	140240	ML5328	840259	ML5369
128709	ML5212	128787	ML5121	128925	ML5688	140240	ML5621	840260	ML5550
128710	ML5345	128788	ML5485	128928	ML5690	140259	ML5369	840262	ML5637
128711	ML5461	128789	ML5486	128929	ML5693	140260	ML5516	840298	ML5840
128712	ML5276	128790	ML5641	128930	ML5778	140260	ML5550	840299	ML5643
128714	ML5275	128791	ML5346	128931	ML5764	140261	ML5646	840300	ML5567
128715	ML5536	128792	ML5358	128938	ML5726	140262	ML5637	840301	ML5568
128719	ML5449	128793	ML5537	128939	ML5821	140298	ML5840	840303	ML5578
128720	ML5239	128805	ML5453	128940	ML5699	140299	ML5643	840304	ML5587
128722	ML5199	128806	ML5460	128941	ML5647	140300	ML5567	840305	ML5624
128723	ML5287	128808	ML5459	128960	ML5809	140301	ML5568	840307	ML5846
128724	ML5264	128809	ML5233	140021	ML5556	140303	ML5578	840310	ML5613
128725	ML5339	128810	ML5512	140024	ML5422	140304	ML5587	840312	ML5560
128726	ML5393	128811	ML5742	140025	ML5596	140305	ML5624	840313	ML5577
128727	ML5347	128812	ML5194	140046	ML5504	140310	ML5613		
128728	ML5348	128812	ML5196	140074	ML5609	140312	ML5560		
128729	ML5487	128813	ML5232	140075	ML5503	140313	ML5577		
128731	ML5187	128814	ML5288	140080	ML5546	140320	ML5518		

DIMENSION CHART

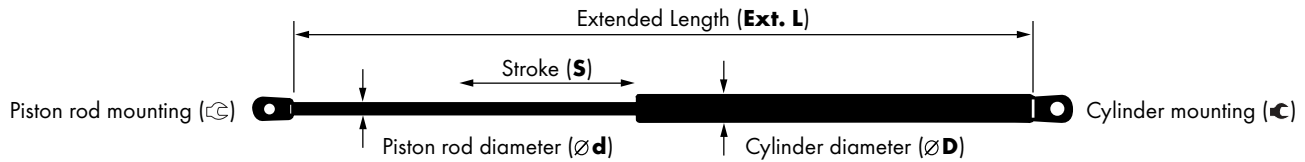

Monroe®	Ød	ØD	Ext. L	S	F1	C	C
ML5001	8	19	405	160	390	Y1	X1
ML5002	8	19	509	200	400	Y1	X1
ML5003	8	19	450	180	300	U	U
ML5004	8	19	502	200	400	U	U
ML5005	8	19	509	200	420	U	U
ML5006	8	19	550	212	230	Y2	X2
ML5007	8	19	405	160	500	Y1	X1
ML5008	8	19	365	140	600	Y1	X1
ML5009	8	19	600	255	180	Y1	X1
ML5010	8	19	600	255	200	Y1	X1
ML5011	8	19	600	255	360	Y1	X1
ML5012	8	19	600	245	410	U	U
ML5013	8	19	595	235	280	U	U
ML5014	8	19	584	234	280	U	U
ML5015	8	19	549	229.5	350	Y1	X1
ML5016	8	19	549	229.5	240	Y1	X2
ML5017	8	19	362	135	190	U	X2
ML5018	8	19	256	86	280	Y1	X1
ML5019	8	19	600	250	500	Y1	X1
ML5020	8	19	600	230	290	U	U
ML5021	8	19	700	251	200	U	U
ML5022	8	19	696	278	220	Y1	X1
ML5023	8	19	614	230	330	U	U
ML5024	8	19	450	175	340	U	U
ML5025	8	19	450	175	260	U	U
ML5026	8	19	528	224	160	U	U
ML5027	8	19	586	236	280	U	U
ML5028	8	19	460	170	220	U	U
ML5029	8	19	589	239	310	U	U
ML5030	8	19	256	86	180	Y1	X1
ML5031	8	19	549	222	355	U	U
ML5032	8	19	473	188	530	U	U
ML5033	8	19	600	250	320	U	U
ML5034	8	19	585	250	200	Y1	X1
ML5035	8	19	450	175	280	U	U
ML5036	8	19	518	209	220	Y1	X1
ML5037	8	19	700	300	325	U	P
ML5038	8	19	500	200	280	U	U
ML5039	8	19	550	229.5	380	Y1	X2
ML5040	8	19	569	220	280	U	U
ML5041	8	19	542	210	300	U	U
ML5042	8	19	600	255	310	Y1	X1
ML5043	8	19	490	180	480	Y1	X1
ML5044	8	19	527	219	450	U	U
ML5045	8	19	405	160	550	U	U
ML5046	8	19	700	300	260	U	U
ML5047	8	19	509	200	220	U	U
ML5048	8	19	527	219	420	U	U
ML5049	8	19	500	212	350	U	U
ML5050	8	19	569	220	280	U	U
ML5051	10	22	726	280	420	S1	E1
ML5052	8	19	700	300	200	U	U
ML5053	8	19	550	212	350	U	U
ML5054	8	19	543.5	206	360	U	U
ML5055	8	19	549.5	229.5	160	Y1	X1
ML5056	8	19	520	213	230	Y1	X1
ML5057	8	19	700	300	325	P	S1
ML5058	8	19	256	86	280	Y1	X1
ML5059	8	19	550	212	270	Y2	X2
ML5060	8	19	405	160	500	Y1	X1
ML5061	8	19	527	210	450	U	U
ML5062	8	19	586	236	200	U	U
ML5063	8	19	284	100	330	U	U
ML5064	8	19	527	219	520	U	U

Monroe®	Ød	ØD	Ext. L	S	F1	C	C
ML5065	8	19	600	245	430	U	U
ML5066	8	19	584	234	290	U	U
ML5067	8	19	600	255	450	Y1	X1
ML5068	8	19	515	202	370	U	U
ML5069	8	19	470	190	350	U	U
ML5070	8	19	405	160	500	Y1	D
ML5071	8	19	405	160	390	Y1	D
ML5072	8	19	502	200	280	U	U
ML5073	8	19	501	207	480	Y1	X1
ML5074	10	22	798	350	500	F1	Y3
ML5075	8	19	405	160	600	Y1	D
ML5076	10	22	550	235	850	U	U
ML5077	8	19	591	240	350	U	U
ML5078	8	19	507	205	420	S1	S1
ML5079	8	19	445	180	300	U	U
ML5080	8	19	495	192	500	U	U
ML5081	8	19	569	242	210	U	U
ML5082	8	19	469.5	171	560	U	U
ML5083	8	19	584	250	200	U	U
ML5084	8	19	685.5	300	200	U	U
ML5085	10	22	249	67	850	U	U
ML5086	8	19	526	207	570	S1	S1
ML5087	8	19	473	172	420	U	U
ML5088	8	19	645	202.6	470	E2	E3
ML5089	8	19	645	202.6	470	E2	E3
ML5090	8	19	450	180	450	U	U
ML5093	8	19	471	191	360	S1	S1
ML5094	8	19	500	204	500	U	U
ML5095	8	19	324	115	290	U	U
ML5096	8	19	447	172	500	U	U
ML5097	8	19	460	170	270	U	U
ML5098	8	19	496	188	270	P	P
ML5099	8	19	528	224	220	U	U
ML5100	8	19	500	204	480	S1	S1
ML5101	8	19	502	199	280	S1	S1
ML5102	8	19	788	342	280	Y1	V
ML5103	8	19	510	202	620	U	U
ML5104	8	19	280	95.5	630	U	S1
ML5105	10	22	569	240	910	U	U
ML5106	8	19	514.5	217	610	U	D
ML5107	8	19	602	252	430	U	U
ML5108	8	19	450	170	460	U	U
ML5109	8	19	544	207	495	U	U
ML5110	8	19	500	170	635	U	U
ML5111	8	19	402	160	390	U	U
ML5112	8	19	566.5	219	280	U	U
ML5113	8	19	700	300	670	T1	T1
ML5114	8	19	450	175	340	U	U
ML5115	8	19	500	200	400	U	U
ML5116	8	19	450	175	160	U	U
ML5117	8	19	440	175	175	S1	S1
ML5118	10	22	685	255	770	U	U
ML5119	8	19	540	196	540	U	U
ML5120	8	19	475	195	350	U	U
ML5121	8	19	450	175	600	S1	S1
ML5122	8	19	570	232	520	U	U
ML5123	8	19	515	210	500	S1	S1
ML5124	8	19	515	195	500	U	U
ML5125	8	19	508	195	600	U	U
ML5126	8	19	554	200	515	S1	U
ML5127	10	22	591	200	830	U	U
ML5128	10	22	690	280	630	S1	S1
ML5129	8	19	622	240	360	S1	S1
ML5130	8	19	596.5	212	515	U	U

DIMENSION CHART

DIMENSION CHART

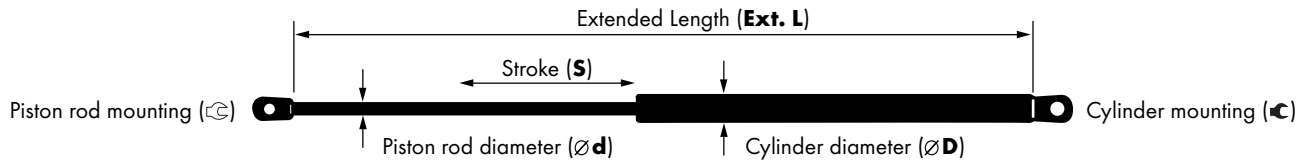

Monroe®	Ød	ØD	Ext. L	S	F1	☐	☐
ML5131	8	19	440	160	450/500	U	U
ML5132	8	19	502	205	500	S1	U
ML5133	8	19	600	250	250/310	U	U
ML5134	8	19	585	222	280	U	U
ML5135	8	19	279	95	490	U	U
ML5136	8	19	448	180	310	U	U
ML5137	8	19	542	193	590	U	U
ML5138	8	19	566	204	500	U	U
ML5139	8	19	602	250	160	S1	S1
ML5140	8	19	526	206	320	U	U
ML5141	10	22	567	221	590	U	U
ML5142	10	22	567	221	650	U	U
ML5143	8	19	574	235	260	U	U
ML5144	8	19	565	216	360	U	U
ML5145	8	19	431	173	380	U	U
ML5146	8	19	510	210	340	S1	S1
ML5147	8	19	574	235	310	U	U
ML5148	8	19	600	230	300/360	U	U
ML5149	8	19	611	230	300/355	U	U
ML5150	8	19	595	250	450/515	U	U
ML5151	8	19	445	162	420	U	U
ML5152	8	19	595	212	485	U	U
ML5153	8	19	460	169	100	S1	S1
ML5154	8	19	298	83	500	U	U
ML5155	8	19	440	160	520	U	U
ML5156	8	19	508	195	600	U	U
ML5157	10	22	540	200	450	U	U
ML5158	8	19	465	178	425	U	U
ML5159	8	19	486	190	320	S1	S1
ML5160	8	19	458	176	430	S1	S1
ML5161	8	19	534	216	410	U	U
ML5162	8	19	664,5	275	390	S1	S1
ML5163	8	19	350	100	320	S1	S1
ML5164	8	19	472	180	330	U	U
ML5165	8	19	455	164	380	U	U
ML5166	8	19	536,5	205	430	U	U
ML5167	8	19	535	215	480	U	U
ML5168	8	19	512	200	550	U	U
ML5169	8	19	527	200	450	U	U
ML5170	8	19	295	80	480	U	U
ML5171	8	19	557	224	360	U	U
ML5172	8	19	557	224	425	U	U
ML5173	8	19	555	228	485	U	U
ML5174	8	19	534	216	410	U	U
ML5175	8	19	440	169	600	U	U
ML5176	8	19	552	200	560	S1	U
ML5177	8	19	515	210	550	U	U
ML5178	8	19	507	207	550	U	U
ML5179	6	15	305,5	121	45	S1	S1
ML5180	8	19	490	190	190/250	U	U
ML5181	8	19	500	200	450	S1	U
ML5182	8	19	300	100	410	S1	S1
ML5183	8	19	445	172	220/250	U	U
ML5184	8	19	602	223	320	U	U
ML5185	8	19	500	205	470	S1	U
ML5186	8	19	540	210	370	U	U
ML5187	8	19	540	214	370	U	U
ML5188	8	19	540	214	400	U	U
ML5189	8	19	513	207	535	S1	S1
ML5190	8	19	513	207	585	S1	S1
ML5191	8	19	585	235	360	U	U
ML5192	8	19	680	270	360	U	U
ML5193	8	19	279	90	530	U	U
ML5194	8	19	500	200	380	S1	U

Monroe®	Ød	ØD	Ext. L	S	F1	☐	☐
ML5195	8	19	500	200	280	S1	U
ML5196	8	19	500	200	400	S1	U
ML5197	8	19	500	205	420	S1	U
ML5198	8	19	500	193	470	S1	U
ML5199	8	19	500	200	365	S1	U
ML5200	8	19	577	226	415	U	U
ML5201	8	19	577	226	400	U	U
ML5202	8	19	566	230	380/440	U	U
ML5203	8	19	600	215	550	U	U
ML5204	8	19	600	215	600	U	U
ML5205	8	19	625	253	575	U	U
ML5206	8	19	599	190	425	U	U
ML5207	8	19	600	190	440	U	U
ML5208	8	19	552	205	370	U	U
ML5209	8	19	552	200	410	U	U
ML5210	8	19	440,5	158	370	U	U
ML5211	8	19	527	210	350	U	U
ML5212	8	19	417	155	500	U	U
ML5213	8	19	540	200	450	S1	S1
ML5214	8	19	517	200	460	S1	S1
ML5215	8	19	264	82	370	S1	S1
ML5216	8	19	264	82	460	S1	S1
ML5217	8	19	493	196	470	U	U
ML5218	8	19	495	198	500	U	U
ML5219	8	19	495	182	515	U	U
ML5220	8	19	495	182	550	U	U
ML5221	8	19	495	182	565	U	U
ML5222	8	19	440	171	370	S1	U
ML5223	10	22	298	95	650	U	U
ML5224	10	22	465	140	655	U	U
ML5225	8	19	500	200	470	S1	U
ML5226	10	22	260	89	690	U	S1
ML5227	8	19	502	200	530	S1	S1
ML5228	10	22	560	210	730	U	U
ML5229	10	22	560	210	800	U	U
ML5230	6	15	447	170	130	S1	S1
ML5231	8	19	535	198	485	U	U
ML5232	8	19	535	198	520	U	U
ML5233	8	19	535	198	585	U	U
ML5234	10	22	278	90	630	U	U
ML5235	8	19	596	190	380	U	U
ML5236	8	19	596	195	430	U	U
ML5237	8	19	596	190	420	U	U
ML5238	8	19	500	190	635	S1	P
ML5239	10	22	500	195	690	P	U
ML5240	10	22	500	200	635	P	P
ML5241	8	19	412	155	340	U	U
ML5242	8	19	543,5	206	320	U	U
ML5243	8	19	549	232	320	U	U
ML5244	8	19	549	232	410	U	U
ML5245	10	22	569	240	750	U	U
ML5246	10	22	569	240	660	U	U
ML5247	10	22	569	240	830	U	U
ML5248	10	22	567	225	460	U	U
ML5249	10	22	685	250	710	U	U
ML5250	10	22	685	250	910	P	P
ML5251	10	22	685	250	830	P	P
ML5252	8	19	544	210	440	U	U
ML5253	8	19	496,5	192	565	U	U
ML5254	8	19	476,5	184	420	U	U
ML5255	8	19	600	250	260/320	U	U
ML5256	8	19	505	190	520	U	U
ML5257	8	19	470	182	600	U	U
ML5258	8	19	471	184	570	U	U

DIMENSION CHART

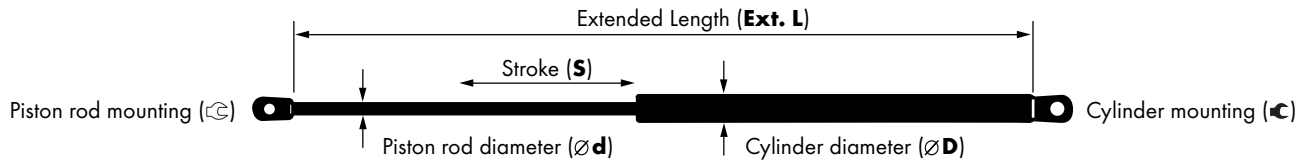

Monroe®	Ød	ØD	Ext. L	S	F1	↺	↻
ML5259	8	19	287	99	365	U	U
ML5260	8	19	293	80	610	U	U
ML5261	8	19	500	200	350	S1	U
ML5262	8	19	595	250	450	U	U
ML5263	8	19	319	110	580	S1	S1
ML5264	8	19	500	200	350	S1	U
ML5265	8	19	585	235	250	U	U
ML5266	8	19	722	306	280	U	U
ML5267	8	19	648	265	190	S1	S1
ML5268	8	19	685	285	150/180	U	U
ML5269	8	19	715	306	290	U	U
ML5270	8	19	460	160	300	U	U
ML5271	8	19	522	210	300	U	U
ML5272	8	19	522	210	400	U	U
ML5273	8	19	278	90	480	U	U
ML5274	8	19	278	90	430	U	U
ML5275	8	19	405	160	310	U	U
ML5276	8	19	529	215	245	U	U
ML5277	8	19	405	150	520	U	U
ML5278	8	19	570	240	520	U	U
ML5279	8	19	595	210	470	S1	U
ML5280	8	19	441.5	169	460	U	U
ML5281	8	19	506	200	380	U	U
ML5282	8	19	630	269	330	U	U
ML5283	8	19	627	230	570	U	U
ML5284	8	19	500	200	320	S1	U
ML5285	8	19	595	248	370	U	U
ML5286	8	19	591	239	400	U	U
ML5287	8	19	500	200	190	S1	U
ML5288	8	19	570	230	460	U	U
ML5289	8	19	556	205	500	U	U
ML5290	8	19	256	85	500	U	U
ML5291	8	19	501	175	595	U	U
ML5292	8	19	550	220	285	U	U
ML5293	8	19	485	196	460	U	U
ML5294	8	19	485	196	520	U	U
ML5295	8	19	678	282	480	U	U
ML5296	8	19	520	197	435	U	U
ML5297	8	19	435	160	100	U	U
ML5298	8	19	450	175	260	U	U
ML5299	8	19	602	252	430	U	U
ML5300	8	19	527	202	390	U	U
ML5301	8	19	295	100	380	U	U
ML5302	8	19	385	138	560	U	U
ML5303	8	19	365	135	620	S1	S1
ML5304	8	19	627	230	570	U	U
ML5305	8	19	610	200	560	U	U
ML5306	8	19	500	196	225	U	U
ML5307	8	19	485	189	450	U	U
ML5308	8	21	450	170	490	U	U
ML5309	8	19	675	285	260	U	U
ML5310	8	19	310	89	590	U	U
ML5311	8	19	640	190	470	U	U
ML5312	8	19	545	230	300	U	U
ML5313	8	19	526	206	520/560	U	U
ML5314	8	19	545	220	490/530	U	U
ML5315	8	19	675	275	400/440	U	U
ML5316	8	19	408	150	310	U	U
ML5317	8	19	590	215	410	U	U
ML5318	8	19	590	215	450	U	U
ML5319	8	19	558	200	490/550	U	U
ML5320	8	19	600	225	450	U	U
ML5321	8	19	315	100	420	U	U
ML5322	8	19	315	100	465	U	U

Monroe®	Ød	ØD	Ext. L	S	F1	↺	↻
ML5323	8	19	285	95	290	U	U
ML5324	8	19	590	220	480	U	U
ML5325	8	19	600	244	330	U	U
ML5326	8	19	566	230	450	U	U
ML5327	8	19	540	220	220/250	U	U
ML5328	10	22	775	322	530	U	U
ML5329	10	22	772	322	630	U	U
ML5330	10	22	250	74	660	U	U
ML5331	10	22	450	162	740	U	U
ML5332	8	19	485	165	640	U	U
ML5333	8	19	668	280	375	Y1	D
ML5334	8	19	549.5	200	610	U	U
ML5335	8	19	310	110	580	S1	S1
ML5336	10	22	333	100	700	S1	S1
ML5337	8	19	691.5	285	270	U	U
ML5338	8	19	570	215	530	U	U
ML5339	8	19	480	180	300	S1	U
ML5340	8	19	525	210	140	U	U
ML5341	8	19	263	80	520	U	U
ML5342	8	19	575	235	330	U	U
ML5343	8	19	448	180	590	U	U
ML5344	8	19	632	230	510/540	U	U
ML5345	8	19	650	270	310	U	U
ML5346	8	19	571	208	570	U	U
ML5347	8	19	525	205	310	U	U
ML5348	8	19	525	205	350	U	U
ML5349	8	19	525	210	480	U	U
ML5350	8	19	525	210	240	U	U
ML5351	8	19	357	128	555	U	U
ML5352	8	19	268	78	510	U	U
ML5353	8	19	555	220	450	U	U
ML5354	8	19	570	230	490	U	U
ML5355	8	19	310	95	430	U	U
ML5356	8	19	352	110	150	U	U
ML5357	8	19	538	190	125	U	U
ML5358	8	19	500	171	350/400	U	U
ML5359	8	19	513	215	350	U	U
ML5360	8	19	500	190	360	U	U
ML5361	8	19	510	200	320	U	U
ML5362	8	19	507	208	436	U	U
ML5363	8	19	632	215	600	U	U
ML5364	8	19	635	248	360	U	U
ML5365	8	19	365	135	180	U	U
ML5366	8	19	365	135	240	U	U
ML5367	8	19	567.5	183	430	U	U
ML5368	8	19	750	315	300	S1	S1
ML5369	8	19	828	249	355	U	U
ML5370	8	19	500	200	420	U	U
ML5371	8	19	499	195	400	U	U
ML5372	8	19	546	215	500	U	U
ML5373	8	19	548	213	475	U	U
ML5374	8	19	556	225	475	U	U
ML5375	8	19	568	230	500	U	U
ML5376	8	19	280	90	580	U	S1
ML5377	8	19	507	203	520	U	S1
ML5378	8	19	545	210	490	U	S1
ML5379	8	19	545	210	530	U	S1
ML5380	8	19	485	187	610	U	S1
ML5381	8	19	557	215	550	U	S1
ML5382	8	19	440	155	300	U	S1
ML5383	8	19	473.5	170	590	U	S1
ML5384	8	19	606.5	230	540	U	S1
ML5385	8	19	722	306	310	U	U
ML5386	8	19	722	315	325	U	U

DIMENSION CHART

DIMENSION CHART

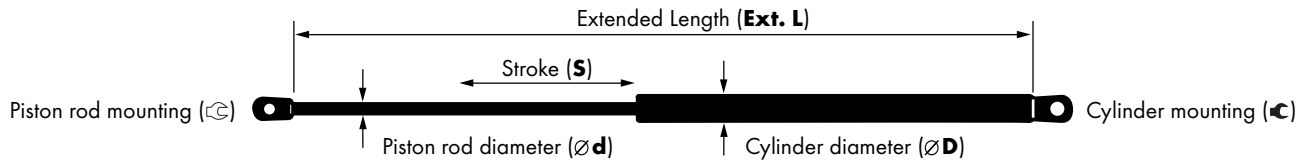

Monroe®	Ød	ØD	Ext. L	S	F1	☐	☐
ML5387	8	19	395	148	180	U	U
ML5388	8	19	565	215	480	U	U
ML5389	8	19	215	48	200	S1	S1
ML5390	8	19	508	194	350	U	U
ML5391	8	19	510	208	440	U	U
ML5392	8	19	400	149	300	S1	S1
ML5393	8	19	678	270	270	U	U
ML5394	8	19	600	226	360	U	U
ML5395	8	19	510	208	390	U	U
ML5396	8	19	568	213	360	U	U
ML5397	8	19	568	230	560	U	U
ML5398	8	18	580	245	340	U	U
ML5399	8	19	570	230	215	U	U
ML5400	8	19	570	230	420	U	U
ML5401	8	19	570	230	520	U	U
ML5402	8	19	570	240	470	U	U
ML5403	8	19	668	215	375	U	U
ML5404	8	19	240	74	300	U	U
ML5405	8	19	516	205	425	U	U
ML5406	8	19	498	197	330	U	U
ML5407	8	19	700	257	320	U	U
ML5408	8	19	511	199	520	U	U
ML5409	8	18	765	325	235	U	U
ML5410	8	19	515	200	445	S1	S1
ML5411	8	19	315	105	370	S1	U
ML5412	8	19	565	210	560	S1	U
ML5413	8	19	472	175	590	S1	U
ML5414	8	19	438	170	480	S1	S1
ML5415	10	22	455	127	700	U	U
ML5416	8	19	481.5	199	530	U	U
ML5417	8	19	275	90	420	S1	S1
ML5418	8	19	645.5	275	450	U	U
ML5419	8	19	280	95	390	S1	S1
ML5420	8	19	465	187	320	Y1	D
ML5421	6	15	367	145	320	Y1	X1
ML5422	6	15	410	160	280	Y1	X1
ML5423	10	22	520	180	660	U	U
ML5424	8	19	567	193	540	U	S1
ML5425	8	19	491	205	600	U	U
ML5426	10	22	418	148	700N	U	U
ML5427	8	19	471	185	380	S1	U
ML5428	8	19	580	247	470	S1	S1
ML5429	10	22	550	235	810	U	U
ML5430	8	19	590.5	245	480	U	U
ML5431	8	19	256	85	630	U	U
ML5432	8	19	624	260	400	S1	S1
ML5433	10	22	520	180	665	U	U
ML5434	8	19	599	220	360	U	U
ML5435	8	19	656	260	400	S1	S1
ML5436	8	19	517	190	420	S1	S1
ML5437	8	19	575	220	500	S1	U
ML5438	8	19	459.5	180	535	S1	S1
ML5439	8	19	279	95	520	U	U
ML5440	8	19	534.5	220	480	S1	S1
ML5441	10	22	326	115	800	S1	S1
ML5442	8	19	348	120	620	U	U
ML5443	10	22	603	220	740	U	U
ML5444	8	19	365	140	410	Y1	D
ML5445	8	19	365	140	480	Y1	D
ML5446	10	22	382	140	660	T1	T1
ML5447	8	19	540	130	170	T1	T1
ML5448	10	22	866	350	370	U	U
ML5449	8	19	405	160	620	U	U
ML5450	8	19	635	259	290	U	U

Monroe®	Ød	ØD	Ext. L	S	F1	☐	☐
ML5451	8	19	611	205	350	U	U
ML5452	8	19	653	260	400/463	U	U
ML5453	8	19	460	180	380	U	U
ML5454	8	19	627	230	630	U	U
ML5455	8	19	632	215	600	U	U
ML5456	8	19	610	200	600	U	U
ML5457	8	19	546	225	220	U	U
ML5458	8	19	631	230	440	U	U
ML5459	8	19	485	193	460	S1	S1
ML5460	8	19	494	185	490	S1	S1
ML5461	8	19	506	205	120/180	S1	S1
ML5462	8	19	477	188	360	S1	S1
ML5463	8	19	577	226	275	S1	S1
ML5464	8	19	577	226	320	S1	S1
ML5465	8	19	614	229	300	S1	S1
ML5466	8	19	280	80	465	S1	S1
ML5467	8	19	280	80	420	S1	S1
ML5468	8	19	512	200	470	S1	S1
ML5469	8	19	581.5	210	535	S1	S1
ML5470	8	19	685	265	200	S1	S1
ML5471	8	19	286	100	310	S1	S1
ML5472	8	19	395	150	230	S1	S1
ML5473	8	19	395	150	470	S1	S1
ML5474	8	19	535	220	425	S1	S1
ML5475	8	19	520	175	640	U	U
ML5476	8	19	574.5	230	530	S1	S1
ML5477	8	19	574.5	230	620	S1	S1
ML5478	8	19	515	200	490	S1	S1
ML5479	8	19	398	120	180	S1	S1
ML5480	8	19	452	177	350	S1	S1
ML5481	8	19	270	75	420	S1	S1
ML5482	8	19	575	230	440	S1	S1
ML5483	8	19	280	95	500	S1	S1
ML5484	8	19	400	150	280	S1	S1
ML5485	8	19	468	163	440	S1	U
ML5486	8	19	434	153	585	S1	S1
ML5487	8	19	298	90	600	S1	S1
ML5488	8	19	320	100	360	S1	S1
ML5489	8	19	364	132	310	S1	S1
ML5490	8	19	363	132	370	S1	S1
ML5491	8	19	500	200	310	S1	U
ML5492	8	19	465	169	113	Y1	D
ML5493	8	19	557	200	135	Y1	D
ML5494	8	19	700	295	400	Y1	D
ML5495	8	19	490	195	610	U	U
ML5496	8	19	226	63	100	Y1	D
ML5497	8	19	670	294	320	Y1	D
ML5498	8	19	670	294	345	Y1	D
ML5499	8	19	700	295	345	Y1	D
ML5500	8	19	430	160	470	S1	S1
ML5501	8	19	600	250	540	Y2	D
ML5502	8	19	300	99	560	S1	S1
ML5503	8	19	600	230	510	T1	T1
ML5504	8	19	837	315	365	T1	T1
ML5505	8	19	630	220	570	T1	T1
ML5506	8	19	540	220	470/520	T1	T1
ML5507	8	19	433	165	500	T1	T1
ML5508	8	19	680	270	390	T1	T1
ML5509	8	19	534	217	200	T1	T1
ML5510	10	22	483	175	740	U	U
ML5511	10	22	483	175	690	U	U
ML5512	10	22	480	173	690	U	U
ML5513	10	22	382	140	660	T1	T1
ML5514	10	22	850	340	670	U	U

DIMENSION CHART

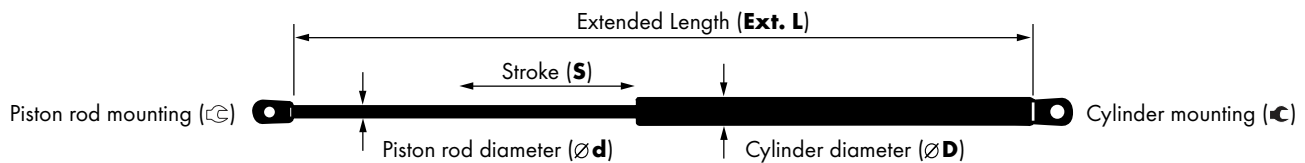

Monroe®	Ød	ØD	Ext. L	S	F1	C	C
ML5515	10	22	722	210	819	U	U
ML5516	10	22	905	307	730	T1	T1
ML5517	10	22	195	55	1100	U	U
ML5518	10	22	730	200	700	U	U
ML5519	10	22	730	200	760	U	U
ML5520	8	19	335	95	520	S1	Q
ML5521	8	19	675	263	360	T1	Q
ML5522	8	19	242	84	380	Y6	D
ML5523	8	19	310	90	640	S1	Q
ML5524	10	22	273	92	680	T1	T1
ML5525	10	22	273	92	720	T1	T1
ML5526	8	19	180	55	480	S1	Z
ML5527	10	22	613.5	248	620	O	O
ML5528	10	22	697	257	610	M	O
ML5529	14	28	270	70	1600	O	M
ML5530	8	19	640	260	510	U	P
ML5531	8	19	280	90	500	S1	T1
ML5532	8	19	280	90	600	S1	T1
ML5533	10	22	272	90	670	T1	T1
ML5534	8	19	605	247	340	S1	U
ML5535	8	19	241	70	560	Y1	T1
ML5536	8	19	288	95	250	U	Q
ML5537	10	22	603	198	810	U	U
ML5538	10	22	603	198	850	U	U
ML5539	10	22	489	144	720	U	U
ML5540	10	22	364	130	800	S2	S2
ML5541	8	19	568	215	410	S1	S1
ML5542	8	19	667	215	375	U	U
ML5543	8	19	695	272	640	U	U
ML5544	8	19	596	210	450	U	S1
ML5545	8	19	596	210	510	U	S1
ML5546	6	15	185	55	100	R	R
ML5547	6	15	502	200	125	S1	S1
ML5548	6	15	530	213	110	S1	S1
ML5549	8	19	270	90	540	T1	D
ML5550	10	22	905	307	730	T1	T1
ML5551	6	15	547	190	170	S1	S1
ML5552	6	15	365	135	135	S1	S1
ML5553	10	22	310	89	650	U	U
ML5554	10	22	573.5	215	580	U	T1
ML5555	10	22	573.5	215	670	U	T1
ML5556	6	15	547	214	225	Y1	X1
ML5557	10	22	492	188	710	U	U
ML5558	8	19	280	90	550	U	T1
ML5559	10	22	235	52	850	U	S2
ML5560	8	19	535	200	280	U	U
ML5561	8	19	687	295	270	U	U
ML5562	8	19	313	112	330	S1	S1
ML5563	8	19	374	140	350	S1	S1
ML5564	8	19	577	225	270	U	P
ML5565	8	19	715	303	160	P	S1
ML5566	8	19	254	90	420	Y1	D
ML5567	8	19	635	225	200	S1	S1
ML5568	8	19	464	166	160	S1	S1
ML5569	8	19	485	185	580	S1	S1
ML5570	8	19	490	187	380	S1	S1
ML5571	8	19	550	222	475	T1	T1
ML5572	8	19	500	190	220	Y1	U
ML5573	8	19	640	235	390	U	D
ML5574	8	19	500	200	270	U	D
ML5575	10	22	755	210	970	U	U
ML5576	10	22	755	210	1080	U	U
ML5577	8	19	570	200	280	U	P
ML5578	8	19	650	250	460	U	U

Monroe®	Ød	ØD	Ext. L	S	F1	C	C
ML5579	8	19	523	202	530	S1	S1
ML5580	10	22	520	185	730	U	U
ML5581	10	22	527	200	660	U	U
ML5582	10	22	769	247	475	U	U
ML5583	10	22	195	50	760/860	U	U
ML5584	10	22	870	370	370	S1	U
ML5585	10	22	613.5	248	560	O	O
ML5586	10	22	613.5	248	640	O	O
ML5587	8	19	459	172	230	S1	S1
ML5588	8	19	559	220	330	S1	S1
ML5589	8	19	671.5	270	360	S1	S1
ML5590	8	19	334	100	520	S1	Q
ML5591	10	22	545	195	750	U	Q
ML5592	8	19	498	225	540	S1	S1
ML5593	8	19	615	260	400	Y1	D
ML5594	8	19	255	86	600	Y5	X3
ML5595	8	19	255	86	370	Y5	X3
ML5596	6	15	254	95	350	Y4	X1
ML5597	8	19	547	230	230	U	X1
ML5598	8	19	600	250	160	S1	S1
ML5599	6	15	440	142	380	Y1	X1
ML5600	8	19	500	200	230	Y1	D
ML5601	8	19	650	275	240/300	Y1	D
ML5602	8	19	650	275	240/300	S1	D
ML5603	8	19	650	275	310/370	Y1	D
ML5604	8	19	640	278	300	S1	D
ML5605	8	19	650	275	310/370	S1	D
ML5606	8	19	579	235	260/320	Y1	D
ML5607	8	19	544	224	240/300	S1	S1
ML5608	8	19	675	279	210	N	N
ML5609	8	19	580	245	380	W	D
ML5610	8	19	600	250	540	Y2	D
ML5611	8	19	245	76	330	Y1	D
ML5612	10	22	501	175	780	U	U
ML5613	8	19	500	201	600	Y1	D
ML5614	10	22	490	200	780	U	U
ML5615	8	19	502	195	400	U	P
ML5616	8	19	570	200	630	S1	U
ML5617	8	19	268	83.5	450	N	N
ML5618	8	19	505	180	430	N	N
ML5619	8	19	330	116	340	N	N
ML5620	8	19	580	205	230	U	U
ML5621	10	22	775	322	530	U	U
ML5622	8	19	515	200	490	S1	S1
ML5623	8	19	398	120	180	S1	S1
ML5624	8	19	392	150	300	P	T1
ML5625	8	19	475	198	180/240	Y1	S1
ML5626	8	19	627	230	570	U	U
ML5627	8	19	610	200	560	U	U
ML5628	10	22	265	80	820	U	U
ML5629	6	15	225	80	100	R	R
ML5630	10	22	431	121	680/740	S1	S1
ML5631	8	19	677	274	340/400	T1	T1
ML5632	8	19	486	170	585	Y1	D
ML5633	8	19	268	90	540	Y1	D
ML5634	8	19	680	270	360	T1	T1
ML5635	8	19	500	195	650	Y1	D
ML5636	8	19	525	210	240	U	U
ML5637	14	28	396	108	1550	O	O
ML5638	8	19	765	324	200	U	U
ML5639	8	19	254	85	340	Y1	D
ML5640	6	15	305	109	130	T1	T1
ML5641	8	19	511.5	172	545	S1	S1
ML5642	8	19	550	200	460	T1	T1

DIMENSION CHART

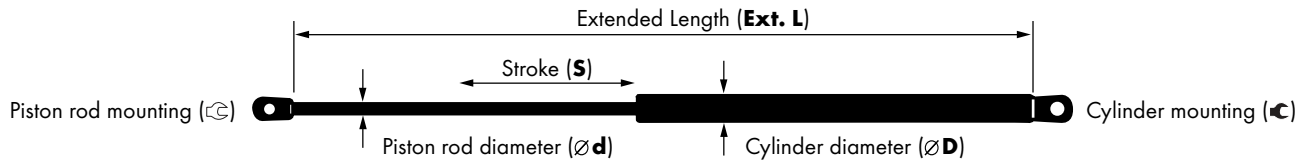

Monroe®	Ød	ØD	Ext. L	S	F1	C	C
ML5643	6	15	244	90	400	S1	S1
ML5644	8	19	515	215	550	T1	D
ML5645	8	19	512	200	300	Y1	U
ML5646	8	19	319	100	370	Y5	X3
ML5647	8	19	485	200	565	P	S1
ML5648	8	18.5	728	310	265	P	U
ML5649	8	19	405	160	300	U	U
ML5650	8	18.5	484	190	200	P	U
ML5651	8	18.5	544	218	290	U	U
ML5652	8	18.5	375	135	495 F3	J	S1
ML5653	8	18.5	439.5	157	550	S1	U
ML5654	8	18.5	657	275	480	P	U
ML5655	8	18.5	456	165	320	S1	S1
ML5656	8	18.5	469.5	185	580 F3	P	P
ML5657	8	18.5	495	205	610 F3	S1	S1
ML5658	8	18.5	369	110	320	S1	S1
ML5659	8	18.5	553	225	220	S1	S1
ML5660	8	19	441	175	300	P	U
ML5661	8	19	440	170	470	U	U
ML5662	8	19	590	245	460	U	U
ML5663	8	18.5	283	101.5	450	U	U
ML5664	8	19	585	240	420	U	U
ML5665	8	19	585.5	245	405	U	U
ML5666	8	19	531	173	545	U	U
ML5667	8	19	490.5	200	480	U	U
ML5668	8	19	545	195	425	S1	U
ML5669	8	19	424.5	165	450	U	U
ML5670	8	19	366	117	280	S1	S1
ML5671	8	19	627	205	660	U	U
ML5672	8	19	540	210	385	U	U
ML5673	8	19	582	203	460	U	U
ML5674	14	28	325	100	1400	S1	S1
ML5675	10	22	175	45	700	U	U
ML5676	8	19	436	175	150	U	U
ML5677	8	19	499	205	460	Y1	T1
ML5678	10	22	943	417	380	U	L
ML5679	8	19	722	306	310	L	L
ML5680	8	19	365.5	130	440	U	U
ML5681	8	19	495	205	440	U	U
ML5682	8	19	420	162	600	U	U
ML5683	8	19	580	201	510	U	U
ML5684	8	19	515	190	490	U	U
ML5685	14	28	320	85	1200	M	O
ML5686	8	19	165	40	650	U	U
ML5687	8	19	555	228	305	U	U
ML5688	8	19	288	104	640	S1	S1
ML5689	8	19	400	160	330	S1	P
ML5690	8	19	530	175	530	S1	S1
ML5691	8	19	412	163	400	S1	U
ML5692	8	19	545	210	450	U	U
ML5693	8	19	625	210	590	P	S1
ML5694	8	19	370	110	320	S1	S1
ML5695	8	19	425	165	350	S1	U
ML5696	8	19	355	120	350	P	U
ML5697	8	19	604	253	250	U	U
ML5698	8	19	291	107	380	S1	U
ML5699	8	19	445	183	550	P	S1
ML5700	8	19	480	173	135	U	U
ML5701	8	19	590	176	435	S1	U
ML5702	8	19	470	185	480	P	S1
ML5703	8	19	480	190	420	P	U
ML5704	8	19	378	145	540	T1	T1
ML5705	8	19	565	240	290	S1	U
ML5706	8	19	395	158	440	P	U

Monroe®	Ød	ØD	Ext. L	S	F1	C	C
ML5707	8	19	545	210	620	U	U
ML5708	8	19	480	195	335	U	U
ML5709	10	22	736.5	310	725	U	U
ML5710	8	19	299	109	550	U	U
ML5711	8	19	515	210	490	U	U
ML5712	8	19	490	200	380	P	U
ML5713	8	19	515	215	400	U	U
ML5714	8	19	386.5	150	350	U	P
ML5715	8	19	650	270	350	U	U
ML5716	10	22	667	255	755	U	U
ML5717	8	19	497	200	430	P	U
ML5718	10	22	547	220	460	U	U
ML5719	8	19	475	175	510	U	P
ML5720	8	19	543	220	310	U	U
ML5721	8	19	474	190	570	U	U
ML5722	10	22	505	205	610	U	U
ML5723	8	19	405	160	480	S1	S1
ML5724	8	19	533	200	515	S1	S1
ML5725	8	19	451	185	385	S1	S1
ML5726	8	19	730	316	140	U	U
ML5727	8	19	320	105	470	U	U
ML5728	8	19	375	145	615	U	U
ML5729	8	19	310	110	400	U	U
ML5730	8	19	565	215	315	U	U
ML5731	8	19	505	211	330	S1	P
ML5732	8	19	505	195	490	S1	S1
ML5733	6	15	435	180	105	S1	S1
ML5734	8	19	460	180	F3 440	S1	S1
ML5735	8	19	730	320	250	P	U
ML5736	8	19	404.5	163	460	S1	U
ML5737	8	19	720	300	180	P	U
ML5738	8	19	735	321	300	P	U
ML5739	8	19	485	200	170	U	P
ML5740	8	19	315	120	440	S1	U
ML5741	8	19	765	335	340	U	U
ML5742	8	19	450	180	535	S1	U
ML5743	10	22	505	170	770	U	P
ML5744	10	22	298	80	730	U	U
ML5745	10	22	298	80	700	U	U
ML5746	8	19	475	184	650	U	P
ML5747	8	19	490	198	530	T1	T1
ML5748	8	19	255	85	600	S1	U
ML5749	8	19	530	210	410	U	P
ML5750	10	22	720	280	870	U	U
ML5751	10	22	300	70	710	T1	T1
ML5752	8	19	500	208	375	U	U
ML5753	8	19	470	160	630	U	U
ML5754	8	19	528	212	420	U	P
ML5755	8	19	640	255	F3 595	U	P
ML5756	8	19	640	255	F3 565	U	P
ML5757	8	19	473	182	540	U	U
ML5758	8	19	726.5	310	360	P	U
ML5759	8	19	483	191	370	T1	T1
ML5760	8	19	515	196	585	P	U
ML5761	8	19	305	105	550	U	U
ML5762	8	19	385	150	140	P	U
ML5763	8	19	540	225	390	T1	T1
ML5764	8	19	252	85	425	U	U
ML5765	8	19	565	220	500	T1	T1
ML5766	8	19	318	120	380	S1	S1
ML5767	8	19	500	195	340	S1	U
ML5768	8	19	721.5	315	350	U	U
ML5769	10	22	285	100	720	U	S1
ML5770	8	19	605	242	635	P	P

DIMENSION CHART

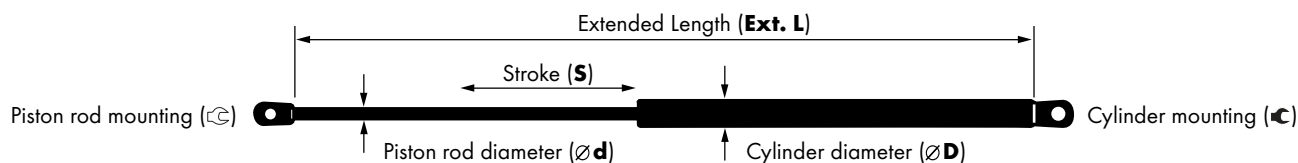

Monroe®	Ød	ØD	Ext. L	S	F1	☉	☉
ML5771	10	22	574	198	990	P	P
ML5772	8	19	539	218	585	T1	P
ML5773	8	19	475	195	640	U	U
ML5774	8	19	500	200	525	T1	P
ML5775	8	19	437	173	350	S1	S1
ML5776	8	19	495	197	420	U	P
ML5777	8	19	430	170	370	U	U
ML5778	8	19	285	105	600	S1	U
ML5779	8	19	445	160	420	U	U
ML5780	8	19	550	235	280	T1	T1
ML5781	10	22	535	183	710	U	S1
ML5782	8	19	558	235	500	T1	T1
ML5783	8	19	585	190	F3-625	U	P
ML5784	8	19	510	213	360	U	U
ML5785	8	19	460	170	350	S1	S1
ML5786	8	19	280	90	510	U	U
ML5787	10	22	550	160	710	T1	T1
ML5788	8	19	554	185	F3 200	T1	T1
ML5789	8	19	345	130	350	U	U
ML5790	8	19	740	310	290	P	S1
ML5791	8	19	201	52	250	S1	U
ML5792	8	19	480	200	550	U	P
ML5793	8	19	315	100	550	S1	S1
ML5794	8	19	462.5	190	560	T1	T1
ML5795	8	19	628	272	440	U	U
ML5796	8	19	463	185	360	S1	U
ML5797	10	22	556	224	715	T1	T1
ML5798	8	19	674	293	300	U	U
ML5799	8	19	674	293	330	U	U
ML5800	8	19	333	117	650	U	U
ML5801	8	19	415	160	530	U	U
ML5802	8	19	418	163	490	U	U
ML5803	8	19	240	70	380	S1	S1
ML5804	8	19	314,5	116	330	U	U
ML5805	8	19	479	179	340	P	U
ML5806	10	22	560	178	725	U	P
ML5807	8	19	609,5	251,5	245	U	U
ML5808	8	19	256	58	560	S1	S1
ML5809	8	19	536	204	410	S1	S1
ML5810	8	19	238	62	165	U	U
ML5811	8	19	323	103	700	U	U
ML5812	8	19	520	208	130	U	U
ML5813	6	15	297	113	240	S1	S1
ML5814	8	19	447	175	300	U	U
ML5815	8	19	600	228	360	U	U
ML5816	10	22	570	240	650	T1	T1
ML5817	10	22	482	185,5	700	P	U
ML5818	8	19	282	98	560	U	U
ML5819	8	19	568	233	330	U	U
ML5820	8	19	613	260	300	U	U
ML5821	8	19	500	203	245	S1	U
ML5822	8	19	580	245	165	S1	S1
ML5823	6	15	362	138	100	S1	S1
ML5824	8	19	558	235	530	S1	S1
ML5825	8	19	500	230	135	S1	S1
ML5826	8	19	520	180	F3-625	T1	T1
ML5827	8	19	603	255	240	U	U
ML5828	8	19	547	220	550	U	P
ML5829	8	19	730	310	380	P	U
ML5830	8	19	375	140	390	U	P
ML5831	8	19	450	180	550	U	S1
ML5832	8	19	390	155	360	U	P
ML5833	10	22	755	210	1080	U	P
ML5834	10	22	699	257	610	M	O

Monroe®	Ød	ØD	Ext. L	S	F1	☉	☉
ML5835	10	22	699	257	540	M	O
ML5836	8	19	639	258	465	T1	T1
ML5837	8	19	690	300	630	T1	T1
ML5838	8	19	494	172	500	P	P
ML5839	10	22	390	148	800	U	K
ML5840	6	15	465	190	335	I	H
ML5841	8	19	700	175	1050	U	U
ML5842	10	22	587	230	340	S1	C1
ML5843	10	22	587	230	340	S1	C2
ML5844	8	18.5	310	110	590	U	U
ML5845	8	18.5	419	165	510	U	U
ML5846	8	19	405	0	270	U	D
ML5847	10	22	610	240	570	B2	A2
ML5848	10	22	610	240	570	B1	A1
ML5849	8	18.5	526	220	325	U	U
ML5850	8	18.5	559	230	290	S1	S1
ML5851	8	18.5	631	265	455	S1	S1
ML5852	10	22	399	86	1430	G	G

Industrial Catalogue

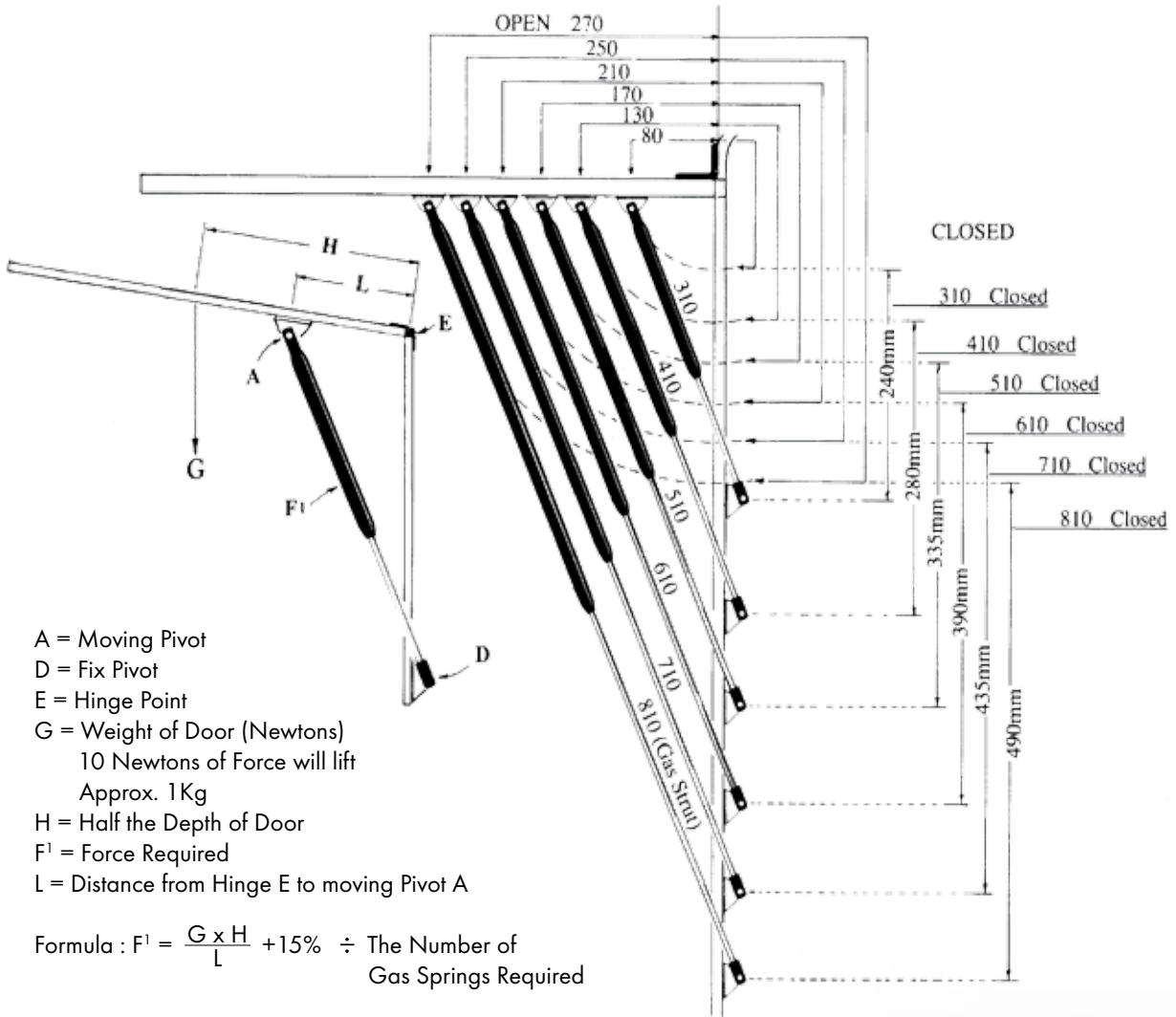

Special Note.

By reducing the measurement from Point A to Hinge Point E by 20mm, this will give you an extra 10° (degrees) lift.

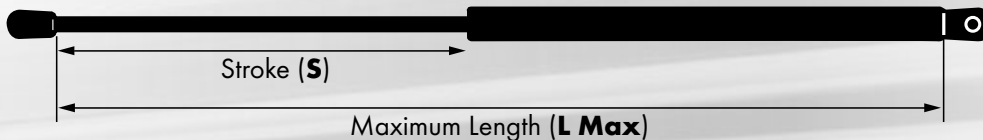

EXTENSION FORCE WITH EXTENDED PISTON ROD

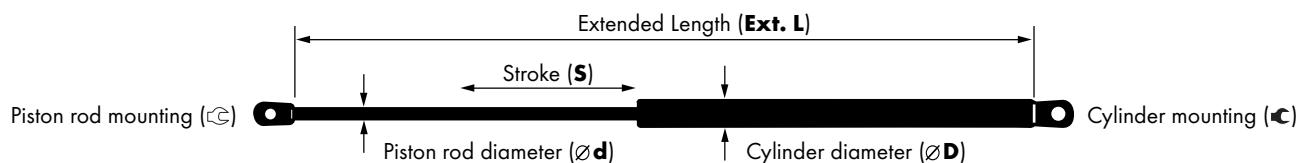
F1

F1	Monroe®	Ød	ØD	Ext. L	S	C	C
45	ML5179	6	15	305.5	121	S1	S1
100	ML5153	8	19	460	169	S1	S1
100	ML5297	8	19	435	160	U	U
100	ML5496	8	19	226	63	Y1	D
100	ML5546	6	15	185	55	R	R
100	ML5629	6	15	225	80	R	R
100	ML5823	6	15	362	138	S1	S1
105	ML5733	6	15	435	180	S1	S1
110	ML5548	6	15	530	213	S1	S1
113	ML5492	8	19	465	169	Y1	D
125	ML5357	8	19	538	190	U	U
125	ML5547	6	15	502	200	S1	S1
130	ML5230	6	15	447	170	S1	S1
130	ML5640	6	15	305	109	T1	T1
130	ML5812	8	19	520	208	U	U
135	ML5493	8	19	557	200	Y1	D
135	ML5552	6	15	365	135	S1	S1
135	ML5700	8	19	480	173	U	U
135	ML5825	8	19	500	230	S1	S1
140	ML5340	8	19	525	210	U	U
140	ML5726	8	19	730	316	U	U
140	ML5762	8	19	385	150	P	U
150	ML5356	8	19	352	110	U	U
150	ML5676	8	19	436	175	U	U
160	ML5026	8	19	528	224	U	U
160	ML5055	8	19	549.5	229.5	Y1	X1
160	ML5116	8	19	450	175	U	U
160	ML5139	8	19	602	250	S1	S1
160	ML5565	8	19	715	303	P	S1
160	ML5568	8	19	464	166	S1	S1
160	ML5598	8	19	600	250	S1	S1
165	ML5810	8	19	238	62	U	U
165	ML5822	8	19	580	245	S1	S1
170	ML5447	8	19	540	130	T1	T1
170	ML5551	6	15	547	190	S1	S1
170	ML5739	8	19	485	200	U	P
175	ML5117	8	19	440	175	S1	S1
180	ML5009	8	19	600	255	Y1	X1
180	ML5030	8	19	256	86	Y1	X1
180	ML5365	8	19	365	135	U	U
180	ML5387	8	19	395	148	U	U
180	ML5479	8	19	398	120	S1	S1
180	ML5623	8	19	398	120	S1	S1
180	ML5737	8	19	720	300	P	U
190	ML5017	8	19	362	135	U	X2
190	ML5267	8	19	648	265	S1	S1
190	ML5287	8	19	500	200	S1	U
200	ML5010	8	19	600	255	Y1	X1
200	ML5021	8	19	700	251	U	U
200	ML5034	8	19	585	250	Y1	X1
200	ML5052	8	19	700	300	U	U
200	ML5062	8	19	586	236	U	U
200	ML5083	8	19	584	250	U	U
200	ML5084	8	19	685.5	300	U	U
200	ML5389	8	19	215	48	S1	S1
200	ML5470	8	19	685	265	S1	S1
200	ML5509	8	19	534	217	T1	T1
200	ML5567	8	19	635	225	S1	S1
200	ML5638	8	19	765	324	U	U
200	ML5650	8	18.5	484	190	P	U
210	ML5081	8	19	569	242	U	U
210	ML5608	8	19	675	279	N	N
215	ML5399	8	19	570	230	U	U
220	ML5022	8	19	696	278	Y1	X1

F1	Monroe®	Ød	ØD	Ext. L	S	C	C
220	ML5028	8	19	460	170	U	U
220	ML5036	8	19	518	209	Y1	X1
220	ML5047	8	19	509	200	U	U
220	ML5099	8	19	528	224	U	U
220	ML5457	8	19	546	225	U	U
220	ML5572	8	19	500	190	Y1	U
220	ML5659	8	18.5	553	225	S1	S1
225	ML5306	8	19	500	196	U	U
225	ML5556	6	15	547	214	Y1	X1
230	ML5006	8	19	550	212	Y2	X2
230	ML5056	8	19	520	213	Y1	X1
230	ML5472	8	19	395	150	S1	S1
230	ML5587	8	19	459	172	S1	S1
230	ML5597	8	19	547	230	U	X1
230	ML5600	8	19	500	200	Y1	D
230	ML5620	8	19	580	205	U	U
235	ML5409	8	18	765	325	U	U
240	ML5016	8	19	549	229.5	Y1	X2
240	ML5350	8	19	525	210	U	U
240	ML5366	8	19	365	135	U	U
240	ML5636	8	19	525	210	U	U
240	ML5813	6	15	297	113	S1	S1
240	ML5827	8	19	603	255	U	U
245	ML5276	8	19	529	215	U	U
245	ML5807	8	19	609.5	251.5	U	U
245	ML5821	8	19	500	203	S1	U
250	ML5265	8	19	585	235	U	U
250	ML5536	8	19	288	95	U	Q
250	ML5697	8	19	604	253	U	U
250	ML5735	8	19	730	320	P	U
250	ML5791	8	19	201	52	S1	U
260	ML5025	8	19	450	175	U	U
260	ML5046	8	19	700	300	U	U
260	ML5143	8	19	574	235	U	U
260	ML5298	8	19	450	175	U	U
260	ML5309	8	19	675	285	U	U
265	ML5648	8	18.5	728	310	P	U
270	ML5059	8	19	550	212	Y2	X2
270	ML5097	8	19	460	170	U	U
270	ML5098	8	19	496	188	P	P
270	ML5337	8	19	691.5	285	U	U
270	ML5393	8	19	678	270	U	U
270	ML5561	8	19	687	295	U	U
270	ML5564	8	19	577	225	U	P
270	ML5574	8	19	500	200	U	D
275	ML5463	8	19	577	226	S1	S1
280	ML5013	8	19	595	235	U	U
280	ML5014	8	19	584	234	U	U
280	ML5018	8	19	256	86	Y1	X1
280	ML5027	8	19	586	236	U	U
280	ML5035	8	19	450	175	U	U
280	ML5038	8	19	500	200	U	U
280	ML5040	8	19	569	220	U	U
280	ML5050	8	19	569	220	U	U
280	ML5058	8	19	256	86	Y1	X1
280	ML5072	8	19	502	200	U	U
280	ML5101	8	19	502	199	S1	S1
280	ML5102	8	19	788	342	Y1	V
280	ML5112	8	19	566.5	219	U	U
280	ML5134	8	19	585	222	U	U
280	ML5195	8	19	500	200	S1	U
280	ML5266	8	19	722	306	U	U
280	ML5422	6	15	410	160	Y1	X1
280	ML5484	8	19	400	150	S1	S1

EXTENSION FORCE WITH EXTENDED PISTON ROD

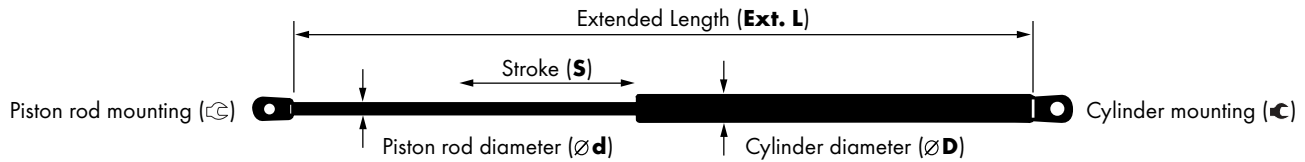
F1

F1	Monroe®	Ød	ØD	Ext. L	S	C	C
280	ML5560	8	19	535	200	U	U
280	ML5577	8	19	570	200	U	P
280	ML5670	8	19	366	117	S1	S1
280	ML5780	8	19	550	235	T1	T1
285	ML5292	8	19	550	220	U	U
290	ML5020	8	19	600	230	U	U
290	ML5066	8	19	584	234	U	U
290	ML5095	8	19	324	115	U	U
290	ML5269	8	19	715	306	U	U
290	ML5323	8	19	285	95	U	U
290	ML5450	8	19	635	259	U	U
290	ML5651	8	18.5	544	218	U	U
290	ML5705	8	19	565	240	S1	U
290	ML5790	8	19	740	310	P	S1
290	ML5850	8	18.5	559	230	S1	S1
300	ML5003	8	19	450	180	U	U
300	ML5041	8	19	542	210	U	U
300	ML5079	8	19	445	180	U	U
300	ML5270	8	19	460	160	U	U
300	ML5271	8	19	522	210	U	U
300	ML5312	8	19	545	230	U	U
300	ML5339	8	19	480	180	S1	U
300	ML5368	8	19	750	315	S1	S1
300	ML5382	8	19	440	155	U	S1
300	ML5392	8	19	400	149	S1	S1
300	ML5404	8	19	240	74	U	U
300	ML5465	8	19	614	229	S1	S1
300	ML5604	8	19	640	278	S1	D
300	ML5624	8	19	392	150	P	T1
300	ML5645	8	19	512	200	Y1	U
300	ML5649	8	19	405	160	U	U
300	ML5660	8	19	441	175	P	U
300	ML5738	8	19	735	321	P	U
300	ML5798	8	19	674	293	U	U
300	ML5814	8	19	447	175	U	U
300	ML5820	8	19	613	260	U	U
305	ML5687	8	19	555	228	U	U
310	ML5029	8	19	589	239	U	U
310	ML5042	8	19	600	255	Y1	X1
310	ML5136	8	19	448	180	U	U
310	ML5147	8	19	574	235	U	U
310	ML5275	8	19	405	160	U	U
310	ML5316	8	19	408	150	U	U
310	ML5345	8	19	650	270	U	U
310	ML5347	8	19	525	205	U	U
310	ML5385	8	19	722	306	U	U
310	ML5471	8	19	286	100	S1	S1
310	ML5489	8	19	364	132	S1	S1
310	ML5491	8	19	500	200	S1	U
310	ML5679	8	19	722	306	L	L
310	ML5720	8	19	543	220	U	U
315	ML5730	8	19	565	215	U	U
320	ML5033	8	19	600	250	U	U
320	ML5140	8	19	526	206	U	U
320	ML5159	8	19	486	190	S1	S1
320	ML5163	8	19	350	100	S1	S1
320	ML5184	8	19	602	223	U	U
320	ML5242	8	19	543.5	206	U	U
320	ML5243	8	19	549	232	U	U
320	ML5284	8	19	500	200	S1	U
320	ML5361	8	19	510	200	U	U
320	ML5407	8	19	700	257	U	U
320	ML5420	8	19	465	187	Y1	D
320	ML5421	6	15	367	145	Y1	X1

F1	Monroe®	Ød	ØD	Ext. L	S	C	C
320	ML5464	8	19	577	226	S1	S1
320	ML5497	8	19	670	294	Y1	D
320	ML5655	8	18.5	456	165	S1	S1
320	ML5658	8	18.5	369	110	S1	S1
320	ML5694	8	19	370	110	S1	S1
325	ML5037	8	19	700	300	U	P
325	ML5057	8	19	700	300	P	S1
325	ML5386	8	19	722	315	U	U
325	ML5849	8	18.5	526	220	U	U
330	ML5023	8	19	614	230	U	U
330	ML5063	8	19	284	100	U	U
330	ML5164	8	19	472	180	U	U
330	ML5282	8	19	630	269	U	U
330	ML5325	8	19	600	244	U	U
330	ML5342	8	19	575	235	U	U
330	ML5406	8	19	498	197	U	U
330	ML5562	8	19	313	112	S1	S1
330	ML5588	8	19	559	220	S1	S1
330	ML5611	8	19	245	76	Y1	D
330	ML5689	8	19	400	160	S1	P
330	ML5731	8	19	505	211	S1	P
330	ML5799	8	19	674	293	U	U
330	ML5804	8	19	314.5	116	U	U
330	ML5819	8	19	568	233	U	U
335	ML5708	8	19	480	195	U	U
335	ML5840	6	15	465	190	I	H
340	ML5024	8	19	450	175	U	U
340	ML5114	8	19	450	175	U	U
340	ML5146	8	19	510	210	S1	S1
340	ML5241	8	19	412	155	U	U
340	ML5398	8	18	580	245	U	U
340	ML5534	8	19	605	247	S1	U
340	ML5619	8	19	330	116	N	N
340	ML5639	8	19	254	85	Y1	D
340	ML5741	8	19	765	335	U	U
340	ML5767	8	19	500	195	S1	U
340	ML5805	8	19	479	179	P	U
340	ML5842	10	22	587	230	S1	C1
340	ML5843	10	22	587	230	S1	C2
345	ML5498	8	19	670	294	Y1	D
345	ML5499	8	19	700	295	Y1	D
350	ML5015	8	19	549	229.5	Y1	X1
350	ML5049	8	19	500	212	U	U
350	ML5053	8	19	550	212	U	U
350	ML5069	8	19	470	190	U	U
350	ML5077	8	19	591	240	U	U
350	ML5120	8	19	475	195	U	U
350	ML5211	8	19	527	210	U	U
350	ML5261	8	19	500	200	S1	U
350	ML5264	8	19	500	200	S1	U
350	ML5348	8	19	525	205	U	U
350	ML5359	8	19	513	215	U	U
350	ML5390	8	19	508	194	U	U
350	ML5451	8	19	611	205	U	U
350	ML5480	8	19	452	177	S1	S1
350	ML5563	8	19	374	140	S1	S1
350	ML5596	6	15	254	95	Y4	X1
350	ML5695	8	19	425	165	S1	U
350	ML5696	8	19	355	120	P	U
350	ML5714	8	19	386.5	150	U	P
350	ML5715	8	19	650	270	U	U
350	ML5768	8	19	721.5	315	U	U
350	ML5775	8	19	437	173	S1	S1
350	ML5785	8	19	460	170	S1	S1

EXTENSION FORCE

EXTENSION FORCE WITH EXTENDED PISTON ROD

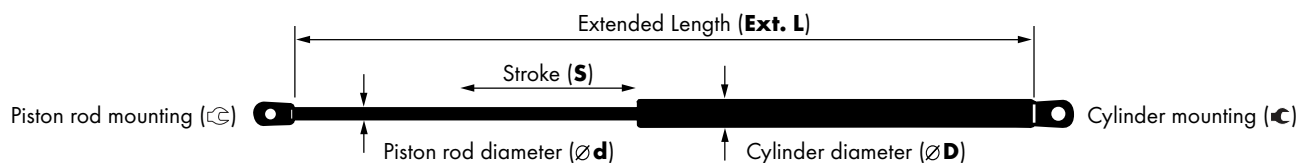
F1

F1	Monroe®	Ød	ØD	Ext. L	S	C	C
350	ML5789	8	19	345	130	U	U
355	ML5031	8	19	549	222	U	U
355	ML5369	8	19	828	249	U	U
360	ML5011	8	19	600	255	Y1	X1
360	ML5054	8	19	543.5	206	U	U
360	ML5093	8	19	471	191	S1	S1
360	ML5129	8	19	622	240	S1	S1
360	ML5144	8	19	565	216	U	U
360	ML5171	8	19	557	224	U	U
360	ML5191	8	19	585	235	U	U
360	ML5192	8	19	680	270	U	U
360	ML5360	8	19	500	190	U	U
360	ML5364	8	19	635	248	U	U
360	ML5394	8	19	600	226	U	U
360	ML5396	8	19	568	213	U	U
360	ML5434	8	19	599	220	U	U
360	ML5462	8	19	477	188	S1	S1
360	ML5488	8	19	320	100	S1	S1
360	ML5521	8	19	675	263	T1	Q
360	ML5589	8	19	671.5	270	S1	S1
360	ML5634	8	19	680	270	T1	T1
360	ML5758	8	19	726.5	310	P	U
360	ML5784	8	19	510	213	U	U
360	ML5796	8	19	463	185	S1	U
360	ML5815	8	19	600	228	U	U
360	ML5832	8	19	390	155	U	P
365	ML5199	8	19	500	200	S1	U
365	ML5259	8	19	287	99	U	U
365	ML5504	8	19	837	315	T1	T1
370	ML5068	8	19	515	202	U	U
370	ML5186	8	19	540	210	U	U
370	ML5187	8	19	540	214	U	U
370	ML5208	8	19	552	205	U	U
370	ML5210	8	19	440.5	158	U	U
370	ML5215	8	19	264	82	S1	S1
370	ML5222	8	19	440	171	S1	U
370	ML5285	8	19	595	248	U	U
370	ML5411	8	19	315	105	S1	U
370	ML5448	10	22	866	350	U	U
370	ML5490	8	19	363	132	S1	S1
370	ML5584	10	22	870	370	S1	U
370	ML5595	8	19	255	86	Y5	X3
370	ML5646	8	19	319	100	Y5	X3
370	ML5759	8	19	483	191	T1	T1
370	ML5777	8	19	430	170	U	U
375	ML5333	8	19	668	280	Y1	D
375	ML5403	8	19	668	215	U	U
375	ML5542	8	19	667	215	U	U
375	ML5752	8	19	500	208	U	U
380	ML5039	8	19	550	229.5	Y1	X2
380	ML5145	8	19	431	173	U	U
380	ML5165	8	19	455	164	U	U
380	ML5194	8	19	500	200	S1	U
380	ML5235	8	19	596	190	U	U
380	ML5281	8	19	506	200	U	U
380	ML5301	8	19	295	100	U	U
380	ML5427	8	19	471	185	S1	U
380	ML5453	8	19	460	180	U	U
380	ML5522	8	19	242	84	Y6	D
380	ML5570	8	19	490	187	S1	S1
380	ML5599	6	15	440	142	Y1	X1
380	ML5609	8	19	580	245	W	D
380	ML5678	10	22	943	417	U	L
380	ML5698	8	19	291	107	S1	U

F1	Monroe®	Ød	ØD	Ext. L	S	C	C
380	ML5712	8	19	490	200	P	U
380	ML5766	8	19	318	120	S1	S1
380	ML5803	8	19	240	70	S1	S1
380	ML5829	8	19	730	310	P	U
385	ML5672	8	19	540	210	U	U
385	ML5725	8	19	451	185	S1	S1
390	ML5001	8	19	405	160	Y1	X1
390	ML5071	8	19	405	160	Y1	D
390	ML5111	8	19	402	160	U	U
390	ML5162	8	19	664.5	275	S1	S1
390	ML5300	8	19	527	202	U	U
390	ML5395	8	19	510	208	U	U
390	ML5419	8	19	280	95	S1	S1
390	ML5508	8	19	680	270	T1	T1
390	ML5573	8	19	640	235	U	D
390	ML5763	8	19	540	225	T1	T1
390	ML5830	8	19	375	140	U	P
400	ML5002	8	19	509	200	Y1	X1
400	ML5004	8	19	502	200	U	U
400	ML5115	8	19	500	200	U	U
400	ML5188	8	19	540	214	U	U
400	ML5196	8	19	500	200	S1	U
400	ML5201	8	19	577	226	U	U
400	ML5272	8	19	522	210	U	U
400	ML5286	8	19	591	239	U	U
400	ML5371	8	19	499	195	U	U
400	ML5432	8	19	624	260	S1	S1
400	ML5435	8	19	656	260	S1	S1
400	ML5494	8	19	700	295	Y1	D
400	ML5593	8	19	615	260	Y1	D
400	ML5615	8	19	502	195	U	P
400	ML5643	6	15	244	90	S1	S1
400	ML5691	8	19	412	163	S1	U
400	ML5713	8	19	515	215	U	U
400	ML5729	8	19	310	110	U	U
405	ML5665	8	19	585.5	245	U	U
410	ML5012	8	19	600	245	U	U
410	ML5161	8	19	534	216	U	U
410	ML5174	8	19	534	216	U	U
410	ML5182	8	19	300	100	S1	S1
410	ML5209	8	19	552	200	U	U
410	ML5244	8	19	549	232	U	U
410	ML5317	8	19	590	215	U	U
410	ML5444	8	19	365	140	Y1	D
410	ML5541	8	19	568	215	S1	S1
410	ML5749	8	19	530	210	U	P
410	ML5809	8	19	536	204	S1	S1
415	ML5200	8	19	577	226	U	U
420	ML5005	8	19	509	200	U	U
420	ML5048	8	19	527	219	U	U
420	ML5051	10	22	726	280	S1	E1
420	ML5078	8	19	507	205	S1	S1
420	ML5087	8	19	473	172	U	U
420	ML5151	8	19	445	162	U	U
420	ML5197	8	19	500	205	S1	U
420	ML5237	8	19	596	190	U	U
420	ML5254	8	19	476.5	184	U	U
420	ML5321	8	19	315	100	U	U
420	ML5370	8	19	500	200	U	U
420	ML5400	8	19	570	230	U	U
420	ML5417	8	19	275	90	S1	S1
420	ML5436	8	19	517	190	S1	S1
420	ML5467	8	19	280	80	S1	S1
420	ML5481	8	19	270	75	S1	S1

EXTENSION FORCE WITH EXTENDED PISTON ROD

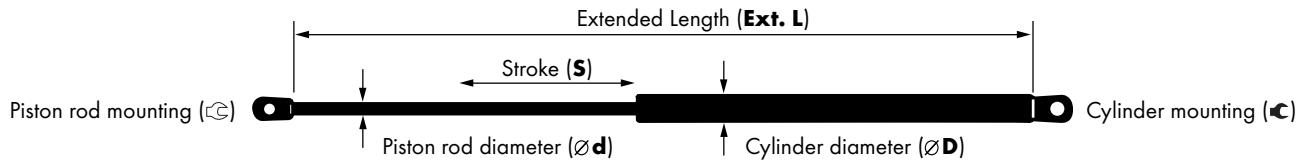
F1

F1	Monroe®	Ød	ØD	Ext. L	S	C	C
420	ML5566	8	19	254	90	Y1	D
420	ML5664	8	19	585	240	U	U
420	ML5703	8	19	480	190	P	U
420	ML5754	8	19	528	212	U	P
420	ML5776	8	19	495	197	U	P
420	ML5779	8	19	445	160	U	U
425	ML5158	8	19	465	178	U	U
425	ML5172	8	19	557	224	U	U
425	ML5206	8	19	599	190	U	U
425	ML5405	8	19	516	205	U	U
425	ML5474	8	19	535	220	S1	S1
425	ML5668	8	19	545	195	S1	U
425	ML5764	8	19	252	85	U	U
430	ML5065	8	19	600	245	U	U
430	ML5107	8	19	602	252	U	U
430	ML5160	8	19	458	176	S1	S1
430	ML5166	8	19	536.5	205	U	U
430	ML5236	8	19	596	195	U	U
430	ML5274	8	19	278	90	U	U
430	ML5299	8	19	602	252	U	U
430	ML5355	8	19	310	95	U	U
430	ML5367	8	19	567.5	183	U	U
430	ML5618	8	19	505	180	N	N
430	ML5717	8	19	497	200	P	U
435	ML5296	8	19	520	197	U	U
435	ML5701	8	19	590	176	S1	U
436	ML5362	8	19	507	208	U	U
440	ML5207	8	19	600	190	U	U
440	ML5252	8	19	544	210	U	U
440	ML5391	8	19	510	208	U	U
440	ML5458	8	19	631	230	U	U
440	ML5482	8	19	575	230	S1	S1
440	ML5485	8	19	468	163	S1	U
440	ML5680	8	19	365.5	130	U	U
440	ML5681	8	19	495	205	U	U
440	ML5706	8	19	395	158	P	U
440	ML5740	8	19	315	120	S1	U
440	ML5795	8	19	628	272	U	U
445	ML5410	8	19	515	200	S1	S1
450	ML5044	8	19	527	219	U	U
450	ML5061	8	19	527	210	U	U
450	ML5067	8	19	600	255	Y1	X1
450	ML5090	8	19	450	180	U	U
450	ML5157	10	22	540	200	U	U
450	ML5169	8	19	527	200	U	U
450	ML5181	8	19	500	200	S1	U
450	ML5213	8	19	540	200	S1	S1
450	ML5262	8	19	595	250	U	U
450	ML5307	8	19	485	189	U	U
450	ML5318	8	19	590	215	U	U
450	ML5320	8	19	600	225	U	U
450	ML5326	8	19	566	230	U	U
450	ML5353	8	19	555	220	U	U
450	ML5418	8	19	645.5	275	U	U
450	ML5544	8	19	596	210	U	S1
450	ML5617	8	19	268	83.5	N	N
450	ML5663	8	18.5	283	101.5	U	U
450	ML5669	8	19	424.5	165	U	U
450	ML5692	8	19	545	210	U	U
455	ML5851	8	18.5	631	265	S1	S1
460	ML5108	8	19	450	170	U	U
460	ML5214	8	19	517	200	S1	S1
460	ML5216	8	19	264	82	S1	S1
460	ML5248	10	22	567	225	U	U

F1	Monroe®	Ød	ØD	Ext. L	S	C	C
460	ML5280	8	19	441.5	169	U	U
460	ML5288	8	19	570	230	U	U
460	ML5293	8	19	485	196	U	U
460	ML5459	8	19	485	193	S1	S1
460	ML5578	8	19	650	250	U	U
460	ML5642	8	19	550	200	T1	T1
460	ML5662	8	19	590	245	U	U
460	ML5673	8	19	582	203	U	U
460	ML5677	8	19	499	205	Y1	T1
460	ML5718	10	22	547	220	U	U
460	ML5736	8	19	404.5	163	S1	U
465	ML5322	8	19	315	100	U	U
465	ML5466	8	19	280	80	S1	S1
465	ML5836	8	19	639	258	T1	T1
470	ML5088	8	19	645	202.6	E2	E3
470	ML5089	8	19	645	202.6	E2	E3
470	ML5185	8	19	500	205	S1	U
470	ML5198	8	19	500	193	S1	U
470	ML5217	8	19	493	196	U	U
470	ML5225	8	19	500	200	S1	U
470	ML5279	8	19	595	210	S1	U
470	ML5311	8	19	640	190	U	U
470	ML5402	8	19	570	240	U	U
470	ML5428	8	19	580	247	S1	S1
470	ML5468	8	19	512	200	S1	S1
470	ML5473	8	19	395	150	S1	S1
470	ML5500	8	19	430	160	S1	S1
470	ML5661	8	19	440	170	U	U
470	ML5727	8	19	320	105	U	U
475	ML5373	8	19	548	213	U	U
475	ML5374	8	19	556	225	U	U
475	ML5571	8	19	550	222	T1	T1
475	ML5582	10	22	769	247	U	U
480	ML5043	8	19	490	180	Y1	X1
480	ML5073	8	19	501	207	Y1	X1
480	ML5100	8	19	500	204	S1	S1
480	ML5167	8	19	535	215	U	U
480	ML5170	8	19	295	80	U	U
480	ML5273	8	19	278	90	U	U
480	ML5295	8	19	678	282	U	U
480	ML5324	8	19	590	220	U	U
480	ML5349	8	19	525	210	U	U
480	ML5388	8	19	565	215	U	U
480	ML5414	8	19	438	170	S1	S1
480	ML5430	8	19	590.5	245	U	U
480	ML5440	8	19	534.5	220	S1	S1
480	ML5445	8	19	365	140	Y1	D
480	ML5526	8	19	180	55	S1	Z
480	ML5654	8	18.5	657	275	P	U
480	ML5667	8	19	490.5	200	U	U
480	ML5702	8	19	470	185	P	S1
480	ML5723	8	19	405	160	S1	S1
485	ML5152	8	19	595	212	U	U
485	ML5173	8	19	555	228	U	U
485	ML5231	8	19	535	198	U	U
490	ML5135	8	19	279	95	U	U
490	ML5308	8	21	450	170	U	U
490	ML5354	8	19	570	230	U	U
490	ML5378	8	19	545	210	U	S1
490	ML5460	8	19	494	185	S1	S1
490	ML5478	8	19	515	200	S1	S1
490	ML5622	8	19	515	200	S1	S1
490	ML5684	8	19	515	190	U	U
490	ML5711	8	19	515	210	U	U

EXTENSION FORCE

EXTENSION FORCE WITH EXTENDED PISTON ROD

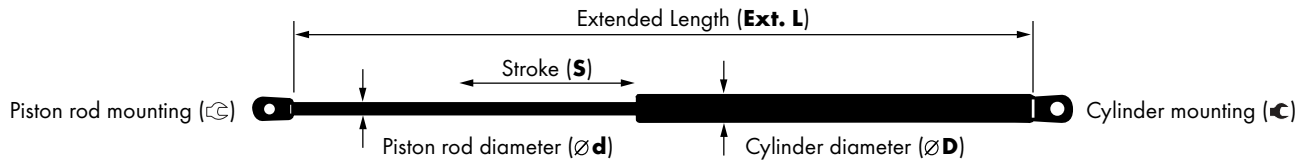
F1

F1	Monroe®	Ød	ØD	Ext. L	S	C	C
490	ML5732	8	19	505	195	S1	S1
490	ML5802	8	19	418	163	U	U
495	ML5109	8	19	544	207	U	U
500	ML5007	8	19	405	160	Y1	X1
500	ML5019	8	19	600	250	Y1	X1
500	ML5060	8	19	405	160	Y1	X1
500	ML5070	8	19	405	160	Y1	D
500	ML5074	10	22	798	350	F1	Y3
500	ML5080	8	19	495	192	U	U
500	ML5094	8	19	500	204	U	U
500	ML5096	8	19	447	172	U	U
500	ML5123	8	19	515	210	S1	S1
500	ML5124	8	19	515	195	U	U
500	ML5132	8	19	502	205	S1	U
500	ML5138	8	19	566	204	U	U
500	ML5154	8	19	298	83	U	U
500	ML5212	8	19	417	155	U	U
500	ML5218	8	19	495	198	U	U
500	ML5289	8	19	556	205	U	U
500	ML5290	8	19	256	85	U	U
500	ML5372	8	19	546	215	U	U
500	ML5375	8	19	568	230	U	U
500	ML5437	8	19	575	220	S1	U
500	ML5483	8	19	280	95	S1	S1
500	ML5507	8	19	433	165	T1	T1
500	ML5531	8	19	280	90	S1	T1
500	ML5765	8	19	565	220	T1	T1
500	ML5782	8	19	558	235	T1	T1
500	ML5838	8	19	494	172	P	P
510	ML5352	8	19	268	78	U	U
510	ML5503	8	19	600	230	T1	T1
510	ML5530	8	19	640	260	U	P
510	ML5545	8	19	596	210	U	S1
510	ML5683	8	19	580	201	U	U
510	ML5719	8	19	475	175	U	P
510	ML5786	8	19	280	90	U	U
510	ML5845	8	18.5	419	165	U	U
515	ML5126	8	19	554	200	S1	U
515	ML5130	8	19	596.5	212	U	U
515	ML5219	8	19	495	182	U	U
515	ML5724	8	19	533	200	S1	S1
520	ML5064	8	19	527	219	U	U
520	ML5122	8	19	570	232	U	U
520	ML5155	8	19	440	160	U	U
520	ML5232	8	19	535	198	U	U
520	ML5256	8	19	505	190	U	U
520	ML5277	8	19	405	150	U	U
520	ML5278	8	19	570	240	U	U
520	ML5294	8	19	485	196	U	U
520	ML5341	8	19	263	80	U	U
520	ML5377	8	19	507	203	U	S1
520	ML5401	8	19	570	230	U	U
520	ML5408	8	19	511	199	U	U
520	ML5439	8	19	279	95	U	U
520	ML5520	8	19	335	95	S1	Q
520	ML5590	8	19	334	100	S1	Q
525	ML5774	8	19	500	200	T1	P
530	ML5032	8	19	473	188	U	U
530	ML5193	8	19	279	90	U	U
530	ML5227	8	19	502	200	S1	S1
530	ML5328	10	22	775	322	U	U
530	ML5338	8	19	570	215	U	U
530	ML5379	8	19	545	210	U	S1
530	ML5416	8	19	481.5	199	U	U

F1	Monroe®	Ød	ØD	Ext. L	S	C	C
530	ML5476	8	19	574.5	230	S1	S1
530	ML5579	8	19	523	202	S1	S1
530	ML5621	10	22	775	322	U	U
530	ML5690	8	19	530	175	S1	S1
530	ML5747	8	19	490	198	T1	T1
530	ML5801	8	19	415	160	U	U
530	ML5824	8	19	558	235	S1	S1
535	ML5189	8	19	513	207	S1	S1
535	ML5438	8	19	459.5	180	S1	S1
535	ML5469	8	19	581.5	210	S1	S1
535	ML5742	8	19	450	180	S1	U
540	ML5119	8	19	540	196	U	U
540	ML5384	8	19	606.5	230	U	S1
540	ML5424	8	19	567	193	U	S1
540	ML5501	8	19	600	250	Y2	D
540	ML5549	8	19	270	90	T1	D
540	ML5592	8	19	498	225	S1	S1
540	ML5610	8	19	600	250	Y2	D
540	ML5633	8	19	268	90	Y1	D
540	ML5704	8	19	378	145	T1	T1
540	ML5757	8	19	473	182	U	U
540	ML5835	10	22	699	257	M	O
545	ML5641	8	19	511.5	172	S1	S1
545	ML5666	8	19	531	173	U	U
550	ML5045	8	19	405	160	U	U
550	ML5168	8	19	512	200	U	U
550	ML5177	8	19	515	210	U	U
550	ML5178	8	19	507	207	U	U
550	ML5203	8	19	600	215	U	U
550	ML5220	8	19	495	182	U	U
550	ML5381	8	19	557	215	U	S1
550	ML5558	8	19	280	90	U	T1
550	ML5644	8	19	515	215	T1	D
550	ML5653	8	18.5	439.5	157	S1	U
550	ML5699	8	19	445	183	P	S1
550	ML5710	8	19	299	109	U	U
550	ML5761	8	19	305	105	U	U
550	ML5792	8	19	480	200	U	P
550	ML5793	8	19	315	100	S1	S1
550	ML5828	8	19	547	220	U	P
550	ML5831	8	19	450	180	U	S1
555	ML5351	8	19	357	128	U	U
560	ML5082	8	19	469.5	171	U	U
560	ML5176	8	19	552	200	S1	U
560	ML5302	8	19	385	138	U	U
560	ML5305	8	19	610	200	U	U
560	ML5397	8	19	568	230	U	U
560	ML5412	8	19	565	210	S1	U
560	ML5502	8	19	300	99	S1	S1
560	ML5535	8	19	241	70	Y1	T1
560	ML5585	10	22	613.5	248	O	O
560	ML5627	8	19	610	200	U	U
560	ML5794	8	19	462.5	190	T1	T1
560	ML5808	8	19	256	58	S1	S1
560	ML5818	8	19	282	98	U	U
565	ML5221	8	19	495	182	U	U
565	ML5253	8	19	496.5	192	U	U
565	ML5647	8	19	485	200	P	S1
570	ML5086	8	19	526	207	S1	S1
570	ML5258	8	19	471	184	U	U
570	ML5283	8	19	627	230	U	U
570	ML5304	8	19	627	230	U	U
570	ML5346	8	19	571	208	U	U
570	ML5505	8	19	630	220	T1	T1

EXTENSION FORCE WITH EXTENDED PISTON ROD

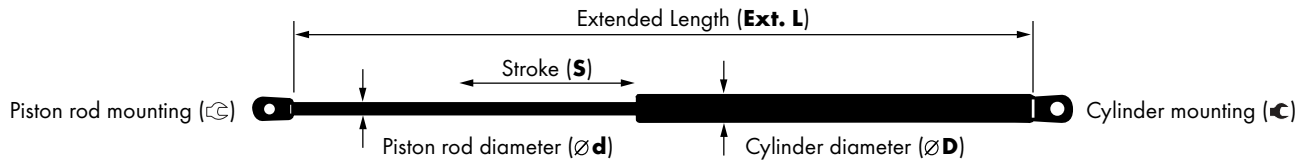
F1

F1	Monroe®	Ød	ØD	Ext. L	S	C	C
570	ML5626	8	19	627	230	U	U
570	ML5721	8	19	474	190	U	U
570	ML5847	10	22	610	240	B2	A2
570	ML5848	10	22	610	240	B1	A1
575	ML5205	8	19	625	253	U	U
580	ML5263	8	19	319	110	S1	S1
580	ML5335	8	19	310	110	S1	S1
580	ML5376	8	19	280	90	U	S1
580	ML5554	10	22	573.5	215	U	T1
580	ML5569	8	19	485	185	S1	S1
585	ML5190	8	19	513	207	S1	S1
585	ML5233	8	19	535	198	U	U
585	ML5486	8	19	434	153	S1	S1
585	ML5632	8	19	486	170	Y1	D
585	ML5760	8	19	515	196	P	U
585	ML5772	8	19	539	218	T1	P
590	ML5137	8	19	542	193	U	U
590	ML5141	10	22	567	221	U	U
590	ML5310	8	19	310	89	U	U
590	ML5343	8	19	448	180	U	U
590	ML5383	8	19	473.5	170	U	S1
590	ML5413	8	19	472	175	S1	U
590	ML5693	8	19	625	210	P	S1
590	ML5844	8	18.5	310	110	U	U
595	ML5291	8	19	501	175	U	U
600	ML5008	8	19	365	140	Y1	X1
600	ML5075	8	19	405	160	Y1	D
600	ML5121	8	19	450	175	S1	S1
600	ML5125	8	19	508	195	U	U
600	ML5156	8	19	508	195	U	U
600	ML5175	8	19	440	169	U	U
600	ML5204	8	19	600	215	U	U
600	ML5257	8	19	470	182	U	U
600	ML5363	8	19	632	215	U	U
600	ML5425	8	19	491	205	U	U
600	ML5455	8	19	632	215	U	U
600	ML5456	8	19	610	200	U	U
600	ML5487	8	19	298	90	S1	S1
600	ML5532	8	19	280	90	S1	T1
600	ML5594	8	19	255	86	Y5	X3
600	ML5613	8	19	500	201	Y1	D
600	ML5682	8	19	420	162	U	U
600	ML5748	8	19	255	85	S1	U
600	ML5778	8	19	285	105	S1	U
610	ML5106	8	19	514.5	217	U	D
610	ML5260	8	19	293	80	U	U
610	ML5334	8	19	549.5	200	U	U
610	ML5380	8	19	485	187	U	S1
610	ML5495	8	19	490	195	U	U
610	ML5528	10	22	697	257	M	O
610	ML5722	10	22	505	205	U	U
610	ML5834	10	22	699	257	M	O
615	ML5728	8	19	375	145	U	U
620	ML5103	8	19	510	202	U	U
620	ML5303	8	19	365	135	S1	S1
620	ML5442	8	19	348	120	U	U
620	ML5449	8	19	405	160	U	U
620	ML5477	8	19	574.5	230	S1	S1
620	ML5527	10	22	613.5	248	O	O
620	ML5707	8	19	545	210	U	U
630	ML5104	8	19	280	95.5	U	S1
630	ML5128	10	22	690	280	S1	S1
630	ML5234	10	22	278	90	U	U
630	ML5329	10	22	772	322	U	U

F1	Monroe®	Ød	ØD	Ext. L	S	C	C
630	ML5431	8	19	256	85	U	U
630	ML5454	8	19	627	230	U	U
630	ML5616	8	19	570	200	S1	U
630	ML5753	8	19	470	160	U	U
630	ML5837	8	19	690	300	T1	T1
635	ML5110	8	19	500	170	U	U
635	ML5238	8	19	500	190	S1	P
635	ML5240	10	22	500	200	P	P
635	ML5770	8	19	605	242	P	P
640	ML5332	8	19	485	165	U	U
640	ML5475	8	19	520	175	U	U
640	ML5523	8	19	310	90	S1	Q
640	ML5543	8	19	695	272	U	U
640	ML5586	10	22	613.5	248	O	O
640	ML5688	8	19	288	104	S1	S1
640	ML5773	8	19	475	195	U	U
650	ML5142	10	22	567	221	U	U
650	ML5223	10	22	298	95	U	U
650	ML5553	10	22	310	89	U	U
650	ML5635	8	19	500	195	Y1	D
650	ML5686	8	19	165	40	U	U
650	ML5746	8	19	475	184	U	P
650	ML5800	8	19	333	117	U	U
650	ML5816	10	22	570	240	T1	T1
655	ML5224	10	22	465	140	U	U
660	ML5246	10	22	569	240	U	U
660	ML5330	10	22	250	74	U	U
660	ML5423	10	22	520	180	U	U
660	ML5446	10	22	382	140	T1	T1
660	ML5513	10	22	382	140	T1	T1
660	ML5581	10	22	527	200	U	U
660	ML5671	8	19	627	205	U	U
665	ML5433	10	22	520	180	U	U
670	ML5113	8	19	700	300	T1	T1
670	ML5514	10	22	850	340	U	U
670	ML5533	10	22	272	90	T1	T1
670	ML5555	10	22	573.5	215	U	T1
680	ML5524	10	22	273	92	T1	T1
690	ML5226	10	22	260	89	U	S1
690	ML5239	10	22	500	195	P	U
690	ML5511	10	22	483	175	U	U
690	ML5512	10	22	480	173	U	U
700	ML5336	10	22	333	100	S1	S1
700	ML5415	10	22	455	127	U	U
700	ML5518	10	22	730	200	U	U
700	ML5675	10	22	175	45	U	U
700	ML5745	10	22	298	80	U	U
700	ML5811	8	19	323	103	U	U
700	ML5817	10	22	482	185.5	P	U
710	ML5249	10	22	685	250	U	U
710	ML5557	10	22	492	188	U	U
710	ML5751	10	22	300	70	T1	T1
710	ML5781	10	22	535	183	U	S1
710	ML5787	10	22	550	160	T1	T1
715	ML5797	10	22	556	224	T1	T1
720	ML5525	10	22	273	92	T1	T1
720	ML5539	10	22	489	144	U	U
720	ML5769	10	22	285	100	U	S1
725	ML5709	10	22	736.5	310	U	U
725	ML5806	10	22	560	178	U	P
730	ML5228	10	22	560	210	U	U
730	ML5516	10	22	905	307	T1	T1
730	ML5550	10	22	905	307	T1	T1
730	ML5580	10	22	520	185	U	U

EXTENSION FORCE

EXTENSION FORCE WITH EXTENDED PISTON ROD

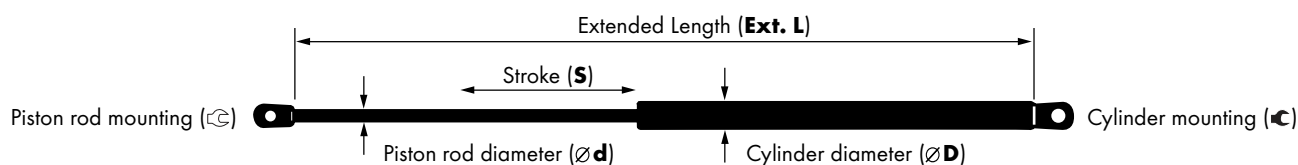
F1

F1	Monroe®	Ød	ØD	Ext. L	S	C	C
730	ML5744	10	22	298	80	U	U
740	ML5331	10	22	450	162	U	U
740	ML5443	10	22	603	220	U	U
740	ML5510	10	22	483	175	U	U
750	ML5245	10	22	569	240	U	U
750	ML5591	10	22	545	195	U	Q
755	ML5716	10	22	667	255	U	U
760	ML5519	10	22	730	200	U	U
770	ML5118	10	22	685	255	U	U
770	ML5743	10	22	505	170	U	P
780	ML5612	10	22	501	175	U	U
780	ML5614	10	22	490	200	U	U
800	ML5229	10	22	560	210	U	U
800	ML5441	10	22	326	115	S1	S1
800	ML5540	10	22	364	130	S2	S2
800	ML5839	10	22	390	148	U	K
810	ML5429	10	22	550	235	U	U
810	ML5537	10	22	603	198	U	U
819	ML5515	10	22	722	210	U	U
820	ML5628	10	22	265	80	U	U
830	ML5127	10	22	591	200	U	U
830	ML5247	10	22	569	240	U	U
830	ML5251	10	22	685	250	P	P
850	ML5076	10	22	550	235	U	U
850	ML5085	10	22	249	67	U	U
850	ML5538	10	22	603	198	U	U
850	ML5559	10	22	235	52	U	S2
870	ML5750	10	22	720	280	U	U
910	ML5105	10	22	569	240	U	U
910	ML5250	10	22	685	250	P	P
970	ML5575	10	22	755	210	U	U
990	ML5771	10	22	574	198	P	P
1050	ML5841	8	19	700	175	U	U
1080	ML5576	10	22	755	210	U	U
1080	ML5833	10	22	755	210	U	P
1100	ML5517	10	22	195	55	U	U
1200	ML5685	14	28	320	85	M	O
1400	ML5674	14	28	325	100	S1	S1
1430	ML5852	10	22	399	86	G	G
1550	ML5637	14	28	396	108	O	O
1600	ML5529	14	28	270	70	O	M
120/180	ML5461	8	19	506	205	S1	S1
150/180	ML5268	8	19	685	285	U	U
180/240	ML5625	8	19	475	198	Y1	S1
190/250	ML5180	8	19	490	190	U	U
220/250	ML5183	8	19	445	172	U	U
220/250	ML5327	8	19	540	220	U	U
240/300	ML5601	8	19	650	275	Y1	D
240/300	ML5602	8	19	650	275	S1	D
240/300	ML5607	8	19	544	224	S1	S1
250/310	ML5133	8	19	600	250	U	U
260/320	ML5255	8	19	600	250	U	U
260/320	ML5606	8	19	579	235	Y1	D
300/355	ML5149	8	19	611	230	U	U
300/360	ML5148	8	19	600	230	U	U
310/370	ML5603	8	19	650	275	Y1	D
310/370	ML5605	8	19	650	275	S1	D
340/400	ML5631	8	19	677	274	T1	T1
350/400	ML5358	8	19	500	171	U	U
380/440	ML5202	8	19	566	230	U	U
400/440	ML5315	8	19	675	275	U	U
400/463	ML5452	8	19	653	260	U	U
450/500	ML5131	8	19	440	160	U	U
450/515	ML5150	8	19	595	250	U	U

F1	Monroe®	Ød	ØD	Ext. L	S	C	C
470/520	ML5506	8	19	540	220	T1	T1
490/530	ML5314	8	19	545	220	U	U
490/550	ML5319	8	19	558	200	U	U
495 F3	ML5652	8	18.5	375	135	J	S1
510/540	ML5344	8	19	632	230	U	U
520/560	ML5313	8	19	526	206	U	U
580 F3	ML5656	8	18.5	469.5	185	P	P
610 F3	ML5657	8	18.5	495	205	S1	S1
680/740	ML5630	10	22	431	121	S1	S1
700N	ML5426	10	22	418	148	U	U
760/860	ML5583	10	22	195	50	U	U
F3 200	ML5788	8	19	554	185	T1	T1
F3 440	ML5734	8	19	460	180	S1	S1
F3 565	ML5756	8	19	640	255	U	P
F3 595	ML5755	8	19	640	255	U	P
F3-625	ML5783	8	19	585	190	U	P
F3-625	ML5826	8	19	520	180	T1	T1

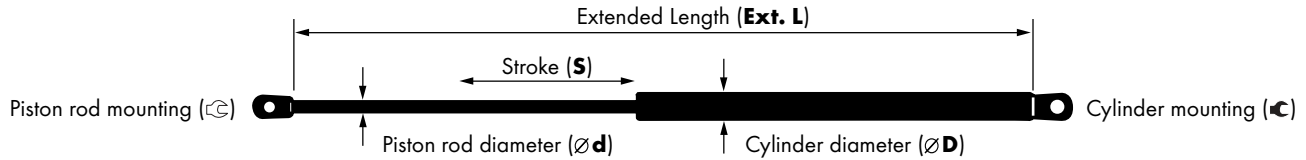

Ext. L	Monroe®	Ød	ØD	S	F1	↺	↻
165	ML5686	8	19	40	650	U	U
175	ML5675	10	22	45	700	U	U
180	ML5526	8	19	55	480	S1	Z
185	ML5546	6	15	55	100	R	R
195	ML5517	10	22	55	1100	U	U
195	ML5583	10	22	50	760/860	U	U
201	ML5791	8	19	52	250	S1	U
215	ML5389	8	19	48	200	S1	S1
225	ML5629	6	15	80	100	R	R
226	ML5496	8	19	63	100	Y1	D
235	ML5559	10	22	52	850	U	S2
238	ML5810	8	19	62	165	U	U
240	ML5404	8	19	74	300	U	U
240	ML5803	8	19	70	380	S1	S1
241	ML5535	8	19	70	560	Y1	T1
242	ML5522	8	19	84	380	Y6	D
244	ML5643	6	15	90	400	S1	S1
245	ML5611	8	19	76	330	Y1	D
249	ML5085	10	22	67	850	U	U
250	ML5330	10	22	74	660	U	U
252	ML5764	8	19	85	425	U	U
254	ML5566	8	19	90	420	Y1	D
254	ML5596	6	15	95	350	Y4	X1
254	ML5639	8	19	85	340	Y1	D
255	ML5594	8	19	86	600	Y5	X3
255	ML5595	8	19	86	370	Y5	X3
255	ML5748	8	19	85	600	S1	U
256	ML5018	8	19	86	280	Y1	X1
256	ML5030	8	19	86	180	Y1	X1
256	ML5058	8	19	86	280	Y1	X1
256	ML5290	8	19	85	500	U	U
256	ML5431	8	19	85	630	U	U
256	ML5808	8	19	58	560	S1	S1
260	ML5226	10	22	89	690	U	S1
263	ML5341	8	19	80	520	U	U
264	ML5215	8	19	82	370	S1	S1
264	ML5216	8	19	82	460	S1	S1
265	ML5628	10	22	80	820	U	U
268	ML5352	8	19	78	510	U	U
268	ML5617	8	19	83,5	450	N	N
268	ML5633	8	19	90	540	Y1	D
270	ML5481	8	19	75	420	S1	S1
270	ML5529	14	28	70	1600	O	M
270	ML5549	8	19	90	540	T1	D
272	ML5533	10	22	90	670	T1	T1
273	ML5524	10	22	92	680	T1	T1
273	ML5525	10	22	92	720	T1	T1
275	ML5417	8	19	90	420	S1	S1
278	ML5234	10	22	90	630	U	U
278	ML5273	8	19	90	480	U	U
278	ML5274	8	19	90	430	U	U
279	ML5135	8	19	95	490	U	U
279	ML5193	8	19	90	530	U	U
279	ML5439	8	19	95	520	U	U
280	ML5104	8	19	95,5	630	U	S1
280	ML5376	8	19	90	580	U	S1
280	ML5419	8	19	95	390	S1	S1
280	ML5466	8	19	80	465	S1	S1
280	ML5467	8	19	80	420	S1	S1
280	ML5483	8	19	95	500	S1	S1
280	ML5531	8	19	90	500	S1	T1
280	ML5532	8	19	90	600	S1	T1
280	ML5558	8	19	90	550	U	T1
280	ML5786	8	19	90	510	U	U

Ext. L	Monroe®	Ød	ØD	S	F1	↺	↻
282	ML5818	8	19	98	560	U	U
283	ML5663	8	18.5	101.5	450	U	U
284	ML5063	8	19	100	330	U	U
285	ML5323	8	19	95	290	U	U
285	ML5769	10	22	100	720	U	S1
285	ML5778	8	19	105	600	S1	U
286	ML5471	8	19	100	310	S1	S1
287	ML5259	8	19	99	365	U	U
288	ML5536	8	19	95	250	U	Q
288	ML5688	8	19	104	640	S1	S1
291	ML5698	8	19	107	380	S1	U
293	ML5260	8	19	80	610	U	U
295	ML5170	8	19	80	480	U	U
295	ML5301	8	19	100	380	U	U
297	ML5813	6	15	113	240	S1	S1
298	ML5154	8	19	83	500	U	U
298	ML5223	10	22	95	650	U	U
298	ML5487	8	19	90	600	S1	S1
298	ML5744	10	22	80	730	U	U
298	ML5745	10	22	80	700	U	U
299	ML5710	8	19	109	550	U	U
300	ML5182	8	19	100	410	S1	S1
300	ML5502	8	19	99	560	S1	S1
300	ML5751	10	22	70	710	T1	T1
305	ML5640	6	15	109	130	T1	T1
305	ML5761	8	19	105	550	U	U
305.5	ML5179	6	15	121	45	S1	S1
310	ML5310	8	19	89	590	U	U
310	ML5335	8	19	110	580	S1	S1
310	ML5355	8	19	95	430	U	U
310	ML5523	8	19	90	640	S1	Q
310	ML5553	10	22	89	650	U	U
310	ML5729	8	19	110	400	U	U
310	ML5844	8	18.5	110	590	U	U
313	ML5562	8	19	112	330	S1	S1
314,5	ML5804	8	19	116	330	U	U
315	ML5321	8	19	100	420	U	U
315	ML5322	8	19	100	465	U	U
315	ML5411	8	19	105	370	S1	U
315	ML5740	8	19	120	440	S1	U
315	ML5793	8	19	100	550	S1	S1
318	ML5766	8	19	120	380	S1	S1
319	ML5263	8	19	110	580	S1	S1
319	ML5646	8	19	100	370	Y5	X3
320	ML5488	8	19	100	360	S1	S1
320	ML5685	14	28	85	1200	M	O
320	ML5727	8	19	105	470	U	U
323	ML5811	8	19	103	700	U	U
324	ML5095	8	19	115	290	U	U
325	ML5674	14	28	100	1400	S1	S1
326	ML5441	10	22	115	800	S1	S1
330	ML5619	8	19	116	340	N	N
333	ML5336	10	22	100	700	S1	S1
333	ML5800	8	19	117	650	U	U
334	ML5590	8	19	100	520	S1	Q
335	ML5520	8	19	95	520	S1	Q
345	ML5789	8	19	130	350	U	U
348	ML5442	8	19	120	620	U	U
350	ML5163	8	19	100	320	S1	S1
352	ML5356	8	19	110	150	U	U
355	ML5696	8	19	120	350	P	U
357	ML5351	8	19	128	555	U	U
362	ML5017	8	19	135	190	U	X2
362	ML5823	6	15	138	100	S1	S1

EXTENDED LENGTH

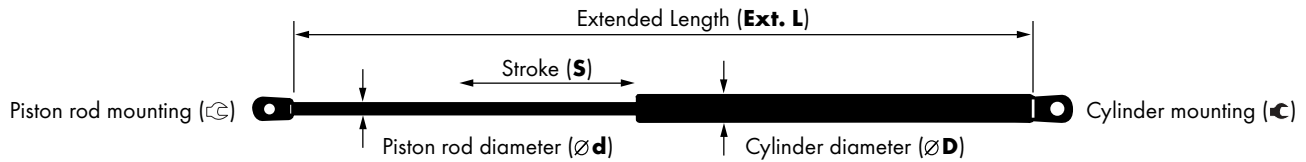

Ext. L	Monroe®	Ød	ØD	S	F1	C	C
363	ML5490	8	19	132	370	S1	S1
364	ML5489	8	19	132	310	S1	S1
364	ML5540	10	22	130	800	S2	S2
365	ML5008	8	19	140	600	Y1	X1
365	ML5303	8	19	135	620	S1	S1
365	ML5365	8	19	135	180	U	U
365	ML5366	8	19	135	240	U	U
365	ML5444	8	19	140	410	Y1	D
365	ML5445	8	19	140	480	Y1	D
365	ML5552	6	15	135	135	S1	S1
365.5	ML5680	8	19	130	440	U	U
366	ML5670	8	19	117	280	S1	S1
367	ML5421	6	15	145	320	Y1	X1
369	ML5658	8	18.5	110	320	S1	S1
370	ML5694	8	19	110	320	S1	S1
374	ML5563	8	19	140	350	S1	S1
375	ML5652	8	18.5	135	495 F3	J	S1
375	ML5728	8	19	145	615	U	U
375	ML5830	8	19	140	390	U	P
378	ML5704	8	19	145	540	T1	T1
382	ML5446	10	22	140	660	T1	T1
382	ML5513	10	22	140	660	T1	T1
385	ML5302	8	19	138	560	U	U
385	ML5762	8	19	150	140	P	U
386.5	ML5714	8	19	150	350	U	P
390	ML5832	8	19	155	360	U	P
390	ML5839	10	22	148	800	U	K
392	ML5624	8	19	150	300	P	T1
395	ML5387	8	19	148	180	U	U
395	ML5472	8	19	150	230	S1	S1
395	ML5473	8	19	150	470	S1	S1
395	ML5706	8	19	158	440	P	U
396	ML5637	14	28	108	1550	O	O
398	ML5479	8	19	120	180	S1	S1
398	ML5623	8	19	120	180	S1	S1
399	ML5852	10	22	86	1430	G	G
400	ML5392	8	19	149	300	S1	S1
400	ML5484	8	19	150	280	S1	S1
400	ML5689	8	19	160	330	S1	P
402	ML5111	8	19	160	390	U	U
404.5	ML5736	8	19	163	460	S1	U
405	ML5001	8	19	160	390	Y1	X1
405	ML5007	8	19	160	500	Y1	X1
405	ML5045	8	19	160	550	U	U
405	ML5060	8	19	160	500	Y1	X1
405	ML5070	8	19	160	500	Y1	D
405	ML5071	8	19	160	390	Y1	D
405	ML5075	8	19	160	600	Y1	D
405	ML5275	8	19	160	310	U	U
405	ML5277	8	19	150	520	U	U
405	ML5449	8	19	160	620	U	U
405	ML5649	8	19	160	300	U	U
405	ML5723	8	19	160	480	S1	S1
408	ML5316	8	19	150	310	U	U
410	ML5422	6	15	160	280	Y1	X1
412	ML5241	8	19	155	340	U	U
412	ML5691	8	19	163	400	S1	U
415	ML5801	8	19	160	530	U	U
417	ML5212	8	19	155	500	U	U
418	ML5426	10	22	148	700N	U	U
418	ML5802	8	19	163	490	U	U
419	ML5845	8	18.5	165	510	U	U
420	ML5682	8	19	162	600	U	U
424.5	ML5669	8	19	165	450	U	U

Ext. L	Monroe®	Ød	ØD	S	F1	C	C
425	ML5695	8	19	165	350	S1	U
430	ML5500	8	19	160	470	S1	S1
430	ML5777	8	19	170	370	U	U
431	ML5145	8	19	173	380	U	U
431	ML5630	10	22	121	680/740	S1	S1
433	ML5507	8	19	165	500	T1	T1
434	ML5486	8	19	153	585	S1	S1
435	ML5297	8	19	160	100	U	U
435	ML5733	6	15	180	105	S1	S1
436	ML5676	8	19	175	150	U	U
437	ML5775	8	19	173	350	S1	S1
438	ML5414	8	19	170	480	S1	S1
439.5	ML5653	8	18.5	157	550	S1	U
440	ML5117	8	19	175	175	S1	S1
440	ML5131	8	19	160	450/500	U	U
440	ML5155	8	19	160	520	U	U
440	ML5175	8	19	169	600	U	U
440	ML5222	8	19	171	370	S1	U
440	ML5382	8	19	155	300	U	S1
440	ML5599	6	15	142	380	Y1	X1
440	ML5661	8	19	170	470	U	U
440.5	ML5210	8	19	158	370	U	U
441	ML5660	8	19	175	300	P	U
441.5	ML5280	8	19	169	460	U	U
445	ML5079	8	19	180	300	U	U
445	ML5151	8	19	162	420	U	U
445	ML5183	8	19	172	220/250	U	U
445	ML5699	8	19	183	550	P	S1
445	ML5779	8	19	160	420	U	U
447	ML5096	8	19	172	500	U	U
447	ML5230	6	15	170	130	S1	S1
447	ML5814	8	19	175	300	U	U
448	ML5136	8	19	180	310	U	U
448	ML5343	8	19	180	590	U	U
450	ML5003	8	19	180	300	U	U
450	ML5024	8	19	175	340	U	U
450	ML5025	8	19	175	260	U	U
450	ML5035	8	19	175	280	U	U
450	ML5090	8	19	180	450	U	U
450	ML5108	8	19	170	460	U	U
450	ML5114	8	19	175	340	U	U
450	ML5116	8	19	175	160	U	U
450	ML5121	8	19	175	600	S1	S1
450	ML5298	8	19	175	260	U	U
450	ML5308	8	21	170	490	U	U
450	ML5331	10	22	162	740	U	U
450	ML5742	8	19	180	535	S1	U
450	ML5831	8	19	180	550	U	S1
451	ML5725	8	19	185	385	S1	S1
452	ML5480	8	19	177	350	S1	S1
455	ML5165	8	19	164	380	U	U
455	ML5415	10	22	127	700	U	U
456	ML5655	8	18.5	165	320	S1	S1
458	ML5160	8	19	176	430	S1	S1
459	ML5587	8	19	172	230	S1	S1
459.5	ML5438	8	19	180	535	S1	S1
460	ML5028	8	19	170	220	U	U
460	ML5097	8	19	170	270	U	U
460	ML5153	8	19	169	100	S1	S1
460	ML5270	8	19	160	300	U	U
460	ML5453	8	19	180	380	U	U
460	ML5734	8	19	180	F3 440	S1	S1
460	ML5785	8	19	170	350	S1	S1
462.5	ML5794	8	19	190	560	T1	T1

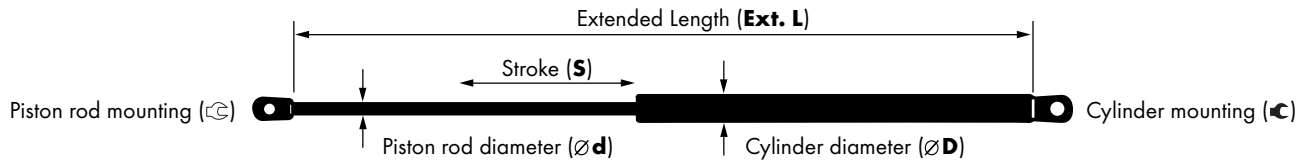

Ext. L	Monroe®	$\varnothing d$	$\varnothing D$	S	F1	C	C
463	ML5796	8	19	185	360	S1	U
464	ML5568	8	19	166	160	S1	S1
465	ML5158	8	19	178	425	U	U
465	ML5224	10	22	140	655	U	U
465	ML5420	8	19	187	320	Y1	D
465	ML5492	8	19	169	113	Y1	D
465	ML5840	6	15	190	335	I	H
468	ML5485	8	19	163	440	S1	U
469.5	ML5082	8	19	171	560	U	U
469.5	ML5656	8	18.5	185	580 F3	P	P
470	ML5069	8	19	190	350	U	U
470	ML5257	8	19	182	600	U	U
470	ML5702	8	19	185	480	P	S1
470	ML5753	8	19	160	630	U	U
471	ML5093	8	19	191	360	S1	S1
471	ML5258	8	19	184	570	U	U
471	ML5427	8	19	185	380	S1	U
472	ML5164	8	19	180	330	U	U
472	ML5413	8	19	175	590	S1	U
473	ML5032	8	19	188	530	U	U
473	ML5087	8	19	172	420	U	U
473	ML5757	8	19	182	540	U	U
473.5	ML5383	8	19	170	590	U	S1
474	ML5721	8	19	190	570	U	U
475	ML5120	8	19	195	350	U	U
475	ML5625	8	19	198	180/240	Y1	S1
475	ML5719	8	19	175	510	U	P
475	ML5746	8	19	184	650	U	P
475	ML5773	8	19	195	640	U	U
476.5	ML5254	8	19	184	420	U	U
477	ML5462	8	19	188	360	S1	S1
479	ML5805	8	19	179	340	P	U
480	ML5339	8	19	180	300	S1	U
480	ML5512	10	22	173	690	U	U
480	ML5700	8	19	173	135	U	U
480	ML5703	8	19	190	420	P	U
480	ML5708	8	19	195	335	U	U
480	ML5792	8	19	200	550	U	P
481.5	ML5416	8	19	199	530	U	U
482	ML5817	10	22	185.5	700	P	U
483	ML5510	10	22	175	740	U	U
483	ML5511	10	22	175	690	U	U
483	ML5759	8	19	191	370	T1	T1
484	ML5650	8	18.5	190	200	P	U
485	ML5293	8	19	196	460	U	U
485	ML5294	8	19	196	520	U	U
485	ML5307	8	19	189	450	U	U
485	ML5332	8	19	165	640	U	U
485	ML5380	8	19	187	610	U	S1
485	ML5459	8	19	193	460	S1	S1
485	ML5569	8	19	185	580	S1	S1
485	ML5647	8	19	200	565	P	S1
485	ML5739	8	19	200	170	U	P
486	ML5159	8	19	190	320	S1	S1
486	ML5632	8	19	170	585	Y1	D
489	ML5539	10	22	144	720	U	U
490	ML5043	8	19	180	480	Y1	X1
490	ML5180	8	19	190	190/250	U	U
490	ML5495	8	19	195	610	U	U
490	ML5570	8	19	187	380	S1	S1
490	ML5614	10	22	200	780	U	U
490	ML5712	8	19	200	380	P	U
490	ML5747	8	19	198	530	T1	T1
490.5	ML5667	8	19	200	480	U	U

Ext. L	Monroe®	$\varnothing d$	$\varnothing D$	S	F1	C	C
491	ML5425	8	19	205	600	U	U
492	ML5557	10	22	188	710	U	U
493	ML5217	8	19	196	470	U	U
494	ML5460	8	19	185	490	S1	S1
494	ML5838	8	19	172	500	P	P
495	ML5080	8	19	192	500	U	U
495	ML5218	8	19	198	500	U	U
495	ML5219	8	19	182	515	U	U
495	ML5220	8	19	182	550	U	U
495	ML5221	8	19	182	565	U	U
495	ML5657	8	18.5	205	610 F3	S1	S1
495	ML5681	8	19	205	440	U	U
495	ML5776	8	19	197	420	U	P
496	ML5098	8	19	188	270	P	P
496.5	ML5253	8	19	192	565	U	U
497	ML5717	8	19	200	430	P	U
498	ML5406	8	19	197	330	U	U
498	ML5592	8	19	225	540	S1	S1
499	ML5371	8	19	195	400	U	U
499	ML5677	8	19	205	460	Y1	T1
500	ML5038	8	19	200	280	U	U
500	ML5049	8	19	212	350	U	U
500	ML5094	8	19	204	500	U	U
500	ML5100	8	19	204	480	S1	S1
500	ML5110	8	19	170	635	U	U
500	ML5115	8	19	200	400	U	U
500	ML5181	8	19	200	450	S1	U
500	ML5185	8	19	205	470	S1	U
500	ML5194	8	19	200	380	S1	U
500	ML5195	8	19	200	280	S1	U
500	ML5196	8	19	200	400	S1	U
500	ML5197	8	19	205	420	S1	U
500	ML5198	8	19	193	470	S1	U
500	ML5199	8	19	200	365	S1	U
500	ML5225	8	19	200	470	S1	U
500	ML5238	8	19	190	635	S1	P
500	ML5239	10	22	195	690	P	U
500	ML5240	10	22	200	635	P	P
500	ML5261	8	19	200	350	S1	U
500	ML5264	8	19	200	350	S1	U
500	ML5284	8	19	200	320	S1	U
500	ML5287	8	19	200	190	S1	U
500	ML5306	8	19	196	225	U	U
500	ML5358	8	19	171	350/400	U	U
500	ML5360	8	19	190	360	U	U
500	ML5370	8	19	200	420	U	U
500	ML5491	8	19	200	310	S1	U
500	ML5572	8	19	190	220	Y1	U
500	ML5574	8	19	200	270	U	D
500	ML5600	8	19	200	230	Y1	D
500	ML5613	8	19	201	600	Y1	D
500	ML5635	8	19	195	650	Y1	D
500	ML5752	8	19	208	375	U	U
500	ML5767	8	19	195	340	S1	U
500	ML5774	8	19	200	525	T1	P
500	ML5821	8	19	203	245	S1	U
500	ML5825	8	19	230	135	S1	S1
501	ML5073	8	19	207	480	Y1	X1
501	ML5291	8	19	175	595	U	U
501	ML5612	10	22	175	780	U	U
502	ML5004	8	19	200	400	U	U
502	ML5072	8	19	200	280	U	U
502	ML5101	8	19	199	280	S1	S1
502	ML5132	8	19	205	500	S1	U

EXTENDED LENGTH

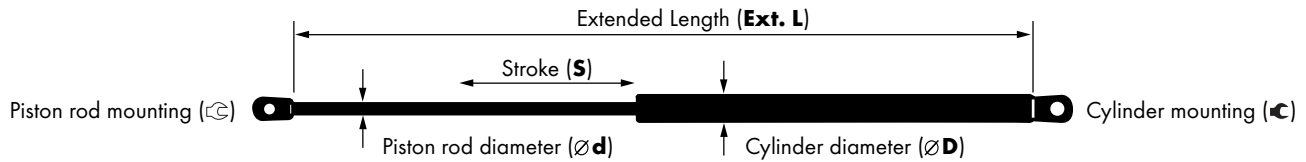

Ext. L	Monroe®	Ød	ØD	S	F1	C	C
502	ML5227	8	19	200	530	S1	S1
502	ML5547	6	15	200	125	S1	S1
502	ML5615	8	19	195	400	U	P
505	ML5256	8	19	190	520	U	U
505	ML5618	8	19	180	430	N	N
505	ML5722	10	22	205	610	U	U
505	ML5731	8	19	211	330	S1	P
505	ML5732	8	19	195	490	S1	S1
505	ML5743	10	22	170	770	U	P
506	ML5281	8	19	200	380	U	U
506	ML5461	8	19	205	120/180	S1	S1
507	ML5078	8	19	205	420	S1	S1
507	ML5178	8	19	207	550	U	U
507	ML5362	8	19	208	436	U	U
507	ML5377	8	19	203	520	U	S1
508	ML5125	8	19	195	600	U	U
508	ML5156	8	19	195	600	U	U
508	ML5390	8	19	194	350	U	U
509	ML5002	8	19	200	400	Y1	X1
509	ML5005	8	19	200	420	U	U
509	ML5047	8	19	200	220	U	U
510	ML5103	8	19	202	620	U	U
510	ML5146	8	19	210	340	S1	S1
510	ML5361	8	19	200	320	U	U
510	ML5391	8	19	208	440	U	U
510	ML5395	8	19	208	390	U	U
510	ML5784	8	19	213	360	U	U
511	ML5408	8	19	199	520	U	U
511.5	ML5641	8	19	172	545	S1	S1
512	ML5168	8	19	200	550	U	U
512	ML5468	8	19	200	470	S1	S1
512	ML5645	8	19	200	300	Y1	U
513	ML5189	8	19	207	535	S1	S1
513	ML5190	8	19	207	585	S1	S1
513	ML5359	8	19	215	350	U	U
514.5	ML5106	8	19	217	610	U	D
515	ML5068	8	19	202	370	U	U
515	ML5123	8	19	210	500	S1	S1
515	ML5124	8	19	195	500	U	U
515	ML5177	8	19	210	550	U	U
515	ML5410	8	19	200	445	S1	S1
515	ML5478	8	19	200	490	S1	S1
515	ML5622	8	19	200	490	S1	S1
515	ML5644	8	19	215	550	T1	D
515	ML5684	8	19	190	490	U	U
515	ML5711	8	19	210	490	U	U
515	ML5713	8	19	215	400	U	U
515	ML5760	8	19	196	585	P	U
516	ML5405	8	19	205	425	U	U
517	ML5214	8	19	200	460	S1	S1
517	ML5436	8	19	190	420	S1	S1
518	ML5036	8	19	209	220	Y1	X1
520	ML5056	8	19	213	230	Y1	X1
520	ML5296	8	19	197	435	U	U
520	ML5423	10	22	180	660	U	U
520	ML5433	10	22	180	665	U	U
520	ML5475	8	19	175	640	U	U
520	ML5580	10	22	185	730	U	U
520	ML5812	8	19	208	130	U	U
520	ML5826	8	19	180	F3-625	T1	T1
522	ML5271	8	19	210	300	U	U
522	ML5272	8	19	210	400	U	U
523	ML5579	8	19	202	530	S1	S1
525	ML5340	8	19	210	140	U	U

Ext. L	Monroe®	Ød	ØD	S	F1	C	C
525	ML5347	8	19	205	310	U	U
525	ML5348	8	19	205	350	U	U
525	ML5349	8	19	210	480	U	U
525	ML5350	8	19	210	240	U	U
525	ML5636	8	19	210	240	U	U
526	ML5086	8	19	207	570	S1	S1
526	ML5140	8	19	206	320	U	U
526	ML5313	8	19	206	520/560	U	U
526	ML5849	8	18.5	220	325	U	U
527	ML5044	8	19	219	450	U	U
527	ML5048	8	19	219	420	U	U
527	ML5061	8	19	210	450	U	U
527	ML5064	8	19	219	520	U	U
527	ML5169	8	19	200	450	U	U
527	ML5211	8	19	210	350	U	U
527	ML5300	8	19	202	390	U	U
527	ML5581	10	22	200	660	U	U
528	ML5026	8	19	224	160	U	U
528	ML5099	8	19	224	220	U	U
528	ML5754	8	19	212	420	U	P
529	ML5276	8	19	215	245	U	U
530	ML5548	6	15	213	110	S1	S1
530	ML5690	8	19	175	530	S1	S1
530	ML5749	8	19	210	410	U	P
531	ML5666	8	19	173	545	U	U
533	ML5724	8	19	200	515	S1	S1
534	ML5161	8	19	216	410	U	U
534	ML5174	8	19	216	410	U	U
534	ML5509	8	19	217	200	T1	T1
534.5	ML5440	8	19	220	480	S1	S1
535	ML5167	8	19	215	480	U	U
535	ML5231	8	19	198	485	U	U
535	ML5232	8	19	198	520	U	U
535	ML5233	8	19	198	585	U	U
535	ML5474	8	19	220	425	S1	S1
535	ML5560	8	19	200	280	U	U
535	ML5781	10	22	183	710	U	S1
536	ML5809	8	19	204	410	S1	S1
536.5	ML5166	8	19	205	430	U	U
538	ML5357	8	19	190	125	U	U
539	ML5772	8	19	218	585	T1	P
540	ML5119	8	19	196	540	U	U
540	ML5157	10	22	200	450	U	U
540	ML5186	8	19	210	370	U	U
540	ML5187	8	19	214	370	U	U
540	ML5188	8	19	214	400	U	U
540	ML5213	8	19	200	450	S1	S1
540	ML5327	8	19	220	220/250	U	U
540	ML5447	8	19	130	170	T1	T1
540	ML5506	8	19	220	470/520	T1	T1
540	ML5672	8	19	210	385	U	U
540	ML5763	8	19	225	390	T1	T1
542	ML5041	8	19	210	300	U	U
542	ML5137	8	19	193	590	U	U
543	ML5720	8	19	220	310	U	U
543.5	ML5054	8	19	206	360	U	U
543.5	ML5242	8	19	206	320	U	U
544	ML5109	8	19	207	495	U	U
544	ML5252	8	19	210	440	U	U
544	ML5607	8	19	224	240/300	S1	S1
544	ML5651	8	18.5	218	290	U	U
545	ML5312	8	19	230	300	U	U
545	ML5314	8	19	220	490/530	U	U
545	ML5378	8	19	210	490	U	S1

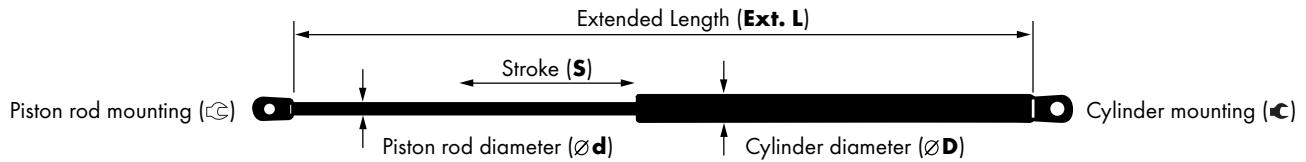

Ext. L	Monroe®	Ød	ØD	S	F1	C	C
545	ML5379	8	19	210	530	U	S1
545	ML5591	10	22	195	750	U	Q
545	ML5668	8	19	195	425	S1	U
545	ML5692	8	19	210	450	U	U
545	ML5707	8	19	210	620	U	U
546	ML5372	8	19	215	500	U	U
546	ML5457	8	19	225	220	U	U
547	ML5551	6	15	190	170	S1	S1
547	ML5556	6	15	214	225	Y1	X1
547	ML5597	8	19	230	230	U	X1
547	ML5718	10	22	220	460	U	U
547	ML5828	8	19	220	550	U	P
548	ML5373	8	19	213	475	U	U
549	ML5015	8	19	229.5	350	Y1	X1
549	ML5016	8	19	229.5	240	Y1	X2
549	ML5031	8	19	222	355	U	U
549	ML5243	8	19	232	320	U	U
549	ML5244	8	19	232	410	U	U
549.5	ML5055	8	19	229.5	160	Y1	X1
549.5	ML5334	8	19	200	610	U	U
550	ML5006	8	19	212	230	Y2	X2
550	ML5039	8	19	229.5	380	Y1	X2
550	ML5053	8	19	212	350	U	U
550	ML5059	8	19	212	270	Y2	X2
550	ML5076	10	22	235	850	U	U
550	ML5292	8	19	220	285	U	U
550	ML5429	10	22	235	810	U	U
550	ML5571	8	19	222	475	T1	T1
550	ML5642	8	19	200	460	T1	T1
550	ML5780	8	19	235	280	T1	T1
550	ML5787	10	22	160	710	T1	T1
552	ML5176	8	19	200	560	S1	U
552	ML5208	8	19	205	370	U	U
552	ML5209	8	19	200	410	U	U
553	ML5659	8	18.5	225	220	S1	S1
554	ML5126	8	19	200	515	S1	U
554	ML5788	8	19	185	F3 200	T1	T1
555	ML5173	8	19	228	485	U	U
555	ML5353	8	19	220	450	U	U
555	ML5687	8	19	228	305	U	U
556	ML5289	8	19	205	500	U	U
556	ML5374	8	19	225	475	U	U
556	ML5797	10	22	224	715	T1	T1
557	ML5171	8	19	224	360	U	U
557	ML5172	8	19	224	425	U	U
557	ML5381	8	19	215	550	U	S1
557	ML5493	8	19	200	135	Y1	D
558	ML5319	8	19	200	490/550	U	U
558	ML5782	8	19	235	500	T1	T1
558	ML5824	8	19	235	530	S1	S1
559	ML5588	8	19	220	330	S1	S1
559	ML5850	8	18.5	230	290	S1	S1
560	ML5228	10	22	210	730	U	U
560	ML5229	10	22	210	800	U	U
560	ML5806	10	22	178	725	U	P
565	ML5144	8	19	216	360	U	U
565	ML5388	8	19	215	480	U	U
565	ML5412	8	19	210	560	S1	U
565	ML5705	8	19	240	290	S1	U
565	ML5730	8	19	215	315	U	U
565	ML5765	8	19	220	500	T1	T1
566	ML5138	8	19	204	500	U	U
566	ML5202	8	19	230	380/440	U	U
566	ML5326	8	19	230	450	U	U

Ext. L	Monroe®	Ød	ØD	S	F1	C	C
566.5	ML5112	8	19	219	280	U	U
567	ML5141	10	22	221	590	U	U
567	ML5142	10	22	221	650	U	U
567	ML5248	10	22	225	460	U	U
567	ML5424	8	19	193	540	U	S1
567.5	ML5367	8	19	183	430	U	U
568	ML5375	8	19	230	500	U	U
568	ML5396	8	19	213	360	U	U
568	ML5397	8	19	230	560	U	U
568	ML5541	8	19	215	410	S1	S1
568	ML5819	8	19	233	330	U	U
569	ML5040	8	19	220	280	U	U
569	ML5050	8	19	220	280	U	U
569	ML5081	8	19	242	210	U	U
569	ML5105	10	22	240	910	U	U
569	ML5245	10	22	240	750	U	U
569	ML5246	10	22	240	660	U	U
569	ML5247	10	22	240	830	U	U
570	ML5122	8	19	232	520	U	U
570	ML5278	8	19	240	520	U	U
570	ML5288	8	19	230	460	U	U
570	ML5338	8	19	215	530	U	U
570	ML5354	8	19	230	490	U	U
570	ML5399	8	19	230	215	U	U
570	ML5400	8	19	230	420	U	U
570	ML5401	8	19	230	520	U	U
570	ML5402	8	19	240	470	U	U
570	ML5577	8	19	200	280	U	P
570	ML5616	8	19	200	630	S1	U
570	ML5816	10	22	240	650	T1	T1
571	ML5346	8	19	208	570	U	U
573.5	ML5554	10	22	215	580	U	T1
573.5	ML5555	10	22	215	670	U	T1
574	ML5143	8	19	235	260	U	U
574	ML5147	8	19	235	310	U	U
574	ML5771	10	22	198	990	P	P
574.5	ML5476	8	19	230	530	S1	S1
574.5	ML5477	8	19	230	620	S1	S1
575	ML5342	8	19	235	330	U	U
575	ML5437	8	19	220	500	S1	U
575	ML5482	8	19	230	440	S1	S1
577	ML5200	8	19	226	415	U	U
577	ML5201	8	19	226	400	U	U
577	ML5463	8	19	226	275	S1	S1
577	ML5464	8	19	226	320	S1	S1
577	ML5564	8	19	225	270	U	P
579	ML5606	8	19	235	260/320	Y1	D
580	ML5398	8	18	245	340	U	U
580	ML5428	8	19	247	470	S1	S1
580	ML5609	8	19	245	380	W	D
580	ML5620	8	19	205	230	U	U
580	ML5683	8	19	201	510	U	U
580	ML5822	8	19	245	165	S1	S1
581.5	ML5469	8	19	210	535	S1	S1
582	ML5673	8	19	203	460	U	U
584	ML5014	8	19	234	280	U	U
584	ML5066	8	19	234	290	U	U
584	ML5083	8	19	250	200	U	U
585	ML5034	8	19	250	200	Y1	X1
585	ML5134	8	19	222	280	U	U
585	ML5191	8	19	235	360	U	U
585	ML5265	8	19	235	250	U	U
585	ML5664	8	19	240	420	U	U
585	ML5783	8	19	190	F3-625	U	P

EXTENDED LENGTH

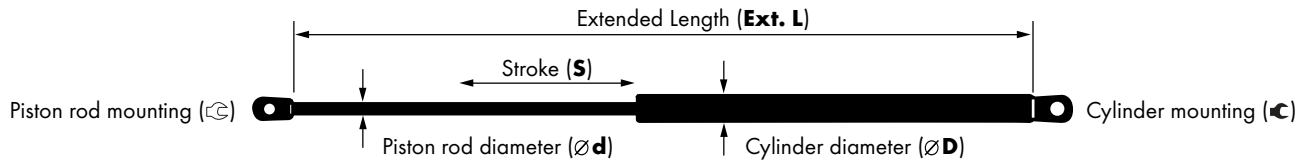

Ext. L	Monroe®	Ød	ØD	S	F1	C	C
585.5	ML5665	8	19	245	405	U	U
586	ML5027	8	19	236	280	U	U
586	ML5062	8	19	236	200	U	U
587	ML5842	10	22	230	340	S1	C1
587	ML5843	10	22	230	340	S1	C2
589	ML5029	8	19	239	310	U	U
590	ML5317	8	19	215	410	U	U
590	ML5318	8	19	215	450	U	U
590	ML5324	8	19	220	480	U	U
590	ML5662	8	19	245	460	U	U
590	ML5701	8	19	176	435	S1	U
590,5	ML5430	8	19	245	480	U	U
591	ML5077	8	19	240	350	U	U
591	ML5127	10	22	200	830	U	U
591	ML5286	8	19	239	400	U	U
595	ML5013	8	19	235	280	U	U
595	ML5150	8	19	250	450/515	U	U
595	ML5152	8	19	212	485	U	U
595	ML5262	8	19	250	450	U	U
595	ML5279	8	19	210	470	S1	U
595	ML5285	8	19	248	370	U	U
596	ML5235	8	19	190	380	U	U
596	ML5236	8	19	195	430	U	U
596	ML5237	8	19	190	420	U	U
596	ML5544	8	19	210	450	U	S1
596	ML5545	8	19	210	510	U	S1
596.5	ML5130	8	19	212	515	U	U
599	ML5206	8	19	190	425	U	U
599	ML5434	8	19	220	360	U	U
600	ML5009	8	19	255	180	Y1	X1
600	ML5010	8	19	255	200	Y1	X1
600	ML5011	8	19	255	360	Y1	X1
600	ML5012	8	19	245	410	U	U
600	ML5019	8	19	250	500	Y1	X1
600	ML5020	8	19	230	290	U	U
600	ML5033	8	19	250	320	U	U
600	ML5042	8	19	255	310	Y1	X1
600	ML5065	8	19	245	430	U	U
600	ML5067	8	19	255	450	Y1	X1
600	ML5133	8	19	250	250/310	U	U
600	ML5148	8	19	230	300/360	U	U
600	ML5203	8	19	215	550	U	U
600	ML5204	8	19	215	600	U	U
600	ML5207	8	19	190	440	U	U
600	ML5255	8	19	250	260/320	U	U
600	ML5320	8	19	225	450	U	U
600	ML5325	8	19	244	330	U	U
600	ML5394	8	19	226	360	U	U
600	ML5501	8	19	250	540	Y2	D
600	ML5503	8	19	230	510	T1	T1
600	ML5598	8	19	250	160	S1	S1
600	ML5610	8	19	250	540	Y2	D
600	ML5815	8	19	228	360	U	U
602	ML5107	8	19	252	430	U	U
602	ML5139	8	19	250	160	S1	S1
602	ML5184	8	19	223	320	U	U
602	ML5299	8	19	252	430	U	U
603	ML5443	10	22	220	740	U	U
603	ML5537	10	22	198	810	U	U
603	ML5538	10	22	198	850	U	U
603	ML5827	8	19	255	240	U	U
604	ML5697	8	19	253	250	U	U
605	ML5534	8	19	247	340	S1	U
605	ML5770	8	19	242	635	P	P

Ext. L	Monroe®	Ød	ØD	S	F1	C	C
606.5	ML5384	8	19	230	540	U	S1
609,5	ML5807	8	19	251,5	245	U	U
610	ML5305	8	19	200	560	U	U
610	ML5456	8	19	200	600	U	U
610	ML5627	8	19	200	560	U	U
610	ML5847	10	22	240	570	B2	A2
610	ML5848	10	22	240	570	B1	A1
611	ML5149	8	19	230	300/355	U	U
611	ML5451	8	19	205	350	U	U
613	ML5820	8	19	260	300	U	U
613.5	ML5527	10	22	248	620	O	O
613.5	ML5585	10	22	248	560	O	O
613.5	ML5586	10	22	248	640	O	O
614	ML5023	8	19	230	330	U	U
614	ML5465	8	19	229	300	S1	S1
615	ML5593	8	19	260	400	Y1	D
622	ML5129	8	19	240	360	S1	S1
624	ML5432	8	19	260	400	S1	S1
625	ML5205	8	19	253	575	U	U
625	ML5693	8	19	210	590	P	S1
627	ML5283	8	19	230	570	U	U
627	ML5304	8	19	230	570	U	U
627	ML5454	8	19	230	630	U	U
627	ML5626	8	19	230	570	U	U
627	ML5671	8	19	205	660	U	U
628	ML5795	8	19	272	440	U	U
630	ML5282	8	19	269	330	U	U
630	ML5505	8	19	220	570	T1	T1
631	ML5458	8	19	230	440	U	U
631	ML5851	8	18.5	265	455	S1	S1
632	ML5344	8	19	230	510/540	U	U
632	ML5363	8	19	215	600	U	U
632	ML5455	8	19	215	600	U	U
635	ML5364	8	19	248	360	U	U
635	ML5450	8	19	259	290	U	U
635	ML5567	8	19	225	200	S1	S1
639	ML5836	8	19	258	465	T1	T1
640	ML5311	8	19	190	470	U	U
640	ML5530	8	19	260	510	U	P
640	ML5573	8	19	235	390	U	D
640	ML5604	8	19	278	300	S1	D
640	ML5755	8	19	255	F3 595	U	P
640	ML5756	8	19	255	F3 565	U	P
645	ML5088	8	19	202.6	470	E2	E3
645	ML5089	8	19	202.6	470	E2	E3
645.5	ML5418	8	19	275	450	U	U
648	ML5267	8	19	265	190	S1	S1
650	ML5345	8	19	270	310	U	U
650	ML5578	8	19	250	460	U	U
650	ML5601	8	19	275	240/300	Y1	D
650	ML5602	8	19	275	240/300	S1	D
650	ML5603	8	19	275	310/370	Y1	D
650	ML5605	8	19	275	310/370	S1	D
650	ML5715	8	19	270	350	U	U
653	ML5452	8	19	260	400/463	U	U
656	ML5435	8	19	260	400	S1	S1
657	ML5654	8	18.5	275	480	P	U
664,5	ML5162	8	19	275	390	S1	S1
667	ML5542	8	19	215	375	U	U
667	ML5716	10	22	255	755	U	U
668	ML5333	8	19	280	375	Y1	D
668	ML5403	8	19	215	375	U	U
670	ML5497	8	19	294	320	Y1	D
670	ML5498	8	19	294	345	Y1	D

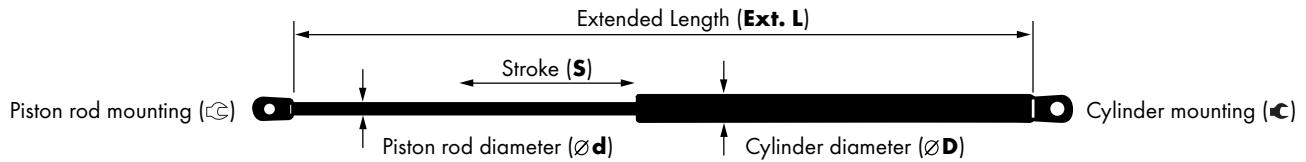

Ext. L	Monroe®	$\varnothing d$	$\varnothing D$	S	F1	⊖	⊕
671.5	ML5589	8	19	270	360	S1	S1
674	ML5798	8	19	293	300	U	U
674	ML5799	8	19	293	330	U	U
675	ML5309	8	19	285	260	U	U
675	ML5315	8	19	275	400/440	U	U
675	ML5521	8	19	263	360	T1	Q
675	ML5608	8	19	279	210	N	N
677	ML5631	8	19	274	340/400	T1	T1
678	ML5295	8	19	282	480	U	U
678	ML5393	8	19	270	270	U	U
680	ML5192	8	19	270	360	U	U
680	ML5508	8	19	270	390	T1	T1
680	ML5634	8	19	270	360	T1	T1
685	ML5118	10	22	255	770	U	U
685	ML5249	10	22	250	710	U	U
685	ML5250	10	22	250	910	P	P
685	ML5251	10	22	250	830	P	P
685	ML5268	8	19	285	150/180	U	U
685	ML5470	8	19	265	200	S1	S1
685.5	ML5084	8	19	300	200	U	U
687	ML5561	8	19	295	270	U	U
690	ML5128	10	22	280	630	S1	S1
690	ML5837	8	19	300	630	T1	T1
691.5	ML5337	8	19	285	270	U	U
695	ML5543	8	19	272	640	U	U
696	ML5022	8	19	278	220	Y1	X1
697	ML5528	10	22	257	610	M	O
699	ML5834	10	22	257	610	M	O
699	ML5835	10	22	257	540	M	O
700	ML5021	8	19	251	200	U	U
700	ML5037	8	19	300	325	U	P
700	ML5046	8	19	300	260	U	U
700	ML5052	8	19	300	200	U	U
700	ML5057	8	19	300	325	P	S1
700	ML5113	8	19	300	670	T1	T1
700	ML5407	8	19	257	320	U	U
700	ML5494	8	19	295	400	Y1	D
700	ML5499	8	19	295	345	Y1	D
700	ML5841	8	19	175	1050	U	U
715	ML5269	8	19	306	290	U	U
715	ML5565	8	19	303	160	P	S1
720	ML5737	8	19	300	180	P	U
720	ML5750	10	22	280	870	U	U
721.5	ML5768	8	19	315	350	U	U
722	ML5266	8	19	306	280	U	U
722	ML5385	8	19	306	310	U	U
722	ML5386	8	19	315	325	U	U
722	ML5515	10	22	210	819	U	U
722	ML5679	8	19	306	310	L	L
726	ML5051	10	22	280	420	S1	E1
726.5	ML5758	8	19	310	360	P	U
728	ML5648	8	18.5	310	265	P	U
730	ML5518	10	22	200	700	U	U
730	ML5519	10	22	200	760	U	U
730	ML5726	8	19	316	140	U	U
730	ML5735	8	19	320	250	P	U
730	ML5829	8	19	310	380	P	U
735	ML5738	8	19	321	300	P	U
736.5	ML5709	10	22	310	725	U	U
740	ML5790	8	19	310	290	P	S1
750	ML5368	8	19	315	300	S1	S1
755	ML5575	10	22	210	970	U	U
755	ML5576	10	22	210	1080	U	U
755	ML5833	10	22	210	1080	U	P

Ext. L	Monroe®	$\varnothing d$	$\varnothing D$	S	F1	⊖	⊕
765	ML5409	8	18	325	235	U	U
765	ML5638	8	19	324	200	U	U
765	ML5741	8	19	335	340	U	U
769	ML5582	10	22	247	475	U	U
772	ML5329	10	22	322	630	U	U
775	ML5328	10	22	322	530	U	U
775	ML5621	10	22	322	530	U	U
788	ML5102	8	19	342	280	Y1	V
798	ML5074	10	22	350	500	F1	Y3
828	ML5369	8	19	249	355	U	U
837	ML5504	8	19	315	365	T1	T1
850	ML5514	10	22	340	670	U	U
866	ML5448	10	22	350	370	U	U
870	ML5584	10	22	370	370	S1	U
905	ML5516	10	22	307	730	T1	T1
905	ML5550	10	22	307	730	T1	T1
943	ML5678	10	22	417	380	U	L

EXTENDED LENGTH

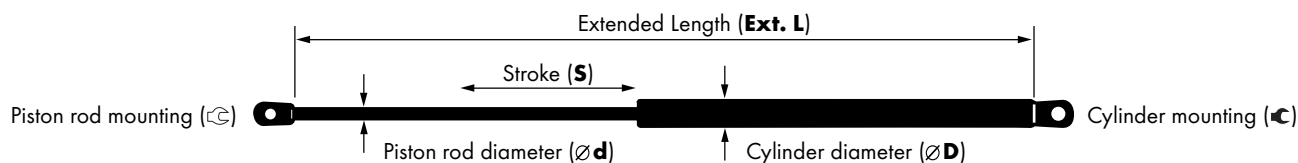

S	Monroe®	$\varnothing d$	$\varnothing D$	Ext. L	F1	C	C
40	ML5686	8	19	165	650	U	U
45	ML5675	10	22	175	700	U	U
48	ML5389	8	19	215	200	S1	S1
50	ML5583	10	22	195	760/860	U	U
52	ML5559	10	22	235	850	U	S2
52	ML5791	8	19	201	250	S1	U
55	ML5517	10	22	195	1100	U	U
55	ML5526	8	19	180	480	S1	Z
55	ML5546	6	15	185	100	R	R
58	ML5808	8	19	256	560	S1	S1
62	ML5810	8	19	238	165	U	U
63	ML5496	8	19	226	100	Y1	D
67	ML5085	10	22	249	850	U	U
70	ML5529	14	28	270	1600	O	M
70	ML5535	8	19	241	560	Y1	T1
70	ML5751	10	22	300	710	T1	T1
70	ML5803	8	19	240	380	S1	S1
74	ML5330	10	22	250	660	U	U
74	ML5404	8	19	240	300	U	U
75	ML5481	8	19	270	420	S1	S1
76	ML5611	8	19	245	330	Y1	D
78	ML5352	8	19	268	510	U	U
80	ML5170	8	19	295	480	U	U
80	ML5260	8	19	293	610	U	U
80	ML5341	8	19	263	520	U	U
80	ML5466	8	19	280	465	S1	S1
80	ML5467	8	19	280	420	S1	S1
80	ML5628	10	22	265	820	U	U
80	ML5629	6	15	225	100	R	R
80	ML5744	10	22	298	730	U	U
80	ML5745	10	22	298	700	U	U
82	ML5215	8	19	264	370	S1	S1
82	ML5216	8	19	264	460	S1	S1
83	ML5154	8	19	298	500	U	U
83,5	ML5617	8	19	268	450	N	N
84	ML5522	8	19	242	380	Y6	D
85	ML5290	8	19	256	500	U	U
85	ML5431	8	19	256	630	U	U
85	ML5639	8	19	254	340	Y1	D
85	ML5685	14	28	320	1200	M	O
85	ML5748	8	19	255	600	S1	U
85	ML5764	8	19	252	425	U	U
86	ML5018	8	19	256	280	Y1	X1
86	ML5030	8	19	256	180	Y1	X1
86	ML5058	8	19	256	280	Y1	X1
86	ML5594	8	19	255	600	Y5	X3
86	ML5595	8	19	255	370	Y5	X3
86	ML5852	10	22	399	1430	G	G
89	ML5226	10	22	260	690	U	S1
89	ML5310	8	19	310	590	U	U
89	ML5553	10	22	310	650	U	U
90	ML5193	8	19	279	530	U	U
90	ML5234	10	22	278	630	U	U
90	ML5273	8	19	278	480	U	U
90	ML5274	8	19	278	430	U	U
90	ML5376	8	19	280	580	U	S1
90	ML5417	8	19	275	420	S1	S1
90	ML5487	8	19	298	600	S1	S1
90	ML5523	8	19	310	640	S1	Q
90	ML5531	8	19	280	500	S1	T1
90	ML5532	8	19	280	600	S1	T1
90	ML5533	10	22	272	670	T1	T1
90	ML5549	8	19	270	540	T1	D
90	ML5558	8	19	280	550	U	T1

S	Monroe®	$\varnothing d$	$\varnothing D$	Ext. L	F1	C	C
90	ML5566	8	19	254	420	Y1	D
90	ML5633	8	19	268	540	Y1	D
90	ML5643	6	15	244	400	S1	S1
90	ML5786	8	19	280	510	U	U
92	ML5524	10	22	273	680	T1	T1
92	ML5525	10	22	273	720	T1	T1
95	ML5135	8	19	279	490	U	U
95	ML5223	10	22	298	650	U	U
95	ML5323	8	19	285	290	U	U
95	ML5355	8	19	310	430	U	U
95	ML5419	8	19	280	390	S1	S1
95	ML5439	8	19	279	520	U	U
95	ML5483	8	19	280	500	S1	S1
95	ML5520	8	19	335	520	S1	Q
95	ML5536	8	19	288	250	U	Q
95	ML5596	6	15	254	350	Y4	X1
95,5	ML5104	8	19	280	630	U	S1
98	ML5818	8	19	282	560	U	U
99	ML5259	8	19	287	365	U	U
99	ML5502	8	19	300	560	S1	S1
100	ML5063	8	19	284	330	U	U
100	ML5163	8	19	350	320	S1	S1
100	ML5182	8	19	300	410	S1	S1
100	ML5301	8	19	295	380	U	U
100	ML5321	8	19	315	420	U	U
100	ML5322	8	19	315	465	U	U
100	ML5336	10	22	333	700	S1	S1
100	ML5471	8	19	286	310	S1	S1
100	ML5488	8	19	320	360	S1	S1
100	ML5590	8	19	334	520	S1	Q
100	ML5646	8	19	319	370	Y5	X3
100	ML5674	14	28	325	1400	S1	S1
100	ML5769	10	22	285	720	U	S1
100	ML5793	8	19	315	550	S1	S1
101,5	ML5663	8	18,5	283	450	U	U
103	ML5811	8	19	323	700	U	U
104	ML5688	8	19	288	640	S1	S1
105	ML5411	8	19	315	370	S1	U
105	ML5727	8	19	320	470	U	U
105	ML5761	8	19	305	550	U	U
105	ML5778	8	19	285	600	S1	U
107	ML5698	8	19	291	380	S1	U
108	ML5637	14	28	396	1550	O	O
109	ML5640	6	15	305	130	T1	T1
109	ML5710	8	19	299	550	U	U
110	ML5263	8	19	319	580	S1	S1
110	ML5335	8	19	310	580	S1	S1
110	ML5356	8	19	352	150	U	U
110	ML5658	8	18,5	369	320	S1	S1
110	ML5694	8	19	370	320	S1	S1
110	ML5729	8	19	310	400	U	U
110	ML5844	8	18,5	310	590	U	U
112	ML5562	8	19	313	330	S1	S1
113	ML5813	6	15	297	240	S1	S1
115	ML5095	8	19	324	290	U	U
115	ML5441	10	22	326	800	S1	S1
116	ML5619	8	19	330	340	N	N
116	ML5804	8	19	314,5	330	U	U
117	ML5670	8	19	366	280	S1	S1
117	ML5800	8	19	333	650	U	U
120	ML5442	8	19	348	620	U	U
120	ML5479	8	19	398	180	S1	S1
120	ML5623	8	19	398	180	S1	S1
120	ML5696	8	19	355	350	P	U

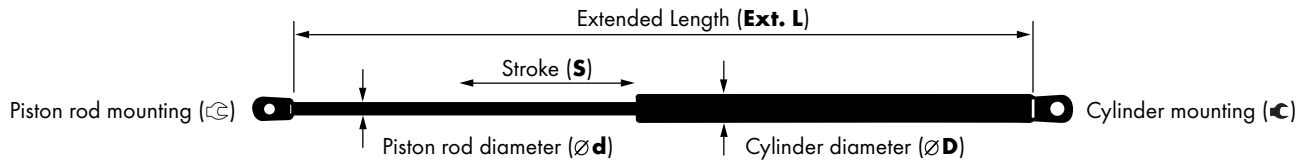

S	Monroe®	Ød	ØD	Ext. L	F1	C	C
120	ML5740	8	19	315	440	S1	U
120	ML5766	8	19	318	380	S1	S1
121	ML5179	6	15	305.5	45	S1	S1
121	ML5630	10	22	431	680/740	S1	S1
127	ML5415	10	22	455	700	U	U
128	ML5351	8	19	357	555	U	U
130	ML5447	8	19	540	170	T1	T1
130	ML5540	10	22	364	800	S2	S2
130	ML5680	8	19	365.5	440	U	U
130	ML5789	8	19	345	350	U	U
132	ML5489	8	19	364	310	S1	S1
132	ML5490	8	19	363	370	S1	S1
135	ML5017	8	19	362	190	U	X2
135	ML5303	8	19	365	620	S1	S1
135	ML5365	8	19	365	180	U	U
135	ML5366	8	19	365	240	U	U
135	ML5552	6	15	365	135	S1	S1
135	ML5652	8	18.5	375	495 F3	J	S1
138	ML5302	8	19	385	560	U	U
138	ML5823	6	15	362	100	S1	S1
140	ML5008	8	19	365	600	Y1	X1
140	ML5224	10	22	465	655	U	U
140	ML5444	8	19	365	410	Y1	D
140	ML5445	8	19	365	480	Y1	D
140	ML5446	10	22	382	660	T1	T1
140	ML5513	10	22	382	660	T1	T1
140	ML5563	8	19	374	350	S1	S1
140	ML5830	8	19	375	390	U	P
142	ML5599	6	15	440	380	Y1	X1
144	ML5539	10	22	489	720	U	U
145	ML5421	6	15	367	320	Y1	X1
145	ML5704	8	19	378	540	T1	T1
145	ML5728	8	19	375	615	U	U
148	ML5387	8	19	395	180	U	U
148	ML5426	10	22	418	700N	U	U
148	ML5839	10	22	390	800	U	K
149	ML5392	8	19	400	300	S1	S1
150	ML5277	8	19	405	520	U	U
150	ML5316	8	19	408	310	U	U
150	ML5472	8	19	395	230	S1	S1
150	ML5473	8	19	395	470	S1	S1
150	ML5484	8	19	400	280	S1	S1
150	ML5624	8	19	392	300	P	T1
150	ML5714	8	19	386.5	350	U	P
150	ML5762	8	19	385	140	P	U
153	ML5486	8	19	434	585	S1	S1
155	ML5212	8	19	417	500	U	U
155	ML5241	8	19	412	340	U	U
155	ML5382	8	19	440	300	U	S1
155	ML5832	8	19	390	360	U	P
157	ML5653	8	18.5	439.5	550	S1	U
158	ML5210	8	19	440.5	370	U	U
158	ML5706	8	19	395	440	P	U
160	ML5001	8	19	405	390	Y1	X1
160	ML5007	8	19	405	500	Y1	X1
160	ML5045	8	19	405	550	U	U
160	ML5060	8	19	405	500	Y1	X1
160	ML5070	8	19	405	500	Y1	D
160	ML5071	8	19	405	390	Y1	D
160	ML5075	8	19	405	600	Y1	D
160	ML5111	8	19	402	390	U	U
160	ML5131	8	19	440	450/500	U	U
160	ML5155	8	19	440	520	U	U
160	ML5270	8	19	460	300	U	U

S	Monroe®	Ød	ØD	Ext. L	F1	C	C
160	ML5275	8	19	405	310	U	U
160	ML5297	8	19	435	100	U	U
160	ML5422	6	15	410	280	Y1	X1
160	ML5449	8	19	405	620	U	U
160	ML5500	8	19	430	470	S1	S1
160	ML5649	8	19	405	300	U	U
160	ML5689	8	19	400	330	S1	P
160	ML5723	8	19	405	480	S1	S1
160	ML5753	8	19	470	630	U	U
160	ML5779	8	19	445	420	U	U
160	ML5787	10	22	550	710	T1	T1
160	ML5801	8	19	415	530	U	U
162	ML5151	8	19	445	420	U	U
162	ML5331	10	22	450	740	U	U
162	ML5682	8	19	420	600	U	U
163	ML5485	8	19	468	440	S1	U
163	ML5691	8	19	412	400	S1	U
163	ML5736	8	19	404.5	460	S1	U
163	ML5802	8	19	418	490	U	U
164	ML5165	8	19	455	380	U	U
165	ML5332	8	19	485	640	U	U
165	ML5507	8	19	433	500	T1	T1
165	ML5655	8	18.5	456	320	S1	S1
165	ML5669	8	19	424.5	450	U	U
165	ML5695	8	19	425	350	S1	U
165	ML5845	8	18.5	419	510	U	U
166	ML5568	8	19	464	160	S1	S1
169	ML5153	8	19	460	100	S1	S1
169	ML5175	8	19	440	600	U	U
169	ML5280	8	19	441.5	460	U	U
169	ML5492	8	19	465	113	Y1	D
170	ML5028	8	19	460	220	U	U
170	ML5097	8	19	460	270	U	U
170	ML5108	8	19	450	460	U	U
170	ML5110	8	19	500	635	U	U
170	ML5230	6	15	447	130	S1	S1
170	ML5308	8	21	450	490	U	U
170	ML5383	8	19	473.5	590	U	S1
170	ML5414	8	19	438	480	S1	S1
170	ML5632	8	19	486	585	Y1	D
170	ML5661	8	19	440	470	U	U
170	ML5743	10	22	505	770	U	P
170	ML5777	8	19	430	370	U	U
170	ML5785	8	19	460	350	S1	S1
171	ML5082	8	19	469.5	560	U	U
171	ML5222	8	19	440	370	S1	U
171	ML5358	8	19	500	350/400	U	U
172	ML5087	8	19	473	420	U	U
172	ML5096	8	19	447	500	U	U
172	ML5183	8	19	445	220/250	U	U
172	ML5587	8	19	459	230	S1	S1
172	ML5641	8	19	511.5	545	S1	S1
172	ML5838	8	19	494	500	P	P
173	ML5145	8	19	431	380	U	U
173	ML5512	10	22	480	690	U	U
173	ML5666	8	19	531	545	U	U
173	ML5700	8	19	480	135	U	U
173	ML5775	8	19	437	350	S1	S1
175	ML5024	8	19	450	340	U	U
175	ML5025	8	19	450	260	U	U
175	ML5035	8	19	450	280	U	U
175	ML5114	8	19	450	340	U	U
175	ML5116	8	19	450	160	U	U
175	ML5117	8	19	440	175	S1	S1

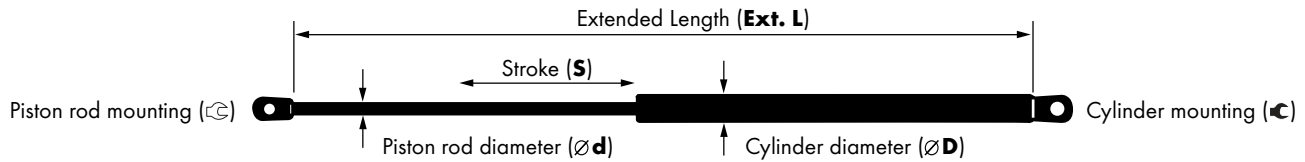

S	Monroe®	Ød	ØD	Ext. L	F1	C	C
175	ML5121	8	19	450	600	S1	S1
175	ML5291	8	19	501	595	U	U
175	ML5298	8	19	450	260	U	U
175	ML5413	8	19	472	590	S1	U
175	ML5475	8	19	520	640	U	U
175	ML5510	10	22	483	740	U	U
175	ML5511	10	22	483	690	U	U
175	ML5612	10	22	501	780	U	U
175	ML5660	8	19	441	300	P	U
175	ML5676	8	19	436	150	U	U
175	ML5690	8	19	530	530	S1	S1
175	ML5719	8	19	475	510	U	P
175	ML5814	8	19	447	300	U	U
175	ML5841	8	19	700	1050	U	U
176	ML5160	8	19	458	430	S1	S1
176	ML5701	8	19	590	435	S1	U
177	ML5480	8	19	452	350	S1	S1
178	ML5158	8	19	465	425	U	U
178	ML5806	10	22	560	725	U	P
179	ML5805	8	19	479	340	P	U
180	ML5003	8	19	450	300	U	U
180	ML5043	8	19	490	480	Y1	X1
180	ML5079	8	19	445	300	U	U
180	ML5090	8	19	450	450	U	U
180	ML5136	8	19	448	310	U	U
180	ML5164	8	19	472	330	U	U
180	ML5339	8	19	480	300	S1	U
180	ML5343	8	19	448	590	U	U
180	ML5423	10	22	520	660	U	U
180	ML5433	10	22	520	665	U	U
180	ML5438	8	19	459.5	535	S1	S1
180	ML5453	8	19	460	380	U	U
180	ML5618	8	19	505	430	N	N
180	ML5733	6	15	435	105	S1	S1
180	ML5734	8	19	460	F3 440	S1	S1
180	ML5742	8	19	450	535	S1	U
180	ML5826	8	19	520	F3-625	T1	T1
180	ML5831	8	19	450	550	U	S1
182	ML5219	8	19	495	515	U	U
182	ML5220	8	19	495	550	U	U
182	ML5221	8	19	495	565	U	U
182	ML5257	8	19	470	600	U	U
182	ML5757	8	19	473	540	U	U
183	ML5367	8	19	567.5	430	U	U
183	ML5699	8	19	445	550	P	S1
183	ML5781	10	22	535	710	U	S1
184	ML5254	8	19	476.5	420	U	U
184	ML5258	8	19	471	570	U	U
184	ML5746	8	19	475	650	U	P
185	ML5427	8	19	471	380	S1	U
185	ML5460	8	19	494	490	S1	S1
185	ML5569	8	19	485	580	S1	S1
185	ML5580	10	22	520	730	U	U
185	ML5656	8	18.5	469.5	580 F3	P	P
185	ML5702	8	19	470	480	P	S1
185	ML5725	8	19	451	385	S1	S1
185	ML5788	8	19	554	F3 200	T1	T1
185	ML5796	8	19	463	360	S1	U
185.5	ML5817	10	22	482	700	P	U
187	ML5380	8	19	485	610	U	S1
187	ML5420	8	19	465	320	Y1	D
187	ML5570	8	19	490	380	S1	S1
188	ML5032	8	19	473	530	U	U
188	ML5098	8	19	496	270	P	P

S	Monroe®	Ød	ØD	Ext. L	F1	C	C
188	ML5462	8	19	477	360	S1	S1
188	ML5557	10	22	492	710	U	U
189	ML5307	8	19	485	450	U	U
190	ML5069	8	19	470	350	U	U
190	ML5159	8	19	486	320	S1	S1
190	ML5180	8	19	490	190/250	U	U
190	ML5206	8	19	599	425	U	U
190	ML5207	8	19	600	440	U	U
190	ML5235	8	19	596	380	U	U
190	ML5237	8	19	596	420	U	U
190	ML5238	8	19	500	635	S1	P
190	ML5256	8	19	505	520	U	U
190	ML5311	8	19	640	470	U	U
190	ML5357	8	19	538	125	U	U
190	ML5360	8	19	500	360	U	U
190	ML5436	8	19	517	420	S1	S1
190	ML5551	6	15	547	170	S1	S1
190	ML5572	8	19	500	220	Y1	U
190	ML5650	8	18.5	484	200	P	U
190	ML5684	8	19	515	490	U	U
190	ML5703	8	19	480	420	P	U
190	ML5721	8	19	474	570	U	U
190	ML5783	8	19	585	F3-625	U	P
190	ML5794	8	19	462.5	560	T1	T1
190	ML5840	6	15	465	335	I	H
191	ML5093	8	19	471	360	S1	S1
191	ML5759	8	19	483	370	T1	T1
192	ML5080	8	19	495	500	U	U
192	ML5253	8	19	496.5	565	U	U
193	ML5137	8	19	542	590	U	U
193	ML5198	8	19	500	470	S1	U
193	ML5424	8	19	567	540	U	S1
193	ML5459	8	19	485	460	S1	S1
194	ML5390	8	19	508	350	U	U
195	ML5120	8	19	475	350	U	U
195	ML5124	8	19	515	500	U	U
195	ML5125	8	19	508	600	U	U
195	ML5156	8	19	508	600	U	U
195	ML5236	8	19	596	430	U	U
195	ML5239	10	22	500	690	P	U
195	ML5371	8	19	499	400	U	U
195	ML5495	8	19	490	610	U	U
195	ML5591	10	22	545	750	U	Q
195	ML5615	8	19	502	400	U	P
195	ML5635	8	19	500	650	Y1	D
195	ML5668	8	19	545	425	S1	U
195	ML5708	8	19	480	335	U	U
195	ML5732	8	19	505	490	S1	S1
195	ML5767	8	19	500	340	S1	U
195	ML5773	8	19	475	640	U	U
196	ML5119	8	19	540	540	U	U
196	ML5217	8	19	493	470	U	U
196	ML5293	8	19	485	460	U	U
196	ML5294	8	19	485	520	U	U
196	ML5306	8	19	500	225	U	U
196	ML5760	8	19	515	585	P	U
197	ML5296	8	19	520	435	U	U
197	ML5406	8	19	498	330	U	U
197	ML5776	8	19	495	420	U	P
198	ML5218	8	19	495	500	U	U
198	ML5231	8	19	535	485	U	U
198	ML5232	8	19	535	520	U	U
198	ML5233	8	19	535	585	U	U
198	ML5537	10	22	603	810	U	U

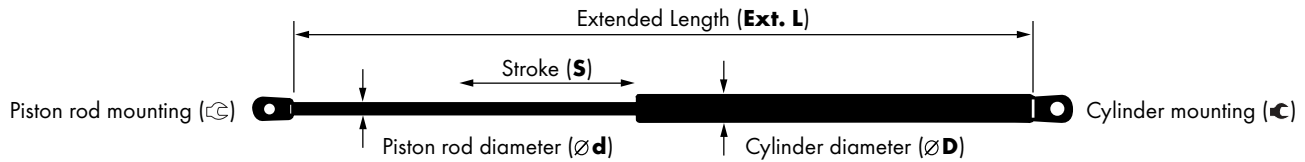

S	Monroe®	Ød	ØD	Ext. L	F1	C	C
198	ML5538	10	22	603	850	U	U
198	ML5625	8	19	475	180/240	Y1	S1
198	ML5747	8	19	490	530	T1	T1
198	ML5771	10	22	574	990	P	P
199	ML5101	8	19	502	280	S1	S1
199	ML5408	8	19	511	520	U	U
199	ML5416	8	19	481.5	530	U	U
200	ML5002	8	19	509	400	Y1	X1
200	ML5004	8	19	502	400	U	U
200	ML5005	8	19	509	420	U	U
200	ML5038	8	19	500	280	U	U
200	ML5047	8	19	509	220	U	U
200	ML5072	8	19	502	280	U	U
200	ML5115	8	19	500	400	U	U
200	ML5126	8	19	554	515	S1	U
200	ML5127	10	22	591	830	U	U
200	ML5157	10	22	540	450	U	U
200	ML5168	8	19	512	550	U	U
200	ML5169	8	19	527	450	U	U
200	ML5176	8	19	552	560	S1	U
200	ML5181	8	19	500	450	S1	U
200	ML5194	8	19	500	380	S1	U
200	ML5195	8	19	500	280	S1	U
200	ML5196	8	19	500	400	S1	U
200	ML5199	8	19	500	365	S1	U
200	ML5209	8	19	552	410	U	U
200	ML5213	8	19	540	450	S1	S1
200	ML5214	8	19	517	460	S1	S1
200	ML5225	8	19	500	470	S1	U
200	ML5227	8	19	502	530	S1	S1
200	ML5240	10	22	500	635	P	P
200	ML5261	8	19	500	350	S1	U
200	ML5264	8	19	500	350	S1	U
200	ML5281	8	19	506	380	U	U
200	ML5284	8	19	500	320	S1	U
200	ML5287	8	19	500	190	S1	U
200	ML5305	8	19	610	560	U	U
200	ML5319	8	19	558	490/550	U	U
200	ML5334	8	19	549.5	610	U	U
200	ML5361	8	19	510	320	U	U
200	ML5370	8	19	500	420	U	U
200	ML5410	8	19	515	445	S1	S1
200	ML5456	8	19	610	600	U	U
200	ML5468	8	19	512	470	S1	S1
200	ML5478	8	19	515	490	S1	S1
200	ML5491	8	19	500	310	S1	U
200	ML5493	8	19	557	135	Y1	D
200	ML5518	10	22	730	700	U	U
200	ML5519	10	22	730	760	U	U
200	ML5547	6	15	502	125	S1	S1
200	ML5560	8	19	535	280	U	U
200	ML5574	8	19	500	270	U	D
200	ML5577	8	19	570	280	U	P
200	ML5581	10	22	527	660	U	U
200	ML5600	8	19	500	230	Y1	D
200	ML5614	10	22	490	780	U	U
200	ML5616	8	19	570	630	S1	U
200	ML5622	8	19	515	490	S1	S1
200	ML5627	8	19	610	560	U	U
200	ML5642	8	19	550	460	T1	T1
200	ML5645	8	19	512	300	Y1	U
200	ML5647	8	19	485	565	P	S1
200	ML5667	8	19	490.5	480	U	U
200	ML5712	8	19	490	380	P	U

S	Monroe®	Ød	ØD	Ext. L	F1	C	C
200	ML5717	8	19	497	430	P	U
200	ML5724	8	19	533	515	S1	S1
200	ML5739	8	19	485	170	U	P
200	ML5774	8	19	500	525	T1	P
200	ML5792	8	19	480	550	U	P
201	ML5613	8	19	500	600	Y1	D
201	ML5683	8	19	580	510	U	U
202	ML5068	8	19	515	370	U	U
202	ML5103	8	19	510	620	U	U
202	ML5300	8	19	527	390	U	U
202	ML5579	8	19	523	530	S1	S1
202.6	ML5088	8	19	645	470	E2	E3
202.6	ML5089	8	19	645	470	E2	E3
203	ML5377	8	19	507	520	U	S1
203	ML5673	8	19	582	460	U	U
203	ML5821	8	19	500	245	S1	U
204	ML5094	8	19	500	500	U	U
204	ML5100	8	19	500	480	S1	S1
204	ML5138	8	19	566	500	U	U
204	ML5809	8	19	536	410	S1	S1
205	ML5078	8	19	507	420	S1	S1
205	ML5132	8	19	502	500	S1	U
205	ML5166	8	19	536.5	430	U	U
205	ML5185	8	19	500	470	S1	U
205	ML5197	8	19	500	420	S1	U
205	ML5208	8	19	552	370	U	U
205	ML5289	8	19	556	500	U	U
205	ML5347	8	19	525	310	U	U
205	ML5348	8	19	525	350	U	U
205	ML5405	8	19	516	425	U	U
205	ML5425	8	19	491	600	U	U
205	ML5451	8	19	611	350	U	U
205	ML5461	8	19	506	120/180	S1	S1
205	ML5620	8	19	580	230	U	U
205	ML5657	8	18.5	495	610 F3	S1	S1
205	ML5671	8	19	627	660	U	U
205	ML5677	8	19	499	460	Y1	T1
205	ML5681	8	19	495	440	U	U
205	ML5722	10	22	505	610	U	U
206	ML5054	8	19	543.5	360	U	U
206	ML5140	8	19	526	320	U	U
206	ML5242	8	19	543.5	320	U	U
206	ML5313	8	19	526	520/560	U	U
207	ML5073	8	19	501	480	Y1	X1
207	ML5086	8	19	526	570	S1	S1
207	ML5109	8	19	544	495	U	U
207	ML5178	8	19	507	550	U	U
207	ML5189	8	19	513	535	S1	S1
207	ML5190	8	19	513	585	S1	S1
208	ML5346	8	19	571	570	U	U
208	ML5362	8	19	507	436	U	U
208	ML5391	8	19	510	440	U	U
208	ML5395	8	19	510	390	U	U
208	ML5752	8	19	500	375	U	U
208	ML5812	8	19	520	130	U	U
209	ML5036	8	19	518	220	Y1	X1
210	ML5041	8	19	542	300	U	U
210	ML5061	8	19	527	450	U	U
210	ML5123	8	19	515	500	S1	S1
210	ML5146	8	19	510	340	S1	S1
210	ML5177	8	19	515	550	U	U
210	ML5186	8	19	540	370	U	U
210	ML5211	8	19	527	350	U	U
210	ML5228	10	22	560	730	U	U

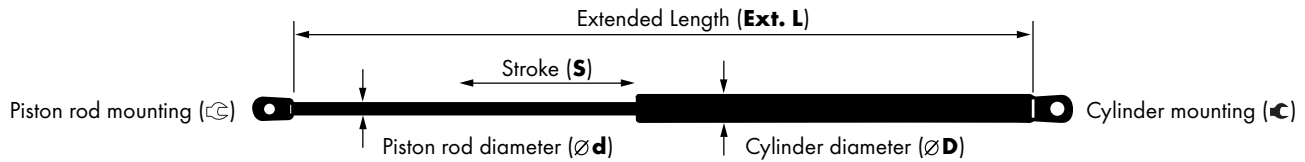

S	Monroe®	Ød	ØD	Ext. L	F1	C	C
210	ML5229	10	22	560	800	U	U
210	ML5252	8	19	544	440	U	U
210	ML5271	8	19	522	300	U	U
210	ML5272	8	19	522	400	U	U
210	ML5279	8	19	595	470	S1	U
210	ML5340	8	19	525	140	U	U
210	ML5349	8	19	525	480	U	U
210	ML5350	8	19	525	240	U	U
210	ML5378	8	19	545	490	U	S1
210	ML5379	8	19	545	530	U	S1
210	ML5412	8	19	565	560	S1	U
210	ML5469	8	19	581.5	535	S1	S1
210	ML5515	10	22	722	819	U	U
210	ML5544	8	19	596	450	U	S1
210	ML5545	8	19	596	510	U	S1
210	ML5575	10	22	755	970	U	U
210	ML5576	10	22	755	1080	U	U
210	ML5636	8	19	525	240	U	U
210	ML5672	8	19	540	385	U	U
210	ML5692	8	19	545	450	U	U
210	ML5693	8	19	625	590	P	S1
210	ML5707	8	19	545	620	U	U
210	ML5711	8	19	515	490	U	U
210	ML5749	8	19	530	410	U	P
210	ML5833	10	22	755	1080	U	P
211	ML5731	8	19	505	330	S1	P
212	ML5006	8	19	550	230	Y2	X2
212	ML5049	8	19	500	350	U	U
212	ML5053	8	19	550	350	U	U
212	ML5059	8	19	550	270	Y2	X2
212	ML5130	8	19	596.5	515	U	U
212	ML5152	8	19	595	485	U	U
212	ML5754	8	19	528	420	U	P
213	ML5056	8	19	520	230	Y1	X1
213	ML5373	8	19	548	475	U	U
213	ML5396	8	19	568	360	U	U
213	ML5548	6	15	530	110	S1	S1
213	ML5784	8	19	510	360	U	U
214	ML5187	8	19	540	370	U	U
214	ML5188	8	19	540	400	U	U
214	ML5556	6	15	547	225	Y1	X1
215	ML5167	8	19	535	480	U	U
215	ML5203	8	19	600	550	U	U
215	ML5204	8	19	600	600	U	U
215	ML5276	8	19	529	245	U	U
215	ML5317	8	19	590	410	U	U
215	ML5318	8	19	590	450	U	U
215	ML5338	8	19	570	530	U	U
215	ML5359	8	19	513	350	U	U
215	ML5363	8	19	632	600	U	U
215	ML5372	8	19	546	500	U	U
215	ML5381	8	19	557	550	U	S1
215	ML5388	8	19	565	480	U	U
215	ML5403	8	19	668	375	U	U
215	ML5455	8	19	632	600	U	U
215	ML5541	8	19	568	410	S1	S1
215	ML5542	8	19	667	375	U	U
215	ML5554	10	22	573.5	580	U	T1
215	ML5555	10	22	573.5	670	U	T1
215	ML5644	8	19	515	550	T1	D
215	ML5713	8	19	515	400	U	U
215	ML5730	8	19	565	315	U	U
216	ML5144	8	19	565	360	U	U
216	ML5161	8	19	534	410	U	U

S	Monroe®	Ød	ØD	Ext. L	F1	C	C
216	ML5174	8	19	534	410	U	U
217	ML5106	8	19	514.5	610	U	D
217	ML5509	8	19	534	200	T1	T1
218	ML5651	8	18.5	544	290	U	U
218	ML5772	8	19	539	585	T1	P
219	ML5044	8	19	527	450	U	U
219	ML5048	8	19	527	420	U	U
219	ML5064	8	19	527	520	U	U
219	ML5112	8	19	566.5	280	U	U
220	ML5040	8	19	569	280	U	U
220	ML5050	8	19	569	280	U	U
220	ML5292	8	19	550	285	U	U
220	ML5314	8	19	545	490/530	U	U
220	ML5324	8	19	590	480	U	U
220	ML5327	8	19	540	220/250	U	U
220	ML5353	8	19	555	450	U	U
220	ML5434	8	19	599	360	U	U
220	ML5437	8	19	575	500	S1	U
220	ML5440	8	19	534.5	480	S1	S1
220	ML5443	10	22	603	740	U	U
220	ML5474	8	19	535	425	S1	S1
220	ML5505	8	19	630	570	T1	T1
220	ML5506	8	19	540	470/520	T1	T1
220	ML5588	8	19	559	330	S1	S1
220	ML5718	10	22	547	460	U	U
220	ML5720	8	19	543	310	U	U
220	ML5765	8	19	565	500	T1	T1
220	ML5828	8	19	547	550	U	P
220	ML5849	8	18.5	526	325	U	U
221	ML5141	10	22	567	590	U	U
221	ML5142	10	22	567	650	U	U
222	ML5031	8	19	549	355	U	U
222	ML5134	8	19	585	280	U	U
222	ML5571	8	19	550	475	T1	T1
223	ML5184	8	19	602	320	U	U
224	ML5026	8	19	528	160	U	U
224	ML5099	8	19	528	220	U	U
224	ML5171	8	19	557	360	U	U
224	ML5172	8	19	557	425	U	U
224	ML5607	8	19	544	240/300	S1	S1
224	ML5797	10	22	556	715	T1	T1
225	ML5248	10	22	567	460	U	U
225	ML5320	8	19	600	450	U	U
225	ML5374	8	19	556	475	U	U
225	ML5457	8	19	546	220	U	U
225	ML5564	8	19	577	270	U	P
225	ML5567	8	19	635	200	S1	S1
225	ML5592	8	19	498	540	S1	S1
225	ML5659	8	18.5	553	220	S1	S1
225	ML5763	8	19	540	390	T1	T1
226	ML5200	8	19	577	415	U	U
226	ML5201	8	19	577	400	U	U
226	ML5394	8	19	600	360	U	U
226	ML5463	8	19	577	275	S1	S1
226	ML5464	8	19	577	320	S1	S1
228	ML5173	8	19	555	485	U	U
228	ML5687	8	19	555	305	U	U
228	ML5815	8	19	600	360	U	U
229	ML5465	8	19	614	300	S1	S1
229.5	ML5015	8	19	549	350	Y1	X1
229.5	ML5016	8	19	549	240	Y1	X2
229.5	ML5039	8	19	550	380	Y1	X2
229.5	ML5055	8	19	549.5	160	Y1	X1
230	ML5020	8	19	600	290	U	U

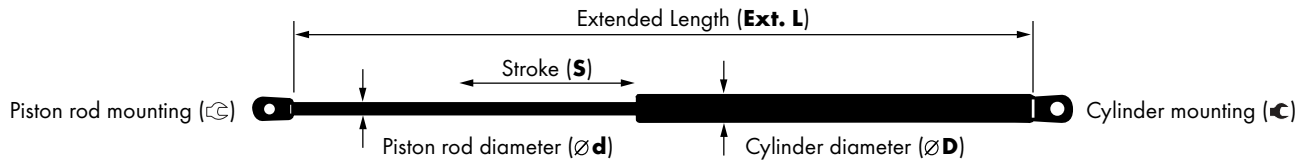

S	Monroe®	Ød	ØD	Ext. L	F1	C	C
230	ML5023	8	19	614	330	U	U
230	ML5148	8	19	600	300/360	U	U
230	ML5149	8	19	611	300/355	U	U
230	ML5202	8	19	566	380/440	U	U
230	ML5283	8	19	627	570	U	U
230	ML5288	8	19	570	460	U	U
230	ML5304	8	19	627	570	U	U
230	ML5312	8	19	545	300	U	U
230	ML5326	8	19	566	450	U	U
230	ML5344	8	19	632	510/540	U	U
230	ML5354	8	19	570	490	U	U
230	ML5375	8	19	568	500	U	U
230	ML5384	8	19	606.5	540	U	S1
230	ML5397	8	19	568	560	U	U
230	ML5399	8	19	570	215	U	U
230	ML5400	8	19	570	420	U	U
230	ML5401	8	19	570	520	U	U
230	ML5454	8	19	627	630	U	U
230	ML5458	8	19	631	440	U	U
230	ML5476	8	19	574.5	530	S1	S1
230	ML5477	8	19	574.5	620	S1	S1
230	ML5482	8	19	575	440	S1	S1
230	ML5503	8	19	600	510	T1	T1
230	ML5597	8	19	547	230	U	X1
230	ML5626	8	19	627	570	U	U
230	ML5825	8	19	500	135	S1	S1
230	ML5842	10	22	587	340	S1	C1
230	ML5843	10	22	587	340	S1	C2
230	ML5850	8	18.5	559	290	S1	S1
232	ML5122	8	19	570	520	U	U
232	ML5243	8	19	549	320	U	U
232	ML5244	8	19	549	410	U	U
233	ML5819	8	19	568	330	U	U
234	ML5014	8	19	584	280	U	U
234	ML5066	8	19	584	290	U	U
235	ML5013	8	19	595	280	U	U
235	ML5076	10	22	550	850	U	U
235	ML5143	8	19	574	260	U	U
235	ML5147	8	19	574	310	U	U
235	ML5191	8	19	585	360	U	U
235	ML5265	8	19	585	250	U	U
235	ML5342	8	19	575	330	U	U
235	ML5429	10	22	550	810	U	U
235	ML5573	8	19	640	390	U	D
235	ML5606	8	19	579	260/320	Y1	D
235	ML5780	8	19	550	280	T1	T1
235	ML5782	8	19	558	500	T1	T1
235	ML5824	8	19	558	530	S1	S1
236	ML5027	8	19	586	280	U	U
236	ML5062	8	19	586	200	U	U
239	ML5029	8	19	589	310	U	U
239	ML5286	8	19	591	400	U	U
240	ML5077	8	19	591	350	U	U
240	ML5105	10	22	569	910	U	U
240	ML5129	8	19	622	360	S1	S1
240	ML5245	10	22	569	750	U	U
240	ML5246	10	22	569	660	U	U
240	ML5247	10	22	569	830	U	U
240	ML5278	8	19	570	520	U	U
240	ML5402	8	19	570	470	U	U
240	ML5664	8	19	585	420	U	U
240	ML5705	8	19	565	290	S1	U
240	ML5816	10	22	570	650	T1	T1
240	ML5847	10	22	610	570	B2	A2

S	Monroe®	Ød	ØD	Ext. L	F1	C	C
240	ML5848	10	22	610	570	B1	A1
242	ML5081	8	19	569	210	U	U
242	ML5770	8	19	605	635	P	P
244	ML5325	8	19	600	330	U	U
245	ML5012	8	19	600	410	U	U
245	ML5065	8	19	600	430	U	U
245	ML5398	8	18	580	340	U	U
245	ML5430	8	19	590.5	480	U	U
245	ML5609	8	19	580	380	W	D
245	ML5662	8	19	590	460	U	U
245	ML5665	8	19	585.5	405	U	U
245	ML5822	8	19	580	165	S1	S1
247	ML5428	8	19	580	470	S1	S1
247	ML5534	8	19	605	340	S1	U
247	ML5582	10	22	769	475	U	U
248	ML5285	8	19	595	370	U	U
248	ML5364	8	19	635	360	U	U
248	ML5527	10	22	613.5	620	O	O
248	ML5585	10	22	613.5	560	O	O
248	ML5586	10	22	613.5	640	O	O
249	ML5369	8	19	828	355	U	U
250	ML5019	8	19	600	500	Y1	X1
250	ML5033	8	19	600	320	U	U
250	ML5034	8	19	585	200	Y1	X1
250	ML5083	8	19	584	200	U	U
250	ML5133	8	19	600	250/310	U	U
250	ML5139	8	19	602	160	S1	S1
250	ML5150	8	19	595	450/515	U	U
250	ML5249	10	22	685	710	U	U
250	ML5250	10	22	685	910	P	P
250	ML5251	10	22	685	830	P	P
250	ML5255	8	19	600	260/320	U	U
250	ML5262	8	19	595	450	U	U
250	ML5501	8	19	600	540	Y2	D
250	ML5578	8	19	650	460	U	U
250	ML5598	8	19	600	160	S1	S1
250	ML5610	8	19	600	540	Y2	D
251	ML5021	8	19	700	200	U	U
251.5	ML5807	8	19	609.5	245	U	U
252	ML5107	8	19	602	430	U	U
252	ML5299	8	19	602	430	U	U
253	ML5205	8	19	625	575	U	U
253	ML5697	8	19	604	250	U	U
255	ML5009	8	19	600	180	Y1	X1
255	ML5010	8	19	600	200	Y1	X1
255	ML5011	8	19	600	360	Y1	X1
255	ML5042	8	19	600	310	Y1	X1
255	ML5067	8	19	600	450	Y1	X1
255	ML5118	10	22	685	770	U	U
255	ML5716	10	22	667	755	U	U
255	ML5755	8	19	640	F3 595	U	P
255	ML5756	8	19	640	F3 565	U	P
255	ML5827	8	19	603	240	U	U
257	ML5407	8	19	700	320	U	U
257	ML5528	10	22	697	610	M	O
257	ML5834	10	22	699	610	M	O
257	ML5835	10	22	699	540	M	O
258	ML5836	8	19	639	465	T1	T1
259	ML5450	8	19	635	290	U	U
260	ML5432	8	19	624	400	S1	S1
260	ML5435	8	19	656	400	S1	S1
260	ML5452	8	19	653	400/463	U	U
260	ML5530	8	19	640	510	U	P
260	ML5593	8	19	615	400	Y1	D

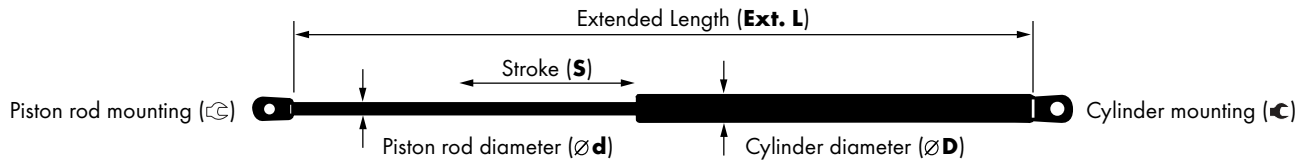

S	Monroe®	$\varnothing d$	$\varnothing D$	Ext. L	F1	↺	↻
260	ML5820	8	19	613	300	U	U
263	ML5521	8	19	675	360	T1	Q
265	ML5267	8	19	648	190	S1	S1
265	ML5470	8	19	685	200	S1	S1
265	ML5851	8	18.5	631	455	S1	S1
269	ML5282	8	19	630	330	U	U
270	ML5192	8	19	680	360	U	U
270	ML5345	8	19	650	310	U	U
270	ML5393	8	19	678	270	U	U
270	ML5508	8	19	680	390	T1	T1
270	ML5589	8	19	671.5	360	S1	S1
270	ML5634	8	19	680	360	T1	T1
270	ML5715	8	19	650	350	U	U
272	ML5543	8	19	695	640	U	U
272	ML5795	8	19	628	440	U	U
274	ML5631	8	19	677	340/400	T1	T1
275	ML5162	8	19	664.5	390	S1	S1
275	ML5315	8	19	675	400/440	U	U
275	ML5418	8	19	645.5	450	U	U
275	ML5601	8	19	650	240/300	Y1	D
275	ML5602	8	19	650	240/300	S1	D
275	ML5603	8	19	650	310/370	Y1	D
275	ML5605	8	19	650	310/370	S1	D
275	ML5654	8	18.5	657	480	P	U
278	ML5022	8	19	696	220	Y1	X1
278	ML5604	8	19	640	300	S1	D
279	ML5608	8	19	675	210	N	N
280	ML5051	10	22	726	420	S1	E1
280	ML5128	10	22	690	630	S1	S1
280	ML5333	8	19	668	375	Y1	D
280	ML5750	10	22	720	870	U	U
282	ML5295	8	19	678	480	U	U
285	ML5268	8	19	685	150/180	U	U
285	ML5309	8	19	675	260	U	U
285	ML5337	8	19	691.5	270	U	U
293	ML5798	8	19	674	300	U	U
293	ML5799	8	19	674	330	U	U
294	ML5497	8	19	670	320	Y1	D
294	ML5498	8	19	670	345	Y1	D
295	ML5494	8	19	700	400	Y1	D
295	ML5499	8	19	700	345	Y1	D
295	ML5561	8	19	687	270	U	U
300	ML5037	8	19	700	325	U	P
300	ML5046	8	19	700	260	U	U
300	ML5052	8	19	700	200	U	U
300	ML5057	8	19	700	325	P	S1
300	ML5084	8	19	685.5	200	U	U
300	ML5113	8	19	700	670	T1	T1
300	ML5737	8	19	720	180	P	U
300	ML5837	8	19	690	630	T1	T1
303	ML5565	8	19	715	160	P	S1
306	ML5266	8	19	722	280	U	U
306	ML5269	8	19	715	290	U	U
306	ML5385	8	19	722	310	U	U
306	ML5679	8	19	722	310	L	L
307	ML5516	10	22	905	730	T1	T1
307	ML5550	10	22	905	730	T1	T1
310	ML5648	8	18.5	728	265	P	U
310	ML5709	10	22	736.5	725	U	U
310	ML5758	8	19	726.5	360	P	U
310	ML5790	8	19	740	290	P	S1
310	ML5829	8	19	730	380	P	U
315	ML5368	8	19	750	300	S1	S1
315	ML5386	8	19	722	325	U	U

S	Monroe®	$\varnothing d$	$\varnothing D$	Ext. L	F1	↺	↻
315	ML5504	8	19	837	365	T1	T1
315	ML5768	8	19	721.5	350	U	U
316	ML5726	8	19	730	140	U	U
320	ML5735	8	19	730	250	P	U
321	ML5738	8	19	735	300	P	U
322	ML5328	10	22	775	530	U	U
322	ML5329	10	22	772	630	U	U
322	ML5621	10	22	775	530	U	U
324	ML5638	8	19	765	200	U	U
325	ML5409	8	18	765	235	U	U
335	ML5741	8	19	765	340	U	U
340	ML5514	10	22	850	670	U	U
342	ML5102	8	19	788	280	Y1	V
350	ML5074	10	22	798	500	F1	Y3
350	ML5448	10	22	866	370	U	U
370	ML5584	10	22	870	370	S1	U
417	ML5678	10	22	943	380	U	L

MOUNTING TYPES

MOUNTING

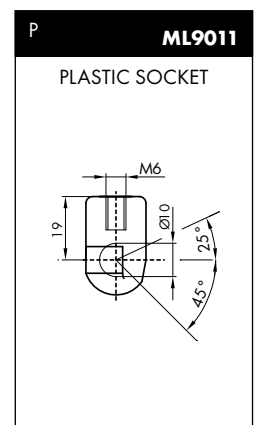
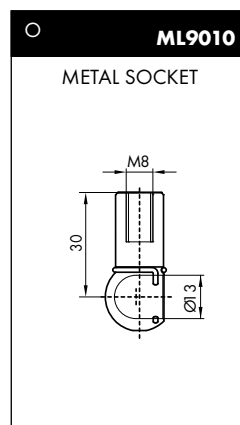
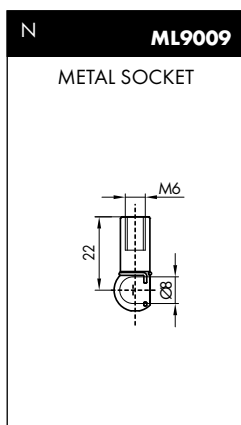
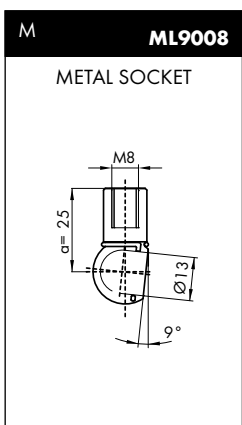
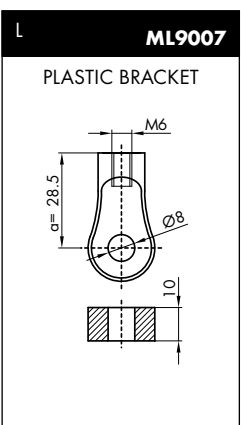
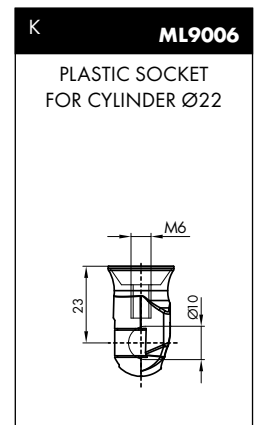
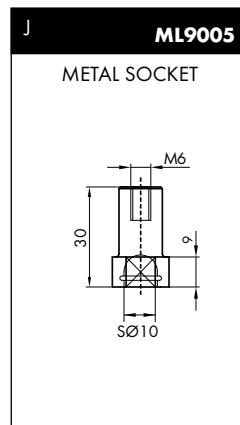
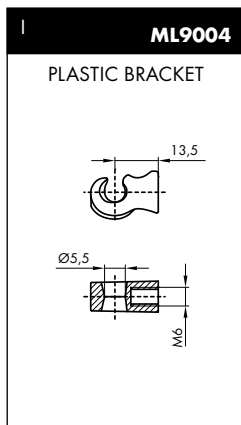
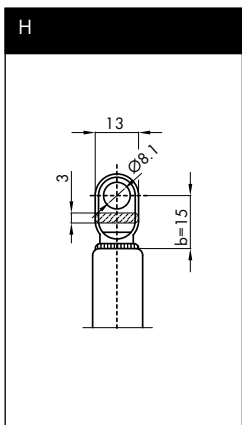
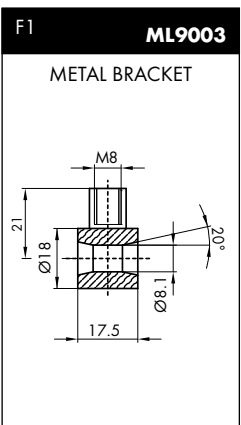
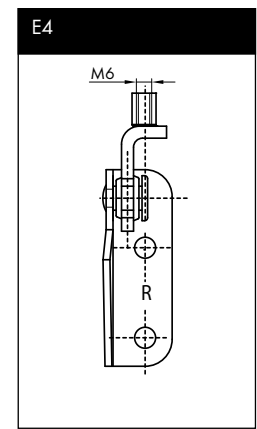
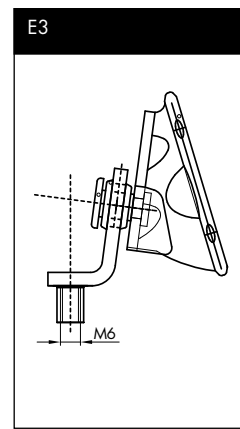
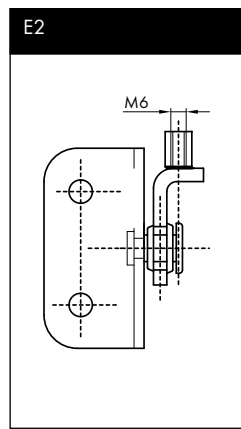
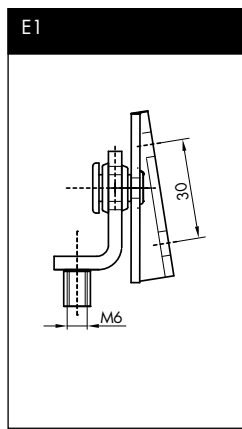
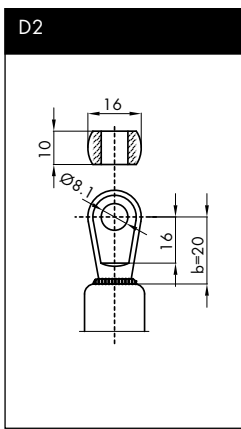
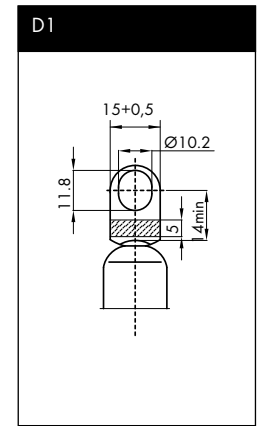
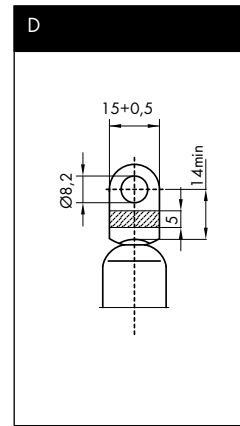
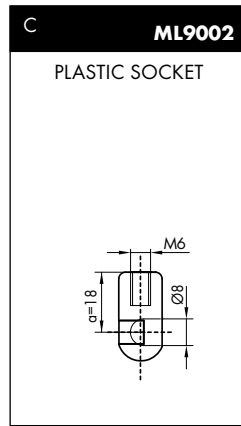
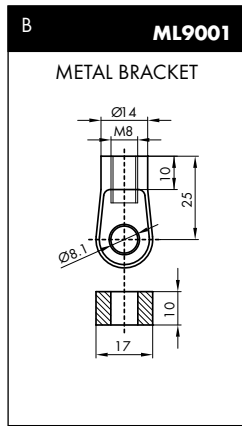
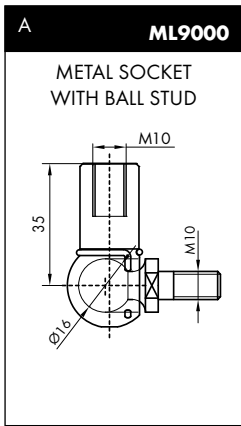

MOUNTING TYPES

MOUNTING

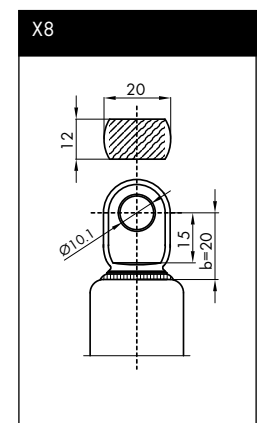
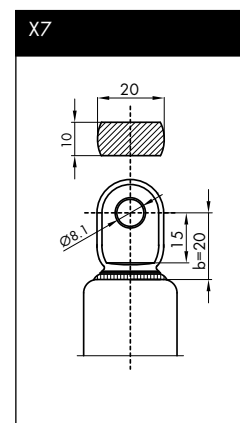
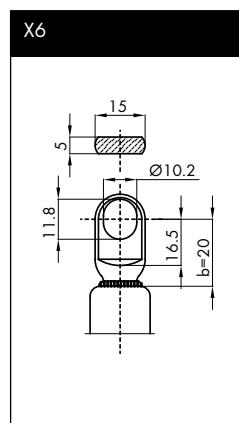
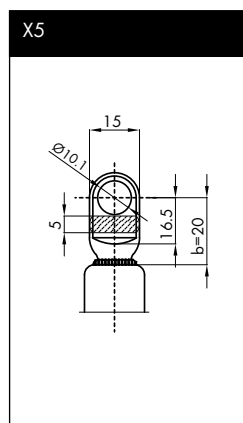
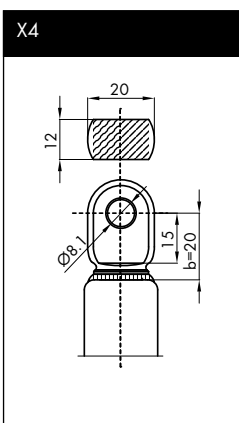
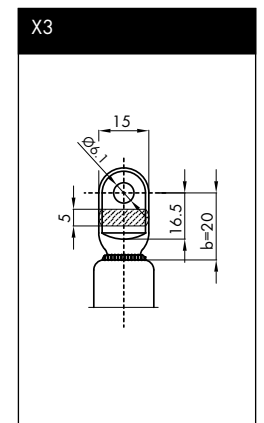
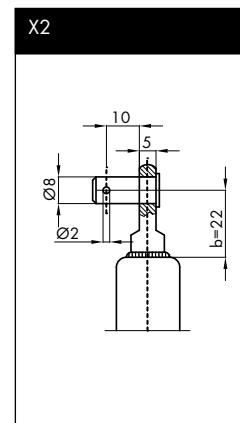
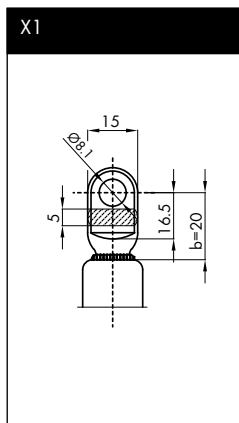
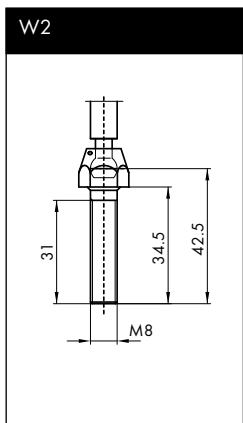
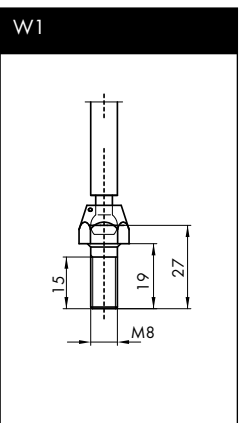
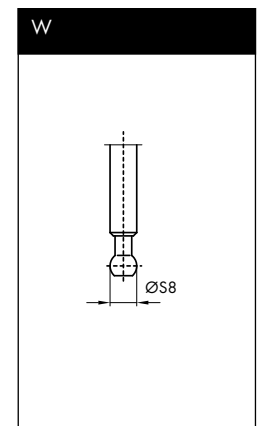
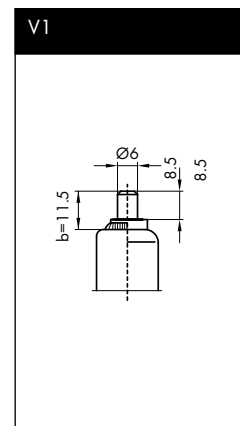
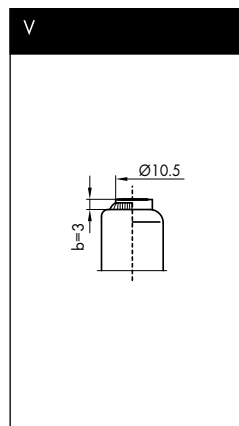
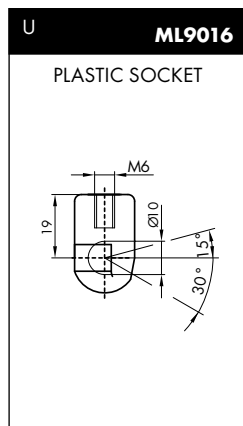
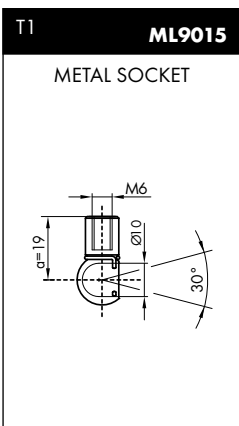
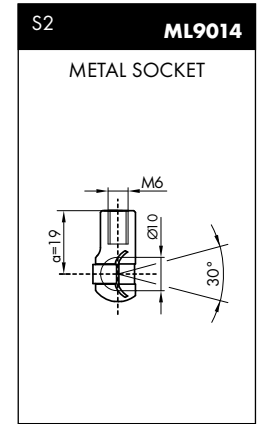
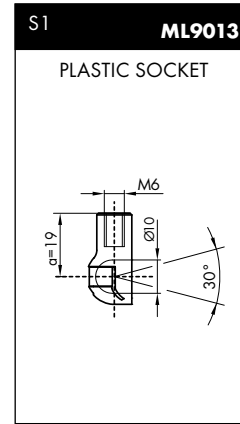
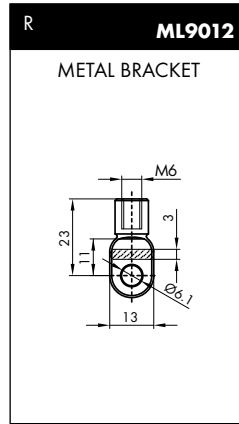
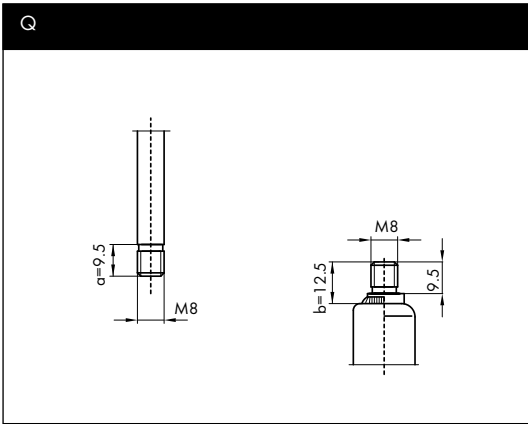

MOUNTING TYPES

MOUNTING

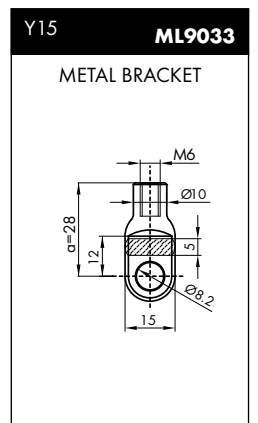
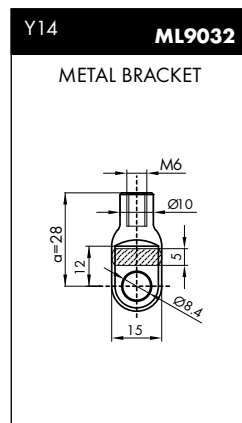
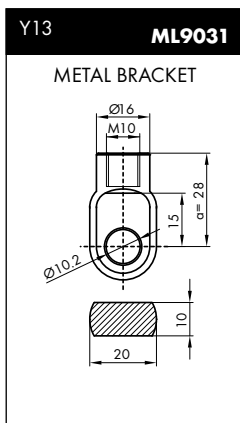
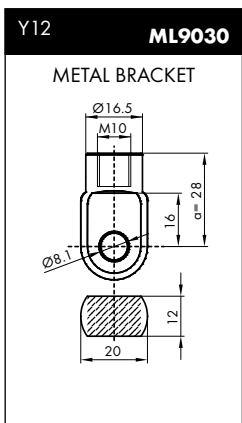
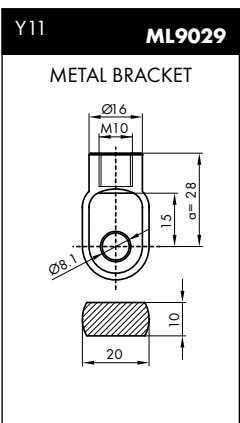
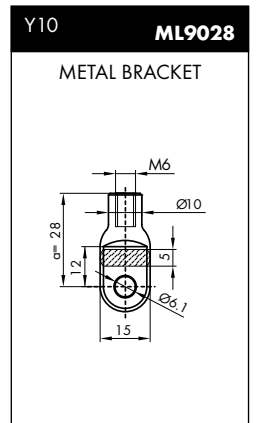
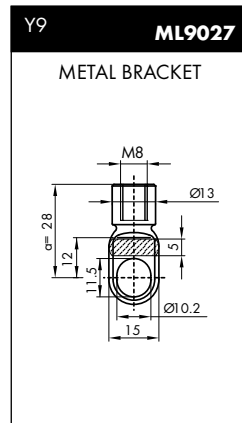
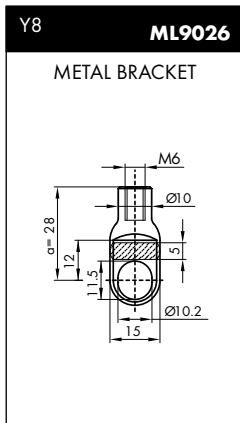
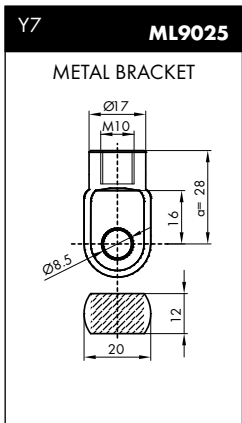
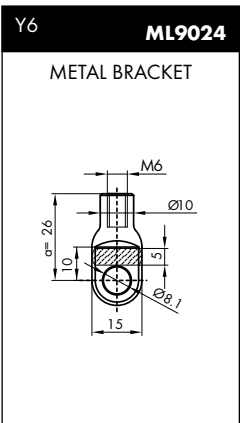
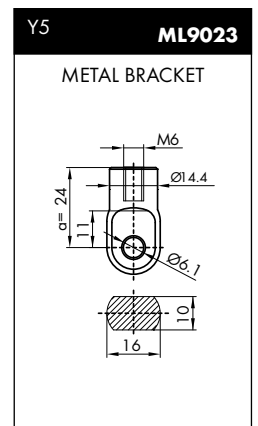
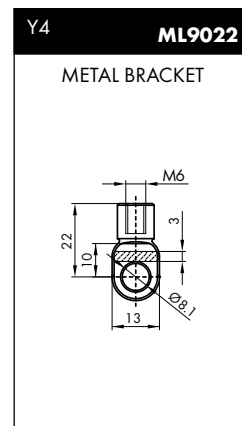
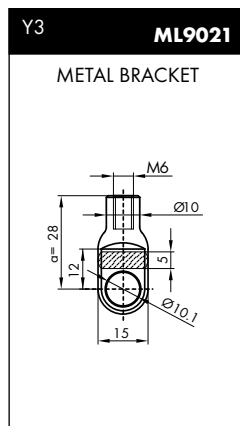
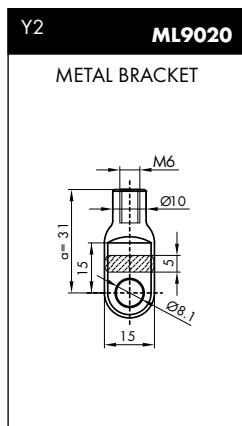
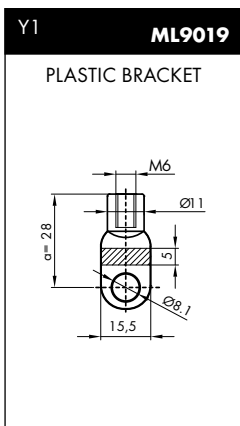
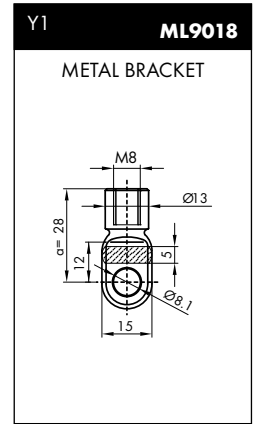
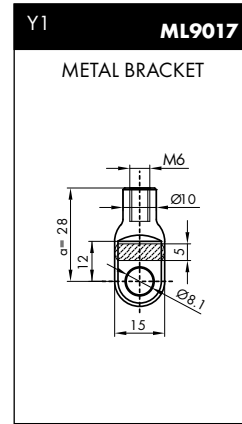
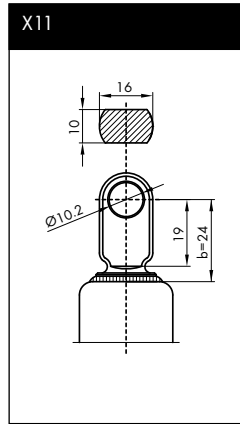
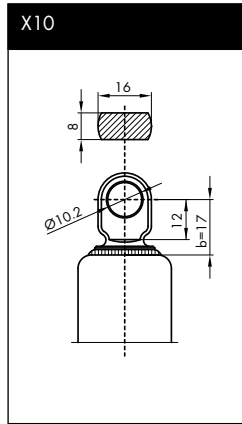
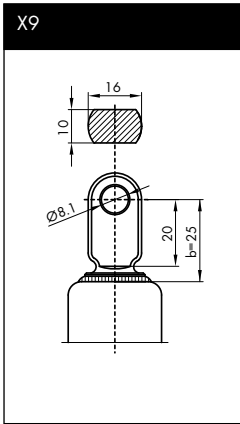

MOUNTING TYPES

MOUNTING TYPES

MOUNTING

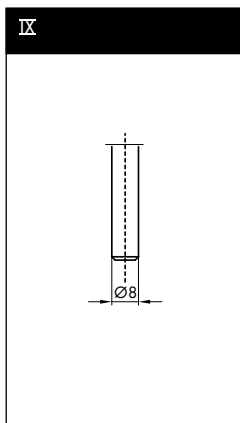
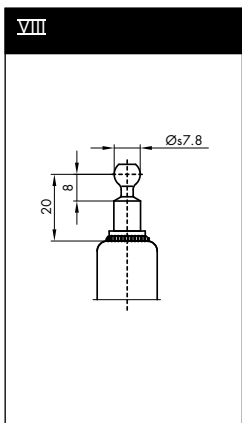
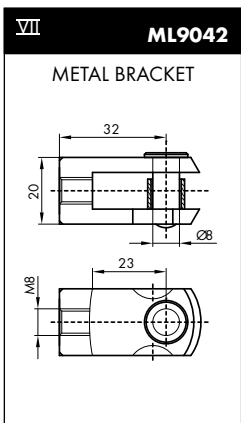
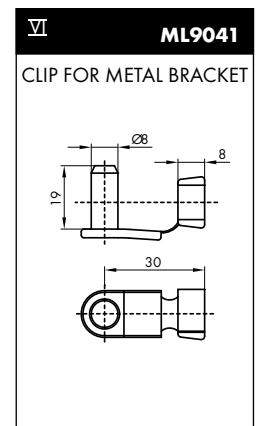
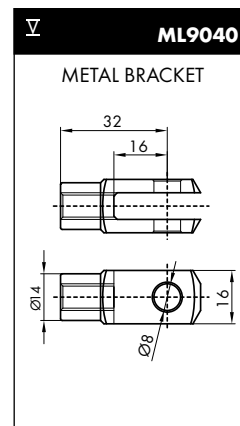
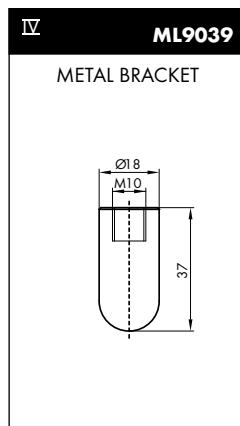
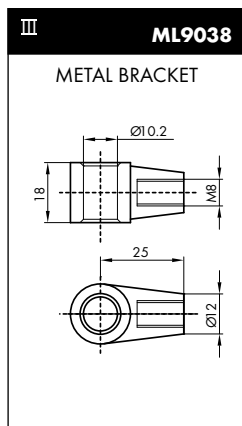
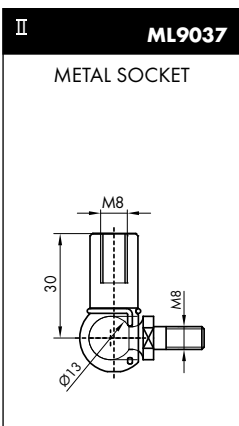
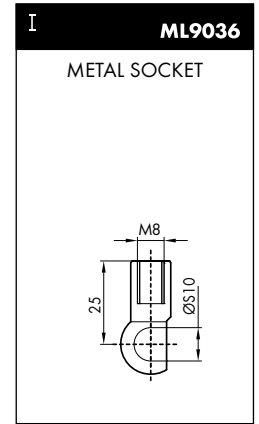
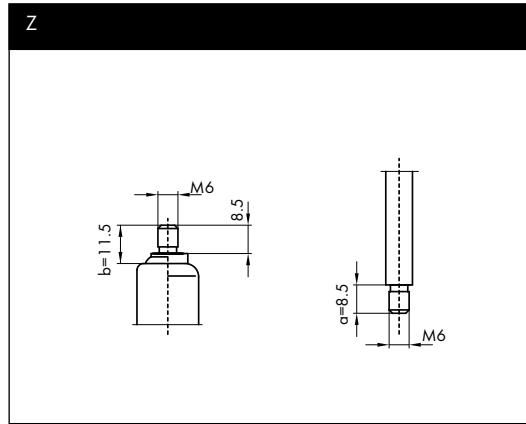
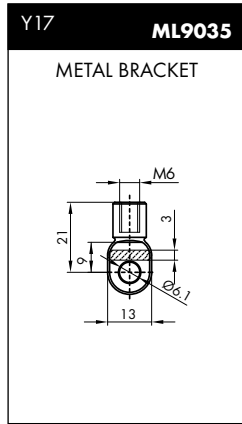
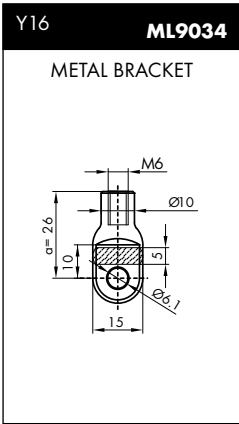

BALL STUD

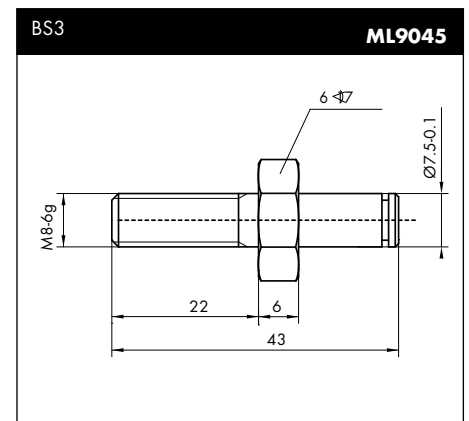
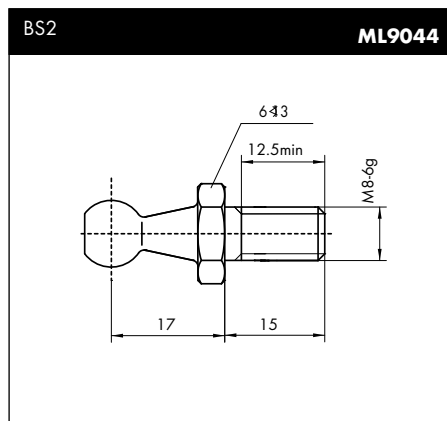
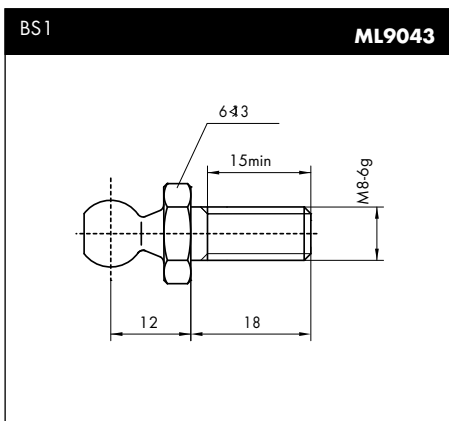

MOUNTING TYPES

BALL STUD

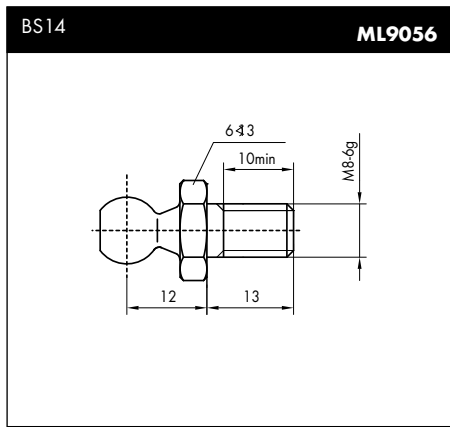
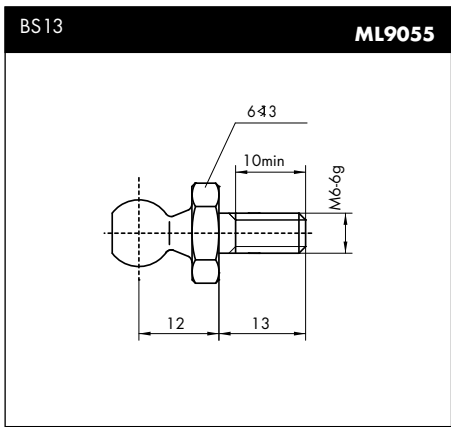
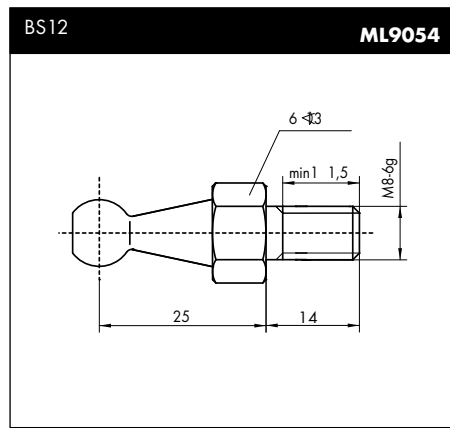
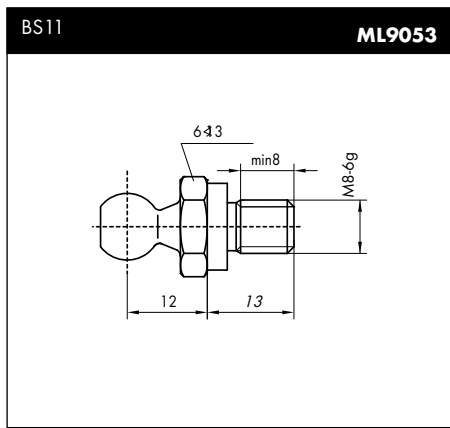
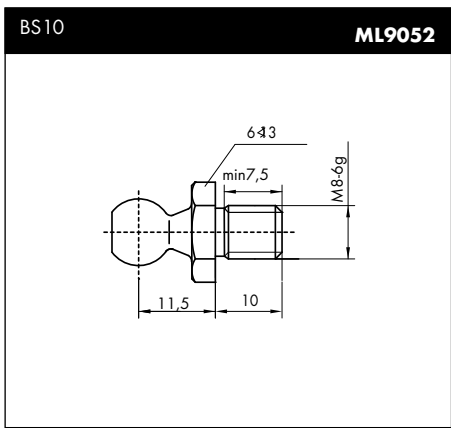
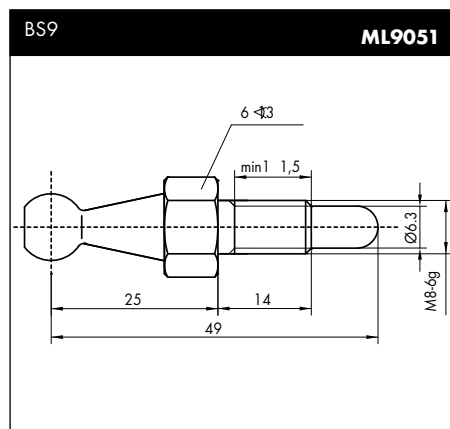
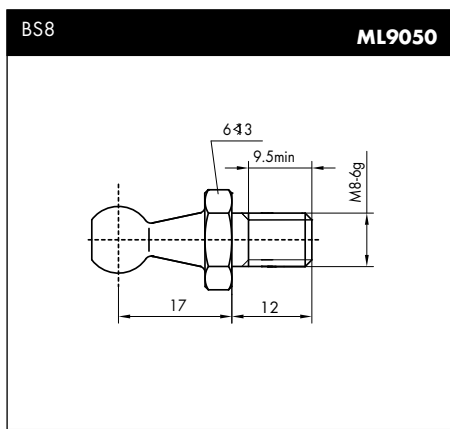
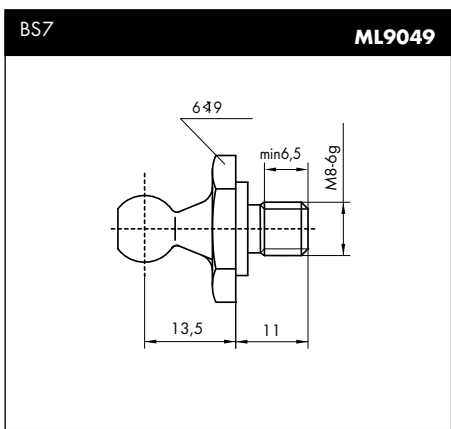
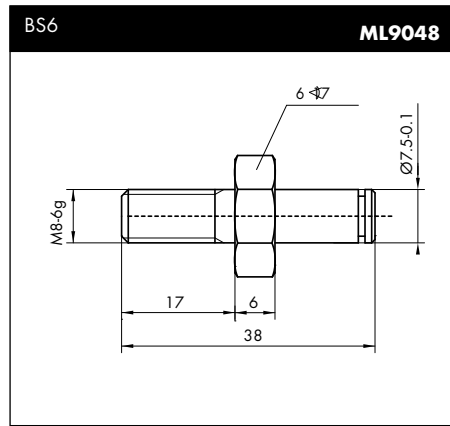
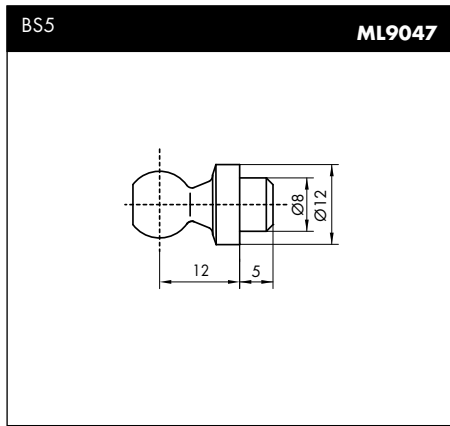
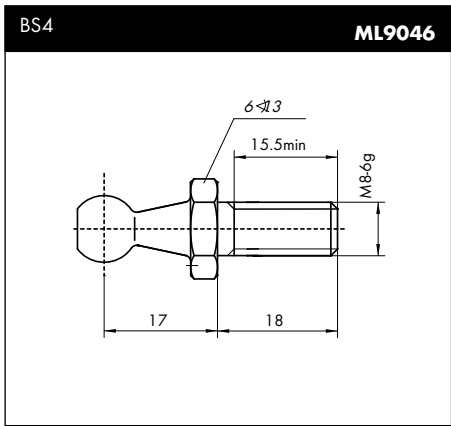

Warranty Terms

(valid in Europe only)

**MONROE® Europe warrants the listed
MONROE® products to the original retail purchaser
against functional and/or material defects:**



**MONROE® Quick-Strut
MONROE® Reflex
MONROE® Springs**



**MONROE® Adventure
MONROE® Gas-Magnum
MONROE® Level-Light
MONROE® Load-Leveler
MONROE® Magic Camber
MONROE® Max Lift
MONROE® Mounting Kit**

**MONROE® Original
MONROE® Protection Kit
MONROE® Ride-Leveler
MONROE® Sensa-Trac
MONROE® Spheres
MONROE® Steering & Suspension
MONROE® Van-Magnum**

MONROE® Europe provides a 2 year warranty without mileage limitation.
(3 year warranty for MONROE® Reflex, MONROE® Quick-Strut, MONROE® Springs)
The Warranty of MONROE® Europe is limited to the delivery of a new MONROE® product.
All claims are first handled by the MONROE® distributor and then honoured by MONROE®.

The reseller/installer will provide the MONROE® distributor with all relevant information such as:

- consumer's name and address
- fitting or sales dates
- MONROE® product part number
- vehicle identification data
- proof of purchase documents
- description of the defect.

Excluded from warranty are:

1. Regular wear-out.
2. MONROE® products fitted contrary to application information in the MONROE® catalogue or its subsequent amendments.
3. MONROE® products which have been modified or damaged by incorrect mounting or incorrect use of the vehicle, contrary to the car manufacturers' specifications or MONROE®s.
4. MONROE® products damaged by mounting on another car than indicated in the MONROE® catalogue or its subsequent amendments.
5. Shock absorbers with damaged piston rod or damaged oil seal due to holding the piston rod with a wrench or pliers instead of the correct tool.
6. Premature wear-out caused by re-use of damaged mounting parts such as: rubber dirt shields, damaged bump stops, etc.
7. Damages caused by an accident.
8. MONROE® products damaged while used in rally or racing sports.
9. Ride-Levelers with air sleeve abrasion caused by incorrect mounting.
10. Reconditioned or recycled MONROE® products.
11. Defects caused by lack of maintenance or maintenance wrongly executed on the vehicle.

In addition: All MONROE® products are developed and manufactured according to original suspension specifications from car manufacturers. MONROE® indicates in its catalogue the originally lowered models on which its products fit.

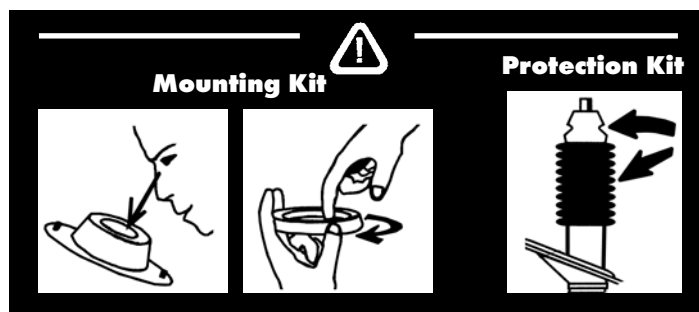
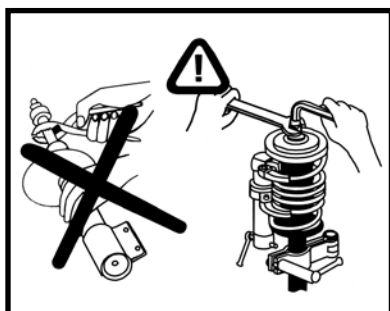

MONROE®

» our expert vision,
YOUR SAFETY »



TENNECO



Tenneco Aftermarket offices

Customer Service

all regions except: France, Spain, UK
T +32 11 703 164 North and West Europe
T +32 11 703 335 South and East Europe
F +32 11 703 310

Customer Service France

T +33 (0)970 80 96 85
F +33 (0)243 68 43 64

Customer Service Spain / Portugal

T +34 902 197 300
F +34 916 710 800

Customer Service UK / Ireland

T +44 (0)121 609 3000
F +44 (0)121 609 3037

Tenneco Europe - Tenneco Benelux

Avenue du Bourgetlaan 50
1130 Brussels, Belgium
T +32 2 706 90 00
F +32 2 706 91 99

Tenneco Baltics, Belarus, Russia

PERKUNO av. 1
44221 Kaunas, Lithuania
T +370 37 32 08 90
F +370 37 32 08 86

Tenneco CEE South

Prekratova 39
10020 Zagreb, Croatia
T +385 16 529 500
F +385 16 529 058

Tenneco Czech Republic

Rychnovska 383
463 42 Hodkovice nad Mohelkou
Czech Republic
T +420 602 627 022
F +420 585 004 473

Tenneco Denmark

Sjællandsvej 2
5500 Middelfart, Denmark
T +45 63 41 33 00
F +45 63 41 33 20

Tenneco France

103 rue Charles Michels
93284 cedex Saint-Denis, France
T +33 (0)970 80 96 85
F +33 (0)2 43 68 43 64

Tenneco Germany

Luitpoldstrasse 83
67480 Edenkoben, Deutschland
T +49 6323 47 2900
F +49 6323 47 2905

Tenneco Iberica

Avda. de la Cañada, 64-66
posterior - P.I. Coslada
28820 Coslada, Madrid, Spain
T +34 902 197 300
F +34 916 710 800

Tenneco Italy

Via W. Tobagi, 13
20068 Peschiera Borromeo
(Milano) Italia
T +39 025536391
F +39 0255305036

Tenneco Middle East, Africa

Avenue du Bourgetlaan 50
1130 Brussels, Belgium
T +32 2 706 90 20
F +32 2 706 90 29

Tenneco Poland & CEE

T +32 11 703 335

Tenneco Portugal

Parque Industrial da Autoeuropa
2950-403 Pamela, Portugal
T +34 902 197 300
F +34 916 710 800

Tenneco South Africa

Block B, 2nd Floor, Pellmeadow Office Park,
60 Civin Drive, Essexwold, Bedfordview
2007 Johannesburg, South Africa
T +27 11 454 5031 or 5032
F +27 11 574 5618

Tenneco Sweden

Rosendalsvägen 5
340 15 Vittaryd, Sweden
T +46 372 705 00
F +46 372 703 60

Tenneco Turkey

Çavuşoğlu Mah. Spor Cad.
No: 86 34873 Kartal - İstanbul, Türkiye
T +90216 586 84 84
F +90216 586 84 60

Tenneco UK

Wharfdale Road
Birmingham B11 2DF, England
T +44 (0)121 609 3000
F +44 (0)121 609 3037

Tenneco Ukraine, CIS, Israel

Desnyanska 19, office 4
03058 Kyiv, Ukraine
T +380 44 277 45 41
F +380 44 277 45 42

Tenneco Original Equipment - Ride Control Plants Worldwide

NORTH AMERICA

Paragould, Arkansas
Long Beach, California
Hartwell, Georgia
Angola, Indiana
Cozad, Nebraska
Kettering, Ohio
Napoleon, Ohio
Owen Sound, Ontario, Canada
Celaya, Mexico
Reynosa, Mexico

SOUTH AMERICA

Rosário, Argentina
Cofia, Brazil
Mogi Mirim, Brazil

EUROPE

Sin-Truiden, Belgium
Hodkovice, Czech Republic
Poissy, France*
Hannover, Germany*
Bologna, Italy
Gliwice, Poland

Ermua, Spain
Gijon, Spain
Port Elizabeth, South Africa

ASIA

Beijing, China
Suzhou, China
Gurgaon, India*
Hosur, India
Pondicherry, India
Pune, India*

AUSTRALIA/ NEW ZEALAND

Adelaide, Australia
Sydney, Australia
Wellington, New Zealand



* Just-In-Time (JIT) plant

MONROE®

Online Catalogue www.monroecatalogue.eu

