



# Aral Ölwegweiser – Lubrication Index.

Motoren- und Getriebeölempfehlungen für Pkw und Kleintransporter.  
Lubricant recommendations for passenger cars and vans.

# Sauber. Sicher. Souverän.

Leistungsfähige Motorenöle von Aral für jeden Einsatzzweck senken den Kraftstoffverbrauch, schützen sicher vor Verschleiß und vermindern den Ölverbrauch.



Erfüllt alle XMF-Leistungsanforderungen.



## Aral EcoTronic F 5W-20



Das Hochleistungsmotorenöl in Aral Synthetic-Technologie wurde speziell für die Ford EcoBoost® Motoren entwickelt, die ein Motorenöl gemäß der Spezifikation Ford WSS-M2C948-B erfordern.

Das Produkt kann auch in den meisten anderen modernen Ford Motoren eingesetzt werden, die ein Motoröl der Spezifikation Ford WSSM2C913-B, WSS-M2C913-C oder WSS-M2C925-B (mit der Ausnahme Ford Ka, Focus ST und Focus RS) benötigen.



**Spezifikationen/Freigaben:**  
Erfüllt Ford WSS-M2C948-B

## Aral SuperTronic SAE 0W-40



Das vollsynthetische Hochleistungs-Motorenöl für Otto- und Dieselmotoren mit und ohne Dieselpartikelfilter.

- universell einsetzbar durch breites Freigabeprofil
- Aral Low SAPS-Technologie für maximale Lebensdauer des Dieselpartikelfilters
- Sicherheit für den Motor bei unverändert langen Ölwechselintervallen
- hohe Kraftstoffeinsparung bis zu 3 % und verbessertes Abgasverhalten



**Spezifikationen/Freigaben:**  
ACEA C2, C3 • API SN/ CF • MB-Freigabe 229.31 / 229.51 • BMW Longlife-04 • erfüllt Fiat 9.55535-S2

## Aral SuperSynth 0W-40



Bei dem neuen Aral SuperSynth 0W-40 handelt es sich um ein Produkt, das speziell für leistungsstarke Motoren in Sportwagen und Fahrzeugen der Luxusklasse entwickelt wurde. Mit seiner ausgewogenen Additivtechnologie bietet es eine gleichbleibende Performance auch bei längsten Wartungsintervallen und kann überall dort eingesetzt werden, wo ein Öl nach ACEA A3/B4 mit einer Porsche A40 Freigabe gefordert wird.



**Spezifikationen/Freigaben:**  
Porsche A40

## Aral SuperTronic E SAE 0W-30



Das High-Performance-Motorenöl in Aral Synthese-Technologie.

- für Pkw-Otto- und -Dieselmotoren z.B. von Volvo, Honda und Renault, die Motorenöle nach ACEA A5/B5 verlangen
- für verlängerte Ölwechselintervalle bei bestimmten Volvo-Modellen



**Spezifikationen/Freigaben:**  
ACEA A5/B5 • API SL/ CF

## Aral SuperTronic G SAE 0W-30



Das vollsynthetische Hochleistungs-Motorenöl für Mercedes-Benz, VW, BMW- und GM-/ Opel-Pkw mit Otto- und Dieselmotoren.

- erfüllt höchste Anforderungen an den Verschleißschutz
- Leichtlauföl zur Erzielung von verlängerten Ölwechselintervallen bei flexiblen Wartungsperioden



**Spezifikationen/Freigaben:**  
ACEA A3/B3, A3/B4 • API SL/ CF • MB-Freigabe 229.3/ 229.5 • VW 502 00/ 505 00 • BMW Longlife-01 • Opel GM-LL-A-025/ GM-LL-B-025 • erfüllt Fiat 9.55535-G1

## Aral SuperTronic LongLife III SAE 5W-30



Das High-Performance-Motorenöl speziell für Pkw des VW Konzerns\* (VW, Audi, SEAT, Škoda) mit Otto- und Dieselmotoren.

- erfüllt höchste Anforderungen an den Verschleißschutz
- Aral Low SAPS-Technologie für maximale Lebensdauer des Dieselpartikelfilters
- für Fahrzeuge mit und ohne LongLife-Service geeignet



**Spezifikationen/Freigaben:**  
ACEA C3 • MB-Freigabe 229.51 • VW 503 01/ 504 00/ 507 00 (erfüllt die technischen Anforderungen der ehemaligen VW-Norm 503 01) • BMW Longlife-04 • Porsche C30

## Aral HighTronic C SAE 5W-30



Das High-Performance-Motorenöl in Aral Synthese-Technologie.

- speziell für PKW mit Dieselpartikelfilter entwickelt, welche ein ACEA C1 oder C2 Motorenöl benötigen
- mit Aral Low SAPS-Technologie für maximale Lebensdauer des Dieselpartikelfilters



**Spezifikationen/Freigaben:**  
ACEA C1, C2 • STJLR.03.5005 • erfüllt Ford WSS-M2C934-B

## Aral HighTronic F SAE 5W-30



Das High-Performance-Motorenöl in Aral Synthese-Technologie speziell für Pkw von Ford, Chrysler, Jaguar und Land Rover.

- für Otto- und Dieselmotoren



**Spezifikationen/Freigaben:**  
ACEA A1/B1, A5/B5 • API SL/ CF • Ford WSS-M2C913-A, WSS-M2C913-B, WSS-M2C913-C, WSS-M2C913-D • ILSAC GF4

## Aral HighTronic G SAE 5W-30



Das High-Performance-Motorenöl in Aral Synthese-Technologie.

- für alle Opel Benzin- und Dieselmotore mit GM dexos2 Anforderung. Das Produkt ist voll rückwärts kompatibel, d.h. auch für alle älteren Fahrzeuge, z. B. gemäß der vorherigen Norm GM-LL-A-025 und GM-LL-B-025 geeignet.
- moderne Aral Low SAPS-Technologie für maximale Lebensdauer und Schutz von Partikelfiltern und Katalysatoren



**Spezifikationen/Freigaben:**  
ACEA C3 • API SM/ CF • MB-Freigabe 229.31 / 229.51 • Erfüllt GM dexos2® Anforderungen (geeignet für Fahrzeuge, die GM-LL-A-025 oder GM-LL-B-025 fordern)

## Aral HighTronic J SAE 5W-30



Das High-Performance-Motorenöl in Aral Synthese-Technologie.

- speziell für Fahrzeuge französischer und asiatischer Hersteller, welche ein Motorenöl nach ACEA C2 Spezifikation benötigen
- moderne Aral Low SAPS-Technologie für maximale Lebensdauer und Schutz von Partikelfiltern und Katalysatoren



**Spezifikationen/Freigaben:**  
ACEA C2 • API SN • erfüllt Fiat 9.55535-S1 • erfüllt PSA B71 2290

## Aral HighTronic R SAE 5W-30



Das High-Performance-Motorenöl in Aral Synthese-Technologie.

- speziell für alle modernen Renault Diesel, Pkw auch mit Partikelfilter
- moderne Aral Low SAPS-Technologie für maximale Lebensdauer und Schutz von Partikelfiltern und Katalysatoren



**Spezifikationen/Freigaben:**  
ACEA C4 • MB-Freigabe 226.51 • Renault RN0720

## Aral HighTronic M SAE 5W-40



Das High-Performance-Motorenöl in Aral Synthese-Technologie für anspruchsvolle Fahrbedingungen.

- für Otto- und Dieselmotoren
- moderne Aral Low SAPS-Technologie für maximale Lebensdauer und Schutz von Partikelfiltern und Katalysatoren
- große Leistungsreserven in Motoren mit verlängerten Ölwechselintervallen und geringem Ölnachfüllbedarf
- spart Kraftstoff und schon die Umwelt



**Spezifikationen/Freigaben:**  
ACEA C3 • API SN/ CF • MB-Freigabe 229.31/ 229.51 • VW 502 00/ 505 00/ 505 01 • BMW Longlife-04 • Porsche A40 • erfüllt Ford WSS-M2C917-A • erfüllt Fiat 9.55535-S2 • Renault RN0700 / RN0710

## Aral HighTronic N SAE 5W-40



Das High-Performance-Motorenöl in Aral Synthese-Technologie für anspruchsvolle Fahrbedingungen. Aschehaltige Formulierung mit erstklassiger Additivierung.

- bei Mercedes Benz für Pkw mit Otto- sowie alle Dieselmotoren ohne Partikelfilter



**Spezifikationen/Freigaben:**  
ACEA A3/B3, A3/B4 • API SN/ CF • MB-Freigabe 229.3/ 229.5/ 226.5 • VW 502 00/ 505 00 • BMW Longlife-01 • Porsche A40 • Renault RN0700 / RN0710

## Aral BlueTronic SAE 10W-40



Das Leichtlauf-Motorenöl mit Aral Synthese-Technologie.

- für Otto- und Dieselmotoren



**Spezifikationen/Freigaben:**  
ACEA A3/B4 • API SL/ CF • MB-Freigabe 229.1 • VW 501 01/ 505 00 • erfüllt Fiat 9.55535-D2

# Aral Motorenöle – Freigaben



Achtung: Bitte die Herstellervorschriften beachten –  
Angaben hierzu finden Sie in der Betriebsanleitung in Ihrem Fahrzeughandbuch.

Produktname	ACEA	API	MB-Freigabe	VW	BMW	Porsche	Opel/GM	Ford	Fiat	Renault	Sonstige	Bemerkungen
EcoTronic F 5W-20								M2C948-B				Für Ford EcoBoost Motoren!
SuperTronic SAE 0W-40	C3, C2	SN/ CF	229.51 229.31		Long-life-04				erfüllt 9.55535-S2			Auch für Fzg. mit DPF
SuperSynth 0W-40						A40						
SuperTronic E SAE 0W-30	A5/B5	SL/ CF										Abgesenkte HTHS! Nur für spez. Motoren, z. B. Volvo
SuperTronic G SAE 0W-30	A3/B3, A3/B4	SL/ CF	229.5 229.3	502 00 505 00	Long-life-01		GM-LL-A-025 GM-LL-B-025		erfüllt 9.55535-G1			
SuperTronic LongLife III SAE 5W-30	C3		229.51	503 01 504 00 507 00	Long-life-04	C30						Speziell für Fahrzeuge der VW-Gruppe mit DPF und WIV; HTHS > 3,5
HighTronic C SAE 5W-30	C1/ C2							M2C934-B			STJLR.03.5005	
HighTronic F SAE 5W-30	A1/B1, A5/B5	SL/ CF						M2C913-A M2C913-B M2C913-C M2C913-D			ILSAC GF-4	
HighTronic G SAE 5W-30	C3	SM/ CF	229.51 229.31				dexos2					
HighTronic J SAE 5W-30	C2	SN							erfüllt 9.55535-S1			erfüllt PSA B71 2290
HighTronic R SAE 5W-30	C4		226.51							RN0720		
HighTronic SAE 5W-40	C3	SN/ CF	229.31 229.51	502 00 505 00 505 01	Long-life-04	A40		M2C917-A	erfüllt 9.55535-S2	RN0700 / RN0710		Auch für Mazda Pkw mit DPF
HighTronic M SAE 5W-40	A3/B3, A3/B4	SN/ CF	229.5 229.3 226.5	502 00 505 00	Long-life-01	A40				RN0700 / RN0710		
BlueTronic SAE 10W-40	A3/B4	SL/ CF	229.1	501 01 505 00					erfüllt 9.55535-D2			

# High performance engine oils „Made in Germany“

Aral premium products reduce oil and fuel consumption and protect against wear.



Meets all XMF performance requirements.

## Aral EcoTronic F 5W-20



Aral EcoTronic F 5W-20 is a high-performance engine oil in Aral Synthetic-Technology specially engineered for Ford EcoBoost® engines that need an oil according to Ford WSSM2C948-B.

It is also suitable for use in most modern Ford petrol engines that require an oil according to Ford WSS-M2C913-B, WSS-M2C913-C or WSS-M2C925-B (with the exception of Ford Ka, Focus ST and Focus RS). The product is able to provide extra fuel economy.



**Specifications/approvals:**  
meets Ford WSS-M2C948-B

## Aral HighTronic F SAE 5W-30



High performance engine oil in Aral Synthetic-Technology especially for cars from Ford, Chrysler, Jaguar and Land Rover.

- For petrol and diesel engines



**Specifications/approvals:**  
ACEA A1/B1, A5/B5 • API SL/ CF • Ford WSS-M2C913-A, WSS-M2C913-B, WSS-M2C913-C, WSS-M2C913-D • ILSAC GF4

## Aral SuperTronic SAE 0W-40



Fully synthetic high performance engine oil for petrol and diesel engines with and without diesel particle filter.

- Universally applicable with an extensive approval profile
- 'Aral Low SAPS-Technology' maximizes diesel particle filter lifespan
- Safety for the engine at extended oil drain intervals
- Lower fuel consumption of approximately 3% and improved emissions performance



**Specifications/approvals:**  
ACEA C2, C3 • API SN/ CF • MB-Approval 229.31 / 229.51 • BMW Longlife-04 • meets Fiat 9.55535-S2

## Aral HighTronic G SAE 5W-30



High performance engine oil in Aral Synthetic-Technology.

- Specially developed for all Opel petrol and diesel models with GM dexos2 requirement starting with model year 2010. This product is 100% backward compatible so it can be used in older vehicles, e.g. as per standard GM-LL-A-025 and GM-LL-B-025.
- Modern Low Ash-formula for a maximum life-circle and protection of particle filter as well as catalytic converters



**Specifications/approvals:**  
ACEA C3 • API SM/ CF • MB-Approval 229.31 / 229.51 • meets GM dexos2® requirements (suitable for all vehicles that require GM-LL-A025 or GM-LL-B025)

## Aral SuperSynth 0W-40



The new Aral SuperSynth 0W-40 is a product that is specifically designed for high-performance engines in sports cars and luxury vehicles. With its balanced additive technology it provides consistent performance even with the longest service intervals and can be used anywhere where an oil according to ACEA A3/B4 with a Porsche A40 release required.



**Specifications/approvals:**  
Porsche A40

## Aral HighTronic J SAE 5W-30



High performance engine oil in Aral Synthetic-Technology.

- Especially for vehicles from French and Asian manufacturers that require engine oil as per ACEA C2 specification.
- Modern Aral Low SAPS-Technology for a maximum life-circle and protection of particle filter as well as catalytic converters



**Specifications/approvals:**  
ACEA C2 • API SN • meets Fiat 9.55535-S1 • meets PSA B71 2290

## Aral SuperTronic E SAE 0W-30



High performance engine oil in Aral Synthetic-Technology.

- For petrol and diesel engines in cars, e.g. from Volvo, Honda and Renault, that require engine oils as per ACEA A5/B5
- For extended drain intervals for certain Volvo models



**Specifications/approvals:**  
ACEA A5/B5 • API SL/ CF

## Aral HighTronic R SAE 5W-30



High performance engine oil in Aral Synthetic-Technology.

- Especially for all modern Renault diesel models also with particle filters
- Modern Aral Low SAPS-Technology for a maximum life-circle and protection of particle filter as well as catalytic converters



**Specifications/approvals:**  
ACEA C4 • MB-Approval 226.51 • Renault RN0720

## Aral SuperTronic G SAE 0W-30



Fully synthetic high-performance engine oil for Mercedes-Benz, VW, BMW and GM/Opel cars with petrol and diesel engines.

- Fulfills the most rigorous anti-wear standards
- provides longest oil drain intervals at flexible service cycles



**Specifications/approvals:**  
ACEA A3/B3, A3/B4 • API SL/ CF • MB-Approval 229.3 / 229.5 • VW 502 00/ 505 00 • BMW Longlife-01 • Opel GM-LL-A-025/ GM-LL-B-025 • meets Fiat 9.55535-G1

## Aral HighTronic M SAE 5W-40



High performance engine oil in Aral Synthetic-Technology for demanding driving conditions.

- For petrol and diesel engines
- Modern Aral Low SAPS-Technology for a maximum life-circle and protection of particle filter as well as catalytic converters
- High power reserves in engines with extended drain intervals and minimal top up requirement
- Saves fuel and protects the environment



**Specifications/approvals:**  
ACEA C3 • API SN/ CF • MB-Approval 229.31/ 229.51 • VW 502 00/ 505 00 / 505 01 • BMW Longlife-04 • Porsche A40 • meets Ford WSS-M2C917-A • meets Fiat 9.55535-S2 • Renault RN0700 / RN0710

## Aral SuperTronic LongLife III SAE 5W-30



High performance engine oil especially for VW Group cars\* (VW, Audi, SEAT and Skoda).

- For petrol and diesel engines
- Fulfills the most rigorous anti-wear standards
- 'Aral Low SAPS-Technology' for maximum diesel particle filter service life
- Suitable for vehicles with and without LongLife service



**Specifications/approvals:**  
ACEA C3 • MB-Approval 229.51 • VW 503 01/ 504 00/ 507 00 (meets the technical requirements of former VW standard 503 01) • BMW Long-life-04 • Porsche C30

## Aral HighTronic C SAE 5W-30



High performance engine oil in Aral Synthetic-Technology.

- Developed particularly for passenger cars with diesel particle filters requiring an ACEA C1 or C2 compliant engine oil
- With Aral low SAPS-Technology to help maximize life span of diesel particle filters



**Specifications/approvals:**  
ACEA C1, C2 • STJLR.03.5005 • meets Ford WSS-M2C934-B

## Aral BlueTronic SAE 10W-40



Low-friction engine oil in Aral Synthetic-Technology.

- For petrol and diesel engines

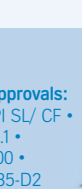

**Specifications/approvals:**  
ACEA A3/B4 • API SL/ CF • MB-Approval 229.1 • VW 501 01/ 505 00 • meets Fiat 9.55535-D2

# Aral engine oils - specifications & approvals



Please refer to the manufacturer's handbook.

Product Name	ACEA	API	MB-Approval	VW	BMW	Porsche	Opel/GM	Ford	Fiat	Renault	Others	Remarks
EcoTronic F 5W-20								M2C948-B				For Ford ecoboost engines!
SuperTronic SAE 0W-40	C3, C2	SN/ CF	229.51 229.31		Long-life-04				meets 9.55535-S2			Also for vehicles with DPF
SuperSynth 0W-40						A40						
SuperTronic E SAE 0W-30	A5/B5	SL/ CF										Lowered HTHS! Only for special engines, e. g. Volvo
SuperTronic G SAE 0W-30	A3/B3, A3/B4	SL/ CF	229.5 229.3	502 00 505 00	Long-life-01		GM-LL-A-025 GM-LL-B-025		meets 9.55535-G1			
SuperTronic LongLife III SAE 5W-30	C3		229.51	503 01 504 00 507 00	Long-life-04	C30						Especially for VW-Group cars with DPF and WIV; HTHS > 3,5
HighTronic C SAE 5W-30	C1/C2							M2C934-B			STJLR.03.5005	
HighTronic F SAE 5W-30	A1/B1, A5/B5	SL/ CF						M2C913-A M2C913-B M2C913-C M2C913-D			ILSAC GF-4	
HighTronic G SAE 5W-30	C3	SM/ CF	229.51 229.31				dexos2					
HighTronic J SAE 5W-30	C2	SN							meets 9.55535-S1			meets PSA B71 2290
HighTronic R SAE 5W-30	C4		226.51							RN0720		
HighTronic SAE 5W-40	C3	SN/ CF	229.31 229.51	502 00 505 00 505 01	Long-life-04	A40		M2C917-A	meets 9.55535-S2	RN0700 / RN0710		Also for Mazda cars with DPF
HighTronic M SAE 5W-40	A3/B3, A3/B4	SN/ CF	229.5 229.3 226.5	502 00 505 00	Long-life-01	A40				RN0700 / RN0710		
BlueTronic SAE 10W-40	A3/B4	SL/ CF	229.1	501 01 505 00					meets 9.55535-D2			



## GEBRAUCHSANLEITUNG

**Modelljahr:** '09-'12 bedeutet: von 2009 bis 2012,  
-'12 bedeutet: bis 2012, '12- bedeutet: ab 2012

### Motor:

Füllmenge der Ölwanne:

4,5/7 bedeutet 4,5 oder 7 Liter;

4,5-7 bedeutet zwischen 4,5 und 7 Liter, je nach Motortyp und/oder Ausführung der Ölwanne.

Angaben beziehen sich auf Motorölwechsel einschließlich Ölfilter, falls montiert. Nach dem Ölwechsel ist der Ölstand bei stillstehendem Motor zu kontrollieren, nachdem der Motor kurze Zeit gelaufen hat.

### Füllmenge des Kühlsystems:

12,5/20 bedeutet 12,5 oder 20 Liter;

12,5-20 bedeutet zwischen 12,5 und 20 Liter.

Füllmenge des Kühlsystems in Liter, einschließlich Heizung und/oder Klimaanlage (sofern zur Standardausführung gehörend).

### Transaxle oder Getriebe und Differential:

Füllmenge:

1,3/1,6 bedeutet 1,3 oder 1,6 Liter;

1,3-1,6 bedeutet zwischen 1,3 und 1,6 Liter.

Bei einer Wechsel der Ölsorte, das Getriebe gründlich mit der weiterhin zu verwendeten Ölsorte spülen.

### Transaxle oder Automatikgetriebe:

Für Nachfüllung und Flüssigkeitswechsel Betriebsanleitung beachten.

- ⇌ bedeutet: gemeinsame Schmierung von Getriebe und Differential oder Getriebe und Differential mit Motor.
- ℓ bedeutet: Kapazität der entsprechenden Komponente in Literangabe (Ölfüllmenge, inkl. Filter).
- ⚠ bedeutet: zu entnehmen aus der Fußnote der Komponente. Siehe entsprechende Fußnote in der Textangabe unter der Empfehlungsübersicht des jeweiligen Modells.

Die Produktzuordnung basiert auf den Fahrzeugbestand Stand 11/2013. Die Vorschriften der Fahrzeug- bzw. Aggregathersteller sind zu beachten.

### Gewährleistung:

Obwohl der richtigen Wiedergabe der in dieser Liste aufgeführten Daten jede erdenkliche Sorgfalt geschenkt wurde, kann irgendwelche Haftung für die Folgen etwaiger Fehler oder Unrichtigkeiten in dieser Liste weder vom Zusammensteller noch vom Verleger übernommen werden.

### Alle Rechte vorbehalten.

Nichts aus dieser Ausgabe darf kopiert werden, in irgendeiner Form, ohne ausdrückliche schriftliche Genehmigung des Verlegers.

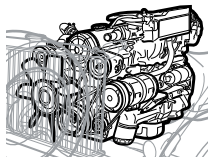

MOTOR

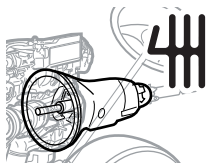

SCHALTGETRIEBE

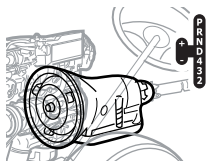

AUTOMATIKGETRIEBE

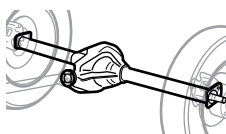

DIFFERENTIAL

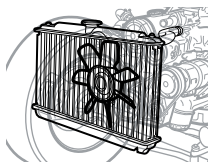

KÜHLANLAGE

## INHALTSVERZEICHNIS

### PKW

ABARTH .....	8	FORD (USA) .....	34	MINI .....	55
ALFA ROMEO .....	8	GALLOPER = HYUNDAI .....		NISSAN .....	57
ASTON MARTIN .....	9	HONDA .....	36	OPEL .....	59
AUDI .....	10	HUMMER .....	37	PEUGEOT .....	61
BENTLEY .....	13	HYUNDAI .....	38	PORSCHE .....	64
BMW .....	13	INFINITI .....	40	RANGE ROVER = LAND ROVER .....	
BUICK .....	17	ISUZU .....	40	RENAULT .....	65
CADILLAC .....	18	JAGUAR .....	41	ROLLS-ROYCE .....	67
CHERY .....	19	JEEP .....	42	ROVER .....	68
CHEVROLET (EU) .....	19	KIA .....	43	SAAB .....	68
CHEVROLET (USA) .....	20	LAMBORGHINI .....	44	SEAT .....	69
CHRYSLER .....	22	LANCIA .....	44	SKODA .....	70
CITROËN .....	23	LAND ROVER .....	45	SMART .....	71
DACIA .....	26	LANDWIND .....	46	SSANGYONG .....	71
DAEWOO = CHEVROLET (EU) .....		LEXUS .....	46	SUBARU .....	72
DAIHATSU .....	26	LOTUS .....	47	SUZUKI .....	73
DAIMLER .....	27	MASERATI .....	47	TESLA .....	74
DODGE .....	27	MAYBACH .....	47	TOYOTA .....	74
FERRARI .....	28	MAZDA .....	48	TVR .....	77
FIAT .....	29	MERCEDES-BENZ .....	49	VOLKSWAGEN .....	77
FISKER .....	31	MG .....	55	VOLVO .....	79
FORD (EU) .....	31	MINI .....	55		

### LIEFERWAGEN

CHEVROLET USA & GMC .....	82	ISUZU .....	87	PIAGGIO .....	92
CITROËN .....	82	IVECO .....	87	RENAULT .....	92
DACIA .....	83	KIA .....	88	SEAT .....	93
DAEWOO-FSO .....	83	LDV .....	88	SKODA .....	93
DAIHATSU .....	83	MAZDA .....	88	SUBARU .....	93
DODGE .....	83	MERCEDES-BENZ .....	89	SUZUKI .....	93
FIAT .....	84	MINI .....	89	TOYOTA .....	93
FORD (EU) .....	85	NISSAN .....	89	VOLKSWAGEN .....	94
FORD (USA) .....	86	OPEL .....	90		
HYUNDAI .....	86	PEUGEOT .....	91		

			SuperTronic						HighTronic			Blue Tronic 10W-40	Aral	⚠	Aral		⚠	Aral	⚠	
			G 0W-30	0W-40	LL III 5W-30	M 5W-40	5W-40	G 5W-30	Synthese	Mineral										
<b>ABARTH</b>																				
500 1.4 T-Jet	'10-	1,65	Spezialprodukt, bitte auf Originalersatzteil des Herstellers zurückgreifen!						1,65	Getr.Öl EP Synth 75W-90	-				↕	↕			4,4	
Grande Punto 1.4 T-Jet	'07-'09	2,6-3,3	●				●		2,55	Getr.Öl EP Synth 75W-90	-				↕	↕			6	
Punto EVO 1.4 T-Jet	'10-	3	●				●		1,5	Spezialprodukt	-				↕	↕			6	
<b>ALFA ROMEO</b>																				
MiTo 1.4 16V 58, 70 kW	'08-	2,9	●				●		1,6	Getr.Öl EP Synth 75W-90	-				↕	↕			5,2	
MiTo 1.4 16V Multi Air 77 kW	'09-	3,4	●				●		1,6	Getr.Öl EP Synth 75W-90	-				↕	↕			5,2	
MiTo 1.4 16V Tjet 88 kW	'08-	3,3	●				●		1,6	Getr.Öl EP Synth 75W-90	-				↕	↕			6	
MiTo 1.4 16V Tjet 110 kW, 114 kW	'08-	3,3	●				●		1,9-2	Getr.Öl EP Synth 75W-90	-				↕	↕			6	
MiTo 1.4 Turbo Multi Air 99 kW	'09-	3,5	●				●		2	Getr.Öl EP Synth 75W-90	-				↕	↕			6	
MiTo 1.4 Turbo Multi Air TCT	'10-	3,5	●				●		-	-	Spezialprodukt				↕	↕			6	
MiTo 1.4 Turbo Multi Air 125 kW	'10-	3,5	●				●		2	Getr.Öl SNS-A 75W-85	-				↕	↕			6	
Alfa 145, 146 1.3-1.7, 16V	'94-'97	4,4-5	●				●	●	2,4	Getriebeöl BS 75W-90	-				↕	↕			6,5-7	
Alfa 145, 146 1.4, 1.6, 1.8 TS 16V	'96-'00	4,4	●				●	●	2	Getriebeöl BS 75W-90	-				↕	↕			8,5	
Alfa 145 Q4, 146 ti	'95-'98	4,4	●				●	●	2	Getriebeöl SNS 75W-80	-				↕	↕			8,5	
Alfa 145 Q4, 146 ti	'98-'00	4,5	●				●	●	2	Getriebeöl BS 75W-90	-				↕	↕			8,5	
Alfa 147 1.6, 2.0 TS 16V	'00-'10	4,4	●				●	●	2	Getriebeöl BS 75W-90	b				↕	↕			7	
Alfa 147 GTA 3.2 V6	'02-'07	5,9	Spezialprodukt, bitte auf Originalersatzteil des Herstellers zurückgreifen!						2	Getr.Öl SNS-A 75W-85	-				↕	↕			9,2	
Giulietta 1.4 Turbo, 1.4 Turbo Multi Air, TCT	'10-	3,1-3,5	●				●		1,9	Spezialprodukt	Spezialprodukt				↕	↕			5,7	
Giulietta 1750 Turbo	'10-	4,25	●				●		1,9	Spezialprodukt	-				↕	↕			6,4	
Alfa 155 1.7-2.0 Twin Spark	'92-'96	5	●				●	●	2	Getriebeöl SNS 75W-80	-				↕	↕			8,5	
Alfa 155 1.6, 1.8, 2.0 TS 16V	'96-'97	4,4	●				●	●	2	Getriebeöl SNS 75W-80	-				↕	↕			8,5	
Alfa 155 Q4 2.0 Turbo	'92-'97	5,5	●				●	●	4	Getriebeöl SNS 75W-80	-				1,3	Getriebeöl BS 75W-90			9,1	
Alfa 155 2.5 V6	'92-'97	6	●				●	●	2	Getriebeöl SNS 75W-80	Getr.Öl ATF E-S	Getriebeöl ATF 55			↕	↕			8,5	
Alfa 156 1.6, 1.8, 2.0 T.Spark	'97-'05	4,4	●				●	●	2	Getriebeöl BS 75W-90	b				↕	↕			7	
Alfa 156 2.0 JTS, Selespeed	'02-'05	4,4	Spezialprodukt, bitte auf Originalersatzteil des Herstellers zurückgreifen!						2	Getriebeöl BS 75W-90	b				↕	↕			6,9	
Alfa 156 2.5 V6 24V	'97-'02	6,4	●				●	●	2	Getriebeöl BS 75W-90	-				↕	↕			9	
Alfa 156 2.5 V6 24V	'02-'05	6,4	●				●	●	2	Getr.Öl SNS-A 75W-85	-				↕	↕			9,2	
Alfa 156 3.2 V6 GTA	'02-'05	5,9	Spezialprodukt, bitte auf Originalersatzteil des Herstellers zurückgreifen!						2	Getr.Öl SNS-A 75W-85	-				↕	↕			9,2	
Alfa 159 1.750 Turbo	'09-'11	4,25	●				●		2	Getr.Öl EP Synth 75W-90	-				↕	↕			6,6	
Alfa 159 1.8 mpi	'06-'10	4,5	●				●		1,6	Getr.Öl EP Synth 75W-90	-				↕	↕			8	
Alfa 159 1.9 JTS, 2.2 JTS	'05-'10	5,4	●				●		2,3	Getr.Öl EP Synth 75W-90	b				↕	↕			8,2	
Alfa 159 3.2 JTS V6, Q4	'05-'10	5,4	●				●		2,8	Getr.Öl EP Synth 75W-90	c	Spezialprodukt		0,75	Getriebeöl BS 75W-90				10,3	
Alfa 164 2.0i Twin Spark	'87-'98	5	●				●	●	1,8	Getriebeöl SNS 75W-80	-				↕	↕			7	
Alfa 164 2.0i Turbo	'87-'98	5,5	●				●	●	1,8	Getriebeöl SNS 75W-80	-				↕	↕			9,5	
Alfa 164 3.0 V6	'87-'98	7	●				●	●	1,8	Getriebeöl SNS 75W-80	Getr.Öl ATF E-S	Getriebeöl ATF 55			↕	↕			9,5	
Alfa 164 Super 2.0 V6 Turbo	'91-'99	6,5	●				●	●	1,8	Getriebeöl SNS 75W-80	-				↕	↕			9,5	
Alfa 164 Super 3.0 V6 24V	'92-'99	7,5	●				●	●	1,8	Getriebeöl SNS 75W-80	Getr.Öl ATF E-S	Getriebeöl ATF 55			↕	↕			12	
Alfa 164 Q4	'93-'98	7,5	●				●	●	1,8	Getriebeöl SNS 75W-80	a			1,1	Getriebeöl BS 75W-90				12	
Alfa 166 2.0 TS	'98-'03	4,4	●				●	●	1,6	Getriebeöl BS 75W-90	-				↕	↕			8	
Alfa 166 2.0 TS	'03-'07	4,4	●				●	●	1,6	Getriebeöl BS 75W-90	-				↕	↕			7,9	
Alfa 166 2.0 TB, 2.5, 3.0 V6	'98-'03	6,1	●				●	●	1,6-1,7	Getriebeöl BS 75W-90	Spezialprodukt				↕	↕			10,5	
Alfa 166 2.0 TB, 2.5, 3.0 V6	'03-'07	5,9-6,1	●				●	●	1,7	Getriebeöl BS 75W-90	Getr.Öl ATF E-S	Getriebeöl ATF 55			↕	↕			10,3-10,5	
Alfa 166 3.2 V6	'04-'07	5,9	Spezialprodukt, bitte auf Originalersatzteil des Herstellers zurückgreifen!						2	Getr.Öl SNS-A 75W-85	-				↕	↕			10,3	
Alfa GT 1.8 T.Spark	'04-'10	4,4	●				●	●	2	Getriebeöl BS 75W-90	-				↕	↕			7,2	
Alfa GT 2.0 JTS	'04-'11	4,4	Spezialprodukt, bitte auf Originalersatzteil des Herstellers zurückgreifen!						2	Getriebeöl BS 75W-90	b				↕	↕			7,2	
Alfa GT 3.2 V6	'04-'07	5,9	Spezialprodukt, bitte auf Originalersatzteil des Herstellers zurückgreifen!						2	Getriebeöl BS 75W-90	b				↕	↕			9,2	



Alfa GTV, Spider 1.8, 2.0 TS 16V	'94-'05	4,4		●		●	●	●	2	Getriebeöl BS 75W-90	-			↔	↔		8,5	
Alfa GTV, Spider 2.0 JTS	'03-'05	4,4	Spezialprodukt, bitte auf Originalersatzteil des Herstellers zurückgreifen!						2	Getriebeöl BS 75W-90	-			↔	↔		8,4	
Alfa GTV, Spider V6 2.0 TB	'95-'03	5,9		●		●	●	●	2	Getriebeöl BS 75W-90	-			↔	↔		11,5	
Alfa GTV, Spider 3.0 V6 24V	'95-'03	5,9		●		●	●	●	2	Getriebeöl BS 75W-90	-			↔	↔		11,5	
Alfa GTV, Spider 3.2 V6 24V	'03-'05	5,9	Spezialprodukt, bitte auf Originalersatzteil des Herstellers zurückgreifen!						2	Getriebeöl BS 75W-90	-			↔	↔		11,7	
Alfa Brera, Spider 1750 Turbo	'09-'11	4,25		●			●		2	Getr.Öl EP Synth 75W-90	-			↔	↔		6,6	
Alfa Brera, Spider 2.2 JTS	'06-'10	5,4		●					2,3	Getr.Öl EP Synth 75W-90	b			↔	↔		8,2	
Alfa Brera, Spider 3.2 JTS V6 Q4	'06-'10	5,4		●					2,8	Getr.Öl EP Synth 75W-90	c		0,75	↔	↔	Getriebeöl BS 75W-90	10,3	
8C 4.7 V8	'07-'10	9		●		●	●	●	2,7-3,2	Getriebeöl BS 75W-90	d			↔	↔		12,5	
<b>Diesel</b>																		
MiTo 1.3 JTDm, 1.3 JTDm-2	'08-	3,2	HighTronic C 5W-30; HighTronic J 5W-30						1,86	Getr.Öl EP Synth 75W-90	-				↔	↔		7,2
MiTo 1.6 JTDm 85, 88 kW	'08-	4,6	HighTronic C 5W-30; HighTronic J 5W-30						1,86	Getr.Öl EP Synth 75W-90	-				↔	↔		5,7
Alfa 145, 146 TD	'94-'99	5				●	●	●	2	Getriebeöl SNS 75W-80	-			↔	↔		9	
Alfa 145, 146, 147 JTD	'99-'10	4,4				●	●	●	2	Getriebeöl BS 75W-90	-			↔	↔		6,1	
Alfa 147 1.9 JTD 16V, 1.9 JTDm, 1.9 JTDm 16V, Q2	'02-'10	4,4				●	●	●	-	Getriebeöl BS 75W-90	-			↔	↔		7,2	
Giulietta 1.6 JTDm	'10-	4,2	HighTronic C 5W-30; HighTronic J 5W-30						1,9	Spezialprodukt	-			↔	↔		6,8	
Giulietta 2.0 JTDm	'10-	4,2	HighTronic C 5W-30; HighTronic J 5W-30						1,9	Spezialprodukt	-			↔	↔		6,7	
Alfa 155 2.0 TD, 2.5 TD	'93-'97	5-6,7				●	●	●	2	Getriebeöl SNS 75W-80	-			↔	↔		9-10	
Alfa 156 1.9, 1.9 16V, 2.4 JTD	'97-'07	4,2-5				●	●	●	2	Getriebeöl BS 75W-90	-			↔	↔		6-7	
Alfa 156 1.9 JTDm 16V Q4	'05-'07	4,2				●	●	●	3,2	Getriebeöl BS 75W-90	-		0,75	↔	↔	Getriebeöl BS 75W-90	6,1	
Alfa 156 2.4 JTD 20V	'03-'05	5		●		●	●	●	3	Getriebeöl BS 75W-90	-			↔	↔		7,3	
Alfa 159 1.9 JTDm 8V, 1.9 JTDm 16V	'05-'10	4,6	HighTronic C 5W-30; HighTronic J 5W-30						2,3	Getr.Öl EP Synth 75W-90	Spezialprodukt			↔	↔		7,5	
Alfa 159 2.0 JTDm 16V	'09-'11	4,9	HighTronic C 5W-30; HighTronic J 5W-30						2,8	Getr.Öl EP Synth 75W-90	-			↔	↔		6,1	
Alfa 159 2.4 JTDm 20V	'05-'10	6,4				●			2,8	Getr.Öl EP Synth 75W-90	Spezialprodukt			↔	↔		7,35	
Alfa 159 2.4 JTDm 20V Q4	'07-'09	6,4				●			2,8	Getr.Öl EP Synth 75W-90	-		0,75	↔	↔	Getriebeöl BS 75W-90	7,35	
Alfa 164, -Super 2.5 TD	'89-'98	7,2				●	●	●	1,8	Getriebeöl SNS 75W-80	-			↔	↔		9	
Alfa 166 2.4 JTD	'98-'03	5				●	●	●	1,7	Getriebeöl BS 75W-90	-			↔	↔		9	
Alfa 166 2.4 JTD	'03-'07	5,5				●	●	●	1,7	Getriebeöl BS 75W-90	-			↔	↔		9,1	
Alfa 166 2.4 JTDm 20V	'03-'07	5-5,5				●	●	●	3,2	Getr.Öl SNS-A 75W-85	Getr.Öl ATF E-S	Getriebeöl ATF 55		↔	↔		9,1	
Alfa GT 1.9 JTDm 16V	'04-'10	4,4				●	●	●	2	Getr.Öl SNS-A 75W-85	-			↔	↔		7,2	
Alfa GT 2.4 JTDm 20V	'04-'09	6,4				●			2,8	Getr.Öl EP Synth 75W-90	-			↔	↔		7,3	
Alfa Brera, Spider 2.0 JTDm	'09-'10	4,9	HighTronic C 5W-30; HighTronic J 5W-30						2,8	Getr.Öl EP Synth 75W-90	-			↔	↔		6,1	
Alfa Brera, Spider 2.4 JTDm 20V	'06-'10	6,4		●					2,8	Getr.Öl EP Synth 75W-90	-			↔	↔		7,35	

a Verteilergetriebe: 0,4 | Getriebeöl SNS 75W-80; Getr.Öl EP Synth 75W-90, Visko-Differential: 0,7 | Getr.Öl ATF E-S; Getriebeöl ATF 55

c Verteilergetriebe: 0,6 | Getriebeöl BS 75W-90; Getriebeöl HYP Synth 75W-90

b Hydraulik Bedienung Getriebe, Selespeed: 0,6 | Spezialprodukt, bitte auf Originalersatzteil des Herstellers zurückgreifen!



d Hydraulik Bedienung Getriebe, Q-Select: 0,5 | Spezialprodukt, bitte auf Originalersatzteil des Herstellers zurückgreifen!

## ASTON MARTIN

V8 Virage, Volante, Vantage	'91-'01	12,8		●		●	●	●	2	Getriebeöl SNS 75W-80	Getr.Öl ATF E-S	Getriebeöl ATF 55		2	Getr.Öl HYP LS 85W-90		18,1
V8 Vantage 4.3 32V	'05-'08	10,4	Spezialprodukt, bitte auf Originalersatzteil des Herstellers zurückgreifen!						4,5	Getriebeöl BS 75W-90	-			↔	↔		-
V8 Vantage N400	'07-'08	10,4	Spezialprodukt, bitte auf Originalersatzteil des Herstellers zurückgreifen!						4,5	Spezialprodukt	a			↔	↔		-
V8 Vantage 4.7 32V	'08-	10	Spezialprodukt, bitte auf Originalersatzteil des Herstellers zurückgreifen!						4,5	Spezialprodukt	a			↔	↔		-
V12 Vantage	'10-	11		●		●	●		4,5	Spezialprodukt	-			↔	↔		14
V12 Vanquish (S)	'01-'07	9,5				●		●	4,2	Getr.Öl ATF E-S	-			2-2,5	Getr.Öl BS LSX 75W-140		15
DB7	'94-'04	8		●			●	●	1,7	Getr.Öl ATF E-S	Getr.Öl ATF E-S	Getriebeöl ATF 55		2	Getr.Öl HYP LS 85W-90		18,1
DB7 Vantage, DB7 Zagato, DB7 AR1, DB7 GT	'99-'04	11				●	●	●	4	Getr.Öl ATF E-S	Spezialprodukt			1,6	Getr.Öl HYP LS 85W-90		14,4
DB9	'03-'08	10				●		●	4,5	Getriebeöl BS 75W-90	Spezialprodukt			↔	↔	b	15
DB9	'08-	10		●		●	●		5	Getriebeöl BS 75W-90	a	Spezialprodukt		↔	↔	b	15
DBS V12	'10-	11		●		●	●		5	Spezialprodukt	Spezialprodukt			↔	↔	b	15
Rapide	'10-	11		●		●	●		5	Spezialprodukt	Spezialprodukt			↔	↔	b	15

a Hydraulik Bedienung Getriebe: Spezialprodukt, bitte auf Originalersatzteil des Herstellers zurückgreifen!

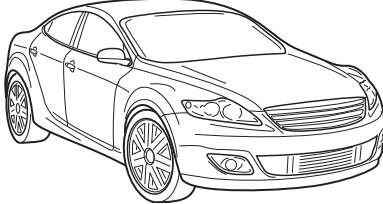
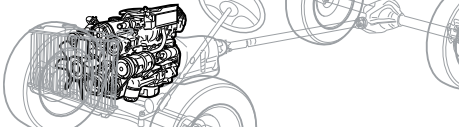
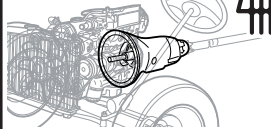
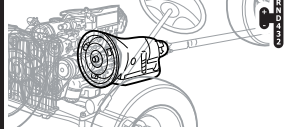
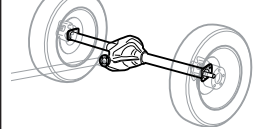
b Differential, Modelle mit Automatikgetriebe: 1,6 | Getriebeöl BS 75W-90; Getriebeöl SNA-C 75W-90

		SuperTronic						HighTronic			Blue Tronic 10W-40	Aral	⚠	Aral		⚠	Aral	⚠		
		G 0W-30	0W-40	LL III 5W-30	M 5W-40	5W-40	G 5W-30	Synthese	Mineral											
																				
<b>AUDI</b>																				
A1 1.2 TFSI	'10-	-	●	●	●	●				2,1	Getr.Öl EP Synth 75W-90	Spezialprodukt			↔	↔			-	
A1 1.4 TFSI (90 kW)	'10-	-	●	●	●	●				2,1	Spezialprodukt	Spezialprodukt			↔	↔			-	
A1 1.4 TFSI (136 kW)	'10-	-	●	●	●	●				-	-	Spezialprodukt			↔	↔			-	
A2 1.4, 1.6 FSI	'00-'05	3,5/4,5	●	●	●	●				1,9	Getr.Öl EP Synth 75W-90	-			↔	↔			4,5/6,2	
A3 1.2 TFSI	'10-	-	●	●	●	●				2,3	Getr.Öl EP Synth 75W-90	Spezialprodukt			↔	↔			-	
A3 1.4 TFSI	'07-	-	●	●	●	●				2,3	Getr.Öl EP Synth 75W-90	Spezialprodukt			↔	↔			-	
A3 1.6, 1.8 20V, Turbo	'95-'99	4-4,5	●	●	●	●				1,9/2	Getr.Öl EP Synth 75W-90	Getriebeöl ATF-LD		e	↔	↔			5	
A3 1.6, 1.8 20V, Turbo (110 kW), quattro	'99-'03	4-4,5	●	●	●	●				1,9-2,4	Getr.Öl EP Synth 75W-90	a Getriebeöl ATF-LD		a	↔	↔		eo	5	
A3 1.8 20V Turbo (132 kW), quattro	'99-'03	4-4,5	●	●	●	●				2,6	Getr.Öl EP Synth 75W-90	a -			↔	↔		o	5	
A3 1.8 TFSI (118kW)	'06-	-	●	●	●	●				2,3	Getr.Öl EP Synth 75W-90	Spezialprodukt			↔	↔			-	
A3 1.6, 1.6 FSI, 2.0 FSI	'03-'08	3,2-4,6	●	●	●	●				2	Getr.Öl EP Synth 75W-90	Spezialprodukt			↔	↔			-	
A3 2.0 TFSI, quattro	'04-'08	4,5	●	●	●	●				2,3	Spezialprodukt	cp Spezialprodukt		cp	↔	↔		o	-	
A3 2.0 TFSI, quattro	'08-	4,5	●	●	●	●				2,3	Spezialprodukt	cp Spezialprodukt		cp	↔	↔		o	-	
A3 3.2 quattro	'03-'09	5,5	●	●	●	●				2,3	Spezialprodukt	cp Spezialprodukt		cp	↔	↔		o	-	
S3 quattro	'99-'03	4,5	●	●	●	●				2,6	Spezialprodukt	a -			↔	↔		o	7	
S3 2.0 TFSI quattro	'06-	-	●	●	●	●				2,6	Spezialprodukt	Spezialprodukt		cp	↔	↔		o	-	
RS3	'11-	-	●	●	●	●				-	-	Spezialprodukt		px	1	Getriebeöl BS 75W-90			-	
Coupé, Cabriolet, quattro	'88-'00	3,5/4,5	●	●	●	●				2,4/2,9	Getr.Öl EP Synth 75W-90	a Getriebeöl ATF-LD		a	↔	↔		df	6,5-8	
Coupé, Cabriolet V6, quattro	'91-'00	5	●	●	●	●				2,9	Getr.Öl EP Synth 75W-90	a Getriebeöl ATF-LD		a	↔	↔		df	8-11	
A4 1.6, 1.8 20V (Turbo), quattro	'94-'99	3,4-4	●	●	●	●				2,3/2,8	Getr.Öl EP Synth 75W-90	a Getriebeöl ATF-LD		a	↔	↔		df	6-8	
A4 1.6, 1.8 20V (Turbo), 2.0 20V, quattro	'99-'04	3,5-4	●	●	●	●				2,3/2,8	Getr.Öl EP Synth 75W-90	a Getriebeöl ATF-LD		al	↔	↔		bdf	6-8	
A4 1.6, 1.8 T, 2.0, 2.0 TFSI, quattro	'04-'07	3,7-4,5	●	●	●	●				2,4-2,7	Getr.Öl EP Synth 75W-90	-		bl	↔	↔		bo	8	
A4 1.8 TFSI, 2.0 TFSI (132 kW), 2.0 TFSI (155 kW)	'07-	-	●	●	●	●				2,3	Spezialprodukt	Spezialprodukt		b	↔	↔		b	-	
A4 1.8 TFSI quattro, 2.0 TFSI quattro (132 kW)	'07-	-	●	●	●	●				4,8	Spezialprodukt	-		1	Getriebeöl BS 75W-90			-		
A4 2.0 TFSI quattro (155 kW)	'08-	-	●	●	●	●				4,8	Spezialprodukt	Spezialprodukt		r	1	Getriebeöl BS 75W-90			-	
A4 2.0 16V FSI	'02-'04	4,2	●	●	●	●				2,3	Getr.Öl EP Synth 75W-90	Spezialprodukt			↔	↔		b	-	
A4 V6 2.4, 2.6, 2.8, quattro	'94-'00	4,3-6	●	●	●	●				2,3/2,8	Getr.Öl EP Synth 75W-90	a Getriebeöl ATF-LD		a	↔	↔		df	10-11	
A4 V6 2.4, 2.8, 3.0, quattro	'99-'04	6-6,5	●	●	●	●				2,3-2,8	Getr.Öl EP Synth 75W-90	a Getriebeöl ATF-LD		bl	↔	↔		bdf	8-9	
A4 3.2 FSI	'04-'07	8,1	●	●	●	●				-	-	-		bl	↔	↔		b	12	
A4 3.2 FSI quattro	'04-'07	8,1	●	●	●	●				2,7	Getr.Öl EP Synth 75W-90	Spezialprodukt		h	↔	↔		do	12	
A4 3.2 FSI	'07-	-	●	●	●	●				-	-	Spezialprodukt		b	↔	↔			-	
A4 3.2 FSI quattro	'07-	-	●	●	●	●				4,8	Getr.Öl EP Synth 75W-90	Spezialprodukt		h	↔	↔		do	-	
S4 2.7 Biturbo	'98-'00	6	●	●	●	●				3,2	Getr.Öl EP Synth 75W-90	-		1,9	Getriebeöl BS 75W-90			6		
S4 2.7 Biturbo	'00-'04	6	●	●	●	●				3,2	Getr.Öl EP Synth 75W-90	-		1,9	Getriebeöl BS 75W-90			6		
S4 4.2 quattro	'04-'07	7,5-8,5	●	●	●	●				3,1	Getr.Öl EP Synth 75W-90	Spezialprodukt		h	↔	↔		do	12	
S4 3.0 TFSI quattro	'10-	-	●	●	●	●				3,2	Getr.Öl EP Synth 75W-90	Spezialprodukt		r	1	Getriebeöl BS 75W-90			-	
RS4 4.2 FSI quattro	'04-'07	-	●	●	●	●				3,2	Getr.Öl EP Synth 75W-90	-			↔	↔		d	12	
A5 1.8 TFSI, 2.0 TFSI	'08-	-	●	●	●	●				4-4,5	Spezialprodukt	Spezialprodukt			↔	↔			-	
A5 3.2 FSI	'07-'12	6,2	●	●	●	●				-	-	Spezialprodukt		bl	↔	↔		b	-	
A5 3.2 FSI quattro	'07-'12	6,2	●	●	●	●				4,5	Getr.Öl EP Synth 75W-90	Spezialprodukt		h	↔	↔		do	-	
S5 3.0 TFSI quattro	'12-	-	●	●	●	●				3,2	Getr.Öl EP Synth 75W-90	Spezialprodukt		r	1	Getriebeöl BS 75W-90			-	
S5 3.0 TFSI quattro	'10-'11	-	●	●	●	●				3,2	Getr.Öl EP Synth 75W-90	Spezialprodukt		r	1	Getriebeöl BS 75W-90			-	
S5 4.2 quattro	'07-'12	8,8	●	●	●	●				3,1	Getr.Öl EP Synth 75W-90	Spezialprodukt			↔	↔		o	-	
RS5 4.2 FSI quattro	'10-'11	8,8	●	●	●	●				-	-	Spezialprodukt		r	0,9	Getriebeöl BS 75W-90			-	
RS5 4.2 FSI quattro	'12-	8,8	●	●	●	●				-	-	Spezialprodukt		r	0,9	Getriebeöl BS 75W-90			-	
A6 1.8 (Turbo), 2.0, 2.3	'94-'00	3-4,5	●	●	●	●				1,7-3,2	Getr.Öl EP Synth 75W-90	Getriebeöl ATF-LD		c	↔	↔		df	6-8	
A6 1.8 (Turbo), 2.0 20V, quattro	'99-'05	3,5-4	●	●	●	●				2,3-2,8	Getr.Öl EP Synth 75W-90	ac Getriebeöl ATF-LD		abcd	↔	↔		bdf	6-8	

A6 2.0 TFSI	'05-'11	-	●	●	●	●	3	Getr.Öl EP Synth 75W-90		Spezialprodukt		b	↔	↔	b	8
A6 2.4, 2.6, 2.8 V6, quattro	'94-'00	5	●	●	●	●	2,9	Getr.Öl EP Synth 75W-90	ac	Getriebeöl ATF-LD		abcd	↔	↔	df	6-12
A6 V6 2.4, 2.8, 3.0, quattro	'99-'05	6-6,5	●	●	●	●	2,3-2,8	Getr.Öl EP Synth 75W-90		Getriebeöl ATF-LD		bcd	↔	↔	bdf	6-12
A6 2.4, 2.8FSI, 3.0, 3.2 FSI, quattro	'05-'11	6,3-6,5	●	●	●	●	3-3,4	Getr.Öl EP Synth 75W-90		Getriebeöl ATF-LD		bl	↔	↔	bo	12
A6 2.7 Biturbo	'99-'05	6	●	●	●	●	2,5	Getr.Öl EP Synth 75W-90		Getriebeöl ATF-LD			1,9	Getriebeöl BS 75W-90		6
A6 4.2 V8	'99-'05	7,5	●	●	●	●	-	-		Getriebeöl ATF-LD		c	1,5	Getriebeöl BS 75W-90	d	11
A6 4.2 quattro	'05-'08	7,5-8,8	●	●	●	●	-	-		Spezialprodukt		h	-	Getriebeöl BS 75W-90	m	12
A6 3.0 TFSI, 4.2 FSI quattro	'06-'11	-	●	●	●	●	-	-		Spezialprodukt		h	-	Getriebeöl BS 75W-90	m	12
A6 2.8 FSI	'10-	-	●	●	●	●	4	Spezialprodukt		Spezialprodukt			-	-		-
A6 2.8 FSI quattro, 3.0 TFSI quattro	'10-	-	●	●	●	●	-	-		Spezialprodukt		r	0,85	Getriebeöl BS 75W-90	m	-
S6 2.2 Turbo quattro	'93-'98	4,5	●	●	●	●	2,6	Getr.Öl EP Synth 75W-90	c	Getriebeöl ATF-LD		c	↔	↔	df	9
S6 4.2 V8 quattro	'93-'98	7,5	●	●	●	●	2,6	Getr.Öl EP Synth 75W-90		Getriebeöl ATF-LD			↔	↔	df	8,5
S6 4.2 V8 quattro	'01-'05	7,5	●	●	●	●	3,4	Getr.Öl EP Synth 75W-90		Getriebeöl ATF-LD		c	1,3/1,5	Getriebeöl BS 75W-90	m	11
RS6 4.2 V8 Turbo quattro	'02-'05	7,5	●	●	●	●	-	-		Getriebeöl ATF-LD		c	1,3/1,5	Getriebeöl BS 75W-90	m	11
S6 5.2 V8 FSI quattro	'06-'11	-	●	●	●	●	-	-		Spezialprodukt		h	-	Getriebeöl BS 75W-90	d	12
RS6 5.0 TFSI quattro	'08-'11	-	●	●	●	●	-	-		Spezialprodukt		s	1,5	Getriebeöl BS 75W-90		-
A7 2.8 FSI	'10-	-	●	●	●	●	-	-		Spezialprodukt			↔	↔		-
A7 2.8 FSI quattro, 3.0 TFSI quattro	'10-	-	●	●	●	●	-	-		Spezialprodukt		r	0,85	Getriebeöl BS 75W-90	m	-
A8 2.8 V6, quattro	'94-'00	5	●	●	●	●	2,6	Getr.Öl EP Synth 75W-90		Getriebeöl ATF-LD		c	↔	↔	df	9
A8 2.8 V6, quattro	'99-'03	5	●	●	●	●	2,6	Getr.Öl EP Synth 75W-90		Getriebeöl ATF-LD		c	↔	↔	df	9
A8 3.0	'03-'06	6,3	●	●	●	●	-	-		Spezialprodukt		b	↔	↔	b	12,6
A8 2.8, 3.2, 4.2 FSI, quattro	'06-'10	-	●	●	●	●	-	-		Spezialprodukt		y	↔	↔	bdo	-
A8, S8 3.7 V8, 4.2 V8, quattro	'94-'00	7,5/8	●	●	●	●	-	-		Getriebeöl ATF-LD		c	↔	↔	df	9
A8, S8 3.7 V8, 4.2 V8, quattro	'00-'03	7,5/8	●	●	●	●	-	-		Getriebeöl ATF-LD		c	↔	↔	df	9
A8 3.7, 4.2 quattro	'03-'06	7,5	●	●	●	●	-	-		Spezialprodukt		c	1,2/1,5	Getriebeöl BS 75W-90	m	11,5-12
A8 6.0 W12	'04-'10	12,5	●	●	●	●	-	-		Getriebeöl ATF-LD		y	1,2/1,5	Getriebeöl BS 75W-90	z	18,9
S8 5.2 FSI quattro	'06-'10	-	●	●	●	●	-	-		Spezialprodukt		y	1,2/1,5	Getriebeöl BS 75W-90	z	-
A8 3.0 TFSI quattro	'10-	-	●	●	●	●	-	-		Spezialprodukt		s	0,9-1,1	Getriebeöl BS 75W-90	m	-
A8 4.2 FSI quattro	'10-	7,7	●	●	●	●	-	-		Spezialprodukt		s	0,9-1,1	Getriebeöl BS 75W-90	m	11,5
Q3 2.0 TDI quattro	'11-	-	●	●	●	●	2,3	Spezialprodukt	p	Spezialprodukt		p	0,9-1	Getriebeöl BS 75W-90		-
Q3 2.0 TFSI quattro	'11-	4,6	●	●	●	●	2,3	Spezialprodukt	p	Spezialprodukt		p	0,9-1	Getriebeöl BS 75W-90		-
Q5 2.0 TFSI	'08-	4,6	●	●	●	●	4,8	Spezialprodukt		Spezialprodukt		rt	0,9-1	Getriebeöl BS 75W-90		-
Q5 3.2 FSI	'08-	-	●	●	●	●	-	-		Spezialprodukt		r	0,9-1	Getriebeöl BS 75W-90		-
Q7 3.0 TFSI quattro	'10-	-	●	●	●	●	-	-		Spezialprodukt		v	1	Getriebeöl BS 75W-90	m	-
Q7 3.6 FSI quattro	'06-'10	-	●	●	●	●	1,8	Spezialprodukt		Getriebeöl ATF-LD		k	-	Getriebeöl BS 75W-90	m	-
Q7 4.2 FSI quattro	'06-'10	-	●	●	●	●	-	-		Spezialprodukt		k	-	Getriebeöl BS 75W-90	m	-
TT 1.8 Turbo (110, 120 kW)	'02-'05	4-4,5	●	●	●	●	2/2,6	Getr.Öl EP Synth 75W-90	a	-			↔	↔	g	5
TT 1.8 Turbo (132 kW)	'98-'05	4,5	●	●	●	●	2	Getr.Öl EP Synth 75W-90		-			↔	↔	g	5
TT 1.8 Turbo quattro (132 kW)	'98-'05	4,5	●	●	●	●	2,6	Spezialprodukt	a	-			↔	↔	g	5
TT 1.8 Turbo, quattro (140 kW)	'05-'06	-	●	●	●	●	2/2,6	Spezialprodukt	a	Spezialprodukt			↔	↔	o	5
TT 1.8 Turbo quattro (165 kW)	'98-'05	4,5	●	●	●	●	2,6	Spezialprodukt	a	-			↔	↔	g	5
TT 1.8 Turbo quattro (176 kW)	'05-'06	-	●	●	●	●	2,6	Spezialprodukt	a	-			↔	↔	o	5
TTRS 2.5 TFSI quattro	'09-	-	●	●	●	●	2,3	Spezialprodukt	a	-			↔	↔	o	-
TT 2.0 TFSI, 3.2 quattro	'06-	-	●	●	●	●	2,3	Spezialprodukt	a	Spezialprodukt			↔	↔	o	-
TT 3.2 quattro	'03-'06	5,5	●	●	●	●	2,6	Spezialprodukt	a	Spezialprodukt			↔	↔	o	-
R8 4.2 V8 FSI	'07-'10	-	●	●	●	●	3,5	Spezialprodukt	q	-			1,5	Getriebeöl BS 75W-90		-
R8 4.2 V8 FSI	'10-	-	●	●	●	●	3,5	Spezialprodukt	q	-			1,5	Getriebeöl BS 75W-90		-
R8 5.2 V10 FSI	'09-	-	●	●	●	●	3,5	Spezialprodukt	q	-			1,5	Getriebeöl BS 75W-90		-
R8 GT	'10-	-	●	●	●	●	3,5	Spezialprodukt	q	-			1,5	Getriebeöl BS 75W-90		-
<b>Diesel</b>																
A1 1.2 TDI	'10-	-	●	●	●	●	1,9	Getr.Öl EP Synth 75W-90		Spezialprodukt			↔	↔		-
A1 1.6 TDI (66 kW, 77 kW)	'10-	-	●	●	●	●	1,9	Getr.Öl EP Synth 75W-90		Spezialprodukt			↔	↔		-
A1 2.0 TDI	'11-	-	●	●	●	●	2,3	Spezialprodukt		-			↔	↔		-
A2 1.2 TDI	'00-'05	4,3	●	●	●	●	2,5	Getr.Öl EP Synth 75W-90		-			↔	↔		4,2
A2 1.4 TDI (P-D)	'00-'05	4,3	●	●	●	●	1,9	Getr.Öl EP Synth 75W-90		-			↔	↔		4,2
A3 1.6 TDI	'08-	-	●	●	●	●	1,9	Getr.Öl EP Synth 75W-90		Spezialprodukt			↔	↔		-
A3 1.9 TDI, (P-D)	'96-'00	4,5	●	●	●	●	2	Getr.Öl EP Synth 75W-90		Getriebeöl ATF-LD		e	↔	↔		6,5
A3 1.9 TDI	'00-'03	4,5	●	●	●	●	2	Getr.Öl EP Synth 75W-90		Getriebeöl ATF-LD		e	↔	↔		6,5
A3 1.9 TDI (P-D), quattro	'00-'03	4,5	●	●	●	●	2,3	Spezialprodukt	a	-			↔	↔	o	6

AUDI	Model	Year	Power (kW)	SuperTronic			HighTronic			Blue Tronic 10W-40	Aral	Aral	Aral		Aral	Aral	Aral
				G 0W-30	0W-40	LL III 5W-30	M 5W-40	5W-40	G 5W-30				Synthese	Mineral			
				⌡	⌡	⌡	⌡	⌡	⌡				⚠	⚠			
A3 1.9 TDI (P-D)	'03-'06	4,5			●		●		2	Getr.Öl EP Synth 75W-90	-			↔	↔	-	
A3 1.9 TDI (P-D) DPF	'06-'10	4,5		●					2	Getr.Öl EP Synth 75W-90	Spezialprodukt			↔	↔	-	
A3 2.0 TDI (P-D)	'03-'06	-		●			●		2,3	Spezialprodukt	Spezialprodukt			↔	↔	-	
A3 2.0 TDI (P-D) DPF, quattro	'06-	-		●					2,3	Spezialprodukt	cp	Spezialprodukt	cp	↔	↔	o	
Cabriolet 1.9 TDI	'95-'01	3,5		●			●		2,3	Getr.Öl EP Synth 75W-90	-			↔	↔	6,5	
A4 1.9 Di, TDI, quattro	'94-'01	3,5		●			●		2,3/2,8	Getr.Öl EP Synth 75W-90	Getriebeöl ATF-LD			↔	↔	df	
A4 1.9 TDI (P-D), 2.5 TDI V6 (132 kW), quattro	'00-'04	4,5-6		●			●		2,3/2,7	Getr.Öl EP Synth 75W-90	c	Getriebeöl ATF-LD	l	↔	↔	df	
A4 1.9, 2.0 TDI (P-D)	'04-'07	3,8		●			●		2,4/2,7	Getr.Öl EP Synth 75W-90	-		l	↔	↔	8	
A4 1.9, 2.0 TDI (P-D) DPF, quattro	'04-'08	3,8		●					2,4/2,7	Getr.Öl EP Synth 75W-90	-		l	↔	↔	bo	
A4 2.0 TDI, quattro	'08-	-		●					4,3-4,8	Spezialprodukt	Spezialprodukt			0,9	Getriebeöl BS 75W-90	b	
A4 2.5 TDI V6, quattro	'98-'04	5,5		●			●		2,7	Getr.Öl EP Synth 75W-90	Getriebeöl ATF-LD			↔	↔	df	
A4 2.5 TDI	'04-'06	5,5		●			●		-	-	-		l	↔	↔	12	
A4 2.7 TDI DPF, 3.0 TDI DPF quattro	'04-'08	8-8,2		●					2,4	Getr.Öl EP Synth 75W-90	Spezialprodukt		h	↔	↔	do	
A4 2.7 TDI, 3.0 TDI quattro	'07-	-		●					3,5	Getr.Öl EP Synth 75W-90	Spezialprodukt		h	0,9	Getriebeöl BS 75W-90	-	
A5 2.0 TDI	'08-	-		●					4-4,5	Spezialprodukt	-			0,9	Getriebeöl BS 75W-90	-	
A5 2.7 TDI	'07-	6,9		●					-	-	Spezialprodukt			↔	↔	-	
A5 3.0 TDI quattro	'07-	6,9		●					-	Getr.Öl EP Synth 75W-90	Getriebeöl ATF-LD			0,9	Getriebeöl BS 75W-90	-	
A6 1.9 TDI	'94-'00	3,5		●			●		2,3	Getr.Öl EP Synth 75W-90	Getriebeöl ATF-LD			↔	↔	d	
A6 1.9 TDI	'00-'01	3,5		●			●		2,3	Getr.Öl EP Synth 75W-90	Getriebeöl ATF-LD			↔	↔	d	
A6 1.9 TDI (P-D)	'01-'05	3,7		●			●		2,3	Getr.Öl EP Synth 75W-90	Getriebeöl ATF-LD			↔	↔	d	
A6 2.0 TDI (P-D)	'05-'11	3,8		●			●		3	Getr.Öl EP Synth 75W-90	Spezialprodukt			↔	↔	8	
A6 2.0 TDI (P-D) DPF	'05-'11	3,8		●					3	Getr.Öl EP Synth 75W-90	Spezialprodukt			↔	↔	b	
A6 2.0 TDI, 3.0 TDI	'11-	-		●					4	Spezialprodukt	Spezialprodukt		w	↔	↔	-	
A6 2.5 TDI, V6, quattro	'94-'00	5-5,5		●			●		2,4	Getr.Öl EP Synth 75W-90	Getriebeöl ATF-LD		c	↔	↔	df	
A6 2.5 TDI V6 (110 kW), quattro	'00-'05	5,5		●			●		2,4/2,7	Getr.Öl EP Synth 75W-90	Getriebeöl ATF-LD		c	↔	↔	df	
A6 2.5 TDI V6 (120, 132 kW), quattro	'00-'05	5,5		●			●		2,4/2,7	Getr.Öl EP Synth 75W-90	Getriebeöl ATF-LD		c	↔	↔	df	
A6 2.7, 3.0 TDI, quattro	'05-'11	8,2		●			●		3/3,4	Getr.Öl EP Synth 75W-90	Spezialprodukt		hl	-	Spezialprodukt	do	
A6 2.7, 3.0 TDI DPF, quattro	'05-'11	8,2		●					3/3,4	Getr.Öl EP Synth 75W-90	Spezialprodukt		hl	↔	↔	do	
A6 3.0 TDI quattro	'10-	-		●					-	-	Spezialprodukt		r	0,9	Getriebeöl BS 75W-90	-	
A7 3.0 TDI	'10-	-		●					-	-	Spezialprodukt			↔	↔	-	
A7 3.0 TDI quattro	'10-	-		●					-	-	Spezialprodukt		r	0,9	Getriebeöl BS 75W-90	-	
A8 2.5 TDI V6, quattro	'97-'00	5,5		●			●		2,4	Getr.Öl EP Synth 75W-90	Getriebeöl ATF-LD		c	↔	↔	df	
A8 2.5 TDI V6 (110 kW), quattro	'00-'03	5,5		●			●		2,4	Getr.Öl EP Synth 75W-90	Getriebeöl ATF-LD		c	↔	↔	df	
A8 2.5 TDI V6 (132 kW), quattro	'00-'03	5,5		●			●		2,4	Getr.Öl EP Synth 75W-90	Getriebeöl ATF-LD		c	↔	↔	df	
A8 3.0 TDI quattro	'03-'10	8,2		●			●		-	-	Getriebeöl ATF-LD	h	1,1/1,5	Getriebeöl BS 75W-90	m		
A8 3.0 TDI DPF quattro	'05-'10	8,2		●					-	-	Getriebeöl ATF-LD	h	1,1/1,5	Getriebeöl BS 75W-90	m		
A8 3.0 TDI quattro	'10-	-		●					-	-	Spezialprodukt	s	0,9-1,1	Getriebeöl BS 75W-90	m		
A8 3.3 TDI V8 quattro	'99-'03	5,3		●			●		-	-	Getriebeöl ATF-LD	c	1,5	Getriebeöl BS 75W-90	f		
A8 4.0 TDI quattro	'03-'06	9,5		●			●		-	-	Spezialprodukt	c	1,2-1,5	Getriebeöl BS 75W-90	m		
A8 4.2 TDI DPF quattro	'06-'10	10		●					-	-	Spezialprodukt	y	1,2-1,5	Getriebeöl BS 75W-90	z		
A8 4.2 TDI quattro	'10-	9,5		●					-	-	Spezialprodukt	y	0,9-1,1	Getriebeöl BS 75W-90	m		
Q3 2.0 TDI	'11-	-		●					2,3	Spezialprodukt	-			↔	↔	-	
Q5 2.0 TDI, 3.0 TDI quattro	'08-	5		●					4,8	Getr.Öl EP Synth 75W-90	Spezialprodukt		r	0,9-1	Getriebeöl BS 75W-90	-	
Q7 3.0, 4.2 TDI quattro	'06-'10	8,2-9,5		●					-	-	Spezialprodukt		k	-	Getriebeöl BS 75W-90	m	
Q7 3.0, 4.2 TDI quattro	'10-	8,2-9,5		●					-	-	Spezialprodukt		v	1-1,25	Getriebeöl BS 75W-90	m	
Q7 6.0 V12 TDI quattro	'08-	-		●					-	-	Spezialprodukt		k	1-1,25	Getriebeöl BS 75W-90	m	
TT 2.0 TDI quattro	'08-	-		●					2,3	Spezialprodukt	-			-	-	-	

- a Haldex-Kupplung (quattro): 0,25 | Spezialprodukt, bitte auf Originalersatzteil des Herstellers zurückgreifen!
- c Verteilergetriebe (quattro): 0,8-1 | Getriebeöl BS 75W-90
- e Differential, Modelle mit Automatikgetriebe: 0,8 | Getriebeöl BS 75W-90
- g Differential, hinten (quattro): 1 | Getriebeöl BS 75W-90
- k Verteilergetriebe von Automatik: 0,85 | Getriebeöl ATF-LD
- m Differentiale, vorn und hinten
- p Haldex-Kupplung (quattro): Spezialprodukt, bitte auf Originalersatzteil des Herstellers zurückgreifen!
- r Getriebe, DSG, Kupplungsteil 0B5: 7 | Spezialprodukt, bitte auf Originalersatzteil des Herstellers zurückgreifen!
- t Automatikgetriebe 0BK: 9 | Spezialprodukt, bitte auf Originalersatzteil des Herstellers zurückgreifen!
- w Differential, Modelle mit CVT: 1,1 | Spezialprodukt, bitte auf Originalersatzteil des Herstellers zurückgreifen!
- y Verteilergetriebe (quattro): Spezialprodukt, bitte auf Originalersatzteil des Herstellers zurückgreifen!

- b Differential, Modelle mit CVT: 1,3 | Spezialprodukt, bitte auf Originalersatzteil des Herstellers zurückgreifen!
- d Differential, Modelle mit Automatikgetriebe: 0,5-1,4 | Getriebeöl BS 75W-90
- f Differential, hinten (quattro): 0,8-2,2 | Getriebeöl BS 75W-90; Getriebeöl HYP Synth 75W-90
- h Verteilergetriebe von Automatik: 0,5-0,6 | Getriebeöl BS 75W-90
- l CVT (Automat): Spezialprodukt, bitte auf Originalersatzteil des Herstellers zurückgreifen!
- o Differential, hinten (quattro): 0,9-1,5 | Getriebeöl BS 75W-90
- q Hydraulik Bedienung Getriebe, R-Tronic: Spezialprodukt, bitte auf Originalersatzteil des Herstellers zurückgreifen!
- s Verteilergetriebe von Automatik: 1,2 | Getriebeöl BS 75W-90
- v Verteilergetriebe: 0,65 | Spezialprodukt, bitte auf Originalersatzteil des Herstellers zurückgreifen!
- x Kegelrad: Getriebeöl BS 75W-90
- z Differential, vorn: Spezialprodukt, bitte auf Originalersatzteil des Herstellers zurückgreifen!

Achtung: Alle Fahrzeuge mit LongLife-Service: Aral SuperTronic LL III 5W-30 verwenden!

## BENTLEY

Mulsanne Turbo, Turbo R	'82-'99	9,4				●				●	-	-		Getr.Öl ATF E-S	Getriebeöl ATF 55		2,6	Getriebeöl BS 75W-90		16
Continental R, Azure	'91-'03	9,4				●				●	-	-		Getr.Öl ATF E-S	Getriebeöl ATF 55		2,3/2,8	Getriebeöl BS 75W-90		16/18
Brooklands	'92-'99	9,4				●				●	-	-		Getr.Öl ATF E-S	Getriebeöl ATF 55		2,8	Getriebeöl BS 75W-90		18
Amage 4.4	'98-'04	7,5				●				●	-	-		Getr.Öl ATF E-S	Getriebeöl ATF 55		2,8	Getriebeöl BS 75W-90		15
Amage, T 6.8	'98-'10	10-10,5		●		●				●	-	-		Getr.Öl ATF E-S	Getriebeöl ATF 55		2,8	Getriebeöl BS 75W-90		18-20
Continental GT, Flying Spur	'03-	12,5				●				●	-	-		Spezialprodukt			2,6-3	Getriebeöl BS 75W-90		19

## BMW

<b>E81/E82/E87/E88 - 1 Series</b>																						
116i, 118i, 120i	'04-'11	4,3	●	●	●	●	●				1-1,5	Getriebeöl SNS 75W-80	r	Spezialprodukt			0,8-1	Getriebeöl BS 75W-90		7-7,8		
128i, 130i	'05-'11	6,5	●	●	●	●	●				1,5	Getriebeöl SNS 75W-80	r	Spezialprodukt			0,8-1,2	Getriebeöl BS 75W-90		8,2-8,4		
135i	'07-'10	6,5	●	●	●	●	●				1,5	Getr.Öl SNS-B 75W-80	r	Spezialprodukt			1,2	Getriebeöl BS 75W-90		8,2-8,4		
135i	'10-	6,5	●	●	●	●	●				-	Spezialprodukt		Spezialprodukt			1,2	Getriebeöl BS 75W-90		8,2-8,4		
M Coupé	'10-	6,5	●	●	●	●	●				-	Spezialprodukt		-			1,2	Getr.Öl BS LSX 75W-140		8,2-8,4		
<b>F20 - 1 Series</b>																						
114i, 116i, 118i, 125i, xDrive	'11-	-	●	●	●	●	●				-	Getr.Öl SNS-B 75W-80		Spezialprodukt			a	0,8-1,2	Getriebeöl BS 75W-90	l	-	
M 135i, xDrive	'12-	-	●	●	●	●	●				-	Spezialprodukt		Spezialprodukt			a	0,8-1,2	Getriebeöl BS 75W-90	l	-	
<b>E36 - 3 Series</b>																						
316i, 318i, 318ti, 318is	'90-'01	4-4,5	●	●	●	●	●				1,1	Getr.Öl ATF E-S		Getr.Öl ATF E-S	Getriebeöl ATF 55	g	1,1	Getriebeöl BS 75W-90	h	6,5		
320i, 323i, 323ti, 325i, 328i	'90-'01	6,5	●	●	●	●	●				1,1	Getr.Öl ATF E-S		Getr.Öl ATF E-S	Getriebeöl ATF 55	f	1,1-1,7	Getriebeöl BS 75W-90	h	10,5		
M3	'92-'99	6	●	●	●	●	●				1,2	Getr.Öl ATF E-S		-			1,3	Getr.Öl BS LSX 75W-140		11		
Z3 1.8i, 1.9i	'95-'03	4-5	●	●	●	●	●				1	Getr.Öl ATF E-S		Getr.Öl ATF E-S	Getriebeöl ATF 55		1	Getriebeöl BS 75W-90	h	6,2-6,6		
Z3 2.0i, 2.5i, 2.8i	'96-'00	6,5	●	●	●	●	●				1	Getriebeöl SNS 75W-80	r	Spezialprodukt			n	1	Getriebeöl BS 75W-90	h	10-10,5	
Z3 2.2i, 2.5i, 3.0i	'00-'03	6,5	●	●	●	●	●				1-1,2	Getriebeöl SNS 75W-80	r	Spezialprodukt			n	1	Getriebeöl BS 75W-90	h	10,5	
Z3 M	'97-'00	5,5	●	●	●	●	●				1	Getr.Öl ATF E-S		-				1	Getriebeöl BS 75W-90	h	11	
Z3 M	'00-'03	5,5	Spezialprodukt, bitte auf Originalersatzteil des Herstellers zurückgreifen!									1	Getr.Öl ATF E-S		-				1	Getr.Öl BS LSX 75W-140		11
<b>E46 - 3 Series</b>																						
316i, 318i	'98-'01	4	●	●	●	●	●				1,1	Getriebeöl SNS 75W-80	r	Getriebeöl ATF 55				1,1	Getriebeöl BS 75W-90	h	6	
316i, 318i	'01-'04	4,3	●	●	●	●	●				1,1	Getriebeöl SNS 75W-80	r	Spezialprodukt			o	1,1	Getriebeöl BS 75W-90	h	7,5	
320i, 323i, 325i, 328i, 330i, xi	'98-'04	6,2-6,5	●	●	●	●	●				1,1	Getriebeöl SNS 75W-80	m	Spezialprodukt			mo	1,7	Getriebeöl BS 75W-90	hl	8,5	
M3	'00-'04	5,5	Spezialprodukt, bitte auf Originalersatzteil des Herstellers zurückgreifen!									1,1	Getriebeöl SNS 75W-80	r	-				1,7	Getr.Öl BS LSX 75W-140		6
<b>E90/E91/E92/E93 - 3 Series</b>																						
316i, 318i	'04-'07	4,3	●	●	●	●	●				1,3	Getriebeöl SNS 75W-80	r	Spezialprodukt				1	Getriebeöl BS 75W-90		-	
316i, 318i	'07-	4,3	●	●	●	●	●				1,3	Getriebeöl SNS 75W-80	r	-				1	Getriebeöl BS 75W-90		-	
318i	'07-	4,3	●	●	●	●	●				1,3	Getriebeöl SNS 75W-80	r	Spezialprodukt				1	Getriebeöl BS 75W-90		-	
320i, 320si	'04-'07	4,3-4,5	●	●	●	●	●				1,3	Getriebeöl SNS 75W-80	r	Spezialprodukt				0,8	Getriebeöl BS 75W-90		-	
320i	'07-	4,3	●	●	●	●	●				1,3	Getriebeöl SNS 75W-80	r	Spezialprodukt				0,8	Getriebeöl BS 75W-90		-	
323i, 325i, 328i, 330i, 335i, xi	'04-'07	6,5	●	●	●	●	●				1,3-1,5	Getriebeöl SNS 75W-80	ar	Spezialprodukt			a	1	Getriebeöl BS 75W-90	l	-	
323i, 325i, 328i, 330i	'08-	6,5	●	●	●	●	●				1,3-1,4	Getriebeöl SNS 75W-80	ar	Spezialprodukt			a	1-1,2	Getriebeöl BS 75W-90	l	-	
335i, xDrive	'08-'10	6,5	●	●	●	●	●				1,5	Getriebeöl SNS 75W-80	ar	Spezialprodukt			a	1-1,2	Getriebeöl BS 75W-90	l	-	
335i, xDrive	'10-	6,5	●	●	●	●	●				-	Spezialprodukt		a	Spezialprodukt		a	1-1,2	Getriebeöl BS 75W-90	l	-	
M3	'07-	8,8	Spezialprodukt, bitte auf Originalersatzteil des Herstellers zurückgreifen!									2	Getr.Öl SNS-B 75W-80	r	Spezialprodukt				1,1	Getr.Öl BS LSX 75W-140		-

BMW	BMW	SuperTronic						HighTronic			Blue Tronic	Aral	Aral	Aral		Aral	Aral		
		G 0W-30	0W-40	LL III 5W-30	M 5W-40	5W-40	G 5W-30	10W-40	Synthese	Mineral									
											⚠			⚠					
<b>F30/F31 - 3 Series</b>																			
316i	'12-	-	●	●	●	●	●			1,4	Getr.Öl SNS-B 75W-80	Spezialprodukt				-	Getriebeöl BS 75W-90	-	
320i, 328i, xDrive	'12-	-	●	●	●	●	●			1,4	Getr.Öl SNS-B 75W-80	Spezialprodukt		a	-	Getriebeöl BS 75W-90	l	-	
335i, xDrive	'12-	-	●	●	●	●	●			-	Spezialprodukt	Spezialprodukt		a	-	Getriebeöl BS 75W-90	l	-	
ActiveHybrid 3	'12-	-	●	●	●	●	●			-	-	Spezialprodukt			-	Getriebeöl BS 75W-90	l	-	
<b>E85/E86 - Z4-series</b>																			
Z4 2.0i	'04-'08	4,3	●	●	●	●	●			-	Getriebeöl SNS 75W-80	r	-		0,9-1,6	Getriebeöl BS 75W-90	h	-	
Z4 2.2i, 2.5i, 3.0i	'02-'06	6,5	●	●	●	●	●			-	Getriebeöl SNS 75W-80	r	Spezialprodukt		0,9-1,6	Getriebeöl BS 75W-90	h	8,3-8,8	
Z4 2.5i, 2.5si, 3.0si	'06-'08	6,5	●	●	●	●	●			-	Getriebeöl SNS 75W-80	r	Spezialprodukt		0,9-1,6	Getriebeöl BS 75W-90	h	-	
Z4 M	'06-'08	5,5	Spezialprodukt, bitte auf Originalersatzteil des Herstellers zurückgreifen!								-	Getriebeöl SNS 75W-80	r	-	1,2	Getr.Öl BS LSX 75W-140		-	
<b>E89 - Z4-series</b>																			
Z4 sDrive20i, Z4 sDrive28i	'11-	-	●	●	●	●	●			-	Getr.Öl SNS-B 75W-80	Spezialprodukt			1,2	Getriebeöl BS 75W-90	h	-	
Z4 sDrive23i, sDrive30i	'08-	6,5-7	●	●	●	●	●			-	Getr.Öl SNS-B 75W-80	Spezialprodukt			1,2	Getriebeöl BS 75W-90	h	8,2-8,5	
Z4 sDrive35i, sDrive35is	'08-	6,5-7	●	●	●	●	●			-	Getr.Öl SNS-B 75W-80	Spezialprodukt			1,2	Getriebeöl BS 75W-90	h	8,2-8,5	
<b>E34 - 5 Series</b>																			
520i, 525i	'88-'91	4,3-5,5				●			●	1-1,3	Getriebeöl SNS 75W-80	d	Getr.Öl ATF E-S	Getriebeöl ATF 55		1,7	Getriebeöl BS 75W-90	h	10,5-11
525i 24V	'90-'95	5,8				●			●	1,2	Getr.Öl ATF E-S		Getr.Öl ATF E-S	Getriebeöl ATF 55		1,7	Getriebeöl BS 75W-90	h	10,5
525iX 24V	'91-'95	5,8				●			●	1,2	Getr.Öl ATF E-S	c	Getr.Öl ATF E-S	Getriebeöl ATF 55	c	1,7	Getriebeöl BS 75W-90	k	10,5
535i	'88-'92	5,8				●			●	1,3	Getr.Öl ATF E-S	e	Getr.Öl ATF E-S	Getriebeöl ATF 55		1,9	Getriebeöl BS 75W-90	h	12
530i V8	'92-'93	7,5				●			●	1,3	Getr.Öl ATF E-S		Getr.Öl ATF E-S	Getriebeöl ATF 55	g	1,7	Getriebeöl BS 75W-90	h	12,5
540i	'92-'95	7,5				●			●	1,8	Getr.Öl ATF E-S		Getr.Öl ATF E-S	Getriebeöl ATF 22	g	1,9	Getriebeöl BS 75W-90	h	12,5
M5	'92-'95	5,8				●			●	1,3	Getr.Öl ATF E-S		-			1,9	Getr.Öl BS LSX 75W-140		13,5
<b>E39 - 5 Series</b>																			
520i, 523i, 528i	'95-'00	6,5	●	●	●	●				1,1-1,2	Getriebeöl SNS 75W-80	r	Spezialprodukt			1	Getriebeöl BS 75W-90	h	10,5
520i, 523i, 525i, 530i	'00-'03	6,5	●	●	●	●				1,1-1,2	Getriebeöl SNS 75W-80	r	Spezialprodukt		n	1	Getriebeöl BS 75W-90	h	10,5
535i, 540i	'95-'03	7,5	●	●	●	●				1,2-2,3	Getriebeöl SNS 75W-80	r	Getr.Öl ATF E-S	Getriebeöl ATF 22	gp	1-1,2	Getriebeöl BS 75W-90	h	12
M5	'98-'00	7,5	Spezialprodukt, bitte auf Originalersatzteil des Herstellers zurückgreifen!								2,3	Getriebeöl SNS 75W-80	r	-		1-1,2	Getr.Öl BS LSX 75W-140		11,5
M5	'00-'03	7,5	Spezialprodukt, bitte auf Originalersatzteil des Herstellers zurückgreifen!								2,3	Getriebeöl SNS 75W-80	r	-		1-1,2	Getr.Öl BS LSX 75W-140		11,5
<b>E60/E61 - 5 Series</b>																			
520i, 523i, 525i, 530i, xi	'03-'10	6,5	●	●	●	●	●			1,7-2,3	Getriebeöl SNS 75W-80	ar	Spezialprodukt		a	1,2	Getriebeöl BS 75W-90	l	9,8-10,6
525i xDrive	'07-'10	6,5	●	●	●	●	●			1,7-2,3	Getriebeöl SNS 75W-80	ar	Spezialprodukt		a	1,2	Getriebeöl BS 75W-90	l	9,8
530i, 530i, xDrive	'07-'10	6,5	●	●	●	●	●			1,7-2,3	Getriebeöl SNS 75W-80	r	Spezialprodukt		a	1,2	Getriebeöl BS 75W-90	l	10-10,6
540i, 545i, 550i	'03-'10	8	●	●	●	●	●			1,7-2,3	Getriebeöl SNS 75W-80	r	Spezialprodukt			1,6	Getriebeöl BS 75W-90		-
M5	'05-'10	9,3	Spezialprodukt, bitte auf Originalersatzteil des Herstellers zurückgreifen!								2,8	Getriebeöl SNS 75W-80	r	-		1,1	Getr.Öl BS LSX 75W-140		-
<b>F07 - GT Series</b>																			
535i GT, 550i GT, xDrive	'10-	-	●	●	●	●	●			-	-	Spezialprodukt		a	1,2	Getriebeöl BS 75W-90	l	9,8-10,6	
<b>F10/F11/F18 - 5 Series</b>																			
520i	'11-	-	●	●	●	●	●			1,4	Getr.Öl SNS-B 75W-80	Spezialprodukt			1	Getriebeöl BS 75W-90		6,5	
523i, 528i	'10-'11	6,5	●	●	●	●	●			1,4	Getr.Öl SNS-B 75W-80	Spezialprodukt			1	Getriebeöl BS 75W-90		6,5	
528i, xDrive	'11-	-	●	●	●	●	●			1,4	Getr.Öl SNS-B 75W-80	Spezialprodukt		a	1	Getriebeöl BS 75W-90	l	6,5	
535i, xDrive	'10-	6,5	●	●	●	●	●			1,4	Spezialprodukt	Spezialprodukt		a	1	Getriebeöl BS 75W-90	l	9-9,3	
550i, xDrive	'10-	8,5	●	●	●	●	●			-	-	Spezialprodukt		a	1	Getriebeöl BS 75W-90	l	-	
M5	'11-	-	●	●	●	●	●			-	-	Spezialprodukt			1	Getr.Öl BS LSX 75W-140		-	
<b>E63/E64 - 6 Serie</b>																			
630i	'04-'11	6,5	●	●	●	●	●			1,5	Getriebeöl SNS 75W-80	r	Spezialprodukt			1	Getriebeöl BS 75W-90		-
645Ci, 650i	'04-'11	8	●	●	●	●	●			1,5	Getriebeöl SNS 75W-80	r	Spezialprodukt			1,4	Getriebeöl BS 75W-90		-
M6	'04-'11	9,3	Spezialprodukt, bitte auf Originalersatzteil des Herstellers zurückgreifen!								2,6-2,8	Getriebeöl SNS 75W-80	r	-		-	Getr.Öl BS LSX 75W-140		-

<b>F12/F13 - 6 serie</b>																		
640i	'11-	6,5	●	●	●	●	●		-	-		Spezialprodukt		-	Getriebeöl BS 75W-90	-		
650i, xDrive	'11-	-	●	●	●	●	●		-	-		Spezialprodukt	a	-	Getriebeöl BS 75W-90	l	-	
<b>E38 - 7 Series</b>																		
728i	'95-'01	5,8	●	●	●	●	●		1,2	Getriebeöl SNS 75W-80	r	Spezialprodukt		1,2-1,4	Getriebeöl BS 75W-90	h	12	
730i, 735i	'94-'01	7,5-8	●	●	●	●	●		1,2-1,7	Getriebeöl SNS 75W-80	r	Getr.Öl ATF E-S	Getriebeöl ATF 55	g	1,2-1,6	Getriebeöl BS 75W-90	h	12-13
740i, 750i	'94-'01	7,5-8	●	●	●	●	●		1,7	Getr.Öl ATF E-S		Getr.Öl ATF E-S	Getriebeöl ATF 22	gp	1,6	Getriebeöl BS 75W-90	h	12-13
<b>E65/E66 - 7 Series</b>																		
730i	'02-'08	6,5	●	●	●	●	●		-	-		Spezialprodukt		1,2	Getriebeöl BS 75W-90		11,4	
735i, 740i, 745i, 750i	'01-'08	8	●	●	●	●	●		-	-		Spezialprodukt		1,4-1,5	Getriebeöl BS 75W-90		-	
760i	'02-'08	8,5	●	●	●	●	●		-	-		Spezialprodukt		0,9-1,6	Getriebeöl BS 75W-90		-	
<b>F01/F02 - 7 Series</b>																		
740i	'08-	6,5	●	●	●	●	●		-	-		Spezialprodukt		-	Getriebeöl BS 75W-90		9	
750i, 750i xDrive	'08-	8,5	●	●	●	●	●		-	-		Spezialprodukt		0,9	Getriebeöl BS 75W-90	l	13,5	
760i	'08-	-	●	●	●	●	●		-	-		Spezialprodukt		0,9	Getriebeöl BS 75W-90		-	
ActiveHybrid 7	'09-	8,5	●	●	●	●	●		-	-		Spezialprodukt		0,9	Getriebeöl BS 75W-90		13,5	
<b>E31 - 8 Series</b>																		
840 Ci	'93-'96	7,5		●		●		●	1,8	Getr.Öl ATF E-S		Getr.Öl ATF E-S	Getriebeöl ATF 22	g	1,9	Getriebeöl BS 75W-90	h	12,5
840 Ci	'96-'99	7,5		●		●		●	1,8	Getr.Öl ATF E-S		Getr.Öl ATF E-S	Getriebeöl ATF 22	g	1,9	Getriebeöl BS 75W-90	h	12,5
850Ci, CSi	'94-'99	7,5-8,3		●		●		●	2,3	Getr.Öl ATF E-S		Getr.Öl ATF E-S	Getriebeöl ATF 22	g	1,9-2,7	Getriebeöl BS 75W-90	h	13
<b>Z8 Series</b>																		
Z8	'00-'03	7,5	Spezialprodukt, bitte auf Originalersatzteil des Herstellers zurückgreifen!							1,9	Getriebeöl SNS 75W-80	r	-		1,2	Getriebeöl BS 75W-90		15,5
<b>E84 - X1 Series</b>																		
X1 sDrive18i	'09-	-	●	●	●	●	●		-	Getr.Öl SNS-B 75W-80		Spezialprodukt		-	Getriebeöl BS 75W-90	k	7,5	
X1 xDrive25i, xDrive28i	'09-	-	●	●	●	●	●		-	-		Spezialprodukt		-	Getriebeöl BS 75W-90	k	8,5	
X1 xDrive28i	'10-	-	●	●	●	●	●		-	Spezialprodukt		Spezialprodukt		-	Getriebeöl BS 75W-90	k	-	
<b>E83 - X3 Series</b>																		
X3 2.0i, xDrive20i	'05-'10	4,3	●	●	●	●	●		1,5-1,6	Getriebeöl SNS 75W-80	ar	-		1	Getriebeöl BS 75W-90	k	-	
X3 2.5i, 3.0i, xDrive25i, xDrive30i	'04-'10	6,2-6,5	●	●	●	●	●		1,5-1,6	Getriebeöl SNS 75W-80	ar	Spezialprodukt	a	1	Getriebeöl BS 75W-90	k	10,5	
X3 2.5si, 3.0si	'06-'10	6,5	●	●	●	●	●		-	Getriebeöl SNS 75W-80	ar	Spezialprodukt	a	-	Getriebeöl BS 75W-90	k	-	
X3 xDrive28i, xDrive35i	'10-	6,5	●	●	●	●	●		-	-		Spezialprodukt	a	-	Getriebeöl BS 75W-90	k	-	
<b>E53 - X5 Series</b>																		
X5 3.0i	'99-'03	6,5	●	●	●	●			-	Getriebeöl SNS 75W-80	br	Spezialprodukt	b	-	Getriebeöl BS 75W-90	k	10,5	
X5 3.0i	'03-'07	6,5	●	●	●	●	●		-	Getriebeöl SNS 75W-80	br	Spezialprodukt	b	-	Getriebeöl BS 75W-90	k	10,5	
X5 4.4i	'99-'03	8	●	●	●	●			-	Getriebeöl SNS 75W-80	br	Spezialprodukt	b	-	Getriebeöl BS 75W-90	k	12	
X5 4.4i	'03-'07	8	●	●	●	●	●		-	Getriebeöl SNS 75W-80	ar	Spezialprodukt	a	-	Getriebeöl BS 75W-90	k	12	
X5 4.6is	'01-'04	8	●	●	●	●	●		-	-		Spezialprodukt	b	-	Getriebeöl BS 75W-90	k	13	
X5 4.8is	'04-'07	8	●	●	●	●	●		-	-		Spezialprodukt	a	-	Getriebeöl BS 75W-90	k	13	
<b>E70 - X5 Series</b>																		
X5 3.0si, 4.8i	'07-	6,5/8	●	●	●	●	●		-	-		Spezialprodukt	a	-	Getriebeöl BS 75W-90	k	-	
X5 M	'07-	8,5	●	●	●	●	●		-	-		Spezialprodukt	a	1	Getriebeöl BS 75W-90	k	17	
<b>E71/E72 - X6 Series</b>																		
X6 xDrive 35i	'08-	6,5	●	●	●	●	●		-	-		Spezialprodukt	a	-	Getriebeöl BS 75W-90	lq	-	
X6 xDrive 50i	'08-	8,5	●	●	●	●	●		-	-		Spezialprodukt	a	1	Getriebeöl BS 75W-90	lq	-	
X6 xDrive M	'08-	8,5	●	●	●	●	●		-	-		Spezialprodukt	a	1	Getriebeöl BS 75W-90	lq	17	
ActiveHybrid X6	'09-	8,5	●	●	●	●	●		-	-		Spezialprodukt	a	1	Getriebeöl BS 75W-90	lq	-	
<b>Diesel</b>																		
<b>E87/E82/E81/E88 - 1 Series</b>																		
118d, 120d	'04-'11	5,2-5,5		●		●		●	1-1,5	Getriebeöl SNS 75W-80	r	Spezialprodukt		0,8-1	Getriebeöl BS 75W-90		7-7,4	
118d, 120d, DPF	'05-'11	5,5		●		●		●	1-1,5	Getriebeöl SNS 75W-80	r	Spezialprodukt		0,8-1	Getriebeöl BS 75W-90		7-7,3	
123d, DPF	'07-'08	5,2	Spezialprodukt, bitte auf Originalersatzteil des Herstellers zurückgreifen!							1,5	Getriebeöl SNS 75W-80	r	Spezialprodukt		1-1,2	Getriebeöl BS 75W-90		7,4
123d	'08-'11	5,2		●		●		●	1,5-1,6	Getr.Öl SNS-B 75W-80		Spezialprodukt		1,2	Getriebeöl BS 75W-90		7,2-7,4	
<b>F20 - 1 Series</b>																		
114d, 116d, 118d	'11-	-		●		●		●	-	Getr.Öl SNS-B 75W-80		Spezialprodukt		1	Getriebeöl BS 75W-90		-	
120d, 125d, xDrive	'11-	-		●		●		●	-	Spezialprodukt		Spezialprodukt	a	1	Getriebeöl BS 75W-90	l	-	
<b>E36 - 3 Series</b>																		
318td, tds	'94-'99	4,5-5,5	●	●	●	●			1,2	Getr.Öl ATF E-S		-		1,1	Getriebeöl BS 75W-90	h	7,5	
325td	'91-'99	6,5-7	●	●	●	●			1,2	Getr.Öl ATF E-S		Getr.Öl ATF E-S	Getriebeöl ATF 55	f	1,7	Getriebeöl BS 75W-90	h	9-10
325tds	'93-'99	6,5-7	●	●	●	●			1,2	Getr.Öl ATF E-S		Getr.Öl ATF E-S	Getriebeöl ATF 55	g	1,7	Getriebeöl BS 75W-90	h	9-10

			SuperTronic						HighTronic			Blue Tronic	4H	Aral		Aral	Aral				
			G 0W-30		0W-40		LL III 5W-30		M 5W-40	5W-40	G 5W-30	10W-40		Aral	Aral						
										Synthese	Mineral										
<b>BMW</b>																					
<b>E46 - 3 Series</b>																					
318d, 320d	'98-'04	5-5,5	●	●	●	●						1,1	Getriebeöl SNS 75W-80	r	Getr.Öl ATF E-S	Getriebeöl ATF 55		1,7	Getriebeöl BS 75W-90	h	8-9,5
330d, xd	'99-'04	6,8	●	●	●	●						1,1	Getriebeöl SNS 75W-80	mr	Getriebeöl ATF 55		m	1,7	Getriebeöl BS 75W-90	hl	10-10,5
<b>E90/E91/E92/E93 - 3 Series</b>																					
318d, 320d	'04-'07	5,5	●	●	●		●					1,3	Getriebeöl SNS 75W-80	r	Spezialprodukt			1	Getriebeöl BS 75W-90		-
318d	'07-	5,5	●	●	●		●					1,3	Getriebeöl SNS 75W-80	r	Spezialprodukt			1	Getriebeöl BS 75W-90		-
318d, 320d, xd, DPF	'05-	5,2-5,5	●	●	●		●					1,3	Getriebeöl SNS 75W-80	r	Spezialprodukt			1	Getriebeöl BS 75W-90		-
320 EfficientDynamics	'10-	5,2		●	●		●					-	Spezialprodukt		-			1	Getriebeöl BS 75W-90		-
325d, 330d, xd	'04-'07	7,5	●	●	●		●					1,3	Getriebeöl SNS 75W-80	ar	Spezialprodukt		a	1	Getriebeöl BS 75W-90	l	-
325d, 330d, 335d, xd, DPF	'05-	7,5		●	●		●					1,3	Getriebeöl SNS 75W-80	ar	Spezialprodukt		a	1	Getriebeöl BS 75W-90	l	-
330d, xDrive	'08-	7,5	●	●	●		●					1,3	Getr.Öl SNS-B 75W-80	a	Spezialprodukt		a	1,2	Getriebeöl BS 75W-90	l	-
330d, xDrive DPF	'08-	7,5		●	●		●					1,3	Getr.Öl SNS-B 75W-80	a	Spezialprodukt		a	1,2	Getriebeöl BS 75W-90	l	-
<b>F30/F31 - 3 Series</b>																					
316d, 318d	'12-	-		●	●		●					1,4	Getr.Öl SNS-B 75W-80		Spezialprodukt			-	Getriebeöl BS 75W-90		-
320d, xDrive	'12-	-		●	●		●					-	Spezialprodukt		Spezialprodukt		a	-	Getriebeöl BS 75W-90	l	-
330d	'12-	-		●	●		●					-	-		Spezialprodukt		a	-	Getriebeöl BS 75W-90	l	-
<b>E34 - 5 Series</b>																					
525tds	'91-'95	7		●			●				●	1,2	Getr.Öl ATF E-S		Getr.Öl ATF E-S	Getriebeöl ATF 55	g	1,7	Getriebeöl BS 75W-90	h	10
<b>E39 - 5 Series</b>																					
520d	'00-'04	5	●	●	●	●						1,2	Getriebeöl SNS 75W-80	r	-			1	Getriebeöl BS 75W-90	h	8,5
525td, 525tds, 525d, 530d	'95-'04	6,5-7,3	●	●	●	●						1,2	Getriebeöl SNS 75W-80	r	Spezialprodukt		o	1	Getriebeöl BS 75W-90	h	9-10
<b>E60 - 5 Series</b>																					
520d DPF	'05-'06	5,5		●	●		●					1,7-2,3	Getriebeöl SNS 75W-80	r	Spezialprodukt			1	Getriebeöl BS 75W-90		-
520d DPF	'06-'10	5,2		●	●		●					1,7-2,3	Getriebeöl SNS 75W-80	r	Spezialprodukt			1	Getriebeöl BS 75W-90		7,2-7,4
525d, 530d, 535d	'03-'06	8,3-8,5		●	●		●					1,7-2,3	Getriebeöl SNS 75W-80	r	Spezialprodukt			1,6	Getriebeöl BS 75W-90		9,8
525d, 530d, 535d	'06-'10	8,3-8,5		●	●		●					1,7-2,3	Getriebeöl SNS 75W-80	r	Spezialprodukt			1,6	Getriebeöl BS 75W-90		9,8
525d, 530d, 535d, xd, DPF	'05-'10	8,3-8,5		●	●		●					1,7-2,3	Getriebeöl SNS 75W-80	r	Spezialprodukt			1,6	Getriebeöl BS 75W-90	l	9,8
<b>F07 - GT Series</b>																					
530d GT, 535d GT, xDrive	'10-	7,2		●	●		●					-	-		Spezialprodukt		a	1,6	Getriebeöl BS 75W-90	l	9,8
<b>F10/F11/F18 - 5 Series</b>																					
520d	'10-	5,2		●	●		●					-	Spezialprodukt		Spezialprodukt			1	Getriebeöl BS 75W-90		7,2-7,5
525d 3.0	'10-'11	7,2		●	●		●					-	Spezialprodukt		Spezialprodukt			1	Getriebeöl BS 75W-90		10-10,6
525d 2.0	'11-	5,2		●	●		●					-	Spezialprodukt		Spezialprodukt			1	Getriebeöl BS 75W-90		7,2-7,5
530d, xDrive	'10-	7,2		●	●		●					-	Spezialprodukt	a	Spezialprodukt		a	1	Getriebeöl BS 75W-90	l	10-10,6
535d, xDrive	'10-	7,2		●	●		●					-	-		Spezialprodukt		a	1	Getriebeöl BS 75W-90	i	10-10,6
<b>E63/E64 - 6 Series</b>																					
635d	'07-'11	7,7		●	●		●					-	-		Spezialprodukt			1,2-1,4	Getriebeöl BS 75W-90		8-8,2
<b>F12/F13 - 6 Series</b>																					
640d	'11-	-		●	●		●					-	-		Spezialprodukt			-	Getriebeöl BS 75W-90		-
<b>E38 - 7 Series</b>																					
725tds, 730d	'95-'01	7-7,7	●	●	●	●						1,2	Getriebeöl SNS 75W-80	r	Spezialprodukt			1,2	Getriebeöl BS 75W-90	h	9-12
740d	'99-'01	9,5	●	●	●	●						-	-		Spezialprodukt			1,2	Getriebeöl BS 75W-90	h	16
<b>E65/E66 - 7 Series</b>																					
730d	'02-'08	8,3	●	●	●		●					-	-		Spezialprodukt			1,4	Getriebeöl BS 75W-90		10
730d DPF	'05-'08	8,3		●	●		●					-	-		Spezialprodukt			1,4	Getriebeöl BS 75W-90		10
740d	'02-'08	9,5	●	●	●		●					-	-		Spezialprodukt			1,5	Getriebeöl BS 75W-90		16,4
745d DPF	'05-'08	9,5		●	●		●					-	-		Spezialprodukt			1,5	Getriebeöl BS 75W-90		-



<b>F01/F02 - 7 Series</b>																		
730d, 740d, 740d xDrive	'08-	7,2		●	●	●				-	-		Spezialprodukt		0,9	Getriebeöl BS 75W-90	l	8,9
<b>E84 - X1 Series</b>																		
X1 sDrive18d, xDrive18d, sDrive20d, xDrive20d	'09-	-		●	●	●				-	Getr.Öl SNS-B 75W-80		Spezialprodukt		-	Getriebeöl BS 75W-90	k	7,5-7,9
xDrive23d	'09-	-		●	●	●				-	Spezialprodukt		Spezialprodukt		-	Getriebeöl BS 75W-90	k	7,5-7,9
<b>E83 - X3 Series</b>																		
X3 2.0d, 3.0d	'04-'05	5,3/7,5	●	●	●	●				-	Getriebeöl SNS 75W-80	ar	Getriebeöl ATF 55	a	-	Getriebeöl BS 75W-90	k	-
X3 1.8d, 2.0d, 3.0d, 3.0sd, xDrive, DPF	'05-'10	5,3/7,5		●	●	●			1,5-1,6	Getriebeöl SNS 75W-80	ar	Spezialprodukt	a	1	Getriebeöl BS 75W-90	k	-	
X3 xDrive20d, xDrive30d	'10-	5,2		●	●	●			-	Spezialprodukt	a	Spezialprodukt	a	1	Getriebeöl BS 75W-90	k	-	
<b>E53 - X5 Series</b>																		
X5 3.0d	'01-'03	6,5	●	●	●	●				-	Getriebeöl SNS 75W-80	br	Getriebeöl ATF 55	b	-	Getriebeöl BS 75W-90	k	10,5
X5 3.0d, DPF	'03-'07	6,5		●	●	●				-	Getriebeöl SNS 75W-80	ar	Spezialprodukt	a	-	Getriebeöl BS 75W-90	k	10,5
<b>E70 - X5 Series</b>																		
X5 3.0d, 3.5d	'07-	-		●	●	●				-	-		Spezialprodukt	a	-	Getriebeöl BS 75W-90	k	-
<b>E71 - X6 Series</b>																		
X6 xDrive30d, xDrive35d	'08-'10	-		●	●	●				-	-		Spezialprodukt	a	-	Getr.Öl BS LSX 75W-140	lq	-
X6 xDrive30d, xDrive40d	'10-	-		●	●	●				-	-		Spezialprodukt	a	-	Getr.Öl BS LSX 75W-140	lq	-

a Verteilergetriebe: Spezialprodukt, bitte auf Originalersatzteil des Herstellers zurückgreifen!

c Verteilergetriebe: 0.55 l Getr.Öl ATF E-S; Getriebeöl ATF 55

e Getriebe bis 1989: Getriebeöl SNS 75W-80; Getr.Öl EP Synth 75W-90

g Mit grünem Getriebetypenschild: Spezialprodukt, bitte auf Originalersatzteil des Herstellers zurückgreifen!

k Differentiale, vorn und hinten

m Verteilergetriebe: Getriebeöl SNS 75W-80

o Automatgetriebe GM A5S 360R/390R: Getriebeöl ATF 55

q Differenzial, Außenbereiche: Getr.Öl BS LSX 75W-140

b Verteilergetriebe: 0.5 l Getr.Öl ATF E-S; Getriebeöl ATF 55

d Mit Klimaanlage: Getr.Öl ATF E-S; Getriebeöl ATF 55

f Mit grünem Getriebetypenschild: Getriebeöl ATF 55

h Sperrdifferential: Getr.Öl BS LSX 75W-140

l Differential, vorn: Getriebeöl BS 75W-90

n Automatgetriebe GM A5S 360R/390R: Spezialprodukt, bitte auf Originalersatzteil des Herstellers zurückgreifen!

p Automatgetriebe ZF 5HP24: Spezialprodukt, bitte auf Originalersatzteil des Herstellers zurückgreifen!

r Mit gelbem Getriebetypenschild (3/2007 |>): Getr.Öl SNS-B 75W-80

## BUICK

Verano 2.4	'12-	4,7				●				-	-		Spezialprodukt		↔	↔		5,5
Century 3.1 V6, Regal 3.8 V6, Supercharger	'96-'03	4,3		●		●				-	-		Getr.Öl ATF E-S	Getriebeöl ATF 55	↔	↔		11
Century 3.1 V6, Regal 3.8 V6, Supercharger	'04-'05	4,3		●		●				-	-		Getriebeöl ATF 55	Getriebeöl ATF J	↔	↔		11
Regal 2.0L VVT Turbo, Turbo GS	'11-	5,7-6				●			2,2	Getr.Öl SNS-A 75W-85			Spezialprodukt		↔	↔		7,8
Regal 2.4L VVT, eAssist	'11-	4,7				●				-	-		Spezialprodukt		↔	↔		7,1
LaCrosse, Allure 2.4L VVT, 3.0 V6 VVT, AWD	'10-'11	4,7/5,7		●		●				-	-		Spezialprodukt		↔	↔		7,1
LaCrosse, Allure 2.4L VVT, 3.6L V6 VVT, eAssist	'11-	4,7-5,7				●				-	-		Spezialprodukt		↔	↔		7,1-9,4
LaCrosse, Allure 3.6 V6 24V, 3.8 V6	'04-'10	5,2/4,3		●		●				-	-		Spezialprodukt		↔	↔		9,7-11
LaCrosse, Allure 3.6 V6 24V	'10-'11	5,2		●		●				-	-		Spezialprodukt		↔	↔		9,4
Park Avenue, LeSabre 3.8 V6, Supercharger	'97-'03	4,3		●		●				-	-		Getr.Öl ATF E-S	Getriebeöl ATF 55	↔	↔		9,5-12,3
Park Avenue, LeSabre 3.8 V6, Supercharger	'04-'05	4,3		●		●				-	-		Getriebeöl ATF 55	Getriebeöl ATF J	↔	↔		9,5-12,3
Lucerne 3.8 V6, 4.6 V8 32V	'05-'08	4,3/7,1		●		●				-	-		Spezialprodukt		↔	↔		10,5-12
Lucerne 3.9 V6, 4.6 V8	'08-'11	3,8/7,1		●		●				-	-		Spezialprodukt		↔	↔		9,2/12
Lucerne 3.9 FlexFuel V6, 4.6 V8	'11-'11	3,8/7,1				●				-	-		Spezialprodukt		↔	↔		9,2
Terraza 3.5 V6, 3.9 V6, 4x4	'04-'07	3,8		●		●				-	-		Spezialprodukt		d	↔	b	10,2-12,2
Rendezvous 3.4 V6, 4x4	'01-'03	4,3		●		●				-	-		Getriebeöl ATF 55	Getriebeöl ATF J	d	↔	b	9,1
Rendezvous 3.4 V6, 4x4	'04-'05	4,3		●		●				-	-		Getriebeöl ATF 55	Getriebeöl ATF J	d	↔	b	9,1
Rendezvous 3.5 V6, 3.6 V6 24V, 4x4	'04-'07	5,2		●		●				-	-		Spezialprodukt		d	↔	b	9,1-10,7
Rainier 4.2 24V, 5.3 V8, 4x4	'03-'07	6,6/5,7		●		●				-	-		Spezialprodukt		c	0,8-2	a	9,2-14,5
Enclave 3.6L V6, AWD	'08-'11	5,2		●		●				-	-		Spezialprodukt		e	-		11,6
Enclave 3.6L V6, AWD	'11-'12	5,2		●		●				-	-		Spezialprodukt		e	-		10,8

a Differentiale, vorn und hinten

c Verteilergetriebe: 1.8 l Spezialprodukt, bitte auf Originalersatzteil des Herstellers zurückgreifen!

e Verteilergetriebe: Getriebeöl BS 75W-90; Getriebeöl HYP Synth 75W-90

b Differential, hinten (4WD/4x4): Spezialprodukt, bitte auf Originalersatzteil des Herstellers zurückgreifen!

d Verteilergetriebe: Spezialprodukt, bitte auf Originalersatzteil des Herstellers zurückgreifen!

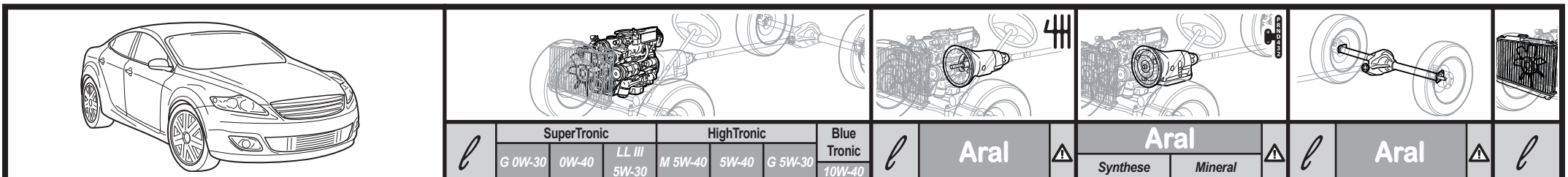

		SuperTronic		HighTronic			Blue Tronic	Aral	Aral	Aral		Aral	Aral				
		G 0W-30	0W-40	LL III 5W-30	M 5W-40	5W-40	G 5W-30 10W-40			Synthese	Mineral						
<b>CADILLAC</b>																	
BLS 2.0T, 2.8 V6, AWD	'06-'09	6	●		●		●	1,9-2,4	Getriebeöl SNS 75W-80		Getriebeöl ATF J	gh	0,6	Spezialprodukt	gh	7,5-9,6	
BLS 2.0T FlexPower	'07-'09	6	●		●		●	1,9-2,2	Getriebeöl SNS 75W-80		Getriebeöl ATF J		←	←		7,5	
ATS 2.0, 2.5, 3.6, AWD	'12-	4,7-5,7					●	-	Spezialprodukt	c	Spezialprodukt	c	0,8	Spezialprodukt		6,6-7,6	
CTS 2.6, 3.2 V6	'03-'04	4,8		●	●			1,3	Getr.Öl ATF E-S		Getr.Öl ATF E-S	Getriebeöl ATF 55	1,3	Getriebeöl BS 75W-90	d	-	
CTS 2.8, 3.6 V6	'05-'06	5,7			●			1,8	Spezialprodukt		Getriebeöl ATF 55	Getriebeöl ATF J	-	Getriebeöl BS 75W-90	d	11,1-11,8	
CTS 2.8, 3.6 V6	'07-'07	5,7		●	●			1,8	Spezialprodukt		Spezialprodukt		-	Getriebeöl BS 75W-90	d	11,1-11,8	
CTS 3.6 V6	'08-'09	5,7	●	●	●			1,8	Getriebeöl BS 75W-90	c	Spezialprodukt		c	-	Getriebeöl BS 75W-90	d	9,7
CTS 3.0 V6, 3.6 V6, AWD	'10-'10	5,7	●	●	●			1,8	Getriebeöl BS 75W-90	c	Spezialprodukt		c	-	Spezialprodukt	d	10,3
CTS 3.0 V6, 3.6 V6, AWD	'11-'12	5,7					●	1,8	Getriebeöl BS 75W-90	c	Spezialprodukt		c	-	Spezialprodukt	d	10,3
CTS 3.0 V6, AWD	'12-	5,7					●	1,8	Getriebeöl BS 75W-90	c	Spezialprodukt		c	-	Getriebeöl BS 75W-90	k	10,3
CTS 3.6 V6, AWD	'12-	5,7					●	-	-		Spezialprodukt		c	-	Spezialprodukt		11,3
CTS-V 5.7, 6.0 V8	'04-'06	5,7-6,2	●	●	●			3,5	Getriebeöl ATF 55	-	-		-	Getriebeöl BS 75W-90	d	12,7	
CTS-V 6.0 V8	'07-'07	5,7	●	●	●			3,5	Spezialprodukt	-	-		-	Getriebeöl BS 75W-90	d	12,7	
CTS-V 6.2 V8	'09-'09	5,7	●	●	●			3,5	Spezialprodukt		Spezialprodukt		-	Getriebeöl BS 75W-90	d	12,7	
CTS-V 6.2 V8	'10-'10	5,7	●	●	●			3,5	Spezialprodukt		Spezialprodukt		-	Spezialprodukt		11,8	
CTS-V 6.2 V8	'11-	5,7					●	3,8	Spezialprodukt		Spezialprodukt		-	Spezialprodukt		11,8	
XTS 3.6 V6, AWD	'12-	5,7					●	-	-		Spezialprodukt		←	←		7,1	
Seville SLS, STS 4.6 V8 32V	'97-'99	7,1	●	●	●		●	-	-		Getr.Öl ATF E-S	Getriebeöl ATF 55	←	←		12	
Seville SLS, STS 4.6 V8 32V	'00-'04	7,1	●	●	●			-	-		Getriebeöl ATF 55	Getriebeöl ATF J	←	←		11,8-12,3	
STS 3.6 V6, 4.6 V8	'04-'06	5,7/7,6	●	●	●			-	-		Getriebeöl ATF 55	Getriebeöl ATF J	a	-	Getriebeöl BS 75W-90	b	11,1/11,8
STS 3.6 V6, 3.6 SIDI V6, 4.6 V8	'07-'10	5,7-7,6	●	●	●			-	-		Spezialprodukt		e	-	Getriebeöl BS 75W-90	b	11,1-11,8
STS 3.6 SIDI V6	'11-'11	5,7					●	-	-		Spezialprodukt		e	-	Getriebeöl BS 75W-90	b	10,8
STS-V 4.4 V8 Supercharged	'06-'09	8,5	●	●	●			-	-		Spezialprodukt		-	Getriebeöl BS 75W-90		12,7	
DeVille DHS, DTS 4.6 V8	'99-'05	7,1	●	●	●			-	-		Getriebeöl ATF 55	Getriebeöl ATF J	←	←		11,8-12,3	
DTS 4.6 V8	'06-'07	7,1			●			-	-		Spezialprodukt		-	-		12-12,2	
DTS 4.6 V8	'08-'10	7,1	●	●	●			-	-		Spezialprodukt		-	-		12	
DTS 4.6 V8	'11-'11	7,1					●	-	-		Spezialprodukt		-	-		12	
XLR 4.6 V8, XLR-V 4.4 V8 Supercharged	'04-'08	7,6	●	●	●			-	-		Spezialprodukt		-	Getriebeöl BS 75W-90	d	12	
XLR 4.6 V8, XLR-V 4.4 V8 Supercharged	'09-'09	7,6	●	●	●			-	-		Spezialprodukt		-	Spezialprodukt		12	
SRX 2.8 V6 Turbo	'10-'10	5,7	●	●	●			-	-		Spezialprodukt		←	←		11,9	
SRX 2.8 V6 Turbo	'11-'11	5,7					●	-	-		Spezialprodukt		←	←		12,4	
SRX 3.0 V6 VVT	'10-'10	5,7	●	●	●			-	-		Spezialprodukt		←	←		11,9	
SRX 3.0 V6 VVT	'11-'11	5,7					●	-	-		Spezialprodukt		←	←		11,9	
SRX 3.6 V6, 4.6 V8	'04-'06	5,3-7,6	●	●	●			-	-		Getriebeöl ATF 55	Getriebeöl ATF J	a	-	Getriebeöl BS 75W-90	b	9,2-11,1
SRX 3.6 V6, 4.6 V8	'07-'09	5,7-7,6	●	●	●			-	-		Spezialprodukt		e	-	Getriebeöl BS 75W-90	b	11,1
SRX 3.6 V6	'12-	5,7					●	-	-		Spezialprodukt		←	←		12,8	
Escalade 6.0 V8	'01-'05	5,7	●	●	●			-	-		Getriebeöl ATF 55	Getriebeöl ATF J	a	-	Getriebeöl BS 75W-90	b	15
Escalade ESV / EXT 6.0 V8, 6.2 VVT V8	'05-'08	5,7	●	●	●			-	-		Spezialprodukt		a	-	Getriebeöl BS 75W-90	b	15,7
Escalade ESV / EXT 6.2 VVT V8, Two-mode Hybrid	'08-'10	5,7						-	-		Spezialprodukt		f	-	Getriebeöl BS 75W-90	b	16,7/20
Escalade ESV / EXT 6.2 VVT V8, Two-mode Hybrid	'11-	5,7					●	-	-		Spezialprodukt		f	-	Getriebeöl BS 75W-90	b	16,7/20
<b>Diesel</b>																	
BLS 1.9D 110 kW	'06-'09	4,6	●	●			●	2,2	Getriebeöl SNS 75W-80		Getriebeöl ATF 55		←	←		-	
BLS 1.9D 132 kW	'07-'09	4,6	●	●			●	2,2	Getriebeöl SNS 75W-80		Getriebeöl ATF 55		←	←		-	

a Verteilergetriebe: Getriebeöl ATF 55; Getriebeöl ATF J  
 c Verteilergetriebe: Spezialprodukt, bitte auf Originalersatzteil des Herstellers zurückgreifen!  
 e Verteilergetriebe: Spezialprodukt, bitte auf Originalersatzteil des Herstellers zurückgreifen!

b Differentiale, vorn und hinten  
 d Sperrdifferential, zufügen: Getr.Öl BS LSX 75W-140  
 f Verteilergetriebe: Spezialprodukt, bitte auf Originalersatzteil des Herstellers zurückgreifen!

g Verteilergetriebe: 0,66 l Spezialprodukt, bitte auf Originalersatzteil des Herstellers zurückgreifen!

h Haldex-Kupplung (AWD): 0,5-0,56 l Spezialprodukt, bitte auf Originalersatzteil des Herstellers zurückgreifen!

k Sperrdifferential: Getr.Öl BS LSX 75W-140

## CHERY

Fora, Elara 1.6 16V, 2.0 16V	'06-	4		●					2	Getr.Öl SNS-B 75W-80	-				↔	↔		7,5
Kimo 1.3	'07-	3,5-4,5		●		●			1,7-1,9	Getr.Öl SNS-B 75W-80	-				↔	↔		6,5
Bonus 1.5	'08-	3,6		●		●			2,3	Getr.Öl SNS-B 75W-80	-				↔	↔		7
CrossEaStar, Boss 1.8 16V, 2.0 16V, 2.4 16V	'06-'10	4,4-5		●		●			2,2	Getr.Öl SNS-B 75W-80	Getr.Öl ATF E-S				↔	↔		7,5
CrossEaStar, Boss 2.4 16V	'10-	3,5-4,5		●		●			-	-	Getr.Öl ATF E-S				↔	↔		7,5
M11, M12, Tengo, Chance, Niche 1.6, 1.8, 2.0	'08-	4,5		●		●			2,1	Getr.Öl SNS-B 75W-80	-				↔	↔		7
Tiggo 1.6, 2.0, 2.4	'06-	4,3-4,5		●		●			2,2	Getr.Öl SNS-B 75W-80	Getr.Öl ATF E-S				↔	↔		7,5
Tiggo 1.8	'06-'10	4,5		●		●			2,2	Getr.Öl SNS-B 75W-80	-				↔	↔		7,5

## CHEVROLET (EU)

Tico 0.8	'90-'97	3				●			2,1	Getr.Öl SNS-A 75W-85	-				↔	↔		3,5-4	
Matiz 0.8, 1.0	'98-'08	2,7-3,2	●	●		●			2,1	Getr.Öl SNS-A 75W-85	Getr.Öl ATF E-S				↔	↔		3,8-4,2	
Matiz 0.8, 1.0	'08-'10	2,7-3,2	●	●		●			2,1	Getr.Öl SNS-A 75W-85	Getr.Öl ATF E-S				↔	↔		4/4,2	
Spark 1.0, 1.2	'10-	3,75	●	●		●			2,1	Getr.Öl SNS-A 75W-85	Getr.Öl ATF E-S				↔	↔		4,7	
Lanos 1.3, 1.5, 1.6	'96-'02	3,8				●			1,8	Getriebeöl SNS 75W-80	Getr.Öl ATF E-S	Getriebeöl ATF 55			↔	↔		7	
Kalos 1.2	'02-'08	3,2	●	●		●			2,1	Getr.Öl SNS-A 75W-85	Getr.Öl ATF E-S	Getriebeöl ATF 55			↔	↔		4,2	
Kalos 1.4	'02-'08	3,8	●	●		●			1,8	Getriebeöl SNS 75W-80	Getr.Öl ATF E-S	Getriebeöl ATF 55			↔	↔		6	
Aveo 1.2, 1.4 16V, 1.6 16V	'05-'08	3,2-3,8	●	●		●			1,8-2,1	Getr.Öl SNS-A 75W-85	Getr.Öl ATF E-S				↔	↔		4,2-6	
Aveo 1.2	'08-'11	3,75	●	●		●			2,1	Getr.Öl SNS-A 75W-85	-				↔	↔		5,2	
Aveo 1.4	'08-'11	4,5	●	●		●			1,8	Getr.Öl SNS-B 75W-80	-	Getriebeöl ATF J			↔	↔		6,3	
Aveo 1.2, 1.4	'11-	3,75-4				●			1,6	Getr.Öl SNS-A 75W-85	Spezialprodukt				↔	↔		4,7-6	
Aveo 1.6	'11-	4,5				●			-	Getr.Öl SNS-B 75W-80	Spezialprodukt				↔	↔		5,6	
Nubira, Lacetti 1.4, 1.6	'03-'08	3,8	●	●		●			1,8	Getriebeöl SNS 75W-80	Getr.Öl ATF E-S	Getriebeöl ATF 55			↔	↔		7,2	
Nubira, Lacetti 1.4, 1.6	'08-'10	3,8	●	●		●			1,8	Getr.Öl SNS-B 75W-80	-	Getriebeöl ATF J			↔	↔		7,2	
Nubira, Lacetti 1.8	'03-'08	4	●	●		●			1,8	Getriebeöl SNS 75W-80	Spezialprodukt				↔	↔		7,4	
Nubira 1.6, 2.0	'97-'03	3,8				●			1,8	Getriebeöl SNS 75W-80	Getr.Öl ATF E-S	Getriebeöl ATF 55			↔	↔		7	
Nubira 1.8	'08-	3,75	●	●		●			1,8	Getr.Öl SNS-B 75W-80	Spezialprodukt				↔	↔		7,5	
Cruze 1.6, 1.8	'09-'11	4,5	●	●		●			2	Getr.Öl SNS-B 75W-80	Spezialprodukt				↔	↔		6,3	
Cruze 1.6	'11-	4,5	●	●		●			2	Getr.Öl SNS-B 75W-80	Spezialprodukt				↔	↔		6,3	
Volt	'11-	3,5				●			-	-	Spezialprodukt				↔	↔		-	
Tacuma, Rezzo 1.6, 1.8, 2.0 16V	'00-'08	3,8-4	●	●		●			1,9	Getriebeöl SNS 75W-80	Spezialprodukt				↔	↔		7-7,5	
Leganza 2.0	'97-'02	4		●		●			1,8	Getriebeöl SNS 75W-80	Getr.Öl ATF E-S	Getriebeöl ATF 55			↔	↔		7	
Evanda, Magnus 2.0	'02-'06	4	●	●		●			1,8	Getriebeöl SNS 75W-80	Spezialprodukt				↔	↔		7,5	
Epica 2.0 24V, 2.5 24V	'06-'07	4/6,4	●	●		●			1,8	Getriebeöl SNS 75W-80	Spezialprodukt				↔	↔		7,5-8	
Epica 2.0 24V, 2.5 24V	'07-'09	6,4	●	●		●			1,6	Getr.Öl SNS-B 75W-80	Spezialprodukt				↔	↔		8	
Epica 2.0 24V, 2.5 24V	'10-	6,4	●	●		●			1,6	Getr.Öl SNS-B 75W-80	Spezialprodukt				↔	↔		8	
Chairman 2.3 16V, 2.8 24V, 3.2 24V	'04-'08	5,8-7	●	●		●			8	Getr.Öl ATF E-S	-				1,1-1,3	Getr.Öl BS LSX 75W-140		9,8-10,2	
Captiva 2.4, 4x4	'06-'08	4,5	●	●		●			2,1	Getr.Öl SNS-B 75W-80	a	Getriebeöl ATF J	a	↔	↔		b	9	
Captiva 2.4, 4x4	'08-'09	4,5	●	●		●			2,1	Getr.Öl SNS-B 75W-80	a	Getriebeöl ATF J	a	↔	↔		b	9	
Captiva 2.4, 4x4	'10-'11	4,5	●	●		●			2,1	Getr.Öl SNS-B 75W-80	a	Getriebeöl ATF J	a	↔	↔		b	9	
Captiva 2.4 FWD, AWD	'11-	4,7				●			2,2	Getr.Öl SNS-B 75W-80	c	Spezialprodukt	c	-	Getriebeöl BS 75W-90			9	
Captiva 3.2 4x4	'06-'08	7,4	●	●		●			2,3	Getr.Öl SNS-B 75W-80	a	Getriebeöl ATF J	a	↔	↔		b	10	
Captiva 3.2 4x4	'08-'09	7,4	●	●		●			-	-	-	Getriebeöl ATF J	a	↔	↔		b	10	
Captiva 3.2 4x4	'10-'11	7,4	●	●		●			-	-	-	Getriebeöl ATF J	a	↔	↔		b	10	
Captiva 3.0 AWD	'11-	5,7				●			-	-	Spezialprodukt		c	-	Getriebeöl BS 75W-90			10,9	
Orlando 1.8	'10-	4,5	●	●		●			1,8	Getr.Öl SNS-B 75W-80	-				↔	↔		5,6	
<b>Diesel</b>																			
Nubira, Lacetti 2.0 DSL	'07-'10	6,2		●		●			2,1	Getr.Öl SNS-B 75W-80	-	Getriebeöl ATF J			↔	↔		8	
Cruze 2.0D	'09-'11	6		●		●			2,1	Getr.Öl SNS-B 75W-80	Spezialprodukt				↔	↔		10	
Cruze 2.0D	'11-	6		●		●			2,1	Getr.Öl SNS-B 75W-80	Spezialprodukt				↔	↔		10	
Epica 2.0 D	'07-'09	6,2		●		●			2,1	Getr.Öl SNS-B 75W-80	Spezialprodukt				↔	↔		8	
Epica 2.0 D	'10-	6,2		●		●			2,1	Getr.Öl SNS-B 75W-80	Spezialprodukt				↔	↔		8	
Captiva 2.0 D 4x4	'06-'08	6,2		●		●			2,3	Getr.Öl SNS-B 75W-80	a	Getriebeöl ATF J	a	↔	↔		b	9	
Captiva 2.0 D 4x4	'08-'09	6,2		●		●			2,3	Getr.Öl SNS-B 75W-80	a	Getriebeöl ATF J	a	↔	↔		b	9	
Captiva 2.0 D 4x4	'10-'11	6,2		●		●			2,3	Getr.Öl SNS-B 75W-80	a	Getriebeöl ATF J	a	↔	↔		b	9	

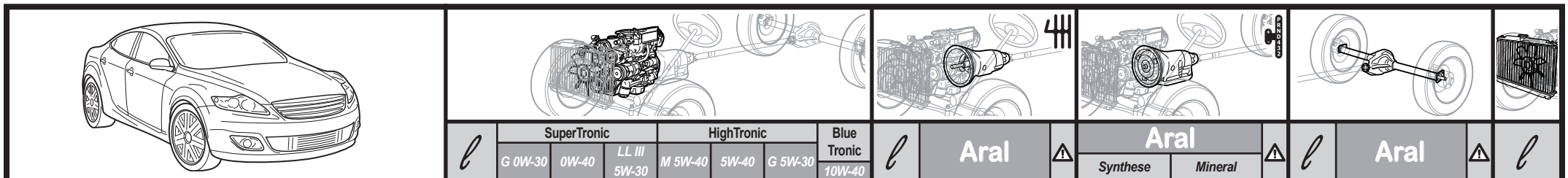
**CHEVROLET (EU)**

			SuperTronic			HighTronic			Blue Tronic		Aral		Aral			Aral		
			G 0W-30	0W-40	LL III 5W-30	M 5W-40	5W-40	G 5W-30	10W-40			Synthese	Mineral					
Captiva 2.2D FWD, AWD	'11-	6,2		●			●	●		2,2	Getr.Öl SNS-B 75W-80	c	Spezialprodukt		c	-	Getriebeöl BS 75W-90	9
Orlando 2.0D	'10-	4,5		●			●	●		1,9	Getr.Öl SNS-B 75W-80		Spezialprodukt			←	←	-

a Verteilergetriebe: 0,8 l Getriebeöl BS 75W-90; Getriebeöl SNA-C 75W-90

b Differential, hinten (4x4): 0,8 l Getriebeöl BS 75W-90; Getriebeöl SNA-C 75W-90

c Verteilergetriebe: Getriebeöl BS 75W-90; Getriebeöl SNA-C 75W-90

**CHEVROLET (USA)**

Sonic 1.4 ECOTEC, 1.8 ECOTEC	'12-	4-4,5						●	●	-	-		Spezialprodukt			←	←	6
Alero 2.4 16V, 3.4 V6	'99-'04	3,8-4,3	●			●			●	-	-		Getr. Öl ATF E-S	Getriebeöl ATF 55		←	←	11-13
Cobalt 2.0 16V Supercharged	'05-'05	4,7	●	●		●				1,7	Getriebeöl ATF 55		Getriebeöl ATF 55	Getriebeöl ATF J		←	←	7
Cobalt 2.0 16V Supercharged	'06-'07	4,7	●	●		●				1,7	Spezialprodukt		Spezialprodukt			←	←	8,7
Cobalt 2.0 16V Turbo	'08-'10	4,7	●	●		●				1,9	Spezialprodukt		Spezialprodukt			←	←	8,7
Cobalt 2.2 16V, 2.4 16V	'05-'06	4,7	●	●		●				1,6-1,7	Getriebeöl ATF 55		Getriebeöl ATF 55	Getriebeöl ATF J		←	←	7
Cobalt 2.2 16V, 2.4 16V	'07-'08	4,7	●	●		●				1,6	Spezialprodukt		Spezialprodukt			←	←	7
Cobalt 2.2 16V	'09-'10	4,7	●	●		●				1,6	Spezialprodukt		Spezialprodukt			←	←	7
Lumina, Monte Carlo 3.1, 3.4, 3.8 V6	'94-'01	3,8-4,8	●	●		●			●	-	-		Getr. Öl ATF E-S	Getriebeöl ATF 55		←	←	11-12
Impala, Monte Carlo 3.4, 3.8 V6	'00-'05	3,8/4,2	●	●		●			●	-	-		Getr. Öl ATF E-S	Getriebeöl ATF 55		←	←	10,7-11
Impala, Monte Carlo 3.5, 3.9 V6, 5.3 V8	'05-'11	3,8/5,7	●	●		●				-	-		Spezialprodukt			←	←	11,6-12,1
Impala 3.6 V6	'11-	5,7						●		-	-		Spezialprodukt			←	←	8,7
Volt	'11-	3,5						●		-	-		Spezialprodukt			←	←	-
Camaro 3.4 V6, Z28 5.7	'93-'98	3,8/4,3		●		●			●	2,8/3,8	Getr. Öl ATF E-S		Getr. Öl ATF E-S	Getriebeöl ATF 55		-	Getriebeöl BS 75W-90	f 11,6-14,5
Camaro 3.8 V6	'95-'02	4,2	●	●		●			●	3,8	Getr. Öl ATF E-S		Getr. Öl ATF E-S	Getriebeöl ATF 55		-	Getriebeöl BS 75W-90	10,8-11,3
Camaro Z28 5.7	'98-'02	5,2	●	●		●			●	3,8	Getr. Öl ATF E-S		Getr. Öl ATF E-S	Getriebeöl ATF 55		-	Getriebeöl BS 75W-90	10,8-11,3
Camaro 3.8 V6	'09-'10	5,7	●	●		●				1,8	Getriebeöl BS 75W-90		Spezialprodukt			0,9	Getriebeöl BS 75W-90	r 10,6-10,2
Camaro 3.8 V6	'11-	5,7						●		1,8	Getriebeöl BS 75W-90		Spezialprodukt			0,9	Getriebeöl BS 75W-90	r 10,6-10,2
Camaro 6.2 V8	'09-'10	7,6		●		●				3,9	Spezialprodukt		Spezialprodukt			0,9	Getriebeöl BS 75W-90	r 10,8-11,2
Camaro 6.2 V8	'11-	7,6						●		3,9	Spezialprodukt		Spezialprodukt			0,9	Getriebeöl BS 75W-90	r 10,8-11,2
Corvette 5.7 V8, Z06	'97-'04	6,1-6,2		●		●			●	3,8	Getr. Öl ATF E-S		Getr. Öl ATF E-S	Getriebeöl ATF 55		1,7	Getr. Öl BS LSX 75W-140	11,9
Corvette 6.0 V8	'05-'07	5,2		●		●				3,8	Getriebeöl ATF 55		Spezialprodukt			1,7	Getr. Öl BS LSX 75W-140	11,9
Corvette 6.2 V8	'08-'10	5,7		●		●				3,8	Spezialprodukt		Spezialprodukt			-	Spezialprodukt	11,3
Corvette 6.2 V8	'11-	5,7						●		3,5	Spezialprodukt		Spezialprodukt			-	Spezialprodukt	11,3
Corvette Z16 6.2 V8 Grand Sport	'10-'10	9,9		●		●				4	Spezialprodukt		Spezialprodukt			-	Spezialprodukt	11,3
Corvette Z16 6.2 V8 Grand Sport	'11-	9,9						●		4	Spezialprodukt		Spezialprodukt			-	Spezialprodukt	11,3
Corvette Z06 7.0 V8	'05-'06	9,9		●		●				4,3	Getriebeöl ATF 55		-			-	Getr. Öl BS LSX 75W-140	11,9
Corvette Z06 7.0 V8, Corvette ZR1	'07-'10	9,9		●		●				4,3	Spezialprodukt		-			-	Spezialprodukt	11,3-12
Corvette Z06 7.0 V8, Corvette ZR1	'11-	9,9						●		4,3	Spezialprodukt		-			-	Spezialprodukt	11,3-12
Malibu 2.2 16V, 2.4 16V	'04-'08	4,7	●	●		●				-	-		Spezialprodukt			←	←	7,1
Malibu 2.4 16V	'08-'10	4,7	●			●				-	-		Spezialprodukt			←	←	7,1
Malibu 2.4 16V	'11-	4,7						●		-	-		Spezialprodukt			←	←	7,1
Malibu 3.5 V6	'04-'10	3,8	●			●				-	-		Spezialprodukt			←	←	9,2
Malibu 3.6 V6	'07-'10	5,2	●			●				-	-		Spezialprodukt			←	←	9,2
Malibu 3.6 V6	'11-	5,2						●		-	-		Spezialprodukt			←	←	9,2
Malibu SS 3.9 V6	'06-'07	3,8	●			●				-	-		Spezialprodukt			←	←	9,3
Malibu Maxx 3.5 V6	'04-'07	3,8	●			●				-	-		Spezialprodukt			←	←	9,2
Malibu Maxx SS 3.9 V6	'06-'07	3,8	●			●				-	-		Spezialprodukt			←	←	9,3
Trans Sport 3.4 V6	'96-'04	4,2	●			●			●	-	-		Getr. Öl ATF E-S	Getriebeöl ATF 55		←	←	9,1-12,6
Uplander 3.5 V6	'05-'05	4,3	●			●				-	-		Getriebeöl ATF 55	Getriebeöl ATF J		←	←	10,7-12,2

Uplander 3.5 V6	'05-'08	4,3	●	●	●					-	-					Spezialprodukt			↔	↔			10,7-12,2	
Traverse 3.6 V6, AWD	'09-'10	5,2	●	●	●					-	-					Spezialprodukt			-		Getriebeöl BS 75W-90		10,8	
Traverse 3.6 V6, AWD	'11-	5,2						●		-	-					Spezialprodukt		v	-		Getriebeöl BS 75W-90		10,8	
HHR SS 2.0 Turbo	'07-'10	4,7		●	●					1,9	Spezialprodukt					Spezialprodukt			↔	↔			8,7	
HHR 2.2 16V, 2.4 16V	'06-'06	4,8	●	●	●					1,7	Getriebeöl ATF 55					Spezialprodukt			↔	↔			7-7,5	
HHR 2.2 16V, 2.4 16V	'07-'10	4,7	●	●	●					1,6	Spezialprodukt					Spezialprodukt			↔	↔			7-8	
HHR 2.2 16V, 2.4 16V	'11-	4,7						●		1,6	Spezialprodukt					Spezialprodukt			↔	↔			7-8	
SSR 6.0 V8	'04-'06	5,2	●	●	●					3,5	Getriebeöl BS 75W-90					Getriebeöl ATF 55	Getriebeöl ATF J		2-2,6		Getriebeöl BS 75W-90		13	
Equinox 2.4, 3.0 V6	'10-	4,7-5,7						●		-	-		c			Spezialprodukt			-	-		c	10,2	
Equinox 3.4 V6	'05-'09	4,3	●	●	●					-	-						Getriebeöl ATF J		-	-	Spezialprodukt		10	
Equinox 3.6 V6	'08-'09	4,3	●	●	●					-	-					Spezialprodukt			-	-	Getriebeöl BS 75W-90		10	
Colorado 2.8 16V, 3.5 20V	'04-'06	4,7/5,6	●	●	●					2,4	Spezialprodukt	l				Getriebeöl ATF 55	Getriebeöl ATF J	l	1,6-1,8		Getriebeöl BS 75W-90	g	9,8	
Colorado 2.9 16V, 3.7 20V	'06-'10	4,7/5,6	●	●	●					2,4	Spezialprodukt	l				Spezialprodukt		l	1,6-1,8		Getriebeöl BS 75W-90	g	9,8-10	
Colorado 2.9 16V, 3.7 20V	'11-	4,7/5,6						●		2,4	Spezialprodukt	l				Spezialprodukt		l	1,6-1,8		Getriebeöl BS 75W-90	g	9,8-10	
Colorado 5.3 20V	'06-'10	5,7						●		-	-					Spezialprodukt		l	1,6-1,8		Getriebeöl BS 75W-90	g	10	
Colorado 5.3 20V	'11-	5,7						●		-	-					Spezialprodukt		l	1,6-1,8		Getriebeöl BS 75W-90	g	10	
Blazer 4.3 V6	'94-'97	4,3		●	●			●		2	Getriebeöl SNS 75W-80	c				Getr.Öl ATF E-S	Getriebeöl ATF 55	c	1,2/1,9		Getriebeöl BS 75W-90	g	11,5	
Blazer 4.3 V6	'97-'05	4,3		●	●			●		2	Getriebeöl SNS 75W-80	c				Getr.Öl ATF E-S	Getriebeöl ATF 55	c	-		Getriebeöl BS 75W-90		11,5	
TrailBlazer 4.2 24V, 5.3 V8	'01-'09	5,7-6,6		●	●					-	-		a			Getr.Öl ATF E-S	Getriebeöl ATF 55	a	-		Getriebeöl BS 75W-90	g	13,1-14,4	
TrailBlazer SS 6.0 V8	'05-'09	5,7	●	●	●					-	-		a			Getr.Öl ATF E-S	Getriebeöl ATF 55	a	-		Getr.Öl BS LSX 75W-140	s	10,6	
Tahoe, Suburban 4.8, 5.3, 6.0 V8	'99-'01	5,7	●	●	●			●		-	-					Getr.Öl ATF E-S	Getriebeöl ATF 55	c	3,8		Getriebeöl BS 75W-90	h	12,7-14,1	
Tahoe, Suburban 4.8, 5.3, 6.0 V8	'02-'05	5,7	●	●	●					-	-					Getr.Öl ATF E-S	Getriebeöl ATF 55	c	-		Getriebeöl BS 75W-90	dgk	-	
Tahoe, Suburban 4.8, 5.3, 6.0 V8	'06-'09	5,7	●	●	●					-	-					Spezialprodukt		a	1,4-3		Getriebeöl BS 75W-90	dg	16,5-17,3	
Tahoe, Suburban 5.3 V8	'09-'10	5,7	●	●	●					-	-					Spezialprodukt		a	2-2,85		Getr.Öl BS LSX 75W-140	dg	16,5-17,3	
Tahoe, Suburban 6.2 V8	'09-'10	5,7	●	●	●					-	-					Spezialprodukt		m	2-2,85		Getriebeöl BS 75W-90	s	16,5-17,3	
Tahoe 1500 Hybrid	'08-'10	5,7	●	●	●					-	-					Spezialprodukt		u	2-2,85		Getriebeöl BS 75W-90	u	14,7	
Tahoe 2500 Hybrid	'08-'10	5,7	●	●	●					-	-					Spezialprodukt		s	2-2,85		Getriebeöl BS 75W-90	s	14,7	
Tahoe 1500 Hybrid	'11-	5,7						●		-	-					Spezialprodukt		u	2-2,85		Getriebeöl BS 75W-90	u	14,7	
Tahoe 2500 Hybrid	'11-	5,7						●		-	-					Spezialprodukt		s	2-2,85		Getriebeöl BS 75W-90	s	14,7	
Avalanche 5.3, 8.1 V8	'02-'06	5,7-6,1	●	●	●					-	-					Getr.Öl ATF E-S	Getriebeöl ATF 55	a	-		Getriebeöl BS 75W-90	hk	-	
Avalanche 5.3, 5.3 Flex Fuel, 6.0 V8	'07-'10	5,7	●	●	●					-	-					Spezialprodukt		n	-		Getriebeöl BS 75W-90	o	15,9	
Avalanche 5.3 Flex Fuel V8	'11-	5,7						●		-	-					Spezialprodukt		p	-		Getriebeöl BS 75W-90	o	15,9	
Silverado Classic 4.3 V6	'02-'06	4,3	●	●	●					2,0/2,3	Getriebeöl SNS 75W-80	be				Spezialprodukt		a	1,4-3		Getriebeöl BS 75W-90	dg	14-15,7	
Silverado Classic 4.8, 5.3, 6.0 V8	'02-'06	5,7	●	●	●					2,0/2,3	Getriebeöl SNS 75W-80	be				Spezialprodukt		a	1,4-3		Getriebeöl BS 75W-90	dg	14-15,9	
Silverado Classic 8.1 V8	'02-'06	6,1	●	●	●					2,0/2,3	Getriebeöl SNS 75W-80	be				Spezialprodukt		a	1,4-3		Getriebeöl BS 75W-90	dg	23,7-25,6	
Silverado 4.3 V6	'06-'10	4,3			●					-	-					Spezialprodukt		m	1,4-2,6		Getriebeöl BS 75W-90	dg	15,6	
Silverado 4.3 V6	'11-	4,3						●		-	-					Spezialprodukt		p	2-2,6		Getriebeöl BS 75W-90	dg	15,6	
Silverado 4.8, 5.3, (HD) 6.0 V8	'06-'10	5,7	●	●	●					-	-					Spezialprodukt		m	1,4-2,6		Getriebeöl BS 75W-90	dg	15,6-15,9	
Silverado 4.8, 5.3, (HD) 6.0 V8	'11-	5,7						●		3,5-4,4	Getriebeöl SNS 75W-80					Spezialprodukt		p	2-2,6		Getriebeöl BS 75W-90	dg	15,6-15,9	
Silverado Hybrid	'09-'10	5,7	●	●	●					-	-					Spezialprodukt		p	2-2,6		Getriebeöl BS 75W-90	dg	15,6-15,9	
Silverado Hybrid	'11-	5,7						●		-	-					Spezialprodukt		p	2-2,6		Getriebeöl BS 75W-90	dg	15,6-15,9	
<b>Diesel</b>																								
Silverado HD 6.6 V8 DPF	'11-	9,5						●		-	-					Spezialprodukt		p	-		Getriebeöl BS 75W-90	g	27	

- a Verteilergetriebe: Spezialprodukt, bitte auf Originalersatzteil des Herstellers zurückgreifen!
- c Verteilergetriebe: Getr.Öl ATF E-S; Getriebeöl ATF 55
- e Getriebe Typ NV 4500: 3,8 l Getr.Öl SNS-A 75W-85; Getriebeöl SNS 75W-80
- g Differentiale, vorn und hinten
- k Differential, Hinterachse (lenkbare Achse): Spezialprodukt, bitte auf Originalersatzteil des Herstellers zurückgreifen!
- m Verteilergetriebe: Spezialprodukt, bitte auf Originalersatzteil des Herstellers zurückgreifen!
- o Differential, vorn (4x4): Getriebeöl BS 75W-90; Getriebeöl SNA-C 75W-90
- r Sperrdifferential: Getr.Öl BS LSX 75W-140
- u Differential, vorn (4x4): Getr.Öl EP Synth 75W-90; Getriebeöl EP 85W-90

- b Verteilergetriebe: 1,9-2,1 l Spezialprodukt, bitte auf Originalersatzteil des Herstellers zurückgreifen!
- d Differential, vorn, selektierbar: Getriebeöl BS 75W-90; Getriebeöl SNA-C 75W-90
- f Sperrdifferential: Getriebeöl BS 75W-90; Getr.Öl HYP LS 85W-90
- h Differential, vorn (4x4): Getriebeöl LSX 75W-140; Getr.Öl HYP LS 85W-90
- l Verteilergetriebe: Getriebeöl SNS 75W-80; Getriebeöl EP 80W
- n Verteilergetriebe: 1,5-1,9 l Spezialprodukt, bitte auf Originalersatzteil des Herstellers zurückgreifen!
- p Verteilergetriebe: 1,5 l Spezialprodukt, bitte auf Originalersatzteil des Herstellers zurückgreifen!
- s Differential, vorn: Getriebeöl BS 75W-90; Getriebeöl HYP Synth 75W-90
- v Verteilergetriebe: Getriebeöl BS 75W-90; Getriebeöl HYP Synth 75W-90

CHRYSLER	Modell	Jahr	Leistung	SuperTronic						Blue Tronic	Aral	Aral	Aral		Aral	Aral	Leistung	
				G 0W-30	0W-40	LL III 5W-30	M 5W-40	5W-40	G 5W-30				10W-40	Synthese				Mineral
Neon 1.6, 1.8, 2.0	'93-'03	4,3-4,5		●			●		●	2,1	Getriebeöl SNS 75W-80	Getr.Öl ATF E-S		↔	↔	6-6,5		
Crossfire, SRT-6	'03-'09	8	●	●		●				1,8	Getriebeöl SGF 84	Spezialprodukt		1,3	Getr.Öl BS LSX 75W-140	11,2-14,5		
PT Cruiser 2.0, 2.4	'99-'10	4,8	●	●		●				2,4-2,7	Getriebeöl SNS 75W-80	Spezialprodukt		↔	↔	7		
PT Cruiser 1.6, 2.4 T	'99-'10	4,3-4,8	●	●		●				1,8-2,7	Getriebeöl SNS 75W-80	Spezialprodukt		↔	↔	4,3-6,2		
Stratus, Convertible	'94-'00	4,3	●	●		●			●	2,1	Getriebeöl SNS 75W-80	Spezialprodukt		↔	↔	8-10		
Sebring 2.0, 2.4, 2.7 V6	'00-'06	4,3-4,8	●	●		●				2,4-2,7	Getriebeöl SNS 75W-80	Spezialprodukt		↔	↔	9-10		
Sebring 2.4, 2.7 V6	'06-'07	4,3-5,2	●	●		●				-	-	Spezialprodukt		↔	↔	7,3-9,3		
Sebring 3.5 V6	'06-'10	5,2	●	●		●				-	-	Spezialprodukt		↔	↔	11		
200 2.4 16V	'11-	4,4	HighTronic F 5W-30								-	-	Spezialprodukt	m	↔	↔	7,3	
200 3.6 V6	'11-	5,6	HighTronic F 5W-30								-	-	Spezialprodukt	m	↔	↔	11	
300M 2.7, 3.5	'98-'04	5,3-5,8				●			●	-	-	Spezialprodukt		↔	↔	b 7,8		
300C 2.7 V6	'05-'06	5,7	●	●		●				-	-	Spezialprodukt		1,4	Getr.Öl BS LSX 75W-140	10-10,5		
300C 2.7 V6	'06-'10	5,7	HighTronic F 5W-30								-	-	Spezialprodukt		-	Getr.Öl BS LSX 75W-140	9,2-9,4	
300C 3.5 V6, AWD	'06-'10	5,7	HighTronic F 5W-30								-	-	Spezialprodukt	eg	-	Getr.Öl BS LSX 75W-140	f 10	
300C 5.7 HEMI V8, AWD	'05-'10	6,6	HighTronic F 5W-30								-	-	Spezialprodukt	eg	-	Getr.Öl BS LSX 75W-140	f 10,5	
300C 6.1 HEMI V8 SRT-8	'05-'09	6,6		●					●	-	-	Spezialprodukt		-	Getr.Öl BS LSX 75W-140	14		
300C 6.1 HEMI V8 SRT-8	'09-'10	6,6				●				-	-	Spezialprodukt		-	Getr.Öl BS LSX 75W-140	14,4		
300 3.6 V6, AWD	'11-'12	5,6	HighTronic F 5W-30								-	-	Spezialprodukt	g	-	Getr.Öl BS LSX 75W-140	h 10,8	
300 3.6 V6, AWD	'12-	5,6	HighTronic F 5W-30								-	-	Spezialprodukt	g	-	Getr.Öl BS LSX 75W-140	h 10,5	
300 5.7 HEMI V8, AWD	'11-	6,6	HighTronic F 5W-30								-	-	Spezialprodukt	g	-	Getr.Öl BS LSX 75W-140	h 13,9-14,3	
300 6.4 HEMI V8 SRT8	'12-	6,6				●				-	-	Spezialprodukt		-	Getr.Öl BS LSX 75W-140	41,4		
(Grand) Voyager 2.4i	'95-'01	4,3				●			●	2,2	HighTronic 5W-40	Getr.Öl ATF E-S		↔	↔	10,5		
(Grand) Voyager 2.4, 3.3	'01-'04	4-4,7	●	●		●			●	2,2	Spezialprodukt	Spezialprodukt		↔	↔	10,7-15,4		
Voyager 2.4i	'04-'08	4,7				●				-	Spezialprodukt	Spezialprodukt		↔	↔	10,7		
(Grand) Voyager 3.3i	'95-'00	4,3				●			●	-	-	Spezialprodukt		↔	↔	12,5		
(Grand) Voyager 3.3i	'00-'01	4,3	●			●				-	-	Spezialprodukt		↔	↔	12,5		
(Grand) Voyager 3.3i V6 AWD	'01-'04	4	●	●		●			●	-	-	Spezialprodukt	c	1,2	Getriebeöl BS 75W-90	12,6-15,4		
(Grand) Voyager 3.3	'04-'10	4,7	HighTronic F 5W-30								-	-	Spezialprodukt		↔	↔	12,6-15,4	
(Grand) Voyager 3.8i AWD	'96-'00	4,3				●			●	-	-	Spezialprodukt	c	1,9	Getriebeöl BS 75W-90	12,5		
(Grand) Voyager 3.6	'11-	5,6	HighTronic F 5W-30								-	-	Spezialprodukt		↔	↔	12,6-15,4	
(Grand) Voyager 3.8i AWD	'00-'01	4,3	●			●				-	-	Spezialprodukt	c	1,9	Getriebeöl BS 75W-90	12,5		
(Grand) Voyager 3.8, AWD	'01-'04	4,7	HighTronic F 5W-30								-	-	Spezialprodukt	k	-	Getriebeöl BS 75W-90	l 12,6-15,4	
(Grand) Voyager 3.8	'05-'10	4,7	HighTronic F 5W-30								-	-	Spezialprodukt		↔	↔	12,6-15,4	
(Grand) Voyager 4.0	'08-'10	4,7	HighTronic F 5W-30								-	-	Spezialprodukt		↔	↔	12,6-15,4	
Pacifica 3.5 V6, 3.8 V6	'03-'08	5,2/4,7	●	●		●				-	-	Spezialprodukt	d	0,7	Getriebeöl BS 75W-90	9,9		
Aspen 4.7 V8, 5.7 HEMI V8	'06-'09	5,7/6,6	●	●		●				-	-	Spezialprodukt	a	-	Getr.Öl BS LSX 75W-140	f 15,5/17,8		
Viper R/T 10	'93-'02	9		●		●			●	3,8	Getr.Öl ATF E-S	-		1,4	Getr.Öl BS LSX 75W-140	15		
<b>Diesel</b>																		
PT Cruiser CRD	'02-'10	7		●				●		2,4-2,7	Spezialprodukt	-		↔	↔	9		
Sebring 2.0 16V CRD	'07-'10	4,2		●			●			2	Spezialprodukt	-		↔	↔	7,3		
300C 3.0 CRD	'05-'10	8,5		●			●			-	-	Spezialprodukt		1,4-1,6	Getr.Öl BS LSX 75W-140	10-10,5		
(Grand) Voyager 2.5 TD	'96-'00	6		●			●		●	2,2	HighTronic 5W-40	-	↔	↔		10-12		
(Grand) Voyager 2.5 CRD	'01-'08	6		●			●		●	2,2-2,7	Spezialprodukt	-		↔	↔	13,8		
(Grand) Voyager 2.8 CRD	'04-'07	6		●			●		●	-	-	Spezialprodukt		↔	↔	13,8-16,6		

a Verteilergetriebe: Spezialprodukt, bitte auf Originalersatzteil des Herstellers zurückgreifen!

c Verteilergetriebe: 1,2 | Getriebeöl BS 75W-90; Getriebeöl SNA-C 75W-90

b Differential, Modelle mit Automatikgetriebe: 1 | Getriebeöl BS 75W-90; Getriebeöl SNA-C 75W-90

d Verteilergetriebe: 1 | Getriebeöl BS 75W-90; Getriebeöl SNA-C 75W-90

e Verteilergetriebe: 0,6 l Spezialprodukt, bitte auf Originalersatzteil des Herstellers zurückgreifen!

g Verteilergetriebe Borg Warner 44-40: Spezialprodukt, bitte auf Originalersatzteil des Herstellers zurückgreifen!

k Verteilergetriebe: Getriebeöl BS 75W-90; Getriebeöl SNA-C 75W-90

m Transaxle-Getriebe, Halbautomatik C635 DDCT

f Differential, vorn (4x4): Getriebeöl BS 75W-90; Getriebeöl SNA-C 75W-90

h Differential, vorn (4x4): Getriebeöl BS 75W-90; Getriebeöl SNA-C 75W-90

l Freilaufkupplung: Spezialprodukt, bitte auf Originalersatzteil des Herstellers zurückgreifen!

## CITROËN

AX 10, 11, 14, Sport, GT, GTI	'86-'92	3,5			●					2/2,6	Getr.Öl EP Synth 75W-90		-						↳	↳	b	5
AX 10, 11, 14, GT, GTI, 4x4	'92-'96	3,5			●					2/2,6	Getr.Öl EP Synth 75W-90		-						↳	↳	b	5
C-Zero	'10-	-								-	-	Spezialprodukt							↳	↳		5,1
C1 1.0	'05-'09	3,1		●	●					1,7	Spezialprodukt								↳	↳		4
C1 1.0	'09-	3,1		●	●					1,7	Spezialprodukt								↳	↳		4
C2 1.1, 1.4, 1.6 16V	'03-'09	3,2		●	●					-			↳		↳				7			
C2 1.1, 1.4, 1.6 16V	'09-'10	3,2		●	●					-	Getr.Öl EP Synth 75W-90								↳	↳		7
Saxo 1.0-1.6 16V	'96-'99	3-3,5			●					2	Getr.Öl EP Synth 75W-90	Getr.Öl ATF E-S	Getriebeöl ATF 55						↳	↳		5
Saxo 1.0-1.6 16V VTS	'99-'03	3-3,5			●					2	Getr.Öl EP Synth 75W-90	Getr.Öl ATF E-S	Getriebeöl ATF 55						↳	↳		5
DS3 1.4 VTi, 1.6 VTi, 1.6 THP, Racing	'10-	4,25						HighTronic J 5W-30		1,8-2,2	Getr.Öl EP Synth 75W-90	Spezialprodukt							↳	↳		5,7-6
C3 1.1, 1.4 (16V), 1.6 16V	'01-'09	3-3,4		●	●					1,9-2	Getr.Öl EP Synth 75W-90	Spezialprodukt							↳	↳		6-7
C3 1.1i, 1.4i	'09-	3,4								1,9-2	Getr.Öl EP Synth 75W-90	-							↳	↳		7
C3 1.4 VTi, 1.6 VTi	'09-	3,1-3,4						HighTronic J 5W-30		2	Getr.Öl EP Synth 75W-90	Spezialprodukt							↳	↳		6-7
C3 Picasso 1.4 VTi, 1.6 VTi	'09-	4,3						HighTronic J 5W-30		1,8	Spezialprodukt	Spezialprodukt							↳	↳	g	6
ZX 1.1i, 1.4i	'91-'93	3,5			●					2	Getr.Öl EP Synth 75W-90	-							↳	↳		6,5
ZX 1.1i, 1.4i	'94-'98	3,5			●					2	Getr.Öl EP Synth 75W-90	-							↳	↳		6,5
ZX 1.6i, 1.9i, 2.0i	'91-'93	5-5,4			●					1,9	Getr.Öl EP Synth 75W-90	Getr.Öl ATF E-S	Getriebeöl ATF 55						↳	↳		7,5-8,5
ZX 1.6i, 1.9i, 2.0i (16V)	'94-'98	5-5,4			●					1,9	Getr.Öl EP Synth 75W-90	Getr.Öl ATF E-S	Getriebeöl ATF 55						↳	↳		7,5-8,5
ZX 1.8i (16V), 2.0i 16V	'94-'98	4,75/4,3			●					1,9	Getr.Öl EP Synth 75W-90	Getr.Öl ATF E-S	Getriebeöl ATF 55						↳	↳		8,5
Xsara, Picasso 1.4i, 1.6i	'97-'99	3,5			●					2	Getr.Öl EP Synth 75W-90	-							↳	↳		6,5-7
Xsara, Picasso 1.4i, 1.6i (16V)	'99-'05	3,5			●					2	Getr.Öl EP Synth 75W-90	Spezialprodukt							↳	↳		6,5-7
Xsara, Picasso 1.8i (16V), 2.0i 16V VTS	'97-'05	4,3-4,8			●					1,8	Getr.Öl EP Synth 75W-90	Getr.Öl ATF E-S	Getriebeöl ATF 55						↳	↳		7-9
Xsara, Picasso 2.0i 16V	'97-'07	4,25			●					1,8	Getr.Öl EP Synth 75W-90	Spezialprodukt							↳	↳		7
C4 1.4 16V, 1.6 16V	'04-'10	3,2-3,5		●	●					1,8-2	Getr.Öl EP Synth 75W-90	Spezialprodukt							↳	↳		5,8-6,7
C4 1.6 VTi, 1.6 THP	'08-'10	4,2						HighTronic J 5W-30		2	Getr.Öl EP Synth 75W-90	Spezialprodukt							↳	↳		6-6,4
C4 2.0 16V 100 kW	'04-'08	4,3			●					1,8	Getr.Öl EP Synth 75W-90	Spezialprodukt							↳	↳		6,6-8,8
C4 2.0 16V 130 kW	'04-'08	5,5			●					1,8	Getr.Öl EP Synth 75W-90	-							↳	↳		6,6
C4 / DS4 1.4i VTi 16V, 1.6i VTi 16V, 1.6i THP 16V	'10-	4,25						HighTronic J 5W-30		1,8	Spezialprodukt	Spezialprodukt							↳	↳	g	-
C4 1.6i 16V	'10-	3,25			●					1,8	Spezialprodukt	-							↳	↳		-
C4 Aircross 1.6i, 2.0i , 4x4	'12-	4,2-4,3						HighTronic J 5W-30		2-2,5	Getr.Öl EP Synth 75W-90	h	Spezialprodukt						h	0,5	Getriebeöl Hyp 80W	-
(Grand) C4 Picasso 1.6 VTi, 1.6 THP	'08-	4,25						HighTronic J 5W-30		2	Getr.Öl EP Synth 75W-90	Spezialprodukt							↳	↳		6-6,4
(Grand) C4 Picasso 1.8 16V	'06-'08	5								1,8	Getr.Öl EP Synth 75W-90	Spezialprodukt							↳	↳		6,5-6,7
(Grand) C4 Picasso 2.0 16V	'06-'08	5			●					1,8	Getr.Öl EP Synth 75W-90	Spezialprodukt							↳	↳		6,5-6,7
BX 14, 16, 19, 19 GT, GTi, 19 16 V, 4x4	'82-'95	5-5,3			●					1,8	Getr.Öl EP Synth 75W-90	a	Getr.Öl ATF E-S	Getriebeöl ATF 55					↳	↳	c	6,5-7
Xantia 1.6i	'93-'94	4,3-5,7			●					1,8	Getr.Öl EP Synth 75W-90	-							↳	↳		7-8,5
Xantia 1.6i	'95-'98	4,8			●					1,8	Getr.Öl EP Synth 75W-90	-							↳	↳		7
Xantia 1.8i (16V)	'93-'01	4,8-5,7			●					1,8	Getr.Öl EP Synth 75W-90	Getr.Öl ATF E-S	Getriebeöl ATF 55						↳	↳		7-8
Xantia 2.0i (16V)	'93-'96	4,5-4,75			●					1,9	Getr.Öl EP Synth 75W-90	Getr.Öl ATF E-S	Getriebeöl ATF 55						↳	↳		7-8,3
Xantia 2.0i (16V)	'96-'00	4,25			●					1,9	Getr.Öl EP Synth 75W-90	Getr.Öl ATF E-S	Getriebeöl ATF 55						↳	↳		7,5
Xantia 2.0i Turbo CT	'95-'00	5,3			●					1,8	Getr.Öl EP Synth 75W-90	-							↳	↳		7-8,5
Xantia V6	'97-'00	5,5			●					1,9	Getr.Öl EP Synth 75W-90	Spezialprodukt							↳	↳		10
C5 1.6 VTi, THP	'09-	4,25						HighTronic J 5W-30		1,9-2,1	Getr.Öl EP Synth 75W-90	g	Spezialprodukt						↳	↳	k	-
C5 1.8, 2.0	'01-'05	4,3			●					1,8	Getr.Öl EP Synth 75W-90	Spezialprodukt							↳	↳		8-9
C5 1.8i 16V	'05-'10	5,05			●					1,8	Getr.Öl EP Synth 75W-90	-							↳	↳		8
C5 2.0 HPI, 3.0i V6	'00-'08	4,3/5,3			●					1,8	Getr.Öl EP Synth 75W-90	Spezialprodukt							↳	↳		9-12
C5 3.0i V6	'08-'09	5,25			●					1,8	Getr.Öl EP Synth 75W-90		Getriebeöl ATF J						↳	↳		12
C5 2.0i 16V	'04-'10	4,3-5,3			●					1,8	Getr.Öl EP Synth 75W-90	Spezialprodukt							↳	↳		8-12
XM 2.0, 2.0i, 2.0i Turbo	'90-'95	4,8-5,3			●					2,2	Getr.Öl EP Synth 75W-90	Getr.Öl ATF E-S	Getriebeöl ATF 55						↳	↳	d	7,5
XM 2.0i 16V, Turbo CT	'95-'01	4,8-5,3			●					2,2	Getr.Öl EP Synth 75W-90	Getr.Öl ATF E-S	Getriebeöl ATF 55						↳	↳	d	7,5
XM V6 3.0	'89-'93	6,5			●					1,9	Getr.Öl EP Synth 75W-90	Getr.Öl ATF E-S	Getriebeöl ATF 55						↳	↳		9,5
XM V6 3.0	'94-'97	6,5			●					1,9	Getr.Öl EP Synth 75W-90	Getr.Öl ATF E-S	Getriebeöl ATF 55						↳	↳		9,5
XM V6 24 3.0	'89-'93	6,5			●					1,9	Getr.Öl EP Synth 75W-90	Getr.Öl ATF E-S	Getriebeöl ATF 55						↳	↳		10
XM V6 24 3.0	'94-'97	6,5			●					1,9	Getr.Öl EP Synth 75W-90	Getr.Öl ATF E-S	Getriebeöl ATF 55						↳	↳		10

CITROËN	Modell	Jahr	SuperTronic						HighTronic			Blue Tronic	4H	Aral		Aral	Aral	Aral	Aral	
			G 0W-30	0W-40	LL III 5W-30	M 5W-40	5W-40	G 5W-30	10W-40	Aral										
			Synthese		Mineral		Aral													
XM 2.9 V6 24V	'97-'00	5,5	●			●				●	1,9	Getr.Öl EP Synth 75W-90	Spezialprodukt			↔	↔	10		
DS5 1.6 THP	'11-	4,25	HighTronic J 5W-30									2,1	Getr.Öl EP Synth 75W-90	Spezialprodukt			↔	↔	-	
C6 3.0 V6	'06-'09	4,8-5,3	●	●			●			●	-	-		Getriebeöl ATF J			↔	↔	11,3	
Evasion, Synergie 1.8i, 2.0i, Turbo	'94-'00	4,2-4,9		●			●			●	1,8-1,9	Getr.Öl EP Synth 75W-90	-			↔	↔	8,5-9		
Evasion, Synergie 2.0 (16V), Turbo	'00-'02	4,3-4,9	●	●			●			●	1,8-1,9	Getr.Öl EP Synth 75W-90	-			↔	↔	8,5-9		
Evasion, Synergie 2.0i Turbo CT	'96-'97	4,75		●			●			●	1,8	Getr.Öl EP Synth 75W-90	-			↔	↔	9		
Evasion, Synergie 2.0i Turbo CT	'98-'99	4,75		●			●			●	1,8	Getr.Öl EP Synth 75W-90	-			↔	↔	9		
Evasion, Synergie 2.0i Turbo CT	'99-'00	4,75		●			●			●	1,8	Getr.Öl EP Synth 75W-90	-			↔	↔	9		
C8 2.0 16V, 3.0 V6 24V	'02-'09	4,3/5,3	●	●			●			●	1,8	Getr.Öl EP Synth 75W-90	Spezialprodukt			↔	↔	7-10,5		
C8 2.0 16V	'09-'11	4,3/5,3		●			●			●	1,8	Getr.Öl EP Synth 75W-90	Spezialprodukt			↔	↔	7-10,5		
C8 2.2 16V	'02-'06	4,3		●			●			●	1,8	Getr.Öl EP Synth 75W-90	-			↔	↔	7,2		
C-crosser 2.4 16V	'07-'09	4,6		●			●				2	Getr.Öl EP Synth 75W-90	e	Getriebeöl ATF J	f	0,5	Getr.Öl HYP LS 85W-90	7,5		
C-crosser 2.4 16V	'09-	4,6	HighTronic J 5W-30									2,5	Getr.Öl EP Synth 75W-90	l	Spezialprodukt		0,5	Getriebeöl BS 75W-90	7,5	
Berlingo 1.1i, 1.4i	'96-'01	3,5		●						●	2	Getr.Öl EP Synth 75W-90	-			↔	↔	6,5-7		
Berlingo 1.8i	'98-'00	5		●			●			●	1,8	Getr.Öl EP Synth 75W-90	-			↔	↔	8		
Berlingo 1.4i, 1.6i 16V	'01-'08	3,5/5	●	●			●			●	2	Getr.Öl EP Synth 75W-90	-			↔	↔	6,5-7		
Berlingo 1.6i (66kW), 1.6i (80kW), 1.6 VTI	'08-	3,3	HighTronic J 5W-30									1,8	Getr.Öl EP Synth 75W-90	-			↔	↔	5,9	
Berlingo 1.6i (72kW)	'08-	4,2	HighTronic J 5W-30									1,8	Getr.Öl EP Synth 75W-90	-			↔	↔	5,7	
Jumpy, Dispatch 2.0i 16V	'07-	5	HighTronic J 5W-30									1,8	Getr.Öl EP Synth 75W-90	-			↔	↔	-	
Nemo Multispace 1.4i	'09-	3,8	HighTronic J 5W-30									2,1	Getr.Öl EP Synth 75W-90	-			↔	↔	2,3	
<b>Diesel</b>																				
AX 14 D	'88-'93	3,8-4,8							●		2	Getr.Öl EP Synth 75W-90	-				↔	↔	5-6	
AX 14 D, 15 D	'94-'96	3,8-4,8		●					●		2	Getr.Öl EP Synth 75W-90	-				↔	↔	5-6	
C1 1.4 HDi	'05-'09	3,8	●	●					●		1,7	Spezialprodukt	-				↔	↔	4,4	
C1 1.4 HDi	'09-	3,75	HighTronic J 5W-30									1,7	Spezialprodukt	-				↔	↔	4,4
C2 1.4 HDi	'03-'08	3,8	●	●					●		2	Getr.Öl EP Synth 75W-90	-				↔	↔	5,7	
C2 1.6 HDi DPF	'08-'10	3,8	HighTronic J 5W-30									2	Getr.Öl EP Synth 75W-90	-				↔	↔	5,9
Saxo 1.5 D	'96-'99	4,8		●					●		2	Getr.Öl EP Synth 75W-90	-				↔	↔	7	
Saxo 1.5 D	'99-'03	4,5	●	●					●		2	Getr.Öl EP Synth 75W-90	-				↔	↔	7	
DS3 1.4 HDi DPF, 1.4 e-HDi DPF	'10-	3,75	HighTronic J 5W-30									2	Getr.Öl EP Synth 75W-90	-				↔	↔	-
DS3 1.6 HDi DPF (66kW)	'10-	3,75	HighTronic J 5W-30									1,9	Spezialprodukt	-				↔	↔	-
DS3 1.6 HDi DPF (82kW)	'10-	3,75	HighTronic J 5W-30									2,1	Getr.Öl EP Synth 75W-90	-				↔	↔	-
C3 1.4 HDi 16V, 1.6 HDi 16V	'01-'09	3,8	●	●					●		1,8	Getr.Öl EP Synth 75W-90	-				↔	↔	5,7	
C3 1.4 HDi, 1.4 e-HDi, 1.6 HDi, 1.6 e-HDi	'09-	3,8	HighTronic J 5W-30									1,8-2	Getr.Öl EP Synth 75W-90	-				↔	↔	-
C3 1.6 HDi DPF, 1.6 e-HDi DPF	'09-	3,75	HighTronic J 5W-30									2,1	Getr.Öl EP Synth 75W-90	-				↔	↔	-
C3 Picasso 1.6 HDi, 1.6 e-HDi	'09-	3,8	HighTronic J 5W-30									1,8	Spezialprodukt	Spezialprodukt		g		↔	↔	6,8
C3 Picasso 1.6 HDi DPF	'09-	3,8	HighTronic J 5W-30									2,1	Getr.Öl EP Synth 75W-90	-				↔	↔	6,8
ZX 1.9 D	'92-'93	4-4,25								●	1,9	Getr.Öl EP Synth 75W-90	Getr.Öl ATF E-S	Getriebeöl ATF 55				↔	↔	8,5
ZX 1.9 D, Turbo D	'94-'98	4,5-5		●					●		1,8	Getr.Öl EP Synth 75W-90	Getr.Öl ATF E-S	Getriebeöl ATF 55				↔	↔	8,5
Xsara, Picasso 1.5 D, 1.9 D, Turbo D	'97-'99	4,3-4,8		●					●		1,8-2	Getr.Öl EP Synth 75W-90	-				↔	↔	6,5-9,5	
Xsara, Picasso 1.5 D, 1.9 D, 2.0 HDi	'00-'06	4,3-4,8	●	●					●		1,8-2	Getr.Öl EP Synth 75W-90	-				↔	↔	6-9,5	
Xsara 1.4 HDi	'02-'05	3,8	●	●					●		2	Getr.Öl EP Synth 75W-90	-				↔	↔	6,5	
Xsara Picasso 1.6 HDi	'04-'09	3,8	●	●					●		1,8	Getr.Öl EP Synth 75W-90	-				↔	↔	11	
Xsara Picasso 1.6 HDi	'09-	3,8	HighTronic J 5W-30									1,8	Getr.Öl EP Synth 75W-90	-				↔	↔	11
Xsara Picasso 1.6 HDi DPF	'06-'09	3,8	●	●					●		1,8	Getr.Öl EP Synth 75W-90	-				↔	↔	11	
Xsara Picasso 1.6 HDi DPF	'09-	3,8	HighTronic J 5W-30									1,8	Getr.Öl EP Synth 75W-90	-				↔	↔	11
C4 1.6 HDi 16V	'04-'07	3,8	●	●					●		1,8/-	Getr.Öl EP Synth 75W-90	-				↔	↔	6,5/8,5	



C4 1.6 HDi DPF 16V	'05-'09	3,8	●	●			●	●	1,8-2	Getr.Öl EP Synth 75W-90	-				↔	↔		6,5		
C4 1.6 HDi DPF 16V	'09-'10	3,8	HighTronic J 5W-30							1,8-2	Getr.Öl EP Synth 75W-90	-				↔	↔		6,5	
C4 2.0 HDi DPF 16V	'04-'09	5,25	●	●			●	●	1,8	Getr.Öl EP Synth 75W-90	-	Getriebeöl ATF J			↔	↔		8,5		
C4 2.0 HDi DPF 16V	'09-'10	5,25	HighTronic J 5W-30							1,8	Getr.Öl EP Synth 75W-90	-	Getriebeöl ATF J			↔	↔		8,5	
C4 / DS4 1.6 HDi (66 kW), 2.0 HDi	'10-	3,75	HighTronic J 5W-30							1,8	Spezialprodukt	-				↔	↔		-	
C4 / DS4 1.6 HDi (82 kW), 1.6 e-HDi (82 kW)	'10-	3,75	HighTronic J 5W-30							2,1	Getr.Öl EP Synth 75W-90	Spezialprodukt			g	↔	↔		-	
C4 Aircross 1.6 HDi DPF, 1.8 HDi DPF, 4x4	'12-	3,75-5,3	HighTronic J 5W-30							-	Getr.Öl EP Synth 75W-90	h	-			0,5	Getriebeöl Hyp 80W		-	
(Grand) C4 Picasso 1.6 HDi DPF	'07-'09	3,8	●	●			●	●	1,8	Getr.Öl EP Synth 75W-90	-	Getriebeöl ATF J			↔	↔		6,4-9		
(Grand) C4 Picasso 1.6 HDi DPF	'09-	3,8	HighTronic J 5W-30							1,8	Getr.Öl EP Synth 75W-90	-	Getriebeöl ATF J			↔	↔		6,4-9	
(Grand) C4 Picasso 2.0 HDi DPF	'07-'09	5,25	●	●			●	●	1,8	Getr.Öl EP Synth 75W-90	-	Getriebeöl ATF J			↔	↔		8-9		
(Grand) C4 Picasso 2.0 HDi DPF	'09-	5,25	HighTronic J 5W-30							1,8	Getr.Öl EP Synth 75W-90	-	Getriebeöl ATF J			↔	↔		8-9	
Xantia 1.9 D, SD, TD, 2.1 TD	'93-'99	4,8-5	●	●			●	●	1,8	Getr.Öl EP Synth 75W-90	Getr.Öl ATF E-S	Getriebeöl ATF 55			↔	↔		7-9		
Xantia 1.9 SD, TD, 2.0 HDi	'00-'01	4,3-5	●	●			●	●	1,8	Getr.Öl EP Synth 75W-90	-				↔	↔		8-8,5		
C5 1.6 HDi DPF 16V	'04-'09	3,8	HighTronic J 5W-30							1,8	Getr.Öl EP Synth 75W-90	-				↔	↔		-	
C5 1.6 HDi DPF, 1.6 e-HDi DPF	'08-	3,75	HighTronic J 5W-30							1,9-2,1	Getr.Öl EP Synth 75W-90	g	Spezialprodukt			k	↔	↔		-
C5 2.0 HDi (66 kW)	'01-'05	4,5-4,8	●	●			●	●	1,8	Getr.Öl EP Synth 75W-90	-				↔	↔		8,5		
C5 2.0 HDi (80 kW)	'01-'05	4,5-4,8	●	●			●	●	1,8	Getr.Öl EP Synth 75W-90	Spezialprodukt				↔	↔		11		
C5 2.0 HDi DPF (80 kW, 100 kW, 120 kW) Euro4	'05-'09	4,5-5	●	●			●	●	-	Getr.Öl EP Synth 75W-90	-	Getriebeöl ATF J			↔	↔		10,7-11,7		
C5 2.0 HDi DPF (100 kW, 120 kW, 125 kW) Euro4	'09-	4,5-5,25	HighTronic J 5W-30							1,9-2,1	Getr.Öl EP Synth 75W-90	g	Spezialprodukt	Getriebeöl ATF J	k	↔	↔		-	
C5 2.0 HDi DPF (80 kW, 100 kW, 120 kW) Euro5	'05-'09	4,5-5	●	●			●	●	-	Getr.Öl EP Synth 75W-90	Spezialprodukt				↔	↔		10,7-11,7		
C5 2.0 HDi DPF (100 kW, 120 kW, 125 kW) Euro5	'09-	4,5-5,25	HighTronic J 5W-30							1,9-2,1	Getr.Öl EP Synth 75W-90	g	Spezialprodukt	Getriebeöl ATF J	k	↔	↔		-	
C5 2.2 HDi 16V	'00-'05	4,8	HighTronic J 5W-30							1,8	Getr.Öl EP Synth 75W-90	Spezialprodukt				↔	↔		11	
C5 2.2 HDi DPF 16V	'06-'09	4,75	●	●			●	●	-	Getr.Öl EP Synth 75W-90	-	Getriebeöl ATF J			↔	↔		11		
C5 2.2 HDi DPF	'09-	4,9-5,25	HighTronic J 5W-30							1,9	Getr.Öl EP Synth 75W-90	Spezialprodukt				↔	↔		10,8-11,8	
C5 2.7 HDi DPF 16V, 3.0 V6 HDi DPF	'08-'10	5,3-5,75	HighTronic J 5W-30							-	-	-	Getriebeöl ATF J			↔	↔		11	
XM 2.1 D	'89-'96	5,5/5,8					●	●	1,9	Getr.Öl EP Synth 75W-90	-				↔	↔		9,8		
XM 2.1 Turbo D	'89-'01	4/4,3		●			●	●	1,9	Getr.Öl EP Synth 75W-90	Getr.Öl ATF E-S	Getriebeöl ATF 55	d	↔	↔		10			
XM 2.5 Turbo D	'95-'01	8		●			●	●	2,2	Getr.Öl EP Synth 75W-90	-				↔	↔		13		
DS5 1.6 HDi	'11-	3,75	HighTronic J 5W-30							2,1	Getr.Öl EP Synth 75W-90	g	-				↔	↔		-
DS5 2.0 HDi	'11-	5-5,5	HighTronic J 5W-30							1,9-2,9	Spezialprodukt	-				↔	↔		-	
DS5 2.0 HDi HYbrid 4	'11-	5-5,5	HighTronic J 5W-30							2,1	Getr.Öl EP Synth 75W-90	g	-			0,7	Getr.Öl EP Synth 75W-90		-	
C6 2.2, 2.7 V6 HDi DPF	'06-'09	5,3-5,8	●	●			●	●	1,9	Getr.Öl EP Synth 75W-90	-	Getriebeöl ATF J			↔	↔		10,7-13,2		
C6 2.2, 2.7 V6 HDi DPF	'09-'11	5,3-5,8	HighTronic J 5W-30							1,9	Getr.Öl EP Synth 75W-90	-	Getriebeöl ATF J			↔	↔		10,7-13,2	
C6 3.0 V6 HDi DPF	'09-	6,25-6,5	HighTronic J 5W-30							-	-	Spezialprodukt				↔	↔		-	
Evasion, Synergie 1.9, 2.1 TD	'95-'00	4,3-4,8		●			●	●	1,8	Getr.Öl EP Synth 75W-90	-				↔	↔		8		
Evasion, Synergie 2.0 HDi	'99-'02	4,3-4,8	●	●			●	●	1,8	Getr.Öl EP Synth 75W-90	-				↔	↔		8		
C8 2.0, 2.2 HDi 16V DPF	'02-'06	4,75	●	●			●	●	2	Getr.Öl EP Synth 75W-90	Spezialprodukt				↔	↔		10-10,2		
C8 2.0, 2.2 HDi 16V DPF	'06-'09	4,8	●	●			●	●	2	Getr.Öl EP Synth 75W-90	-	Getriebeöl ATF J			↔	↔		10-11,3		
C8 2.0 HDi (100kW), 2.2 HDi 16V DPF (125kW)	'09-	4,75	HighTronic J 5W-30							1,9	Getr.Öl EP Synth 75W-90	Spezialprodukt				↔	↔		10-11,3	
C8 2.0 HDi 16V DPF (120 kW)	'11-	5-5,5	HighTronic J 5W-30							1,9	Getr.Öl EP Synth 75W-90	Spezialprodukt				↔	↔		11,3	
C-Crosser 2.2 HDi DPF	'07-'09	5,5	●	●			●	●	2	Getr.Öl EP Synth 75W-90	e	-			0,5	Getr.Öl HYP LS 85W-90		8		
C-Crosser 2.2 HDi DPF	'09-	4,9-5,25	HighTronic J 5W-30							2	Getr.Öl EP Synth 75W-90	l	Spezialprodukt	0,5	Getriebeöl BS 75W-90				8	
Berlingo 1.6 HDi	'05-'08	3,8	HighTronic J 5W-30							1,8	Getr.Öl EP Synth 75W-90	-				↔	↔		11	
Berlingo 1.6 HDi DPF (55kW)	'08-	3,8	HighTronic J 5W-30							1,8	Getr.Öl EP Synth 75W-90	-				↔	↔		6,3	
Berlingo 1.6 HDi DPF (66kW, 80kW)	'08-	3,8	HighTronic J 5W-30							1,8	Getr.Öl EP Synth 75W-90	-				↔	↔		6,3	
Berlingo 1.9 D	'96-'98	4-4,3		●			●	●	1,8	Getr.Öl EP Synth 75W-90	-				↔	↔		8		
Berlingo 1.9 D	'99-'05	4,8	●	●			●	●	1,8	Getr.Öl EP Synth 75W-90	-				↔	↔		8		
Berlingo 2.0 HDi	'98-'05	4,3	●	●			●	●	1,8	Getr.Öl EP Synth 75W-90	-				↔	↔		7		
Jumpy, Dispatch 1.6 HDi, 2.0 HDi	'07-	5-6,1	HighTronic J 5W-30							1,8	Getr.Öl EP Synth 75W-90	-				↔	↔		10,2	
Jumpy, Dispatch 2.0 HDi DPF (88kW, 103kW)	'07-	5	HighTronic J 5W-30							1,9	Getr.Öl EP Synth 75W-90	-				↔	↔		-	
Jumper, Relay 2.2 HDi (74kW, 88kW), 3.0 HDi	'07-	6-7	HighTronic J 5W-30							2,7-2,9	Getr.Öl EP Synth 75W-90	-				↔	↔		11,1-12	
Nemo Multispace 1.3 Hdi	'10-	3,2	HighTronic J 5W-30							2	Getr.Öl EP Synth 75W-90	Spezialprodukt			g	↔	↔		7,6	
Nemo Multispace 1.4 Hdi	'09-	3,8	HighTronic J 5W-30							2,1	Getr.Öl EP Synth 75W-90	-				↔	↔		7,4	

a Verteilergetriebe (BX 4x4): 1,8 l Getr.Öl HYP LS 85W-90

c Differential, hinten (BX 4x4): 1,7 l Getr.Öl BS-LSX 75W-140, Getr.Öl HYP LS 85W-90

e Verteilergetriebe: Getr.Öl BS-LSX 75W-140, Getr.Öl HYP LS 85W-90

g Hydraulisch betätigtes Automatikgetriebe MCP: Spezialprodukt, bitte auf Originalersatzteil des Herstellers zurückgreifen!

k Automatikgetriebe AL4: Spezialprodukt, bitte auf Originalersatzteil des Herstellers zurückgreifen!

b Differential, hinten (AX 4x4): 0,8 l Getriebeöl BS 75W-90; Getriebeöl HYP Synth 75W-90

d Automatikgetriebe Typ: MB3, ZF 4HP14 oder ZF 4HP18; Getr.Öl ATF E-S; Getriebeöl ATF 55

f Stufenloses Getriebe CVT: Spezialprodukt, bitte auf Originalersatzteil des Herstellers zurückgreifen!

h Verteilergetriebe: Getriebeöl Hyp 80W

l Verteilergetriebe: Getriebeöl BS 75W-90; Getriebeöl HYP Synth 75W-90

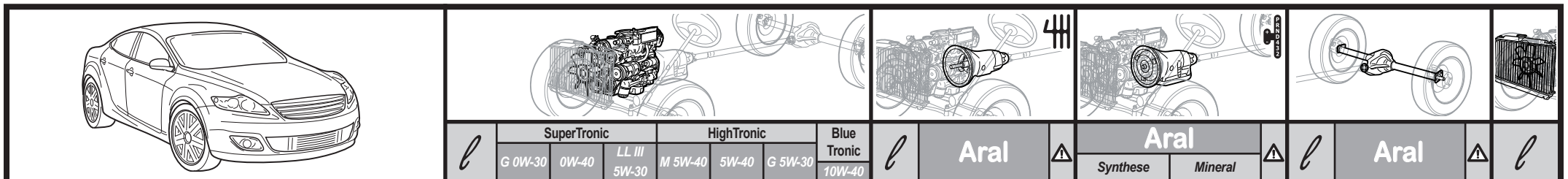

			SuperTronic			HighTronic			Blue Tronic 10W-40	Aral	⚠	Aral		⚠	Aral	⚠	
			G 0W-30	0W-40	LL III 5W-30	M 5W-40	5W-40	G 5W-30				Synthese	Mineral				
<b>DACIA</b>																	
1210, 1310, 1410, 1610, Denem	'77-'04	3,3				●			●	2	Getriebeöl Hyp 80W	-			↔	↔	5
Shifter	'84-'98	3,3				●			●	2	Getriebeöl Hyp 80W	-			↔	↔	5/5,5
Duster, 4x4	'84-'98	3,3				●			●	1,4	Getriebeöl BS 75W-90	a		0,8/1,4	Getriebeöl BS 75W-90	b	7/7,5
Duster 1.6, 1.6 16V	'10-	4,8				●				2,5	Getr.Öl EP Synth 75W-90	-		↔	↔	-	
Solenza 1.4	'03-'05	4				●			●	3,1	Getriebeöl BS 75W-90	-		↔	↔	6,5	
Logan 1.0 16V, 1.2 16V	'04-	4				●				2,8	Getr.Öl EP Synth 75W-90	-		↔	↔	4,5-5,5	
Logan 1.4, 1.6	'04-	3,3				●				2,5-2,8	Getr.Öl EP Synth 75W-90	-		↔	↔	4,5-5,5	
Logan 1.6 16V	'06-	-				●				2,5-2,8	Getr.Öl EP Synth 75W-90	-		↔	↔	4,5-5,5	
Sandero 1.0 16V	'09-	4				●				2,8	Getr.Öl EP Synth 75W-90	-		↔	↔	4,5-5,5	
Sandero 1.4, 1.6	'08-	3,3				●				2,8	Getr.Öl EP Synth 75W-90	-		↔	↔	4,5	
Sandero 1.6 16V	'08-	4,8				●				2,8	Getr.Öl EP Synth 75W-90	-		↔	↔	4,5-5,5	
<b>Diesel</b>																	
Duster Diesel 4x4	'84-'98	5,5					●		●	1,4	Getriebeöl BS 75W-90	a		0,8/1,4	Getriebeöl BS 75W-90	b	7
Duster 1.5 dCi	'10-	4,5					●			2,5	Getr.Öl EP Synth 75W-90	-		↔	↔	-	
Duster 1.5 dCi DPF	'10-	4,5					●			2,5	Getr.Öl EP Synth 75W-90	-		↔	↔	-	
Solenza 1.9 D	'03-'05	5					●		●	3,1	Getriebeöl BS 75W-90	-		↔	↔	7,4	
Logan 1.5 dCi	'06-	4,5					●			2,5-2,8	Getr.Öl EP Synth 75W-90	-		↔	↔	4,5-5,5	
Sandero 1.5 dCi	'09-	4,5					●			2,8	Getr.Öl EP Synth 75W-90	-		↔	↔	5,7	

a Verteilergetriebe: 0,8 l Getriebeöl BS 75W-90; Getriebeöl HYP Synth 75W-90

b Differentiale, vorn und hinten

**DAEWOO = CHEVROLET (EU)****DAIHATSU**

Cuore, Mira, Domino, 850, Move	'85-'99	2,9		●		●			●	1,4/1,6	Getriebeöl SNS 75W-80	Getr.Öl ATF E-S	Getriebeöl ATF 55		↔	↔	3/3,5		
Cuore, Move	'99-'06	2,3		●		●			●	1,6	Getr.Öl SNS-A 75W-85	Getr.Öl ATF E-S	Getriebeöl ATF 55		↔	↔	3		
Cuore / Mira 1.0 12V, AWD	'07-	2,9	●	●		●				2,3	Getr.Öl EP Synth 75W-90	Spezialprodukt	Getriebeöl ATF 55	g	0,8 l	Getriebeöl BS 75W-90	d	2,8-3,1	
Trevis 1.0 12V	'06-'09	2,3		●		●				2,3	Getr.Öl SNS-A 75W-85	Getr.Öl ATF E-S	Getriebeöl ATF 55		↔	↔	3,4		
Sirion	'98-'05	2,3		●		●			●	2,3	Getr.Öl EP Synth 75W-90	Getr.Öl ATF E-S	Getriebeöl ATF 55		↔	↔	3		
Sirion 2	'05-'10	3,6		●		●				2,3	Getr.Öl SNS-A 75W-85	Getr.Öl ATF E-S	Getriebeöl ATF 55		↔	↔	3,3-3,5		
Charade 1.0, 1.3, 1.6	'93-'00	3-3,5		●		●			●	2,3	Getriebeöl SNS 75W-80	Getr.Öl ATF E-S	Getriebeöl ATF 55		↔	↔	4,5		
Charade 1.3 16V VVT-i	'11-	3,4	●	●		●				2,4	Getr.Öl EP Synth 75W-90	Getr.Öl SNS-B 75W-80	Getriebeöl ATF 55		↔	↔	4,1-4,9		
YRV 1.0 12V	'00-'07	2,3		●		●			●	2,3	Getr.Öl SNS-A 75W-85	Getr.Öl ATF E-S	Getriebeöl ATF 55		↔	↔	4,1		
YRV 1.3 16V	'00-'07	3,6		●		●			●	2,3	Getr.Öl SNS-A 75W-85	Getr.Öl ATF E-S	Getriebeöl ATF 55		↔	↔	4,1		
YRV 1.3 16V Turbo	'00-'07	3,6		●		●			●	2,3	Getr.Öl SNS-A 75W-85	Getr.Öl ATF E-S	Getriebeöl ATF 55		↔	↔	4,1		
Gran Move	'97-'03	3,5		●		●			●	2,2	Getr.Öl SNS-A 75W-85	-	Getriebeöl ATF 55		↔	↔	4,5		
Valéra 1.5	'94-'01	3,5		●		●			●	2,2	Getr.Öl SNS-A 75W-85	Getr.Öl ATF E-S	Getriebeöl ATF 55		↔	↔	5-5,5		
Applause, 4WD	'89-'97	3,5/3,6		●		●			●	2,2	Getriebeöl SNS 75W-80	a	Getr.Öl ATF E-S	Getriebeöl ATF 55		↔	↔	de	5/5,5
Applause 1.6 16V	'97-'01	3,2		●		●			●	2,2	Getr.Öl SNS-A 75W-85	Getr.Öl ATF E-S	Getriebeöl ATF 55		↔	↔	5-5,5		
Materia 1.3 16V, 1.5 16V, 4x4	'06-'11	3,1	●	●		●				2,2	Getr.Öl SNS-A 75W-85	b	Getr.Öl ATF E-S	Getriebeöl ATF 55	b	↔	↔	e	4,2/4,4
Copen	'03-	2,7		●		●				2,2	Getr.Öl SNS-A 75W-85	-	Getriebeöl ATF 55		↔	↔	3,8		
Feroza, Sportrack (F300)	'88-'00	3,5		●		●			●	1,7	Getriebeöl SNS 75W-80	c	-	Getriebeöl ATF 55		0,9/2	Getriebeöl BS 75W-90	f	5,5
Terios 1.3 16V	'97-'06	3,6		●		●			●	2,2	Getr.Öl SNS-A 75W-85	Getr.Öl ATF E-S	Getriebeöl ATF 55		0,7/1,6	Getriebeöl BS 75W-90	bf	5,5	
Terios 1.3 16V, 1.5 16V, 4x4	'06-	3,2-3,5	●	●		●				2,2	Getr.Öl SNS-A 75W-85	Getr.Öl ATF E-S	Getriebeöl ATF 55	b	0,4/1,8	Getriebeöl BS 75W-90	f	4,2-4,6	
Rocky 4WD, Fourtrak (F80, F85)	'85-'98	4,6		●		●			●	2/2,7	Getriebeöl SNS 75W-80	c	-	Getriebeöl ATF 55		1,5	Getriebeöl BS 75W-90	f	7-8
<b>Diesel</b>																			
Rocky 4WD, Fourtrak Diesel (F70, F75)	'84-'98	5,5					●		●	2/2,7	Getriebeöl SNS 75W-80	c	-	Getriebeöl ATF 55		1,5	Getriebeöl BS 75W-90	f	10

Rocky 4WD, Fourtrak Turbo D (F75)	'85-'98	5,5				●		●	2/2,7	Getriebeöl SNS 75W-80	c	-	1,5	Getriebeöl BS 75W-90	f	10
a	Verteilergetriebe: 0,3/1,4   Getriebeöl BS 75W-90; Getriebeöl SNA-C 75W-90							b								
c	Verteilergetriebe: 1,4   Getriebeöl SNS 75W-80							d								
e	Differential, hinten (4WD/4x4): 0,6-1,2   Getriebeöl BS 75W-90; Getriebeöl SNA-C 75W-90							f								
g	Verteilergetriebe Getriebeöl BS 75W-90; Getriebeöl SNA-C 75W-90							f								

### DAIMLER

Six 4.0	'94-'97	8			●		●		1,4	Getr.Öl ATF E-S		Getr.Öl ATF E-S	Getriebeöl ATF 55	2,1	Getr.Öl HYP LS 85W-90	12
V8 4.0	'97-'01	6,5-7,5			●		●		-	-		Spezialprodukt		1,6	Getr.Öl HYP LS 85W-90	10
V8 4.0 Compressor	'97-'01	6,5-7,5			●		●		-	-		Spezialprodukt		1,6	Getr.Öl HYP LS 85W-90	12
Double Six 6.0	'93-'97	10			●		●		-	-		Getr.Öl ATF E-S	Getriebeöl ATF 55	1,6	Getr.Öl HYP LS 85W-90	20
Super Eight 4.2 SC	'05-'09	6			●		●		-	-		Spezialprodukt		1,3	Getr.Öl BS LSX 75W-140	12,4-13,2

### DODGE

Neon 2.0 16V	'03-'05	4,3		●	●	●			2,4-2,7	Spezialprodukt		Spezialprodukt		↔	↔	6,2		
Neon 2.4 16V Turbo SRT-4	'03-'05	4,8		●	●	●			2,3-2,5	Spezialprodukt		-		↔	↔	6,2		
Dart 1.4 Turbo MultiAir	'12-	3,8					●		-	Spezialprodukt		Spezialprodukt		↔	↔	6,8		
Dart 2.0 16V VVT, 2.4 MultiAir II	'12-	4,7					●		-	Spezialprodukt			Getriebeöl ATF J	↔	↔	6,8		
Caliber 1.8, 2.0, 2.4, AWD	'06-'12	4,3	HighTronic F 5W-30						2,4-2,7	Spezialprodukt	g	Spezialprodukt		-	Getriebeöl BS 75W-90	6,8		
Caliber 2.4T SRT-4	'08-'09	4,7		●		●			-	Spezialprodukt				↔	↔	7,1		
Avenger 2.4 16V, 2.7 V6	'08-'12	4,4-5,2	HighTronic F 5W-30						-	-		Spezialprodukt		↔	↔	7,3-9,3		
Avenger 2.4 16V	'13-	4,4	HighTronic F 5W-30						-	-		Spezialprodukt		↔	↔	7,3		
Avenger 3.5 V6	'08-'10	5,2	HighTronic F 5W-30						-	-		Spezialprodukt		↔	↔	11		
Avenger 3.6 V6	'11-'12	5,6	HighTronic F 5W-30						-	-		Spezialprodukt		↔	↔	11		
Avenger 3.6 V6	'13-	5,6	HighTronic F 5W-30						-	-		Spezialprodukt		↔	↔	11		
Challenger 3.5	'09-'11	5,7	HighTronic F 5W-30						-	-		Spezialprodukt		-	Getr.Öl BS LSX 75W-140	10,5		
Challenger 3.6	'11-'12	5,6	HighTronic F 5W-30						-	-		Spezialprodukt		-	Getr.Öl BS LSX 75W-140	10,5		
Challenger 3.6	'13-	5,6	HighTronic F 5W-30						-	-		Spezialprodukt		-	Getr.Öl BS LSX 75W-140	10,5		
Challenger 5.7	'09-'11	6,6	HighTronic F 5W-30						-	Spezialprodukt		Spezialprodukt		-	Getr.Öl HYP LS 85W-90	10,5		
Challenger 5.7	'11-'12	6,6	HighTronic F 5W-30						-	Spezialprodukt		Spezialprodukt		-	Getr.Öl HYP LS 85W-90	13,9		
Challenger 5.7	'13-	6,6	HighTronic F 5W-30						-	Spezialprodukt		Spezialprodukt		-	Getr.Öl HYP LS 85W-90	13,9		
Challenger 6.1 SRT8	'08-'10	6,6					●		-	Spezialprodukt		Spezialprodukt		-	Getr.Öl HYP LS 85W-90	14,4		
Challenger 6.4 SRT8	'11-'11	6,6					●		-	-		Spezialprodukt		-	Getr.Öl HYP LS 85W-90	14,4		
Challenger 6.4 SRT8	'12-'12	6,6		●			●		-	-		Spezialprodukt		-	Getr.Öl HYP LS 85W-90	14,4		
Challenger 6.4 SRT8	'13-	6,6		●			●		-	-		Spezialprodukt		-	Getr.Öl HYP LS 85W-90	14,4		
Charger, Magnum 2.7, 3.5 V6, AWD	'06-'10	5,7		●			●		-	-		Spezialprodukt		b	1,4-1,6	Getr.Öl BS LSX 75W-140	a	10-10,5
Charger 3.6	'11-'12	5,6	HighTronic F 5W-30						-	-		Spezialprodukt		-	Getr.Öl BS LSX 75W-140	9,5		
Charger 3.6	'13-	5,6	HighTronic F 5W-30						-	-		Spezialprodukt		-	Getr.Öl BS LSX 75W-140	9,5		
Charger, Magnum 5.7 V8, AWD	'04-'08	6,6					●	●	-	-		Spezialprodukt		b	1,4-1,6	Getr.Öl BS LSX 75W-140	a	10,5
Charger 5.7	'08-'10	6,6	HighTronic F 5W-30						-	-		Spezialprodukt		-	Getr.Öl BS LSX 75W-140	13,9-14,3		
Charger 5.7, AWD	'11-'12	6,6	HighTronic F 5W-30						-	-		Spezialprodukt		h	-	Getr.Öl BS LSX 75W-140	k	13,9-14,3
Charger 5.7, AWD	'13-	6,6	HighTronic F 5W-30						-	-		Spezialprodukt		h	-	Getr.Öl BS LSX 75W-140	k	13,9-14,3
Charger, Magnum 6.1 V8 SRT-8	'05-'10	6,6	●				●		-	-		Spezialprodukt		1,4-1,6	Getr.Öl BS LSX 75W-140	14		
Charger 6.4 SRT-8	'12-'12	6,6		●			●		-	-		Spezialprodukt		-	Getr.Öl HYP LS 85W-90	14,4		
Charger 6.4 SRT-8	'13-	6,6		●			●		-	-		Spezialprodukt		-	Getr.Öl HYP LS 85W-90	14,4		
Nitro 3.7 V6, AWD	'06-'10	4,7	●	●			●		1,5	Getr.Öl SNS-B 75W-80	d	Spezialprodukt		d	2,1	Getr.Öl BS LSX 75W-140	c	13,2
Nitro 3.7 V6, AWD	'11-'12	4,7	HighTronic F 5W-30						-	-		Spezialprodukt		d	-	Getriebeöl BS 75W-90	l	13,3
Nitro R/T 4.0 V6, AWD	'08-'10	5,2	HighTronic F 5W-30						-	-		Spezialprodukt		d	-	Getr.Öl BS LSX 75W-140	l	13,3
Nitro R/T 4.0 V6, AWD	'11-'12	5,2	HighTronic F 5W-30						-	-		Spezialprodukt		d	-	Getriebeöl BS 75W-90	l	13,3
Journey 2.4 16V	'09-'12	4,3	HighTronic F 5W-30						-	-		Spezialprodukt		↔	↔	7,5-11		
Journey 2.4 16V	'13-	4,3	HighTronic F 5W-30						-	-		Spezialprodukt		↔	↔	10,1-11		
Journey 2.7 V6, 3.5 V6, AWD	'07-'10	5,2	HighTronic F 5W-30						-	-		Spezialprodukt		f	-	Getriebeöl BS 75W-90	9,3-11	
Journey 3.6 V6, AWD	'11-'12	5,6	HighTronic F 5W-30						-	-		Spezialprodukt		f	-	Getriebeöl BS 75W-90	9,3-13,7	
Journey 3.6 V6 AWD	'13-	5,6	HighTronic F 5W-30						-	-		Spezialprodukt		f	-	Getriebeöl BS 75W-90	12,4-13,7	
Grand Caravan 3.3, 3.8	'04-'10	4,7	HighTronic F 5W-30						-	-		Spezialprodukt		↔	↔	12,6-15,4		
Grand Caravan 3.6	'11-'12	5,6	HighTronic F 5W-30						-	-		Spezialprodukt		↔	↔	12,6-15,4		
Grand Caravan 3.6	'13-	5,6	HighTronic F 5W-30						-	-		Spezialprodukt		↔	↔	12,6-15,4		
Grand Caravan 4.0	'08-'10	4,7	HighTronic F 5W-30						-	-		Spezialprodukt		↔	↔	12,6-15,4		

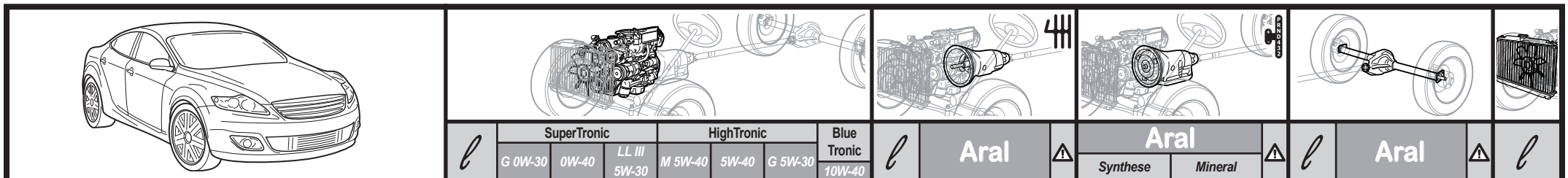
**DODGE**

			SuperTronic			HighTronic			Blue Tronic	ℓ	Aral	⚠	Aral		⚠	ℓ	Aral	⚠	ℓ
			G 0W-30	0W-40	LL III 5W-30	M 5W-40	5W-40	G 5W-30	10W-40				Synthese	Mineral					
Durango, Dakota 3.7 V6, 4x4	'04-'09	4,7	●	●		●			-	Spezialprodukt	d	Spezialprodukt		d	1,7/2,1	Getr.Öl BS LSX 75W-140	e	15,4	
Durango, Dakota 4.7, 5.7 V8, 4x4	'04-'09	5,6	●	●		●			2,2	Spezialprodukt	d	Spezialprodukt		d	1,7/2,1	Getr.Öl BS LSX 75W-140	e	15,4	
Durango 3.6 V6, AWD	'11-'12	5,6							-			Spezialprodukt		m	-	Getr.Öl BS LSX 75W-140	e	9,9	
Durango 3.6 V6, AWD	'13-	5,6							-			Spezialprodukt		m	-	Getr.Öl BS LSX 75W-140	e	9,9	
Durango 5.7 V8, AWD	'11-'12	6,6							-			Spezialprodukt		d	-	Getr.Öl BS LSX 75W-140	e	14,6-15,2	
Durango 5.7 V8, AWD	'13-	6,6							-			Spezialprodukt		d	-	Getr.Öl BS LSX 75W-140	e	14,6-15,2	
Ram 1500 3.6 V6, 4x4	'13-	5,6							-			Spezialprodukt		dr	-	Getr.Öl BS LSX 75W-140	ao	13	
Ram 1500 3.7 V6	'02-'04	4,7							-	Spezialprodukt	n	Spezialprodukt			-	Getr.Öl BS LSX 75W-140	o	16	
Ram 1500 3.7 V6	'05-'07	4,7							-	Spezialprodukt		Spezialprodukt			-	Getr.Öl BS LSX 75W-140	o	16	
Ram 1500 3.7 V6, 4x4	'08-'12	4,7							-	Spezialprodukt	dpr	Spezialprodukt		dpr	-	Getr.Öl BS LSX 75W-140	ao	13-16	
Ram 1500 4.7 V8, 4x4	'02-'05	5,7							-	Getr.Öl SNS-A 75W-85	dn	Spezialprodukt		d	-	Getr.Öl BS LSX 75W-140	ao	16	
Ram 1500 4.7 V8, 4x4	'06-'07	5,7							-	Spezialprodukt	dp	Spezialprodukt		dp	-	Getr.Öl BS LSX 75W-140	ao	16	
Ram 1500 4.7 V8, 4x4	'08-'13	5,7							-	Spezialprodukt	dpr	Spezialprodukt		dpr	-	Getr.Öl BS LSX 75W-140	ao	13-16	
Ram 1500 4.7 V8, 4x4	'13-	5,6							-			Spezialprodukt		dr	-	Getr.Öl BS LSX 75W-140	ao	13	
Ram 1500 5.7 V8, 4x4	'03-'04	6,6							-	Getr.Öl SNS-A 75W-85	dn	Spezialprodukt		d	-	Getr.Öl BS LSX 75W-140	ao	17,7	
Ram 1500 5.7 V8, 4x4	'05-'13	6,6							-	Spezialprodukt	dpr	Spezialprodukt		dpr	-	Getr.Öl BS LSX 75W-140	ao	15-17,7	
Ram 1500 5.7 V8, 4x4	'13-	6,6							-			Spezialprodukt		dr	-	Getr.Öl BS LSX 75W-140	ao	15	
Ram SRT-10 8.3 V10	'04-'04	8		●		●			-	Getriebeöl BS 75W-90					-	Spezialprodukt		19	
Ram SRT-10 8.3 V10	'05-'06	8-9,5		●		●			-	Getriebeöl BS 75W-90		Spezialprodukt			-	Spezialprodukt		19	
Viper SRT-10	'03-'10	10,4	●	●		●			-	Getriebeöl BS 75W-90					1,35	Getr.Öl BS LSX 75W-140		-	
SRT Viper 8.4 V10	'13-	10,4		●		●			-	Spezialprodukt					1,4	Getr.Öl BS LSX 75W-140		15	
<b>Diesel</b>																			
Caliber 2.0 CRD	'06-'10	4,3			●				2	Spezialprodukt					↔	↔		8	
Magnum 3.0 CRD	'05-'08	8,5		●	●		●		-			Spezialprodukt			1,4-1,6	Getr.Öl BS LSX 75W-140		10,5	
Nitro 2.8 CRD	'07-'10	6,6		●	●		●		1,5	Getr.Öl SNS-B 75W-80	d	Spezialprodukt		d	1-2,25	Getriebeöl BS 75W-90	e	12	
Nitro 2.8 CRD DPF	'07-'10	6,6		●	●		●		1,5	Getr.Öl SNS-B 75W-80	d	Spezialprodukt		d	1-2,25	Getriebeöl BS 75W-90	e	12	
Journey 2.0 CRD	'08-'10	4,3		●	●		●		2	Spezialprodukt		Spezialprodukt			↔	↔		8	
Ram 5.9 TD, 4x4	'06-'07	8,2		●		●		●	4,5	Getr.Öl SNS-B 75W-80	d	Spezialprodukt		d	1,6-3,6	Getriebeöl BS 75W-90	e	28	

- a Differential, vorn (4x4): Getriebeöl BS 75W-90; Getriebeöl SNA-C 75W-90  
 c Differential, vorn (4x4): 1,2 l Getriebeöl BS 75W-90; Getriebeöl SNA-C 75W-90  
 e Differentiale, vorn und hinten  
 g Verteilergetriebe Getriebeöl BS 75W-90; Getriebeöl SNA-C 75W-90  
 k Differential, vorn: Getriebeöl BS 75W-90; Getriebeöl SNA-C 75W-90  
 m Verteilergetriebe: Getriebeöl ATF M12; Getriebeöl ATF M14  
 o Sperrdifferential: Getr.Öl BS LSX 75W-140  
 r Verteilergetriebe BW44-44: Getr.Öl ATF E-S; Getriebeöl ATF 55

- b Verteilergetriebe: 0,6 l Spezialprodukt, bitte auf Originalersatzteil des Herstellers zurückgreifen!  
 d Verteilergetriebe Spezialprodukt, bitte auf Originalersatzteil des Herstellers zurückgreifen!  
 f Verteilergetriebe Getriebeöl BS 75W-90; Getriebeöl SNA-C 75W-90  
 h Verteilergetriebe Borg Warner 44-40: Spezialprodukt, bitte auf Originalersatzteil des Herstellers zurückgreifen!  
 l Differential, vorn: Getriebeöl BS 75W-90; Getriebeöl SNA-C 75W-90  
 n Getriebe Type NV 3500 Getr.Öl SNS-B 75W-80  
 p Verteilergetriebe NVG 246 Spezialprodukt, bitte auf Originalersatzteil des Herstellers zurückgreifen!

**FERRARI**

F355, 360	'94-'05	10		●		●		●	3,5	Getriebeöl BS 75W-90	b	-			↔	↔		11
F430	'05-'10	10		●		●			3,5	Getriebeöl BS 75W-90					↔	↔		17,5
458 Italia	'10-	10		●		●			3,9	Getriebeöl BS 75W-90	c	-			↔	↔		16,5
California	'09-	11		●		●			3,5-4,6	Getriebeöl BS 75W-90	c	-			↔	↔		18-21
550 Maranello	'96-'02	10		●		●		●	4,5	Getr.Öl BS LSX 75W-140					↔	↔		19
575M Maranello	'02-'06	10		●		●			4,5	Getriebeöl BS 75W-90	b	-			↔	↔		19
456 GT, GTA	'92-'03	10							5	Getr.Öl BS LSX 75W-140		Getr.Öl ATF E-S	Getriebeöl ATF 55		↔	↔	a	14
599 GTB Fiorano / GTO	'06-	12,5							4,7	Getriebeöl BS 75W-90	b	-			↔	↔		19-21

612 Scaglietti	'04-	13		●		●			5	Getriebeöl BS 75W-90	b	-				↕	↕		19		
Enzo	'02-'04	11,5	Spezialprodukt, bitte auf Originalersatzteil des Herstellers zurückgreifen!						5	Getriebeöl BS 75W-90	b	-						↕	↕		19,8



a Differential, Modelle mit Automatikgetriebe: 2,3 l Getr.Öl BS LSX 75W-140

b System F1: 1 l Getr.Öl ATF E-S; Getriebeöl ATF 55

c Getriebe, Getrag 7DCL750, Kupplungsteil: Spezialprodukt, bitte auf Originalersatzteil des Herstellers zurückgreifen!

### FIAT

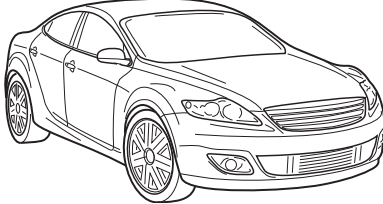
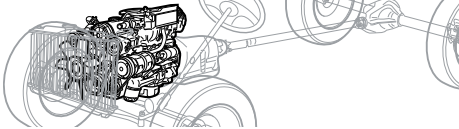
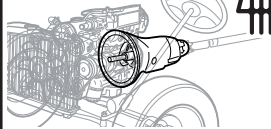
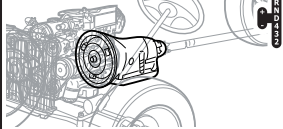
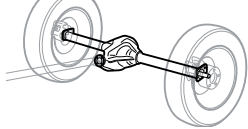
126 Bis	'87-'00	2,5			●		●		1,1	Getriebeöl EP 85W-90	-	-					↕	↕		4
Cinquecento 700	'91-'98	2,3			●		●		1,4	Getriebeöl SNS 75W-80	-	-					↕	↕		5
Cinquecento 900, 1100	'91-'98	3,8			●		●		2,4	Getriebeöl SNS 75W-80	-	-					↕	↕		4,5/5
500 0.9 TwinAir, 1.2, 1.4 16V	'07-	2,8-3,2		●		●			1,65	Getr.Öl EP Synth 75W-90	-	-					↕	↕		4,4-5,3
500 Abarth 1.4 T-Jet 16V	'08-	2,9		●		●			1,65	Getr.Öl EP Synth 75W-90	-	-					↕	↕		5,15
Seicento 900, 1100	'98-'05	3,5-3,8		●		●			2,4	Getr.Öl EP Synth 75W-90	-	-					↕	↕		4-5
Panda 750, 1000, 1100, Selecta	'86-'03	3,8			●		●		2,4	Getriebeöl EP 85W-90	Spezialprodukt						↕	↕		5
Panda 4x4	'83-'03	3,8			●		●		2,4	Getriebeöl EP 85W-90	-	-					↕	↕	a	5
Panda 1.1, 1.2, 1.4 16V	'03-'10	2,8-3,5		●					1,7	Getr.Öl EP Synth 75W-90	-	-					↕	↕		4,5-4,6
Panda 0.9 TwinAir	'11-	3,2		●			●		1,7	Spezialprodukt	-	-					↕	↕		5,3
Panda 1.2 LPG	'03-'10	2,8		●			●		1,7	Getr.Öl EP Synth 75W-90	-	-					↕	↕		4,6
Panda 1.2 4x4	'04-'10	2,8		●			●		2,7	Getr.Öl EP Synth 75W-90	-	-	0,9		Getriebeöl BS 75W-90		↕	↕		4,6
Panda 1.2 69	'10-	2,8		●			●		1,7	Getr.Öl EP Synth 75W-90	-	-					↕	↕		4,6
Panda 1.2 69 4x4	'10-	2,8		●			●		2,7	Getr.Öl EP Synth 75W-90	-	-	0,9		Spezialprodukt		↕	↕		4,6
Panda 1.2	'11-	2,8		●			●		1,7	Spezialprodukt	-	-					↕	↕		5,2
Panda 1.4 Natural Power	'10-	3,5		●			●		1,7	Getr.Öl EP Synth 75W-90	-	-					↕	↕		4,6
Panda 1.4 Natural Power 4x4	'10-	3,5		●			●		2,7	Getr.Öl EP Synth 75W-90	-	-	0,9		Spezialprodukt		↕	↕		4,6
Panda 1.4 16V 100HP	'06-'09	2,9			●		●		1,7	Getr.Öl EP Synth 75W-90	-	-					↕	↕		4,5
Punto 55, 60, 75, 90, Selecta	'93-'99	3,5-3,7		●		●		●	2,4	Getriebeöl SNS 75W-80	Spezialprodukt						↕	↕		4,5/6
Punto 85 16V	'97-'99	2,8		●			●		1,7	Getriebeöl BS 75W-90	-	-					↕	↕		4,5
Punto GT	'93-'99	4		●			●		2	Getriebeöl SNS 75W-80	-	-					↕	↕		6
Punto 1.2 8V, 16V, 1.4 16V	'99-'06	2,8		●			●		1,7	Getr.Öl EP Synth 75W-90	Spezialprodukt						↕	↕		4,4-5
Punto 1.2 8V	'03-'10	2,8		●			●		1,7	Getr.Öl EP Synth 75W-90	-	-					↕	↕		4,2
Punto 1.8 16V	'99-'06	4		●			●		2	Getr.Öl EP Synth 75W-90	-	-					↕	↕		6
Palio Weekend 75, 100	'96-'04	3,7-3,8		●		●		●	2	Getriebeöl SNS 75W-80	-	-					↕	↕		6-7
Grande Punto 1.2, 1.4, 1.4 (16V)	'05-	2,6-2,9		●			●		1,5-1,7	Getr.Öl EP Synth 75W-90	-	-					↕	↕		5,3
Grande Punto 1.4 16V T-Jet	'07-'09	2,6		●			●		1,5-1,9	Getr.Öl EP Synth 75W-90	-	-					↕	↕		5,3-6
Punto Evo 1.2, 1.4, 1.4 Multi Air	'09-	2,6-3,4		●			●		1,5-1,7	Getr.Öl EP Synth 75W-90	-	-					↕	↕		5,3
Punto Evo 1.4 Turbo Multi Air	'09-	3,5		●			●		1,7	Getr.Öl EP Synth 75W-90	-	-					↕	↕		6
Linea 1.4, 1.4 16V T-jet	'07-	2,6		●			●		1,5-1,7	Getr.Öl EP Synth 75W-90	-	-					↕	↕		5,3
Bravo, Brava 1.2 16V, 1.4, 1.6, 1.8	'95-'02	3,1-4,3		●		●		●	1,7/2	Getriebeöl BS 75W-90	Getr.Öl ATF E-S Getriebeöl ATF 55						↕	↕		5,5-7
Bravo, Brava 2.0 20V	'95-'02	5		●			●		2	Getriebeöl BS 75W-90	-	-					↕	↕		7-7,5
Bravo 1.4 16V	'07-	2,9		●			●		1,9	Getr.Öl EP Synth 75W-90	-	-					↕	↕		5,2
Bravo 1.4 16V LPG	'10-	2,9		●			●		1,9	Getr.Öl EP Synth 75W-90	-	-					↕	↕		5,2
Bravo 1.4 16V T-jet (88kW/110kW)	'07-	2,9		●			●		1,9	Getr.Öl EP Synth 75W-90	-	-					↕	↕		6
Bravo 1.4 Turbo Multi Air	'10-	3,5		●			●		2	Spezialprodukt	-	-					↕	↕		6
Stilo 1.2 16V	'01-'05	2,8		●		●		●	1,9	Getr.Öl EP Synth 75W-90	-	-					↕	↕		6
Stilo 1.4 16V	'03-'07	2,8		●			●		1,7	Getr.Öl EP Synth 75W-90	-	-					↕	↕		5,3
Stilo 1.6 16V, 1.8 16V	'01-'07	3,9-4,2		●			●		2	Getr.Öl EP Synth 75W-90	-	-					↕	↕		7,5-8
Stilo 2.4 20V	'01-'07	4,7		●			●		1,8	Getr.Öl EP Synth 75W-90	b	-					↕	↕		9,5
Tempra 1.4, 1.6, Selecta	'90-'97	3,8-4,3			●		●		2	Getriebeöl SNS 75W-80	Getr.Öl ATF E-S Getriebeöl ATF 55						↕	↕		4,5/6,5
Tempra 1.8 (16V), 2.0 (16V)	'90-'97	5,2-5,8			●		●		2	Getriebeöl SNS 75W-80	Getr.Öl ATF E-S Getriebeöl ATF 55						↕	↕	c	7/7,5
Tempra S.W. 2.0 4x4	'92-'97	5,2			●		●		3,8	Getriebeöl SNS 75W-80	-	-					↕	↕	d	7
Marea 1.2, 1.4, 1.6, 1.8, 2.0 20V	'96-'03	2,8-4,5		●			●		1,7-2	Getriebeöl BS 75W-90	Getr.Öl ATF E-S Getriebeöl ATF 55						↕	↕		5,5-7,5
Croma 1.6, 2.0, 16V, Turbo	'85-'97	4,8-5,5			●		●		1,7-2	Getriebeöl SNS 75W-80	Getr.Öl ATF E-S Getriebeöl ATF 55						↕	↕		8
Croma 2.5 V6	'93-'97	7			●		●		1,9	Getriebeöl SNS 75W-80	Getr.Öl ATF E-S Getriebeöl ATF 55						↕	↕		10
Croma 1.8 16V, 2.2 16V	'05-'10	4,5-5		●			●		1,6-1,8	Getr.Öl EP Synth 75W-90	-	-				Getriebeöl ATF J	↕	↕		7,4
Barchetta 1.8 16V	'95-'05	4,1		●			●		2	Getr.Öl EP Synth 75W-90	-	-					↕	↕		6
Coupé 2.0 16V, Turbo	'93-'96	5,2		●			●		2,4	Getriebeöl SNS 75W-80	-	-					↕	↕		7-7,5
Coupé 1.8 16V, 2.0 20V, Turbo	'96-'00	3,8-4,5		●			●		2,4	Getriebeöl BS 75W-90	-	-					↕	↕		7-7,5
Idea 1.2 16V, 1.4 (16V)	'03-'05	2,6-2,8			●		●		1,7	Getr.Öl EP Synth 75W-90	-	-					↕	↕		4,6
Idea 1.2 16V, 1.4 (16V)	'05-	2,6-2,8		●			●		1,7	Getr.Öl EP Synth 75W-90	-	-					↕	↕		4,6

FIAT	Model	Year	Power (kW)	SuperTronic			HighTronic			Blue Tronic	Transmission	Aral		Oil	Oil Change Interval (km)	
				G 0W-30	0W-40	LL III 5W-30	M 5W-40	5W-40	G 5W-30	10W-40		Synthese	Mineral			
				⌘	⌘	⌘	⌘	⌘	⌘	⌘		⚠	⚠			
																
																
																
																
																
																
Idea 1.4 LPG	'05-	2,6		●				●		1,7	Getr.Öl EP Synth 75W-90	-		↔	↔	4,6
Doblò, Strada 1.2, 1.6 16V	'00-'05	2,8/3,9		●				●	●	2	Getr.Öl EP Synth 75W-90	-		↔	↔	4,2
Doblò, Strada 1.4, 1.6 16V	'05-	2,6/3,9		●				●		2	Getr.Öl EP Synth 75W-90	-		↔	↔	7,-
Qubo 1.4 8V	'09-	3		●				●		1,7	Getr.Öl EP Synth 75W-90	-		↔	↔	7,4
Qubo 1.4 8V Natural Power	'09-	3		●				●		1,7	Getr.Öl EP Synth 75W-90	-		↔	↔	7,4
Sedici 1.6 16V, 4x4	'06-'09	3,9		●			●			2,5-2,6	Getr.Öl EP Synth 75W-90	e	Getriebeöl ATF J	0,8	Getriebeöl BS 75W-90	7,7
Sedici 1.6 16V, 4x4	'09-'11	3,9		●				●		2,5	Getr.Öl EP Synth 75W-90	e	Getriebeöl ATF J	0,8	Getriebeöl BS 75W-90	6,6
Sedici 1.6 16V, 4x4	'11-	3,9		●				●		2,5	Getr.Öl SNS-B 75W-80	e	Getriebeöl ATF J	0,8	Getriebeöl BS 75W-90	6,6
Multipla 1.6 16V	'98-'01	3,8		●			●		●	2	Getriebeöl BS 75W-90	-		↔	↔	7
Multipla 1.6 16V	'01-	3,8		●					●	2	Getr.Öl EP Synth 75W-90	-		↔	↔	7
Ulysse 1.8, 2.0, 16V, Turbo	'94-	4,3-4,9		●			●		●	1,9-2,2	Getriebeöl BS 75W-90	Getr.Öl ATF E-S	Getriebeöl ATF 55	↔	↔	7-8,5
Ulysse 3.0 V6 24V	'02-'05	4,8		●			●		●	-	-	Getr.Öl ATF E-S	Getriebeöl ATF 55	↔	↔	-
<b>Diesel</b>																
500 1.3 16V Multijet	'07-	2,8								1,65	Getr.Öl EP Synth 75W-90	-		↔	↔	6,3
Panda 1.3 Multijet 16V, 16V 75	'04-'10	3							●	1,7	Getr.Öl EP Synth 75W-90	-		↔	↔	6,5
Panda 1.3 Multijet 16V, 4x4	'04-'10	3		●					●	2,7	Getr.Öl EP Synth 75W-90	-		↔	↔	f 6,5
Panda 1.3 Multijet	'10-	3								1,7	Getr.Öl EP Synth 75W-90	-		↔	↔	4,6
Panda 1.3 Multijet 4x4	'10-	3								2,7	Getr.Öl EP Synth 75W-90	-		↔	↔	4,6
Panda 1.3 Multijet	'11-	3								1,8	Spezialprodukt	-		↔	↔	6,4
Punto D, TD	'93-'97	4,8-5		●					●	2,4	Getriebeöl SNS 75W-80	-		↔	↔	7
Punto TD 60, 70	'97-'99	4,8							●	2	Getriebeöl BS 75W-90	-		↔	↔	7
Punto 1.3 Multijet 16V	'03-'06	3		●					●	2	Getr.Öl EP Synth 75W-90	-		↔	↔	6
Punto 1.9 D, JTD	'99-'03	4,3							●	2	Getr.Öl EP Synth 75W-90	-		↔	↔	6
Punto 1.9 Multijet	'03-'06	4,4		●					●	2	Getr.Öl EP Synth 75W-90	-		↔	↔	5,9-6,5
Palio Weekend TD 70	'96-'01	4,8							●	2	Getriebeöl SNS 75W-80	-		↔	↔	7
Grande Punto 1.3 Multijet 16V	'05-'09	3,2		●						1,8	Getr.Öl EP Synth 75W-90	-		↔	↔	7,3-7,4
Grande Punto 1.3 Multijet	'10-	3,2								1,7	Getr.Öl EP Synth 75W-90	-		↔	↔	7,4
Grande Punto 1.9 Multijet	'05-'09	4,2		●						2,1	Getr.Öl EP Synth 75W-90	-		↔	↔	6,3
Punto Evo 1.3 Multijet 51, 55 kW	'09-	3,2								1,7	Getr.Öl EP Synth 75W-90	-		↔	↔	6,7
Punto Evo 1.3 Multijet 62, 66, 70 kW, 1.6 Multijet	'09-	3,2-4,6								2	Getr.Öl EP Synth 75W-90	-		↔	↔	5,6-7,4
Linea 1.3 Multijet 90 + DPF	'07-	3,2		●						1,8	Getr.Öl EP Synth 75W-90	-		↔	↔	7,4
Linea 1.6 MultiJet 16V, DPF	'07-	3,2-3,9		●						2,2	Getr.Öl EP Synth 75W-90	-		↔	↔	6,3-7,4
Tipo 1.7, 1.9 D, Turbo D	'88-'96	5,6-6							●	2,2	Getriebeöl SNS 75W-80	-		↔	↔	8-9
Bravo, Brava 1.9 Diesel	'95-'99	4,9							●	2	Getriebeöl BS 75W-90	-		↔	↔	7,5
Bravo, Brava 1.9 TD 75, 100	'96-'02	4,1							●	1,7/2	Getriebeöl BS 75W-90	-		↔	↔	5,5-6
Bravo, Brava 1.9 JTD	'98-'02	4,9							●	2	Getriebeöl BS 75W-90	-		↔	↔	6,5
Bravo 1.6 Multijet 16V	'07-	4,6								1,9	Getr.Öl EP Synth 75W-90	-		↔	↔	7,1
Bravo 1.9 Multijet (8V/16V), 2.0 Multijet 16V	'07-	4,7		●						1,8-1,9	Getr.Öl EP Synth 75W-90	-		↔	↔	7
Stilo 1.9 JTD, Multijet	'01-'07	4,7		●					●	1,7	Getr.Öl EP Synth 75W-90	-		↔	↔	5,9-8,2
Stilo 1.9 JTD 16V, Multijet 16V	'04-'07	4,7		●					●	1,7-2	Getr.Öl EP Synth 75W-90	-		↔	↔	6,3
Tempra 1.9 D, Turbo D	'90-'97	5-6							●	2,2	Getriebeöl SNS 75W-80	-		↔	↔	8-9
Marea 1.9, 2.4 Turbo D, JTD	'96-'03	3,8-5,5							●	1,7/2	Getriebeöl BS 75W-90	-		↔	↔	5,5-7,5
Croma 2.0, 2.5 Turbo D	'92-'97	5-6,4							●	2	Getriebeöl SNS 75W-80	-		↔	↔	9,5
Croma 1.9 Multijet, 16V, 2.4 Multijet 20V	'05-'10	4,5-5,4		●						1,9	Getr.Öl EP Synth 75W-90	Spezialprodukt		↔	↔	7,7-8,4
Croma 1.9 Multijet, 16V, 2.4 Multijet 20V DPF	'05-'10	4,5-5,4								1,9	Getr.Öl EP Synth 75W-90	Spezialprodukt		↔	↔	7,7-8,4
Idea 1.3 JTD 16V	'03-'05	3		●					●	1,6-2	Getr.Öl EP Synth 75W-90	-		↔	↔	6
Idea 1.3 Multijet	'05-	3								2	Getr.Öl EP Synth 75W-90	b		↔	↔	6

Idea 1.6 Multijet	'08-	4,7	HighTronic C 5W-30; HighTronic J 5W-30	2	Getr.Öl EP Synth 75W-90	b	-						↔	↔				7,8
Idea 1.9 JTD	'03-'05	4,4	●	●	●	1,65	Getr.Öl EP Synth 75W-90	-					↔	↔				6
Idea 1.9 Multijet	'05-'08	4,4	HighTronic C 5W-30; HighTronic J 5W-30	1,65	Getr.Öl EP Synth 75W-90	-							↔	↔				6,5
Doblò 1.3 JTD 16V	'04-'05	3	●	●	●	2	Getr.Öl EP Synth 75W-90	-					↔	↔				6,2
Strada 1.3 JTD 16V	'07-	3	●	●	●	2	Getr.Öl EP Synth 75W-90	-					↔	↔				7,6
Doblò 1.3 Multijet 16V, 1.3 Multijet 16V DPF	'05-	3	●	●	●	2	Getr.Öl EP Synth 75W-90	-					↔	↔				6,2
Doblò 1.9 D, JTD	'00-'05	4,3-4,7	●	●	●	2	Getr.Öl EP Synth 75W-90	-					↔	↔				6,2
Strada 1.9 D, JTD	'97-'07	4,3	●	●	●	2	Getr.Öl EP Synth 75W-90	-					↔	↔				6,2
Doblò 1.9 Multijet, 1.9 Multijet DPF	'05-	4,3	●	●	●	2	Getr.Öl EP Synth 75W-90	-					↔	↔				-
Qubo 1.3 Multijet	'09-	3,2	HighTronic C 5W-30; HighTronic J 5W-30	1,8	Getr.Öl EP Synth 75W-90	-							↔	↔				7,6
Sedici 1.9 Multijet, 4x4	'06-'09	4,5	●	●	●	2,5	Getr.Öl SNS-B 75W-80	e	-				0,8	Getriebeöl BS 75W-90				6,5
Sedici 2.0 Multijet, 4x4	'09-'11	4,4	●	●	●	2,5	Getr.Öl SNS-B 75W-80	e	-				0,8	Getriebeöl BS 75W-90				6,5
Sedici 2.0 Multijet, 4x4	'11-	4,4	Spezialprodukt, bitte auf Originalersatzteil des Herstellers zurückgreifen!			2,5	Getr.Öl SNS-B 75W-80	e	-				0,8	Getriebeöl BS 75W-90				6,5
Multipia 1.9 JTD	'98-'04	4,2-4,5	●	●	●	2	Getriebeöl BS 75W-90	-					↔	↔				6,3
Multipia 1.9 JTD	'04-	4,5	●	●	●	-	Getr.Öl EP Synth 75W-90	-					↔	↔				-
Ulysse 1.9, 2.1 Turbo D, JTD, 16V	'94-'02	4,5-6	●	●	●	1,9	Getriebeöl BS 75W-90	-					↔	↔				9
Ulysse 2.0, 2.2 JTD 16V	'02-'05	4,8	●	●	●	2	Getriebeöl BS 75W-90	-					↔	↔				9,5-11,3
Ulysse 2.0 JTD 16V	'05-	5,3	●	●	●	2	Getr.Öl EP Synth 75W-90		Getr.Öl ATF E-S		Getriebeöl ATF 55		↔	↔				9,5

a Differential, hinten (Panda 4WD/4x4): 1,4 | Getr.Öl BS LSX 75W-140

c Differential, Modelle mit Automatikgetriebe: 0,7 | Getr.Öl BS 75W-90

e Verteilergetriebe: 0,6 | Getriebeöl BS 75W-90; Getriebeöl SNA-C 75W-90

b Hydraulik Bedienung Getriebe, Selespeed: 0,6 | Spezialprodukt, bitte auf Originalersatzteil des Herstellers zurückgreifen!

d Differential, hinten (Tempra 4x4): 1,1 | Getriebeöl BS 75W-90; Getriebeöl SNA-C 75W-90

f Differential, hinten (4x4): 0,8-0,9 | Getriebeöl BS 75W-90; Getriebeöl SNA-C 75W-90

## FISKER

Karma	'11-	4,7	●	●	-	-								Getriebeöl BS 75W-90				↔	↔	-
-------	------	-----	---	---	---	---	--	--	--	--	--	--	--	----------------------	--	--	--	---	---	---

## FORD (EU)

Ka 1.3	'96-'08	3,3	HighTronic F 5W-30	2,8	Getriebeöl SNS 75W-80	-								↔	↔				5,5
Ka 1.6	'03-'08	4,1	HighTronic F 5W-30	2,3	Getriebeöl SNS 75W-80	-								↔	↔				5,3
StreetKa, SportKa	'03-'08	4,1	HighTronic F 5W-30	2,3	Getriebeöl SNS 75W-80	-								↔	↔				5,3
Ka 1.2 Duratec	'08-	2,8	●	●	1,65	Spezialprodukt	-							↔	↔				4,85
Fiesta 1.0, 1.1, 1.3, 1.4	'89-'95	3,3/4,3	●	●	2,8-3,1	Getriebeöl SNS 75W-80		Getr.Öl ATF E-S						↔	↔				6-7,5
Fiesta 1.6, 1.6i 16V, Si, XR 2i 1.8i 16V	'92-'95	4,3	●	●	2,6	Getriebeöl SNS 75W-80	-							↔	↔				7
Fiesta 1.1, 1.3, 1.25, 1.4, 1.6 16V	'95-'02	3,3-4,3	HighTronic F 5W-30	2,8	Getriebeöl SNS 75W-80	-		Getr.Öl ATF E-S						↔	↔				6-7
Fiesta 1.25, 1.3, 1.4 16V, 1.6 16V	'02-'08	3,7-4,1	HighTronic F 5W-30	2,3	Getriebeöl SNS 75W-80	-								↔	↔				5
Fiesta 2.0 16V ST	'05-'08	4,3	HighTronic F 5W-30	2,3	Getriebeöl SNS 75W-80	-								↔	↔				4
Fiesta 1.25 16V, 1.4 16V, 1.4 16V LPG, 1.6 16V TI-VCT	'08-'11	3,8-4,1	EcoTronic F 5W-20; HighTronic F 5W-30	2,3	Getriebeöl SNS 75W-80	-		Spezialprodukt						↔	↔				5,5
Fiesta 1.0 EcoBoost, 1.25 16V, 1.4 16V, 1.4 16V LPG	'12-	3,8-4,1	EcoTronic F 5W-20	2,3	Getriebeöl SNS 75W-80	-		Spezialprodukt						↔	↔				5,5
Fiesta 1.6 16V TI-VCT	'12-'12	3,8-4,1	EcoTronic F 5W-20; HighTronic F 5W-30	2,3	Getriebeöl SNS 75W-80	-		Spezialprodukt						↔	↔				5,5
Fiesta ST 1.6 Ecoboost	'13-	4,05	EcoTronic F 5W-20	-	Spezialprodukt	-								↔	↔				-
Fusion 1.25 16V, 1.4 16V, LPG, 1.6 16V	'02-'12	3,75-3,8	EcoTronic F 5W-20; HighTronic F 5W-30	2,3	Getriebeöl SNS 75W-80	-				Getriebeöl ATF J				↔	↔				5
Puma 1.4 16V, 1.6 16V, 1.7 16V	'97-'02	3,8-4,6	HighTronic F 5W-30	2,8	Getriebeöl SNS 75W-80	-								↔	↔				6-7,5
Escort, Orion 1.1-1.6i	'90-'97	3,3/3,5	●	●	3,1	Getriebeöl SNS 75W-80	c	Getriebeöl ATF 55		Getriebeöl ATF 22				↔	↔				7-8
Escort 1.6i-16V	'91-'00	3,5	HighTronic F 5W-30	3,1	Getriebeöl SNS 75W-80	c	-							↔	↔				7
Escort, Orion 1.8-16V, 4x4, XR3i	'91-'00	4,3	HighTronic F 5W-30	2,4/2,6	Getriebeöl SNS 75W-80	cd	-							↔	↔		h		7
Focus 1.4, 1.6, 1.8 16V	'98-'04	3,8-4,3	HighTronic F 5W-30	2,8	Getriebeöl SNS 75W-80	-								↔	↔				5,5-6
Focus 2.0 16V	'98-'04	4,3	HighTronic F 5W-30	2,6	Getriebeöl SNS 75W-80	-								↔	↔				6
Focus 2.0 16V ST170	'02-'04	4,25	HighTronic F 5W-30	1,7	Getriebeöl SNS 75W-80	-								↔	↔				-
Focus 2.0 16V Turbo RS	'02-'04	4,3	HighTronic F 5W-30	1,9	Getriebeöl SNS 75W-80	-								↔	↔				-
Focus 1.4 16V, 1.6 16V, 1.8 16V, 2.0 16V	'04-'11	3,8-4,3	EcoTronic F 5W-20; HighTronic F 5W-30	1,9-2,3	Getriebeöl SNS 75W-80	-		Getr.Öl ATF E-S						↔	↔				5,2-6,5
Focus 1.8 16V, 1.8 16V Flex Fuel	'09-'11	4,6	EcoTronic F 5W-20; HighTronic F 5W-30	1,9-2,3	Getriebeöl SNS 75W-80	-								↔	↔				6,5
Focus 2.0 16V CNG, 2.0 16V LPG	'09-'11	4,3	EcoTronic F 5W-20; HighTronic F 5W-30	1,9	Getriebeöl SNS 75W-80	-								↔	↔				6,3
Focus 2.5 20V Turbo RS	'09-'11	5,8	Spezialprodukt, bitte auf Originalersatzteil des Herstellers zurückgreifen!			2	Getriebeöl SNS 75W-80	-						↔	↔				7,1
Focus 2.5 20V Turbo ST	'05-'10	6,4	HighTronic F 5W-30	2	Getriebeöl SNS 75W-80	-								↔	↔				7,1
Focus 1.0 EcoBoost	'12-	4,1	EcoTronic F 5W-20	2,3	Getriebeöl SNS 75W-80	-								↔	↔				5,8
Focus 1.6 16V TI-VCT, 1.6 EcoBoost	'11-	4,05	EcoTronic F 5W-20	1,67	Spezialprodukt	p	Spezialprodukt			qr				↔	↔				5,5-5,7
Focus 2.0 ST EcoBoost	'12-	5,4	EcoTronic F 5W-20	1,75	Spezialprodukt	-								↔	↔				5,5
Mondeo 1.6, 1.8, 2.0, 4x4	'92-'01	4,3	HighTronic F 5W-30	2,4-2,6	Getriebeöl SNS 75W-80	e	Getriebeöl ATF 55		Getriebeöl ATF 22					↔	↔		h		6,5/7
Mondeo V6 2.5i 24V	'94-'01	5,5	HighTronic F 5W-30	2,6	Getriebeöl SNS 75W-80	-		Getriebeöl ATF 55		Getriebeöl ATF 22				↔	↔				9,5

FORD (EU)	Modell	Jahr	Zylinder	SuperTronic			HighTronic			Blue Tronic	Aral	Aral	Aral		Aral	Aral	Aral	Aral
				G 0W-30	0W-40	LL III 5W-30	M 5W-40	5W-40	G 5W-30	10W-40			Synthese	Mineral				
Mondeo 1.8 16V, 2.0 16V	'01-'07	4,3-4,5	HighTronic F 5W-30						1,9	Getriebeöl SNS 75W-80		Getriebeöl ATF 55	Getriebeöl ATF 22					8-8,5
Mondeo 1.8 SCl	'06-'07	4,3	EcoTronic F 5W-20; HighTronic F 5W-30						1,8	Getriebeöl SNS 75W-80		-						8,3
Mondeo 2.5	'01-'03	5,5	EcoTronic F 5W-20; HighTronic F 5W-30						1,9	Getriebeöl SNS 75W-80		Getriebeöl ATF 55	Getriebeöl ATF 22					9,5
Mondeo 2.5	'03-'07	5,7	EcoTronic F 5W-20; HighTronic F 5W-30						1,9	Getriebeöl SNS 75W-80		Getriebeöl ATF 55	Getriebeöl ATF 22	m				9,5
Mondeo 3.0 V6, ST 220	'02-'07	5,2-5,7	EcoTronic F 5W-20; HighTronic F 5W-30						1,9	Getriebeöl SNS 75W-80		-						9,5
Mondeo 1.6 16V, 2.0 16V, 2.3 16V	'07-'10	4,1-4,3	EcoTronic F 5W-20; HighTronic F 5W-30						1,9/2,3	Getriebeöl SNS 75W-80			Getriebeöl ATF J					6,2
Mondeo 1.6 Ti-VCT	'10-'11	4,05	EcoTronic F 5W-20; HighTronic F 5W-30						2,3	Getriebeöl SNS 75W-80		-						6,16
Mondeo 1.6 Ti-VCT	'10-'11	4,05	EcoTronic F 5W-20; HighTronic F 5W-30						2,3	Getriebeöl SNS 75W-80		-						6,16
Mondeo 1.6 EcoBoost ECOnetic	'11-'11	4,1	EcoTronic F 5W-20; HighTronic F 5W-30						1,75-2	Spezialprodukt		-						6,5
Mondeo 1.6 EcoBoost ECOnetic	'12-	4,1	EcoTronic F 5W-20; HighTronic F 5W-30						1,75-2	Spezialprodukt		-						6,5
Mondeo 2.0 16V Flex Fuel, 2.0 16V LPG	'07-'10	4,6	EcoTronic F 5W-20; HighTronic F 5W-30						1,9	Getriebeöl SNS 75W-80		-						6,2
Mondeo 2.0 16V Flex Fuel	'10-'11	4,3	EcoTronic F 5W-20; HighTronic F 5W-30						1,9	Spezialprodukt		-						6,2
Mondeo 2.0 16V Flex Fuel	'12-	4,3	EcoTronic F 5W-20; HighTronic F 5W-30						1,9	Spezialprodukt		-						6,2
Mondeo 2.0 16V EcoBoost SCTi	'07-'10	5,4	EcoTronic F 5W-20; HighTronic F 5W-30						1,8	Getriebeöl SNS 75W-80		-						6,2
Mondeo 2.0 16V EcoBoost SCTi	'10-'11	5,4	EcoTronic F 5W-20; HighTronic F 5W-30						-	-		Spezialprodukt						6,2
Mondeo 2.0 16V EcoBoost SCTi	'12-	5,4	EcoTronic F 5W-20; HighTronic F 5W-30						-	-		Spezialprodukt						6,2
Mondeo 2.5 20V	'07-'10	6,4	EcoTronic F 5W-20; HighTronic F 5W-30						2	Getriebeöl SNS 75W-80		-						7,1
Scorpio 2.0i, 2.0i, 2.3i 16V, 2.9i V6, 24V	'94-'98	4,3-5	HighTronic F 5W-30						1,2	Getriebeöl SNS 75W-80		Getriebeöl ATF 55	Getriebeöl ATF 22		0,9-1,3	Getriebeöl BS 75W-90		7,5-8,5
Probe 2.0 16V, 2.5 V6 24V	'92-'98	3,5-4	HighTronic F 5W-30						2,7	Getr.Öl SNS-B 75W-80	c	-						7-7,5
Cougar 2.0 16V	'98-'02	4,3	HighTronic F 5W-30						2,6	Getriebeöl SNS 75W-80		-						6,6
Cougar 2.5 V6 24V	'98-'02	5,5	HighTronic F 5W-30						2,6	Getriebeöl SNS 75W-80		Getriebeöl ATF 55	Getriebeöl ATF 22					9,5
B-Max 1.0 EcoBoost	'12-	4,1	EcoTronic F 5W-20						2,3	Getriebeöl SNS 75W-80		-						-
B-Max 1.4	'12-	4,05	EcoTronic F 5W-20						2,3	Getriebeöl SNS 75W-80		-						5,5
B-Max 1.6 Ti-VCT	'12-	-	EcoTronic F 5W-20						2,3	Spezialprodukt		-						5,5
Focus C-Max 1.6 16V, 1.8 16V, 2.0 16V	'03-'07	4,1-4,3	EcoTronic F 5W-20; HighTronic F 5W-30						1,9-2,3	Getriebeöl SNS 75W-80		-						5-6,5
C-Max 1.0 EcoBoost	'12-	4,1	EcoTronic F 5W-20						-	Spezialprodukt	p	-						5,8
C-Max 1.6 16V, 1.8 16V, 1.8 16V Flexfuel	'07-'10	4-4,6	EcoTronic F 5W-20; HighTronic F 5W-30						1,9-2,3	Getriebeöl SNS 75W-80		-						5-6,5
C-Max 2.0 16V	'07-'07	4,3	EcoTronic F 5W-20; HighTronic F 5W-30						1,9	Getriebeöl SNS 75W-80		Spezialprodukt						6,3
C-Max 2.0 16V	'08-'10	4,3	EcoTronic F 5W-20; HighTronic F 5W-30						1,9	Getriebeöl SNS 75W-80		Spezialprodukt						6,3
C-Max 2.0 16V CNG, 2.0 16V LPG	'09-'10	4,3	EcoTronic F 5W-20; HighTronic F 5W-30						1,9	Getriebeöl SNS 75W-80		-						6,3
(Grand) C-Max 1.0 EcoBoost	'12-	4,1	EcoTronic F 5W-20						-	Spezialprodukt	p	-						5,8
(Grand) C-Max 1.6 Ti-VCT, EcoBoost	'10-'10	4,05	EcoTronic F 5W-20; HighTronic F 5W-30						1,67	Spezialprodukt	p	-						5,5-5,7
(Grand) C-Max 1.6 Ti-VCT, EcoBoost	'11-'11	4,05	EcoTronic F 5W-20; HighTronic F 5W-30						1,67	Spezialprodukt	p	-						5,5-5,7
(Grand) C-Max 1.6 Ti-VCT	'12-	4,05	EcoTronic F 5W-20						1,67	Spezialprodukt	p	-						5,5-5,7
(Grand) C-Max 1.6 EcoBoost	'12-	4,05	EcoTronic F 5W-20; HighTronic F 5W-30						1,67	Spezialprodukt	p	-						5,5-5,7
Galaxy 2.0i, 2.3i (L4)	'95-'06	4-4,5	HighTronic F 5W-30						2	Getriebeöl SNS 75W-80		Getriebeöl ATF-LD					f	8-11
Galaxy 2.8i (VR6), 4x4	'95-'00	5,5							2,3-2,5	Getriebeöl SNS 75W-80		Getriebeöl ATF-LD					fh	9-11,5
Galaxy 2.8i V6	'00-'06	5,5							2,5	Getr.Öl EP Synth 75W-90		Getriebeöl ATF-LD						7,2-10
Galaxy, S-Max 1.6 EcoBoost	'10-'11	4,1	EcoTronic F 5W-20; HighTronic F 5W-30						1,75-2	Spezialprodukt		-						-
Galaxy, S-Max 1.6 EcoBoost	'12-	4,1	EcoTronic F 5W-20; HighTronic F 5W-30						1,75-2	Spezialprodukt		-						-
Galaxy, S-Max 2.0 16V, 2.3 16V, 2.5 20V Turbo	'06-'10	4,3/6,4	EcoTronic F 5W-20; HighTronic F 5W-30						1,7-1,9	Getriebeöl SNS 75W-80			Getriebeöl ATF J					6,17,1
Galaxy, S-Max 2.0 16V Flex Fuel	'09-'10	4,6	EcoTronic F 5W-20; HighTronic F 5W-30						1,9	Getriebeöl SNS 75W-80		-						6,2
Galaxy, S-Max 2.0 16V, Flex Fuel, EcoBoost SCTi	'10-'11	4,3-5,4	EcoTronic F 5W-20; HighTronic F 5W-30						1,9	Spezialprodukt		Spezialprodukt						6,2
Galaxy, S-Max 2.0 16V, Flex Fuel, EcoBoost SCTi	'12-	4,3-5,4	EcoTronic F 5W-20; HighTronic F 5W-30						1,9	Spezialprodukt		Spezialprodukt						6,2
Kuga 2.5 Turbo AWD	'08-'11	5,8	EcoTronic F 5W-20; HighTronic F 5W-30						2	Spezialprodukt			Getriebeöl ATF J					-
Kuga 1.6 EcoBoost	'13-	4,05	EcoTronic F 5W-20; HighTronic F 5W-30						1,89	Spezialprodukt		Spezialprodukt		r				-
Tourneo Connect 1.8	'02-'07	4,3	HighTronic F 5W-30						1,9	Getriebeöl SNS 75W-80		-						6,5



Maverick 2.4i	'93-'00	4,3		●					3,5	Getriebeöl SNS 75W-80	a	-				2,8	Getr.Öl HYP LS 85W-90	j	7
Maverick, Escape 2.0 16V, 3.0 V6	'00-'03	4,3-5,7	HighTronic F 5W-30						2,7	Getr.Öl SNS-B 75W-80	a	-				↕	↕	j	6,5-10
Maverick, Escape 2.3 16V, 3.0 V6	'03-'07	4,3-5,7	HighTronic F 5W-30						2,7	Getriebeöl SNS 75W-80	n	-				↕	↕	l	6,7-10
Windstar	'94-'99	4,7		●		●			-	-		-	Spezialprodukt			↕	↕		15
<b>Diesel</b>																			
Ka 1.3 TDCi Duratorq	'08-	2,8					●		1,65	Spezialprodukt		-				↕	↕		6,3
Fiesta 1.8 D	'95-'02	5	HighTronic F 5W-30						2,8	Getriebeöl SNS 75W-80	-	-				↕	↕		9,5
Fiesta 1.8 Turbo DI	'00-'02	5,6	HighTronic F 5W-30						2,6	Getriebeöl SNS 75W-80	-	-				↕	↕		9,5
Fiesta 1.4, 1.6 TDCi	'02-'08	3,9	HighTronic F 5W-30						2,3	Getriebeöl SNS 75W-80	-	-				↕	↕		5,5-6
Fiesta 1.4, 1.6 TDCi Duratorq	'08-'10	3,9	HighTronic F 5W-30						2,3	Getriebeöl SNS 75W-80	-	-				↕	↕		5,5
Fiesta 1.4, 1.5, 1.6 TDCi Duratorq Euro 5	'10-	3,9	HighTronic F 5W-30						2,3	Getriebeöl SNS 75W-80	-	-				↕	↕		-
Fusion 1.4, 1.6 TDCi	'02-'12	3,8	HighTronic F 5W-30						2,3	Getriebeöl SNS 75W-80	-	-				↕	↕		5,5-6
Escort, Orion 1.6 D, 1.8 D	'83-'97	5		●		●			2,8/3,1	Getriebeöl SNS 75W-80	-	-				↕	↕		9,5
Escort 1.8 TD	'91-'99	5-5,1		●		●			2,6	Getriebeöl SNS 75W-80	-	-				↕	↕		9,5
Focus 1.8 Turbo DI, TDCi	'98-'04	5,6	HighTronic F 5W-30						2,6	Getriebeöl SNS 75W-80	-	-				↕	↕		6,5
Focus 1.6, 1.8, 2.0 TDCi	'04-'10	3,8-5,6	HighTronic F 5W-30						1,8-1,9	Getriebeöl SNS 75W-80	Getr.Öl ATF E-S		g			↕	↕		7,3-9
Focus 1.6 TDCi Duratorq	'11-'11	3,85	HighTronic F 5W-30						0,96	Spezialprodukt	-	-				↕	↕		-
Focus 1.6 TDCi Duratorq	'12-	3,85	HighTronic F 5W-30						0,96	Spezialprodukt	-	-				↕	↕		-
Focus 2.0 TDCi Duratorq	'11-'11	5,65	HighTronic F 5W-30						1,75-1,9	Spezialprodukt	Spezialprodukt		qr			↕	↕		-
Focus 2.0 TDCi Duratorq	'12-	5,65	HighTronic F 5W-30						1,75-1,9	Spezialprodukt	Spezialprodukt		qr			↕	↕		-
Mondeo 1.8 Turbo D	'92-'01	4,5-5,6	HighTronic F 5W-30						2,6	Getriebeöl SNS 75W-80	-	-				↕	↕		9,5
Mondeo 2.0 TDDi, 2.0, 2.2 TDCi	'01-'07	5,6-6,5	HighTronic F 5W-30						1,9	Getriebeöl SNS 75W-80	Getriebeöl ATF 55	Getriebeöl ATF 22				↕	↕		10,5
Mondeo 1.6 TDCi ECONetic Euro 5	'11-'11	3,85	HighTronic F 5W-30						2	Spezialprodukt	-	-				↕	↕		-
Mondeo 1.6 TDCi ECONetic Euro 5	'12-	3,85	HighTronic F 5W-30						2	Spezialprodukt	-	-				↕	↕		-
Mondeo 1.8, 2.0 TDCi	'07-'10	5,5-5,6	HighTronic F 5W-30						1,9/-	Getriebeöl SNS 75W-80		Getriebeöl ATF J				↕	↕		7,9-8,1
Mondeo 2.0 TDCi, 2.2 TDCi	'07-'10	5,5-6,5	HighTronic F 5W-30						1,8	Getriebeöl SNS 75W-80		Getriebeöl ATF J				↕	↕		8,1
Mondeo 2.0 TDCi Duratorq	'10-	5,65	HighTronic F 5W-30						1,75	Spezialprodukt	r	-	r			↕	↕		8,14
Mondeo 2.2 TDCi Duratorq	'10-'11	5,9	HighTronic F 5W-30						2	Spezialprodukt	-	-				↕	↕		8,14
Mondeo 2.2 TDCi Duratorq	'12-	5,9	HighTronic F 5W-30						2	Spezialprodukt	-	-				↕	↕		8,14
Scorpio, Granada 2.5 D	'85-'91	5,6		●		●			1,3	Getriebeöl SNS 75W-80	b	-			0,9-1,3	Getriebeöl BS 75W-90			11
Scorpio 2.5 Turbo D (VM)	'94-'98	6,6		●		●			1,2	Getriebeöl SNS 75W-80	-	-			1,3	Getriebeöl BS 75W-90			7
Focus C-Max 1.6, 1.8, 2.0 TDCi 16V	'03-'07	3,8-5,6	HighTronic F 5W-30						1,8-1,9	Getriebeöl SNS 75W-80	Getr.Öl ATF E-S		g			↕	↕		6,5-9
B-Max 1.5 TDCi, 1.6 TDCi	'12-	3,85	HighTronic F 5W-30						2,3	Getriebeöl SNS 75W-80	-	-				↕	↕		5,5
C-Max 1.6 TDCi, 1.8 TDCi	'07-'08	3,8-5,6	HighTronic F 5W-30						1,9	Getriebeöl SNS 75W-80	-	-				↕	↕		7-9
C-Max 1.6 TDCi, 2.0 TDCi	'07-'10	3,8-5,5	HighTronic F 5W-30						1,8-1,9	Getriebeöl SNS 75W-80	-	-				↕	↕		6,5-7
C-Max 1.6 TDCi, 2.0 TDCi	'11-	3,8-5,5	HighTronic F 5W-30						1,75	Spezialprodukt	pr	-				↕	↕		-
(Grand) C-Max 1.6 TDCi	'10-'11	3,85	HighTronic F 5W-30						1,67	Spezialprodukt	pr	-				↕	↕		-
(Grand) C-Max 1.6 TDCi	'12-	3,85	HighTronic F 5W-30						1,67	Spezialprodukt	pr	-				↕	↕		-
(Grand) C-Max 2.0 TDCi	'10-'11	5,65	HighTronic F 5W-30						1,75	Spezialprodukt	p	Spezialprodukt				↕	↕		-
(Grand) C-Max 2.0 TDCi	'12-	5,65	HighTronic F 5W-30						1,75	Spezialprodukt	p	Spezialprodukt				↕	↕		-
Galaxy 1.9 TDI	'95-'99	4,3							2-2,3	Getriebeöl SNS 75W-80	-	-				↕	↕		9
Galaxy 1.9 TDI	'99-'06	4,3-4,5					●		2,3	Getriebeöl SNS 75W-80	-	-				↕	↕		9
Galaxy, S-Max 1.6 TDCi ECONetic Euro 5	'11-'11	3,85	HighTronic F 5W-30						2	Spezialprodukt	-	-				↕	↕		7,9
Galaxy, S-Max 1.6 TDCi ECONetic Euro 5	'12-	3,85	HighTronic F 5W-30						2	Spezialprodukt	-	-				↕	↕		7,9
Galaxy, S-Max 2.2 TDCi	'10-'11	5,9	HighTronic F 5W-30						1,7-2	Spezialprodukt				Getriebeöl ATF J		↕	↕		-
Galaxy, S-Max 1.8, 2.0, 2.2 TDCi	'06-'10	5,5-5,9	HighTronic F 5W-30						1,7-2	Getriebeöl SNS 75W-80	-	-				↕	↕		7,9-8,2
Galaxy, S-Max 2.0 TDCi Duratorq	'10-'11	5,65	HighTronic F 5W-30						1,75	Spezialprodukt	Spezialprodukt					↕	↕		-
Galaxy, S-Max 2.0 TDCi Duratorq	'12-	5,65	HighTronic F 5W-30						1,75	Spezialprodukt	Spezialprodukt					↕	↕		-
Galaxy, S-Max 2.2 TDCi	'10-'11	5,9	HighTronic F 5W-30						1,7-2	Spezialprodukt				Getriebeöl ATF J		↕	↕		-
Galaxy, S-Max 2.2 TDCi	'12-	5,9	HighTronic F 5W-30						1,7-2	Spezialprodukt				Getriebeöl ATF J		↕	↕		-
Kuga 2.0 TDCi	'09-'10	5,5	HighTronic F 5W-30						1,8	Spezialprodukt	-	-				↕	↕		7
Kuga 2.0 TDCi	'10-'11	-	HighTronic F 5W-30						1,8	Spezialprodukt	-	-				↕	↕		7
Kuga 2.0 TDCi (140, 163) AWD Euro 5	'11-'13	-	HighTronic F 5W-30						1,8-2	Spezialprodukt				Getriebeöl ATF J	r	-	Getriebeöl HYP 85W-90	t	-
Kuga 2.0 TDCi (140, 163) AWD Euro 5	'13-	-	HighTronic F 5W-30						1,8-2	Spezialprodukt	Spezialprodukt			r	-	Getriebeöl HYP 85W-90	t	-	
Tourneo Connect 1.8 TDCi	'02-'11	4,25-5,6	HighTronic F 5W-30						1,9	Getriebeöl SNS 75W-80	-	-				↕	↕		7
Maverick 2.7 TD, TDi	'93-'99	6,2-7,2		●		●			3,5	Getriebeöl SNS 75W-80	a	-				↕	↕		10
Ranger 2.5 TDCi, 3.0 TDCi	'06-'11	7-8		●		●			2,8	Getr.Öl SNS-B 75W-80	Getr.Öl ATF E-S	Getriebeöl ATF 55			1,3-2,6	Getriebeöl BS 75W-90	j	9,4	

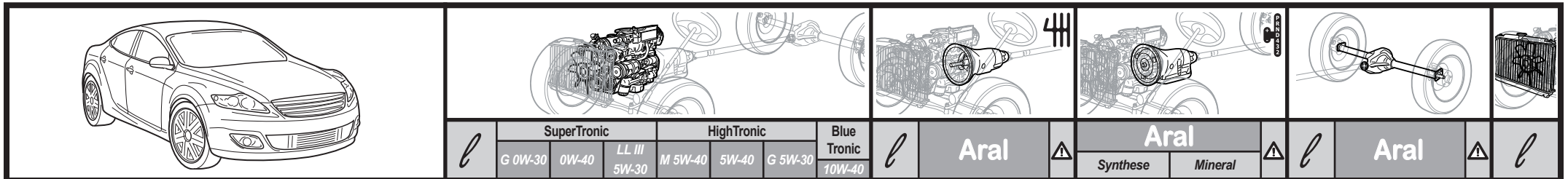

SuperTronic		HighTronic			Blue Tronic	Aral		Aral		Aral	
G 0W-30	0W-40	LL III 5W-30	M 5W-40	5W-40	G 5W-30	10W-40	Synthese	Mineral			
<p><b>FORD (EU)</b></p> <p>a Verteilergetriebe: 2,3 l Getr.Öl ATF E-S; Getriebeöl ATF 55</p> <p>c Getriebe ab 1995 Modelle: Getriebeöl SNS 75W-80; Getr.Öl EP Synth 75W-90</p> <p>e Verteilergetriebe: 0,5/0,7 l Getr.Öl ATF E-S; Getriebeöl ATF 55</p> <p>g CVT (Automat): Spezialprodukt, bitte auf Originalersatzteil des Herstellers zurückgreifen!</p> <p>j Differential, vorn (4WD/4x4): 1,3-1,4 l Getriebeöl BS 75W-90; Getriebeöl HYP Synth 75W-90</p> <p>m 5-Gang Automatikgetriebe: Getr.Öl ATF E-S</p> <p>p Getriebe iB5: 2,3 l Getriebeöl SNS 75W-80; Getr.Öl EP Synth 75W-90</p> <p>r Getriebe 6DCT450 Spezialprodukt, bitte auf Originalersatzteil des Herstellers zurückgreifen!</p>						<p>b Getriebe Typ MT75 ab 1989: 1,2 l Getriebeöl SNS 75W-80</p> <p>d Verteilergetriebe: 0,3 l Getriebeöl SNS 75W-80; Getr.Öl EP Synth 75W-90</p> <p>f Differential, Modelle mit Automatikgetriebe: 0,8-1,4 l Getriebeöl BS 75W-90</p> <p>h Differential, hinten (4WD/4x4): 1 l Getriebeöl BS 75W-90; Getriebeöl HYP Synth 75W-90</p> <p>l Differential, hinten (4WD/4x4): 1,4 l Getriebeöl HYP 85W-90</p> <p>n Verteilergetriebe: 0,4 l Getr.Öl BS LSX 75W-140</p> <p>q Getriebe 6DCT250</p> <p>t Verteilergetriebe: Getriebeöl BS 75W-90; Getriebeöl SNA-C 75W-90</p>					

<b>FORD (USA)</b>											
Fiesta 1.6 16V	'10-'11	4	HighTronic F 5W-30	2,1	Getriebeöl SNS 75W-80	Spezialprodukt					5,5
Fiesta 1.6 16V	'12-	4	HighTronic F 5W-30	2,1	Getriebeöl SNS 75W-80	Spezialprodukt					5,5
Escort, ZX2	'97-'03	4,3	HighTronic F 5W-30	3,4	Getr.Öl ATF E-S	Getr.Öl ATF E-S	Getriebeöl ATF 55				5-6
C-Max Hybrid, Energi	'13-	4,3	HighTronic F 5W-30	-	-	Spezialprodukt					7-9,3
Focus 2.0 16V, 2.3 16V	'05-'07	4,3	HighTronic F 5W-30	2	Getriebeöl SNS 75W-80	Spezialprodukt					5,8
Focus 2.0 16V	'11-'11	4,3	HighTronic F 5W-30	1,8	Spezialprodukt	Spezialprodukt					5
Focus 2.0 16V	'12-	4,3	HighTronic F 5W-30	1,8	Spezialprodukt	Spezialprodukt					5
Focus Electric	'12-	-	-	-	-	Spezialprodukt					15
Contour 2.0, 2.5 V6	'97-'00	4,3/5,5	HighTronic F 5W-30	1,9	Getr.Öl ATF E-S	Getr.Öl ATF E-S	Getriebeöl ATF 55				6,6-9,7
Fusion 1.6 EcoBoost	'13-	4,1	HighTronic F 5W-30	-	-	Spezialprodukt					6,8
Fusion 2.0 EcoBoost	'13-	5,4	HighTronic F 5W-30	-	-	Spezialprodukt					8,4
Fusion 2.3 16V	'05-'09	4,3	HighTronic F 5W-30	2,8	Getr.Öl SNS-B 75W-80		Getriebeöl ATF J				8,1
Fusion 2.5 16V	'10-'11	4,7	HighTronic F 5W-30	2,87	Getr.Öl SNS-B 75W-80		Getriebeöl ATF J				8,1
Fusion 2.5 16V	'12-'12	5	HighTronic F 5W-30	2,87	Getr.Öl SNS-B 75W-80		Getriebeöl ATF J	x			8,8
Fusion 2.5 16V	'13-	5,4	HighTronic F 5W-30	2,87	-	Spezialprodukt					6,8
Fusion 2.5 Hybrid	'10-'11	4,7	HighTronic F 5W-30	-	-	Spezialprodukt					11,5
Fusion 2.5 Hybrid	'12-'12	4,7	HighTronic F 5W-30	-	-	Spezialprodukt					11,5
Fusion 3.0 V6 24V	'05-'09	5,7	HighTronic F 5W-30	-	-		Getriebeöl ATF J				9,2
Fusion 3.0 V6, 3.5 V6, AWD	'10-'11	5,2-5,7	HighTronic F 5W-30	2,87	Getr.Öl SNS-B 75W-80		Getriebeöl ATF J	ax		b	9,2-9,5
Fusion 3.0 V6, 3.5 V6, AWD	'12-	5,2-5,7	HighTronic F 5W-30	2,87	Getr.Öl SNS-B 75W-80		Getriebeöl ATF J	ax		b	9,2-10
Five Hundred, Freestyle 3.0 V6, 4WD	'04-'07	5,7	HighTronic F 5W-30	-	-		Getriebeöl ATF J	dfg		e	11
Taurus 2.0 EcoBoost	'13-	5,4	HighTronic F 5W-30	-	-	Spezialprodukt					11
Taurus 3.0, 3.4 SHO	'96-'99	4,3/6,1				Getr.Öl ATF E-S	Getriebeöl ATF 55				10/11
Taurus 3.0 V6, 24V	'99-'05	4,3/5,7	HighTronic F 5W-30	-	-	Spezialprodukt					10/11
Taurus 3.5 V6, AWD	'08-'10	5,2	HighTronic F 5W-30	-	-	Spezialprodukt		a		b	10,5
Taurus 3.5 V6, AWD	'10-'11	5,2	HighTronic F 5W-30	-	-	Spezialprodukt		a		b	10,5
Taurus 3.5 V6, AWD	'12-	5,2-5,7	HighTronic F 5W-30	-	-	Spezialprodukt		a		b	10,5
Taurus 3.5 V6 SHO AWD	'10-'11	5,2	HighTronic F 5W-30	-	-	Spezialprodukt		a	1,15	Getriebeöl HYP 85W-90	10,8
Taurus 3.5 V6 SHO AWD	'12-'12	5,2	HighTronic F 5W-30	-	-	Spezialprodukt		a	1,15	Getriebeöl HYP 85W-90	10,8
Taurus 3.5 V6 SHO EcoBoost AWD	'13-	5,7	HighTronic F 5W-30	-	-	Spezialprodukt		a	1,15	Getriebeöl HYP 85W-90	10,8
Taurus X 3.5 V6, AWD	'08-'09	5,2	HighTronic F 5W-30	-	-	Spezialprodukt		a		b	10,5
Crown Victoria 4.6 V8	'98-'01	4,7	HighTronic F 5W-30	-	-	Spezialprodukt		1,8		Getriebeöl BS 75W-90	15
Crown Victoria 4.6 V8	'01-'05	4,7	HighTronic F 5W-30	-	-	Spezialprodukt		1,8		Getriebeöl BS 75W-90	15
Crown Victoria 4.6 V8	'05-'11	5,7	HighTronic F 5W-30	-	-	Spezialprodukt		2,4		Getriebeöl BS 75W-90	u
Thunderbird 3.9 V8	'00-'03	6,2				Spezialprodukt		1,2-1,3		Getr.Öl BS LSX 75W-140	11,3
Thunderbird 3.9 V8	'03-'05	6,2				Spezialprodukt		1,2-1,3		Getriebeöl BS 75W-90	11,3
Mustang 3.7 V6	'11-'11	5,7	HighTronic F 5W-30	2,6	Getriebeöl SNS 75W-80	Spezialprodukt		2,5		Getr.Öl BS LSX 75W-140	11,7

Mustang 3.7 V6	'12-	5,7	HighTronic F 5W-30		2,6	Getriebeöl SNS 75W-80		Spezialprodukt				2,5	Getr.Öl BS LSX 75W-140		11,7	
Mustang 3.8 V6	'93-'05	5		●				Getr.Öl ATF E-S	Getr.Öl ATF E-S	Getriebeöl ATF 55		1,4	Getriebeöl BS 75W-90	c	12	
Mustang, GT 4.9 V8	'93-'05	4,7		●				Getr.Öl ATF E-S	Getr.Öl ATF E-S	Getriebeöl ATF 55		1,4	Getr.Öl HYP LS 85W-90		13	
Mustang 4.0 V6, 4.6 V8	'05-'11	4,7-5,7		●				Getr.Öl ATF E-S	Spezialprodukt			1,5-2	Getr.Öl BS LSX 75W-140		11,8	
Mustang GT 5.0 V8	'11-'11	7,6	HighTronic F 5W-30		2,6	Getriebeöl SNS 75W-80		Spezialprodukt				2,5	Getr.Öl BS LSX 75W-140		12,3	
Mustang GT 5.0 V8	'12-	7,6	HighTronic F 5W-30		2,6	Getriebeöl SNS 75W-80		Spezialprodukt				2,5	Getr.Öl BS LSX 75W-140		12,3	
Mustang GT 5.0 Track Pack V8	'13-	7,6	Spezialprodukt, bitte auf Originalersatzteil des Herstellers zurückgreifen!		2,6	Spezialprodukt		Spezialprodukt				2,5	Getr.Öl BS LSX 75W-140		12,3	
Mustang Boss 302 5.0 V8	'11-'11	7,6	HighTronic F 5W-30		2,6	Getriebeöl SNS 75W-80		Spezialprodukt				2,5	Getr.Öl BS LSX 75W-140		12,3	
Mustang Boss 302 5.0 V8	'12-	7,6	Spezialprodukt, bitte auf Originalersatzteil des Herstellers zurückgreifen!		2,6	Getriebeöl SNS 75W-80		Spezialprodukt				2,5	Getr.Öl BS LSX 75W-140		12,3	
Mustang Shelby GT500	'06-'09	6,1	Spezialprodukt, bitte auf Originalersatzteil des Herstellers zurückgreifen!		3,5	Spezialprodukt		-				2	Getr.Öl BS LSX 75W-140		23,75	
Mustang Shelby GT500	'10-'10	6,1	Spezialprodukt, bitte auf Originalersatzteil des Herstellers zurückgreifen!		3,5	Spezialprodukt		-				2	Getr.Öl BS LSX 75W-140		23,75	
Mustang Shelby GT500	'11-'12	6,1	Spezialprodukt, bitte auf Originalersatzteil des Herstellers zurückgreifen!		3,4-3,9	Spezialprodukt		-			1,9-2,8		Getr.Öl BS LSX 75W-140		20-25	
Mustang Shelby GT500	'13-	8,5	Spezialprodukt, bitte auf Originalersatzteil des Herstellers zurückgreifen!		3,4-3,9	Spezialprodukt		-			1,9-2,8		Getr.Öl BS LSX 75W-140		20-25	
Escape 1.6 EcoBoost, AWD	'13-	4,1	HighTronic F 5W-30		-	-		Spezialprodukt		a	↔	↔	b	8		
Escape 2.0 EcoBoost, AWD	'13-	5,4	HighTronic F 5W-30		-	-		Spezialprodukt		a	↔	↔	b	9,2		
Escape 2.3, 3.0 V6, AWD	'00-'08	4,3/ 5,7	HighTronic F 5W-30		2,2/2,7	Getriebeöl SNS 75W-80	ak	-			↔	↔	h	6,7/10		
Escape 2.5 16V, 3.0 V6, AWD	'09-'11	5-5,7	HighTronic F 5W-30		2,3	Getr.Öl SNS-B 75W-80		Spezialprodukt		a	↔	↔	b	7-9		
Escape 2.5 16V, 3.0 V6, AWD	'12-'12	5-5,7	HighTronic F 5W-30		2,3	Getr.Öl SNS-B 75W-80		Spezialprodukt		a	↔	↔	b	7-9		
Escape 2.5 16V	'13-	5,4	HighTronic F 5W-30		-	-		Spezialprodukt			↔	↔	b	8,7		
Escape Hybrid, AWD	'05-'08	4,3	HighTronic F 5W-30		-	-		Getr.Öl ATF E-S	Getriebeöl ATF 55	ak	↔	↔	h	8/3,5		
Escape Hybrid 2.5 16V, AWD	'09-'11	5	HighTronic F 5W-30		-	-		Spezialprodukt		a	↔	↔	b	10,5		
Escape Hybrid 2.5 16V, AWD	'12-'12	5	HighTronic F 5W-30		-	-		Spezialprodukt		a	↔	↔	b	10,5		
Edge 2.0 Ecoboost	'11-	5,4	HighTronic F 5W-30		-	-		Spezialprodukt			↔	↔		8,4		
Edge 3.5 V6 24V	'06-'11	5,2	HighTronic F 5W-30		-	-		Spezialprodukt			↔	↔		11,1-12,1		
Edge 3.5 V6 24V, 3.7 Ti-VCT V6, AWD	'11-'11	5,2	HighTronic F 5W-30		-	-		Spezialprodukt		a	↔	↔	b	11,1-11,3		
Edge 3.5 V6 24V, 3.7 Ti-VCT V6, AWD	'12-	5,2	HighTronic F 5W-30		-	-		Spezialprodukt		a	↔	↔	b	11,1-11,3		
Freestyle 3.0 V6 24V, AWD	'04-'08	5,7	HighTronic F 5W-30		-	-		Spezialprodukt		d	↔	↔	b	11		
Flex 3.5 V6, AWD	'09-'11	5,2	HighTronic F 5W-30		-	-		Spezialprodukt		a	↔	↔	b	12,5		
Flex 3.5 V6, AWD	'12-	5,2-5,7	HighTronic F 5W-30		-	-		Spezialprodukt		a	↔	↔	b	12,5		
Flex 3.5 EcoBoost V6, AWD	'10-'11	5,2	HighTronic F 5W-30		-	-		Spezialprodukt		a	↔	↔	b	13		
Flex 3.5 EcoBoost V6, AWD	'12-	5,2-5,7	HighTronic F 5W-30		-	-		Spezialprodukt		a	↔	↔	b	13		
Windstar 3.0 V6	'94-'98	4,3		●				Getriebeöl ATF 55	Getriebeöl ATF 22		↔	↔		13-13,2		
Windstar 3.0 V6, 3.8 V6	'98-'01	4,3/4,7	HighTronic F 5W-30		-	-		Spezialprodukt			↔	↔		14-15		
Windstar 3.8 V6	'01-'04	4,7	HighTronic F 5W-30		-	-		Spezialprodukt			↔	↔		14-15		
Freestar 3.9 V6, 4.2 V6	'04-'07	4,7	HighTronic F 5W-30		-	-		Spezialprodukt			↔	↔		14-15		
Ranger 2.3, 3.0 V6, 4.0 V6, 4x4	'93-'97	4,3-4,7		●				Getr.Öl ATF E-S	m	Getr.Öl ATF E-S	Getriebeöl ATF 55	m	1,7/2,4	Getr.Öl BS LSX 75W-140	ln	6,2-11,2
Ranger 2.3, 3.0 V6, 4x4	'01-'10	3,8-4,3	HighTronic F 5W-30		2,7	Getr.Öl ATF E-S	m	Spezialprodukt		m	1,7		Getriebeöl BS 75W-90	n	9,7-14,3	
Ranger 3.0 V6, 4x4	'97-'01	4,3	HighTronic F 5W-30		2,7	Getr.Öl ATF E-S	m	Spezialprodukt		m	1,7		Getriebeöl BS 75W-90	n	14-14,3	
Ranger 4.0 V6, 4x4	'98-'11	4,7	HighTronic F 5W-30		2,7	Getr.Öl ATF E-S	m	Spezialprodukt		m	1,7		Getriebeöl BS 75W-90	n	12,5-13	
Explorer 3.5 V6, 4x4	'11-	5,7	HighTronic F 5W-30		-	-		Spezialprodukt			1,7		Getr.Öl BS LSX 75W-140	r	11,5	
Explorer 3.5 EcoBoost V6 AWD	'13-	5,7	HighTronic F 5W-30		-	-		Spezialprodukt		a	1,15		Getriebeöl HYP 85W-90		13	
Explorer 4.0 V6, 4.9 V6, 4x4	'95-'02	4,7		●				Getr.Öl ATF E-S	m	Getr.Öl ATF E-S	Getriebeöl ATF 55	m	2,6	Getr.Öl BS LSX 75W-140	no	7,4-13,5
Explorer 4.0 V6, 4.6 V8, 4x4	'02-'06	4,7/5,7		●				Spezialprodukt		m	1,5-1,7		Getriebeöl BS 75W-90	p	15,4-19	
Explorer 4.0 V6, 4.6 V8, 4x4	'06-'10	4,7/5,7	HighTronic F 5W-30		-	-		Spezialprodukt		mq	1,7		Getr.Öl BS LSX 75W-140	r	11,5-14,9	
Expedition 4.6 V8, 5.4 V8, 4x4	'96-'02	5,7	HighTronic F 5W-30		-	-		Getr.Öl ATF E-S	Getriebeöl ATF 55	mq	2,9-3,1		Getr.Öl BS LSX 75W-140	s	20,5-26,4	
Expedition 4.6 V8, 5.4 V8, 4x4	'02-'05	5,7		●				Spezialprodukt		m	1,8-2		Getriebeöl BS 75W-90	l	16,1-20,9	
Expedition 5.4 V8, 4x4	'05-'08	6,6	HighTronic F 5W-30		-	-		Spezialprodukt		m	2,13		Getr.Öl BS LSX 75W-140	ur	19,5-22,5	
Expedition 5.4 V8, 4x4	'09-'11	6,6	HighTronic F 5W-30		-	-		Spezialprodukt		y	2,13		Getr.Öl BS LSX 75W-140	ur	15,5-18,5	
Expedition 5.4 V8, 4x4	'12-	6,6	HighTronic F 5W-30		-	-		Spezialprodukt		y	2,1		Getr.Öl BS LSX 75W-140	ur	15,5-18,5	
Excursion 5.4 V8, 6.8 V10, 4x4	'00-'05	5,7	HighTronic F 5W-30		5,5	Getr.Öl ATF E-S		Spezialprodukt		m	3,3		Getr.Öl BS LSX 75W-140	r	25-26	
Econoline Wagon 4.9 V6, 5.0, 5.8, 7.5 V8	'92-'97	4,7	HighTronic F 5W-30		-	-		Getr.Öl ATF E-S	Getriebeöl ATF 55		3,5		Getr.Öl BS LSX 75W-140	tuv	16-22,3	
Econoline Wagon 4.2, 4.6, 5.4 V8, 6.8 V10	'97-'00	5,7	HighTronic F 5W-30		5,5	Getr.Öl ATF E-S		Spezialprodukt		qw	3,5		Getr.Öl BS LSX 75W-140	tuv	20,9-30,8	
E-150 Wagon 4.2 V6, 4.6 V8, 5.4 V8	'01-'08	5,7	HighTronic F 5W-30		5,5	Getr.Öl ATF E-S		Spezialprodukt		w	2,6-3,9	-		j	20,9-30,8	
E-150 Wagon 4.2 V6, 4.6 V8, 5.4 V8	'08-'11	5,7	HighTronic F 5W-30		-	-		Spezialprodukt			2,8-3,1	-		j	22,6-24,6	
E-150 Wagon 4.2 V6, 4.6 V8, 5.4 V8	'12-	5,7	HighTronic F 5W-30		-	-		Spezialprodukt			2,8-3,1	-		j	22,6-29,1	
E-350 Wagon 5.4 V8, 6.8 V10	'01-'08	5,7	HighTronic F 5W-30		-	-		Spezialprodukt		w	2,8-3,1	-		j	27,2-29,1	
E-350 Wagon 5.4 V8, 6.8 V10	'08-'11	5,7	HighTronic F 5W-30		-	-		Spezialprodukt			2,8-3,1	-		j	27,2-29,1	
E-350 Wagon 5.4 V8, 6.8 V10	'12-	5,7	HighTronic F 5W-30		-	-		Spezialprodukt			2,8-3,1	-		j	27,2-29,1	
GT	'04-'06	9		●				Spezialprodukt			↔	↔	e	25/17		

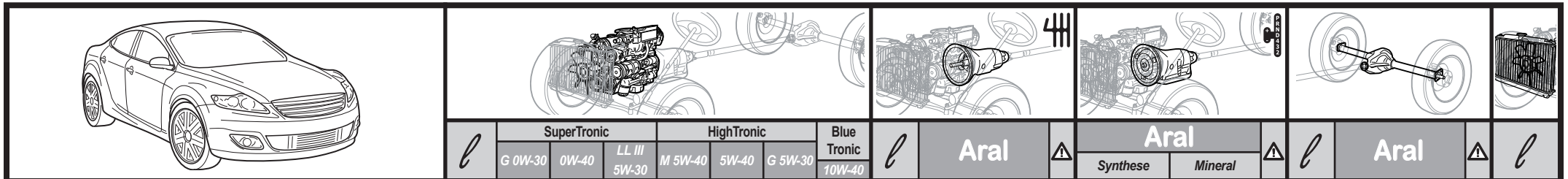

		SuperTronic			HighTronic			Blue Tronic	Aral	⚠	Aral		⚠	Aral	⚠		
		G 0W-30	0W-40	LL III 5W-30	M 5W-40	5W-40	G 5W-30	10W-40			Synthese	Mineral					
<b>FORD (USA)</b>																	
<b>Diesel</b>																	
Ranger 2.5 Diesel, Turbo Diesel	'00-	6,3					●	●	2-2,8	Getr.Öl SNS-B 75W-80	-			-	-	n	8,8-9,4
Excursion 6.0, 7.3 V8 Turbo Diesel, 4x4	'00-'05	14,2						●	5,5	Getr.Öl ATF E-S	Spezialprodukt	m	3,3	Getr.Öl BS LSX 75W-140	r	26-31	
Econoline Minibus 6.0, 7.3 V8 Turbo Diesel	'94-'00	14,2						●	5,5	Getr.Öl ATF E-S	Spezialprodukt	qw	3,5	Getr.Öl BS LSX 75W-140	tuv	26-28,5	
E-350 Wagon 7.3 V8	'01-'03	14,2					●	●	5,5	Getr.Öl ATF E-S	Spezialprodukt	w	2,8-3,1	-	j	28,5	
E-350 Wagon 6.0 V8	'03-'03	14,2					●	●	5,5	Getr.Öl ATF E-S	Spezialprodukt		2,8-3,1	-	j	26	
E-350 Wagon 6.0 V8	'04-'10	14,2	HighTronic F 5W-30						-	-	Spezialprodukt	q	2,8-3,1	-	j	26	

- a Verteilergetriebe: Getr.Öl BS LSX 75W-140
- c Sperrdifferential: Getr.Öl BS LSX 75W-140; Getr.Öl HYP LS 85W-90
- e Differential, hinten (4WD): 0,7-1,2 l Getriebeöl BS 75W-90; Getriebeöl SNA-C 75W-90
- g CVT (Automat): Spezialprodukt, bitte auf Originalersatzteil des Herstellers zurückgreifen!
- j Visteon 8.8/9.75: 2,6-2,7 l Getr.Öl HYP LS 85W-90; Getr.Öl BS LSX 75W-140; Differential, konventionell Hinterachse Dana M60 (2,8 l), M70FF (3,1 l), M70HD (4,3 l); Getr.Öl BS LSX 75W-140; Hinterachsgetriebe, Ausgleichgetriebe mit begrenztem Schlupf Dana M60 (2,8 l), M70FF (3,1 l), M70HD (4,3 l); Getr.Öl HYP LS 85W-90
- k PTO (4x4): Getriebeöl BS 75W-90; Getriebeöl SNA-C 75W-90
- m Verteilergetriebe: Getr.Öl ATF E-S; Getriebeöl ATF 55
- o Differential, vorn (4x4): 1,7 l Getriebeöl BS 75W-90
- q Automatikgetriebe 4R70W/4R75E/5R55S: Spezialprodukt, bitte auf Originalersatzteil des Herstellers zurückgreifen!
- s Differential, vorn (4x4): 1,8-2 l Getriebeöl BS 75W-90
- u Sperrdifferential, herkömmliche Hinterachse: 2,0-2,8 l Getr.Öl BS LSX 75W-140
- w Automatikgetriebe 4R100: Getr.Öl ATF E-S; Getriebeöl ATF 55
- y Verteilergetriebe: Getriebeöl ATF 55; Getriebeöl ATF 22
- b Differential, hinten (4WD): Getriebeöl HYP 85W-90
- d Verteilergetriebe: 0,9 l Spezialprodukt, bitte auf Originalersatzteil des Herstellers zurückgreifen!
- f Haldex-Kupplung (4WD): 0,7 l Spezialprodukt, bitte auf Originalersatzteil des Herstellers zurückgreifen!
- h Differential, hinten (4x4): 1,4 l Getriebeöl HYP 85W-90
- l Differentiale, vorn und hinten
- n Sperrdifferential: Getr.Öl BS LSX 75W-140
- p Differential, vorn (4x4): 1,7-2 l Getriebeöl BS 75W-90; Getriebeöl SNA-C 75W-90
- r Differential, vorn (4x4): 1,3-1,8 l Getriebeöl HYP 85W-90
- t Differential, konventionell Hinterachse: 2,8-3,9 l Getriebeöl BS 75W-90; Getriebeöl SNA-C 75W-90
- v Sperrdifferential: 2,8-3,9 l Getr.Öl HYP LS 85W-90
- x Automatikgetriebe 6F35: Spezialprodukt, bitte auf Originalersatzteil des Herstellers zurückgreifen!

**GALLOPER = HYUNDAI**

<b>HONDA</b>																	
Logo 1.3	'99-'02	3,6		●		●			●	1,8	Getr.Öl SNS-B 75W-80	Spezialprodukt					5
Jazz/Fit 1.2i, 1.4i-Dsi	'02-'08	3,6	●	●		●			1,5	Getr.Öl SNS-B 75W-80	Getr.Öl ATF E-S	Getriebeöl ATF J		↔	↔		5-5,5
Jazz/Fit 1.5i-VTEC	'03-'08	3,6	●	●		●	●		1,5	Getr.Öl SNS-B 75W-80	Getr.Öl ATF E-S	Getriebeöl ATF J		↔	↔		3,6
Jazz/Fit 1.2i-VTEC, 1.4i-VTEC, 1.5i-VTEC	'08-'11	3,6	●	●		●			1,5	Getr.Öl SNS-B 75W-80	Getr.Öl ATF E-S	Getriebeöl ATF J	e	↔	↔		4,5
Jazz/Fit 1.2i-VTEC, 1.4i-VTEC, 1.5i-VTEC	'11-	3,6	●	●		●			1,5	Getr.Öl SNS-B 75W-80	Getr.Öl ATF E-S	Getriebeöl ATF J	e	↔	↔		4,5
Jazz Hybrid	'11-	3,2-3,6	SuperTronic E 0W-30; HighTronic F 5W-30						-	-	Spezialprodukt			↔	↔		4,6
Civic 1.3, 1.4, 1.5	'92-'01	3,3-3,5		●		●		●	1,8	Getr.Öl SNS-B 75W-80	a	Getr.Öl ATF E-S	Getriebeöl ATF J	↔	↔		4,5
Civic 1.6 DOHC, 4WD	'92-'01	4		●		●		●	2,2	Getr.Öl SNS-B 75W-80	a	-		↔	↔	b	5
CRX 1.6 ESi, 1.6 Vti, 1.8 Vti, 4WD	'92-'01	3,3-4		●		●		●	1,8/2,3	Getr.Öl SNS-B 75W-80	a	-		↔	↔	b	5
Civic 1.4, 1.6, 1.7	'01-'05	3,2-3,5	●	●		●			1,5	Getr.Öl SNS-B 75W-80	Getr.Öl ATF E-S	Getriebeöl ATF J		↔	↔		4
Civic Hybrid, IMA	'01-'05	3,6	●	●		●			1,5	Getr.Öl SNS-B 75W-80	Getr.Öl ATF E-S	Getriebeöl ATF J		↔	↔		4,1
Civic 2.0i-VTEC Type R	'01-'05	4,5	●	●		●			1,5	Getr.Öl SNS-B 75W-80	-			↔	↔		5,3
Civic 1.4i DSi, 1.8i-VTEC	'05-'08	3,6-3,7	●	●		●			1,4	Getr.Öl SNS-B 75W-80	-			↔	↔		4,6/5,3
Civic 2.0i-VTEC Type R	'07-'08	4,4	●	●		●			1,9	Getr.Öl SNS-B 75W-80	-			↔	↔		4,4
Civic 1.4i-VTEC, 1.8i-VTEC	'08-	3,6-3,7	●	●		●			1,4	Getr.Öl SNS-B 75W-80	-			↔	↔		5,3
Civic 2.0i-VTEC Type R	'08-	4,4	●	●		●			1,9	Getr.Öl SNS-B 75W-80	-			↔	↔		4,4
Civic Hybrid	'05-'11	3,6	●	●		●			-	-	Spezialprodukt			↔	↔		4,8
Civic Hybrid	'11-	3,6	SuperTronic E 0W-30; HighTronic F 5W-30						-	-	Spezialprodukt			↔	↔		4,8
Insight Hybrid	'09-'11	3,6	●	●		●			-	-	Spezialprodukt			↔	↔		4,4
Insight Hybrid	'11-	3,6	SuperTronic E 0W-30; HighTronic F 5W-30						-	-	Spezialprodukt			↔	↔		4,4
Accord 1.8, 2.0, 2.0i, 2.2i	'89-'96	3,8		●		●		●	1,9	Getr.Öl SNS-B 75W-80	a	Getr.Öl ATF E-S	Getriebeöl ATF J	↔	↔		5,5-7

Accord 1.6, 1.8, 2.0, Type R 2.2	'96-'02	3,3-4,8					●		●			●	1,9-2	Getr.Öl SNS-B 75W-80		Getr.Öl ATF E-S	Getriebeöl ATF J			↔	↔			4,5-7			
Accord Coupé 3.0 V6	'98-'02	3,3-4,8					●		●			●	1,9-2	Getr.Öl SNS-B 75W-80		Getr.Öl ATF E-S	Getriebeöl ATF J			↔	↔			4,5-7			
Accord 2.0i, 2.4i	'03-'08	4,2	●	●			●		●			1,9	Getr.Öl SNS-B 75W-80		Getr.Öl ATF E-S	Getriebeöl ATF J			↔	↔			4,5-5,4				
Accord 2.0i, 2.4i	'08-'12	3,7-4,2	●	●			●		●			1,9	Getr.Öl SNS-B 75W-80		Getr.Öl ATF E-S	Getriebeöl ATF J			↔	↔			5,5-6,6				
Accord 2.0i, 2.4i	'12-	3,7-4,2	●	●			●		●			1,9	Getr.Öl SNS-B 75W-80		Spezialprodukt				↔	↔			5,4-6,1				
CR-Z 1.5 i-VTEC IMA S	'10-	3,6	SuperTronic E 0W-30; HighTronic F 5W-30									1,6	Getr.Öl SNS-B 75W-80		Spezialprodukt				↔	↔			4,4				
Prelude 2.0i, 2.2i, VTEC, 2.3i	'92-'00	3,8/4,8					●		●			1,9	Getr.Öl SNS-B 75W-80	a	Getr.Öl ATF E-S	Getriebeöl ATF J			↔	↔			6-8				
Legend 3.2i V6, 3.5i V6	'91-'04	4,6-4,7					●		●			2,3	Getr.Öl SNS-B 75W-80	a	Getr.Öl ATF E-S	Getriebeöl ATF J			1,1	Getriebeöl BS 75W-90			7,5				
Legend 3.5i V6, 3.7i V6	'07-'10	4,3	●	●			●		●			-	-		Getr.Öl ATF E-S	Getriebeöl ATF J		d	0,7-3,9	Getr.Öl ATF E-S			6				
Integra Type R (DC2)	'97-'02	4					●		●			2,3	Getr.Öl SNS-B 75W-80		-				↔	↔			4-6,5				
S2000	'99-'10	4,8	●	●			●		●			1,5	Getr.Öl SNS-B 75W-80		-				0,75	Getriebeöl BS 75W-90			6,5				
NSX 3.0 V6-24 VTEC	'90-'05	5					●		●			2,7	Getr.Öl SNS-B 75W-80	a	Getr.Öl ATF E-S	Getriebeöl ATF J			↔	↔			12				
CR-V 2.0i	'95-'02	3,8					●		●			1,7	Getr.Öl SNS-B 75W-80		Getr.Öl ATF E-S	Getriebeöl ATF J			1	Getr.Öl ATF E-S			3,9				
CR-V 2.0i, 2.4i	'02-'07	4,2	●	●			●		●			1,9	Getr.Öl SNS-B 75W-80		Getr.Öl ATF E-S	Getriebeöl ATF J			1,2	Spezialprodukt			5,3-5,5				
CR-V 2.0i, 2.4i	'07-'11	3,7/4,2	●	●			●		●			2,2	Getr.Öl SNS-B 75W-80		Getr.Öl ATF E-S	Getriebeöl ATF J			1,2	Spezialprodukt			5-6,2				
CR-V 2.0i, 2.4i	'11-	3,7	●	●			●		●			2,2	Getr.Öl SNS-B 75W-80		Getr.Öl ATF E-S	Getriebeöl ATF J			1,2	Spezialprodukt			5-6,2				
HR-V 1.6i, 1.6i-VTEC	'98-'06	3,3	●	●			●		●			1,7-1,8	Getr.Öl SNS-B 75W-80		Spezialprodukt				1	Getr.Öl ATF E-S			2,8-3				
FR-V 1.7i, 2.0i	'04-'07	3,5-4,2	●	●			●		●			1,5-1,8	Getr.Öl SNS-B 75W-80		-				↔	↔			4,4-5				
FR-V 1.8i	'07-'10	3,7	●	●			●		●			2,1	Getr.Öl SNS-B 75W-80		Getr.Öl ATF E-S	Getriebeöl ATF J			↔	↔			4,9				
Stream 1.7, 2.0	'02-'06	3,2/4,2	●	●			●		●			1,5-1,8	Getr.Öl SNS-B 75W-80		Getr.Öl ATF E-S	Getriebeöl ATF J			↔	↔			4,4-1				
Shuttle 2.2i, 2.3i, 4WD	'95-'01	3,8-4,3					●		●			-	-		Getr.Öl ATF E-S	Getriebeöl ATF J			↔	↔		b	7,8				
<b>Diesel</b>																											
Civic 2.0 TDi	'97-'01	4,5					●		●			2,2	Getr.Öl SNS-B 75W-80	-	-				↔	↔				8,5			
Civic 1.7 CTDi	'02-'05	5	●	●			●		●			2	Getr.Öl SNS-B 75W-80	-	-				↔	↔				5,3			
Civic 2.2i-CTDi	'05-'08	5,9	●	●			●		●			2,2	Getr.Öl SNS-B 75W-80	-	-				↔	↔				6,6			
Civic 2.2i-CTDi DPF	'05-'08	5,9					●		●			2,2	Getr.Öl SNS-B 75W-80	-	-				↔	↔				6,6			
Civic 2.2i-CTDi	'08-	5,9					●		●			2,2	Getr.Öl SNS-B 75W-80	-	-				↔	↔				6,6			
Civic 2.2i-CTDi DPF	'08-	5,9					●		●			2,2	Getr.Öl SNS-B 75W-80	-	-				↔	↔				6,6			
FR-V 2.2 CTDi	'05-'10	5,9					●		●			1,8	Getr.Öl SNS-B 75W-80	-	-				↔	↔				6,8			
FR-V 2.2 CTDi DPF	'07-'10	5,9					●		●			1,8	Getr.Öl SNS-B 75W-80	-	-				↔	↔				6,8			
Accord 2.0 TDi	'95-'02	5-5,5	●	●			●		●			2-2,2	Getr.Öl SNS-B 75W-80	-	-				↔	↔				6-7			
Accord 2.2i-CTDi	'03-'08	5,9	●	●			●		●			2,2	Getr.Öl SNS-B 75W-80	-	-				↔	↔				6,8			
Accord 2.2i-CTDi DPF	'05-'08	5,9					●		●			2,2	Getr.Öl SNS-B 75W-80	-	-				↔	↔				6,8			
Accord 2.2i-DTEC DPF	'08-'12	5,5					●		●			2,2	Getr.Öl SNS-B 75W-80		Getr.Öl ATF E-S	Getriebeöl ATF J			↔	↔			6,9				
Accord 2.2i-DTEC DPF	'12-	5,5					●		●			2,2	Getr.Öl SNS-B 75W-80		Spezialprodukt				↔	↔			6,9				
CR-V 2.2i-CTDi	'04-'07	5,9	●	●			●		●			1,9	Getr.Öl SNS-B 75W-80	-	-				1,2	Spezialprodukt				6,8			
CR-V 2.2i-CTDi	'07-'10	5,9	●	●			●		●			2,5	Getr.Öl SNS-B 75W-80	-	-				1,2	Spezialprodukt				7,1			
CR-V 2.2i-CTDi DPF	'07-'10	5,9					●		●			2,5	Getr.Öl SNS-B 75W-80	-	-				1,2	Spezialprodukt				7,1			
CR-V 2.2i-DTEC 4WD	'10-	5,5					●		●			2,5	Getr.Öl SNS-B 75W-80		Getr.Öl ATF E-S	Getriebeöl ATF J			1,2	Spezialprodukt			6,8-6,9				

a Getriebe ab 1996 Modelle: Getriebeöl SNS 75W-80

b Differential, hinten (4WD/4x4): 1 l Getriebeöl BS 75W-90; Getriebeöl HYP Synth 75W-90

d Verteilergetriebe: 1,4 l Getriebeöl BS 75W-90; Getriebeöl HYP Synth 75W-90

e Stufenloses Getriebe CVT: Spezialprodukt, bitte auf Originalersatzteil des Herstellers zurückgreifen!

## HUMMER



H3 3.5, 3.7	'05-'10	5,7	●	●			●		●			2,5	Spezialprodukt		Spezialprodukt				a	-	Getriebeöl BS 75W-90	b		9,5			
H3 5.3 V8	'08-'10	5,7	●	●			●		●			-	-		Spezialprodukt				a	-	Getriebeöl BS 75W-90	b		13,5			
H2 6.0	'02-'07	5,7	●	●			●		●			-	-		Spezialprodukt				a	-	Getriebeöl BS 75W-90	b		16,3			
H2 6.2	'07-'10	5,7	●	●			●		●			-	-		Spezialprodukt				a	-	Getriebeöl BS 75W-90	b		15,8			
<b>Diesel</b>																											
H1 6.5D, 6.5TD	'94-'04	7,6					●		●			-	-		Getr.Öl ATF E-S	Getriebeöl ATF 55			d	-	Getriebeöl BS 75W-90	c		25			

a Verteilergetriebe: 1,4 l Spezialprodukt, bitte auf Originalersatzteil des Herstellers zurückgreifen!

b Differentiale, vorn und hinten

c Differential, vorn: 2 l Getriebeöl BS 75W-90; Getriebeöl SNA-C 75W-90

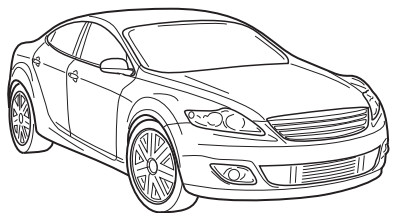
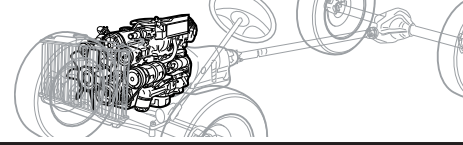
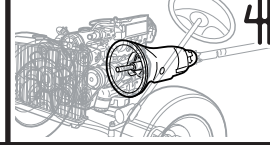
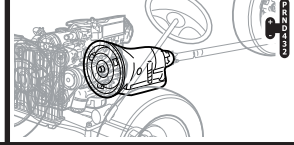
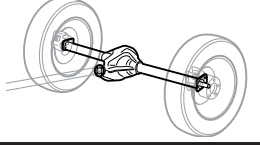
d Verteilergetriebe: 3,3 l Getr.Öl ATF E-S; Getriebeöl ATF 55

			SuperTronic			HighTronic			Blue Tronic 10W-40		Aral	Aral			Aral	
			G 0W-30	0W-40	LL III 5W-30	M 5W-40	5W-40	G 5W-30				Synthese	Mineral			
																
<b>HYUNDAI</b>																
Atos / Amica 1.0i	'97-'03	2,8	●	●	●			●	2,2	Getr.Öl SNS-A 75W-85	Getr.Öl ATF E-S			↔	↔	6
Atos / Amica 1.1i	'03-'05	3,1	●	●	●				2,5	Getr.Öl SNS-A 75W-85	Getr.Öl ATF E-S			↔	↔	4,5
Atos / Amica 1.1i	'05-'08	3,1	●	●	●				2,5	Getr.Öl SNS-A 75W-85	Getr.Öl ATF E-S			↔	↔	4,5
i10 1.0 D-CVVT, 1.1i, 1.1i LPG	'08-	2,7-3,1	●	●	●				1,9	Getr.Öl SNS-A 75W-85	Getr.Öl ATF E-S			↔	↔	3,9-5,1
i10 1.25i	'08-'10	3,5	●	●	●				1,9	Getr.Öl SNS-A 75W-85	Getr.Öl ATF E-S			↔	↔	4,2
i10 1.2i, 1.25i	'10-	3,5	●	●	●				1,9	Getr.Öl SNS-A 75W-85	Getr.Öl ATF E-S			↔	↔	4,2
Getz 1.1, 1.3, 1.6 16V	'02-'09	3-3,3	●	●	●				2,2	Getr.Öl SNS-A 75W-85	Getr.Öl ATF E-S			↔	↔	6-6,5
Getz 1.4i	'05-'09	3,3	●	●	●				2,2	Getr.Öl SNS-A 75W-85	Getr.Öl ATF E-S			↔	↔	6,2
i20 1.2i, 1.4i, 1.6i	'08-'10	3,3-3,5	●	●	●				1,9	Getr.Öl SNS-A 75W-85	Getr.Öl ATF E-S			↔	↔	4,2-5,8
i20 1.2i, 1.4i, 1.6i	'10-'12	3,3-3,5	●	●	●				1,9	Getr.Öl SNS-A 75W-85	Getr.Öl ATF E-S			↔	↔	4,1-5,8
i20 1.2i, 1.4i	'12-	3,3-3,6	●	●	●				1,8-2	Getr.Öl SNS-A 75W-85	Getr.Öl ATF E-S			↔	↔	4,1-5,8
ix20 1.4, 1.6	'10-	3,3	●	●	●				1,8-1,9	Getr.Öl SNS-A 75W-85	Getr.Öl ATF E-S			↔	↔	5,8-5,9
Accent, Pony, Excel 1.3i, 1.5i	'94-'03	3,3	●	●	●			●	2,2	Getr.Öl SNS-A 75W-85	Getr.Öl ATF E-S	Getriebeöl ATF J		↔	↔	5,5
Accent, Excel 1.3i, 1.6i	'03-'06	3,3	●	●	●				2,5	Getr.Öl SNS-A 75W-85	Getr.Öl ATF E-S			↔	↔	6,2-6,5
Accent 1.4 16V, 1.6 16V	'06-'09	3,3	●	●	●				2	Getr.Öl SNS-A 75W-85	Getr.Öl ATF E-S			↔	↔	5,5-5,8
i25 / Accent / Solaris / Verna 1.4L, 1.6L	'10-	3,3	●	●	●				1,9	Getr.Öl SNS-A 75W-85	Getr.Öl ATF E-S			↔	↔	5,3
Matrix 1.6, 1.8 16V	'01-'08	3,3-4	●	●	●				2,2	Getr.Öl SNS-A 75W-85	Getr.Öl ATF E-S			↔	↔	6,2-6,5
Matrix 1.6i	'08-'10	3,3-4	●	●	●				2,2	Getr.Öl SNS-A 75W-85	Getr.Öl ATF E-S			↔	↔	6,2-6,5
Lantra, Elantra 1.5, 1.6, 1.8, 2.0	'90-'00	3-4,4	●	●	●			●	1,8-2,2	Getr.Öl SNS-A 75W-85	Getr.Öl ATF E-S			↔	↔	5,5-6
Elantra, Avante 1.6i, 1.8i, 2.0i	'01-'03	3,3-4	●	●	●			●	2,2	Getr.Öl SNS-A 75W-85	Getr.Öl ATF E-S			↔	↔	5,5-6
Elantra, Avante 1.6i, 1.8i, 2.0i	'03-'06	3,3-4	●	●	●			●	2,2	Getr.Öl SNS-A 75W-85	Getr.Öl ATF E-S			↔	↔	5,5-6
Elantra, Avante 1.6 CVT, 2.0	'06-'10	3,3-4	●	●	●				2	Getr.Öl SNS-A 75W-85	Getr.Öl ATF E-S			↔	↔	6,5-6,6
Elantra / Avante / i35 1.6, 1.8 MPI	'10-	3,3-4	●	●	●				1,8-1,9	Getr.Öl SNS-A 75W-85	Getr.Öl ATF E-S	Getriebeöl ATF J		↔	↔	5,9-6,5
i30 1.4, 1.4 Blue, 1.6, 2.0	'07-'12	3,3-4	●	●	●				1,9-2	Getr.Öl SNS-A 75W-85	Getr.Öl ATF E-S			↔	↔	5,5-6,6
i30 1.4 MPI, 1.6 MPI, 1.6 GDI	'12-	3,3-3,6	●	●	●				1,8-1,9	Getr.Öl SNS-A 75W-85	Getr.Öl ATF E-S	Getriebeöl ATF J		↔	↔	6,4-6,5
i40 1.6 GDI, 2.0 GDI	'11-	3,3-4	●	●	●				1,8-2	Getr.Öl SNS-A 75W-85	Getriebeöl ATF J			↔	↔	6,8-7,1
i40 2.0 MPI	'12-	4	SuperTronic E 0W-30; HighTronic F 5W-30						1,9-2	Getr.Öl SNS-A 75W-85	Getriebeöl ATF J			↔	↔	6,9-7,1
Veloster 1.6 MPI, 1.6 GDI, 1.6 T-GDI	'11-	3,3/4,5	●	●	●				1,8-1,9	Getr.Öl SNS-A 75W-85	Getriebeöl ATF J	k		↔	↔	5-5,2
Coupé 1.6, 1.8, 2.0	'96-'01	4	●	●	●			●	2,2	Getr.Öl SNS-A 75W-85	Getr.Öl ATF E-S			↔	↔	6
Coupé 1.6, 2.0	'02-'06	3,3	●	●	●			●	2,2	Getr.Öl SNS-A 75W-85	-			↔	↔	7
Coupé 1.6, 2.0	'06-'09	3,3/4	●	●	●				-	Getr.Öl SNS-A 75W-85	Getr.Öl ATF E-S			↔	↔	6
Coupé 2.0, 2.7 V6	'02-'06	4/4,5	●	●	●			●	2,2	Getr.Öl SNS-A 75W-85	Getr.Öl ATF E-S			↔	↔	7-8
Genesis Coupé 2.0T	'10-'12	5,3	●	●	●				2	Getr.Öl SNS-A 75W-85	Getriebeöl ATF J		1,45	Getriebeöl BS 75W-90	5,5	
Genesis Coupé 2.0T	'13-	5,3	●	●	●				2,2	Getr.Öl SNS-A 75W-85	Spezialprodukt		1,45	Getriebeöl BS 75W-90	5,5	
Genesis Coupé 3.8 V6	'10-'13	5,2	●	●	●				2,2	Getr.Öl SNS-A 75W-85	Spezialprodukt		1,45	Getriebeöl BS 75W-90	9,6	
Genesis Coupé 3.8 V6	'13-	5,2	●	●	●				2,2	Getr.Öl SNS-A 75W-85	Spezialprodukt		1,45	Getriebeöl BS 75W-90	9,6	
Sonata 1.8i, 2.0i, 2.4i	'93-'05	3,3-4,5	●	●	●			●	1,8-2,5	Getr.Öl SNS-A 75W-85	Getr.Öl ATF E-S			↔	↔	5,5-7,5
Sonata 2.4 16V, 3.3 V6	'05-'10	4/5,6	●	●	●				2,1	Getr.Öl SNS-A 75W-85	Getr.Öl ATF E-S			↔	↔	7,8
Sonata / i45 2.0, 2.0T GDI, 2.4, 2.4 GDI	'11-	4,1-4,6	●	●	●				1,8	Getr.Öl SNS-A 75W-85	Getriebeöl ATF J			↔	↔	6,4-6,5
Grandeur, Azera 3.3 V6, 3.8 V6	'06-'11	5,2	●	●	●				-	-	Getr.Öl ATF E-S			↔	↔	8,6
Grandeur / Azera / i55 2.4 GDI, 3.0 V6 GDI	'11-	4,1-5,2	●	●	●				-	-	Getriebeöl ATF J			↔	↔	6,8-8,4
XG 2.5, 3.0 V6 24V	'99-'05	4	●	●	●			●	2,1	Getr.Öl SNS-A 75W-85	Getr.Öl ATF E-S			↔	↔	8,5
Equus / Centennial 3.8 V6 MPI	'09-'11	5,2	●	●	●				-	-	Getriebeöl ATF J		1,4	Getriebeöl BS 75W-90	10,1	
Equus / Centennial 3.8 V6 MPI, GDI	'11-	5,2	●	●	●				-	-	Spezialprodukt		1,4	Getriebeöl BS 75W-90	10,1	
Equus / Centennial 4.6 V8 MPI	'09-'11	6,5	●	●	●				-	-	Spezialprodukt		1,4	Getriebeöl BS 75W-90	13,5-13,6	
Equus / Centennial 4.6 V8 MPI, 5.0 V8 GDI	'11-	6,5-6,8	●	●	●				-	-	Spezialprodukt		1,4	Getriebeöl BS 75W-90	12,1-13,5	
Trajet 2.0, 2.7 V6	'00-'08	4,3-4,5	●	●	●				2,1	Getr.Öl SNS-A 75W-85	Getr.Öl ATF E-S			↔	↔	7

Tucson 2.0, 2.7 V6	'04-'09	4-4,5	●	●	●	●	●	●	2,1	Getr.Öl SNS-A 75W-85	e	Getr.Öl ATF E-S		e	↔	↔	c	6	
Santa Fe 2.0, 2.4, 2.7 V6, 4WD	'00-'05	4	●	●	●	●	●	●	2,1	Getr.Öl SNS-A 75W-85		Getr.Öl ATF E-S			↔	↔	c	7	
Santa Fe 2.7 V6, 3.3 V6, 4WD	'05-'10	4,5-5,2	●	●	●	●	●	●	1,9	Getr.Öl SNS-A 75W-85		Getr.Öl ATF E-S			↔	↔	f	8,2-9	
Santa Fe 2.4i CVVT	'10-	4,6	●	●	●	●	●	●	1,6-1,7	Getr.Öl SNS-A 75W-85			Getriebeöl ATF J					6,8	
ix35 1.6 GDI, 2.0i CVVT, 2.4i CVVT, 4WD	'10-	3,3-4,1	●	●	●	●	●	●	1,8-2,1	Getr.Öl SNS-A 75W-85	j		Getriebeöl ATF J	j	0,6-0,7			6,8	
Terracan 3.5 V6	'01-'07	4,1	●	●	●	●	●	●	2,5-3,2	Getr.Öl SNS-A 75W-85	d	Getr.Öl ATF E-S	Getriebeöl ATF J	d	1,8/2,8		gh	11	
ix55 / Veracruz 3.8 V6, 4WD	'07-	5,2	●	●	●	●	●	●	-	-	f		Getriebeöl ATF J		0,9			8,5-10,5	
i800 2.4 MPI	'07-	4,3-5,1	●	●	●	●	●	●	1,95	Getr.Öl SNS-A 75W-85		Getr.Öl ATF E-S	Getriebeöl ATF J		1,8-2,4			7,1-10,2	
<b>Diesel</b>																			
i10 1.1 CRDi	'08-'10	5,3		●					1,9	Getr.Öl SNS-A 75W-85		-			↔	↔		5,3	
i10 1.1 CRDi + DPF	'08-'10	5,3		●					1,9	Getr.Öl SNS-A 75W-85		-			↔	↔		5,3	
Getz 1.5 CRDi, 1.5 CRDi VGT	'02-'09	4,8-5,3		●					2,2	Getr.Öl SNS-A 75W-85		Getr.Öl ATF E-S			↔	↔		6,7	
i20 1.1 CRDi, DPF	'12-	4,8		●					1,8-1,9	Getr.Öl SNS-A 75W-85		-			↔	↔		6,8	
i20 1.4 CRDi, 1.6 CRDi	'08-'12	5,3		●					1,9	Getr.Öl SNS-A 75W-85		Getr.Öl ATF E-S			↔	↔		6,3	
i20 1.4 CRDi, 1.6 CRDi + DPF	'08-'12	5,3		●					1,9	Getr.Öl SNS-A 75W-85		Getr.Öl ATF E-S			↔	↔		6,3	
ix20 1.4 CRDi	'10-	5,3		●					1,9	Getr.Öl SNS-A 75W-85		-			↔	↔		6,3	
ix20 1.4 CRDi + DPF	'10-	5,3		●					1,9	Getr.Öl SNS-A 75W-85		-			↔	↔		6,3	
Accent 1.5 CRDi	'06-'09	5,3		●					2	Getr.Öl SNS-A 75W-85		-			↔	↔		5,5-5,8	
Accent / i25 / Solaris / Verna 1.6 CRDi VGT	'12-	5,3		●					1,9	Getr.Öl SNS-A 75W-85		Getr.Öl ATF E-S			↔	↔		6,3	
Accent / i25 / Solaris / Verna 1.6 CRDi VGT DPF	'12-	5,3		●					1,9	Getr.Öl SNS-A 75W-85		Getr.Öl ATF E-S			↔	↔		6,3	
Matrix 1.5 CRDi	'01-'08	4,8-5,3		●					2,2	Getr.Öl SNS-A 75W-85		Getr.Öl ATF E-S	Getriebeöl ATF J		↔	↔		6,3	
Lantra 1.9 D	'96-'00	4,5		●					1,8	Getr.Öl SNS-A 75W-85		-			↔	↔		5,5-6	
Elantra, Avante 2.0 CRDi	'01-'03	5,9		●					2,1	Getr.Öl SNS-A 75W-85		Getr.Öl ATF E-S			↔	↔		8,7	
Elantra, Avante 2.0 CRDi	'03-'06	5,9		●					2,2	Getr.Öl SNS-A 75W-85		-			↔	↔		7,9	
Elantra, Avante 1.6 CRDi	'06-'10	5,3		●					2	Getr.Öl SNS-A 75W-85		Getr.Öl ATF E-S			↔	↔		-	
Elantra, Avante 1.6 CRDi DPF	'06-'10	5,3		●					2	Getr.Öl SNS-A 75W-85		Getr.Öl ATF E-S			↔	↔		-	
i30 1.6, 2.0 CRDi	'07-'12	5,3/5,9		●					1,9-2	Getr.Öl SNS-A 75W-85		-			↔	↔		6,3/7,3	
i30 1.6, 2.0 CRDi + DPF	'07-'12	5,3/5,9		●					1,9-2	Getr.Öl SNS-A 75W-85		-			↔	↔		6,3/7,3	
i30 1.4, 1.6 CRDi	'12-	5,3		●					1,8-2	Getr.Öl SNS-A 75W-85			Getriebeöl ATF J		↔	↔		6,4-6,5	
i30 1.4, 1.6 CRDi + DPF	'12-	5,3		●					1,8-2	Getr.Öl SNS-A 75W-85			Getriebeöl ATF J		↔	↔		6,4-6,5	
i40 1.7 CRDi	'11-	5,3		●					1,8-2	Getr.Öl SNS-A 75W-85			Getriebeöl ATF J		↔	↔		6,9	
i40 1.7 CRDi + DPF	'11-	5,3		●					1,8-1,9	Getr.Öl SNS-A 75W-85			Getriebeöl ATF J		↔	↔		6,9	
Sonata 2.0 CRDi	'06-'10	5,9		●					1,9	Getr.Öl SNS-A 75W-85		Getr.Öl ATF E-S			↔	↔		5	
Grandeur, Azera 2.2 CRDi + DPF	'06-'11	5,9		●					-	-		Getr.Öl ATF E-S			↔	↔		7,9	
Trajet 2.0 CRDi	'02-'07	5,4		●					2,3	Getr.Öl SNS-A 75W-85		Getr.Öl ATF E-S			↔	↔		9,4	
Tucson 2.0 CRDi, VGT	'04-'10	5,4		●					2,1	Getr.Öl SNS-A 75W-85	e	Getr.Öl ATF E-S		e	↔	↔	c	7,9	
Tucson 2.0 CRDi, VGT + DPF	'04-'10	5,4-5,9		●					2,1	Getr.Öl SNS-A 75W-85	e	Getr.Öl ATF E-S		e	↔	↔	c	7,9	
Santa Fe 2.0 CRDi 4WD	'02-'05	5,9		●					2,2	Getr.Öl SNS-A 75W-85	e	Getr.Öl ATF E-S		e	↔	↔	c	8,7	
Santa Fe 2.2 CRDi	'05-'10	5,9		●					1,85	Getr.Öl SNS-A 75W-85		Getr.Öl ATF E-S			↔	↔		8,4	
Santa Fe 2.2 CRDi + DPF	'05-'10	5,9		●					1,85	Getr.Öl SNS-A 75W-85		Getr.Öl ATF E-S			↔	↔		7,8	
Santa Fe 2.2 CRDi	'10-	6,7		●					1,6-1,7	Getr.Öl SNS-A 75W-85			Getriebeöl ATF J		0,9			8,5-9,1	
Santa Fe 2.2 CRDi + DPF	'10-	6,7		●					1,6-1,7	Getr.Öl SNS-A 75W-85			Getriebeöl ATF J		0,9			8,5-9,1	
ix35 1.7 CRDi, 2.0 CRDi VGT, 2.0 CRDi VGT HP	'10-	5,3-8		●					1,8-1,9	Getr.Öl SNS-A 75W-85	j		Getriebeöl ATF J	j	0,6-0,7			8,5	
ix35 1.7 CRDi, 2.0 CRDi VGT, 2.0 CRDi VGT HP, DPF	'10-	5,3-8		●					1,8-1,9	Getr.Öl SNS-A 75W-85	j		Getriebeöl ATF J	j	0,6-0,7			8,5	
Galloper 2.5 TD	'99-'03	6,5		●					2,2-2,7	Getr.Öl SNS-A 75W-85	a	Getr.Öl ATF E-S	Getriebeöl ATF J	a	1,2-2,6			8	
Terracan 2.5 TCI	'01-'04	6,5		●					2,5-3,2	Getr.Öl SNS-A 75W-85	d	Getr.Öl ATF E-S	Getriebeöl ATF J	d	1,8/2,8			10	
Terracan 2.9 CRDi	'04-'07	6		●					2,5-3,2	Getr.Öl SNS-A 75W-85	d	Getr.Öl ATF E-S	Getriebeöl ATF J	d	1,8/2,8			9,3	
ix55 / Veracruz 3.0 CRDi VGT, 4x4	'07-	7,2		●					-	-	f		Getriebeöl ATF J		0,9			9,8-11,5	
i800 2.5 TCI	'07-	5,4		●					1,95	Getr.Öl SNS-A 75W-85		Getr.Öl ATF E-S			1,8-2,4			10-13	
i800 2.5 CRDi WGT	'07-	7,4		●					3-3,2	Getr.Öl SNS-A 75W-85			Getriebeöl ATF J		1,8-2,4			10-13	
i800 2.5 CRDi VGT	'07-	7,4		●					3-3,2	Getr.Öl SNS-A 75W-85			Getriebeöl ATF J		1,8-2,4			10-13	

a Verteilergetriebe: 2,2 l Getriebeöl SNS 75W-80; Getr.Öl EP Synth 75W-90

c Differential, hinten (4WD/4x4): Getriebeöl BS 75W-90; Getriebeöl SNA-C 75W-90

e Verteilergetriebe: Getriebeöl BS 75W-90; Getriebeöl SNA-C 75W-90

g Sperrdifferential: Getriebeöl BS-LSX 75W-140; Getriebeöl HYP LS 85W-90

j Verteilergetriebe: 0,6 l Getriebeöl BS 75W-90; Getriebeöl SNA-C 75W-90

b Sperrdifferential: Getriebeöl BS-LSX 75W-140; Getriebeöl HYP LS 85W-90

d Verteilergetriebe: 1,4 l Getr.Öl ATF E-S; Getriebeöl ATF 55

f Differential, hinten (4WD/4x4): Getriebeöl BS 75W-90; Getriebeöl SNA-C 75W-90

h Differenziale, vorn und hinten

k Getriebe, DCT: 1,9 l Getr.Öl SNS-A 75W-85; Getriebeöl SNS 75W-80

			SuperTronic						HighTronic			Blue Tronic	4	Aral		Aral	Aral				
			G 0W-30	0W-40	LL III 5W-30	M 5W-40	5W-40	G 5W-30	10W-40	Aral		Synthese		Mineral							
															⚠						
<b>INFINITI</b>																					
G20	'91-'96	3,4	●	●		●			●	3,6	Getr.Öl SNS-B 75W-80		Getriebeöl ATF J		↔	↔				6,1-6,5	
G20	'99-'02	3,4	●	●		●			●	-	Getr.Öl EP Synth 75W-90		Getriebeöl ATF J		↔	↔				6,2	
G25, AWD	'11-	4,9	●	●		●			-	-	Getr.Öl SNS-A 75W-85	c	Getriebeöl ATF J	c	-	Getriebeöl BS 75W-90	d			8,8	
G35	'03-'03	5,4	●	●		●			●	2,9	Getr.Öl SNS-A 75W-85		Getriebeöl ATF J		1,4	Getriebeöl BS 75W-90	b			8,5-8,7	
G35	'04-'06	5,4	●	●		●			●	2,9	Getr.Öl SNS-A 75W-85		Getriebeöl ATF J	a	1,4	Getriebeöl BS 75W-90	b			8,5-8,7	
G35, AWD	'07-'08	4,9	●	●		●			●	-	-		Getriebeöl ATF J	a	-	Getriebeöl BS 75W-90	b			9,2	
G37, AWD	'07-	4,9	●	●		●			-	-	-		Getriebeöl ATF J	c	-	Getriebeöl BS 75W-90	d			8,5	
I30	'96-'96	4		●		●			●	4,3-4,8	Getr.Öl SNS-B 75W-80	Getr.Öl ATF E-S	Getriebeöl ATF 55		↔	↔				8,5	
I30	'97-'97	4		●		●			●	4,3-4,8	Getr.Öl SNS-B 75W-80		Getriebeöl ATF J		↔	↔				8,5	
I30	'98-'98	4		●		●			●	4,3-4,8	Getr.Öl EP Synth 75W-90		Getriebeöl ATF J		↔	↔				8,5	
I30	'99-'01	4		●		●			●	4,3-4,8	Getr.Öl EP Synth 75W-90		Getriebeöl ATF J		↔	↔				7,7-8,5	
I35	'02-'03	4	●	●		●			●	-	-		Getriebeöl ATF J		↔	↔				7,7	
I35	'03-'04	4	●	●		●			●	-	-		Getriebeöl ATF J		↔	↔				7,7	
J30	'96-'97	4,3		●		●			●	-	-		Getriebeöl ATF J		-	Getriebeöl BS 75W-90				9,2	
M35, AWD	'05-'07	4,7	●	●		●			-	-	-		Getriebeöl ATF J	a	1,4	Getriebeöl BS 75W-90	b			8,9	
M35, AWD	'08-'10	4,7-4,9	●	●		●			-	-	-		Getriebeöl ATF J	c	1,4	Getriebeöl BS 75W-90	b			8,9-9,2	
M35h	'10-	4,9	●	●		●			-	-	-		Getriebeöl ATF J		-	Getriebeöl BS 75W-90				8,6	
M37	'10-	4,9	●	●		●			-	-	-		Getriebeöl ATF J		-	Getriebeöl BS 75W-90				8,4	
M45	'03-'03	5,6	●	●		●			●	-	-		Getriebeöl ATF J		-	Getriebeöl BS 75W-90				9,8	
M45	'04-'06	5,5-5,6	●	●		●			-	-	-		Getriebeöl ATF J		1,4	Getriebeöl BS 75W-90				9,8-10,4	
M45	'07-'07	5,5	●	●		●			-	-	-		Getriebeöl ATF J		1,4	Getriebeöl BS 75W-90				10,4	
M45, AWD	'08-'10	5,5	●	●		●			-	-	-		Getriebeöl ATF J	c	1,4	Getriebeöl BS 75W-90	b			10,4	
M56, AWD	'10-	6,1	●	●		●			-	-	-		Getriebeöl ATF J	c	-	Getriebeöl BS 75W-90	e			10,9	
Q45	'99-'01	5,3	●	●		●			●	-	-		Getriebeöl ATF J		-	Getriebeöl BS 75W-90				11,7	
Q45	'02-'03	5,3-5,6	●	●		●			●	-	-		Getriebeöl ATF J		-	Getriebeöl BS 75W-90				9,8	
Q45	'04-'06	5,6	●	●		●			-	-	-		Getriebeöl ATF J		-	Getriebeöl BS 75W-90				9,8	
EX35	'08-'09	4,9	●	●		●			-	-	-		Getriebeöl ATF J	a	-	Getriebeöl BS 75W-90	b			9,5	
EX35	'10-	4,9	●	●		●			-	-	-		Getriebeöl ATF J	c	-	Getriebeöl BS 75W-90	d			8,6-9,5	
FX 35, 45	'03-'08	4,7-6,4	●	●		●			-	-	-		Getriebeöl ATF J	a	-	Getriebeöl BS 75W-90	b			8,6	
FX 35	'09-	4,9	●	●		●			-	-	-		Getriebeöl ATF J	c	-	Getriebeöl BS 75W-90	d			9,2	
FX 50	'09-	6,7	●	●		●			-	-	-		Getriebeöl ATF J	c	-	Getriebeöl BS 75W-90	e			11	
QX56, AWD	'04-'10	6,5	●	●		●			-	-	-		Getriebeöl ATF J	a	1,75	Getriebeöl BS 75W-90	e			14,4	
QX56, AWD	'10-	6,5	●	●		●			-	-	-		Getriebeöl ATF J	f	-	Getriebeöl BS 75W-90	e			14,9	

a Verteilergetriebe: Getriebeöl ATF J

c Verteilergetriebe: Getriebeöl ATF J

e Differential, vorn: Getriebeöl BS 75W-90; Getriebeöl SNA-C 75W-90

b Differential, hinten (4WD/4x4): Getriebeöl BS 75W-90; Getriebeöl SNA-C 75W-90

d Differentiale, vorn und hinten

f Verteilergetriebe: Spezialprodukt, bitte auf Originalersatzteil des Herstellers zurückgreifen!

**ISUZU**

Trooper 3.2, 3.5 V6	'92-'04	5,2		●		●			●	3	SuperTronic 0W-40	Getr.Öl ATF E-S	Getriebeöl ATF 55	a	1,5/1,8	Getriebeöl BS 75W-90	b			8,5/9
<b>Diesel</b>																				
Trooper 3.0, 3.1 TD	'92-'04	6		●		●			●	3	SuperTronic 0W-40	-			1,5/1,8	Getriebeöl BS 75W-90	b			8,5

a Verteilergetriebe: 1,5 l BlueTronic 10W-40; Tronic 15W-40

b Differentiale, vorn und hinten; Sperrdifferential: Getr.Öl BS LSX 75W-140



# JAGUAR

X-type 2.0 V6	'01-'05	5,8	●	●	●				1,8	Getriebeöl SNS 75W-80		Getr.Öl ATF E-S			↔	↔	8,3	
X-type 2.5, 3.0 V6	'01-'06	5,8	●	●	●				1,8	Getriebeöl SNS 75W-80	b	Getr.Öl ATF E-S			1,2	Getr.Öl BS LSX 75W-140	8,3	
X-type 2.5, 3.0 V6	'06-'10	5,8	●	●	●				1,8	Getriebeöl SNS 75W-80	b	Getr.Öl ATF E-S			1,2	Getr.Öl BS LSX 75W-140	8,3	
S-type V6, V8, type R	'99-'07	6,3-6,9	●	●	●		●		1,1	Getr.Öl ATF E-S		Spezialprodukt	c		1,5	Getr.Öl BS LSX 75W-140	10-10,5	
XF 3.0 V6, 4.2 V8, 4.2 V8 Supercharged	'08-'09	6-6,5		●	●				-	-		Spezialprodukt			1,3	Getr.Öl BS LSX 75W-140	9,3-12,5	
XF 3.0 V6, 4.2 V8 Supercharged	'09-'10	6,5		●	●				-	-		Spezialprodukt			0,9	Getriebeöl BS 75W-90	9,3	
XF 3.0 V6	'10-'12	6,5	●	●	●				-	-		Spezialprodukt			0,9	Getriebeöl BS 75W-90	9,4	
XF 3.0 V6	'12-	6,5	●	●	●				-	-		Spezialprodukt			0,9	Getriebeöl BS 75W-90	9,25	
XF 4.2 V8, 4.2 V8 Supercharged	'08-'09	6		●	●				-	-		Spezialprodukt			1,25	Getr.Öl BS LSX 75W-140	10,1-12,5	
XF 4.2 V8 Supercharged	'09-'10	6		●	●				-	-		Spezialprodukt			0,9	Getriebeöl BS 75W-90	12,5	
XF 5.0 V8	'09-	7,25							-	-		Spezialprodukt			0,9	Getriebeöl BS 75W-90	12,5	
XF-, XFR 5.0 V8 Supercharged	'09-	7,25							-	-		Spezialprodukt			1,3	Getriebeöl BS 75W-90	12,3-12,5	
XJ 6 3.2, 4.0, Sovereign, Sports	'94-'97	8		●	●		●		1,4	Getr.Öl ATF E-S		Getr.Öl ATF E-S	Getriebeöl ATF 55		2,1	Getr.Öl HYP LS 85W-90	12	
XJR 4.0, Supercharged	'89-'97	8		●	●		●		1,4	Getr.Öl ATF E-S		Getr.Öl ATF E-S	Getriebeöl ATF 55		1,6	Getr.Öl HYP LS 85W-90	12,5	
XJR V8 4.0	'97-'03	7,5		●	●		●		-	-		Spezialprodukt			1,9	Getr.Öl HYP LS 85W-90	12	
XJ12 6.0	'94-'97	10		●	●		●		-	-		Getr.Öl ATF E-S	Getriebeöl ATF 55		1,6	Getr.Öl HYP LS 85W-90	20	
XJ-S 4.0	'93-'96	8		●	●		●		1,4	Getr.Öl ATF E-S		Getr.Öl ATF E-S	Getriebeöl ATF 55		1,3	Getriebeöl BS 75W-90	a 9,9	
XJ-S 6.0 V12	'94-'96	10		●	●		●		-	-		Getr.Öl ATF E-S	Getriebeöl ATF 55		1,3	Getriebeöl BS 75W-90	a 20	
XJ 6 3.0	'03-'06	6,5	●	●	●		●		-	-		Spezialprodukt			1,3	Getr.Öl BS LSX 75W-140	10,3-11,1	
XJ 6 3.0	'06-'09	6,5	●	●	●		●		-	-		Spezialprodukt			1,3	Getr.Öl BS LSX 75W-140	10,3-11,1	
XJ 8 3.2, 4.0	'97-'03	7,5	●	●	●		●		-	-		Spezialprodukt			1,6	Getr.Öl HYP LS 85W-90	10	
XJ 8 3.5, 4.2, 4.2 SC	'03-'06	6	●	●	●		●		-	-		Spezialprodukt			1,3	Getr.Öl BS LSX 75W-140	9,5-10,3	
XJ 8 3.5, 4.2, 4.2 SC	'06-'09	6	●	●	●		●		-	-		Spezialprodukt			1,3	Getr.Öl BS LSX 75W-140	9,5-10,3	
XJ 3.0 V6	'11-	6,5	●	●	●		●		-	-		Spezialprodukt			0,9	Getriebeöl BS 75W-90	8,7	
XJ 5.0 V8	'09-	7,25							-	-		Spezialprodukt			0,9	Getriebeöl BS 75W-90	10,5	
XJ 5.0 S V8 (346 kW, 375 kW)	'09-	7,25							-	-		Spezialprodukt			1,3	Getriebeöl BS 75W-90	10,5	
XK8	'96-'03	7,5		●	●		●		-	-		Spezialprodukt			1,8	Getr.Öl HYP LS 85W-90	9,5	
XK8 4.2	'03-'06	7	●	●	●		●		-	-		Spezialprodukt			1,9	Getr.Öl HYP LS 85W-90	9,5	
XK8 4.2	'06-'09	7	●	●	●		●		-	-		Spezialprodukt			1,9	Getr.Öl HYP LS 85W-90	9,5	
XKR	'97-'03	7,5	●	●	●		●		-	-		Spezialprodukt			1,6	Getr.Öl HYP LS 85W-90	12	
XKR	'03-'06	7	●	●	●		●		-	-		Spezialprodukt			1,9	Getr.Öl HYP LS 85W-90	12	
XK 3.5 V8	'07-'09	6	●	●	●		●		-	-		Spezialprodukt			1,3	Getr.Öl BS LSX 75W-140	9,5	
XK 4.2 V8, XKR Supercharged	'06-'09	7		●	●		●		-	-		Spezialprodukt			1,3	Getr.Öl BS LSX 75W-140	9,5	
XK 5.0 V8	'09-	7,25							-	-		Spezialprodukt			0,9	Getriebeöl BS 75W-90	9,5	
XKR 5.0 V8-, XKR-S 5.0 V8 Supercharged	'09-	7,25							-	-		Spezialprodukt			1,3	Getriebeöl BS 75W-90	13,8	
<b>Diesel</b>																		
X-type 2.0D	'03-'09	6,7							1,8	Getriebeöl SNS 75W-80		-			↔	↔	10	
X-type 2.2D	'05-'10	6,7							1,8	Getriebeöl SNS 75W-80		Spezialprodukt			↔	↔	10	
S-type 2.7D	'04-'07	6,6							1,6	Getr.Öl SNS-B 75W-80		Spezialprodukt			1,5	Getr.Öl BS LSX 75W-140	10,4	
XF 2.2D TD4	'12-	5,86							-	-		Spezialprodukt			0,9	Getriebeöl BS 75W-90	11,6	
XF 2.2D TD4 DPF	'12-	5,86							-	-		Spezialprodukt			0,9	Getriebeöl BS 75W-90	11,6	
XF 2.7D V6	'08-'09	6,6							-	-		Spezialprodukt			1,3	Getr.Öl BS LSX 75W-140	12,4	
XF 3.0D V6, 3.0D V6 S	'09-'12	6,5-6,6							-	-		Spezialprodukt			0,9	Getriebeöl BS 75W-90	9,4-12,5	
XF 3.0D V6, 3.0D V6 S	'12-	6,6							-	-		Spezialprodukt	d		0,9	Getriebeöl BS 75W-90	12,1	
XF 3.0D V6 DPF, 3.0D V6 S DPF	'12-	6,6							-	-		Spezialprodukt	d		0,9	Getriebeöl BS 75W-90	12,1	
XJ 6 2.7D	'05-'09	6,6							-	-		Spezialprodukt			1,3	Getriebeöl SNS 75W-80	13,5	
XJ 3.0D	'09-	6,6							-	-		Spezialprodukt			1,25	Getr.Öl BS LSX 75W-140	e 12-12,5	
XJ 3.0D DPF	'09-	6,6							-	-		Spezialprodukt			1,25	Getr.Öl BS LSX 75W-140	e 12-12,5	

a Sperrdifferential: Getr.Öl BS LSX 75W-140; Getr.Öl HYP LS 85W-90

c 6-Gang Automatikgetriebe: Spezialprodukt, bitte auf Originalersatzteil des Herstellers zurückgreifen!

e Differential, hinten VIN >H31471: 0,9l Getriebeöl BS 75W-90; Getriebeöl SNA-C 75W-90

b Verteilergetriebe: Getr.Öl BS LSX 75W-140

d Automatikgetriebe ZF 8HP70: Spezialprodukt, bitte auf Originalersatzteil des Herstellers zurückgreifen!

Hydraulikanlage (XJ 6, Sovereign (10/1986->), XJ12 (1993->)): LHM+

JEOP	Modell	Jahr	Leistung	SuperTronic						HighTronic			Blue Tronic	Leistung	Aral	Aral	Aral		Leistung	Aral	Aral	Leistung
				G 0W-30	0W-40	LL III 5W-30	M 5W-40	5W-40	G 5W-30	10W-40	Synthese	Mineral										
				●	●	●	●	●	●	●	⚠	⚠										
Compass 1.8, 2.0, 2.4, 4x4	'06-'10	4,3		●	●		●					2,4-2,7	Spezialprodukt		Spezialprodukt			h	↔	↔	g	6,8
Compass 2.0, 2.4, 4x4	'11-	4,26										-	Spezialprodukt		Spezialprodukt			j	↔	↔	k	6,8
Wrangler 2.5, 4.0	'87-'97	3,8/5,7		●			●				●	3,2-3,3	Getriebeöl BS 75W-90	a	Getr.Öl ATF E-S			ab	1,2-1,9	Getriebeöl BS 75W-90	c	8,5-11,5
Wrangler 2.5, 4.0	'97-'02	3,8/5,7		●			●				●	2-2,3	Getr.Öl SNS-B 75W-80	e	Spezialprodukt			e	1,2-1,9	Getr.Öl BS LSX 75W-140	c	8,5/9,9
Wrangler 2.4, 4.0	'02-'07	3,8/5,7	●	●		●						2-2,3	Getr.Öl SNS-B 75W-80	e	Spezialprodukt			e	1,2-1,9	Getr.Öl BS LSX 75W-140	c	8,5/9,9
Wrangler 3.6 4x4	'12-	5,6										-	Getr.Öl SNS-B 75W-80	e	Spezialprodukt			e	-	Getriebeöl BS 75W-90	clm	9,9
Wrangler 3.8, Unlimited 3.8	'07-'11	5,7		●		●						1,5	Getr.Öl SNS-B 75W-80	e	Spezialprodukt			e	1,8-2,25	Getriebeöl BS 75W-90	lm	12
Cherokee/Liberty 3,7 V6	'08-'11	4,7										-	Getr.Öl SNS-B 75W-80	e	Spezialprodukt			e	-	Getr.Öl BS LSX 75W-140	pnq	13-13,3
Cherokee/Liberty 3,7 V6	'12-	4,7										-	-	e	Spezialprodukt			e	-	Getriebeöl BS 75W-90	n	13-13,3
Cherokee 2.5, 4.0	'87-'00	3,8/5,7		●		●					●	3,3	Getriebeöl BS 75W-90	a	Getr.Öl ATF E-S	Getriebeöl ATF 55		a	1,4	Getriebeöl BS 75W-90	c	9,5-11,4
Cherokee 2.4, 3.7 V6	'01-'07	4,7	●	●		●						3,2	Getr.Öl SNS-B 75W-80	e	Getr.Öl ATF E-S	Getriebeöl ATF 55		e	1,2-2,1	Getriebeöl BS 75W-90	c	9,6-11,4
Grand Cherokee 3.6 V6	'11-	5,6										-	-		Spezialprodukt			r	-	Getr.Öl BS LSX 75W-140	c	9,9
Grand Cherokee 4.0, 5.2 V8, 5.9 V8	'92-'99	4,7-5,7		●		●					●	3,3	Getriebeöl BS 75W-90	a	Getr.Öl ATF E-S			a	1,2-1,6	Getriebeöl BS 75W-90	c	11,3-13,5
Grand Cherokee 4.0	'99-'05	5,7		●		●					●	-	-		Spezialprodukt			d	1,8-2,3	Getr.Öl SNS-B 75W-80	c	12,3
Grand Cherokee 4.7 V8	'99-'05	5,7		●		●						-	-		Spezialprodukt			d	1,8-2,3	Getr.Öl BS LSX 75W-140	c	12,3
Grand Cherokee 3.7 V6, 4.7 V8	'05-'10	4,7/5,6	●	●		●						-	-		Spezialprodukt			f	1,7-2,1	Getr.Öl BS LSX 75W-140	c	10
Grand Cherokee 5.7 HEMI V8	'05-'08	6,6	●				●					-	-		Spezialprodukt			f	1,7-2,1	Getr.Öl BS LSX 75W-140	c	13,7
Grand Cherokee 5.7 HEMI V8	'08-'10	6,6										-	-		Spezialprodukt			f	-	Getr.Öl BS LSX 75W-140	c	13,7
Grand Cherokee 5.7 HEMI V8	'11-	6,6										-	-		Spezialprodukt			e	-	Getriebeöl BS 75W-90	st	14,6-15,2
Grand Cherokee SRT 6.1 HEMI V8	'05-'10	6,6	●	●		●						-	-		Spezialprodukt			u	-	Getr.Öl BS LSX 75W-140	c	14
Grand Cherokee 6.4 HEMI V8 SRT8	'12-	6,6	●	●		●						-	-		Spezialprodukt			u	-	Getr.Öl BS LSX 75W-140	c	15,5
Commander 3.7 V6, 4.7 V8	'06-'10	4,7/5,7	●	●		●						-	-		Spezialprodukt			f	1,7-2,1	Getr.Öl BS LSX 75W-140	c	13,7
Commander 5.7 HEMI V8	'05-'10	6,6										-	-		Spezialprodukt			f	1,7-2,1	Getr.Öl BS LSX 75W-140	c	13,7
Patriot 2.0, 2.4, 4x4	'07-	4,26										2,7	Spezialprodukt	j	Spezialprodukt			j	0,5	Getriebeöl BS 75W-90		6,8
<b>Diesel</b>																						
Compass 2.0 CRD	'06-'10	4,3			●							2	Spezialprodukt		-				↔	↔		8
Wrangler 2.8 CRD, Unlimited 2.8 CRD	'07-	6,6		●	●		●					1,5	Getr.Öl SNS-B 75W-80	e	Spezialprodukt			e	-	Getriebeöl BS 75W-90	clmo	12
Wrangler 2.8 CRD DPF, Unlimited 2.8 CRD DPF	'07-	6,6		●	●		●					1,5	Getr.Öl SNS-B 75W-80	e	Spezialprodukt			e	-	Getriebeöl BS 75W-90	clmo	12
(Grand) Cherokee 2.5 TD	'87-'01	6,5									●	3,1	Getriebeöl BS 75W-90	a	Getr.Öl ATF E-S			a	1,4	Getriebeöl BS 75W-90	c	8-11,4
Cherokee 2.8 CRD	'02-'05	6									●	2-2,3	Getr.Öl SNS-B 75W-80		Spezialprodukt			a	1,2-2	Getriebeöl BS 75W-90	c	13,8-16,6
Grand Cherokee 2.7 CRD	'01-'05	6,5									●	-	-		Spezialprodukt			a	1,2-2,2	Getr.Öl BS LSX 75W-140	c	14,2
Grand Cherokee 3.0 CRD	'05-'08	9,5		●	●		●					-	-		Spezialprodukt			f	1,7-2,2	Getr.Öl BS LSX 75W-140	c	13,3
Grand Cherokee 3.0 CRD	'08-'10	9,5		●	●		●					-	-		Spezialprodukt			f	-	Getr.Öl BS LSX 75W-140	c	13,3
Grand Cherokee 3.0 CRD	'11-	-		●	●		●					-	-		Spezialprodukt			e	-	Getriebeöl BS 75W-90	st	-
Grand Cherokee 3.1 TD	'99-'01	7,2									●	-	-		Spezialprodukt			a	1,2-2,3	Getr.Öl BS LSX 75W-140	c	12
Commander 3.0 CRD	'05-'10	9,5		●	●		●					-	-		Spezialprodukt			f	1,7-2,24	Getr.Öl BS LSX 75W-140	c	13,2

a Verteilergetriebe: 1-2,1 | Getr.Öl ATF E-S; Getriebeöl ATF 55

c Differentiale, vorn und hinten

e Verteilergetriebe: Spezialprodukt, bitte auf Originalersatzteil des Herstellers zurückgreifen!

g Differential, hinten (4x4): 0,5 | Getriebeöl BS 75W-90; Getriebeöl SNA-C 75W-90

j Verteilergetriebe: Getriebeöl BS 75W-90; Getriebeöl SNA-C 75W-90

l Hinterachsgetriebe, Ausgleichgetriebe mit begrenztem Schlupf: Getr.Öl BS LSX 75W-140; Getr.Öl HYP LS 85W-90

n Differential, vorn: Getriebeöl BS 75W-90; Getriebeöl SNA-C 75W-90

p Hinterachsgetriebe, Ausgleichgetriebe mit begrenztem Schlupf: Getr.Öl BS LSX 75W-140

b Automatikgetriebe Aisin Warner: Getr.Öl ATF E-S; Getriebeöl ATF 55

d Verteilergetriebe NV247: 1,6 | Spezialprodukt, bitte auf Originalersatzteil des Herstellers zurückgreifen!

f Verteilergetriebe NV140/NV245: 0,7 | 1,8 | Spezialprodukt, bitte auf Originalersatzteil des Herstellers zurückgreifen!

h Verteilergetriebe: 0,54 | Getriebeöl BS 75W-90; Getriebeöl SNA-C 75W-90

k Differential, hinten (AWD): Getriebeöl BS 75W-90; Getriebeöl SNA-C 75W-90

m Differential, hinten, Sperrdifferential, mit Anhängerkupplungssatz: Getr.Öl BS LSX 75W-140

o Differential, vorn, mit Anhängerkupplungssatz: Getr.Öl BS LSX 75W-140

q Vorderachsgetriebe, Ausgleichgetriebe mit begrenztem Schlupf: Getr.Öl BS LSX 75W-140; Getr.Öl HYP LS 85W-90

r Verteilergetriebe: Spezialprodukt, bitte auf Originalersatzteil des Herstellers zurückgreifen!

s Differential, vorn: Getr.Öl BS LSX 75W-140

t Hinterachsgetriebe, Ausgleichgetriebe mit elektronisch begrenztem Schlupf: Getriebeöl BS 75W-90; Getriebeöl SNA-C 75W-90

u Verteilergetriebe: Spezialprodukt, bitte auf Originalersatzteil des Herstellers zurückgreifen!

### KIA

Picanto 1.0, 1.1	'04-'11	3,3	●	●	●				1,9	Getr.Öl SNS-A 75W-85		Spezialprodukt							-
Picanto 1.0 CVVT, 1.2 CVVT	'11-	2,9-3,6	●	●	●				1,9	Getr.Öl SNS-A 75W-85		Getr.Öl ATF E-S							5,1
Pride 1.1, 1.3	'91-'00	3,4		●	●			●	2,5	Getr.Öl SNS-B 75W-80		Getr.Öl ATF E-S	Getriebeöl ATF J						5
Venga 1.4, 1.6 CVVT	'10-	3,7	●	●	●				1,9	Getr.Öl SNS-A 75W-85		Getr.Öl ATF E-S							5,3
Rio 1.3, 1.5	'01-'05	3,4		●	●			●	2,8	Getr.Öl SNS-B 75W-80		Getr.Öl ATF E-S							6
Rio 1.4, 1.6 CVVT	'05-'11	3,3	●	●	●				1,9	Getr.Öl SNS-A 75W-85		Getr.Öl ATF E-S							5,5-5,8
Rio 1.2 CVVT	'11-	3,3	●	●	●				1,9	Getr.Öl SNS-A 75W-85		-							5
Rio 1.4 CVVT	'11-	3,3	●	●	●				1,8-1,9	Getr.Öl SNS-A 75W-85		Getr.Öl ATF E-S							5,3-5,5
Rio 1.6 CVVT	'11-	3,3	●	●	●				1,8-1,9	Getr.Öl SNS-A 75W-85		Getriebeöl ATF J							5-5,2
Sephia, Mentor 1.5, 1.6, 1.8	'93-'98	3,4-3,6		●	●			●	2,7	Getr.Öl EP Synth 75W-90		Getr.Öl ATF E-S	Getriebeöl ATF J						5-6
Sephia, Shuma, Spectra 1.5, 1.6, 1.8	'98-'04	3,4-3,8		●	●			●	2,7-2,8	Getr.Öl SNS-B 75W-80		Getr.Öl ATF E-S	Getriebeöl ATF J						6
Cerato, Spectra 1.6	'04-	3,3	●	●	●				2,2	Getr.Öl SNS-B 75W-80		Getr.Öl ATF E-S							8,1
Cerato, Spectra 2.0 CVVT	'04-	4	●	●	●				2,2	Getr.Öl SNS-B 75W-80		Getr.Öl ATF E-S							8,1
Soul 1.6 CVVT, 2.0 CVVT	'09-	3,3-5,3	●	●	●				1,9	Getr.Öl SNS-A 75W-85		Getr.Öl ATF E-S							6,5-7,2
Cee'd 1.4 CVVT, 1.6 CVVT, 2.0 CVVT	'07-'12	3,3-4	●	●	●				1,9-2	Getr.Öl SNS-A 75W-85		Getr.Öl ATF E-S							5,5-6,6
Cee'd 1.4, 1.6, 1.6 GDI	'12-	3,6	●	●	●				1,8-1,9	Getr.Öl SNS-A 75W-85			Getriebeöl ATF J	j					5,8
Clarus, Credos 1.8	'96-'00	4		●	●			●	2,7	Getr.Öl EP Synth 75W-90		Getr.Öl ATF E-S	Getriebeöl ATF J						6
Clarus, Credos 2.0	'96-'00	3,6	●	●	●			●	2,7	Getr.Öl EP Synth 75W-90		Getr.Öl ATF E-S	Getriebeöl ATF J						6
Magentis, Optima 2.0, 2.5 V6	'01-'06	4,3/4,8		●	●				2,1	Getriebeöl BS 75W-90		Getr.Öl ATF E-S							6,5/7,1
Magentis, Optima 2.0 CVVT, 2.7 V6	'06-	4,3/4,5	●	●	●				2,1	Getr.Öl SNS-A 75W-85		Getr.Öl ATF E-S							6,4-8,3
Opirus, Amanti 3.5 V6	'03-'08	4,3		●	●				-	-		Getr.Öl ATF E-S							10,2
Carens 1.6, 1.8	'99-'06	3,4-4	●	●	●				2,7	Getr.Öl SNS-B 75W-80		Getr.Öl ATF E-S							7,3-7,7
Carens 2.0 CVVT	'06-	4,3	●	●	●				2,1	Getr.Öl SNS-A 75W-85		Getr.Öl ATF E-S							6,7
Joice, Carstar 2.0	'99-'03	4,4		●	●			●	2,5	Getr.Öl SNS-B 75W-80		Getr.Öl ATF E-S							6,5
Carnival, Sedona 2.5 V6	'99-'06	5,8	●	●	●				2,3	Getr.Öl SNS-B 75W-80		Getr.Öl ATF E-S	Getriebeöl ATF J						9,4
Carnival, Sedona 2.7 V6, 3.8 V6	'06-	4,5-5,2	●	●	●				1,9	Getr.Öl SNS-A 75W-85		Getr.Öl ATF E-S							8,2-8,6
Sportage 2.0 (16V), 4WD	'94-'03	4,9		●	●			●	1,3	Getr.Öl SNS-B 75W-80	a	Getr.Öl ATF E-S	Getriebeöl ATF J	a	1,2-1,5	Getriebeöl BS 75W-90	c		6,9-7,5
Sportage 2.0 CVVT, 2.7 V6, 4WD	'04-'10	4/4,5	●	●	●				2,2	Getr.Öl SNS-A 75W-85	e	Getr.Öl ATF E-S		e			f		6/7,8
Sportage 1.6 GDI	'10-	3,3	●	●	●				1,8	Getr.Öl SNS-A 75W-85		-							6,8
Sportage 2.0 CVVT, AWD	'10-'11	4,1	●	●	●				1,8	Getr.Öl SNS-A 75W-85	h		Getriebeöl ATF J	h	0,65	Getriebeöl BS 75W-90			6,8
Sportage 2.0 CVVT, AWD	'11-	5,8	●	●	●				1,8	Getr.Öl SNS-A 75W-85	h		Getriebeöl ATF J	h	0,65	Getriebeöl BS 75W-90			6,8
Sorento 2.4, 3,3 V6, 3,5 V6	'02-'09	4,4-5,2	●	●	●				2,7-3,2	Getr.Öl SNS-B 75W-80	b	Getr.Öl ATF E-S	Getriebeöl ATF J	bg	1,3/1,6	Getriebeöl BS 75W-90	cd		7-11
Sorento 2.4, 2.4 GDI, 4WD	'09-	4,6-5,2	●	●	●				1,9	Getr.Öl SNS-A 75W-85			Getriebeöl ATF J		0,6	Getriebeöl BS 75W-90			7,1-7,4
Sorento 3.5 V6, 4WD	'09-	4,6-5,2	●	●	●				1,8	Getr.Öl SNS-A 75W-85			Getriebeöl ATF J		0,7	Getriebeöl BS 75W-90			9,1
<b>Diesel</b>																			
Picanto 1.1 CRDi VGT	'04-'11	5,3		●	●	●	●		1,9	Getr.Öl SNS-A 75W-85		-							5,3
Venga 1.4, 1.6 CRDi	'10-	5,7		●	●	●	●		1,9	Getr.Öl SNS-A 75W-85		-							6,5
Rio 1.5 CRDi VGT	'05-'11	5,3		●	●	●	●		2	Getr.Öl SNS-A 75W-85		Getr.Öl ATF E-S							5,3-5,5
Rio 1.1 CRDi, 1.4 CRDi	'11-	4,8-5,3		●	●	●	●		1,8-1,9	Getr.Öl SNS-A 75W-85		-							6,4-6,6
Rio 1.1 CRDi + DPF, 1.4 CRDi + DPF	'11-	4,8-5,3		●	●	●	●		1,8-1,9	Getr.Öl SNS-A 75W-85		-							6,4-6,6
Cerato, Spectra 1.5 CRDi, 1.6 CRDi VGT	'05-	5,3		●	●	●	●		2	Getr.Öl SNS-A 75W-85		-							6,8-8
Cerato, Spectra 2.0 CRDi	'04-'07	5,9		●	●	●	●		2,2	Getr.Öl SNS-B 75W-80		Getr.Öl ATF E-S							5
Cee'd 1.6 CRDi VGT, 2.0 CRDi	'07-'12	5,3/5,9		●	●	●	●		1,9-2	Getr.Öl SNS-A 75W-85		-							6,3/7,3
Cee'd 1.6 CRDi VGT + DPF, 2.0 CRDi + DPF	'07-'12	5,3/5,9		●	●	●	●		1,9-2	Getr.Öl SNS-A 75W-85		-							6,3/7,3
Cee'd 1.6 CRDi	'12-	5,3		●	●	●	●		1,8-1,9	Getr.Öl SNS-A 75W-85			Getriebeöl ATF J						5,8
Cee'd 1.6 CRDi DPF	'12-	5,3		●	●	●	●		1,8-1,9	Getr.Öl SNS-A 75W-85			Getriebeöl ATF J						5,8
Magentis, Optima 2.0 CRDi VGT DPF	'06-	5,9		●	●	●	●		1,9	Getr.Öl SNS-A 75W-85		Getr.Öl ATF E-S							8,1-8,3
Carens 2.0 CRDi	'02-'06	5,9		●	●	●	●		2,1	Getr.Öl SNS-B 75W-80		Getr.Öl ATF E-S							7,7
Carens 2.0 CRDi VGT	'05-'10	5,9		●	●	●	●		1,8	Getr.Öl SNS-A 75W-85		Getr.Öl ATF E-S							8-8,2
Carens 2.0 CRDi VGT DPF	'06-'10	5,9		●	●	●	●		1,8	Getr.Öl SNS-A 75W-85		Getr.Öl ATF E-S							8-8,2
Carnival, Sedona 2.9 TDi, HPDi	'99-'06	5,6-5,8		●	●	●	●		2,3	Getr.Öl SNS-B 75W-80		Getr.Öl ATF E-S	Getriebeöl ATF J						9,4
Carnival, Sedona 2.9 CRDi VGT	'06-	6,6		●	●	●	●		1,9	Getr.Öl SNS-A 75W-85		Getr.Öl ATF E-S							9,7-10
Sportage 2.0 TD, 2.2 D, 4WD	'96-'03	6,4/6,6		●	●	●	●		1,3	Getr.Öl SNS-B 75W-80	a	Getr.Öl ATF E-S	Getriebeöl ATF J	a	1,2-1,5	Getriebeöl BS 75W-90	c		6,5-9
Sportage 2.0 CRDi, 4WD	'04-'10	5,9		●	●	●	●		1,9-2,2	Getr.Öl SNS-A 75W-85	e	Getr.Öl ATF E-S		e			f		7,9
Sportage 2.0 CRDi + DPF, 4WD	'04-'10	5,9		●	●	●	●		1,9-2,2	Getr.Öl SNS-A 75W-85	e	Getr.Öl ATF E-S		e			f		7,9

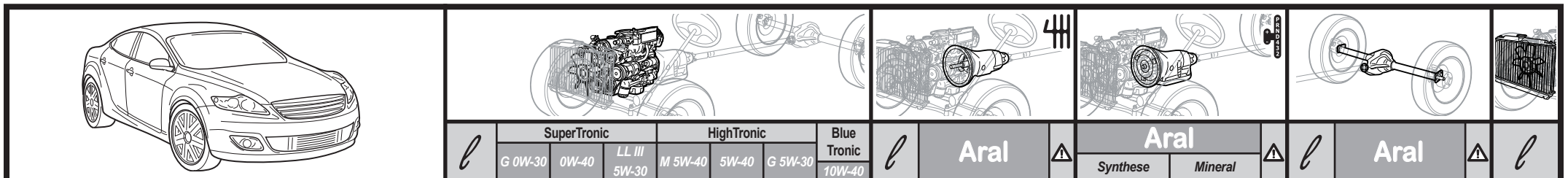
**KIA**

			SuperTronic			HighTronic			Blue Tronic 10W-40		Aral	⚠	Aral		⚠		Aral	⚠	
			G 0W-30	0W-40	LL III 5W-30	M 5W-40	5W-40	G 5W-30					Synthese	Mineral					
Sportage 1.7 CRDi	'10-	5,3		●	●		●	●		1,9	Getr.Öl SNS-A 75W-85			Getriebeöl ATF J		↔	↔		8,5
Sportage 1.7 CRDi DPF	'10-	5,3		●	●		●	●		1,9	Getr.Öl SNS-A 75W-85			Getriebeöl ATF J		↔	↔		8,5
Sportage 2.0 CRDi, AWD	'10-	8		●	●		●	●		1,7	Getr.Öl SNS-A 75W-85	h		Getriebeöl ATF J	h	0,65	Getriebeöl BS 75W-90		8,5
Sportage 2.0 CRDi DPF, AWD	'10-	8		●	●		●	●		1,7	Getr.Öl SNS-A 75W-85	h		Getriebeöl ATF J	h	0,65	Getriebeöl BS 75W-90		8,5
Sorento 2.5 CRDi, VGT	'02-'09	7,4		●	●		●	●		2,7-3,2	Getr.Öl SNS-B 75W-80	b	Getr.Öl ATF E-S	Getriebeöl ATF J	bg	1,3/1,6	Getriebeöl BS 75W-90	cd	10
Sorento 2.0 CRDi, 2.2 CRDi, 4WD	'09-	6,7		●	●		●	●		1,9	Getr.Öl SNS-A 75W-85	h		Getriebeöl ATF J	h	0,6	Getriebeöl BS 75W-90		9,1-9,3
Sorento 2.0 CRDi DPF, 2.2 CRDi DPF, 4WD	'09-	6,7		●	●		●	●		1,9	Getr.Öl SNS-A 75W-85	h		Getriebeöl ATF J	h	0,6	Getriebeöl BS 75W-90		9,1-9,3

- a Verteilergetriebe: Getr.Öl SNS-B 75W-80; Getriebeöl SNS 75W-80  
 c Differentiale, vorn und hinten  
 e Verteilergetriebe: Getriebeöl BS 75W-90; Getriebeöl SNA-C 75W-90  
 g Automatgetriebe A5SR1: Getriebeöl ATF 55; Getriebeöl ATF J  
 j Transaxle-Getriebe, Halbautomatik D6GF1

- b Verteilergetriebe 1,4 l Getr.Öl ATF E-S; Getriebeöl ATF 55  
 d Sperrdifferential: Getr.Öl BS LSX 75W-140; Getr.Öl HYP LS 85W-90  
 f Differential, hinten (AWD): Getriebeöl BS 75W-90; Getriebeöl SNA-C 75W-90  
 h Verteilergetriebe: Getriebeöl BS 75W-90; Getriebeöl SNA-C 75W-90

**LAMBORGHINI**

Gallardo, Superleggera	'03-'08	9,5		●		●				4	Spezialprodukt					↔	↔		e	21
Gallardo LP 550-2, LP 560-4, LP 570-4 Superleggera	'08-	8,3			●					4	Spezialprodukt					↔	↔		e	21
Diablo 5.7 V12, VT	'90-'00	14		●		●			●	3,5	Getriebeöl SNS 75W-80					1,7	Getr.Öl BS LSX 75W-140	a	15	
Diablo 6.0 V12, VT	'00-'02	15		●		●			●	3,5	Getriebeöl BS 75W-90					1,7	Getr.Öl BS LSX 75W-140	a	15	
Murciélago, LP 640, LP 670-4 SV	'02-'11	12-13,5		●		●				3,5	Getriebeöl BS 75W-90					2,5	Getriebeöl BS 75W-90	b	15	
Aventador LP 700-4	'11-	13			●					2,6	Spezialprodukt	d				1,3	Getr.Öl BS LSX 75W-140	c	25	

- a Differential, vorn (4x4): 1 l Getr.Öl BS LSX 75W-140  
 c Differential, vorn (4x4): Getriebeöl BS 75W-90; Getriebeöl SNA-C 75W-90  
 e Differential, vorn: Getriebeöl BS 75W-90

- b Differential, vorn (4x4): 1 l Getr.Öl BS LSX 75W-140  
 d Haldex-Kupplung: Spezialprodukt, bitte auf Originalersatzteil des Herstellers zurückgreifen!

**LANCIA**

Y 1.1, 1.2, 1.4, ECVT	'95-'02	3,5-3,8		●		●		●		1,7-1,9	Getr.Öl EP Synth 75W-90		Spezialprodukt			↔	↔			4,5
Y 1.2 16V	'97-'02	2,8		●		●		●		1,7	Getr.Öl EP Synth 75W-90					↔	↔			4,5
Ypsilon 1.2 8V, 1.2 16V, 1.4 16V	'03-'06	2,8-2,9		●		●		●		1,5	Getr.Öl EP Synth 75W-90					↔	↔			4,8
Ypsilon 1.2 8V, 1.4 8V; 1.4 16V	'06-'11	2,6-2,9		●		●		●		1,7-1,8	Getr.Öl EP Synth 75W-90					↔	↔			4,5-4,8
Ypsilon 1.4 8V LPG	'06-'11	2,6		●		●		●		1,8	Getr.Öl EP Synth 75W-90					↔	↔			4,5
Ypsilon 0.9 TwinAir	'11-	3,2		●		●		●		1,7	Getr.Öl EP Synth 75W-90	c				↔	↔			5,3
Ypsilon 1.2 8V, 1.4 16V	'11-	2,8-2,9		●		●		●		1,7	Getr.Öl EP Synth 75W-90	c				↔	↔			4,4-4,9
Ypsilon 1.2 8V LPG	'11-	2,8		●		●		●		1,7	Getr.Öl EP Synth 75W-90	c				↔	↔			4,9
Musa 1.4 8V, 1.4 16V	'04-	2,8		●		●		●		1,7-2	Getr.Öl EP Synth 75W-90					↔	↔			4,5-6,5
Delta 1.6, 1.8, 2.0-16V	'93-'96	3,8/5,8		●		●		●		2	Getr.Öl EP Synth 75W-90					↔	↔			5,7
Delta 1.6 16V, 1.8 16V	'96-'00	3,8		●		●		●		2	Getr.Öl EP Synth 75W-90					↔	↔			7
Delta HF turbo, 2.0 16V Turbo	'93-'00	5,2		●		●		●		2	Getr.Öl EP Synth 75W-90					↔	↔			7
Delta 1.4 16V TJet	'08-	3,3		●		●		●		2,4	Getr.Öl EP Synth 75W-90					↔	↔			5,9
Delta 1.8 TurboJet	'09-	4,35		●		●		●		-	-		Spezialprodukt			↔	↔			7,3
Dedra 1.6i, 1.8i, 2.0i	'89-'99	3,8/5,8		●		●		●		1,4	Getr.Öl EP Synth 75W-90		Getr.Öl ATF E-S	Getriebeöl ATF 55		↔	↔		a	5,7
Dedra 2.0 Turbo, Integrale	'91-'99	5,2		●		●		●		2/3,8	Getr.Öl EP Synth 75W-90					↔	↔		b	7
Lybra 1.6, 1.8, 2.0	'99-'05	3,8-5		●		●		●		2	Getr.Öl EP Synth 75W-90		Getr.Öl ATF E-S	Getriebeöl ATF 55		↔	↔			7-8,5
Kappa 2.0, 2.4, 2.0 turbo	'94-'01	5,5		●		●		●		2	Getr.Öl EP Synth 75W-90					↔	↔			8,5
Kappa 3.0 V6	'94-'01	7		●		●		●		2	Getr.Öl EP Synth 75W-90		Getr.Öl ATF E-S	Getriebeöl ATF 55		↔	↔			9
Thesis 2.0 20V turbo, 2.4 20V	'01-'08	5,5		●		●		●		1,7	Getr.Öl EP Synth 75W-90		Getr.Öl ATF E-S	Getriebeöl ATF 55		↔	↔			8,3-8,6

Spezialprodukt, bitte auf Originalersatzteil des Herstellers zurückgreifen!

Thesis 3.0 V6 24V	'01-'05	5,9		●		●		●	-	-		Getr.Öl ATF E-S	Getriebeöl ATF 55		↔	↔		12,2
Thesis 3.2 V6 24V	'03-'08	5,9		●		●		●	-	-		Getr.Öl ATF E-S	Getriebeöl ATF 55		↔	↔		12,2
Thema 3.6 V6	'11-	5,6		●			●		-	-		Spezialprodukt			↔	↔		9,5
Flavia 2.4	'12-	4,4		●			●		-	-		Spezialprodukt			↔	↔		7,3
Z 2.0 turbo, 2.0 16V	'95-'02	4,3-5		●		●		●	2,2	Getriebeöl BS 75W-90					↔	↔		8,5
Phedra 2.0 16V, 3.0 V6 24V	'02-'06	4,3-4,8		●		●		●	1,9	Getriebeöl BS 75W-90	Getr.Öl ATF E-S	Getriebeöl ATF 55		↔	↔		7	
Voyager 3.6 V6	'11-	5,6		●			●		-	-		Spezialprodukt			↔	↔		12,6
<b>Diesel</b>																		
Ypsilon 1.3 Mjet 16V	'03-'06	3-3,2							1,8	Getriebeöl BS 75W-90	c	-			↔	↔		6-6,8
Ypsilon 1.3 Mjet 16V	'06-'11	3-3,2							1,5	Getr.Öl EP Synth 75W-90	c	-			↔	↔		6
Musa 1.3 Mjet 16V (55kW), 1.9 Multijet	'04-'08	3-4,4		●			●		1,7-2	Getriebeöl BS 75W-90	-	-			↔	↔		4,5-6,5
Musa 1.3 Mjet (66kW)	'06-	3		●			●		2	Getriebeöl BS 75W-90	c	-			↔	↔		6
Musa 1.6 Mjet	'09-	4,7		●			●		1,6	Getr.Öl SNS-A 75W-85	-	-			↔	↔		7,8
Delta, HPE 1.9 TD	'95-'00	5					●		2	Getriebeöl SNS 75W-80	-	-			↔	↔		9
Delta 1.6 Mjet	'08-	4,6							1,9	Getr.Öl SNS-A 75W-85	-	-			↔	↔		5,9
Delta 1.9 Mjet Twin Turbo	'08-	4,9		●			●		3,1	Getr.Öl EP Synth 75W-90	-	-			↔	↔		7,1
Delta 2.0 Mjet	'08-	4,9							3,1	Getr.Öl EP Synth 75W-90	-	-			↔	↔		7,1
Dedra 1.9 turbo ds	'89-'99	5					●		1,4	Getriebeöl SNS 75W-80	-	-			↔	↔		9
Lybra 1.9, 2.4 JTD	'99-'05	4,8-5,5		●			●		2	Getriebeöl BS 75W-90	-	-			↔	↔		7-7,5
Kappa 2.4 td, JTD	'94-'01	5,3-7		●			●		2	Getriebeöl BS 75W-90	-	-			↔	↔		8,5
Thesis 2.4 JTD	'01-'08	5,5		●			●		1,7	Getriebeöl BS 75W-90	-	-			↔	↔		8,5
Thesis 2.4 Multijet 20V	'03-'08	5		●			●		1,7	Getriebeöl BS 75W-90	-	-			↔	↔		8,4
Thesis 3.0 Multijet	'11-	9,5		●			●		-	-		Spezialprodukt			↔	↔		12
Z 2.1 TD, 2.0 JTD	'95-'00	4,5-6		●			●		1,9	Getriebeöl SNS 75W-80	-	-			↔	↔		9
Z 2.0 JTD 16V	'00-'02	4,75		●			●		1,9	Getriebeöl BS 75W-90	-	-			↔	↔		9
Phedra 2.0, 2.2 JTD 16V	'02-'06	4,75		●			●		2	Getriebeöl BS 75W-90	Getr.Öl ATF E-S	Getriebeöl ATF 55		↔	↔		9,5	
Phedra 2.0 Multijet 16V	'06-'11	5,25		●			●		1,9	Getr.Öl EP Synth 75W-90	Getr.Öl ATF E-S	Getriebeöl ATF 55		↔	↔		9	
Phedra 2.2 Multijet 16V	'08-'11	4,75		●			●		-	Getr.Öl EP Synth 75W-90	Getr.Öl ATF E-S	Getriebeöl ATF 55		↔	↔		9	
Voyager 2.8 Multijet	'11-	6,6		●			●		-	-		Spezialprodukt			↔	↔		16,6

a Differential, Modelle mit Automatikgetriebe: 0,7 | Getriebeöl BS 75W-90; Getriebeöl SNA-C 75W-90

b Differential, hinten (4x4): 1/1,1 | Getriebeöl BS 75W-90; Getriebeöl SNA-C 75W-90

c Hydraulik Bedienung Getriebe: 0,6 | Getr.Öl ATF E-S; Getriebeöl ATF 55

## LAND ROVER

Freelander 1.8 i	'97-'07	4,5		●		●		●	2	Getriebeöl SNS 75W-80	-			0,8	Getriebeöl BS 75W-90	g	5,5	
Freelander 2.5 i V6	'01-'07	5,2		●		●		●	-	-		Spezialprodukt		a	0,8	Getriebeöl BS 75W-90	g	7,8
Freelander 2.0 Si4, AWD	'12-	5,6							2	Spezialprodukt	kl	Spezialprodukt		kl	0,7	Getriebeöl BS 75W-90		4,4
Freelander 3.2 i6	'07-'12	7,5							1,9	Spezialprodukt	kl		Getriebeöl ATF J	kl	0,7	Getriebeöl BS 75W-90		8
Defender 90, 110, 130 2.5	'90-'95	6,9		●		●		●	2,4	Getriebeöl SNS 75W-80	d	-			1,7	Getriebeöl BS 75W-90	g	10,5-11
Defender 90, 110, 130 V8	'90-'02	5,7		●		●		●	2,4	Getriebeöl SNS 75W-80	d	-			1,7	Getriebeöl BS 75W-90	g	13
Discovery 1 2.0 16V	'93-'98	5,3						●	2,7	Getriebeöl SNS 75W-80	d	Getr.Öl ATF E-S	Getriebeöl ATF 55	d	1,7	Getriebeöl BS 75W-90	g	10
Discovery 1, 2 V8, V8i	'89-'05	6,1-6,7		●		●		●	2,7	Getriebeöl SNS 75W-80	d	Getr.Öl ATF E-S	Getriebeöl ATF 55	d	1,7	Getriebeöl BS 75W-90	g	11,3-11,5
Discovery 2 4.6 V8i	'98-'02	6,3		●		●		●	2,6	Getriebeöl SNS 75W-80	m	Getr.Öl ATF E-S	Getriebeöl ATF 55	m	1,6	Getriebeöl BS 75W-90	g	12-13
Discovery 3 4.0 V6	'05-'09	5,7							1,6	Spezialprodukt	h	Spezialprodukt		h	0,6-1,1	Getriebeöl BS 75W-90	e	8,4-11,1
Discovery 3 4.4 V8	'05-'09	7,5							1,6	Spezialprodukt	h	Spezialprodukt		h	0,6-1,1	Getriebeöl BS 75W-90	e	8,4-11,1
Discovery 4 4.0 V6	'09-	5,7							1,6	Spezialprodukt	h	Spezialprodukt		h	0,6-1,1	Getriebeöl BS 75W-90	e	8,4-11,1
Discovery 4 5.0 V8	'09-'11	8							1,6	Spezialprodukt	h	Spezialprodukt		h	0,6-1,1	Getriebeöl BS 75W-90	e	15,9-16,6
Range Rover Evoque 2.0 GTDi, AWD	'11-	5,6							-	-		Spezialprodukt		kl	0,7	Getriebeöl BS 75W-90		8,4-8,6
Range Rover V8 4.0, 4.6	'95-'01	4,9		●		●		●	2,4	Getriebeöl SNS 75W-80	f	Getr.Öl ATF E-S	Getriebeöl ATF 55	f	1,7	Getriebeöl BS 75W-90	g	11,5
Range Rover (Sport) V8 4.2 SC	'05-'09	7,7							-	-		Spezialprodukt		h	0,75-1,1	Getriebeöl BS 75W-90	eg	12
Range Rover (Sport) V8 4.4	'02-'05	8,5		●		●		●	-	-		Spezialprodukt		b	0,75-1	Getriebeöl BS 75W-90	g	13
Range Rover (Sport) V8 4.4	'05-'07	7,7							-	-		Spezialprodukt		h	0,75-1,1	Getriebeöl BS 75W-90	eg	9,3
Range Rover (Sport) V8 5.0, V8 5.0 SC	'09-	8							-	-		Spezialprodukt		h	0,6-1,14	Getriebeöl BS 75W-90	gn	15,9-20,5
<b>Diesel</b>																		
Freelander 2.0 di	'97-'01	4,5		●		●		●	2,2	Getriebeöl SNS 75W-80	-				0,8	Getriebeöl BS 75W-90	g	7
Freelander 2.0 Td4	'01-'07	6,8		●		●		●	1,6	Getriebeöl SNS 75W-80	a	Spezialprodukt		a	0,8	Getriebeöl BS 75W-90	g	7,3
Freelander 2.2 TD4	'07-'10	5,9							1,9	Getriebeöl SNS 75W-80	kl		Getriebeöl ATF J	kl	0,7	Getriebeöl BS 75W-90		8,5
Freelander 2.2 TD4, SD4, eD4	'10-	5,9							2	Spezialprodukt	kl	Spezialprodukt		kl	0,7	Getriebeöl BS 75W-90		5,4-5,9
Freelander 2.2 TD4, SD4, eD4 + DPF	'12-	5,9							2	Spezialprodukt	kl	Spezialprodukt		kl	0,7	Getriebeöl BS 75W-90		5,4-5,9

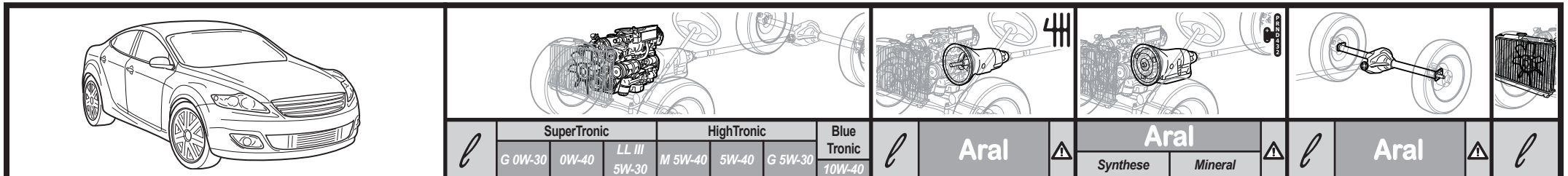

## LAND ROVER

			SuperTronic			HighTronic			Blue Tronic 10W-40	Aral	Aral	Aral		Aral				
			G 0W-30	0W-40	LL III 5W-30	M 5W-40	5W-40	G 5W-30				Synthese	Mineral					
Defender 90, 110, 130 2.5 D, Tdi	'83-'94	6,7		●		●		●	1,8/2,2	Getr.Öl ATF E-S	cd	-		1,7/2,3	Getriebeöl BS 75W-90	g	11	
Defender 90, 110, 130 Tdi	'94-'98	6,7		●		●		●	2,4	Getriebeöl SNS 75W-80	d	-		1,7	Getriebeöl BS 75W-90	g	11	
Defender 90, 110, 130 Td5	'98-'07	8,2	SuperTronic E 0W-30; HighTronic F 5W-30							2,4	Getriebeöl SNS 75W-80	d	-		1,7	Getriebeöl BS 75W-90	g	13
Defender 90 2.2 Td4, 110 2.2 Td4	'11-	7	HighTronic F 5W-30							2,2	Getriebeöl SNS 75W-80	a	-		1,7	Getriebeöl BS 75W-90	g	11,5
Defender 90 2.2 Td4, 110 2.2 Td4 + DPF	'11-	7	HighTronic C 5W-30							2,2	Getriebeöl SNS 75W-80	a	-		1,7	Getriebeöl BS 75W-90	g	11,5
Defender 90 2.4 Td4, 110 Td4, 130 Td4	'07-'11	6,3	HighTronic F 5W-30							2,2	Getriebeöl SNS 75W-80	d	-		1,6/1,7	Getriebeöl BS 75W-90	g	10
Discovery 1, 2 Tdi	'89-'05	6,7-6,9				●		●	2,4	Getriebeöl SNS 75W-80	d	-		1,7	Getriebeöl BS 75W-90	g	11,5	
Discovery 1, 2 Td5	'98-'05	8,2	SuperTronic E 0W-30; HighTronic F 5W-30							2,7	Getriebeöl SNS 75W-80	d	Getr.Öl ATF E-S	Getriebeöl ATF 55	1,7	Getriebeöl BS 75W-90	g	11,5
Discovery 3 2.7 TdV6	'05-'09	5,7	HighTronic F 5W-30							1,6	Spezialprodukt	h	Spezialprodukt	h	0,6-1,1	Getriebeöl BS 75W-90	eg	9,4-13,1
Discovery 4 2.7 TDV6	'09-'10	5,5	HighTronic F 5W-30							1,6	Spezialprodukt	h	Spezialprodukt	h	0,6-1,1	Getriebeöl BS 75W-90	eg	9,4-13,1
Discovery 4 3.0 TDV6, SDV6	'09-	5,9	HighTronic C 5W-30							-	-	h	Spezialprodukt	h	0,6-1,1	Getriebeöl BS 75W-90	eg	15,9-16,6
Range Rover Evoque 2.2 TD4, SD4, AWD	'11-	5,9	HighTronic F 5W-30							2	Spezialprodukt	kl	Spezialprodukt	kl	0,7	Getriebeöl BS 75W-90		8-8,4
Range Rover Evoque 2.2 TD4, SD4, AWD, + DPF	'11-	5,9	HighTronic C 5W-30							2	Spezialprodukt	kl	Spezialprodukt	kl	0,7	Getriebeöl BS 75W-90		8-8,4
Range Rover 2.5 TDi	'94-'01	9,5				●		●	2,4	Getriebeöl SNS 75W-80	f	Getr.Öl ATF E-S	Getriebeöl ATF 55	f	1,7	Getriebeöl BS 75W-90	g	11,5
Range Rover Td6	'02-'06	8,75	●	●				●	-	-		Getr.Öl ATF E-S	Getriebeöl ATF 55	b	1,0	Getriebeöl BS 75W-90	g	9,4-10,4
Range Rover (Sport) TDV6 2.7	'05-'09	5,5	HighTronic F 5W-30							-	-		Spezialprodukt	h	0,6/1,1	Getriebeöl BS 75W-90	eg	9,4-10,4
Range Rover (Sport) TDV6 3.0	'09-'12	5,9	HighTronic F 5W-30							-	-		Spezialprodukt	h	0,6/1,1	Getriebeöl BS 75W-90	eg	11,5-12,8
Range Rover (Sport) TDV6 3.0 DPF	'09-'12	5,9	HighTronic C 5W-30							-	-		Spezialprodukt	h	0,6/1,1	Getriebeöl BS 75W-90	eg	11,5-12,8
Range Rover (Sport) TDV6 3.0	'12-	5,9	HighTronic F 5W-30							-	-		Spezialprodukt	h	0,6/1,1	Getriebeöl BS 75W-90	eg	11,5-12,8
Range Rover (Sport) TDV6 3.0 DPF	'12-	5,9	HighTronic C 5W-30							-	-		Spezialprodukt	h	0,6/1,1	Getriebeöl BS 75W-90	eg	11,5-12,8
Range Rover (Sport) TDV8 3.6	'06-	9,5	HighTronic F 5W-30							-	-		Spezialprodukt	h	0,75/1,14	Getriebeöl BS 75W-90	eg	14-16,6
Range Rover (Sport) TDV8 3.6 DPF	'06-	9,5	HighTronic C 5W-30							-	-		Spezialprodukt	h	0,75/1,14	Getriebeöl BS 75W-90	eg	14-16,6
Range Rover (Sport) TDV8 4.4	'10-	9,5	HighTronic F 5W-30							-	-		Spezialprodukt	h	0,75-1,14	Getriebeöl BS 75W-90	eg	8,2-9,2
Range Rover (Sport) TDV8 4.4 DPF	'10-	9,5	HighTronic C 5W-30							-	-		Spezialprodukt	h	0,75-1,14	Getriebeöl BS 75W-90	eg	8,2-9,2

a Verteilergetriebe: Getriebeöl BS 75W-90; Getriebeöl SNA-C 75W-90

c LT 77 5-Ganggetriebe bis no. 50A.0154645D (bis 1986); 2,2 l Getr.Öl ATF E-S; Getriebeöl ATF 55

e Differential, hinten+ETM: 1,5 l Getr.Öl BS LSX 75W-140

g Differentiale, vorn und hinten

k Haldex-Kupplung: 0,65 l Spezialprodukt, bitte auf Originalersatzteil des Herstellers zurückgreifen!

m Verteilergetriebe: 2,8 l Getriebeöl BS 75W-90; Getriebeöl SNA-C 75W-90

b Verteilergetriebe: 1 l Spezialprodukt, bitte auf Originalersatzteil des Herstellers zurückgreifen!

d Verteilergetriebe (LT 230): 2,3-2,8 l Getr.Öl EP Synth 75W-90; Getriebeöl EP 85W-90

f Verteilergetriebe: 2,4 l Getr.Öl ATF E-S; Getriebeöl ATF 55

h Verteilergetriebe: 1,5 l Spezialprodukt, bitte auf Originalersatzteil des Herstellers zurückgreifen!

l Verteilergetriebe: 0,8 l Spezialprodukt, bitte auf Originalersatzteil des Herstellers zurückgreifen!

n Differential, hinten+ETM: 1,5 l Getriebeöl BS 75W-90

## LANDWIND

X6 2.0, 2.4, 4x4	'05-'08	-		●		●		●	-	HighTronic M 5W-40		-				Getriebeöl BS 75W-90	a	-
CV9 1.6	'11-	3,5		●		●		●	2,3	Getriebeöl SNS 75W-80		-		↔	↔			8
CV9 2.0	'11-	5,5		●		●		●	1,85	Getriebeöl SNS 75W-80		-		↔	↔			8
<b>Diesel</b>				●														
X6 2.8 TD, 4x4	'05-'08	-		●			●	●	-	HighTronic M 5W-40		-				Getriebeöl BS 75W-90	a	-

## LEXUS

CT200h	'11-	4,2	●	●		●			-	-		Spezialprodukt			↔	↔		6,5-6,9
IS 200, 200 Compressor, 300	'98-'05	4,1-5,4	●	●		●			1,9	Getr.Öl SNS-B 75W-80		Getr.Öl ATF E-S	Getriebeöl ATF J	-	-	Getriebeöl BS 75W-90		7-7,8
IS 250	'06-'11	6,3	●	●		●			1,8	Getr.Öl SNS-B 75W-80		Spezialprodukt				Getriebeöl BS 75W-90		9,1
IS F	'08-	9,3	●	●		●			-	-		Spezialprodukt			1,3-1,4	Getriebeöl BS 75W-90		11,9
GS 300, 400, 430	'93-'05	5-6,3	●	●		●		●	-	-		Getr.Öl ATF E-S	Getriebeöl ATF J	1,4	Spezialprodukt			7,5-11
GS 300, 430	'05-'08	5,2/6,3	●	●		●			-	-		Spezialprodukt			1,2	Getriebeöl BS 75W-90		9,1
GS 450h	'06-	6,3	●	●		●			-	-		Spezialprodukt			1,35	Getriebeöl BS 75W-90		12,2

GS 460	'08-'10	8,6	●	●	●					-	-	Spezialprodukt			1,3-1,4	Getriebeöl BS 75W-90		10,8	
LS 400, 430	'90-'03	4,6-5,1		●	●					-	-	Getr.Öl ATF E-S	Getriebeöl ATF J		1,3-1,9	Getriebeöl BS 75W-90		9-10,5	
LS 430	'03-'06	4,6	●	●	●					-	-	Spezialprodukt			1,35	Getriebeöl BS 75W-90		9,5-10,1	
LS 460 2WD	'06-	8,6	●	●	●					-	-	Spezialprodukt			1,3-1,4	Getriebeöl BS 75W-90		11,8	
LS 460 AWD	'08-	9	●	●	●					-	-	Spezialprodukt		g	1,3-1,4	Getr.Öl HYP LS 85W-90	h	11,1	
LS 600h	'07-	8,6	●	●	●					-	-	Spezialprodukt		e	0,7-1,4	Getriebeöl BS 75W-90	b	13,7	
SC 430	'01-'02	5,3		●	●			●		-	-	Getr.Öl ATF E-S	Getriebeöl ATF J		1,4	Getriebeöl BS 75W-90		10	
SC 430	'02-'04	5,3	●	●	●			●		-	-	Getr.Öl ATF E-S	Getriebeöl ATF J		1,4	Getriebeöl BS 75W-90		10	
SC 430	'04-'05	5,3	●	●	●			●		-	-	Getr.Öl ATF E-S	Getriebeöl ATF J		1,4	Getriebeöl BS 75W-90		10	
SC 430	'05-'10	5,3	●	●	●					-	-	Spezialprodukt			1,4	Getriebeöl BS 75W-90		10	
RX 300	'01-'03	4,7		●	●			●		-	-	Getr.Öl ATF E-S	Getriebeöl ATF J		0,9	Getriebeöl BS 75W-90	d	9,2	
RX 300	'03-'06	4,7	●	●	●					-	-	Getr.Öl ATF E-S	Getriebeöl ATF J		0,9	Getriebeöl BS 75W-90	d	9,6	
RX 350	'06-	6,1	●	●	●					-	-	Spezialprodukt			-	Getriebeöl BS 75W-90	d	8,4	
RX 400h	'05-'09	4,7	●	●	●					-	-	Spezialprodukt			1,8-2	Spezialprodukt		13,7	
RX 450h 2WD, Hybrid	'09-	6,1	●	●	●					-	-	Spezialprodukt			-	-	k	11,7	
LX 470	'97-'97	6,8		●	●			●		-	-	Getr.Öl ATF E-S	Getriebeöl ATF J	a	1,6-3,2	Getriebeöl BS 75W-90	bc	14,8	
GX 460	'09-	7,8	●	●	●			●		-	-	Spezialprodukt		i	1,4-2,7	Getriebeöl BS 75W-90	b	15,4	
LFA	'11-	17	Spezialprodukt, bitte auf Originalersatzteil des Herstellers zurückgreifen!							5,3	Getriebeöl BS 75W-90	-			↔	↔			25,5
<b>Diesel</b>																			
IS 220d	'05-	6	●	●			●			1,8	Getr.Öl SNS-B 75W-80	-			1,4	Getriebeöl BS 75W-90		8,9	

a Verteilergetriebe: 1,3 l Getr.Öl SNS-B 75W-80; Getriebeöl SNS 75W-80

c Sperrdifferential: Getr.Öl BS LSX 75W-140; Getr.Öl HYP LS 85W-90

e Verteilergetriebe: 0,7 l Getriebeöl BS 75W-90

h Differential, vorn (4x4): 0,7-0,8 l Getriebeöl BS 75W-90

k Differential, hinten (4x4): 1,8 l Spezialprodukt, bitte auf Originalersatzteil des Herstellers zurückgreifen!

b Differentiale, vorn und hinten

d Verteilergetriebe: 0,9 l Getriebeöl BS 75W-90; Getriebeöl HYP Synth 75W-90

g Verteilergetriebe: 0,7 l Getr.Öl BS LSX 75W-140; Getr.Öl HYP LS 85W-90

i Verteilergetriebe: 1,4 l Spezialprodukt, bitte auf Originalersatzteil des Herstellers zurückgreifen!

## LOTUS

Elise	'95-'03	4,5		●	●			●		2,1	Getriebeöl SNS 75W-80	-			↔	↔			10,5
Elise 111R	'04-'06	4,4		●	●			●		2,3	Getr.Öl SNS-B 75W-80	-			↔	↔			-
Esprit S4, S4s, Sport 300	'92-'04	5,7		●	●			●		3	Spezialprodukt	-			↔	↔			12
Esprit GT3, V8	'96-'04	6,3-6,5	Spezialprodukt, bitte auf Originalersatzteil des Herstellers zurückgreifen!							3	Getr.Öl EP Synth 75W-90	-			↔	↔			15-24

## MASERATI

Ghibli, Quattroporte 2.0 V6 24V	'92-'01	5,5	Spezialprodukt, bitte auf Originalersatzteil des Herstellers zurückgreifen!							1,7	Getriebeöl SNS 75W-80	-			1,4	Getr.Öl BS LSX 75W-140		8,5	
Ghibli, Quattroporte 2.8 V6 24V	'92-'01	5,5	Spezialprodukt, bitte auf Originalersatzteil des Herstellers zurückgreifen!							1,7	Getriebeöl SNS 75W-80	a	Spezialprodukt		1,4	Getr.Öl BS LSX 75W-140		8,5	
Quattroporte 3.2 V8 32V	'95-'01	6,5	Spezialprodukt, bitte auf Originalersatzteil des Herstellers zurückgreifen!							1,7	Getriebeöl SNS 75W-80	a	Spezialprodukt		1,7	Getr.Öl BS LSX 75W-140		14	
Quattroporte	'04-'08	9,5		●	●			●		2,7	Getriebeöl BS 75W-90	-			↔	↔			13
Quattroporte, S, GT S	'08-	9		●	●			●		-	-	Getr.Öl ATF E-S	Getriebeöl ATF 55		1	Getr.Öl BS LSX 75W-140		13	
3200 GT	'98-'02	7	Spezialprodukt, bitte auf Originalersatzteil des Herstellers zurückgreifen!							1,7	Getriebeöl SNS 75W-80	-			1,7	Getr.Öl BS LSX 75W-140		14	
Coupé/Spyder	'01-'07	7,8		●	●			●		2,8	Getriebeöl BS 75W-90	-			↔	↔			11,5
GranTurismo, GranTurismo S	'07-	9		●	●			●		3,1	Getriebeöl BS 75W-90	-			1,1	Getr.Öl BS LSX 75W-140		12,5-13	

a 6-Ganggetriebe: 2,3 l Getr.Öl ATF E-S; Getriebeöl ATF 55

## MAYBACH

Maybach 57, 62	'02-	9					●			-	-	Spezialprodukt			1,9	Getr.Öl BS LSX 75W-140		17
Maybach 57 S	'02-	10,5					●			-	-	Spezialprodukt			1,9	Getr.Öl BS LSX 75W-140		15,1
Maybach 62 S	'06-	-					●			-	-	Spezialprodukt			1,6-1,9	Getr.Öl BS LSX 75W-140		17

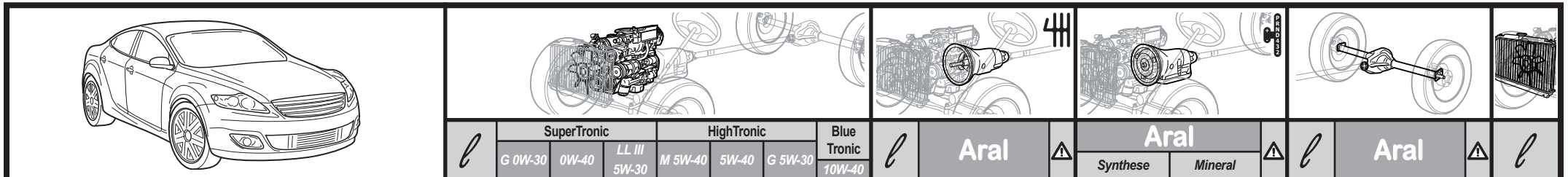

			SuperTronic			HighTronic			Blue Tronic	Aral		Aral		Aral				
			G 0W-30	0W-40	LL III 5W-30	M 5W-40	5W-40	G 5W-30	10W-40	l	⚠	Synthese	Mineral	⚠	l	⚠	l	
<b>MAZDA</b>																		
121 1.1, 1.3	'88-'96	3,3		●		●	●	●	●	2,5	Getr.Öl SNS-B 75W-80	-			↔	↔	5	
121 1.25 16V, 1.3	'96-'02	4/3,3		●		●	●	●	●	2,8	Getr.Öl SNS-B 75W-80	Getr.Öl ATF E-S			↔	↔	7,6	
Demio 1.3 16V, 1.5 16V	'96-'02	3,2		●		●	●	●	●	2,7	Getr.Öl SNS-B 75W-80	Getr.Öl ATF E-S	Getriebeöl ATF 55		↔	↔	6	
2 1.25 16V, 1.4 16V, 1.6 16V	'02-'07	3,8-4,3	●	●		●	●	●	●	2,3	Getr.Öl SNS-B 75W-80	-			↔	↔	5	
2 1.3, 1.3 HP	'07-'08	3,9	●	●		●	●	●	●	3	Getr.Öl SNS-B 75W-80	Spezialprodukt			↔	↔	5,3-5,5	
2 1.3, 1.3 HP	'09-'10	3,9	●	●		●	●	●	●	2,9,3	Getr.Öl EP Synth 75W-90	Spezialprodukt			↔	↔	5,3-5,5	
2 1.3, 1.3 HP	'10-	3,9	●	●		●	●	●	●	2,9	Getr.Öl EP Synth 75W-90	Spezialprodukt			↔	↔	5,3-5,5	
2 1.5	'07-'08	3,9	●	●		●	●	●	●	3	Getr.Öl SNS-B 75W-80		Getriebeöl ATF J		↔	↔	5-5,1	
2 1.5	'09-'10	3,9	●	●		●	●	●	●	2,9,3	Getr.Öl EP Synth 75W-90		Getriebeöl ATF J		↔	↔	5-5,1	
2 1.5	'10-	3,9	●	●		●	●	●	●	2,9	Getr.Öl EP Synth 75W-90		Getriebeöl ATF J		↔	↔	5-5,1	
323, 323F 1.3i, 1.5i, 1.8i, 2.0i V6	'95-'01	2,9-4		●		●	●	●	●	2,7	Getr.Öl SNS-B 75W-80	Getr.Öl ATF E-S	Getriebeöl ATF 55		↔	↔	6-7	
323 1.3i, 1.6i, 2.0i	'01-'03	2,9-3,5		●		●	●	●	●	2,7	Getr.Öl SNS-B 75W-80	Getr.Öl ATF E-S	Getriebeöl ATF 55		↔	↔	6-7,5	
3 1.4, 1.6, 2.0	'03-'09	3,9-4,3	●	●		●	●	●	●	2,9,3	Getr.Öl SNS-B 75W-80		Getriebeöl ATF J		↔	↔	5,5-7,5	
3 2.3 MPS	'06-'09	5,7	●	●		●	●	●	●	2,5	Getr.Öl SNS-B 75W-80	-			↔	↔	7,5	
3 1.6, 2.0	'09-	3,9-4,3	●	●		●	●	●	●	2,9	Getr.Öl EP Synth 75W-90		Getriebeöl ATF J		↔	↔	6-7,5	
3 2.3 MPS	'09-	5,7	●	●		●	●	●	●	2,4-2,6	Getr.Öl EP Synth 75W-90	-			↔	↔	7,5	
5 1.8, 2.0	'05-'08	4,3	●	●		●	●	●	●	2,9	Getr.Öl SNS-B 75W-80		Getriebeöl ATF J		↔	↔	6,5	
5 1.8, 2.0	'09-'10	4,3	●	●		●	●	●	●	2,8	Getr.Öl EP Synth 75W-90		Getriebeöl ATF J		↔	↔	6,5-7	
5 1.8, 2.0, 2.0 DISI	'10-	4,3	●	●		●	●	●	●	2,9	Getr.Öl EP Synth 75W-90		Getriebeöl ATF J		↔	↔	6,1	
626 1.8, 2.0, 2.5 V6, 4WD	'92-'02	3,5-4,1		●		●	●	●	●	2,6-3,4	Getr.Öl SNS-B 75W-80	d	Getr.Öl ATF E-S	Getriebeöl ATF 55	↔	↔	c 6,9-7,5	
Xedos 6 1.6i, 2.0i V6	'92-'00	3,6/4		●		●	●	●	●	2,7	Getr.Öl SNS-B 75W-80	Getr.Öl ATF E-S	Getriebeöl ATF 55		↔	↔	6-7,5	
6 1.8, 2.0 (S-VT), 2.3 S-VT, AWD	'02-'07	3,5-4,3	●	●		●	●	●	●	2,9	Getr.Öl SNS-B 75W-80		Getriebeöl ATF J	f	↔	↔	a 7,5	
6 2.3 DISI Turbo	'06-'08	5,7	●	●		●	●	●	●	2,6	Getr.Öl SNS-B 75W-80	h	-		↔	↔	k -	
6 1.8, 2.0, 2.5	'07-'08	4,3-5	●	●		●	●	●	●	2,8	Getr.Öl SNS-B 75W-80		Getriebeöl ATF J		↔	↔	7,5	
6 1.8, 2.0, 2.5	'09-'10	4,3-5	●	●		●	●	●	●	2,8	Getr.Öl EP Synth 75W-90		Getriebeöl ATF J		↔	↔	7,5	
6 1.8, 2.0, 2.5, 2.0 DISI	'10-	4,3-5	●	●		●	●	●	●	2,8-2,9	Getr.Öl EP Synth 75W-90		Getriebeöl ATF J		↔	↔	7,5	
Xedos 9 2.0, 2.3 V6 Miller Cycle, 2.5 V6	'93-'02	4-4,1		●		●	●	●	●	2	Getr.Öl ATF E-S	Getr.Öl ATF E-S	Getriebeöl ATF 55		↔	↔	7,5	
MPV 3.0 18V	'88-'99	4,8		●		●	●	●	●	2,5	Getr.Öl SNS-B 75W-80	-			1,5	Getriebeöl BS 75W-90	9,4	
MPV 2.0 16V	'99-'02	3,5		●		●	●	●	●	2,7	Getr.Öl SNS-B 75W-80	Getr.Öl ATF E-S	Getriebeöl ATF 55		↔	↔	11,2-12	
MPV 2.5 V6-24V	'99-'02	5,2		●		●	●	●	●	2,7	Getr.Öl SNS-B 75W-80	Getr.Öl ATF E-S	Getriebeöl ATF 55		↔	↔	12	
MPV 2.3 16V, 3.0 V-24V	'03-'05	3,5/5,2	●	●		●	●	●	●	2,7	Getr.Öl SNS-B 75W-80	Getr.Öl ATF E-S	Getriebeöl ATF 55		↔	↔	8,8-12,4	
Premacy 1.8, 2.0	'99-'05	3,5	●	●		●	●	●	●	2,7	Getr.Öl SNS-B 75W-80	Getr.Öl ATF E-S	Getriebeöl ATF 55		↔	↔	7,5	
Tribute 2.0	'01-'05	4,3	●	●		●	●	●	●	2,2-2,7	Getr.Öl SNS-B 75W-80	f	-		↔	↔	b 8	
Tribute 2.3	'04-'05	4,5		●		●	●	●	●	-	Getr.Öl SNS-B 75W-80	f	-		↔	↔	b 7,5	
Tribute 3.0 V6	'00-'05	5,2		●		●	●	●	●	-	-	Getr.Öl ATF E-S	Getriebeöl ATF 55	e	↔	↔	b 10	
CX-5 2.0 SKYACTIVE-G, 4WD	'12-	4,2	●	●		●	●	●	●	1,7	Getr.Öl EP Synth 75W-90	n	Spezialprodukt		n	0,45	Getriebeöl BS 75W-90	7,4
CX-7 2.3 DISI Turbo	'07-'08	5,7	●	●		●	●	●	●	2,6	Getr.Öl SNS-B 75W-80	n		Getriebeöl ATF J	n	1	Getriebeöl BS 75W-90	9
CX-7 2.3 DISI Turbo	'09-	5,7	●	●		●	●	●	●	2,6	Getr.Öl EP Synth 75W-90	n		Getriebeöl ATF J	n	1	Getriebeöl BS 75W-90	9
CX-7 2.5	'09-	5,5	●	●		●	●	●	●	-	-		Getriebeöl ATF J	n	1	Getriebeöl BS 75W-90	9	
CX-9 3.7 V6	'09-	5,2	●	●		●	●	●	●	-	-		Getriebeöl ATF J	e	1	Getriebeöl BS 75W-90	12,9-13,3	
MX-3 1.6i, 1.8i V6	'92-'98	3,3/4		●		●	●	●	●	2,7	Getr.Öl SNS-B 75W-80	Getr.Öl ATF E-S	Getriebeöl ATF 55		↔	↔	6/7,5	
MX-5, Miata 1.6, 1.8	'93-'00	3,8-4		●		●	●	●	●	2	Getr.Öl SNS-B 75W-80	Getr.Öl ATF E-S	Getriebeöl ATF 55		0,7-1	Getriebeöl BS 75W-90	6	
MX-5, Miata 1.6, 1.8	'00-'05	3,8		●		●	●	●	●	2	Getr.Öl SNS-B 75W-80	Getr.Öl ATF E-S	Getriebeöl ATF 55		0,7-1	Getriebeöl BS 75W-90	6	
MX-5, Miata 1.8, 2.0	'05-'11	4,6	●	●		●	●	●	●	2-2,1	Getr.Öl SNS-B 75W-80		Getriebeöl ATF J		0,6-0,8	Getriebeöl BS 75W-90	7,5	
MX-5, Miata 1.8, 2.0	'11-	4,6	●	●		●	●	●	●	2-2,1	Getr.Öl SNS-B 75W-80		Getriebeöl ATF J		0,6-0,8	Getriebeöl BS 75W-90	7,5	
MX-6 2.0i, 2.5i V6	'92-'96	3,5/4		●		●	●	●	●	2,7	Getr.Öl SNS-B 75W-80	Getr.Öl ATF E-S	Getriebeöl ATF 55		↔	↔	7,5	
RX-8 (141 kW), HP	'03-'11	3,5	SuperTronic E 0W-30; HighTronic F 5W-30						1,7-2,5	Getr.Öl SNS-B 75W-80	Getr.Öl ATF E-S	Getriebeöl ATF 55		1,3	Getriebeöl BS 75W-90	10		



RX-8 (158 kW) <b>Diesel</b>	'06-'11	3,5	SuperTronic E 0W-30; HighTronic F 5W-30							-	-				Getriebeöl ATF J		1,3	Getriebeöl BS 75W-90	9,8
121 1.8 D	'96-'02	4,5				●			●	2,8	Getriebeöl SNS 75W-80	-			↔	↔			9,3
2 1.4 CiTD	'02-'07	3,8		●				●	●	2,3	Getriebeöl SNS 75W-80	-			↔	↔			5,5
2 1.4 CiTD	'07-'11	3,8		●				●	●	2,3	Getriebeöl SNS 75W-80			Getriebeöl ATF J	↔	↔			5,5
2 1.6 CiTD	'09-	3,9		●				●	●	2,3	Getriebeöl SNS 75W-80			Getriebeöl ATF J	↔	↔			6,5
323 1.7 Diesel, 2.0 DiTD	'90-'03	4,5/4,7		●		●		●	●	2,7	Getr.Öl SNS-B 75W-80	Getr.Öl ATF E-S		Getriebeöl ATF 55	↔	↔			6-9
323 2.0 Diesel	'96-'01	5,4-5,8		●		●		●	●	2,7	Getr.Öl SNS-B 75W-80	-			↔	↔			9
3 1.6 CiTD	'04-'09	3,8		●				●	●	1,9	Spezialprodukt	-			↔	↔			8,5-9
3 2.0 CiTD	'07-'09	4,1		●				●	●	2,9	Getr.Öl SNS-B 75W-80	-			↔	↔			9
3 1.6 CiTD (80 kW)	'09-'10	3,8		●				●	●	1,9	Spezialprodukt	-			↔	↔			9
3 1.6 CiTD (85 kW)	'10-	3,8		●				●	●	1,7	Spezialprodukt	-			↔	↔			9
3 2.2 CiTD	'09-	4,7		●				●	●	2,4-2,6	Getr.Öl EP Synth 75W-90	-			↔	↔			7,5
5 2.0 CiTD, HP DPF	'05-'08	4,1		●				●	●	2,6	Getr.Öl SNS-B 75W-80			Getriebeöl ATF J	↔	↔			8-8,5
5 2.0 CiTD, HP DPF	'09-'10	4,1		●				●	●	2,6	Getr.Öl EP Synth 75W-90			Getriebeöl ATF J	↔	↔			8-8,5
5 1.6 CiTD	'10-	4,3		●				●	●	1,7	Spezialprodukt	-			↔	↔			6,1
626 2.0 Compreh Diesel, 2.0 DiTD	'92-'97	5/5,4		●				●	●	2,7-3,4	Getr.Öl SNS-B 75W-80	Getr.Öl ATF E-S		Getriebeöl ATF 55	↔	↔			9
6 2.0 CiTD, HP	'02-'05	5	●	●				●	●	2,3	Getr.Öl SNS-B 75W-80	-			↔	↔			9
6 2.0 CiTD, HP DPF	'05-'07	4,1		●				●	●	2,6	Getr.Öl SNS-B 75W-80	-			↔	↔			9
6 2.0 CiTD	'07-'10	4,1		●				●	●	2,6	Getr.Öl SNS-B 75W-80	-			↔	↔			9
6 2.2 CiTD	'07-'08	4,7		●				●	●	2,4-2,6	Getr.Öl SNS-B 75W-80	-			↔	↔			9
6 2.2 CiTD	'09-'10	4,7		●				●	●	2,4-2,6	Getr.Öl EP Synth 75W-90	-			↔	↔			9
6 2.2 CiTD	'10-	4,7		●				●	●	2,4-2,6	Getr.Öl EP Synth 75W-90	-			↔	↔			9
MPV 2.0 CiTD	'03-'05	5	●	●				●	●	2,3	Getr.Öl SNS-B 75W-80	Getr.Öl ATF E-S		Getriebeöl ATF 55	↔	↔			8,6-10,7
MPV 2.5 TD	'96-'99	6,8		●				●	●	2,5	Getr.Öl SNS-B 75W-80	-			1,5	Getriebeöl BS 75W-90			7,5
Premacy 2.0 DiTD	'99-'05	4,7		●				●	●	2,7	Getr.Öl SNS-B 75W-80	-			↔	↔			8,5-9
CX-5 2.2 SKYACTIVE-D, 4WD	'12-	5,1		●	●			●	●	2,4	Getr.Öl EP Synth 75W-90	n	Spezialprodukt	n	0,45	Getriebeöl BS 75W-90			8,9
CX-7 2.2 CiTD	'09-	4,7		●				●	●	2,6	Getriebeöl BS 75W-90	l	-		1	Getriebeöl BS 75W-90			9

- a Differential, hinten (4WD): 0,7-1 l Getriebeöl BS 75W-90; Getriebeöl HYP Synth 75W-90
- c Differential, hinten (4WD): 0,5 l Getriebeöl BS 75W-90; Getriebeöl SNA-C 75W-90
- e Verteilergetriebe: 0,4-0,5 l Getr.Öl BS LSX 75W-140
- h Verteilergetriebe: Getr.Öl SNS-B 75W-80
- l Verteilergetriebe: 1,2 l Getriebeöl BS 75W-90; Getriebeöl SNA-C 75W-90



- b Differential, hinten (4WD): 1,4 l Getriebeöl BS 75W-90; Getriebeöl SNA-C 75W-90
- d Verteilergetriebe: 0,5 l Getriebeöl BS 75W-90; Getriebeöl SNA-C 75W-90
- f Verteilergetriebe: 0,35-0,62 l Getriebeöl BS 75W-90; Getriebeöl SNA-C 75W-90
- k Differential, hinten (4WD): Getr.Öl BS LSX 75W-140; Getr.Öl HYP LS 85W-90
- n Verteilergetriebe: Getriebeöl BS 75W-90; Getriebeöl SNA-C 75W-90

## MERCEDES-BENZ

<b>A-Class (W168), Vaneo (W414)</b>																			
A 140, 160, 190, 210	'97-'05	4,5	●			●				1,8	Getr.Öl SNS-B 75W-80	Spezialprodukt				↔	↔		5-5,7
Vaneo 1.6, 1.9	'01-'06	5	●			●				1,8	Getr.Öl SNS-B 75W-80	Spezialprodukt				↔	↔		6
<b>A-Class (W169)</b>																			
A 150, 170, 200, 200 Turbo, BlueEFFICIENCY	'05-'09	5	●	●	●	●	●	●		1,8	Getr.Öl SNS-B 75W-80	Spezialprodukt				↔	↔		6,8-7
A 160, 180, 200, 200 Turbo, BlueEFFICIENCY	'09-'12	5	●	●	●	●	●	●		1,8	Getr.Öl SNS-B 75W-80	Spezialprodukt				↔	↔		6,8-7
<b>A-Class (W176)</b>																			
A 180, 200, 250, BlueEFFICIENCY, Sport	'12-	5,8	●	●	●	●	●	●		1,8	Getr.Öl SNS-B 75W-80	Spezialprodukt				↔	↔		-
<b>B-Class (W245)</b>																			
B 150, 170, 200, 200 Turbo	'05-'09	5	●	●	●	●	●	●		1,8	Getr.Öl SNS-B 75W-80	Spezialprodukt				↔	↔		4,5-6,5
B 160, 170 NGT, 180, 180 NGT, 200, 200 Turbo, BlueEFFICIENCY	'09-'11	5-5,2	●	●	●	●	●	●		1,8	Getr.Öl SNS-B 75W-80	Spezialprodukt				↔	↔		4,3-4,5
<b>B-Class (W246)</b>																			
B 180 CGI, 200 CGI, 250, BlueEFFICIENCY	'11-	5,8	●	●	●	●	●	●		1,8	Getr.Öl SNS-B 75W-80	Spezialprodukt				↔	↔		-
B 200 Natural Gas Drive	'13-	5,8	●	●	●	●	●	●		2,2	Getr.Öl SNS-B 75W-80	Spezialprodukt				↔	↔		-
<b>C-Class (W202), CLK-Class (W208)</b>																			
C 180, 200, 200 K, CLK 200, 200 K, 230	'93-'00	5,5-5,8				●			●	1,5	Getr.Öl SNS-B 75W-80		Getr.Öl ATF M 14	d	0,7-1,1	Getr.Öl BS LSX 75W-140			8,5
C 220, 230, 230 K	'93-'00	5,9				●			●	1,5	Getriebeöl ATF 22		Getr.Öl ATF M 14	d	0,7	Getr.Öl BS LSX 75W-140			8
C 280	'93-'97	7,5				●			●	1,5	Getriebeöl ATF 22		Getr.Öl ATF M 14	d	0,7	Getr.Öl BS LSX 75W-140			10
C 240, C 280, CLK 320, 430	'97-'00	8-9,5				●			●	1,5	Getr.Öl SNS-B 75W-80		Getr.Öl ATF M 14	d	0,7-1,1	Getr.Öl BS LSX 75W-140			9,5
C 36 AMG	'93-'97	7,5				●			-	-			Getr.Öl ATF M 14	d	0,7	Getr.Öl BS LSX 75W-140	e		10
C 43 AMG	'97-'00	8				●			-	-			Getr.Öl ATF M 14	d	0,7	Getr.Öl BS LSX 75W-140			15
CLK 55 AMG	'99-'02	9,5				●			-	-			Getr.Öl ATF M 14	d	1,1	Getr.Öl BS LSX 75W-140			11

		SuperTronic		HighTronic			Blue Tronic	Aral		Aral		Aral									
		G 0W-30	0W-40	LL III 5W-30	M 5W-40	5W-40	G 5W-30	10W-40		Synthese	Mineral										
<b>MERCEDES-BENZ</b>																					
<b>C-Class (W203), CLK-Class (W209)</b>																					
C 160 Kompressor	'00-'07	5,5	●	●	●	●	●	●	1,2	Getr.Öl SNS-B 75W-80			Getr.Öl ATF M 14		-	Getr.Öl BS LSX 75W-140		7,5-8			
C 180	'00-'07	7	●		●	●	●	●	1,5	Getr.Öl SNS-B 75W-80			Getr.Öl ATF M 14	0,7	Getr.Öl BS LSX 75W-140		8-8,5				
C 180 K, 200 K, CLK 200 K	'00-'07	5,8	●		●	●	●	●	1,5	Getr.Öl SNS-B 75W-80			Getr.Öl ATF M 14	0,7	Getr.Öl BS LSX 75W-140		8-8,5				
C 160 K, 200 K (CGI), CLK 200 K	'02-'07	5,5	●	●	●	●	●	●	1,2	Getr.Öl SNS-B 75W-80			Getr.Öl ATF M 14	-	Getr.Öl BS LSX 75W-140		7,5-8				
C 230 K, 240, 320, 4MATIC, CLK 240, 320	'00-'04	8	●		●	●	●	●	1,5	Getr.Öl SNS-B 75W-80			Getr.Öl ATF M 14	0,7	Getr.Öl BS LSX 75W-140	f	6,4-8				
C 230, 280, 350, 4MATIC, CLK 280, 350	'05-'07	8	●		●	●	●	●	1,5	Getr.Öl SNS-B 75W-80			Getr.Öl ATF M 14	-	Getr.Öl BS LSX 75W-140	f	7-10				
CLK 500	'02-'06	7,5	●		●	●	●	●	-	-			Getr.Öl ATF M 14	1,6	Getr.Öl BS LSX 75W-140		11,5				
CLK 500	'06-'09	8,5	●		●	●	●	●	-	-			Getr.Öl ATF M 14	1,6	Getr.Öl BS LSX 75W-140		7,5				
C 32 AMG	'00-'04	8			●	●	●	●	-	-			Getr.Öl ATF M 14	-	Getr.Öl BS LSX 75W-140		6,4				
C, CLK 55 AMG	'00-'07	8,5			●	●	●	●	-	-			Getr.Öl ATF M 14	1,2	Getr.Öl BS LSX 75W-140		11-12				
CLK 63 AMG	'06-'09	8,8			●	●	●	●	-	-			Getr.Öl ATF M 14	1,2	Getr.Öl BS LSX 75W-140		8				
<b>CLC-Class (CL203)</b>																					
CLC 160 BlueEFFICIENCY, 180 K, 200 K	'08-'11	5,5	●	●	●	●	●	●	1,2	Getr.Öl SNS-B 75W-80	Spezialprodukt		q	1-1,2	Getr.Öl BS LSX 75W-140		-				
CLC 230, 250, 350	'08-'11	8	●		●	●	●	●	1,2	Getr.Öl SNS-B 75W-80	Spezialprodukt		q	1,1	Getr.Öl BS LSX 75W-140		-				
<b>C-Class (W204)</b>																					
C 180 CGI BlueEFFICIENCY, C200 CGI BlueEFFICIENCY	'09-	5,5	●	●	●	●	●	●	1,2-1,5	Getr.Öl SNS-B 75W-80	Spezialprodukt		q	1-1,2	Getr.Öl BS LSX 75W-140		-				
C 180 K, 200 K	'07-'10	5,5	●	●	●	●	●	●	1,2	Getr.Öl SNS-B 75W-80		Getr.Öl ATF M 14	1-1,2	Getr.Öl BS LSX 75W-140		-					
C 200 K, C 200 K BlueEFFICIENCY	'09-'10	5,5	●	●	●	●	●	●	1,2	Getr.Öl SNS-B 75W-80		Getr.Öl ATF M 14	1-1,2	Getr.Öl BS LSX 75W-140		-					
C 230, 280, 300, 350, 350 CGI BlueEFFICIENCY, 4MATIC	'07-	6,5-8	●		●	●	●	●	1,2-1,5	Getr.Öl SNS-B 75W-80	Spezialprodukt		q	1-1,2	Getr.Öl BS LSX 75W-140	f	-				
C 250 CGI BlueEFFICIENCY, 4MATIC	'09-	5,5	●	●	●	●	●	●	1,5	Getr.Öl SNS-B 75W-80	Spezialprodukt		q	1-1,2	Getr.Öl BS LSX 75W-140	f	-				
C 63 AMG	'07-'12	8,5-8,8			●	●	●	●	-	-	Spezialprodukt		q	1,2	Getr.Öl BS LSX 75W-140		-				
C 63 AMG, Black Series	'12-	8,5			●	●	●	●	-	-	Spezialprodukt			1,2	Getr.Öl BS LSX 75W-140		-				
<b>GLK-Class (X204)</b>																					
GLK 280, 280 4MATIC, 300, 300 4MATIC, 350, 350 4MATIC	'08-'12	7	●		●	●	●	●	-	-	Spezialprodukt		q	1-1,2	Getr.Öl BS LSX 75W-140	f	5				
GLK 350 BlueEFFICIENCY, 4MATIC	'12-	6,5	●		●	●	●	●	-	-	Spezialprodukt			1-1,2	Getr.Öl BS LSX 75W-140	f	5				
<b>SLK-Class (R170)</b>																					
SLK 200, 200 K, 230 K	'96-'04	5,8-5,9			●	●	●	●	1,5	Getr.Öl SNS-B 75W-80		Getr.Öl ATF M 14	0,7	Getr.Öl BS LSX 75W-140		8-8,5					
SLK 320	'00-'04	7,5-9,5	●		●	●	●	●	-	-		Getr.Öl ATF M 14	0,7	Getr.Öl BS LSX 75W-140		9-11					
SLK 32 AMG K	'01-'04	8			●	●	●	●	-	-		Getr.Öl ATF M 14	1,2	Getr.Öl BS LSX 75W-140		8					
<b>SLK-Class (R171)</b>																					
SLK 200 K	'04-'08	5,5	●	●	●	●	●	●	1,2	Getr.Öl SNS-B 75W-80	m	Getr.Öl ATF M 14	1	Getr.Öl BS LSX 75W-140		8,2					
SLK 200 K	'08-'11	5,5	●		●	●	●	●	1,2	Getr.Öl SNS-B 75W-80	m	Getr.Öl ATF M 14	1	Getr.Öl BS LSX 75W-140		-					
SLK 280, 350	'04-'11	8	●		●	●	●	●	1,5	Getr.Öl SNS-B 75W-80	m	Spezialprodukt	q	1	Getr.Öl BS LSX 75W-140		7,1-10,2				
SLK 55 AMG	'04-'11	8-9,2			●	●	●	●	-	-	Spezialprodukt		q	1,2	Getr.Öl BS LSX 75W-140		11,1				
<b>SLK-Class (R172)</b>																					
SLK 200 CGI, 250 CGI	'11-	5,5	●	●	●	●	●	●	1,5	Getr.Öl SNS-B 75W-80	Spezialprodukt			1-1,2	Getr.Öl BS LSX 75W-140		-				
SLK 350 CGI	'11-	6,5	●		●	●	●	●	-	-	Spezialprodukt			1-1,2	Getr.Öl BS LSX 75W-140		-				
SLK 55 AMG	'12-	9,5			●	●	●	●	-	-	Spezialprodukt			1,2	Getr.Öl BS LSX 75W-140		-				
<b>E-Class (W124, W210)</b>																					
E 200, 220, 230	'92-'00	5,8			●	●	●	●	1,3/1,5	Getriebeöl ATF 22		Getr.Öl ATF M 14	d	0,7	Getriebeöl HYP 85W-90	e	8,5				
E 200 K	'00-'02	5,5			●	●	●	●	1,5	Getr.Öl SNS-B 75W-80		Getr.Öl ATF M 14		0,7-1,1	Getriebeöl HYP 85W-90	e	8,5				
E 280, 300, 320, 420, 500, 4MATIC	'92-'97	7,5-8			●	●	●	●	1,5-1,7	Getriebeöl ATF 22		Getr.Öl ATF M 14	ad	0,7	Getriebeöl HYP 85W-90	ef	9-15,5				
E 240, 280, 320, 430	'97-'02	8			●	●	●	●	1,5	Getr.Öl SNS-B 75W-80		Getr.Öl ATF M 14		0,7	Getr.Öl BS LSX 75W-140		10-11				
E 55 AMG	'97-'02	8			●	●	●	●	-	-		Getr.Öl ATF M 14		0,7	Getr.Öl BS LSX 75W-140		11				
<b>E-Class (W211)</b>																					
E 200 K, NGT	'02-'09	5,5	●	●	●	●	●	●	1,2	Getr.Öl SNS-B 75W-80	m	Getr.Öl ATF M 14		1-1,6	Getr.Öl BS LSX 75W-140		5,6-8				

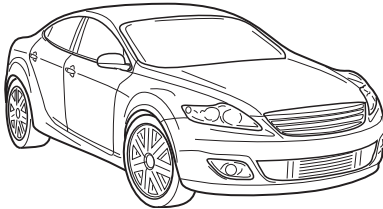
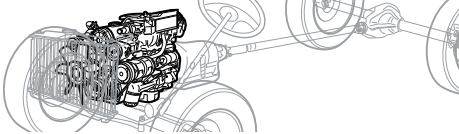
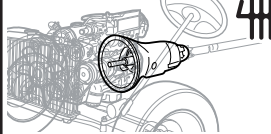
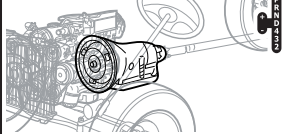
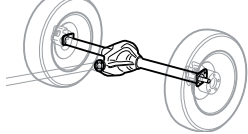
E 230	'07-'09	8	●						1,2	Getr.Öl SNS-B 75W-80	n		Getr.Öl ATF M 14	n	1-1,6	Getr.Öl BS LSX 75W-140	f	6,5
E 240, 320, 500, 4MATIC	'02-'06	8	●						1,2	Getr.Öl SNS-B 75W-80	n		Getr.Öl ATF M 14	n	1-1,6	Getr.Öl BS LSX 75W-140	f	9,5-10,8
E 280, 350, 500, 4MATIC	'05-'10	8-8,5	●						1,5	Getr.Öl SNS-B 75W-80	n		Getr.Öl ATF M 14	n	1-1,6	Getr.Öl BS LSX 75W-140	f	6,5-10,5
E 55 AMG	'02-'06	8,5							-	-			Getr.Öl ATF M 14		1-1,6	Getr.Öl BS LSX 75W-140		13
E 63 AMG	'06-'10	8,8							-	-			Getr.Öl ATF M 14		1,2	Getr.Öl BS LSX 75W-140		8
<b>E-Class (W212), Coupé/Cabriolet (C207/A207)</b>																		
E 200, E 250 CGI BlueEFFICIENCY	'09-'10	5,5	●	●	●	●	●	●	1,8	Getr.Öl SNS-B 75W-80			Getr.Öl ATF M 14		1-1,2	Getr.Öl BS LSX 75W-140		-
E 180 CGI, E 200 CGI, E 200 NGT, BlueEFFICIENCY	'10-	5,5	●	●	●	●	●	●	1,2	Getr.Öl SNS-B 75W-80	Spezialprodukt		q	1-1,2	Getr.Öl BS LSX 75W-140			-
E 250, E 250 CGI, E 260 CGI L, E 300, BlueEFFICIENCY	'10-	8	●						1,2-1,5	Getr.Öl SNS-B 75W-80	Spezialprodukt		q	1-1,2	Getr.Öl BS LSX 75W-140			-
E 350, CGI BlueEFFICIENCY, 4MATIC	'09-'10	6,5	●						-	-			Getr.Öl ATF M 14		1-1,2	Getr.Öl BS LSX 75W-140	f	-
E 350, CGI BlueEFFICIENCY, 4MATIC	'10-	6,5	●						-	-			Spezialprodukt	q	1-1,2	Getr.Öl BS LSX 75W-140	f	-
E 500, 4MATIC	'09-'10	8,5	●						-	-			Getr.Öl ATF M 14		1-1,2	Getr.Öl BS LSX 75W-140	f	-
E 500, E 550, 4MATIC, BlueEFFICIENCY	'10-	8,5	●						-	-			Spezialprodukt	q	1-1,2	Getr.Öl BS LSX 75W-140	f	-
E 63 AMG	'09-	8,8							-	-			Spezialprodukt	q	1-1,2	Getr.Öl BS LSX 75W-140		-
<b>R-Class (W251)</b>																		
R 280, R 300, R 350	'07-'12	8	●						-	-			Spezialprodukt	q	1,1	Getr.Öl BS LSX 75W-140		-
R 350 4MATIC	'05-'11	8	●						-	-			Spezialprodukt	kq	1,1	Getr.Öl BS LSX 75W-140	g	-
R 350 CGI 4MATIC	'11-	7,5	●						-	-			Spezialprodukt	k	1,1	Getr.Öl BS LSX 75W-140	g	-
R 500 4MATIC, R 550 4MATIC	'05-	8,5-9	●						-	-			Spezialprodukt	kq	1,1	Getr.Öl BS LSX 75W-140	g	-
R 63 AMG	'05-'08	9,6							-	-			Getr.Öl ATF M 14	k	1,1	Getr.Öl BS LSX 75W-140	g	7,5
<b>S-Class (W140)</b>																		
300 SE, SEL 2.8, 3.2, S 280, 320	'91-'98	7,5						●	1,7	Getriebeöl ATF 22			Getr.Öl ATF M 14	d	1	Getriebeöl HYP 85W-90	e	14,5
400 SE, SEL, S 420	'91-'98	8						●	-	-			Getr.Öl ATF M 14		1	Getriebeöl HYP 85W-90	e	16,5
500 SE, SEL, SEC, S, CL 500	'91-'98	8						●	-	-			Getr.Öl ATF M 14	d	1	Getriebeöl HYP 85W-90	e	16,5
600 SE, SEL, SEC, S, CL 600	'91-'98	10						●	-	-			Getr.Öl ATF M 14	d	1	Getriebeöl HYP 85W-90	e	20,5
<b>S-Class (W220)</b>																		
S 320, 350, 430, 500, 4MATIC	'98-'05	8	●					●	-	-			Getr.Öl ATF M 14	l	-	Getr.Öl BS LSX 75W-140	g	10,5-11,5
S 600	'99-'05	9	●					●	-	-			Getr.Öl ATF M 14		-	Getr.Öl BS LSX 75W-140		18
<b>S-Class (W221)</b>																		
S 350, 450, 500, 4MATIC	'05-'10	8-8,5	●					●	-	-			Getr.Öl ATF M 14		-	Getr.Öl BS LSX 75W-140	g	8-8,5
S 280, S300, S 350 CGI BlueEFFICIENCY, 4MATIC, S 400 Hybrid	'07-	6,5-8	●					●	-	-			Spezialprodukt	q	-	Getr.Öl BS LSX 75W-140	g	-
S 450, S 450 4MATIC, S 500, S 550	'09-'10	8	●					●	-	-			Spezialprodukt	q	-	Getr.Öl BS LSX 75W-140	g	-
S 500 CGI, S 550 CGI, BlueEFFICIENCY, 4MATIC	'09-	8	●					●	-	-			Spezialprodukt	q	-	Getr.Öl BS LSX 75W-140	g	-
S 600, S 600 Pullman Guard	'05-	9						●	-	-			Spezialprodukt	q	-	Getr.Öl BS LSX 75W-140		8,8/1,5
S 63 AMG	'06-'10	9,4						●	-	-			Getr.Öl ATF M 14		1,1-1,9	Getr.Öl BS LSX 75W-140		-
S 63 AMG	'10-	8,5						●	-	-			Spezialprodukt	q	1,1-1,9	Getr.Öl BS LSX 75W-140		-
S 65 AMG	'06-	9-9,5						●	-	-			Spezialprodukt	q	-	Getr.Öl BS LSX 75W-140		11,8
<b>SL-Class (R129)</b>																		
SL 280, 320	'93-'01	7						●	1,5	Getriebeöl ATF 22			Getr.Öl ATF M 14	d	1,1	Getr.Öl BS LSX 75W-140		11,5
500 SL, SL 500	'89-'01	8						●	-	-			Getr.Öl ATF M 14	d	1,3	Getriebeöl HYP 85W-90	e	15
600 SL, SL 600	'92-'01	10						●	-	-			Getr.Öl ATF M 14	d	1,3	Getriebeöl HYP 85W-90	e	18,5-19
<b>SL-Class (R230)</b>																		
SL 280, SL 300, SL 350, SL 500, SL 550	'01-'12	7,5-8,5	●					●	1,5	Getr.Öl SNS-B 75W-80	m	Spezialprodukt	q	1,1-1,9	Getr.Öl BS LSX 75W-140			7,5-11,5
SL 55 AMG	'01-'08	8,5						●	-	-			Getr.Öl ATF M 14		1,2	Getr.Öl BS LSX 75W-140		13
SL 600	'03-'12	8						●	-	-			Spezialprodukt	q	1,1-1,9	Getr.Öl BS LSX 75W-140		9,4
SL 63 AMG	'08-'12	9,4						●	-	-			Spezialprodukt	q	1,2	Getr.Öl BS LSX 75W-140		-
SL 65 AMG, SL 65 AMG Black Series	'04-'12	8-9,5						●	-	-			Spezialprodukt	q	1,2	Getr.Öl BS LSX 75W-140		12
<b>SL-Class (R231)</b>																		
SL 350 BlueEFFICIENCY	'12-	6,5	●					●	-	-			Spezialprodukt		1,1-1,2	Getr.Öl BS LSX 75W-140		-
SL 63 AMG	'12-	8,5	●					●	-	-			Spezialprodukt		1,2	Getr.Öl BS LSX 75W-140		-
SL 500 BlueEFFICIENCY	'12-	8,5	●					●	-	-			Spezialprodukt		1,1-1,2	Getr.Öl BS LSX 75W-140		-
<b>CLA-Class (C117)</b>																		
CLA 180, 200, 250, BlueEFFICIENCY	'13-	5,8	●	●	●	●	●	●	1,8	Getr.Öl SNS-B 75W-80	Spezialprodukt			↔	↔			-
<b>CLS-Class (C219)</b>																		
CLS 350 (CGI), 500	'04-'10	8-8,5	●					●	-	-			Getr.Öl ATF M 14		1,1-1,6	Getr.Öl BS LSX 75W-140		6,5-10,7
CLS 55 AMG K, 63 AMG	'04-'06	8,5						●	-	-			Getr.Öl ATF M 14		1,2	Getr.Öl BS LSX 75W-140		13,2
CLS 63 AMG	'06-'10	8,8						●	-	-			Getr.Öl ATF M 14		1,2	Getr.Öl BS LSX 75W-140		8

																		
	SuperTronic			HighTronic			Blue Tronic	Aral	⚠	Aral		⚠	Aral	⚠	Aral			
	G 0W-30	0W-40	LL III 5W-30	M 5W-40	5W-40	G 5W-30	10W-40			Synthese	Mineral							
<b>MERCEDES-BENZ</b>																		
<b>CLS-Class (C218)</b>																		
CLS 350 CGI BlueEFFICIENCY	'10-	6,5	●		●				-	-		Spezialprodukt		q	1,1-1,2	Getr.Öl BS LSX 75W-140		-
CLS 500 CGI, 550 CGI, BlueEFFICIENCY, 4MATIC	'10-	8,5	●		●				-	-		-			0,6-1,2	Getr.Öl BS LSX 75W-140	g	-
CLS 63 AMG	'10-	8,5			●				-	-		Spezialprodukt		q	1,2	Getr.Öl BS LSX 75W-140		-
<b>CL-Class (C215, C216)</b>																		
CL 500, 600	'99-'06	8/10	●		●			●	-	-			Getr.Öl ATF M 14		1,6-1,9	Getr.Öl BS LSX 75W-140		11,5/13,8
CL 500, 4MATIC	'06-'10	8,5	●		●				-	-			Getr.Öl ATF M 14		1,1-1,6	Getr.Öl BS LSX 75W-140	g	8,5/19,5
CL 500, BlueEFFICIENCY, 4MATIC	'10-	8,5	●		●				-	-		Spezialprodukt		q	1,1-1,6	Getr.Öl BS LSX 75W-140	g	8,5/19,5
CL 600	'06-	9			●				-	-		Spezialprodukt		q	1,1-1,6	Getr.Öl BS LSX 75W-140		8,5/19,5
CL 55 AMG K, CL 65 AMG	'02-'06	7,5-10,5			●				-	-			Getr.Öl ATF M 14		1,2-1,6	Getr.Öl BS LSX 75W-140		8-16,6
CL 63 AMG	'07-'10	9,4			●				-	-			Getr.Öl ATF M 14		1,1-1,6	Getr.Öl BS LSX 75W-140		-
CL 63 AMG, CL 65 AMG	'10-	8,5-9,5			●				-	-		Spezialprodukt		q	1,1-1,6	Getr.Öl BS LSX 75W-140		-
<b>M-Class (W163)</b>																		
ML 230	'97-'01	5,5	●		●			●	1,8	Getr.Öl SNS-B 75W-80	b		Getr.Öl ATF M 14	b	-	Getr.Öl BS LSX 75W-140	g	10,5
ML 320, 350, 430, 500	'97-'05	7,5-8	●		●			●	-	-			Getr.Öl ATF M 14	b	-	Getr.Öl BS LSX 75W-140	g	11-12
ML 55 AMG	'99-'04	8			●				-	-			Getr.Öl ATF M 14	b	-	Getr.Öl BS LSX 75W-140	g	11
<b>M-Class, GL-Class (W164, X164)</b>																		
ML 350, 4MATIC	'05-'11	8	●		●				-	-		Spezialprodukt		kq	1,1	Getr.Öl BS LSX 75W-140	gh	6,5/10
ML 450 Hybrid 4MATIC	'11-'11	8	●		●				-	-		Spezialprodukt			1,1	Getr.Öl BS LSX 75W-140	gh	-
ML 500, ML 550, 4MATIC	'05-'11	8,5	●		●			●	-	-		Spezialprodukt		kq	1,1	Getr.Öl BS LSX 75W-140	g	-
ML 63 AMG	'06-'11	9,7			●				-	-		Spezialprodukt		kq	1,1	Getr.Öl BS LSX 75W-140	gh	7,5
GL 450 4MATIC, GL 500	'06-'09	8,5	●		●				-	-			Getr.Öl ATF M 14	k	1,1	Getr.Öl BS LSX 75W-140	gh	6,5
GL 450 4MATIC, 500 / 550 4MATIC	'09-'12	9	●		●			●	-	-		Spezialprodukt		kq	1,1	Getr.Öl BS LSX 75W-140	gh	-
<b>M-Class, GL-Class (W166, X166)</b>																		
ML 300, 350, 4MATIC, BlueEFFICIENCY	'11-	7	●		●				-	-		Spezialprodukt		k	0,8-1,2	Getr.Öl BS LSX 75W-140	g	-
ML 500 4MATIC BlueEFFICIENCY	'12-	8,5	●		●				-	-		Spezialprodukt		k	0,8-1,2	Getr.Öl BS LSX 75W-140	g	-
ML 63 AMG	'12-	8,5			●				-	-		Spezialprodukt		k	0,8-1,2	Getr.Öl BS LSX 75W-140	g	-
GL 500 4MATIC BlueEFFICIENCY	'12-	8,5	●		●				-	-		Spezialprodukt		k	0,8-1,2	Getr.Öl BS LSX 75W-140	g	-
GL 63 AMG	'12-	8,5			●				-	-		Spezialprodukt		k	0,8-1,2	Getr.Öl BS LSX 75W-140	g	-
<b>G-Class (W461, W463)</b>																		
200, 230, 300 GE, G 230, 300	'90-'94	4,5-6,5			●			●	1,5-1,6	Getriebeöl ATF 22	c		Getr.Öl ATF M 14	c	1,1/1,8	Getriebeöl HYP 85W-90	g	5-8
G 320	'94-'06	8	●		●			●	-	-			Getr.Öl ATF M 14	c	1,4/1,8	Getriebeöl HYP 85W-90	g	11,5
G 500	'98-'06	8	●		●			●	-	-			Getr.Öl ATF M 14	c	1,4/1,8	Getriebeöl HYP 85W-90	g	12
G 500	'06-'10	8	●		●			●	-	-			Getr.Öl ATF M 14	o	1,4/1,8	Getriebeöl HYP 85W-90	g	12
G 500	'10-	8	●		●			●	-	-		Spezialprodukt		oq	1,4/1,8	Getriebeöl HYP 85W-90	g	-
G 55 AMG	'03-'04	8			●				-	-			Getr.Öl ATF M 14	c	1,4/1,8	Getriebeöl HYP 85W-90	g	12
G 55 AMG K	'04-'09	8-8,5			●				-	-			Getr.Öl ATF M 14	o	1,4/1,8	Getr.Öl BS LSX 75W-140	g	13
G 55 AMG K	'09-'12	8,5			●				-	-		Spezialprodukt		oq	1,4/1,8	Getr.Öl BS LSX 75W-140	g	-
G 63 AMG	'12-	8,5			●				-	-		Spezialprodukt		o	1,4/1,8	Getr.Öl BS LSX 75W-140	g	-
<b>V-Class (W638)</b>																		
V 230	'96-'03	4,5-5	●		●			●	1,7-2	Getr.Öl SNS-B 75W-80		Getr.Öl ATF E-S		↔	↔			9
V 280	'99-'03	6,4	●		●			●	-	-		Getr.Öl ATF E-S		↔	↔			12,5
<b>Viano (W639)</b>																		
Viano 3.0, 3.2, 3.5	'03-'09	10	●		●			●	1,2-1,5	Getr.Öl SNS-B 75W-80			Getr.Öl ATF M 14		1,3	Getr.Öl BS LSX 75W-140		8,1-9,9
Viano 3.5	'07-	10	●		●				1,2-1,5	Getr.Öl SNS-B 75W-80			Getr.Öl ATF M 14		1,3-1,5	Getr.Öl BS LSX 75W-140		8,1-9,9
<b>SLS AMG (C197)</b>																		
SLS AMG	'10-	9,5			●				-	-		Spezialprodukt			2,9-3,72	Spezialprodukt		-



	SuperTronic	HighTronic	Blue Tronic	Aral	Aral		Aral									
					G 0W-30	0W-40			LL III 5W-30	M 5W-40	5W-40	G 5W-30	10W-40	Synthese	Mineral	
<b>MERCEDES-BENZ</b>																
<b>E-Class (W212)</b>																
E 200, 220, 250 CDI, BlueEFFICIENCY	'09-'10	6,5	●	●	●	●	●	1,5-1,8	Getr.Öl SNS-B 75W-80		Getr.Öl ATF M 14	1-1,2	Getr.Öl BS LSX 75W-140	-		
E 200, 220, 250 CDI, BlueEFFICIENCY, 4MATIC	'10-	6,5	●	●	●	●	●	1,5	Getr.Öl SNS-B 75W-80	Spezialprodukt	Getr.Öl ATF M 14	q	1-1,2	Getr.Öl BS LSX 75W-140	f	
E 350 CDI, BlueEFFICIENCY, 4MATIC, BlueTEC	'09-'10	8	●	●	●	●	●	1,8	Getr.Öl SNS-B 75W-80		Getr.Öl ATF M 14	1-1,2	Getr.Öl BS LSX 75W-140	f		
E 300, 350 CDI, BlueEFFICIENCY, 4MATIC, BlueTEC	'10-	8	●	●	●	●	●	1,8	Getr.Öl SNS-B 75W-80	Spezialprodukt	Getr.Öl ATF M 14	q	1-1,2	Getr.Öl BS LSX 75W-140	f	
<b>R-Class (W251)</b>																
R 280, 320 CDI, DPF, 4MATIC	'05-'09	8,5	●	●	●	●	●	-	-		Getr.Öl ATF M 14	p	1,1	Getr.Öl BS LSX 75W-140	g	
R 300, 350 CDI, DPF, 4MATIC	'09-	8,5	●	●	●	●	●	-	-	Spezialprodukt	Getr.Öl ATF M 14	pq	1,1	Getr.Öl BS LSX 75W-140	g	
R 350 BlueTEC L 4MATIC	'09-	8,5	Spezialprodukt, bitte auf Originalersatzteil des Herstellers zurückgreifen!						-	-	Spezialprodukt	Getr.Öl ATF M 14	pq	1,1	Getr.Öl BS LSX 75W-140	g
<b>S-Class (W140)</b>																
S 300, 350 Turbo Diesel	'93-'00	7,5/8			●			●	-	-	Getr.Öl ATF M 14	d	1,3	Getr.Öl BS LSX 75W-140	e	
<b>S-Class (W220)</b>																
S 320, 400 CDI	'00-'05	7,5/10	●	●	●	●	●	-	-		Getr.Öl ATF M 14	-	Getr.Öl BS LSX 75W-140	15,5/16,5		
<b>S-Class (W221)</b>																
S 250 CDI	'11-	6,5	●	●	●	●	●	-	-	Spezialprodukt	Getr.Öl ATF M 14	-	Getr.Öl BS LSX 75W-140	g		
S 320, 420 CDI, DPF, 4MATIC	'05-'09	8,5/10,5	●	●	●	●	●	-	-	Spezialprodukt	Getr.Öl ATF M 14	q	-	Getr.Öl BS LSX 75W-140	g	
S 350, BlueTEC, DPF, 4MATIC	'09-	8	●	●	●	●	●	-	-	Spezialprodukt	Getr.Öl ATF M 14	q	-	Getr.Öl BS LSX 75W-140	g	
S 450 CDI, DPF, 4MATIC, Guard	'09-	10,5	●	●	●	●	●	-	-	Spezialprodukt	Getr.Öl ATF M 14	q	-	Getr.Öl BS LSX 75W-140	g	
<b>CLA-Class (C117)</b>																
CLA 220 CDI	'13-	6,5	●	●	●	●	●	-	-	Spezialprodukt	Getr.Öl ATF M 14	←	←	-		
<b>CLS-Class (C219)</b>																
CLS 320, 350 CDI, DPF	'04-'10	8,5	●	●	●	●	●	-	-		Getr.Öl ATF M 14	1,1	Getr.Öl BS LSX 75W-140	7,5		
<b>CLS-Class (C218)</b>																
CLS 250 CDI, 350 CDI, BlueEFFICIENCY, BlueTEC	'10-	6,5-8	●	●	●	●	●	-	-	Spezialprodukt	Getr.Öl ATF M 14	q	1,1-1,2	Getr.Öl BS LSX 75W-140	-	
<b>M-Class (W163)</b>																
ML 270, 400 CDI	'99-'05	7,5/10	●	●	●	●	●	-	Getr.Öl SNS-B 75W-80	b	Getr.Öl ATF M 14	b	-	Getr.Öl BS LSX 75W-140	g	
<b>M-Class, GL-Class (W164, X164)</b>																
ML, GL 280, 320 CDI, DPF, 4MATIC	'05-'09	8,5	●	●	●	●	●	-	-		Getr.Öl ATF M 14	k	1,1	Getr.Öl BS LSX 75W-140	gh	
ML, GL 300, 350 CDI, BlueEFFICIENCY, 4MATIC	'09-'12	8,5	●	●	●	●	●	-	-	Spezialprodukt	Getr.Öl ATF M 14	kq	1,1	Getr.Öl BS LSX 75W-140	gh	
ML, GL 320, 350 BlueTEC 4MATIC	'07-'12	8,5	Spezialprodukt, bitte auf Originalersatzteil des Herstellers zurückgreifen!						-	-	Spezialprodukt	Getr.Öl ATF M 14	kq	1,1	Getr.Öl BS LSX 75W-140	gh
ML, GL 420 CDI, DPF, 4MATIC	'06-'09	11,5	●	●	●	●	●	-	-		Getr.Öl ATF M 14	k	1,1,1,8	Getr.Öl BS LSX 75W-140	gh	
GL 450 CDI 4MATIC	'09-'12	11,5	●	●	●	●	●	-	-		Getr.Öl ATF M 14	k	1,1	Getr.Öl BS LSX 75W-140	gh	
<b>M-Class, GL-Class (W166, X166)</b>																
ML, GL, 250, 350, CDI, BlueTEC, 4MATIC	'11-	6,5-8	●	●	●	●	●	-	-	Spezialprodukt	Getr.Öl ATF M 14	k	0,8-1,2	Getr.Öl BS LSX 75W-140	g	
<b>G-Class (W461, W463)</b>																
250, 300 GD, G 300 TD, 350 GD Turbo	'90-'00	7,5-8,5			●			●	1,5	Getriebeöl ATF 22	c	Getr.Öl ATF M 14	cd	1,1-1,8	Getriebeöl HYP 85W-90	g
G 270, 400 CDI	'00-'06	7/10	●	●	●	●	●	-	-		Getr.Öl ATF M 14	c	1,4/1,8	Getr.Öl BS LSX 75W-140	g	
G 320 CDI, DPF	'06-'09	8,5	●	●	●	●	●	-	-		Getr.Öl ATF M 14	c	1,4/1,8	Getr.Öl BS LSX 75W-140	g	
G 350 CDI	'09-'11	8	●	●	●	●	●	-	-	Spezialprodukt	Getr.Öl ATF M 14	oq	1,4/1,8	Getr.Öl BS LSX 75W-140	g	
G 350 BlueTEC	'11-	8	Spezialprodukt, bitte auf Originalersatzteil des Herstellers zurückgreifen!						-	-	Spezialprodukt	Getr.Öl ATF M 14	q	1,4/1,8	Getr.Öl BS LSX 75W-140	g
<b>V-Class (W638)</b>																
V 200, 220 CDI	'99-'03	7,5	●			●		●	2,2	Getr.Öl SNS-B 75W-80	Getr.Öl ATF E-S	←	←	-	11	
<b>Viano (W639)</b>																
Viano 2.0/2.2 CDI (OM 646)	'03-'10	8,5-9	●	●	●	●	●	1,2-1,5	Getr.Öl SNS-B 75W-80		Getr.Öl ATF M 14	1,3	Getr.Öl BS LSX 75W-140	8,6-10,5		
Viano 2.0/2.2 CDI, 4x4 (OM 646) DPF	'05-'10	8,5-9	●	●	●	●	●	1,2-1,5	Getr.Öl SNS-B 75W-80	p	Getr.Öl ATF M 14	p	1,3	Getr.Öl BS LSX 75W-140	r	
Viano 2.0/2.2 CDI (OM 651)	'10-	9	●	●	●	●	●	1,2-1,5	Getr.Öl SNS-B 75W-80		Getr.Öl ATF M 14	1,5	Getr.Öl BS LSX 75W-140	-		
Viano 2.0/2.2 CDI, 4x4 (OM 651) DPF	'10-	9	●	●	●	●	●	1,2-1,5	Getr.Öl SNS-B 75W-80	p	Getr.Öl ATF M 14	p	1,5	Getr.Öl BS LSX 75W-140	r	

Viano 3.0 CDI (OM 642) DPF	'06-'10	10		●	●	●	●		1,2-1,5	Getr.Öl SNS-B 75W-80		Getr.Öl ATF M 14		1,3	Getr.Öl BS LSX 75W-140	9,9-11,4
Viano 3.0 CDI (OM 642) DPF	'10-	10		●	●	●	●		1,2-1,5	Getr.Öl SNS-B 75W-80		Getr.Öl ATF M 14		1,3	Getr.Öl BS LSX 75W-140	-
a	Verteilergetriebe (4-Matic): 0,7 l Getr.Öl ATF E-S; Getriebeöl ATF 55															
c	Verteilergetriebe: 2-2,8 l Getriebeöl EP 80W															
e	Sperrdifferential und Differentiale von PKW mit ASD oder 4MATIC: Getr.Öl BS LSX 75W-140															
g	Differential, vorn und hinten															
k	Verteilergetriebe: 0,5 l; Verteilergetriebe, 2-gang: 0,5 l; Getr.Öl ATF M 14															
m	Hydraulik Bedienung Getriebe: 0,5 l Spezialprodukt, bitte auf Originalersatzteil des Herstellers zurückgreifen!															
o	Verteilergetriebe: 2,8 l Getr.Öl SNS-AT 75W-90															
q	Automatikgetriebe, Herstellungsdatum bis 18.06.2010: Getr.Öl ATF M 14															
b	Verteilergetriebe: Getr.Öl ATF M 14															
d	5-Gang Automatikgetriebe ab 01/1996: Getr.Öl ATF M 14															
f	Differential, vorn (4MATIC): Getr.Öl BS LSX 75W-140															
h	Sperrdifferential: 1,6 l Getr.Öl BS LSX 75W-140; Getr.Öl HYP LS 85W-90															
l	Verteilergetriebe: Getriebeöl ATF 22															
n	Verteilergetriebe (4MATIC): 0,6 l Spezialprodukt, bitte auf Originalersatzteil des Herstellers zurückgreifen!															
p	Verteilergetriebe: Getr.Öl ATF M 14															
r	Differential, vorn (4MATIC): Getriebeöl SNA-C 75W-90															

## MG



F, TF 1.8 16V	'95-'05	4,5		●		●			2,2	Getriebeöl SNS 75W-80		Spezialprodukt		↔	↔	10,5
ZR 1.4, 1.6	'01-'05	4,5	●	●	●				1,8	Getriebeöl BS 75W-90		-		↔	↔	4,8
ZR 1.8, VVC	'01-'05	4,5	●	●	●				2	Getriebeöl SNS 75W-80		Spezialprodukt		↔	↔	4,8
ZS 1.8 16V	'01-'05	4,5			●				2	Getriebeöl SNS 75W-80		Spezialprodukt		↔	↔	4,8
ZS V6-24V	'01-'05	5,2			●				2	Getriebeöl SNS 75W-80		Spezialprodukt		↔	↔	6,8
ZT V6-24V 190	'01-'05	5,2			●				1,4	Getriebeöl SNS 75W-80		Spezialprodukt		↔	↔	6,8
<b>Diesel</b>																
ZR, ZS TD	'01-'05	4,5				●		●	2	Getriebeöl SNS 75W-80		-		↔	↔	6,3

## MINI

Mini 1000	'89-'01	4,8/5,3			●			●	↔	↔		-		↔	↔	5
Mini Cooper	'89-'01	4,8			●			●	↔	↔		-		↔	↔	5
Mini One, Cooper	'01-'04	4,5-4,8	●	●	●				1,5	Getr.Öl SNS-B 75W-80		Spezialprodukt		↔	↔	5,3-5,6
Mini One, Cooper	'04-'06	4,5-4,8	●	●	●				1,7	Getr.Öl SNS-B 75W-80		Spezialprodukt		↔	↔	5,3-5,6
Mini One, Cooper	'06-	4,2	●	●	●				-	Getr.Öl SNS-B 75W-80		Getriebeöl ATF J		↔	↔	5,5
Mini Cooper S	'01-'06	4,8	●	●	●				2	Getr.Öl SNS-B 75W-80		-		↔	↔	5,6
Mini Cooper S	'06-	4,2	●	●	●				-	Getr.Öl SNS-B 75W-80		Getriebeöl ATF J		↔	↔	5,5
Mini Countryman One, Cooper	'10-	-	●	●	●				1,7	Getr.Öl SNS-B 75W-80		Getriebeöl ATF J		↔	↔	-
Mini Countryman Cooper S, ALL4	'10-	-	●	●	●				1,9	Getr.Öl SNS-B 75W-80		Getriebeöl ATF J		-	Getriebeöl BS 75W-90	-
<b>Diesel</b>																
Mini One Diesel	'03-'06	4,3		●		●	●		1,7	Getr.Öl SNS-B 75W-80		-		↔	↔	5,3
Mini Cooper D, Cooper SD	'07-'10	-		●		●	●		-	Getr.Öl SNS-B 75W-80		Getriebeöl ATF J		↔	↔	5,3
Mini Countryman One D, Cooper D, Cooper SD, ALL4	'10-	-		●		●	●		1,9	Getr.Öl SNS-B 75W-80		Getriebeöl ATF J		↔	↔	-

## MITSUBISHI

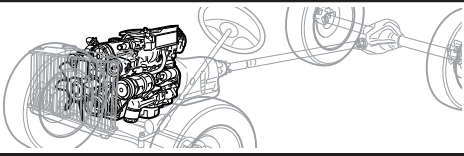
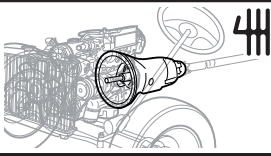
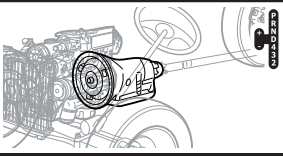
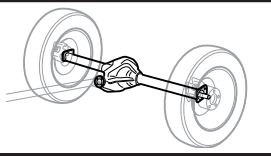
i-MiEV	'09-	-	-						-	-		Getr.Öl ATF E-S		↔	↔	5,1
Colt 1.3, 1.5, 1.6, 1.8 GTi, 4WD	'92-'96	3,3-3,8		●	●			●	1,8/2,2	Getr.Öl SNS-A 75W-85	b	Getr.Öl ATF E-S		↔	↔	d 5
Colt 1.3, 1.6	'96-'04	3,3/3,8		●	●			●	2,1	Getr.Öl SNS-A 75W-85		Getr.Öl ATF E-S		↔	↔	5/6
Colt 1.1, 1.3, 1.5	'04-'07	3,2-4,2	●	●	●			●	1,8	Getr.Öl SNS-A 75W-85		Spezialprodukt		↔	↔	4,2-4,6
Colt 1.1, ClearTec, 1.3, ClearTec	'07-	3-4	●	●	●			●	1,75	Getr.Öl SNS-A 75W-85		-		↔	↔	4,2
Colt 1.5 Turbo	'04-'08	3,7	●		●			●	1,8	Getr.Öl SNS-A 75W-85		Spezialprodukt		↔	↔	6
Colt 1.5 Turbo	'08-	3,3	●		●			●	1,75	Getr.Öl SNS-A 75W-85		-		↔	↔	6
Lancer 1.3, 1.5, 1.6, 1.8, 4WD	'92-'96	3,3-3,8		●	●			●	1,8	Getr.Öl SNS-A 75W-85	b	Getr.Öl ATF E-S		↔	↔	d 5
Lancer 1.3, 1.6, 4WD	'96-'01	3,3/3,8		●	●			●	2,1	Getr.Öl SNS-A 75W-85	b	Getr.Öl ATF E-S	b	↔	↔	d 5/6
Lancer 1.3, 1.6, 2.0	'03-'10	3,3-4,3	●	●	●			●	2,1	Getr.Öl SNS-A 75W-85		-		↔	↔	5-7
Lancer (Sportback) 1.5, 1.6, ClearTec, 1.8	'07-	4	●	●	●			●	1,9-2,5	Getr.Öl SNS-A 75W-85		Getr.Öl ATF E-S	n	↔	↔	6-7
Lancer 2.0 4x2, 4x4	'08-	4	●	●	●			●	2,5	Getr.Öl SNS-A 75W-85	o	Spezialprodukt		0,5	Getriebeöl BS 75W-90	7
Lancer (Sportback) Ralliart	'08-	4	●	●	●			●	2,5	Getr.Öl SNS-A 75W-85	op	-		0,5	Getriebeöl BS 75W-90	7
Lancer Evolution IV, V, VI	'96-'01	5,1		●	●			●	2,8	Getr.Öl SNS-A 75W-85	ar	-		0,4-0,43	Getriebeöl BS 75W-90	gh 6
Lancer Evolution VII, VIII, IX	'01-'07	5,1		●	●			●	2,8	Getr.Öl SNS-A 75W-85	ak	-		-	Getriebeöl BS 75W-90	dh 6
Lancer Evolution X GSR, MR	'07-	4		●	●			●	2,5	Getr.Öl SNS-A 75W-85	kp	Spezialprodukt		0,55	Getriebeöl BS 75W-90	7,5
Space Star 1.3	'98-'06	3,3		●	●			●	3,4	Getr.Öl EP Synth 75W-90		-		↔	↔	6
Space Star 1.6	'02-'06	3,3	●	●	●			●	3,4	Getr.Öl EP Synth 75W-90		Getr.Öl ATF E-S		↔	↔	6
Space Star 1.8 GDi	'98-'02	3,8	●		●			●	2,2	Getr.Öl SNS-A 75W-85		Getr.Öl ATF E-S		↔	↔	6
Carisma 1.6, 1.8	'95-'99	3,8		●	●			●	3,4	Getr.Öl EP Synth 75W-90		Getr.Öl ATF E-S		↔	↔	6
Carisma 1.8 GDi	'95-'99	3,8	●		●			●	2,2	Getr.Öl SNS-A 75W-85		Getr.Öl ATF E-S		↔	↔	6

																	
		SuperTronic			HighTronic				Blue Tronic	Aral	⚠	Aral		⚠	Aral	⚠	
		G 0W-30	0W-40	LL III 5W-30	M 5W-40	5W-40	G 5W-30	10W-40	Synthese			Mineral					
<b>MITSUBISHI</b>																	
Carisma 1.6	'99-'05	3,8	●	●	●			●	3,4	Getr.Öl EP Synth 75W-90	Getr.Öl ATF E-S			↔	↔		6
Carisma 1.8 GDi	'99-'05	3,8	●					●	2,2	Getr.Öl SNS-A 75W-85	Getr.Öl ATF E-S			↔	↔		6
Galant 1.8, 2.0, 2.0 V6, 2.5 V6	'92-'96	3,8-4,3		●	●			●	1,8-2	Getr.Öl SNS-A 75W-85	Getr.Öl ATF E-S			↔	↔		6-7
Galant 2.0, 2.5 V6	'96-'04	4,3		●	●			●	2,2	Getr.Öl SNS-A 75W-85	Getr.Öl ATF E-S			↔	↔		6-7
Galant 2.4 GDi	'99-'04	4,3	●					●	2,2	Getr.Öl SNS-A 75W-85	Getr.Öl ATF E-S			↔	↔		6-7
Sigma 3.0, 3.0 24V	'91-'96	4		●	●			●	2	Getr.Öl SNS-A 75W-85	Getr.Öl ATF E-S			↔	↔		8
Space Runner 1.8	'91-'98	3,8		●	●			●	2,8	Getr.Öl SNS-A 75W-85	Getr.Öl ATF E-S			↔	↔		6
Space Runner 2.0	'99-'02	4,3	●	●	●			●	2,2	Getr.Öl SNS-A 75W-85	Getr.Öl ATF E-S			↔	↔		6
Space Runner 2.4 GDi	'99-'02	4,3	●					●	2,2	Getr.Öl SNS-A 75W-85	Getr.Öl ATF E-S			↔	↔		6
Space Wagon 1.8, 2.0, 4WD	'91-'98	3,8/4,3		●	●			●	1,8-2,2	Getr.Öl SNS-A 75W-85	Getr.Öl ATF E-S	b		↔	↔	e	6
Space Wagon 2.0, 4WD	'98-'04	4,3	●	●	●			●	2,2-2,3	Getr.Öl SNS-A 75W-85	Getr.Öl ATF E-S	b		↔	↔	e	6
Space Wagon 2.4 GDi, 4WD	'98-'04	4,3	●	●	●			●	2,2-2,3	Getr.Öl SNS-A 75W-85	Getr.Öl ATF E-S	b		↔	↔	e	6
Grandis 2.4	'04-'11	4,3	●	●	●			●	2,2	Getr.Öl SNS-A 75W-85	Getr.Öl ATF E-S			↔	↔		-
Space Gear 2.0, 2.4, 4WD	'94-'00	4,3	●	●	●			●	2,2-2,3	Getr.Öl SNS-A 75W-85	Getr.Öl ATF E-S	c		↔	↔	dfg	8
ASX / RVR 1.6, ClearTec, 1.8	'10-	4	●	●	●			●	2-2,2	Getr.Öl SNS-A 75W-85	-			↔	↔		6
ASX / RVR 2.0 4x2, 4x4	'10-	4	●	●	●			●	2,5	Getr.Öl SNS-A 75W-85	Spezialprodukt	o		0,5	Getriebeöl BS 75W-90		7,5
Pajero, Shogun Pinin 1.8	'01-'05	3,8	●	●	●			●	2,4	Getr.Öl SNS-A 75W-85	Getr.Öl ATF E-S	c		-	-	dh	6
Pajero, Shogun Pinin 1.8 GDi, 2.0 GDi	'99-'05	3,8	●					●	2,4	Getr.Öl SNS-A 75W-85	Getr.Öl ATF E-S	c		-	-	dh	6
Pajero, Shogun 2.4, 3.0 V6	'91-'01	4,9		●	●			●	2,5	Getr.Öl SNS-A 75W-85	Getr.Öl ATF E-S	c		-	-	dgh	9,1-10
Pajero, Shogun 3.5 V6	'94-'99	4,9		●	●			●	3,7	Getr.Öl SNS-A 75W-85	Getr.Öl ATF E-S	c		-	-	dgh	9,5
Pajero, Shogun 3.5 V6 GDi	'01-'07	4,9	●					●	3,2	Getr.Öl SNS-A 75W-85	Getr.Öl ATF E-S	c		-	-	dgh	9
Pajero, Shogun 3.8 V6	'07-	4,9	●					●	3,2	Getr.Öl SNS-A 75W-85	Getr.Öl ATF E-S	m		1,2/1,6	Getriebeöl BS 75W-90	h	9-10,5
Outlander (Sport), Airtrek 2.0, 2.4	'03-'09	4,3-4,6	●	●	●			●	2,2-2,3	Getr.Öl SNS-A 75W-85	Getr.Öl ATF E-S	j		-	-	dg	7
Outlander (Sport), Airtrek 2.0 Turbo	'03-'09	4,6		●	●			●	2,2/2,8	Getr.Öl SNS-B 75W-80	-	l		↔	↔	d	7
Outlander 2.0 4x2, 4x4	'10-	4	●	●	●			●	2,5	Getr.Öl SNS-A 75W-85	Spezialprodukt	p		0,5	Getriebeöl BS 75W-90		7,5
Outlander 2.4, ClearTec FFV	'07-	4,3	●	●	●			●	2,5	Getr.Öl SNS-A 75W-85	Spezialprodukt	p		0,5	Getriebeöl BS 75W-90		7,5
Outlander 3.0	'07-	4,3	●	●	●			●	-	-	Spezialprodukt	p		0,5	Getriebeöl BS 75W-90		7,5
Eclipse 2.0, 4WD	'91-'98	4,3-4,4		●	●			●	2-2,4	Getr.Öl SNS-A 75W-85	Getr.Öl ATF E-S	b		↔	↔	e	6,5-7
3000 GT, Turbo, 4WD	'96-'01	4,6			●			●	2,4	Getr.Öl SNS-A 75W-85	Getr.Öl ATF E-S	b		↔	↔	e	8
<b>Diesel</b>																	
Colt 1.5 Di-D	'04-'07	5,5	●					●	1,8	Getr.Öl SNS-A 75W-85	Spezialprodukt			↔	↔		6,6
Lancer 2.0 D	'92-'96	5,1			●			●	1,8	Getr.Öl SNS-A 75W-85	-			↔	↔		6
Lancer (Sportback) 1.8 Di-D, ClearTec	'08-	5		●	●			●	2,5	Getr.Öl SNS-A 75W-85	-			↔	↔		7,5
Carisma 1.9 TD	'96-'05	5,1-5,5		●	●			●	3,4	Getr.Öl EP Synth 75W-90	-			↔	↔		6
Carisma, Space Star 1.9 Di-D	'01-'06	5		●	●			●	2,1	Getr.Öl SNS-A 75W-85	Getr.Öl ATF E-S			↔	↔		6
Galant 2.0 TD	'92-'04	4,8						●	1,8-2,2	Getr.Öl SNS-A 75W-85	-			↔	↔		8
Space Runner 2.0 TD	'91-'98	4,8			●			●	2,2	Getr.Öl SNS-A 75W-85	-			↔	↔		7,5
Space Wagon 1.8 TD, 2.0 TD	'91-'99	5,1			●			●	2,2	Getr.Öl SNS-A 75W-85	-			↔	↔		7,5
Grandis 2.0 Di-D	'05-'10	4			●			●	2	Getr.Öl SNS-A 75W-85	-			↔	↔		8-9,5
Grandis 2.0 Di-D DPF	'05-'10	4			●			●	2	Getr.Öl SNS-A 75W-85	-			↔	↔		8-9,5
Space Gear 2.5 TD, 4WD	'94-'00	6,9			●			●	2,3	Getr.Öl SNS-A 75W-85	c			-	-	dfg	9-10
ASX / RVR 1.8 Di-D 4x2, 4x4, ClearTec	'10-	5		●	●			●	2,2	Getr.Öl SNS-A 75W-85	o			0,5	Getriebeöl BS 75W-90		7,5
Pajero, Shogun 2.5 TD, 2.8 TD	'91-'01	6,5-7,8			●			●	2,5/3,7	Getr.Öl SNS-A 75W-85	c			-	-	egh	8-10,5
Pajero, Shogun 2.5 TD, 3.2 Di-D	'01-'07	7,3/9,6		●	●			●	3,2	Getr.Öl SNS-A 75W-85	c			-	-	dgh	9-10,5
Pajero, Shogun 3.2 Di-D	'07-	9,3	●	●	●			●	3,2	Getr.Öl SNS-A 75W-85	m			1,2/1,6	Getriebeöl BS 75W-90	h	9-10,5
Pajero, Shogun 3.2 Di-D DPF	'07-	9,3		●	●			●	3,2	Getr.Öl SNS-A 75W-85	m			1,2/1,6	Getriebeöl BS 75W-90	h	9-10,5
Outlander 2.0 Di-D	'07-'10	5,5			●			●	2	Getr.Öl SNS-B 75W-80	q			0,5	Getriebeöl BS 75W-90	h	8



Outlander 2.2 DI-D (103 kW, 130 kW), ClearTec, 4x2, 4x4	'10-	5,5		●	●	●	●	2,2	Getr.Öl SNS-A 75W-85	o	-	0,5	Getriebeöl Hyp 80W	8,3
Outlander 2.2 DI-D (115 kW) 4x4 TC SST	'10-	5	HighTronic J 5W-30					-	-		Spezialprodukt	0,5	Getriebeöl Hyp 80W	7,6

- a Drehmomentverteiler, AYC: Getr.Öl ATF E-S
- c Verteilergetriebe: 2,2-2,6 l Getr.Öl SNS-A 75W-85
- e Differential, hinten (4WD): 0,7-1,1 l Getriebeöl BS 75W-90; Getriebeöl HYP Synth 75W-90
- g Sperrdifferential: Getr.Öl BS LSX 75W-140; Getr.Öl HYP LS 85W-90
- j Verteilergetriebe: 0,55 l: >10°C: Getriebeöl BS 75W-90; Getriebeöl HYP Synth 75W-90; Verteilergetriebe: 0,55 l: <10°C: Getriebeöl Hyp 80W
- l Verteilergetriebe: 0,6 l Getr.Öl BS LSX 75W-140; Getr.Öl HYP LS 85W-90
- n CVT (Automat): Spezialprodukt, bitte auf Originalersatzteil des Herstellers zurückgreifen!
- p Hydraulisches Allradsystem: Getr.Öl ATF E-S
- r Verteilergetriebe: 0,6 l Getriebeöl BS 75W-90; Getriebeöl HYP Synth 75W-90

- b Verteilergetriebe: 0,3-1 l Getr.Öl SNS-A 75W-85
- d Differential, hinten: >10°C: Getriebeöl BS 75W-90; Getriebeöl HYP Synth 75W-90; Differential, hinten: <10°C: Getriebeöl Hyp 80W
- f Differential, vorn (4WD): 0,9 l Getr.Öl SNS-A 75W-85
- h Differentiale, vorn und hinten
- k Verteilergetriebe: 0,6-0,9 l Getr.Öl HYP LS 85W-90
- m Verteilergetriebe: 2,8 l Getr.Öl SNS-A 75W-85
- o Verteilergetriebe: 0,49 l Getriebeöl Hyp 80W
- q Verteilergetriebe: 0,54 l Getriebeöl BS 75W-90; Getriebeöl HYP Synth 75W-90

## NISSAN

Pixo 1.0	'09-	2,9	●	●	●	●	2,2	Getr.Öl SNS-A 75W-85			Getriebeöl ATF J	↔	↔	4,3		
Micra 1.0, 1.3, 1.4	'92-'02	3-3,1		●	●	●	2,8-3,3	Getr.Öl SNS-A 75W-85	Getr.Öl ATF E-S		Getriebeöl ATF 55	↔	↔	4		
Micra 1.0, 1.2, 1.4	'03-'10	3		●	●	●	2,6	Getr.Öl SNS-A 75W-85			Getriebeöl ATF J	↔	↔	4,9-5,3		
Micra / March 1.2	'11-	3,4	●	●	●	●	2,7	Getr.Öl SNS-A 75W-85			Getriebeöl ATF J	o	↔	5,5-5,7		
Micra / March 1.2 DIG-S	'11-	3,9	●	●	●	●	2,7	Getr.Öl SNS-A 75W-85			Getriebeöl ATF J	o	↔	5,4-5,9		
Micra / March 1.5	'11-	3	●	●	●	●	2,7	Getr.Öl SNS-A 75W-85			Getriebeöl ATF J	o	↔	5,6-6		
Micra 1.6	'05-'08	4,5		●	●	●	2,6	Getr.Öl SNS-A 75W-85			Getriebeöl ATF J		↔	5,3		
Cube 1.6	'10-'11	4,3	●	●	●	●	2,6	Getr.Öl SNS-A 75W-85		Spezialprodukt		↔	↔	5,6-6		
Note 1.4, 1.6	'06-	3,4/4,6	●	●	●	●	2,6	Getr.Öl SNS-A 75W-85			Getriebeöl ATF J		↔	4,9-6		
Leaf	'10-	-	-				-	-			Getriebeöl ATF J		↔	6,6		
Almera 1.4, 1.6, 2.0	'95-'00	3,2-3,4		●	●	●	3,2-3,7	Getr.Öl SNS-A 75W-85	Getr.Öl ATF E-S		Getriebeöl ATF 55		↔	6-6,5		
Almera, Tino 1.5, 1.8	'00-'06	2,7	●	●	●	●	3	Getr.Öl SNS-A 75W-85	Getr.Öl ATF E-S		Getriebeöl ATF 55		↔	4,5-7		
Almera 2.0	'00-'01	3,7	●	●	●	●	-	-		Spezialprodukt		↔	↔	6,6		
Tiida 1.4, 1.6	'07-	3,4-4,5	●	●	●	●	2,6	Getr.Öl SNS-A 75W-85			Getriebeöl ATF J		↔	5-6,3		
Tiida 1.8	'07-	4,5	●	●	●	●	2	Getr.Öl SNS-A 75W-85					↔	6,8		
Primera 1.6, 2.0	'90-'99	3,5-3,7		●	●	●	2,8	Getr.Öl SNS-A 75W-85	Getr.Öl ATF E-S		Getriebeöl ATF 55		↔	4,5-5,5		
Primera 1.6, 1.8, 2.0	'00-'02	2,9-3,7	●	●	●	●	2,9-3	Getr.Öl SNS-A 75W-85		Spezialprodukt		↔	↔	5,5-6,8		
Primera 1.6, 1.8, 2.0	'02-	2,7-3,9	●	●	●	●	2,8-3,1	Getr.Öl SNS-A 75W-85		Spezialprodukt		↔	↔	6,7-6,9		
Maxima QX 2.0 V6, 3.0 V6	'95-'04	4,1		●	●	●	4,3-4,8	Getr.Öl SNS-A 75W-85	Getr.Öl ATF E-S		Getriebeöl ATF 55		↔	7-8		
Serena 1.6, 2.0	'92-'00	2,9/3,4		●	●	●	2,1	Getr.Öl SNS-A 75W-85	Getr.Öl ATF E-S		Getriebeöl ATF 55	1,3	Getr.Öl BS LSX 75W-140	9/10		
Juke 1.6 ECO, 1.6	'10-	4,3	●	●	●	●	2,3	Spezialprodukt		Spezialprodukt		↔	↔	6,3		
Juke 1.6 DIG-T, 4x4	'10-	4,8	●	●	●	●	2	Spezialprodukt	g	Spezialprodukt	g	0,4	Getriebeöl BS 75W-90	8,1		
Qashqai 1.6, 2.0, 4x4	'07-	4,3/7,4	●	●	●	●	2-2,3	Getr.Öl SNS-A 75W-85	k	Spezialprodukt	k	↔	↔	5,9-8,9		
X-Trail 2.0, 2,5	'01-'07	3,9	●	●	●	●	2,3	Getr.Öl SNS-A 75W-85	gk		Getriebeöl ATF J	k	0,55	Getr.Öl BS LSX 75W-140	e	7,7
X-Trail 2.0, 2,5	'07-'10	4,4-5,1	●	●	●	●	2	Getr.Öl SNS-A 75W-85	gk	Spezialprodukt	k	0,55	Getriebeöl BS 75W-90	e	7/7,4	
X-Trail 2.0, 2,5	'10-	4,4-5,1	●	●	●	●	2	Getr.Öl SNS-A 75W-85	gk	Spezialprodukt	k	0,55	Getriebeöl BS 75W-90	e	7/7,4	
Murano 3.5 V6	'04-'08	4	●	●	●	●	-	-		Spezialprodukt	k	-	Getriebeöl BS 75W-90	9,6		
Murano 3.5 V6	'08-	4,6	●	●	●	●	-	-		Spezialprodukt	k	-	Getriebeöl BS 75W-90	9,4		
Terrano II 2.4	'92-'02	4,3		●	●	●	3,5	Getr.Öl SNS-A 75W-85	c	Getr.Öl ATF E-S	Getriebeöl ATF 55	c	1,3/2,8	Getriebeöl BS 75W-90	ef	7
Pathfinder, Terrano 3.3 V6, 3.5 V6	'96-'04	4,5/3,8		●	●	●	3,6	Getr.Öl SNS-A 75W-85	b	Getr.Öl ATF E-S	Getriebeöl ATF 55	b	1,9-3	Getriebeöl BS 75W-90	ef	10,8
Pathfinder 4.0 V6	'05-'10	5,1	●	●	●	●	-	-			Getriebeöl ATF J	b	-	Getriebeöl BS 75W-90	ef	10,5/13,7
Patrol R 2.8, 4.2	'92-'97	4,5/8,2		●	●	●	3,6-3,9	Getr.Öl SNS-A 75W-85	b	Getr.Öl ATF E-S	Getriebeöl ATF 55	b	2,1-5,4	Getriebeöl BS 75W-90	ef	11/16
Patrol GR 4.2	'92-'97	8,2		●	●	●	3,6-3,9	Getr.Öl SNS-A 75W-85	b	Getr.Öl ATF E-S	Getriebeöl ATF 55	b	2,1-5,4	Getriebeöl BS 75W-90	ef	16
Patrol 5.6 V8	'10-	6,5	●	●	●	●	-	-			Getriebeöl ATF J	p	2,3	Getriebeöl BS 75W-90	e	9,2-11
200 SX	'94-'99	3,7		●	●	●	2,4	Getr.Öl SNS-A 75W-85	Getr.Öl ATF E-S		Getriebeöl ATF 55		1,8	Getr.Öl BS LSX 75W-140	6,2	
350Z	'03-'09	4,7	●	●	●	●	2,9	Getr.Öl SNS-A 75W-85			Getriebeöl ATF J	1,4	Getr.Öl BS LSX 75W-140	7,9		
370Z	'09-	4,9	●	●	●	●	2,8	Getr.Öl SNS-A 75W-85			Getriebeöl ATF J	1,4	Getriebeöl BS 75W-90	9,1-9,2		
GT-R	'08-	5,5		●	●	●	-	Spezialprodukt		-		-	Getr.Öl BS LSX 75W-140	11		
<b>Diesel</b>																
Micra 1.5 Diesel	'01-'03	4,4		●	●	●	2,8-3,3	Getr.Öl SNS-A 75W-85	-			↔	↔	6,3		
Micra 1.5 dCi	'03-'08	4,6		●	●	●	2,5-2,6	Getr.Öl SNS-A 75W-85	-			↔	↔	6,5		
Micra 1.5 dCi (63 kW)	'07-'10	4,6		●	●	●	2,5-2,6	Getr.Öl SNS-A 75W-85	-			↔	↔	7		
Cube 1.5 dCi, DPF	'10-	4,7	HighTronic R 5W-30				2	Spezialprodukt		Spezialprodukt		↔	↔	8,7		
Note 1.5 dCi	'06-'09	4,4		●	●	●	2,6	Getr.Öl SNS-A 75W-85	-			↔	↔	6		
Note 1.5 dCi	'09-	4,4		●	●	●	2,6	Getr.Öl SNS-A 75W-85	-			↔	↔	6		

		SuperTronic						HighTronic			Blue Tronic	Aral	⚠	Aral		⚠	Aral	⚠		
		G 0W-30	0W-40	LL III 5W-30	M 5W-40	5W-40	G 5W-30	10W-40	Aral	Synthese	Mineral									
																				
Note 1.5 dCi DPF Euro 4	'09-	4,4	●			●				2,6	Getr.Öl SNS-A 75W-85	-			↔	↔		6,7		
Note 1.5 dCi DPF Euro 5	'10-	4,4	HighTronic R 5W-30								2,5	Getr.Öl SNS-A 75W-85	-			↔	↔		6,7	
Almera 1.5 dCi	'02-'06	4,6	●							2,3	Getr.Öl SNS-A 75W-85	-			↔	↔		6,5		
Almera 2.0 Diesel	'95-'00	5,2		●						-	Getr.Öl SNS-A 75W-85	-			↔	↔		5,2		
Almera, Tino 2.2 Di, DT	'00-'03	6,1	●	●						3	Getr.Öl SNS-A 75W-85	-			↔	↔		8		
Almera, Tino 2.2 dCi	'03-'06	5,4	●	●						2,3	Getr.Öl SNS-A 75W-850	-			↔	↔		8,7		
Tiida 1.5 dCi	'07-	4,4		●						2	Getr.Öl SNS-A 75W-85	-			↔	↔		7		
Primera 1.9 dCi	'03-'06	4,7		●						2,1	Getr.Öl SNS-A 75W-85	-			↔	↔		6,5		
Primera 2.0 D	'90-'96	4,7		●						2,8	Getr.Öl SNS-A 75W-85	Getr.Öl ATF E-S	Getriebeöl ATF 55		↔	↔		5,5		
Primera 2.0 TD	'96-'99	4,7		●						2,8	Getr.Öl SNS-A 75W-85	Getr.Öl ATF E-S	Getriebeöl ATF 55		↔	↔		5,5		
Primera 2.0 TD	'00-'02	5,1		●						2,8	Getr.Öl SNS-A 75W-85	-			↔	↔		6,4		
Primera 2.2 DCT, dCi	'02-'06	5,4	●	●						2,3	Getr.Öl SNS-A 75W-85	-			↔	↔		9,5		
Serena 2.3 Diesel	'96-'00	7		●						2,1	Getr.Öl SNS-A 75W-85	-			1,5	Getriebeöl BS 75W-90		13,7-14,5		
Juke 1.5 dCi	'10-	4,4	HighTronic R 5W-30								2	Spezialprodukt	-			↔	↔		9,6	
Qashqai 1.5 dCi	'07-	4,4						●		2	Getr.Öl SNS-A 75W-85	-			↔	↔		7,3		
Qashqai 1.5 dCi Euro 5	'10-	4,4	HighTronic R 5W-30								2	Getr.Öl SNS-A 75W-85	-			↔	↔		7-7,4	
Qashqai 1.6 dCi DPF, 4WD	'10-	5,5	HighTronic R 5W-30								2	Spezialprodukt	-			0,4-0,6	Getriebeöl BS 75W-90		8	
Qashqai 2.0 dCi, 2.0dCi 4x4	'08-'10	7,4		●				●		2	Getr.Öl SNS-A 75W-85		Getriebeöl ATF J		0,4-0,6	Getriebeöl BS 75W-90		8-8,4		
Qashqai 2.0 dCi, 2.0dCi 4x4 DPF	'10-	7,4	HighTronic R 5W-30								2	Spezialprodukt		Getriebeöl ATF J		0,4-0,6	Getriebeöl BS 75W-90		8-8,4	
X-Trail 2.2 Cdi	'01-'03	5,2		●					●	2,3	Getr.Öl SNS-A 75W-85	g	-		0,55	Getr.Öl BS LSX 75W-140	e	10		
X-Trail 2.2 dCi	'03-'07	5,2		●					●	2,3	Getr.Öl SNS-A 75W-85	g	-		0,55	Getr.Öl BS LSX 75W-140	e	10		
X-Trail 2.2 dCi DPF	'05-'07	5,2		●						2,3	Getr.Öl SNS-A 75W-85	g	-		0,55	Getr.Öl BS LSX 75W-140	e	10		
X-Trail 2.0 dCi	'07-'10	7,4		●						2	Getr.Öl SNS-A 75W-85	g	-		0,55	Getriebeöl BS 75W-90	e	8,4/8,7		
X-Trail 2.0 dCi DPF	'07-'10	7,4		●						2	Getr.Öl SNS-A 75W-85	g	-		0,55	Getriebeöl BS 75W-90	e	8,4/8,7		
X-Trail 2.0 dCi DPF	'10-	7,4	HighTronic R 5W-30								2	Getr.Öl SNS-A 75W-85	r	-		0,55	Getriebeöl BS 75W-90	e	8,4/8,7	
Murano 2.5 dCi	'10-	6,6	HighTronic R 5W-30								-	-		Getriebeöl ATF J	k	0,55	Getriebeöl BS 75W-90		11	
Terrano II 2.7 TD	'93-'00	6,2-7,2		●					●	3,5	Getr.Öl SNS-A 75W-85	c	-		1,3/2,8	Getriebeöl BS 75W-90	ef	10		
Terrano II 2.7 TD, 3.0 Di	'00-	6,2-6,7		●					●	3,5	Getr.Öl SNS-A 75W-85	b	-		1,3	Getriebeöl BS 75W-90	ef	10		
Pathfinder 2.5 dCi	'05-'10	7,6		●						4,3	Getr.Öl SNS-A 75W-85	l		Getriebeöl ATF J	l	0,9/1,8	Getriebeöl BS 75W-90	e	9,9-13,1	
Pathfinder 2.5 dCi DPF	'06-'10	7,6		●						4,3	Getr.Öl SNS-A 75W-85	l		Getriebeöl ATF J	l	0,9/1,8	Getriebeöl BS 75W-90	e	10,2-13,4	
Pathfinder 2.5 dCi	'10-	6,9		●						4,3	Getr.Öl SNS-A 75W-85	q		Getriebeöl ATF J	q	1,8	Getriebeöl BS 75W-90	a	10,1-13,3	
Pathfinder 2.5 dCi DPF	'10-	6,9		●						4,3	Getr.Öl SNS-A 75W-85	q		Getriebeöl ATF J	q	1,8	Getriebeöl BS 75W-90	a	10,1-13,3	
Pathfinder 3.0 dCi DPF	'10-	7,1	HighTronic R 5W-30								4,3	Getr.Öl SNS-A 75W-85	p		Getriebeöl ATF J	p	1,8	Getriebeöl BS 75W-90	a	13,2-14,6
Patrol R 2.8 D, 4.2 D	'91-'95	6,4/9,2		●					●	3,6-3,9	Getr.Öl SNS-A 75W-85	b	Getr.Öl ATF E-S	Getriebeöl ATF 55	b	2,1-5,4	Getriebeöl BS 75W-90	ef	13,6	
Patrol GR 2.8 TD	'88-'98	6,4		●					●	5,1	Getr.Öl SNS-A 75W-85	b	Getr.Öl ATF E-S	Getriebeöl ATF 55	b	2,1-5,4	Getriebeöl BS 75W-90	ef	12,4-13,6	
Patrol GR 2.8 TD, TDi	'98-'00	6,4		●					●	5,1	Getr.Öl SNS-A 75W-85	b	Getr.Öl ATF E-S	Getriebeöl ATF 55	b	2,1-5,4	Getriebeöl BS 75W-90	eh	11,6-12,9	
Patrol GR 3.0 Di	'00-'10	5,7-8,2		●					●	3,5	Getr.Öl SNS-A 75W-85	b	Getr.Öl ATF E-S	Getriebeöl ATF 55	b	2,1-5,4	Getriebeöl BS 75W-90	eh	11,6	
Patrol GR 4.2 D	'97-'10	10,5		●					●	3,5	Getr.Öl SNS-A 75W-85	b	Getr.Öl ATF E-S	Getriebeöl ATF 55	b	2,1-5,4	Getriebeöl BS 75W-90	eh	11,6	
Patrol GR 4.2 TD	'97-'02	10,5		●					●	3,5	Getr.Öl SNS-A 75W-85	b	Getr.Öl ATF E-S	Getriebeöl ATF 55	b	2,1-5,4	Getriebeöl BS 75W-90	eh	11,6	
Navara 2.5 dCi	'05-'07	7,6		●					●	4-4,3	Getr.Öl SNS-A 75W-85	m	Getriebeöl ATF J		m	0,9/2	Getriebeöl BS 75W-90	ej	9,9-10,2	

- a Differential, vorn: Getriebeöl BS 75W-90; Getriebeöl SNA-C 75W-90
- c Verteilergetriebe: 2,3 l Getr.Öl ATF E-S; Getriebeöl ATF 55
- f Sperrdifferential: Getr.Öl BS LSX 75W-140; Getr.Öl HYP LS 85W-90
- h Sperrdifferential: Getr.Öl BS LSX 75W-140
- k Verteilergetriebe: Getriebeöl BS 75W-90; Getriebeöl SNA-C 75W-90
- m Verteilergetriebe: Getriebeöl ATF J
- o CVT (Automat): Spezialprodukt, bitte auf Originalersatzteil des Herstellers zurückgreifen!
- q Verteilergetriebe: Getriebeöl ATF J

- b Verteilergetriebe: 1,4-2,2 l Getr.Öl SNS-A 75W-85
- e Differentiale, vorn und hinten
- g Verteilergetriebe: 0,3-0,4 l Getr.Öl BS LSX 75W-140; Getr.Öl HYP LS 85W-90
- j Sperrdifferential: Getr.Öl BS LSX 75W-140
- l Verteilergetriebe: 3 l Getr.Öl SNS-A 75W-85
- n Differential, hinten (4x4): 0,6 l Getriebeöl BS 75W-90; Getriebeöl SNA-C 75W-90
- p Verteilergetriebe: Spezialprodukt, bitte auf Originalersatzteil des Herstellers zurückgreifen!
- r Verteilergetriebe: 0,36-0,38 l Getriebeöl BS 75W-90; Getriebeöl SNA-C 75W-90

## OPEL

Agila 1.0 12V, 1.2 16V	'00-'04	3-3,5	●	●	●	●	2,2	Getr.Öl SNS-A 75W-85	-	↔	↔	4,7-4,9		
Agila 1.0 12V, 1.2 16V	'04-'08	3-3,5	●	●	●	●	1,6	Getr.Öl SNS-A 75W-85	-	↔	↔	4,7-5,2		
Agila B 1.0 12V, 1.2 16V	'08-	2,9-3,3	●	●	●	●	2,2	Getr.Öl SNS-A 75W-85	Getriebeöl ATF J	↔	↔	4,5-5,2		
ADAM 1.2 16V, 1.4 16V, ecoFLEX	'13-	4	●	●	●	●	1,6	Spezialprodukt	-	↔	↔	-		
Corsa B 1.2i, 1.4i, 1.6i 16V, GSi	'93-'01	3-3,5	●	●	●	●	1,6-1,8	Getr.Öl SNS-A 75W-85	Getr.Öl ATF E-S	Getriebeöl ATF 55	↔	↔	5,5/6	
Corsa B 1.0i 12V, 1.4i 16V	'93-'01	3-3,5	●	●	●	●	1,6	Getr.Öl SNS-A 75W-85	Getr.Öl ATF E-S	Getriebeöl ATF 55	↔	↔	4,5-5	
Corsa B 1.2i 16V	'98-'00	3,5	●	●	●	●	1,6	Getr.Öl SNS-A 75W-85	Getr.Öl ATF E-S	Getriebeöl ATF 55	↔	↔	5,2-5,5	
Corsa C 1.0 12V, 1.2 16V, 1.4 16V, Twinport	'00-'07	3-3,5	●	●	●	●	1,6	Getr.Öl SNS-A 75W-85	-	Getriebeöl ATF 55	↔	↔	4,5-5	
Corsa C 1.8 16V, GSi	'00-'07	4,5	●	●	●	●	1,6	Getr.Öl SNS-A 75W-85	-	↔	↔	5,3		
Corsa D 1.0 12V, 1.2 16V, 1.4 16V, Twinport	'07-'11	3-3,5	●	●	●	●	1,6	Getr.Öl SNS-A 75W-85	-	Getriebeöl ATF 55	↔	↔	4,5-5	
Corsa D 1.0 12V, 1.2 16V, 1.4 16V, Twinport	'11-	3-3,5	●	●	●	●	1,6	Spezialprodukt	-	Getriebeöl ATF 55	↔	↔	4,5-5	
Corsa D 1.6 Turbo, 1.6 Turbo OPC	'07-'11	4,5	●	●	●	●	2,2	Getr.Öl SNS-A 75W-85	-	↔	↔	5,8		
Corsa D 1.6 Turbo, 1.6 Turbo OPC	'11-	4,5	●	●	●	●	2,2	Spezialprodukt	-	↔	↔	5,8		
Tour 1.4 16V Twinport, 1.6 (CNG)	'05-'11	3,5	●	●	●	●	1,6	Getr.Öl SNS-A 75W-85	-	Getriebeöl ATF 55	↔	↔	5-6,5	
Tigra 1.4i 16V, 1.6i 16V	'94-'00	3,5	●	●	●	●	1,6/1,8	Getr.Öl SNS-A 75W-85	Getr.Öl ATF E-S	Getriebeöl ATF 55	↔	↔	6	
Tigra TwinTop 1.4 16V Twinport, 1.8 16V	'04-'10	3,5-4,3	●	●	●	●	1,6	Getr.Öl SNS-A 75W-85	-	↔	↔	5-5,4		
Meriva 1.4 16V Twinport, 1.6 (16V)	'03-'10	3,5	●	●	●	●	1,6	Getr.Öl SNS-A 75W-85	-	↔	↔	6,8-7,1		
Meriva 1.6 16V Twinport, 1.8 16V	'03-'10	4,4-3	●	●	●	●	1,6	Getr.Öl SNS-A 75W-85	-	↔	↔	6,5-7,1		
Meriva 1.6 16V Turbo, 1.6 16V Turbo OPC	'06-'10	4,5	●	●	●	●	2,2	Getr.Öl SNS-A 75W-85	-	↔	↔	6,3		
Meriva B 1.4, 1.4 Turbo	'10-'11	4	●	●	●	●	1,6	Getr.Öl SNS-A 75W-85	h	-	↔	↔	6-6,2	
Meriva B 1.4, 1.4 Turbo, ecoFLEX, ecoFLEX LPG	'11-	4	●	●	●	●	1,6	Spezialprodukt	m	-	↔	↔	6-6,2	
Astra F 1.4, 1.6, 1.8, 2.0, 16V, i, GSi	'91-'98	3,5-4,5	●	●	●	●	1,6/1,9	Getr.Öl SNS-A 75W-85	Getr.Öl ATF E-S	Getriebeöl ATF 55	↔	↔	5,5-7	
Astra G 1.2, 1.4, 1.6, 1.8, 2.0 16V	'98-'04	3,3-5,3	●	●	●	●	1,6/1,8	Getr.Öl SNS-A 75W-85	-	Getriebeöl ATF 55	↔	↔	5-7,5	
Astra G 2.0 16V Turbo, OPC, 2.2 16V	'99-'04	4,3-5,3	●	●	●	●	1,6/1,8	Getr.Öl SNS-A 75W-85	-	↔	↔	5-7,5		
Astra G Classic II 1.4 16V Twinport, 1.6 16V Twinport	'03-'04	3,5/4	●	●	●	●	1,6	Getr.Öl SNS-A 75W-85	-	↔	↔	5,2-5,5		
Astra H 1.4 16V Twinport, 1.6 16V Twinport	'04-'10	3,5/4	●	●	●	●	1,6	Getr.Öl SNS-A 75W-85	-	↔	↔	5,6-6,9		
Astra H 1.6 16V Turbo, 1.6 OPC	'07-'10	4,5	●	●	●	●	2,2	Getr.Öl SNS-A 75W-85	-	↔	↔	5,9/5,8		
Astra H 1.8 16V, 2.0 16V Turbo, 2.0 OPC	'04-'10	4,3	●	●	●	●	1,6/2,4	Getr.Öl SNS-A 75W-85	-	Getriebeöl ATF 55	↔	↔	6,1-7,7	
Astra J 1.4, 1.4 Turbo, 1.6, 1.6 Turbo, ecoFLEX	'09-'11	3,75-4,5	●	●	●	●	1,6-2	Getr.Öl SNS-A 75W-85	h	Spezialprodukt	↔	↔	-	
Astra J 1.4, 1.4 Turbo, 1.6, 1.6 Turbo, ecoFLEX	'11-	3,75-4,5	●	●	●	●	1,6-2	Spezialprodukt	m	Spezialprodukt	↔	↔	-	
Ampera	'11-	3,5	●	●	●	●	-	-	-	Spezialprodukt	↔	↔	-	
Zafira 1.6 16V, 1.8 16V	'99-'05	3,3-4,3	●	●	●	●	1,8	Getr.Öl SNS-A 75W-85	-	Getriebeöl ATF 55	↔	↔	6,3-6,8	
Zafira OPC, 2.2 16V	'02-'05	4,3/5	●	●	●	●	1,6	Getr.Öl SNS-A 75W-85	-	↔	↔	6,8-7,4		
Zafira B 1.6 16V CNG, 1.6 CNG Turbo, 1.6 16V, 1.8 16V	'05-'11	4,5	●	●	●	●	1,6	Getr.Öl SNS-A 75W-85	h	-	↔	↔	6,1-6,3	
Zafira B 2.0 16V Turbo, OPC, 2.2 16V Direct	'05-'10	4,3/5	●	●	●	●	1,6	Getr.Öl SNS-A 75W-85	h	Getriebeöl ATF 55	↔	↔	7,1-7,7	
Zafira Tourer 1.4 Turbo, 1.6 Turbo CNG	'12-	4,4-5	●	●	●	●	2,2	Spezialprodukt	-	Spezialprodukt	↔	↔	6,2	
Zafira Tourer 1.8	'12-	4,5	●	●	●	●	1,6	Spezialprodukt	-	↔	↔	6,2		
Calibra 2.0i (16V), 2.5i V6, 4x4	'89-'99	4,4-5	●	●	●	●	1,9	Getr.Öl SNS-A 75W-85	d	Getr.Öl ATF E-S	Getriebeöl ATF 55	↔	↔	b 7-7,5
Calibra 2.0i 16V Turbo 4x4	'92-'99	4,9	●	●	●	●	1,9	Getr.Öl SNS-A 75W-85	d	Getr.Öl ATF E-S	Getriebeöl ATF 55	↔	↔	b 7,2
Vectra B 1.6, 1.8, 2.0, 16V, 2.5 V6, 2.6 V6	'95-'02	3,3-4,8	●	●	●	●	1,6-1,9	Getr.Öl SNS-A 75W-85	-	Getriebeöl ATF 55	↔	↔	6-8	
Vectra C, Signum 1.6 16V (Twinport), 1.8 16V	'02-'09	3,5-4,5	●	●	●	●	1,6	Getr.Öl SNS-A 75W-85	-	Spezialprodukt	e	↔	↔	5,5-6,1
Vectra C, Signum 2.2 16V Direct, 3.2 V6	'02-'09	4,8-5	●	●	●	●	1,6-2,4	Getr.Öl SNS-A 75W-85	Getr.Öl ATF E-S	Getriebeöl ATF J	↔	↔	7,1-7,9	
Vectra C, Signum 2.0 16V Turbo, 2.8 V6 Turbo (OPC)	'03-'09	6	●	●	●	●	3,2	Getr.Öl SNS-A 75W-85	-	Getriebeöl ATF 55	↔	↔	7,5	
Insignia 1.4 Turbo	'11-	4	●	●	●	●	2,2	Spezialprodukt	-	↔	↔	-		
Insignia 1.6, 1.6 Turbo, 1.8	'08-'11	4,5	●	●	●	●	2,2	Getr.Öl SNS-A 75W-85	-	↔	↔	-		
Insignia 1.6, 1.6 Turbo	'11-	4,5	●	●	●	●	2,2	Spezialprodukt	-	↔	↔	-		
Insignia 2.0 Turbo, 2.8 V6 Turbo, 4x4, OPC	'08-'11	6	●	●	●	●	1,6	Getr.Öl SNS-A 75W-85	k	Getriebeöl ATF 55	k	0,6	Spezialprodukt	-
Insignia 2.0 Turbo, 2.8 V6 Turbo, 4x4, OPC	'11-	6	●	●	●	●	1,6	Spezialprodukt	k	Spezialprodukt	k	0,6	Spezialprodukt	-
Omega 2.0i (16V)	'94-'01	4,5	●	●	●	●	1,2	Getr.Öl SNS-A 75W-85	-	Getr.Öl ATF E-S	Getriebeöl ATF 55	1	Getr.Öl BS LSX 75W-140	8,5-9,5

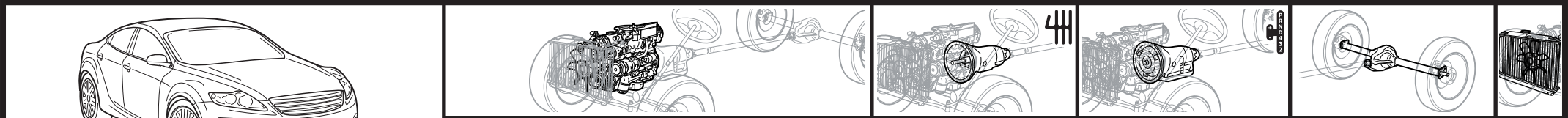

	SuperTronic			HighTronic			Blue Tronic		Aral	⚠	Aral		⚠		Aral	⚠	
	G 0W-30	0W-40	LL III 5W-30	M 5W-40	5W-40	G 5W-30	10W-40				Synthese	Mineral					

<b>OPEL</b>																		
Omega 2.2i 16V	'99-'01	4,5/5,8	●	●		●			●	1,2	Getr.Öi SNS-A 75W-85		Getr.Öi ATF E-S	Getriebeöl ATF 55		1	Getr.Öi BS LSX 75W-140	8,5-9,5
Omega 2.5i V6, 3.0i V6	'94-'01	5,5-5,8	●	●		●			●	1,2	Getr.Öi SNS-A 75W-85		Getr.Öi ATF E-S	Getriebeöl ATF 55		1	Getr.Öi BS LSX 75W-140	9,5
Omega 2.2i 16V, 2.6i V6, 3.2i V6	'01-'03	4,5-5,8	●	●		●			●	1,2	Getr.Öi SNS-A 75W-85		Getr.Öi ATF E-S	Getriebeöl ATF 55		1	Getr.Öi BS LSX 75W-140	9,4-9,7
Omega V8	'01-'01	6	●					●	-	-	-		Getr.Öi ATF E-S	Getriebeöl ATF 55		1,6	Getr.Öi BS LSX 75W-140	9,7
Sintra 2.2, 3.0	'96-'99	4,5	●			●			●	1,8	Getr.Öi SNS-A 75W-85		Getr.Öi ATF E-S	Getriebeöl ATF 55		↔	↔	6
Mokka 1.4 Turbo	'12-	4								1,9	Spezialprodukt		-	-		↔	↔	-
Mokka 1.6	'12-	4,5							●	1,6	Spezialprodukt		-	-		↔	↔	-
Antara 2.4	'06-'11	4,5	●						●	2,1	Getr.Öi SNS-B 75W-80	g		Getriebeöl ATF J	g	0,6	Getriebeöl BS 75W-90	9
Antara 2.4, 4x4	'11-	4,7							●	2,2	Getr.Öi SNS-B 75W-80	g	Spezialprodukt		g	-	Getriebeöl BS 75W-90	9
Antara 3.2 V6	'06-'11	7,4	●						●	-	-			Getriebeöl ATF J	g	0,6	Getriebeöl BS 75W-90	10
Frontera 2.0i	'91-'98	4,5	●	●		●			●	4,4	SuperTronic 0W-40	-	-			0,9-2,4	Getr.Öi BS LSX 75W-140	c 8,5
Frontera 2.2i, 2.4i	'91-'98	5/5,5	●	●		●			●	3	SuperTronic 0W-40	a	-			1,7-2,4	Getr.Öi BS LSX 75W-140	c 8-8,5
Frontera B 2.2 16V, 3.2 24V	'98-'04	4,5-5,6	●	●		●			●	3	SuperTronic 0W-40	a	Getr.Öi ATF E-S	Getriebeöl ATF 55		1,7-2,3	Getriebeöl BS 75W-90	c 7-11
Monterey 3.2 V6, 3.5 V6	'92-'00	5,2	●	●		●			●	3	SuperTronic 0W-40		Getr.Öi ATF E-S	Getriebeöl ATF 55	a	1,5/1,8	Getriebeöl BS 75W-90	c 8,5/9
Speedster 2.0 16V Turbo, 2.2 16V	'01-'05	4,5/5,5	●	●		●			●	1,8	Getr.Öi SNS-A 75W-85		-	-		↔	↔	12,3-13,2
GT 2.0 Turbo	'07-'09	4,8	●						●	2,6	Getr.Öi SNS-A 75W-85		-	-		1	Getr.Öi BS LSX 75W-140	9
<b>Diesel</b>																		
Agila 1.3 CDTi	'04-'08	3,3	●	●					●	1,6	Getr.Öi SNS-A 75W-85		-	-		↔	↔	5,3
Agila B 1.3 CDTi	'08-	3,2	●						●	2,6	Getr.Öi SNS-A 75W-85		-	-		-	-	5,3
Corsa B 1.5 D, TD	'93-'00	3,8-4,3	●	●			●		●	1,8	Getr.Öi SNS-A 75W-85		-	-		↔	↔	6-6,3
Corsa B 1.7 D	'93-'00	3,8-4,3	●	●			●		●	1,6	Getr.Öi SNS-A 75W-85		-	-		↔	↔	6
Corsa C 1.7 Di, DTi	'00-'04	4,5	●	●			●		●	1,6	Getr.Öi SNS-A 75W-85		-	-		↔	↔	6,1-7,1
Corsa C 1.3, 1.7 CDTi	'04-'07	3,2-4,5	●	●			●		●	1,6	Getr.Öi SNS-A 75W-85		-	-		↔	↔	6,3-7,1
Corsa D 1.3 CDTi, 1.3 CDTi ecoFLEX, 1.7 CDTi	'07-'11	3,2/5,4	●	●			●		●	1,6-2,4	Getr.Öi SNS-A 75W-85		-	-		↔	↔	6,3-7,1
Corsa D 1.3 CDTi, 1.3 CDTi ecoFLEX, 1.7 CDTi	'11-	3,2/5,4	●	●			●		●	1,6-2,4	Spezialprodukt		-	-		↔	↔	6,3-7,1
Tour 1.3 CDTi, 1.7 Di, Dt, CDTi	'04-'11	3,2/4,5	●	●			●		●	1,6	Getr.Öi SNS-A 75W-85		-	-		↔	↔	6,1-7,1
Tour 1.7 Di, Dt	'02-'04	4,5	●	●			●		●	1,6	Getr.Öi SNS-A 75W-85		-	-		↔	↔	6,1-7,1
Tigra TwinTop 1.3 CDTi	'04-'10	3,2	●	●			●		●	1,6	Getr.Öi SNS-A 75W-85		-	-		↔	↔	6,3
Meriva 1.3 CDTi (DPF), 1.7 DTi, CDTi	'03-'10	3,2-4,5	●	●			●		●	1,6	Getr.Öi SNS-A 75W-85		-	-		↔	↔	-
Meriva B 1.3 CDTi, 1.7 CDTi	'10-'11	3,2-5,4	●	●			●		●	2,2	Getr.Öi SNS-A 75W-85			Getriebeöl ATF 55		↔	↔	6,2-7,1
Meriva B 1.3 CDTi, 1.7 CDTi	'11-	3,2-5,4	●	●			●		●	1,6	Spezialprodukt	m		Getriebeöl ATF 55		↔	↔	6,2-7,1
Astra F 1.7 D, Turbo D, DTL	'91-'98	4,5-5,5	●	●			●		●	1,6-1,9	Getr.Öi SNS-A 75W-85		Getr.Öi ATF E-S	Getriebeöl ATF 55		↔	↔	7-8
Astra G 1.7 TD, 2.0 Di	'98-'04	5,5	●	●			●		●	1,6-1,8	Getr.Öi SNS-A 75W-85			Getriebeöl ATF 55		↔	↔	7,9-8,7
Astra G 1.7 DTi, 2.0 Dt, 2.2 Dt	'99-'04	4,5-5,5	●	●			●		●	1,6-1,8	Getr.Öi SNS-A 75W-85			Getriebeöl ATF 55		↔	↔	6-9
Astra G Classic II 1.7 CDTi	'03-'04	4,5	●	●			●		●	1,6	Getr.Öi SNS-A 75W-85		-	-		↔	↔	7,1
Astra H 1.3, 1.9 CDTi, DPF	'04-	3,1-4,3	●	●			●		●	2,4	Getr.Öi SNS-A 75W-85		-	-		↔	↔	7-7,6
Astra H 1.7 CDTi (59kW), 1.7 CDTi (74kW)	'04-'06	4,5-5	●	●			●		●	1,6-1,8	Getr.Öi SNS-A 75W-85		-	-		↔	↔	6,8
Astra H 1.7 CDTi (81kW), 1.7 CDTi (92kW)	'08-	5,4	●	●			●		●	2,4	Getr.Öi SNS-A 75W-85		-	-		↔	↔	7,1
Astra J 1.3 CDTi, 1.7 CDTi, 2.0 CDTi	'09-'11	3,2-5,4	●	●			●		●	1,6-2	Getr.Öi SNS-A 75W-85		h	-		↔	↔	-
Astra J 1.3 CDTi, 1.7 CDTi, 2.0 CDTi	'11-	3,2-5,4	●	●			●		●	1,6-2	Spezialprodukt	m	Spezialprodukt			↔	↔	-
Zafira 2.0 Di, DTi, 2.2 DTi	'99-'05	5,5	●	●			●		●	1,6-1,8	Getr.Öi SNS-A 75W-85		-	-		↔	↔	6-8
Zafira B 1.7 CDTi, 1.9 CDTi DPF	'05-'11	4,3-5,4	●	●			●		●	2,2	Getr.Öi SNS-A 75W-85			Getriebeöl ATF 55		↔	↔	7-7,1
Zafira Tourer 2.0 CDTi (81 kW), (96 kW)	'12-	4,5							●	2,2	Spezialprodukt		-	-		↔	↔	-
Zafira Tourer 2.0 CDTi (121 kW)	'12-	4,5							●	1,8	Spezialprodukt		Spezialprodukt			↔	↔	9
Vectra B 1.7 TD, 2.0 Di, DTi, 2.2 DTi	'95-'02	4,5-5,5	●	●			●		●	1,2-1,6	Getr.Öi SNS-A 75W-85			Getriebeöl ATF 55		↔	↔	7-8
Vectra C, Signum 1.9 CDTi, DPF	'04-'09	4,3	●	●			●		●	3,2	Getr.Öi SNS-A 75W-85			Getriebeöl ATF 55		↔	↔	7-7,5
Vectra C, Signum 2.0, 2.2 DTi 16V	'02-'05	5,5	●	●			●		●	1,6-1,9	Getr.Öi SNS-A 75W-85		Getr.Öi ATF E-S	Getriebeöl ATF J		↔	↔	7,3-8,4

Vectra C, Signum 3.0 V6 CDTi, DPF	'03-'09	7,3	●	●					3,2	Getr.Öl SNS-A 75W-85		Getr.Öl ATF E-S	Getriebeöl ATF J					8,3-8,9
Insignia 2.0 CDTi, 4x4	'08-'11	4,5	●	●					1,6-2,2	Getr.Öl SNS-A 75W-85	k	Getriebeöl ATF 55	Getriebeöl ATF 55	k	0,6	Spezialprodukt		-
Insignia 2.0 CDTi, 4x4	'11-	4,5							1,6-2,2	Spezialprodukt	k	Spezialprodukt		k	0,6	Spezialprodukt		-
Insignia 2.0 BiTurbo CDTi, 4x4	'08-'10	4,5		●			●		1,6	Getr.Öl SNS-A 75W-85	k	Getriebeöl ATF 55	Getriebeöl ATF 55	k	0,6	Spezialprodukt		-
Insignia 2.0 BiTurbo CDTi, 4x4	'12-	4,5							1,6	Spezialprodukt	k	Spezialprodukt		k	0,6	Spezialprodukt		-
Omega 2.0 DTi, 2.5 TD	'97-'00	5,5/6,5	●	●			●		1,2	Getr.Öl SNS-A 75W-85		Getr.Öl ATF E-S	Getriebeöl ATF 55		1,2	Getr.Öl BS LSX 75W-140		8/10,2
Omega 2.2 DTi	'01-'03	5,5	●	●			●		1,2	Getr.Öl SNS-A 75W-85		Getr.Öl ATF E-S	Getriebeöl ATF 55		1,2	Getr.Öl BS LSX 75W-140		8
Omega 2.5 TD	'00-'03	6-6,5	●	●			●		1,2	Getr.Öl SNS-A 75W-85		Getr.Öl ATF E-S	Getriebeöl ATF 55		1,2	Getr.Öl BS LSX 75W-140		10,2
Sintra 2.2 DTi	'97-'99	5,5	●	●			●		1,8	Getr.Öl SNS-A 75W-85		-			←	←		6
Mokka 1.7 CDTi	'12-	5,4					●		2,4	Spezialprodukt		Spezialprodukt			←	←		-
Antara 2.0 CDTi	'06-'11	6,2		●			●		2,3	Getr.Öl SNS-A 75W-85	g	Getriebeöl ATF J	Getriebeöl BS 75W-90	g	0,6	Getriebeöl BS 75W-90		9
Antara 2.0 CDTi, 4x4	'11-	5,6					●		2,2	Getr.Öl SNS-A 75W-85	g	Spezialprodukt		g	-	Getriebeöl BS 75W-90		9
Frontera 2.3, 2.5, 2.8 TD	'91-'98	5,5-6,3	●	●			●		3	SuperTronic 0W-40	a				1,7-2,4	Getr.Öl BS LSX 75W-140	c	9
Frontera B 2.2 DTi	'98-'04	6,1	●	●			●		3	SuperTronic 0W-40	a	Getr.Öl ATF E-S	Getriebeöl ATF 55		1,7-2,3	Getriebeöl BS 75W-90	c	8
Monterey 3.0, 3.1 TD	'92-'00	6	●	●			●		3	SuperTronic 0W-40	a	-			1,5/1,8	Getriebeöl BS 75W-90	c	8,5

a Verteilergetriebe: 1,4 I BlueTronic 10W-40; Tronic 15W-40

c Differentiale, vorn und hinten

e CVT (Automat): Spezialprodukt, bitte auf Originalersatzteil des Herstellers zurückgreifen!

h 6-Ganggetriebe: 2,2 I Getr.Öl SNS-A 75W-85

m 6-Ganggetriebe: 2,2 I Spezialprodukt, bitte auf Originalersatzteil des Herstellers zurückgreifen!

b Differential, hinten (4WD/4x4): 0,8 I Getr.Öl HYP LS 85W-90; Getr.Öl BS LSX 75W-140

d Verteilergetriebe (Vectra, Calibra 4x4): 0,6 I Spezialprodukt, bitte auf Originalersatzteil des Herstellers zurückgreifen!

g Verteilergetriebe: 0,8 I Getriebeöl BS 75W-90; Getriebeöl SNA-C 75W-90

k Verteilergetriebe: Spezialprodukt, bitte auf Originalersatzteil des Herstellers zurückgreifen!

## PEUGEOT

iOn	'10-	-	-						-	-		Spezialprodukt			←	←		5,1
106 1.0, 1.1, 1.3, 1.4, 1.6	'91-'98	3,2-3,4				●			2	Getr.Öl EP Synth 75W-90		Getr.Öl ATF E-S	Getriebeöl ATF 55		←	←		6
106 1.0, 1.1, 1.4, 1.6 (16V)	'99-'04	3,2-3,4	●	●		●			2	Getr.Öl EP Synth 75W-90		Getr.Öl ATF E-S	Getriebeöl ATF 55		←	←		6
107 1.0	'05-'08	3,1	●	●		●			1,7	Spezialprodukt		-			←	←		4
107 1.0	'08-	3,1	●	●		●			1,7	Spezialprodukt		-			←	←		4
1007 1.4 (16V), 1.6 16V	'05-'09	2,5-3,3	●	●		●			2	Getr.Öl EP Synth 75W-90		-			←	←		5,4-5,9
205 1.0, 1.1, 1.3	'87-'98	3,3-3,5				●			1,8-2	Getr.Öl EP Synth 75W-90		-			←	←		5,8
205 1.4	'91-'99	3,5				●			2	Getr.Öl EP Synth 75W-90		-			←	←		5,8
206 1.1, 1.4 (16V), 1.6 (16V)	'98-'99	3,2-3,3	●	●		●			2	Getr.Öl EP Synth 75W-90		Spezialprodukt			←	←		6-7
206 (CC) / 206+ 1.1, 1.4 (16V), 1.6 (16V)	'00-'09	3,2-3,3	●	●		●			2	Getr.Öl EP Synth 75W-90		Spezialprodukt			←	←		6-7
206+ 1.1, 1.4	'09-	3,2				●			2	Getr.Öl EP Synth 75W-90		-			←	←		6-7
206 (CC) / 206+ 2.0 16V	'98-'99	4,3	●	●		●			2	Getr.Öl EP Synth 75W-90		Spezialprodukt			←	←		8
206 (CC) / 206+ 2.0 16V	'00-'09	4,3	●	●		●			2	Getr.Öl EP Synth 75W-90		Spezialprodukt			←	←		8
207 / 207 Compact 1.1, 1.4 (16V), 1.6 16V	'06-'09	2,5-3,3	●	●		●			2	Getr.Öl EP Synth 75W-90		-			←	←		5,3-7,2
207 / 207 Compact 1.1, 1.4 (16V), 1.6 16V	'09-	2,5-3,3				HighTronic J 5W-30			2	Getr.Öl EP Synth 75W-90		-			←	←		5,3-7,2
207 1.6 16V VTi, Turbo	'06-'09	4,3	●	●		●			2	Getr.Öl EP Synth 75W-90		Spezialprodukt			←	←		-5,3
207 1.6 16V VTi, Turbo	'09-	4,3				HighTronic J 5W-30			2	Getr.Öl EP Synth 75W-90		Spezialprodukt			←	←		-5,3
207 RC	'07-'09	-	●	●		●			1,8	Getr.Öl EP Synth 75W-90		-			←	←		-
207 RC	'09-	-				HighTronic J 5W-30			1,8	Getr.Öl EP Synth 75W-90		-			←	←		-
207 1.4 16V Vti, Compact 1.4 16V Vti	'09-	4,2				HighTronic J 5W-30			2	Getr.Öl EP Synth 75W-90		-			←	←		7,2
208 1.0i VTi, 1.2i 16V VTi	'12-	3,25				HighTronic J 5W-30			1,85-2,2	Getr.Öl EP Synth 75W-90		Spezialprodukt			←	←		-
208 1.4i 16V VTi, 1.6i 16V VTi, 1.6i 16V THP	'12-	4,25				HighTronic J 5W-30			1,85-2,2	Getr.Öl EP Synth 75W-90		-			←	←		-
306 1.1, 1.4, 1.6	'93-'98	3,2				●			2	Getr.Öl EP Synth 75W-90		-			←	←		6,5-7
306 1.4, 1.6 (16V)	'99-'03	3,2-3,3	●	●		●			2	Getr.Öl EP Synth 75W-90		-			←	←		6,5-7
306 1.8, 2.0 (16V)	'93-'99	4,2-4,8				●			2	Getr.Öl EP Synth 75W-90		-			←	←		7-7,5
306 1.8, 2.0 16V	'99-'00	4,2-5				●			2-2,2	Getr.Öl EP Synth 75W-90		-			←	←		6,5-7,5
306 1.8 16V	'97-'98	4,2-5				●			2-2,2	Getr.Öl EP Synth 75W-90		-			←	←		7,5
306 1.8 16V	'99-'00	5	●	●		●			2	Getr.Öl EP Synth 75W-90		-			←	←		7,5
306 2.0 16V	'99-'03	4,75		●		●			2	Getr.Öl EP Synth 75W-90		-			←	←		6,5
306 2.0 16V GTi	'96-'98	4,25-4,75				●			2,15	Getr.Öl EP Synth 75W-90		-			←	←		6,5
306 2.0 16V GTi	'99-'00	4,75				●			2,15	Getr.Öl EP Synth 75W-90		-			←	←		6,5
307 1.4 (16V), 1.6 16V	'01-'09	2,7-3,3	●	●		●			2	Getr.Öl EP Synth 75W-90		Spezialprodukt			←	←		5,8-6,7
307 2.0 16V	'01-'05	4,3	●	●		●			2	Getr.Öl EP Synth 75W-90		Spezialprodukt			←	←		6,2-6,9
307 2.0 16V	'05-'09	4,7	●	●		●			2	Getr.Öl EP Synth 75W-90		Spezialprodukt			←	←		6,6-6,8
308 1.4 16V VTi, 1.6 16V VTi	'07-'09	4,2-4,3	●	●		●			1,8-1,9	Getr.Öl EP Synth 75W-90		Spezialprodukt			←	←		6-6,2
308 1.4 16V VTi, 1.6 16V VTi	'09-	4,2-4,3				HighTronic J 5W-30			1,8-1,9	Getr.Öl EP Synth 75W-90		Spezialprodukt			←	←		6-6,2

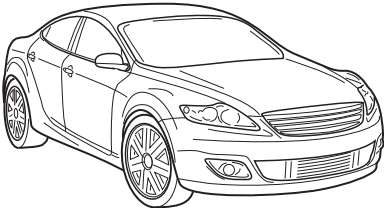
			SuperTronic						HighTronic			Blue Tronic 10W-40		Aral	⚠	Aral		⚠		Aral	⚠			
			G 0W-30	0W-40	LL III 5W-30	M 5W-40	5W-40	G 5W-30	Synthese	Mineral														
																								
<b>PEUGEOT</b>																								
308 1.6 16V VTI THP, 1.6 16V VTI THP (128 kW)	'07-'09	4,3	●	●		●							1,9-2	Getr.Öl EP Synth 75W-90		Spezialprodukt				↔	↔		6,2	
308 1.6 16V VTI THP, 1.6 16V VTI THP (128 kW)	'09-	4,3	HighTronic J 5W-30										1,9-2	Getr.Öl EP Synth 75W-90		Spezialprodukt				↔	↔		6,2	
RCZ 1.6 THP	'10-	4,2	HighTronic J 5W-30										2,2	Getr.Öl EP Synth 75W-90		Spezialprodukt				↔	↔		6,2	
406 1.6, 1.8 16V, Turbo, 3.0 V6 24V	'96-'99	4,2-5,3				●						●	1,9-2	Getr.Öl EP Synth 75W-90		Spezialprodukt				↔	↔		7-7,8	
406 1.8 16V, 2.0 16V, 3.0 V6 24V	'00-'04	4,2-5,3	●	●		●						●	1,9-2	Getr.Öl EP Synth 75W-90		Spezialprodukt				↔	↔		7-7,8	
406 1.8 8V, 2.2 16V	'97-'04	4,5-5				●						●	2	Getr.Öl EP Synth 75W-90		-				↔	↔		7-9,2	
406 2.0 16V	'96-'00	4,3				●						●	1,9	Getr.Öl EP Synth 75W-90		Spezialprodukt				↔	↔		7,8	
407 1.8 16V, 2.0 16V	'04-'07	4,3	●	●		●						●	1,9	Getr.Öl EP Synth 75W-90		Spezialprodukt				↔	↔		7,3-8,1	
407 1.8 16V, 2.0 16V	'08-'11	4,3	HighTronic J 5W-30										1,9	Getr.Öl EP Synth 75W-90		-				↔	↔		7,5	
407 2.2 16V	'04-'07	4,3		●		●						●	2,6	Getr.Öl EP Synth 75W-90		Spezialprodukt				↔	↔		7,9	
407 2.2 16V	'08-'11	4,3	HighTronic J 5W-30										2,6	Getr.Öl EP Synth 75W-90		Spezialprodukt				↔	↔		7,9-8,4	
407 3.0 V6 24V	'04-'08	4,8	●	●		●						●	-	-			Getriebeöl ATF J			↔	↔		8,4	
407 3.0 V6 24V	'09-'11	4,8	HighTronic J 5W-30										-	-		Getriebeöl ATF J				↔	↔		8,4	
508 1.6i 16V VTI, 1.6i 16V THP	'11-	-	HighTronic J 5W-30										2,1	Getr.Öl EP Synth 75W-90	de	Spezialprodukt				↔	↔		-	
605 2.0, 3.0 V6, 24V	'89-'99	5,4/6,5				●						●	1,8/2,2	Getr.Öl EP Synth 75W-90		Getr. Öl ATF E-S	Getriebeöl ATF 55			↔	↔		7,3-10	
605 2.0 16V, 2.0 Turbo, 2.9 V6 24V	'95-'01	4,3/5,3				●						●	1,8-1,9	Getr.Öl EP Synth 75W-90		Spezialprodukt				↔	↔		7,3-7,8	
607 2.0 16V, 3.0 V6 24V	'00-'05	4,3/4,9	●	●		●						●	1,9	Getr.Öl EP Synth 75W-90		Spezialprodukt				↔	↔		7,4-10,1	
607 2.2 16V	'00-'05	4,3	●	●		●						●	1,9	Getr.Öl EP Synth 75W-90		Spezialprodukt				↔	↔		7,6-8,2	
607 2.2 16V	'05-'08	4,3	●	●		●						●	1,9	Getr.Öl EP Synth 75W-90		Spezialprodukt				↔	↔		7,6-8,2	
607 3.0 V6 24V	'05-'09	4,7-5,3	●	●		●						●	-	-		Spezialprodukt				↔	↔		10-10,1	
806 1,8	'98-'99	4,25-4,75				●						●	-	Getr.Öl EP Synth 75W-90		-				↔	↔		8,5	
806 2.0, Turbo	'95-'00	4,8				●						●	1,8-2	Getr.Öl EP Synth 75W-90		-				↔	↔		8,5	
806 2.0 16V	'01-'02	4,3	●	●		●						●	1,9	Getr.Öl EP Synth 75W-90		Spezialprodukt				↔	↔		7,8	
807 2.0 16V, 3.0 V6 24V	'02-'08	4,3/4,8	●	●		●						●	1,9	Getr.Öl EP Synth 75W-90		Spezialprodukt				↔	↔		7,1/11	
807 2.0 16V (103 kW)	'08-'10	4,3	HighTronic J 5W-30										1,9	Getr.Öl EP Synth 75W-90		Spezialprodukt				↔	↔		7	
807 2.0 16V (130 kW)	'08-'10	4,3	HighTronic J 5W-30										1,9	Getr.Öl EP Synth 75W-90		Spezialprodukt				↔	↔		7	
807 2.2 16V	'02-'05	4,3	●	●		●						●	2,1	Getr.Öl EP Synth 75W-90		Spezialprodukt				↔	↔		7,2	
3008 1.6 16V THP (110 kW, 115 kW) Euro4, 1.6 16V Vti	'09-	4,3	HighTronic J 5W-30										1,9-2,2	Getr.Öl EP Synth 75W-90		Spezialprodukt	Getriebeöl ATF J			↔	↔		6,2	
3008 1.6 16V THP (110 kW, 115 kW) Euro5	'09-	4,3	HighTronic J 5W-30										1,9-2,2	Getr.Öl EP Synth 75W-90		Spezialprodukt				↔	↔		6,2	
4008 1.6i, 2.0i, 4x4	'12-	4,2-4,3	HighTronic J 5W-30										2-2,5	Getr.Öl EP Synth 75W-90	g	Spezialprodukt		g	0,5	Getriebeöl BS 75W-90				-
4007 2.4	'07-'09	4,3	HighTronic J 5W-30										2-2,5	Getr.Öl EP Synth 75W-90		-				↔	↔		7,5	
4007 2.4	'09-'12	4,25	HighTronic J 5W-30										2-2,5	Getr.Öl EP Synth 75W-90	f	Spezialprodukt		f	0,5	Getriebeöl BS 75W-90				7,5
5008 1.6 16V THP Euro4, 1.6 16V Vti	'09-	4,3	HighTronic J 5W-30										1,9-2,2	Getr.Öl EP Synth 75W-90		Spezialprodukt	Getriebeöl ATF J			↔	↔		6,2	
5008 1.6 16V THP Euro5	'09-	4,3	HighTronic J 5W-30										1,9-2,2	Getr.Öl EP Synth 75W-90		Spezialprodukt				↔	↔		6,2	
Bipper Tepee 1.4	'09-	3,8	HighTronic J 5W-30										2	Getr.Öl EP Synth 75W-90		-				↔	↔		5,3	
Partner 1.1, 1.4, 1.6 16V	'02-'08	3-3,2	●	●		●						●	2	Getr.Öl EP Synth 75W-90		-				↔	↔		-	
Partner 1.4 CNG	'07-'08	2,75	HighTronic J 5W-30										1,8-1,9	Getr.Öl EP Synth 75W-90		-				↔	↔		5,6	
Partner Tepee 1.6 16V, 1.6 Vti	'08-	3,3	HighTronic J 5W-30										1,8-1,9	Getr.Öl EP Synth 75W-90		-				↔	↔		5,9	
Expert Tepee 2.0i	'07-	5	HighTronic J 5W-30										1,8-1,9	Getr.Öl EP Synth 75W-90		-				↔	↔		8,5	
<b>Diesel</b>																								
106 1.4, 1.5 D	'92-'98	3,5/4,5											2	Getr.Öl EP Synth 75W-90		-				↔	↔		6	
106 1.5 D	'99-'04	4,6	●	●								●	2	Getr.Öl EP Synth 75W-90		-				↔	↔		6	
107 1.4 HDi	'05-'08	3,8	●	●								●	1,7	Spezialprodukt		-				↔	↔		4,4	
107 1.4 HDi	'08-	3,8											1,7	Spezialprodukt		-				↔	↔		4,4	
1007 1.4 HDi, 1.6 HDi	'05-'09	3,8	●	●								●	2	Getr.Öl EP Synth 75W-90		-				↔	↔		5,6	
205 1.8 D, 1.8 TD, 1.9 D	'83-'99	4,2-5											2	Getr.Öl EP Synth 75W-90		-				↔	↔		8,3	
206, 206+ 1.4 HDi	'01-'09	3,8	●	●								●	2	Getr.Öl EP Synth 75W-90		-				↔	↔		7	

206, CC 1.6 HDi DPF	'04-'08	3,8	●	●				2	Getr.Öl EP Synth 75W-90	-								-
206 1.9 D, 2.0 HDi	'98-'05	4,5-4,8	●	●				2	Getr.Öl EP Synth 75W-90	-								6,2-8,2
207, Compact 1.4, 1.6 HDi	'06-'08	3,5-3,8	●	●				1,9-2	Getr.Öl EP Synth 75W-90	-								7,1
207, Compact 1.4, 1.6 HDi	'09-	3,5-3,8						1,9-2	Getr.Öl EP Synth 75W-90	-								7,1
207 1.6 HDi DPF	'06-'08	3,5	●	●				1,9	Getr.Öl EP Synth 75W-90	-								7,1
207 1.6 HDi DPF	'09-	3,5						1,9	Getr.Öl EP Synth 75W-90	-								7,1
208 1.4 HDi, e-HDi, 1.6 e-HDi (84 kW)	'12-	3,75						1,85-2,2	Getr.Öl EP Synth 75W-90	Spezialprodukt								-
208 1.6 e-HDi (68 kW)	'12-	3,75						1,9	Spezialprodukt	Spezialprodukt		d						-
306 1.8, 1.9 D, 1.9 TD	'93-'98	4-4,5						2	Getr.Öl EP Synth 75W-90	-								7-9
306 1.9 D, 2.0 HDi	'98-'01	4-4,8	●	●				2	Getr.Öl EP Synth 75W-90	-								7-9
307 1.4 HDi, 1.6 HDi, 2.0 HDi	'01-'09	3,5-3,8	●	●				2	Getr.Öl EP Synth 75W-90	-								6-6,5
307 1.6 HDi DPF, 2.0 HDi DPF,	'04-'09	3,5-5,3	●	●				2	Getr.Öl EP Synth 75W-90	-								6,5
308 1.6 HDi DPF (66 kW), 1.6 HDi DPF (80 kW)	'07-	3,8						1,9-2	Getr.Öl EP Synth 75W-90	-								6
308 2.0 HDi DPF	'07-	5,3						2,2	Getr.Öl EP Synth 75W-90	-			Getriebeöl ATF J					7,8-8,2
RCZ 2.0 HDi DPF	'10-	4,8						1,9-2,9	Getr.Öl EP Synth 75W-90	-								8
406 1.9 TD (55kW), 2.1 TD	'96-'99	4,0-5,25						1,8-2	Getr.Öl EP Synth 75W-90	-								9
406 1.9 TD (68kW), 2.0 HDi	'98-'99	4,8						1,9	Getr.Öl EP Synth 75W-90	Spezialprodukt								9,2
406 2.0 HDi, 2.2 HDi	'99-'04	4,5-4,75	●	●				1,9	Getr.Öl EP Synth 75W-90	Spezialprodukt								8,5-9,2
407 1.6 HDi DPF, 2.2 HDi DPF	'04-'09	3,5	●	●				1,9	Getr.Öl EP Synth 75W-90	-								7,2
407 1.6 HDi DPF, 2.2 HDi DPF	'09-'10	3,5						1,9	Getr.Öl EP Synth 75W-90	-								7,2
407 2.0 HDi DPF	'04-'07	5,3	●	●				2,6	Getr.Öl EP Synth 75W-90	Spezialprodukt								9-10
407 2.0 HDi DPF	'07-'07	5,3	●	●				2,6	Getr.Öl EP Synth 75W-90	-			Getriebeöl ATF J					9-10
407 2.0 HDi DPF (103 kW, 120 kW)	'08-'11	5,3						2,6	Getr.Öl EP Synth 75W-90	Spezialprodukt			b					9-10
407 2.0 HDi DPF (103 kW, 120 kW)	'08-'11	5,3						2,6	Getr.Öl EP Synth 75W-90	-			Getriebeöl ATF J	c				9-10
407 2.2 HDi DPF	'06-'08	5,3	●	●				2,6	Getr.Öl EP Synth 75W-90	-								9,7
407 2.2 HDi DPF	'08-'11	5,3	●	●				2,6	Getr.Öl EP Synth 75W-90	-								9,7
407 2.7 HDi DPF	'06-'08	5,8	●	●				-	-	-			Getriebeöl ATF J					11
407 2.7 HDi DPF	'09-'11	5,8						-	-	-			Getriebeöl ATF J					-
508 1.6 HDi 16V	'11-	-						1,8-2,1	Getr.Öl EP Synth 75W-90	e								-
508 2.0 HDi 16V	'11-	-						1,9-2,6	Spezialprodukt	Spezialprodukt								-
508 2.0 HDi 16V + DPF	'11-	-						-	-	Spezialprodukt								-
508 GT 2.2 HDi	'11-	-						-	-	Spezialprodukt								-
605 2.1 D, TD, 2.4 TD	'90-'98	6						1,9	Getr.Öl EP Synth 75W-90	Getr.Öl ATF E-S			Getriebeöl ATF 55					10
605 2.1, 2.4 TD	'99-'99	6/8						1,9/2,2	Getr.Öl EP Synth 75W-90	Getr.Öl ATF E-S			Getriebeöl ATF 55					10/13
607 2.0, 2.2 HDi	'00-'05	4,8	●	●				1,9	Getr.Öl EP Synth 75W-90	Spezialprodukt								9,3
607 2.0, 2.2, 2.7 HDi DPF	'05-'10	5,3-5,8	●	●				1,9/2,6	Getr.Öl EP Synth 75W-90	-			Getriebeöl ATF J					9,3-11,1
806 1.9, 2.1 TD	'94-'98	4,2-4,8						1,9	Getr.Öl EP Synth 75W-90	-								9
806 1.9 TD, 2.0 HDi	'99-'01	4,5	●	●				1,9	Getr.Öl EP Synth 75W-90	-								8,5
807 2.0 HDi DPF	'02-'07	4,8	●	●				2,1	Getr.Öl EP Synth 75W-90	Spezialprodukt								10
807 2.0 HDi DPF	'08-	4,5						2,2-2,8	Getr.Öl EP Synth 75W-90	-								9,5-10
807 2.2 HDi	'02-'04	4,8	●	●				2,1	Getr.Öl EP Synth 75W-90	-								11,3
807 2.2 HDi DPF	'02-'07	4,8	●	●				2,1	Getr.Öl EP Synth 75W-90	-								11,3
807 2.2 HDi DPF	'08-	4,8						2,2-2,9	Getr.Öl EP Synth 75W-90	-			Getriebeöl ATF J					11,3
3008 1.6 HDi DPF	'09-	3,8						2,2	Getr.Öl EP Synth 75W-90	-								6,4
3008 2.0 HDi DPF (Euro4)	'09-	5,3						1,9-2,6	Getr.Öl EP Synth 75W-90	-			Getriebeöl ATF J					8,4
3008 2.0 HDi DPF (Euro5)	'09-	5,3						1,9-2,6	Getr.Öl EP Synth 75W-90	Spezialprodukt								8,4
4008 1.6 HDi DPF, 1.8 HDi DPF, 4x4	'12-	3,75						-	Getr.Öl EP Synth 75W-90	g					0,5	Getriebeöl BS 75W-90		-
4007 2.2 HDi	'07-	5,3						2	Getr.Öl EP Synth 75W-90	-			a		0,5	Getr.Öl BS LSX 75W-140		8
5008 1.6 HDi DPF	'09-	3,8						2,2	Getr.Öl EP Synth 75W-90	-								6,4
5008 2.0 HDi DPF (Euro4)	'09-	5,3						1,9-2,6	Getr.Öl EP Synth 75W-90	-			Getriebeöl ATF J					8,4
5008 2.0 HDi DPF (Euro5)	'09-	5,3						1,9-2,6	Getr.Öl EP Synth 75W-90	Spezialprodukt								8,4
Bipper Tepee 1.3 Hdi	'10-	3,2						2	Getr.Öl EP Synth 75W-90	Spezialprodukt			d					7,6
Bipper Tepee 1.4 Hdi	'09-	3,8						2	Getr.Öl EP Synth 75W-90	-								7,4
Partner Tepee 1.6 HDi DPF (66 kW), 1.6 Hdi DPF (80 kW)	'08-	3,75-4,25						1,8-1,9	Getr.Öl EP Synth 75W-90	-								6,25
Expert Tepee 1.6 Hdi, 2.0 Hdi (88 kW)	'07-	5						1,8-2,2	Getr.Öl EP Synth 75W-90	-								-
Expert Tepee 2.0 Hdi (100 kW)	'07-	5						1,9-2,2	Getr.Öl EP Synth 75W-90	-								-

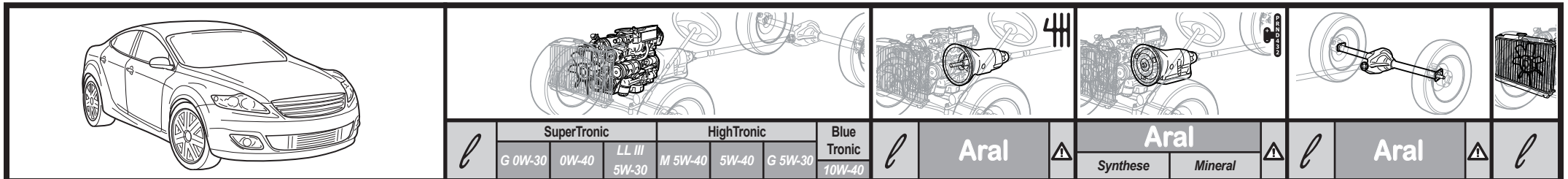

## PEUGEOT

a Verteilergetriebe: 0,54 l Getr.Öl BS LSX 75W-140; Getr.Öl HYP LS 85W-90  
 c Automatgetriebe AM6: Getriebeöl ATF J  
 e Getriebe MCM: Getriebeöl BS 75W-90; Getriebeöl HYP Synth 75W-90  
 g Verteilergetriebe: Getriebeöl Hyp 80W

b Automatgetriebe 4HP20: Spezialprodukt, bitte auf Originalersatzteil des Herstellers zurückgreifen!  
 d Hydraulisch betätigtes Automatgetriebe MCP: Spezialprodukt, bitte auf Originalersatzteil des Herstellers zurückgreifen!  
 f Verteilergetriebe: Getriebeöl BS 75W-90; Getriebeöl HYP Synth 75W-90

## PORSCHE

Boxster, S	'96-'05	8,8		●					2,3-2,8	Getriebeöl BS 75W-90		Spezialprodukt			↔	↔	a	17
Boxster, Cayman, S	'05-'09	7,8		●					2,3-2,8	Getriebeöl BS 75W-90		Spezialprodukt			↔	↔	g	22-24,3
Boxster, Cayman, S, Spyder, R	'09-	7,5		●					3-3,2	Getriebeöl BS 75W-90		Spezialprodukt		k	↔	↔		23-25
911 Carrera 2, 4, RS (964, 993)	'93-'98	11,5					●		3,6	Getriebeöl BS 75W-90		Getr.Öl ATF E-S	Getriebeöl ATF 55		↔	↔	a	-
911 Turbo (964, 993)	'90-'98	10-13					●		3,7	Getriebeöl BS 75W-90		-			↔	↔		-
911 Carrera (996)	'97-'04	8,3		●					2,7	Getriebeöl BS 75W-90		Spezialprodukt			↔	↔	a	22,5
911 Turbo, GT3 (996)	'99-'06	8,3/11		●					3,8	Getriebeöl BS 75W-90		Spezialprodukt			↔	↔	ab	22,5-25
911 Carrera, 4, S, 4S (997)	'04-'08	8,3							2,6	Getriebeöl BS 75W-90		Spezialprodukt			↔	↔	gh	32
911 Turbo, GT3, GT3 RS, GT2 (997)	'06-'10	8/9		●					3,3-3,8	Spezialprodukt		Spezialprodukt			↔	↔	gh	25-30
911 Carrera, S, 4S (997)	'08-'12	7,5		●					2,6-2,9	Spezialprodukt		Spezialprodukt		k	↔	↔	c	29-32
911 GT3, GT3 RS 4.0 (997)	'10-'12	9		●					3,3	Spezialprodukt		-			↔	↔		30
911 GT2 RS (997)	'11-'12	8		●					3,8	Spezialprodukt		-			↔	↔		28
911 Turbo, Turbo S (997)	'10-	7,5		●					2,9	Spezialprodukt		Spezialprodukt		k	↔	↔	c	29-32
911 Carrera, Carrera S (991)	'11-	7,5		●					3,2	Spezialprodukt		Spezialprodukt		k	↔	↔		-
Carrera GT	'03-'06	10,5							2,3/4	Spezialprodukt		-			↔	↔	gh	28
Cayenne	'04-'07	6,3		●	●				1,8	Spezialprodukt	d		Getriebeöl ATF J	d	1-1,4	Getriebeöl BS 75W-90	ef	13-18
Cayenne S, Turbo, Turbo S	'03-'07	8,5		●	●				1,8	Spezialprodukt	d		Getriebeöl ATF J	d	1-1,4	Getriebeöl BS 75W-90	ef	18-21
Cayenne	'07-'10	6,9		●	●				1,8	Getriebeöl BS 75W-90	j	Spezialprodukt		j	1-1,6	Getriebeöl BS 75W-90	f	13-18
Cayenne S, GTS, Turbo	'07-'10	8,5		●	●				1,8	Getriebeöl BS 75W-90	j	Spezialprodukt		j	1-1,6	Getriebeöl BS 75W-90	f	18-21
Cayenne	'10-	6,9			●				1,8	Spezialprodukt		Spezialprodukt		lm	0,8-1,3	Getriebeöl BS 75W-90	f	-
Cayenne S Hybrid	'10-	6,75			●				-	-		Spezialprodukt		lm	0,8-1,3	Getriebeöl BS 75W-90	f	-
Cayenne S	'10-	9,5		●		●			-	-		Spezialprodukt		lm	0,8-1,3	Getriebeöl BS 75W-90	f	-
Cayenne Turbo	'10-	9,5		●		●			-	-		Spezialprodukt		lm	0,8-1,3	Getriebeöl BS 75W-90	f	-
Panamera	'11-	8,5		●		●			1,8	Spezialprodukt		Spezialprodukt			1,1-1,2	Getriebeöl BS 75W-90	e	-
Panamera 4	'11-	8,5		●		●			-	-		Spezialprodukt			1,1-1,2	Getriebeöl BS 75W-90	e	-
Panamera S	'09-	9		●		●			1,8	Spezialprodukt		Spezialprodukt			1,1-1,2	Getriebeöl BS 75W-90	e	-
Panamera S Hybrid	'11-	6,75			●				-	-		Spezialprodukt			1,1-1,2	Getriebeöl BS 75W-90	e	-
Panamera 4S, GTS	'09-	9		●		●			-	-		Spezialprodukt			1,1-1,2	Getriebeöl BS 75W-90	e	-
Panamera Turbo, Turbo S	'09-	9		●		●			-	-		Spezialprodukt			1,1-1,2	Getriebeöl BS 75W-90	e	-
<b>Diesel</b>																		
Cayenne Diesel	'08-'10	8,3			●				1,8	Getriebeöl BS 75W-90	j	Spezialprodukt		j	1,4	Getriebeöl BS 75W-90	f	18-21
Cayenne Diesel	'10-	7,3			●				-	-		Spezialprodukt		lm	0,8-1,3	Getriebeöl BS 75W-90	f	-
Panamera Diesel	'11-	7,3			●				-	-		Spezialprodukt			1,1	Getriebeöl BS 75W-90	e	-

a Differential, Modelle mit Automatgetriebe (Tiptronic): 0,7-0,9 Getriebeöl BS 75W-90; Getriebeöl SNA-C 75W-90  
 c Differential, vorn: Spezialprodukt, bitte auf Originalersatzteil des Herstellers zurückgreifen!  
 e Sperrdifferential: Getr.Öl BS LSX 75W-140  
 g Differential, Modelle mit Automatgetriebe: 0,8-1,2 l Getriebeöl BS 75W-90  
 j Verteilergetriebe: 0,8 l Getriebeöl BS 75W-90  
 l Verteilergetriebe Hang-On: 0,8 l Spezialprodukt, bitte auf Originalersatzteil des Herstellers zurückgreifen!

b Differential, vorn: 0,6-1,2 l Getriebeöl BS 75W-90; Getriebeöl SNA-C 75W-90  
 d Verteilergetriebe: 0,8 l Spezialprodukt, bitte auf Originalersatzteil des Herstellers zurückgreifen!  
 f Differentiale, vorn und hinten  
 h Differential, vorn: 0,9 l Getriebeöl BS 75W-90  
 k Getriebe, Porsche PDK, Kupplungsteil: Spezialprodukt, bitte auf Originalersatzteil des Herstellers zurückgreifen!  
 m Verteilergetriebe Torsen: 0,8 l Spezialprodukt, bitte auf Originalersatzteil des Herstellers zurückgreifen!



# RANGE ROVER = LAND ROVER

## RENAULT

Twizy	'12-	-	-													Spezialprodukt											-	
Twingo 1.1, 1.2	'96-'00	4							●					●	3,4	Getr.Öl EP Synth 75W-90	-										5	
Twingo 1.2 (16V)	'01-'07	4	●						●					2,8-3,1	Getr.Öl EP Synth 75W-90	m											5	
Twingo II 1.2 (16V)	'07-	4							●					2,8-3,4	Getr.Öl EP Synth 75W-90	m											5,5	
Twingo II GT TCE	'07-	4							●					2,8	Getr.Öl EP Synth 75W-90	n											5,7	
Twingo II RS	'08-	5							●					2,5	Getr.Öl EP Synth 75W-90	m											5,7	
Wind 1.2 Tce 100	'10-	4							●					2,8	Getr.Öl EP Synth 75W-90	-											5,7	
Wind 1.6 16V 133	'10-	5	●						●					2,3	Getr.Öl EP Synth 75W-90	-											5,7	
Clio 1.1, 1.2, 1.4, 1.7	'90-'98	3,3-4							●					2,8-3,4	Getr.Öl EP Synth 75W-90		Getr.Öl ATF E-S	Getriebeöl ATF 55								d	5-6,5	
Clio 1.8 (16V), RSi	'90-'98	4,2-5,5							●					3,1-3,4	Getr.Öl EP Synth 75W-90		Getr.Öl ATF E-S	Getriebeöl ATF 55								d	6,5-7	
Clio II 1.2, 1.4, 1.6	'98-'00	2,9-3,7	●						●					3,4	Getr.Öl EP Synth 75W-90		Getr.Öl ATF E-S	Getriebeöl ATF 55									5-5,5	
Clio II 1.2 16V, 1.4 16V, 1.6 16V	'98-'09	4,2-4,8	●						●					3,4	Getr.Öl EP Synth 75W-90		Getr.Öl ATF E-S	Getriebeöl ATF 55									5,5-6,2	
Clio II Sport 2.0 16V	'00-'05	6		●					●					3,1	Getr.Öl EP Synth 75W-90	-											7	
Clio II Sport V6	'01-'05	5,5		●					●					2,4	Getr.Öl SNS-B 75W-80	-											15	
Clio III 1.2 16V, 1.4 16V, 1.6 16V	'05-'09	4-5	●						●					2,8	Getr.Öl EP Synth 75W-90	e	Getr.Öl ATF E-S	Getriebeöl ATF 55									5-6,5	
Clio III 1.2 16V, 1.4 16V, 1.6 16V	'09-	4-5							●					2,8	Getr.Öl EP Synth 75W-90	-											5-5,5	
Clio III TCE	'05-'09	4	●						●					2,8	Getr.Öl EP Synth 75W-90	-											5,5	
Clio III TCE 100, 1.6 16V 128	'09-	3,8-5							●					2,8-3,4	Getr.Öl EP Synth 75W-90		Getr.Öl ATF E-S	Getriebeöl ATF 55									5-6,5	
Clio III 2.0 16V	'06-'09	3,5	●						●					2	Getr.Öl EP Synth 75W-90		Getr.Öl ATF E-S	Getriebeöl ATF 55									5,9	
Clio III 2.0 16V	'09-	4,4							●					2	Getr.Öl EP Synth 75W-90		Getr.Öl ATF E-S	Getriebeöl ATF 55									5,5-5,9	
Clio III Sport 2.0 16V	'07-'09	5,4							●					2	Getr.Öl EP Synth 75W-90	-											5	
Clio III 2.0 16V RS	'09-	5,4							●					2	Getr.Öl EP Synth 75W-90	-											5	
Symbol/Thalia 1.2 16V, 1.4 16V, 1.6 16V	'10-	4-4,8							●					3,4	Getr.Öl EP Synth 75W-90		Getr.Öl ATF E-S	Getriebeöl ATF 55									5-5,7	
Modus 1.2 16V, 1.4 16V, 1.6 16V	'04-'08	4-5	●	●					●					2,8	Getr.Öl EP Synth 75W-90	n	Getr.Öl ATF E-S	Getriebeöl ATF 55									5-5,8	
(Grand) Modus 1.2 16V, 1.4 16V, 1.6 16V	'08-	4-5							●					2,8	Getr.Öl EP Synth 75W-90	n	Getr.Öl ATF E-S	Getriebeöl ATF 55									5-5,8	
(Grand) Modus TCE	'07-	4							●					2,8	Getr.Öl EP Synth 75W-90	-											5,5	
Kangoo 1.2 (16V), 1.6 16V, 4x4	'97-'08	3,7-4,8	●	●					●					3,3-3,4	Getr.Öl EP Synth 75W-90		Getr.Öl ATF E-S	Getriebeöl ATF 55							a		4,3-7,9	
Kangoo 1.4	'97-'03	2,9	●	●					●					3,4	Getr.Öl EP Synth 75W-90		Getr.Öl ATF E-S	Getriebeöl ATF 55									5,5	
Kangoo II Family 1.6 8V, 16V	'08-	3,4-4,8							●					2,5-2,8	Getr.Öl EP Synth 75W-90		Getr.Öl ATF E-S	Getriebeöl ATF 55									5	
Kangoo Z.E.	'11-	-	-											-													-	
19, 16V	'88-'96	3-5		●					●					2,8-3,4	Getr.Öl EP Synth 75W-90		Getr.Öl ATF E-S	Getriebeöl ATF 55							d		6/6,5	
Sandero 1.0 16V, 1.2 16V, 1.4, 1.6	'09-	3,3-4	●						●					2,8	Getr.Öl EP Synth 75W-90	-											4,5-5,5	
Sandero 1.6 16V	'08-	4,8							●					2,8	Getr.Öl EP Synth 75W-90	-											4,5-5,5	
Logan 1.0 16V, 1.2 16V, 1.4, 1.6, 1.6 16V	'04-	3,3-4,8	●						●					2,5-2,8	Getr.Öl EP Synth 75W-90	-											4,5-5,5	
Mégane, Scénic 1.4 (16V), 1.6 (16V), 2.0 (16V), ide	'95-'01	4-6							●					3,1-3,4	Getr.Öl EP Synth 75W-90	k	Getr.Öl ATF E-S	Getriebeöl ATF 55	g								6-8	
Mégane, Scénic, RX-4 1.4, 1.6, 1.8, 2.0 16V, ide	'01-'02	4,2-5,4	●						●					3,1-3,4	Getr.Öl EP Synth 75W-90	k	Getr.Öl ATF E-S	Getriebeöl ATF 55							a		8	
Mégane II, Scénic II 1.4 16V, 1.6 16V, 2.0 16V	'02-'09	4,8-5,4	●						●					2,1-2,8	Getr.Öl EP Synth 75W-90	k	Getr.Öl ATF E-S	Getriebeöl ATF 55									6-6,5	
Mégane II, Scénic II 2.0 16V T, RS	'02-'09	5,4							●					2,1	Getr.Öl EP Synth 75W-90	-											6,5-7	
Mégane III, (Grand) Scénic III 1.4 TCE	'09-	4,5							●					1,9	Getr.Öl EP Synth 75W-90	-											6,5	
Mégane III, (Grand) Scénic III 1.6 16V, 1.6 16V E85	'08-	4,8							●					1,9-2,8	Getr.Öl EP Synth 75W-90	k											5,3	
Mégane III, (Grand) Scénic III 2.0 16V	'08-	3,5							●					-														6,8
Mégane III 2.0 TCE 180, 2.0 16V Turbo 250 RS	'08-	5,4							●					2,4	Getr.Öl EP Synth 75W-90	-											6,5	
Fluence 1.6 16V, 2.0 16V	'10-	3,5-4,8							●					2-2,7	Getr.Öl EP Synth 75W-90		Getr.Öl ATF E-S	Getriebeöl ATF 55									5,3-6,8	
Fluence Z.E.	'11-	-	-											-													-	
Laguna 1.8, 2.0 (16V)	'93-'98	5-5,9							●					3,4	Getr.Öl EP Synth 75W-90		Getr.Öl ATF E-S	Getriebeöl ATF 55							c		7-8	
Laguna 1.6 16V, 1.8, 2.0 (16V)	'98-'01	4,8-5,9		●					●					3,1-3,4	Getr.Öl EP Synth 75W-90		Getr.Öl ATF E-S	Getriebeöl ATF 55									6-7	
Laguna 2.9 V6 24V	'97-'01	5,4		●					●					2,1-2,8	Getr.Öl EP Synth 75W-90												8	
Laguna 3.0 V6	'93-'97	7		●					●					2,1-2,6	Getr.Öl SNS-B 75W-80	b	Getr.Öl ATF E-S	Getriebeöl ATF 55							d		10	
Laguna II 1.6 16V, 1.8 16V, 2.0 16V, ide	'01-'07	4,8-5,4	●						●					2,5-2,8	Getr.Öl EP Synth 75W-90		Getr.Öl ATF E-S	Getriebeöl ATF 55									6,5-6,8	
Laguna II 2.0 16V Turbo	'01-'07	5,4							●					2,2	Getr.Öl EP Synth 75W-90												6,5	
Laguna II 3.0 V6 24V	'01-'07	4,8-5,1	●						●					-							g						7,2	
Laguna III 1.6 16V	'07-	4,8							●					1,9	Getr.Öl EP Synth 75W-90	-											5,3	
Laguna III 2.0 16V	'07-	3,5-4,4							●					1,9	Getr.Öl EP Synth 75W-90	-											7,2	
Laguna III 2.0 16V Turbo	'07-	5,4							●					-													7,5	
Laguna III 2.0 16V Turbo GT	'08-	5,4							●					2	Getr.Öl EP Synth 75W-90	-											7,5	
Laguna III 2.0 16V Ethanol	'07-	3,5							●					1,9	Getr.Öl EP Synth 75W-90	-											7,2	

RENAULT	Year	Power (kW)	SuperTronic			HighTronic			Blue Tronic	Oil	Aral	Filter	Aral		Oil	Aral	Filter	Oil
			G 0W-30	0W-40	LL III 5W-30	M 5W-40	5W-40	G 5W-30	10W-40				Synthese	Mineral				
			⊕	⊕	⊕	⊕	⊕	⊕	⊕				⊕	⊕				
Laguna Coupé 2.0 16V Turbo (GT)	'08-	5,4				●			2,4	Getr.Öl EP Synth 75W-90		Spezialprodukt			↔	↔		7,5-7,7
Laguna Coupé 3.5 V6	'08-	5,5				●			-			Spezialprodukt			↔	↔		8,5
Safrane 2.0 (12V), 2.2 (12V), 3.0 V6, Quadra	'92-'96	6,1-7		●					2,2-3,4	Getr.Öl SNS-B 75W-80		Getr.Öl ATF E-S	Getriebeöl ATF 55		↔	↔		7-10
Safrane 2.0, 2.5	'96-'00	6,5		●					2,2	Getr.Öl SNS-B 75W-80		Getr.Öl ATF E-S	Getriebeöl ATF 55		↔	↔		8-8,5
Safrane 3.0 V6	'96-'99	7		●					3	Getr.Öl SNS-B 75W-80		Getr.Öl ATF E-S	Getriebeöl ATF 55		↔	↔	d	10
Latitude 2.0 16V E85	'11-	4,8							2	Getr.Öl EP Synth 75W-90					↔	↔		-
Latitude 2.5 V6, 3.5 V6	'11-	4,6							-			Spezialprodukt			↔	↔		-
Sport Spider 2.0 16V	'95-'00	6		●					3	Getr.Öl EP Synth 75W-90					↔	↔		8
Espace II 2.0, 2.2, 2.85 V6, Quadra	'91-'96	6-7		●					2,2-3	Getr.Öl EP Synth 75W-90		Getr.Öl ATF E-S	Getriebeöl ATF 55		↔	↔		8,4-10
(Grand) Espace III 2.0 (16V)	'96-'01	5,3-5,5		●					3,1	Getr.Öl EP Synth 75W-90		Getr.Öl ATF E-S	Getriebeöl ATF 55		↔	↔	d	7-8,8
(Grand) Espace III 2.9 V6 24V	'98-'02	4,9		●					-			Spezialprodukt			↔	↔		8
(Grand) Espace III 3.0 V6	'96-'98	7		●					-			Getr.Öl ATF E-S	Getriebeöl ATF 55		↔	↔	d	10
(Grand) Espace IV 2.0 16V, 3.5 V6 24V	'02-'08	5-5,4	●	●					2,4	Getr.Öl EP Synth 75W-90		Spezialprodukt			↔	↔		7,2-8,8
(Grand) Espace IV 2.0 16V, 3.5 V6 24V	'08-	5-5,4							2,4	Getr.Öl EP Synth 75W-90		Spezialprodukt			↔	↔		7,2-8,8
(Grand) Espace IV 2.0 16V Turbo	'02-'08	5,4		●					2,4	Getr.Öl EP Synth 75W-90		Spezialprodukt			↔	↔		9,3
(Grand) Espace IV 2.0 16V Turbo	'08-	5,4							2,4	Getr.Öl EP Synth 75W-90		Spezialprodukt			↔	↔		9,3
Vel Satis 2.0 16V Turbo	'02-'09	5,4		●					2,4	Getr.Öl EP Synth 75W-90		Spezialprodukt			↔	↔		6,8
Vel Satis 3.5 V6 24V	'02-'09	5-5,7	●	●					-			Spezialprodukt			↔	↔		7,2
Avantime 2.0 16V Turbo	'01-'03	5		●					2,4	Getr.Öl EP Synth 75W-90					↔	↔		-
Avantime 3.0 V6 24V	'01-'03	6,5	●	●					2,2	Getr.Öl EP Synth 75W-90					↔	↔		10
Duster 1.6, 16V, Hi-Flex, Hi-Torque	'09-	4,8							2,5	Getr.Öl EP Synth 75W-90					↔	↔		-
Koleos 2.5 16V 4x2, 4x4	'08-	5,1							-	Getr.Öl EP Synth 75W-90		Spezialprodukt			-	Getriebeöl BS 75W-90		7,2
Trafic II 2.0 16V	'08-	5,4							2,7	Getr.Öl EP Synth 75W-90					↔	↔		6,5
<b>Diesel</b>																		
Twingo II 1.5 dCi	'07-	-	HighTronic R 5W-30							2,8	Getr.Öl EP Synth 75W-90				↔	↔		5,7
Clio 1.9 D	'90-'98	5,5		●					3,4	Getr.Öl EP Synth 75W-90					↔	↔		6,6
Clio II 1.5 dCi, 1.9 D, dTi	'98-'05	5,2-5,5	●	●					3,1-3,4	Getr.Öl EP Synth 75W-90					↔	↔		7,4-7,5
Clio III 1.5 dCi	'05-'09	4,5	●	●					2,5	Getr.Öl EP Synth 75W-90	e				↔	↔		6,5
Clio III 1.5 dCi	'09-	4,5							2,5	Getr.Öl EP Synth 75W-90					↔	↔		6,5
Clio III 1.5 dCi DPF	'05-'09	4,5		●	●				2,5	Getr.Öl EP Synth 75W-90	e				↔	↔		6,5
Clio III 1.5 dCi DPF	'09-	4,5	HighTronic R 5W-30							2,5	Getr.Öl EP Synth 75W-90				↔	↔		6,5
Symbol/Thalia 1.5 dCi	'10-	4,6							2,5-3,4	Getr.Öl EP Synth 75W-90					↔	↔		5,7
Symbol/Thalia 1.5 dCi DPF	'10-	4,6	HighTronic R 5W-30							2,5-3,4	Getr.Öl EP Synth 75W-90				↔	↔		5,7
Modus 1.5 dCi	'04-'05	4,5	●	●					2,5-2,8	Getr.Öl EP Synth 75W-90					↔	↔		5,5
(Grand) Modus 1.5 dCi DPF	'05-'08	4,5-5		●	●				2,5-2,8	Getr.Öl EP Synth 75W-90	ek				↔	↔		5,7
(Grand) Modus 1.5 dCi DPF	'08-	4,5	HighTronic R 5W-30							2,8	Getr.Öl EP Synth 75W-90				↔	↔		5,7
Kangoo 1.5 dCi, 1.9 D, dTi, dCi, 4x4	'97-'08	4,6-5,5	●	●					3,1-3,4	Getr.Öl EP Synth 75W-90					↔	↔	a	6,5-7,5
Kangoo II Family 1.5 dCi	'08-	4,5							2,1-2,8	Getr.Öl EP Synth 75W-90					↔	↔		7,2
Kangoo II Family 1.5 dCi DPF	'08-	4,5	HighTronic R 5W-30							2,1-2,8	Getr.Öl EP Synth 75W-90				↔	↔		7,2
19 1.9 D, TD	'88-'96	5-5,5		●					3,1-3,4	Getr.Öl EP Synth 75W-90					↔	↔		6,8
Sandero	'09-	4,5							2,8	Getr.Öl EP Synth 75W-90					↔	↔		5,7
Logan 1.5 dCi	'06-	4,5							2,8	Getr.Öl EP Synth 75W-90					↔	↔		4,5-5,45
Mégane, Scénic 1.9 D, TD, dTi, dCi	'95-'00	5,5		●					3,1-3,4	Getr.Öl EP Synth 75W-90		Getr.Öl ATF E-S	Getriebeöl ATF 55		↔	↔		7,5
Mégane, Scénic, RX-4 1.9 D, dTi, dCi	'01-'03	5,5	●	●					3,1-3,4	Getr.Öl EP Synth 75W-90		Getr.Öl ATF E-S	Getriebeöl ATF 55		↔	↔	a	7,5
Mégane II, (Grand) Scénic II 1.5, 1.9 dCi	'03-'05	4,5-4,6	●	●					2,1-2,5	Getr.Öl EP Synth 75W-90		Getr.Öl ATF E-S	Getriebeöl ATF 55		↔	↔		5,3-7,2
Mégane II, (Grand) Scénic II 1.5, 1.9 dCi DPF	'05-'08	4,5-4,9		●	●				2-2,5	Getr.Öl EP Synth 75W-90		Getr.Öl ATF E-S	Getriebeöl ATF 55		↔	↔		5,3-7,9
Mégane II, (Grand) Scénic II 2.0 dCi DPF	'06-'08	6,6-7,4		●	●				2,4	Getr.Öl EP Synth 75W-90		Spezialprodukt			↔	↔		7,5

Mégane III, (Grand) Scénic III 1.5, 1.9 dCi	'08-	4,5/5,1					●			2,4/2,1	Getr.Öl EP Synth 75W-90	k	-			↔	↔		6,5/6,3
Mégane III, (Grand) Scénic III 1.5, 1.9 dCi DPF	'08-	4,5/5,1	HighTronic R 5W-30							2,4/2,1	Getr.Öl EP Synth 75W-90	k	-			↔	↔		6,5/6,3
Mégane III, (Grand) Scénic III 1.6 dCi DPF	'11-	5,5	HighTronic R 5W-30							2,1	Getr.Öl EP Synth 75W-90	-	-			↔	↔		-
Mégane III, (Grand) Scénic III 2.0 dCi DPF	'08-	7-7,4	HighTronic R 5W-30							2,4	Getr.Öl EP Synth 75W-90	-	-	Spezialprodukt		↔	↔		6,6-7,5
Fluence 1.5 dCi	'10-	4,5					●			1,9-2,4	Getr.Öl EP Synth 75W-90	-	-			↔	↔		6,5
Laguna 1.9 dTi	'98-'01	5,5		●			●			3,1	Getr.Öl EP Synth 75W-90	-	-	Getr.Öl ATF E-S	Getriebeöl ATF 55	↔	↔		7,5
Laguna 2.2 D	'94-'98	6,5		●			●			3,1	Getr.Öl EP Synth 75W-90	-	-			↔	↔		9
Laguna 2.2 dT	'96-'01	7,2-7,7		●			●			2,8	Getr.Öl SNS-B 75W-80	b	-			↔	↔		9
Laguna II 1.9 dCi	'01-'06	4,6	●	●			●			2,5	Getr.Öl EP Synth 75W-90	h	-			↔	↔		7
Laguna II 1.9 dCi DPF	'05-'07	4,8		●	●		●			2,2	Getr.Öl EP Synth 75W-90	-	-	Getr.Öl ATF E-S	Getriebeöl ATF 55	↔	↔		7
Laguna II 2.0 dCi DPF	'05-'07	5,9		●	●		●			2,4	Getr.Öl EP Synth 75W-90	-	-			↔	↔		7,5
Laguna II 2.2 dCi, DPF	'01-'05	5,4-6,3					●			2,2	Getr.Öl EP Synth 75W-90	-	-	Spezialprodukt		↔	↔		6,8
Laguna III 1.5 dCi	'08-	4,5					●			1,9	Getr.Öl EP Synth 75W-90	-	-			↔	↔		7,2
Laguna III 1.5 dCi DPF	'08-	4,5	HighTronic R 5W-30							1,9	Getr.Öl EP Synth 75W-90	-	-			↔	↔		7,2
Laguna III 2.0 dCi, 2.0 dCi GT	'07-	6,6-7,4					●			2,4	Getr.Öl EP Synth 75W-90	-	-	Spezialprodukt		↔	↔		7,8
Laguna III 2.0 dCi DPF, 2.0 dCi GT DPF, 3.0 dCi	'07-	6,6-7,4	HighTronic R 5W-30							2,4	Getr.Öl EP Synth 75W-90	-	-	Spezialprodukt		↔	↔		7,8-9,2
Laguna Coupé 2.0 dCi (GT)	'08-	6,6-7,4					●			2,4	Getr.Öl EP Synth 75W-90	-	-	Spezialprodukt		↔	↔		7,8
Laguna Coupé 2.0 dCi (GT) DPF, 3.0 dCi	'08-	6,6-7,4	HighTronic R 5W-30							2,4	Getr.Öl EP Synth 75W-90	-	-			↔	↔		7,8
Safrane 2.1, 2.5 dT	'92-'96	6,5-7,1					●			2,6	Getr.Öl SNS-B 75W-80	-	-	Getr.Öl ATF E-S	Getriebeöl ATF 55	↔	↔	d	7,2-10
Safrane 2.2 dT	'96-'00	7,7		●			●			2,8	Getr.Öl EP Synth 75W-90	-	-			↔	↔		9
Latitude 1.5 dCi	'11-	4,5					●			2	Getr.Öl EP Synth 75W-90	-	-			↔	↔		-
Latitude 1.5 dCi DPF	'11-	4,5	HighTronic R 5W-30							2	Getr.Öl EP Synth 75W-90	-	-			↔	↔		-
Latitude 2.0 dCi	'11-	7,4					●			2,4	Getr.Öl EP Synth 75W-90	-	-	Spezialprodukt		↔	↔		-
Latitude 2.0 dCi DPF, 3.0 dCi	'11-	7,4	HighTronic R 5W-30							2,4	Getr.Öl EP Synth 75W-90	-	-	Spezialprodukt		↔	↔		-
Espace II 2.1 dT	'91-'96	6		●			●			2,2	Getr.Öl EP Synth 75W-90	-	-			↔	↔		8,8
Espace III 1.9 dTi	'99-'02	4,1-4,6		●			●			3,1	Getr.Öl EP Synth 75W-90	-	-			↔	↔		7,5
Espace III 2.1 dT	'96-'00	7,2		●			●			2,6	Getr.Öl EP Synth 75W-90	-	-			↔	↔		9
(Grand) Espace III 2.2 dT	'96-'00	7,2		●			●			2,6	Getr.Öl EP Synth 75W-90	-	-			↔	↔		9
(Grand) Espace III 2.2 dCi	'00-'02	7,6		●			●			2,4	Getr.Öl EP Synth 75W-90	-	-			↔	↔		7,5
(Grand) Espace IV 1.9 dCi	'02-'06	4,6	●				●			2,4	Getr.Öl EP Synth 75W-90	-	-			↔	↔		9,3
(Grand) Espace IV 2.0 dCi DPF	'06-'08	6,8		●	●		●			2,4	Getr.Öl EP Synth 75W-90	-	-	Spezialprodukt		↔	↔		-
(Grand) Espace IV 2.0 dCi DPF	'08-	6,8	HighTronic R 5W-30							2,4	Getr.Öl EP Synth 75W-90	-	-	Spezialprodukt		↔	↔		-
(Grand) Espace IV 2.2 dCi, 3.0 dCi V6, DPF	'02-'08	6,3-7,3		●			●			2,4	Getr.Öl EP Synth 75W-90	-	-	Spezialprodukt		↔	↔		9,1-9,5
(Grand) Espace IV 3.0 dCi V6	'08-	7,3					●			-	-	-	-	Spezialprodukt		↔	↔		9,5
Vel Satis 2.0 dCi DPF	'02-'09	-		●	●		●			2,4	Getr.Öl EP Synth 75W-90	-	-			↔	↔		-
Vel Satis 2.2 dCi, DPF	'02-'06	6/6,3		●			●			2,4	Getr.Öl EP Synth 75W-90	-	-	Spezialprodukt		↔	↔		7
Vel Satis 3.0 dCi V6, DPF	'06-'09	7,3/8		●	●		●			2,4	Getr.Öl EP Synth 75W-90	-	-	Spezialprodukt		↔	↔		7
Avantime 2.2 dCi	'01-'03	6,3	●	●			●			2,4	Getr.Öl EP Synth 75W-90	-	-			↔	↔		-
Duster 1.5 dCi	'09-	4,5					●			2,5	Getr.Öl EP Synth 75W-90	-	-			↔	↔		4,5
Koleos 2.0 dCi 2x4, 4x4	'08-	7,4	HighTronic R 5W-30				●			-	Getr.Öl EP Synth 75W-90	-	-	Spezialprodukt		-	Getriebeöl BS 75W-90		8-8,5
Trafic II 2.0 dCi	'07-'09	6,6					●			2,7	Getr.Öl EP Synth 75W-90	-	-	Spezialprodukt	e	↔	↔		6,3
Trafic II 2.0 dCi	'09-	7,7					●			2,7	Getr.Öl EP Synth 75W-90	-	-	Spezialprodukt	e	↔	↔		-
Trafic II 2.0 dCi DPF	'09-	7,7	HighTronic R 5W-30							2,7	Getr.Öl EP Synth 75W-90	-	-	Spezialprodukt	e	↔	↔		-
Trafic II 2.5 dCi DPF	'07-'09	7,5	HighTronic R 5W-30							2,7	Getr.Öl EP Synth 75W-90	-	-	Spezialprodukt	e	↔	↔		6,4

a Differential, hinten (4x4); Getriebeöl BS 75W-90; Getriebeöl SNA-C 75W-90

c Differential, Modelle mit Automatikgetriebe: 0,8 l Getriebeöl Hyp 80W

e Hydraulik Bedienung Getriebe, Quickshift: Spezialprodukt, bitte auf Originalersatzteil des Herstellers zurückgreifen!

h Getriebe PK6: Getr.Öl EP Synth 75W-90

l Differential, hinten (4x4); 1,1-1,3 l Getriebeöl BS 75W-90

n Hydraulik Bedienung Getriebe, Quickshift: 2,8-3,4 l Getr.Öl EP Synth 75W-90

b Getriebe PK1 Nr. 046/047/048/049: Getr.Öl EP Synth 75W-90

d Differential, Modelle mit Automatikgetriebe: 0,8-1,5 l Getriebeöl BS 75W-90

g Automatgetriebe DP0: Getr.Öl ATF E-S; Getriebeöl ATF 55

k Getriebe TL4: Getriebeöl BS 75W-90

m Hydraulik Bedienung Getriebe, Quickshift: 0,6 l Getr.Öl ATF E-S; Getriebeöl ATF 55

## ROLLS-ROYCE

Silver Spirit, Silver Spur	'80-'98	9,4		●			●			-	-			Getr.Öl ATF E-S	Getriebeöl ATF 55		2,3	Getriebeöl BS 75W-90		16/18
Touring Limousine	'92-'98	9,4		●			●			-	-			Getr.Öl ATF E-S	Getriebeöl ATF 55		2,8	Getriebeöl BS 75W-90		18
Phantom, Phantom Drophead Coupé, Phantom Coupé	'03-	8,5		●			●			-	-			Spezialprodukt			-	Getriebeöl BS 75W-90		14
Ghost	'10-	-	●	●			●			-	-			Spezialprodukt			-	Getriebeöl BS 75W-90		-

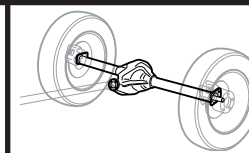
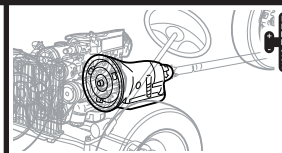
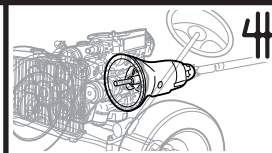
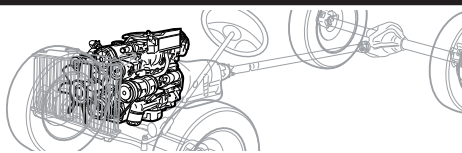
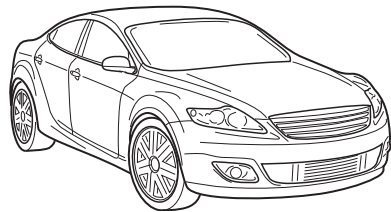

## ROVER

			SuperTronic			HighTronic			Blue Tronic 10W-40		Aral	⚠	Aral		⚠		Aral	⚠	
			G 0W-30	0W-40	LL III 5W-30	M 5W-40	5W-40	G 5W-30					Synthese	Mineral					
111, 114	'90-'99	4,5		●		●		●	2	Getr.Öl EP Synth 75W-90		Getriebeöl ATF 55	Getriebeöl ATF 22		↔	↔		4,5	
City Rover	'03-'05	4,5		●		●		●	2,9	Getr.Öl SNS-B 75W-80		-	-		↔	↔		6	
216, 220i, Coupé 2.0	'89-'96	3,4-4,5				●		●	1,8	HighTronic 5W-40		Getr.Öl ATF E-S	Getriebeöl ATF 55		↔	↔		5,5-7	
Coupé, Tourer, Cabriolet 1.4, 1.6	'92-'05	4,5				●		●	2	Getr.Öl EP Synth 75W-90		Getriebeöl ATF 55	Getriebeöl ATF 22		↔	↔		5,5-5,8	
Coupé, Tourer 1.8 vvc	'96-'99	4,5				●		●	2,3	Getr.Öl SNS-B 75W-80		-	-		↔	↔		4,5	
214, 216	'95-'99	4,5				●		●	2	Getr.Öl EP Synth 75W-90		Getriebeöl ATF 55	Getriebeöl ATF 22		↔	↔		5,5	
218	'95-'99	3,5				●		●	2,3	Getr.Öl SNS-B 75W-80		-	-		↔	↔		5,5	
200 Vi	'95-'99	4,5				●		●	2,2	Getr.Öl SNS-B 75W-80		-	-		↔	↔		5,5	
25 1.1, 1.4, 1.6	'99-'05	4,5		●		●		●	1,8-2	Getr.Öl EP Synth 75W-90		-	-		↔	↔		4,5-5,5	
25 1.8	'99-'05	4,5		●		●		●	2-2,2	Getr.Öl SNS-B 75W-80		Spezialprodukt	-		↔	↔		4,8-5,5	
414, 416	'95-'99	4/4,5				●		●	1,8	Getr.Öl EP Synth 75W-90		Getr.Öl ATF E-S	Getriebeöl ATF 55		↔	↔		4,5/5,5	
420	'95-'99	4,5				●		●	2,2	Getr.Öl SNS-B 75W-80		-	-		↔	↔		4,5	
45 1.4, 1.6	'99-'05	4,5		●		●		●	1,8-2	Getr.Öl EP Synth 75W-90		-	-		↔	↔		4,5-5,5	
45 1.8	'99-'05	4,5		●		●		●	2-2,2	Getr.Öl SNS-B 75W-80		Spezialprodukt	-		↔	↔		4,8-5,5	
45 2.0 V6	'99-'05	5,2		●		●		●	-	-		Spezialprodukt	-		↔	↔		4,7-5,8	
620i, 620Si, 623i	'93-'99	4,9-5,4				●		●	2	Getr.Öl SNS-B 75W-80		Getr.Öl ATF E-S	Getriebeöl ATF 55		↔	↔		7	
620i, 620Si, 623i	'93-'99	4,9-5,4				●		●	2	Getr.Öl SNS-B 75W-80		Getr.Öl ATF E-S	Getriebeöl ATF 55		↔	↔		7	
618i, 620Ti	'95-'99	3,8/5,9				●		●	2	Getr.Öl SNS-B 75W-80		Getr.Öl ATF E-S	Getriebeöl ATF 55		↔	↔		7	
75 1.8, 1.8T, 2.0, 2.5 V6	'99-'05	4,5-4,6		●		●		●	1,6	Getr.Öl SNS-B 75W-80		Spezialprodukt	-		↔	↔		6-7,5	
820, 825i, 827	'86-'96	4,5				●		●	2,2-2,3	HighTronic 5W-40		Getr.Öl ATF E-S	Getriebeöl ATF 55		↔	↔		8,6-10	
820i	'86-'99	4,5				●		●	2,3	HighTronic 5W-40		Getr.Öl ATF E-S	Getriebeöl ATF 55		↔	↔		10	
820 Vitesse, 825i	'96-'99	4,5/6,4			●	●		●	2	Getr.Öl SNS-B 75W-80		Spezialprodukt	-		↔	↔		7-8,5	
<b>Diesel</b>																			
113, 115 Diesel	'92-'99	3,5-3,8					●	●	2	Getr.Öl EP Synth 75W-90		-	-		↔	↔		4,5-5,5	
220 D, 420 D	'95-'99	4,5-4,8					●	●	2,2	Getr.Öl SNS-B 75W-80		-	-		↔	↔		7	
25, 45 2.0 TD	'99-'05	4,5		●			●	●	2	Getr.Öl EP Synth 75W-90		-	-		↔	↔		6,3-7	
620 Di	'95-'99	5,9					●	●	2	HighTronic 5W-40		-	-		↔	↔		7	
75 2.0 Di, CDTi	'99-'05	4,9/6,8		●			●	●	1,6	Getr.Öl SNS-B 75W-80		Spezialprodukt	-		↔	↔		8,2	
825 Turbo Diesel	'90-'99	5,8		●			●	●	2-2,2	HighTronic 5W-40		-	-		↔	↔		8	

## SAAB

900 2.0 (Turbo), 2.3	'93-'98	5-5,4		●		●		●	1,8	BlueTronic 10W-40	a	Getr.Öl ATF E-S	Getriebeöl ATF 55		↔	↔		8,5
900 2.5 V6	'93-'98	4,5		●		●		●	1,8	BlueTronic 10W-40	a	Getr.Öl ATF E-S	Getriebeöl ATF 55		↔	↔		8
2.0 Turbo, 2.5	'04-'05	4	●	●		●		●	3,5	Getriebeöl BS 75W-90		Getr.Öl ATF E-S	Getriebeöl ATF 55	e	0,8	Getriebeöl BS 75W-90		6,9-7,6
2.5, 2.5 Turbo	'06-'06	4	●	●		●		●	3,5	Getriebeöl BS 75W-90		Getriebeöl ATF J	Getriebeöl ATF 55	e	0,8	Getriebeöl BS 75W-90		7,3-7,8
9-3 2.0, 2.0 t, 2.0 Turbo, 2.3	'98-'00	4		●		●		●	1,8	Spezialprodukt			Getriebeöl ATF 55		↔	↔		8,5
9-3 2.0 t, 2.0 Turbo, 2.3 Turbo, Viggen	'01-'03	4	●	●		●		●	1,8	Spezialprodukt			Getriebeöl ATF 55		↔	↔		8,5
9-3 Sport 1.8i	'02-'11	4,3	●	●				●	1,6	Getriebeöl SNS 75W-80		-	-		↔	↔		6,5-6,8
9-3 Sport 1.8t, 2.0t, 2.0 Turbo, BioPower	'02-'10	6	●	●				●	1,9/3	Getriebeöl SNS 75W-80			Getriebeöl ATF J		↔	↔		7,5
9-3 Sport 2.8 Turbo V6	'05-'10	6,3	●	●				●	2,2	Getriebeöl SNS 75W-80			Getriebeöl ATF 55		↔	↔		9,6
9000i 2.0 (Turbo), 2.3 (Turbo), 3.0 V6	'89-'98	4,2-5,5		●		●		●	1,8-2,5	Getr.Öl EP Synth 75W-90	a	Getr.Öl ATF E-S	Getriebeöl ATF 55		↔	↔		8,5-9
9-5 2.0 t, 2.3 t, 2.3 Turbo, 3.0 V6 t	'97-'01	4-4,5	●	●		●		●	2	Spezialprodukt			Getriebeöl ATF 55		↔	↔		7,2-7,4
9-5 2.0 t, 2.3 t, 2.3 Turbo, 3.0 V6 t	'01-'05	4-4,5	●	●		●		●	2	Getriebeöl SNS 75W-80			Getriebeöl ATF J		↔	↔		7,2-7,4
9-5 Sport 2.0 t, 2.3 t, 2.3 Turbo, BioPower	'05-'10	4	●	●				●	2	Getriebeöl SNS 75W-80			Getriebeöl ATF J		↔	↔		7,4
9-5 1.6T, 2.0T (BioPower), XWD	'10-'11	4,5-5,7	●					●	2,2	Getr.Öl SNS-A 75W-85	b	Spezialprodukt	-	b	0,5-0,7	Spezialprodukt		-
9-5 2.8T V6 XWD	'10-'11	5,7	●					●	-	-		Spezialprodukt	-	b	0,5-0,7	Spezialprodukt		-
9-7X 4.2, 5.3 V8	'05-'08	5,7/6,6				●		●	2-2,3	Getriebeöl SNS 75W-80	d	Getriebeöl ATF 55	Getriebeöl ATF J	d	-	Getriebeöl BS 75W-90	c	10,2-11,6

<b>Diesel</b>															
9-3 2.2 TID	'98-'03	5,5	●	●			●	●	1,8	Spezialprodukt	-		↔	↔	8,5
9-3 Sport 1.9 TID	'04-'11	4,6	●	●			●	●	2,2	Getriebeöl SNS 75W-80		Getriebeöl ATF J	↔	↔	-
9-3 Sport 1.9 TTDID	'07-'11	4,6		●			●	●	2,2	Getriebeöl SNS 75W-80		Getriebeöl ATF J	↔	↔	-
9-3 Sport 2.2 TID	'01-'04	5,5	●	●			●	●	1,9	Getriebeöl SNS 75W-80	-		↔	↔	7,5
9-5 2.2, 3.0 V6 TID	'02-'05	5,5-6,8		●			●	●	2	Getriebeöl SNS 75W-80		Getriebeöl ATF J	↔	↔	7,2-8,1
9-5 Sport 1.9 TID	'05-'10	4,6	●	●			●	●	2	Getriebeöl SNS 75W-80		Getriebeöl ATF J	↔	↔	7,4
9-5 2.0 TID (118 kW)	'10-'11	4,5	●	●			●	●	2,2	Getr.Öl SNS-A 75W-85	Spezialprodukt		0,52-0,7	Spezialprodukt	9
9-5 2.0 TID (140 kW) XWD	'10-'11	4,5		●					2,2	Getr.Öl SNS-A 75W-85	Spezialprodukt		b 0,52-0,7	Spezialprodukt	b 9

a Kein synthetisches Öl verwenden

c Differenziale, vorn und hinten



e Differential, Modelle mit Automatikgetriebe: Getriebeöl BS 75W-90; Getriebeöl SNA-C 75W-90

b Verteilergetriebe: Spezialprodukt, bitte auf Originalersatzteil des Herstellers zurückgreifen!

d Verteilergetriebe: Spezialprodukt, bitte auf Originalersatzteil des Herstellers zurückgreifen!

## SEAT

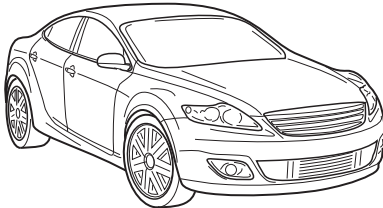
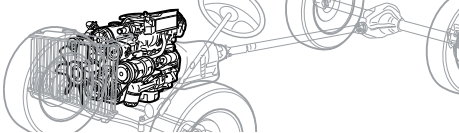
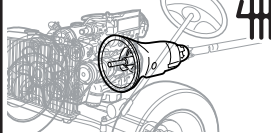
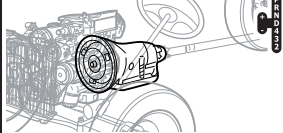
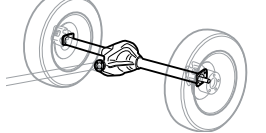
Marbella, Terra	'86-'98	3,6		●		●			2,4	Getriebeöl SNS 75W-80	-		↔	↔	5
Arosa 1.0, 1.4	'97-'05	3,4		●		●			2,7	Getr.Öl EP Synth 75W-90		Getriebeöl ATF-LD	↔	↔	5,5
Ibiza 1.0, 1.3, 1.4, 1.6, 1.8, 2.0, 16V	'93-'02	3,5-4,5	●			●			2-3,1	Getr.Öl EP Synth 75W-90		Getriebeöl ATF-LD	↔	↔	d 4-5,5
Cordoba 1.4, 1.6, 1.8, 2.0, 16V, 20VT	'93-'02	3,5-5,3	●			●			1,9-2	Getr.Öl EP Synth 75W-90		Getriebeöl ATF-LD	↔	↔	d 4-6,5
Ibiza, Cordoba 1.2, 1.2 12V, 1.4 16V, 2.0	'02-'08	3-4	●			●			1,9-2,1	Getr.Öl EP Synth 75W-90		Getr.Öl ATF E-S	↔	↔	5,5-6
Ibiza, Cordoba 1.6 16V	'07-'08	-	●			●			1,9-2,1	Getr.Öl EP Synth 75W-90	-		↔	↔	-
Ibiza 1.8 20VT, Cupra R	'04-'08	4,5	●			●			2	Getr.Öl EP Synth 75W-90	-		↔	↔	5
Ibiza 1.2 12V, 1.2 TSI, 1.4 16V	'08-	2,8-3,2	●			●			2	Getr.Öl EP Synth 75W-90	Spezialprodukt		↔	↔	-
Ibiza 1.4 TSI, TFSI Cupra	'09-	-	●			●			-	-	Spezialprodukt		↔	↔	-
Ibiza 1.6, 2.0	'08-	3,6-4	●			●			2	Getr.Öl EP Synth 75W-90	Spezialprodukt		↔	↔	-
León 1.4, 1.6, 1.8 20V	'99-'05	3,5-5	●			●			2	Getr.Öl EP Synth 75W-90		Getriebeöl ATF-LD	↔	↔	d 5-6,5
León 1.8 20VT, 4, Cupra R	'01-'05	4,5	●			●			2,4-2,6	Spezialprodukt	c	-	↔	↔	b 5
León 2.8 V6 Cupra 4	'01-'05	5,5	●			●			2,6	Spezialprodukt	c	-	1	Getriebeöl BS 75W-90	9,2
Exeo 1.6, 1.8 TSI, 2.0 TSI	'09-	3,8-4,6	●			●			3	Getr.Öl EP Synth 75W-90	-		↔	↔	-
Toledo 1.6, 1.8, 2.0, 16V	'91-'99	4-5	●			●			2	Getr.Öl EP Synth 75W-90		Getriebeöl ATF-LD	↔	↔	d 7,5
Toledo 1.6, 1.8 20V, V5	'99-'04	4-4,5	●			●			2	Getr.Öl EP Synth 75W-90		Getriebeöl ATF-LD	↔	↔	d 5-9
Altea (XL), León, Toledo 1.2 TSI, 1.4 16V	'10-	-	●			●			2	Getr.Öl EP Synth 75W-90	-		↔	↔	-
Altea (XL), León, Toledo 1.6	'04-	3,2/4,5	●			●			2	Getr.Öl EP Synth 75W-90	-		↔	↔	5,6/-
Altea (XL), León, 1.4 TSI	'07-	3,6	●			●			2	Spezialprodukt	-		↔	↔	-
Altea (XL), León, Toledo 2.0 FSI	'04-	4,6	●			●			2-2,1	Getr.Öl EP Synth 75W-90	Spezialprodukt		↔	↔	-
Altea (XL), León, Toledo 1.8 TSI, 2.0 TFSI, Cupra	'05-	4,6	●			●			2,3	Spezialprodukt	Spezialprodukt		↔	↔	-
Alhambra 1.8 20VT, 2.0	'95-'00	4,5	●			●			2-2,2	Getriebeöl ATF-LD		Getriebeöl ATF-LD	↔	↔	a 8-8,5
Alhambra 1.8 20VT, 2.0	'00-'10	4,5	●			●			2-2,2	Spezialprodukt		Getr.Öl ATF E-S	↔	↔	a 8-8,5
Alhambra 2.8 V6 24V, 4x4	'00-'10	5,5	●			●			2,3	Spezialprodukt	c	Getr.Öl ATF E-S	↔	↔	ab 11
Alhambra 1.4 TSI, 2.0 TSI	'10-	3,6-4,7	●			●			2,3	Spezialprodukt		Spezialprodukt	↔	↔	-
<b>Diesel</b>															
Arosa 1.4 TDi	'00-'05	3,8		●			●		2,7	Getr.Öl EP Synth 75W-90	-		↔	↔	5
Arosa 1.7 SDi	'98-'05	4,7	●			●			2,7	Getr.Öl EP Synth 75W-90	-		↔	↔	5-6,5
Ibiza, Cordoba 1.9 Diesel, SDi	'93-'02	4,3-4,5	●			●			2	Getr.Öl EP Synth 75W-90	-		↔	↔	6,5
Ibiza, Cordoba 1.9 Turbo D, TDi	'93-'02	4,5	●			●			2	Getr.Öl EP Synth 75W-90	-		↔	↔	6,5
Ibiza, Cordoba 1.4 TDi	'02-'07	3,8		●			●		1,9	Getr.Öl EP Synth 75W-90	-		↔	↔	5
Ibiza, Cordoba 1.4 TDi DPF	'07-'08	3,8-4,4		●			●		2	Getr.Öl EP Synth 75W-90	-		↔	↔	-
Ibiza, Cordoba 1.9 SDi	'02-'06	4,3		●			●		1,9-2	Getr.Öl EP Synth 75W-90	-		↔	↔	6,5
Ibiza, Cordoba 1.9 TDi (74, 96 kW)	'02-'08	4,5		●			●		2-2,3	Spezialprodukt	-		↔	↔	5
Ibiza, Cordoba 1.9 TDi (66, 77 kW)	'08-'09	4,5		●			●		1,9	Getr.Öl EP Synth 75W-90	-		↔	↔	-
Ibiza 1.9 TDi (118 kW) Cupra	'04-'08	4,5		●			●		2,3	Spezialprodukt	-		↔	↔	5
Ibiza 1.2 TDi, 1.4 TDi, 1.6 TDi, 1.9 TDi	'08-	-		●			●		1,9-2	Getr.Öl EP Synth 75W-90	-		↔	↔	-
Ibiza 2.0 TDi	'10-	-		●			●		2,3	Spezialprodukt	-		↔	↔	-
León, Toledo 1.9 SDi, TDi	'98-'05	4,5-5		●			●		2	Getr.Öl EP Synth 75W-90	-		↔	↔	6
León, Toledo 1.9 TDi (P-D), 4	'00-'05	4,3-4,5		●			●		2,4-2,6	Spezialprodukt	c	-	↔	↔	b 5
Toledo 1.9 Diesel, Turbo Diesel, TDi	'91-'98	4,5		●			●		2	Getr.Öl EP Synth 75W-90	-		↔	↔	6-7
Exeo 2.0 TDi	'08-	4,3		●			●		3	Getr.Öl EP Synth 75W-90	-		↔	↔	-
Altea (XL), León, Toledo 1.6 TDi	'10-	-		●			●		-	Getr.Öl EP Synth 75W-90	Spezialprodukt		↔	↔	-
Altea (XL), León, Toledo 1.9 TDi (P-D)	'04-'09	4,3		●			●		2	Getr.Öl EP Synth 75W-90	-		↔	↔	-

															
	SuperTronic			HighTronic			Blue Tronic			Aral			Aral		
	G 0W-30	0W-40	LL III 5W-30	M 5W-40	5W-40	G 5W-30	10W-40								
<b>SEAT</b>															
Altea (XL), León, Toledo 1.9 TDi (P-D) DPF	'06-'09	4,3		●				2	Getr.Öl EP Synth 75W-90	-			↕	↕	-
Altea (XL), León, Toledo 2.0 TDi (P-D)	'04-'10	3,8		●		●		2,3	Spezialprodukt	Spezialprodukt			↕	↕	-
Altea (XL), León, Toledo 2.0 TDi (P-D) DPF	'06-'10	3,8-4,3		●		●		2,3	Spezialprodukt	Spezialprodukt			↕	↕	-
Alhambra 1.9 TDI	'96-'00	4,3		●		●		2	Getriebeöl ATF-LD	Getriebeöl ATF-LD			↕	↕	9
Alhambra 1.9 TDI, 4x4	'00-'10	4,3-4,5		●		●		2,3	Spezialprodukt	c	Getr.Öl ATF E-S		↕	↕	b
Alhambra 2.0 TDI	'05-'10	3,8		●		●		2,5	Spezialprodukt	-			↕	↕	-
Alhambra 2.0 TDI	'10-	4,3		●				2,3	Spezialprodukt		Spezialprodukt		↕	↕	-

a Differential, Modelle mit Automatikgetriebe: 0,8 l Getriebeöl BS 75W-90

c Haldex-Kupplung (Cupra 4, AWD): 0,25 l Spezialprodukt, bitte auf Originalersatzteil des Herstellers zurückgreifen!

b Differential, hinten (Cupra 4, AWD): 1 l Getriebeöl BS 75W-90

d Differential, Modelle mit Automatikgetriebe: 0,8 l Getriebeöl BS 75W-90

**SKODA**

Felicia 1.1, 1.3	'94-'00	4,5						●	2,4	Getr.Öl EP Synth 75W-90	-			↕	↕	6
Fabia 1.0, 1.4 (16V), 2.0	'00-'07	3,2-4,5	●	●	●				1,9-2	Getr.Öl EP Synth 75W-90	Getriebeöl ATF-LD			↕	↕	6-6,5
Fabia 1.2 6V, 12V	'02-'07	2,4-2,8	●	●	●				-	Getr.Öl EP Synth 75W-90	-			↕	↕	5,1
Fabia II 1.2 6V, 12V, 1.4 16V (63kW), 1.6 16V	'07-'10	2,8-3,6	●	●	●			●	2	Getr.Öl EP Synth 75W-90	Spezialprodukt			↕	↕	5,2-5,9
Fabia II 1.2 6V, 12V, 1.2 TSI, 1.4 16V, 1.4 TSI	'10-	2,8-3,6	●	●	●				2	Getr.Öl EP Synth 75W-90	Spezialprodukt			↕	↕	5,2-5,9
Fabia II 1.6 16V	'10-	3,6	●	●	●				2	Getr.Öl EP Synth 75W-90	Spezialprodukt			↕	↕	5,9
Roomster 1.2, 1.4, 1.6	'06-'10	-	●	●	●				-	Getr.Öl EP Synth 75W-90	Spezialprodukt			↕	↕	-
Roomster 1.2 12V (51kW)	'06-'10	2,8	●	●	●			●	2	Getr.Öl EP Synth 75W-90	-			↕	↕	5,2
Roomster 1.2 12V, 1.2 TSI, 1.4 16V	'10-	2,8-3,2	●	●	●				2	Getr.Öl EP Synth 75W-90	Spezialprodukt			↕	↕	5,2-5,9
Roomster 1.6 16V	'10-	3,6	●	●	●				2	Getr.Öl EP Synth 75W-90	Spezialprodukt			↕	↕	5,9
Yeti 1.2 TSI, 1.4 TSI	'09-	-	●	●	●				2	Spezialprodukt	-			↕	↕	-
Yeti 1.8 TSI 4x4	'09-	-	●	●	●				2,3	Spezialprodukt	e	-	0,9	Getriebeöl BS 75W-90	-	
Octavia 1.4, 1.6, 1.8 20V (Turbo), 2.0, 4x4	'96-'00	3,5-4,7	●	●	●			●	1,5-2,4	Getr.Öl EP Synth 75W-90	a	Getriebeöl ATF-LD		↕	↕	b
Octavia 1.4, 1.6, 1.8 20V (Turbo), 2.0, 4x4	'01-'04	3,5-4,7	●	●	●				1,5-2,4	Getr.Öl EP Synth 75W-90	a	Getriebeöl ATF-LD		↕	↕	b
Octavia II 1.2 TSI, 1.4 TSI	'10-	3,2	●	●	●				2	Spezialprodukt				↕	↕	-
Octavia II 1.4, 1.6 (FSI), 2.0 FSI	'04-'09	3,2-4,5	●	●	●				2	Getr.Öl EP Synth 75W-90	Spezialprodukt			↕	↕	6,7-8,5
Octavia II 1.8 TSI, 2.0 FSI, 4x4	'05-'09	4,5	●	●	●			●	2-2,2	Spezialprodukt	e	-		↕	↕	c
Octavia II 2.0 TFSI RS	'05-'08	4,6	●	●	●			●	2	Spezialprodukt				↕	↕	-
Octavia II 1.4 16V (59kW), 1.6, 1.6 Multi Fuel	'04-	3,2-4,5	●	●	●				2	Getr.Öl EP Synth 75W-90	Spezialprodukt			↕	↕	6,7-7,7
Octavia II 1.8 TSI	'07-'09	4,5	●	●	●				1,9-2,1	Spezialprodukt	-			↕	↕	7,7
Superb 1.8 20V T, 2.0	'01-'08	3,8-4	●	●	●				2,3	Getr.Öl EP Synth 75W-90	-			↕	↕	6,7
Superb 2.8 V6 30V	'01-'08	6	●	●	●				2,3	Getr.Öl EP Synth 75W-90	Getriebeöl ATF-LD			↕	↕	d
Superb II 1.4 TSI (92kW), 1.8 TSI (118kW), 2.0 TSI	'08-	3,6-4,5	●	●	●				1,9-2,1	Spezialprodukt	Spezialprodukt			↕	↕	7,7-9,6
Superb II 3.6 V6 FSI 4x4	'08-	5,5		●					-	-	Spezialprodukt			↕	↕	-
<b>Diesel</b>																
Felicia 1.9 D	'94-'00	4-5		●				●	2,4	Getr.Öl EP Synth 75W-90	-			↕	↕	6-6,5
Fabia 1.4 TDI	'03-'07	3,8		●					-	Getr.Öl EP Synth 75W-90	-			↕	↕	-
Fabia II 1.4 TDI (51kW), 1.4 Tdi (59kW)	'07-'10	3,8-4,2		●		●			2	Getr.Öl EP Synth 75W-90	-			↕	↕	5,5
Fabia II 1.4 TDI (59kW) DPF	'07-'10	4,2		●					2	Getr.Öl EP Synth 75W-90	-			↕	↕	5,5
Fabia 1.9 SDI, TDI (P-D) (74 kW)	'00-'07	5		●					1,9	Getr.Öl EP Synth 75W-90	-			↕	↕	6
Fabia 1.9 TDI (P-D) (96 kW)	'00-'07	4,3		●					-	Getr.Öl EP Synth 75W-90	-			↕	↕	6,8
Fabia II 1.9 TDI (77kW)	'07-'10	4,3		●					2	Getr.Öl EP Synth 75W-90	-			↕	↕	6,8
Fabia II 1.9 TDI (77kW) DPF	'07-'10	4,3		●					2	Getr.Öl EP Synth 75W-90	-			↕	↕	6,8
Fabia, Roomster 1.4 TDI (51kW)	'06-'10	3,8		●		●			2	Getr.Öl EP Synth 75W-90	-			↕	↕	5,5
Fabia, Roomster 1.4 TDI DPF(59kW), 1.9 TDI DPF	'06-'10	4,2		●					2	Getr.Öl EP Synth 75W-90	-			↕	↕	5,5

Fabia II 1.2 TDI, 1.6 TDI	'10-	-							1,9	Getr.Öl EP Synth 75W-90	-														-	
Roomster 1.4 TDI (59kW), 1.9 TDI (77kW)	'06-'10	3,8-4,3							2	Getr.Öl EP Synth 75W-90	-															5,5-6,8
Roomster 1.2 TDI, 1.6 TDI	'10-	-							1,9	Getr.Öl EP Synth 75W-90	-															-
Yeti 1.6 TDI	'10-	-							1,9	Getr.Öl EP Synth 75W-90	-															-
Yeti 2.0 TDI, 4x4	'09-	-							2-2,3	Spezialprodukt	e	Spezialprodukt					e	0,9	Getriebeöl BS 75W-90						-	
Octavia 1.9 SDi, TDi, 4x4	'96-'04	4,5							1,7-2,4	Getr.Öl EP Synth 75W-90	a	-											b		5-6,5	
Octavia 1.9 TDi (P-D), 4x4	'01-'04	4,3							2,3-2,6	Getr.Öl EP Synth 75W-90	a	-											b		6,3	
Octavia 1.9 TDi (P-D)	'04-'09	4,3							1,9	Getr.Öl EP Synth 75W-90		Spezialprodukt													7,7	
Octavia 1.9 TDi (P-D) 4x4	'04-'09	4,3							2,2	Spezialprodukt	e	-											c		7,7	
Octavia 2.0 TDi (P-D) DPF	'04-'09	3,8							-	Spezialprodukt		Spezialprodukt													8,2	
Octavia II 1.6 TDi DPF	'09-	3,8							1,7	Getr.Öl EP Synth 75W-90		Spezialprodukt													-	
Octavia II 1.9 TDi DPF	'06-'10	4,3							1,9	Getr.Öl EP Synth 75W-90		Spezialprodukt													7,7	
Octavia II 1.9 TDi DPF 4x4	'06-'10	4,3							2,2	Spezialprodukt		-					0,95	Getriebeöl BS 75W-90				e			7,7	
Octavia II 2.0 TDi (100kW), (103kW), 4x4 (103kW)	'04-'10	3,8							-	Spezialprodukt		Spezialprodukt					0,95	Getriebeöl BS 75W-90				e			8,2	
Octavia II 2.0 TDi (103kW) DPF, 4x4 (103kW) DPF	'05-	4,3							-	Spezialprodukt		Spezialprodukt					0,95	Getriebeöl BS 75W-90				e			8,2	
Octavia II 2.0 TDi RS (125kW)	'06-	4,4-3							2,3	Spezialprodukt		Spezialprodukt													8,2-9,4	
Superb 1.9 TDi (P-D), 2.0 Tdi	'01-'08	3,6-3,8							2,3	Getr.Öl EP Synth 75W-90		Getriebeöl ATF-LD											d		6,5	
Superb 2.5 TDi	'01-'08	5,4							2,4-3,2	Getr.Öl EP Synth 75W-90		Getriebeöl ATF-LD											d		8,6	
Superb II 1.6 TDi	'10-	-							1,9	Spezialprodukt		-													-	
Superb II 1.9 TDi (77kW)	'08-'10	3,8							1,9	Spezialprodukt		-													8,4-9,4	
Superb II 1.9 TDi (77kW) DPF	'08-'10	3,8							1,9	Spezialprodukt		-													8,4-9,4	
Superb II 2.0 TDi, 4x4	'08-	4,3							2,3	Spezialprodukt	e	Spezialprodukt					e	0,95	Getriebeöl BS 75W-90						-	

a Haldex-Kupplung (4x4): 0,25 l Spezialprodukt, bitte auf Originalersatzteil des Herstellers zurückgreifen!  
c Differential, hinten (4x4): 0,95 l Getriebeöl BS 75W-90  
e Haldex-Kupplung (4x4): 0,65 l Spezialprodukt, bitte auf Originalersatzteil des Herstellers zurückgreifen!

b Differential, hinten (4x4): 1 l Getriebeöl BS 75W-90  
d Differential, Modelle mit Automatikgetriebe: 0,8 l Getriebeöl BS 75W-90

Achtung: Alle Fahrzeuge mit LongLife-Service: Aral SuperTronic LongLife III 5W-30 verwenden!

## SMART

city-coupé	'98-'03	3,2							1,4	Spezialprodukt	-															4,2	
city-coupé, fortwo, Brabus	'03-'06	3-3,2							1,4	Spezialprodukt	-															4,2	
fortwo, turbo, Brabus	'07-	3,7							1,7	Getr.Öl SNS-AT 75W-90	-															-	
fortwo mhd (45 kW)	'08-	3,7							1,7	Getr.Öl SNS-AT 75W-90	-															-	
fortwo mhd (52 kW)	'08-	3,3							1,7	Getr.Öl SNS-AT 75W-90	-															-	
fortwo electric drive	'10-	-							2,3	Getr.Öl SNS-AT 75W-90	-															-	
fourfour 1.0, 1.1, 1.3, 1.5, Brabus	'04-'06	3,2-4,2							1,7	Getr.Öl SNS-AT 75W-90		Spezialprodukt														4,2-4,6	
roadster, Brabus	'03-'06	3							1,7	Spezialprodukt	-															4,2	
<b>Diesel</b>																											
city-coupé cdi	'99-'03	3,2							1,4	Spezialprodukt	-															4,5	
city-coupé, fortwo cdi	'01-'06	3,2							1,4	Spezialprodukt	-															4,5	
fortwo cdi	'07-	2,7-3,4							1,7	Getr.Öl SNS-AT 75W-90	-															-	
fourfour 1.5 cdi	'04-'06	5,5							1,7	Getr.Öl SNS-AT 75W-90	-															-	

## SSANGYONG

Chairman H 2.3 16V, 2.8 24V, 3.2 24V	'04-'06	5,8-7							8	Getr.Öl ATF E-S	-																1,1	Getr.Öl BS LSX 75W-140								9,8-10,2	
Korando, Musso 2.3, 3.2	'94-'07	6,5-8,2							3,4	Getr.Öl ATF E-S	-																										11,5
Korando C / New Actyon	'12-	4,5							1,6	Getr.Öl SNS-A 75W-85	m	-																									8,5
Kyron, Actyon M230, 4WD, M320 4WD	'07-	7,5-9							3,6	Getriebeöl ATF 22	j																										10,5-12
Rexton 230, 320	'02-'06	7,5-8,2							3,4-3,6	Getr.Öl ATF E-S	b	Getr.Öl ATF E-S																									10-11,5
Rexton M320 4WD	'10-	9							-	-	-																										11,5-12
Rodius, Stavic 320	'05-'09	7-9							3,4	Getr.Öl ATF E-S	bg	Getr.Öl ATF E-S																									11,5
<b>Diesel</b>																																					
Korando 2.2 D, 2.5 D	'94-'99	5							1,8-2	Getr.Öl ATF E-S	b	-																									11
Korando, Musso 2.3 D	'98-'02	6,5-8							3,4	Getr.Öl ATF E-S	b																										9-10
Korando, Musso 2.9 D, TD	'98-'07	8-9,5							3,4	Getr.Öl ATF E-S	b																										10-11
Korando C / New Actyon e-XDi200, 4WD	'11-	6							1,6	Getr.Öl SNS-A 75W-85	m	Spezialprodukt																									8,5
Kyron XDi200, XDi270, 4WD	'05-'07	7,5-8,5							3,6	Getr.Öl ATF E-S	b																										11,5
Kyron XDi200 XVT, XDi270, 4WD	'07-	7,5-8,5							3,4-3,6	Getriebeöl ATF 22	o	Spezialprodukt																									10,5-11,5

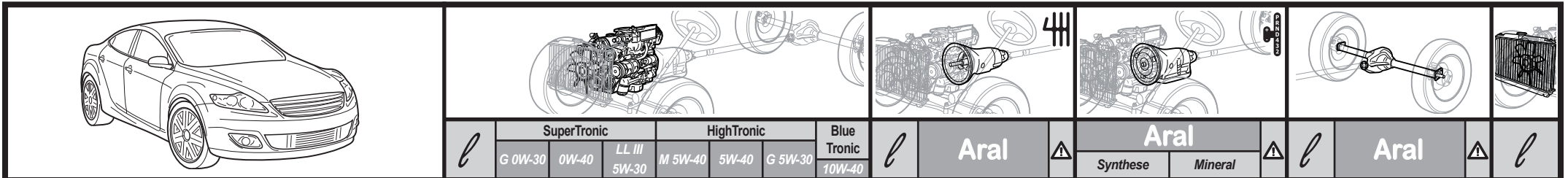

**SSANGYONG**

Modell	Jahr	Leistung	SuperTronic			HighTronic			Blue Tronic	Aral	Aral	Aral		Aral	Aral	Aral		
			G 0W-30	0W-40	LL III 5W-30	M 5W-40	5W-40	G 5W-30				10W-40	Synthese				Mineral	
Kyron XDi200 XVT + DPF, XDi270 + DPF, 4WD	'07-	7,5-8,5	●	●	●	●	●	●	3,4-3,6	Getriebeöl ATF 22	o	Spezialprodukt	lo	1,5	Getriebeöl BS 75W-90	fn	10,5-11,5	
Actyon 2.0 CRDi, 4WD	'06-'08	7,5	●	●	●	●	●	●	3,4	Getr.Öl ATF E-S	b	Getr.Öl ATF E-S	Getriebeöl ATF 55	b	1,4/1,9	Getriebeöl BS 75W-90	d	11,5
Actyon XDi200, 4WD	'08-	7,5	●	●	●	●	●	●	3,4-3,6	Getriebeöl ATF 22	o	Spezialprodukt		o	1,5	Getriebeöl BS 75W-90	fn	10,5-11
Actyon XDi200 + DPF, 4WD	'08-	7,5	●	●	●	●	●	●	3,4-3,6	Getriebeöl ATF 22	o	Spezialprodukt		o	1,5	Getriebeöl BS 75W-90	fn	10,5-11
Rexton 270 XDi	'04-'09	8,3	●	●	●	●	●	●	3,4	Getr.Öl ATF E-S	b	Getr.Öl ATF E-S	Getriebeöl ATF 55	b	1,4/2,2	Getriebeöl BS 75W-90	d	11-11,5
Rexton RX270, 4WD	'10-	8,5	●	●	●	●	●	●	3,4-3,6	Getriebeöl ATF 22	o		Getr.Öl ATF M14	o	2	Getriebeöl BS 75W-90	f	11-11,5
Rexton RX270 + DPF, 4WD	'10-	8,5	●	●	●	●	●	●	3,4-3,6	Getriebeöl ATF 22	o		Getr.Öl ATF M14	o	2	Getriebeöl BS 75W-90	f	11-11,5
Rexton RX270 XVT, 4WD	'10-	8,5	●	●	●	●	●	●	3,4-3,6	Getriebeöl ATF 22	o		Getr.Öl ATF M14	o	1,5	Getriebeöl BS 75W-90	k	11-11,5
Rexton RX270 XVT + DPF, 4WD	'10-	8,5	●	●	●	●	●	●	3,4-3,6	Getriebeöl ATF 22	o		Getr.Öl ATF M14	o	1,5	Getriebeöl BS 75W-90	k	11-11,5
Rexton 290 Td	'02-'06	8	●	●	●	●	●	●	3,4	Getr.Öl ATF E-S	b	Getr.Öl ATF E-S	Getriebeöl ATF 55	b	1,4/1,9	Getriebeöl BS 75W-90	d	10,5-11
Rodius, Stavic 270 XDi	'05-'09	6,3-8,3	●	●	●	●	●	●	3,4	Getr.Öl ATF E-S	b		Getr.Öl ATF M14	b	1,3-1,7	Getriebeöl BS 75W-90	d	11,5

- a Verteilergetriebe, Automatikgetriebe: 1,4-1,5 | Getr.Öl ATF E-S; Getriebeöl ATF 55
- c Automatikgetriebe BTRA M74LE : Getr.Öl ATF E-S; Getriebeöl ATF 55
- e Sperrdifferential: Getr.Öl BS LSX 75W-140
- g Getriebe mit 4x4: 3,4 | Getr.Öl ATF E-S; Getriebeöl ATF 55
- j Verteilergetriebe, Automatikgetriebe: 1,1-1,4 | Getr.Öl ATF E-S; Getriebeöl ATF 55
- l Automatikgetriebe DC5: 8 | Getriebeöl ATF M14
- n Differential, hinten (4WD): 0,7 | Getriebeöl BS 75W-90; Getriebeöl SNA-C 75W-90

- b Verteilergetriebe: 1,4 | Getr.Öl ATF E-S; Getriebeöl ATF 55
- d Differentiale, vorn und hinten
- f Differential, vorne: 1,4 | Getriebeöl BS 75W-90; Getriebeöl SNA-C 75W-90
- h Differential, hinten (Starrachse): 1,9 | Getriebeöl BS 75W-90; Getriebeöl SNA-C 75W-90
- k Differenzial, vorn, mit integrierter Ölwanne: Getriebeöl BS 75W-90; Getriebeöl SNA-C 75W-90
- m Verteilergetriebe: Getriebeöl BS 75W-90; Getriebeöl SNA-C 75W-90
- o Verteilergetriebe: Getr.Öl ATF E-S; Getriebeöl ATF 55

**SUBARU**

Modell	Jahr	Leistung	SuperTronic			HighTronic			Blue Tronic	Aral	Aral	Aral		Aral	Aral	Aral		
			G 0W-30	0W-40	LL III 5W-30	M 5W-40	5W-40	G 5W-30				10W-40	Synthese				Mineral	
Vivio, 4WD	'97-'00	2,7		●	●	●	●	●	2/3	Getr.Öl SNS-B 75W-80		Getr.Öl ATF E-S	Getriebeöl ATF 55	↔	↔	c	3,1	
Justy 1.0, 1.2, 4WD	'84-'96	2,8		●	●	●	●	●	2,1/3,4	Getr.Öl SNS-B 75W-80		Getr.Öl ATF E-S	Getriebeöl ATF 55	↔	↔	c	4,6-4,9	
Justy 1.0, 1.3	'07-'11	3,6	●	●	●	●	●	●	2,25	Getr.Öl SNS-A 75W-85		Getr.Öl ATF E-S	Getriebeöl ATF 55	↔	↔		3,3-3,5	
Justy 1.3	'96-'03	3,3	●	●	●	●	●	●	4,1	Getr.Öl SNS-B 75W-80		Getr.Öl ATF E-S	Getriebeöl ATF 55	↔	↔		4,7	
G3X Justy 1.3 16V	'03-'07	4,1	●	●	●	●	●	●	2,2	Getr.Öl SNS-A 75W-85	a	-		1	Getriebeöl BS 75W-90		5,4-5,6	
Trezia 1.3i, 1.5i	'11-	3,4-3,7	●	●	●	●	●	●	2,4	Getr.Öl EP Synth 75W-90		Spezialprodukt		↔	↔		4,6-5	
Impreza 1.5R, AWD	'07-'12	4,2	●	●	●	●	●	●	3,5	Getriebeöl BS 75W-90	a		Getriebeöl ATF J	a	0,8	Getriebeöl BS 75W-90	d	-
Impreza 1.6, 1.8, 2.0, 2.0 Turbo, 2.5, 4WD	'93-'00	4,4-5		●	●	●	●	●	3,3/4	Getriebeöl BS 75W-90		Getr.Öl ATF E-S	Getriebeöl ATF 55	↔	↔	bc	6-7,2	
Impreza 1.6, 2.0, WRX, STI, 2.5	'00-'07	4,5-5	●	●	●	●	●	●	3,5-4	Getriebeöl BS 75W-90		Getr.Öl ATF E-S	Getriebeöl ATF 55	↔	↔	bc	6,9-7,4	
Impreza 2.0R	'07-'12	4,2	●	●	●	●	●	●	3,5	Getriebeöl BS 75W-90			Getriebeöl ATF J		0,8	Getriebeöl BS 75W-90	d	6,9-7
Impreza 2.0i	'12-	4,8	●	●	●	●	●	●	3,5	Getriebeöl BS 75W-90		Spezialprodukt			0,8	Getriebeöl BS 75W-90	g	7,5-7,8
Impreza 2.5i, 2.5T WRX, 2.5T WRX STI	'07-'11	4,4-3	●	●	●	●	●	●	3,5-4,1	Getriebeöl BS 75W-90			Getriebeöl ATF J		0,8-1,2	Getriebeöl BS 75W-90	f	6,7-7,7
Impreza 2.5i, 2.5T WRX, 2.5T WRX STI	'11-	4,4-3	●	●	●	●	●	●	3,5-4,1	Getriebeöl BS 75W-90			Getriebeöl ATF J		0,8-1,2	Getriebeöl BS 75W-90	f	6,7-7,7
Forester 2.0, 2.0 T	'97-'08	4,4-5	●	●	●	●	●	●	3,9,4	Getriebeöl BS 75W-90		Getr.Öl ATF E-S	Getriebeöl ATF 55	↔	↔	bc	6-7,4	
Forester 2.0	'08-'13	4,2	●	●	●	●	●	●	4	Getriebeöl BS 75W-90			Getriebeöl ATF J		0,8	Getriebeöl BS 75W-90	d	6,9-7,3
Forester 2.5, 2.5 T	'08-'11	4	●	●	●	●	●	●	3,5-4	Getriebeöl BS 75W-90			Getriebeöl ATF J		0,8-1,2	Getriebeöl BS 75W-90	f	6,8-7,4
Forester 2.5	'11-'13	5,2	●	●	●	●	●	●	3,5	Getriebeöl BS 75W-90			Getriebeöl ATF J		0,8-1,2	Getriebeöl BS 75W-90	f	7-7,1
Forester 2.5 T	'11-'13	4,2	●	●	●	●	●	●	3,5	Getriebeöl BS 75W-90			Getriebeöl ATF J		0,8-1,2	Getriebeöl BS 75W-90	f	8
Forester 2.0i, 2.5i	'13-	4,8	●	●	●	●	●	●	-	Getriebeöl BS 75W-90		Spezialprodukt			-	Getriebeöl BS 75W-90	g	-
Forester 2.0XT	'13-	5,1	●	●	●	●	●	●	-	-		Spezialprodukt			1,7	Getriebeöl BS 75W-90		8,9
Legacy, Outback 2.0, 2.2, 2.5, 4WD	'94-'04	4,4-5		●	●	●	●	●	3,3-3,5	Getriebeöl BS 75W-90		Getr.Öl ATF E-S	Getriebeöl ATF 55	↔	↔	bc	6-6,4	
Legacy, Outback 2.0, 2.5, 3.0	'04-'06	4/5,5	●	●	●	●	●	●	3,5-4	Getriebeöl BS 75W-90		Getr.Öl ATF E-S	Getriebeöl ATF 55	↔	↔	bc	6,3-7,8	
Legacy, Outback 2.0R	'06-'09	-	●	●	●	●	●	●	-	Getriebeöl BS 75W-90			Getriebeöl ATF J		↔	↔	bc	-
Legacy, Outback 2.5, 2.5 Turbo, 3.6R	'06-'11	4-6,3	●	●	●	●	●	●	3,5-4,1	Getriebeöl BS 75W-90			Getriebeöl ATF J	e	↔	↔	bc	6,3-7,2
Legacy, Outback 2.5, 2.5 Turbo, 3.6R	'11-'13	4-2-6,3	●	●	●	●	●	●	3,7	Getriebeöl BS 75W-90			Getriebeöl ATF J	e	↔	↔	bcg	6,4-6,5
Legacy, Outback 2.5i	'13-	4,8	●	●	●	●	●	●	3,3	Getriebeöl BS 75W-90		Spezialprodukt			0,8	Getriebeöl BS 75W-90	g	7,5-7,6



Legacy, Outback 3.6R	'13-	6,5	●	●	●	●	●	●	-	-		Getriebeöl ATF J	0,8	Getriebeöl BS 75W-90	b	6,5
BRZ 2.0	'12-	5,4	●	●	●	●	●	●	2,2	Getriebeöl SNS 75W-80	Spezialprodukt		1,15	Getriebeöl BS 75W-90	h	7,2-7,5
XV 2.0i	'12-	4,8	●	●	●	●	●	●	3,5	Getriebeöl BS 75W-90	Spezialprodukt		0,8	Getriebeöl BS 75W-90	g	7,5-7,8
(B9) Tribeca	'06-'11	5,7-6,3	●	●	●	●	●	●	-	-		Getriebeöl ATF J	0,8-1,4	Getriebeöl BS 75W-90	f	7,2-7,6
Tribeca	'11-	6,5	●	●	●	●	●	●	-	-		Getriebeöl ATF J	0,8-1,4	Getriebeöl BS 75W-90	f	7,6
<b>Diesel</b>																
Trezia 1.4 D	'11-	4,1	HighTronic J 5W-30							2,4	Getr.Öl EP Synth 75W-90	Getr.Öl SNS-B 75W-80	↔	↔		4,3-4,6
Impreza 2.0 D	'08-'12	5,9	●	●	●	●	●	●	3,6-3,75	Getriebeöl BS 75W-90	-		0,8	Getriebeöl BS 75W-90		8,6
Impreza 2.0 D	'13-	-	●	●	●	●	●	●	-	Getriebeöl BS 75W-90	-		-	Getriebeöl BS 75W-90		-
Forester 2.0 D	'08-'13	5,9	●	●	●	●	●	●	3,7	Getriebeöl BS 75W-90	-		0,8	Getriebeöl BS 75W-90		8,6
Forester 2.0 D	'13-	-	●	●	●	●	●	●	-	Getriebeöl BS 75W-90	-		-	Getriebeöl BS 75W-90		-
Legacy, Outback 2.0 D	'08-	5,9	●	●	●	●	●	●	-	Getriebeöl BS 75W-90	-		-	Getriebeöl BS 75W-90		-
XV 2.0 D	'12-	-	●	●	●	●	●	●	-	Getriebeöl BS 75W-90	-		0,8	Getriebeöl BS 75W-90		-

a Verteilergetriebe: Getriebeöl BS 75W-90; Getriebeöl SNA-C 75W-90

c Differential, hinten (4WD): 0,8 | Getriebeöl BS 75W-90; Getriebeöl SNA-C 75W-90

e CVT (Automat): Spezialprodukt, bitte auf Originalersatzteil des Herstellers zurückgreifen!

g Differential, Modelle mit CVT: Getriebeöl BS 75W-90; Getriebeöl SNA-C 75W-90

b Differential, Modelle mit Automatikgetriebe: 1,1-1,4 | Getriebeöl BS 75W-90; Getriebeöl SNA-C 75W-90

d Differential, Modelle mit Automatikgetriebe: 1,2 | Getriebeöl BS 75W-90; Getriebeöl SNA-C 75W-90

f Differentiale, vorn und hinten

h Sperrdifferential: Getr.Öl BS LSX 75W-140; Getr.Öl HYP LS 85W-90

## SUZUKI

Alto 1.0	'94-'02	3,6	●	●	●	●	●	●	2,4	Getr.Öl SNS-B 75W-80		Getr.Öl ATF E-S	Getriebeöl ATF 55	↔	↔		3,5/4	
Alto 1.0	'09-	2,7	●	●	●	●	●	●	2,2	Getr.Öl SNS-B 75W-80			Getriebeöl ATF J	↔	↔		4,3	
Alto 1.1	'02-'09	4	●	●	●	●	●	●	2,2	Getr.Öl SNS-B 75W-80		Getr.Öl ATF E-S	Getriebeöl ATF 55	↔	↔		3,5	
Wagon R+ 1.0, 1.2, 1.3	'97-'06	3,3-3,5	●	●	●	●	●	●	2,1-2,2	Getr.Öl SNS-B 75W-80		Getr.Öl ATF E-S	Getriebeöl ATF 55	↔	↔		3,5-4,4	
Wagon R+ 1.0, 1.2 (Z10XEP, Z12XEP)	'00-'08	3,1-3,5	●	●	●	●	●	●	2,2	Getr.Öl SNS-B 75W-80		Getr.Öl ATF E-S	Getriebeöl ATF 55	↔	↔		3,9	
Splash 1.0, 1.2	'08-	2,8-3,2	●	●	●	●	●	●	2,2	Getr.Öl SNS-B 75W-80			Getriebeöl ATF J	↔	↔		4,4-4,5	
Swift 1.0, 1.3, 1.3 16V GTi, 1.6, 4x4	'89-'00	3,3	●	●	●	●	●	●	2,4/4,1	Getr.Öl SNS-B 75W-80		Getr.Öl ATF E-S	Getriebeöl ATF 55	↔	↔	d	3,9-4,9	
Swift 1.0, 1.3 16V	'01-'03	3,3	●	●	●	●	●	●	2,4	Getr.Öl SNS-B 75W-80		Getr.Öl ATF E-S	Getriebeöl ATF 55	↔	↔		3,9-4,7	
Swift 1.3, 1.5, 1.6	'04-'10	3,7	●	●	●	●	●	●	2,2	Getr.Öl SNS-B 75W-80	f		Getriebeöl ATF J	↔	↔		6,1-6,2	
Swift 1.2	'10-	3,1	●	●	●	●	●	●	2,2	Getr.Öl SNS-A 75W-85			Getriebeöl ATF J	↔	↔		4,4-4,5	
Swift 1.6	'12-	3,7	●	●	●	●	●	●	1,8	Getr.Öl SNS-A 75W-85	-			↔	↔		-	
Ignis 1.3, 1.5, 4x4	'01-'06	3,8-4,1	●	●	●	●	●	●	2,2	Getr.Öl SNS-B 75W-80	a	Getr.Öl ATF E-S	Getriebeöl ATF 55	↔	↔	d	4,6	
SX4 1.5, 1.6, 4x4	'06-	3,9	●	●	●	●	●	●	2,5	Getr.Öl SNS-B 75W-80	a		Getriebeöl ATF J	a	0,7-0,9	Getriebeöl BS 75W-90	g	7,7
Baleno 1.3, 1.6, 4x4	'95-'02	3,3-3,4	●	●	●	●	●	●	2,4/4,1	Getr.Öl SNS-B 75W-80		Getr.Öl ATF E-S	Getriebeöl ATF 55	↔	↔	d	3,6-4,7	
Baleno 1.8	'98-'02	4,7-5	●	●	●	●	●	●	2,2/4,1	Getr.Öl SNS-B 75W-80		Getr.Öl ATF E-S	Getriebeöl ATF 55	↔	↔		4,2-5,6	
Liana 1.3, 1.6, 1.8, 4x4	'01-'07	4,1-4,2	●	●	●	●	●	●	2	Getr.Öl SNS-B 75W-80	a	Getr.Öl ATF E-S	Getriebeöl ATF 55	↔	↔	d	6,5-6,9	
Kizashi 2.4, 2.4 AWD	'10-	4,5	●	●	●	●	●	●	2,5	Getr.Öl SNS-A 75W-85		Spezialprodukt		a	0,7-0,9	Getriebeöl BS 75W-90		6,6
Samurai	'88-'98	3,5	●	●	●	●	●	●	1,3	Getr.Öl EP Synth 75W-90	b				1,5/2	Getriebeöl BS 75W-90	e	5
Jimny 1.3, 4x4	'98-'05	3,7	●	●	●	●	●	●	1,1	Getr.Öl SNS-B 75W-80	c	Getr.Öl ATF E-S	Getriebeöl ATF 55	c	1,1-1,5	Getriebeöl BS 75W-90	e	4,5-5,9
X-90	'95-'00	4,2	●	●	●	●	●	●	1,5	Getr.Öl SNS-B 75W-80	c	Getr.Öl ATF E-S	Getriebeöl ATF 55	c	1/2,2	Getriebeöl BS 75W-90	e	5-5,5
Vitara 1.6, 1.6 16V	'89-'98	4,2	●	●	●	●	●	●	1,5	Getr.Öl SNS-B 75W-80	c	Getr.Öl ATF E-S	Getriebeöl ATF 55	c	1/2,2	Getriebeöl BS 75W-90	eh	5,3
Vitara 2.0 V6	'95-'98	5,9	●	●	●	●	●	●	1,5	Getr.Öl SNS-B 75W-80	c	Getr.Öl ATF E-S	Getriebeöl ATF 55	c	1/2,2	Getriebeöl BS 75W-90	eh	8
Grand Vitara 1.6	'00-'05	4,2	●	●	●	●	●	●	1,5	Getr.Öl SNS-B 75W-80	c	Getr.Öl ATF E-S	Getriebeöl ATF 55	c	1/2,2	Getriebeöl BS 75W-90	eh	5,3
Grand Vitara 2.0, 2.5 V6, 2.7 V6	'98-'05	5,2-5,5	●	●	●	●	●	●	1,5-2,7	Getr.Öl SNS-B 75W-80	c	Getr.Öl ATF E-S	Getriebeöl ATF 55	c	1/2,2	Getriebeöl BS 75W-90	e	6,5-8
Grand Vitara 1.6, 2.0, 2.7 V6	'05-'08	4,5-5,5	●	●	●	●	●	●	1,9	Getr.Öl SNS-B 75W-80	c		Getriebeöl ATF J	c	0,8-1,1	Getriebeöl BS 75W-90	e	-
Grand Vitara 1.6, 2.4	'08-	4,4-4,6	●	●	●	●	●	●	1,9	Getr.Öl SNS-A 75W-85	a		Getriebeöl ATF J	a	0,8-1,1	Getriebeöl BS 75W-90	e	6,9-7,3
Grand Vitara 2.0, 3.2 V6	'08-'10	4-5,5	●	●	●	●	●	●	1,9	Getr.Öl SNS-B 75W-80	c		Getriebeöl ATF J	c	0,8-1,1	Getriebeöl BS 75W-90	e	-
<b>Diesel</b>																		
Wagon R+ 1.3 Diesel	'03-'06	3,2	●	●	●	●	●	●	2,6	Getr.Öl SNS-B 75W-80	-			↔	↔		5,3	
Splash 1.3 Diesel	'08-	3,1	●	●	●	●	●	●	2,6	Getr.Öl SNS-B 75W-80	-			↔	↔		-	
Swift 1.3 Diesel, DPF	'04-'10	3,2	●	●	●	●	●	●	1,6	Getr.Öl SNS-B 75W-80	-			↔	↔		5,9	
Swift 1.3 Diesel	'10-	3,2	●	●	●	●	●	●	2,2	Getr.Öl SNS-A 75W-85	-			↔	↔		6,5	
Swift 1.3 Diesel DPF	'10-	3,2	●	●	●	●	●	●	2,2	Getr.Öl SNS-A 75W-85	-			↔	↔		6,5	
Ignis 1.3 Diesel	'03-'06	3,2	●	●	●	●	●	●	2,2	Getr.Öl SNS-A 75W-85	-			↔	↔		-	
SX4 1.6 DDiS, 4x4	'09-	3,85	●	●	●	●	●	●	2	Getr.Öl SNS-A 75W-85	a				0,7-0,9	Getriebeöl BS 75W-90	g	6,5
SX4 1.9 DDiS, 4x4	'06-'09	4,5	●	●	●	●	●	●	2,5	Getr.Öl SNS-A 75W-85	a				0,7-0,9	Getriebeöl BS 75W-90	g	6,5
SX4 2.0 DDiS, 4x4	'09-	4,4	●	●	●	●	●	●	2	Getr.Öl SNS-A 75W-85	a				0,7-0,9	Getriebeöl BS 75W-90	g	6,5
Baleno 1.9 TD	'00-'02	4,5	●	●	●	●	●	●	2,2	Getr.Öl SNS-B 75W-80		Getr.Öl ATF E-S	Getriebeöl ATF 55	↔	↔		8	
Liana 1.4 Diesel	'04-'06	3,9	●	●	●	●	●	●	1,9	Spezialprodukt	-			↔	↔		6	

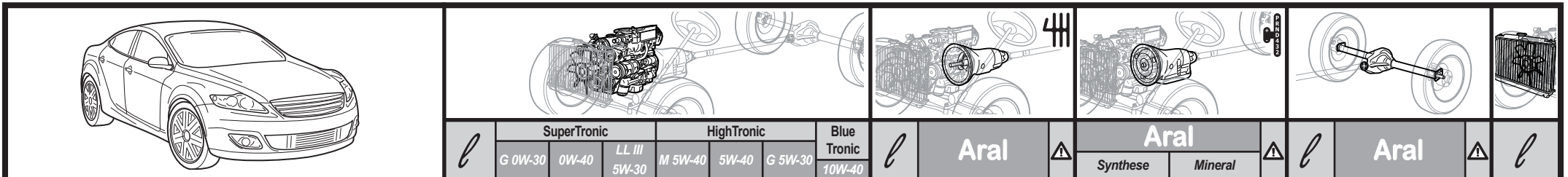
**SUZUKI**

			SuperTronic			HighTronic			Blue Tronic 10W-40	Aral	⚠	Aral		⚠	Aral	⚠		
			G 0W-30	0W-40	LL III 5W-30	M 5W-40	5W-40	G 5W-30				Synthese	Mineral					
Jimny 1.5 Diesel, 4x4	'04-'08	4		●			●	●	1,9	Getr.Öl SNS-B 75W-80	c	-		1,4/1,5	Getriebeöl BS 75W-90	e	7	
Grand Vitara 1.9 DDiS	'05-'08	5,1		●	●		●	●	2	Getr.Öl SNS-B 75W-80	c	-		0,8-1,1	Getriebeöl BS 75W-90	e	7,5	
Grand Vitara 1.9 DDiS DPF	'05-'08	5,1		●	●		●	●	2	Getr.Öl SNS-B 75W-80	c	-		0,8-1,1	Getriebeöl BS 75W-90	e	7,5	
Grand Vitara 1.9 DDiS Euro 4	'08-	5,1		●	●		●	●	1,9	Getr.Öl SNS-A 75W-85	a	-		0,9-1,1	Getriebeöl BS 75W-90	e	-	
Grand Vitara 1.9 DDiS Euro 4 DPF	'08-	5,1		●	●		●	●	1,9	Getr.Öl SNS-A 75W-85	a	-		0,9-1,1	Getriebeöl BS 75W-90	e	-	
Grand Vitara 1.9 DDiS Euro 5 DPF	'08-	5,1	HighTronic R 5W-30							1,9	Getr.Öl SNS-A 75W-85	a	-		0,9-1,1	Getriebeöl BS 75W-90	e	-
Grand Vitara 2.0 TD	'98-'05	5,5		●			●	●	2,7	Getr.Öl SNS-B 75W-80	c	Getr.Öl ATF E-S	Getriebeöl ATF 55	c	1/2,2	Getriebeöl BS 75W-90	e	6,5
Grand Vitara 2.0 TDi	'01-'05	4,5	●	●			●	●	2,7	Getr.Öl SNS-B 75W-80	c	Getr.Öl ATF E-S	Getriebeöl ATF 55	c	1/2,5	Getriebeöl BS 75W-90	e	9,2

a Verteilergetriebe: Getriebeöl BS 75W-90; Getriebeöl SNA-C 75W-90

c Verteilergetriebe: 0,7-1,7 l Getr.Öl SNS-B 75W-80; Getriebeöl SNS 75W-80

e Differentiale, vorn und hinten

g Differential, hinten (4x4): Getriebeöl BS 75W-90; Getriebeöl SNA-C 75W-90

b Verteilergetriebe: 0,8 l Getr.Öl EP Synth 75W-90; Getriebeöl EP 85W-90

d Differential, hinten (4WD/4x4): 0,7-1,2 l Getriebeöl BS 75W-90; Getriebeöl SNA-C 75W-90

f Semi-Automatikgetriebe: 1,75 l Getr.Öl SNS-B 75W-80; Getriebeöl SNS 75W-80

h Sperrdifferential: Getr.Öl BS LXS 75W-140

**TESLA**

Roadster	'09-	-	-						-	-		Spezialprodukt		←	←		7
----------	------	---	---	--	--	--	--	--	---	---	--	----------------	--	---	---	--	---

**TOYOTA**

iQ 1.0 VVT-i, 1.3 VVT-i	'08-	3,1-3,7	●	●		●			2,4	Getr.Öl SNS-B 75W-80		Spezialprodukt		↔	↔		4,3-4,9	
Aygo 1.0 12V VVT-i	'05-'09	3,1	●	●		●		●	1,7	Getr.Öl SNS-B 75W-80		-		↔	↔		4	
Aygo 1.0 12V VVT-i	'09-	3,6	●	●		●			1,7	Getr.Öl SNS-B 75W-80	j	-		↔	↔		4	
Starlet 1.0, 1.3, 1.3i	'90-'95	3,2		●		●		●	2,4	Getr.Öl SNS-B 75W-80		Getr.Öl ATF E-S	Getriebeöl ATF 55	↔	↔	g	4-5	
Starlet 1.3 16V	'96-'98	2,8		●		●		●	1,9	Getriebeöl SNS 75W-80		Getr.Öl ATF E-S	Getriebeöl ATF 55	↔	↔	g	4,5-5	
Yaris, Yaris/Echo Verso 1.0, 1.3, 1.5 VVT-i	'98-'06	3,2-3,7	●	●		●		●	1,4-1,9	Getr.Öl SNS-B 75W-80		Getr.Öl ATF E-S	Getriebeöl ATF J	↔	↔		4,5-5	
Yaris 1.0 VVT-i, 1.3 VVT-i (64 kW)	'05-'09	3,1-3,2	●	●		●		●	1,8	Getr.Öl EP Synth 75W-90		-		↔	↔		4,5-5,1	
Yaris 1.0 12V VVT-i, 1.3 16V Dual VVT-i	'09-'11	3,1/3,4	●	●		●		●	1,75/2,4	Getr.Öl EP Synth 75W-90		-		↔	↔		4,1-4,9	
Yaris 1.3 VVT-i (63 kW)	'05-'09	3,7		●		●		●	1,9	Getriebeöl SNS 75W-80		Getr.Öl ATF E-S	Getriebeöl ATF J	↔	↔		4,8-4,9	
Yaris 1.5 VVT-i	'05-'09	3,1	●	●		●		●	1,9	Getriebeöl SNS 75W-80		Spezialprodukt		↔	↔		4,7-4,8	
Yaris 1.8 16V VVT-i	'09-'11	3,2	●	●		●		●	2,4	Getr.Öl SNS-B 75W-80		-		↔	↔		5	
Yaris 1.0 12V, 1.3 16V	'11-	3,1-3,4	●	●		●		●	1,7-2,4	Getr.Öl SNS-B 75W-80		Spezialprodukt		↔	↔		4,5-4,8	
Yaris 1.5 Full Hybrid	'12-	3,7	●	●		●		●	-	-		Spezialprodukt		↔	↔		1,6-4,5	
Verso S/ Ractis 1.3 VVT-i	'10-	3,4	●	●		●		●	2,4	Getr.Öl SNS-B 75W-80		Spezialprodukt		↔	↔		4,6-4,8	
Verso S/ Ractis 1.5 VVT-i	'10-	3,7	●	●		●		●	-	-		Spezialprodukt		↔	↔		5	
Paseo	'96-'99	2,8		●		●		●	1,9	Getr.Öl SNS-B 75W-80		-		↔	↔		5	
Urban Cruiser 1.3 VVT-i	'09-	3,4	●	●		●		●	2,4	Getr.Öl SNS-B 75W-80		-		↔	↔		4,1-4,9	
Corolla 1.3i, 1.6i	'92-'97	3,2/3,3		●		●		●	2,4/2,6	Getr.Öl SNS-B 75W-80		Getr.Öl ATF E-S	Getriebeöl ATF 55	↔	↔	g	5/5,5	
Corolla 4WD Escape	'88-'97	3,2/3,7		●		●		●	5	Getriebeöl BS 75W-90		Getr.Öl ATF E-S	Getriebeöl ATF J	e	↔	↔	h	5/6
Corolla 1.3, 1.4, 1.6	'97-'02	2,8-3,7	●	●		●		●	1,9-2,1	Getr.Öl SNS-B 75W-80		Getr.Öl ATF E-S	Getriebeöl ATF 55	↔	↔	g	4,5-5,5	
Corolla 1.8, 4WD	'97-'02	3,9	●	●		●		●	4,5-5	Getriebeöl BS 75W-90		Getr.Öl ATF E-S	Getriebeöl ATF 55	↔	↔	gh	5,5	
Corolla, Corolla Verso 1.4, 1.6, 1.8 VVTL-i	'02-'07	3,7-4,4	●	●		●		●	1,9-2,3	Getr.Öl SNS-B 75W-80		Getr.Öl ATF E-S	Getriebeöl ATF J	↔	↔		6,5-7	
Corolla 1.8 VVTL-i Compressor	'05-'07	4,4	●	●		●		●	2,3	Getr.Öl SNS-B 75W-80		-		↔	↔		6,7	
Verso 1.6 16V VVT-i, 1.8 16V VVT-i	'07-'09	3,7	●	●		●		●	1,9	Getr.Öl SNS-B 75W-80		Getr.Öl ATF E-S	Getriebeöl ATF 55	↔	↔		6,5	
Verso 1.6 16V VVT-i, 1.8 16V VVT-i	'09-	4,2	●	●		●		●	2,4	Getr.Öl SNS-B 75W-80		Spezialprodukt		↔	↔		5,6-6,3	
Auris, Corolla 1.3 Dual VVT-i, 1.8 Valvematic	'09-	3,4/4,2	●	●		●		●	2,4	Getr.Öl SNS-B 75W-80		-		↔	↔		4,7-5,7	
Auris, Corolla 1.4, 1.6 VVT-i	'07-'09	4,2	●	●		●		●	1,9	Getr.Öl EP Synth 75W-90		-		↔	↔		6	
Auris, Corolla 1.6, Valvematic, Dual VVT-i	'09-	4,7	●	●		●		●	2,4	Getr.Öl SNS-B 75W-80	j	Spezialprodukt		j	↔	↔	5,5-5,6	
Auris HSD Full Hybrid	'10-'13	4,2	●	●		●		●	-	-		Spezialprodukt		↔	↔		6,5-7,3	

Auris 1.6 VVT-i	'13-	4,2	●	●	●	●	●	●	2,4	Getr.Öl SNS-B 75W-80		Spezialprodukt			↔	↔			5,6-5,8
Auris 1.8 Hybrid	'13-	4,2	●	●	●	●	●	●	-	-		Spezialprodukt			↔	↔			2,1-7
Prius	'01-'03	3,7	●	●	●	●	●	●	-	-		Getr.Öl ATF E-S	Getriebeöl ATF J		↔	↔			4,9/2,6
Prius THSD	'03-'09	3,3-3,9	●	●	●	●	●	●	-	-		Spezialprodukt			↔	↔			7,1-8,7
Prius	'09-	4,2	●	●	●	●	●	●	-	-		Spezialprodukt			↔	↔			6,5-7,3
Picnic	'96-'01	3,9		●	●	●	●	●	2,6	Getr.Öl SNS-B 75W-80		Getr.Öl ATF E-S	Getriebeöl ATF 55		↔	↔			6-7
Carina E 1.6i	'92-'97	3,3		●	●	●	●	●	2,6	Getr.Öl SNS-B 75W-80		Getr.Öl ATF E-S	Getriebeöl ATF 55		↔	↔			5,5
Carina E 2.0i	'92-'97	3,9-4,6		●	●	●	●	●	2,6	Getr.Öl SNS-B 75W-80		Getr.Öl ATF E-S	Getriebeöl ATF 55		↔	↔			5,5
Avensis 1.6, 1.8, VVT-i	'97-'03	3-3,7	●	●	●	●	●	●	1,9	Getr.Öl SNS-B 75W-80		Getr.Öl ATF E-S	Getriebeöl ATF 55		↔	↔			6-8,5
Avensis 2.0	'97-'00	3,9	●	●	●	●	●	●	2,2	Getr.Öl SNS-B 75W-80		Getr.Öl ATF E-S	Getriebeöl ATF 55		↔	↔			7,5
Avensis, Avensis Verso 2.0 VVT-i (D4)	'00-'03	4,2		●	●	●	●	●	2,2	Getr.Öl SNS-B 75W-80		Getr.Öl ATF E-S	Getriebeöl ATF J		↔	↔			7,5
Avensis, Avensis Verso 1.6, 1.8, 2.0 D4, 2.4 D4 VVT-i	'03-'09	3,7-4,3	●	●	●	●	●	●	1,9-2,5	Getr.Öl SNS-B 75W-80		Getr.Öl ATF E-S	Getriebeöl ATF J		↔	↔			5,8-7,5
Avensis 1.6, 1.8, 2.0 Valvematic	'09-	4,2	●	●	●	●	●	●	2,4	Getr.Öl SNS-B 75W-80	k	Spezialprodukt		k	↔	↔			-
MR2 2.0i, 2.2i	'90-'99	4,2		●	●	●	●	●	2,1-2,6	Getr.Öl SNS-B 75W-80		Getr.Öl ATF E-S	Getriebeöl ATF 55		↔	↔			13
MR2 1.8 VVT-i	'99-'05	3,7	●	●	●	●	●	●	1,8-1,9	Getr.Öl SNS-B 75W-80		-			↔	↔			10,4
Celica 1.8i	'93-'99	3,7		●	●	●	●	●	2,6	Getr.Öl SNS-B 75W-80		Getr.Öl ATF E-S	Getriebeöl ATF 55		↔	↔		g	6
Celica 2.0i, 2.2i	'93-'99	3,9-4,5		●	●	●	●	●	2,6-3,5	Getr.Öl SNS-B 75W-80		Getr.Öl ATF E-S	Getriebeöl ATF 55		↔	↔		g	7
Celica 2.0i Turbo 4WD	'93-'99	4,5		●	●	●	●	●	5,2	Getriebeöl BS 75W-90		-			↔	↔		h	7
Celica 1.8 VVT-i, VVTL-i	'99-'05	3,7-4,4		●	●	●	●	●	2,3	Getr.Öl SNS-B 75W-80		-			↔	↔			5,7
GT86 2.0 D-4S	'12-	5,4	●	●	●	●	●	●	2,2	Getriebeöl SNS 75W-80		Spezialprodukt			1,2	Getriebeöl BS 75W-90	n		7,2-7,5
Supra 3.0i 24V	'93-'02	5,2		●	●	●	●	●	2,6	Getr.Öl SNS-B 75W-80		Getr.Öl ATF E-S	Getriebeöl ATF J		1,4-1,7	Getr.Öl BS-LSX 75W-140			7,5
Supra 3.0i Twin Turbo 24V	'93-'02	5		●	●	●	●	●	2,6	Getr.Öl SNS-B 75W-80	b	Getr.Öl ATF E-S	Getriebeöl ATF J		1,4-1,7	Getr.Öl BS-LSX 75W-140			9,5
Camry 2.2i, 3.0i V6	'91-'02	3,9-4,2		●	●	●	●	●	2,6-4,2	Getr.Öl SNS-B 75W-80		Getr.Öl ATF E-S	Getriebeöl ATF 55		↔	↔			6,5-9,5
Camry 2.4 VVT-i, 3.0i 24V	'02-'04	4,3-4,7	●	●	●	●	●	●	2,5	Getr.Öl SNS-B 75W-80		Getr.Öl ATF E-S	Getriebeöl ATF J		↔	↔			6,2-9,2
Previa 2.4i, 4WD	'90-'00	5,8		●	●	●	●	●	2,2-2,6	Getr.Öl SNS-B 75W-80	c	Getr.Öl ATF E-S	Getriebeöl ATF 55	c	1,1	Getriebeöl BS 75W-90	f		11,5
Previa 2.4 VVT-i	'00-'05	4,3	●	●	●	●	●	●	2,5	Getr.Öl SNS-B 75W-80		Getr.Öl ATF E-S	Getriebeöl ATF J		↔	↔			6,5-8
RAV 4, Fun Cruiser	'94-'00	3,9		●	●	●	●	●	5	Getr.Öl SNS-B 75W-80		Getr.Öl ATF E-S	Getriebeöl ATF J	d	↔	↔		h	8
RAV 4 1.8, 2.0 VVT-i	'00-'06	3,7-4,2	●	●	●	●	●	●	1,9-3,4	Getr.Öl SNS-B 75W-80		Getr.Öl ATF E-S	Getriebeöl ATF J	d	↔	↔		h	6-6,5
RAV 4 2.0 VVT-i	'06-'09	3,8	●	●	●	●	●	●	2,5	Getr.Öl EP Synth 75W-90		Spezialprodukt		d	↔	↔		h	6,3-6,4
RAV 4 2.0 VVT-i, 2.3 16V	'09-	4,2/4,3	●	●	●	●	●	●	2,4	Getr.Öl SNS-B 75W-80	m	Spezialprodukt		k	0,5-0,55	Getriebeöl BS 75W-90			-
4Runner 2.7	'95-'03	5,4		●	●	●	●	●	2,2	Getr.Öl SNS-B 75W-80	c	Getr.Öl ATF E-S	Getriebeöl ATF 55	e	1,1/2,5	Getriebeöl BS 75W-90	af		10
4Runner 3.4 V6	'96-'03	5,2		●	●	●	●	●	2,2	Getr.Öl SNS-B 75W-80	c	Getr.Öl ATF E-S	Getriebeöl ATF 55	e	1,1/2,5	Getriebeöl BS 75W-90	af		10
Landcruiser 60 4.2	'85-'90	7,8		●	●	●	●	●	3,5	Getr.Öl EP Synth 75W-90	c	Getriebeöl ATF 22			3/2,5	Getriebeöl BS 75W-90	f		16,5
Landcruiser 70 2.4	'85-'96	4,3		●	●	●	●	●	2,6/2,8	Getr.Öl SNS-B 75W-80	d	-			1,8/2	Getriebeöl BS 75W-90	af		10-11
Landcruiser 70 4.0, 4.5	'85-'96	7,6-7,8		●	●	●	●	●	2,6-4,9	Getr.Öl SNS-B 75W-80	d	-			2,5-2,6	Getriebeöl BS 75W-90	af		13,2-18,5
Landcruiser 80 4.5 24V	'92-'98	7,4		●	●	●	●	●	2,7	Getriebeöl BS 75W-90	d	-			2,7-3,3	Getriebeöl BS 75W-90	af		11,5-14
Landcruiser 90 2.7 16V, 3.4 V6 24V	'96-'99	5,2-5,4		●	●	●	●	●	2,2	Getr.Öl SNS-B 75W-80	d	Getr.Öl ATF E-S	Getriebeöl ATF 55		1,1/2,9	Getriebeöl BS 75W-90	af		8-10
Landcruiser 90 2.7 16V, 3.4 V6 24V	'00-'02	5,2-5,4	●	●	●	●	●	●	2,2	Getr.Öl SNS-B 75W-80	d	Getr.Öl ATF E-S	Getriebeöl ATF 55		1,1/2,9	Getriebeöl BS 75W-90	af		8-10
Landcruiser 100 4.7 V8 32V	'98-'99	6,8		●	●	●	●	●	-	-		Getr.Öl ATF E-S	Getriebeöl ATF 55		1,6-3,3	Getriebeöl BS 75W-90	af		15
Landcruiser 100 4.5 24V, 4.7 V8 32V	'00-'08	6,8/7,4	●	●	●	●	●	●	-	-		Getr.Öl ATF E-S	Getriebeöl ATF 55		1,6-3,3	Getriebeöl BS 75W-90	af		13,4-15,7
Landcruiser 120 2.7 16V, 4.0 V6 VVT-i	'03-'09	5,1-5,2	●	●	●	●	●	●	2,2	Getr.Öl SNS-B 75W-80	d	Getr.Öl ATF E-S	Getriebeöl ATF J	d	1,4-3	Getriebeöl BS 75W-90	af		7,1-7,3
Landcruiser 150, 155 2.7 VVT-i	'09-	5,7	●	●	●	●	●	●	2,2	Getr.Öl SNS-B 75W-80	d	-			1,4-2,8	Getriebeöl BS 75W-90	nf		8,1-10,1
Landcruiser 150, 155 4.0 V6 VVT-i	'09-	6,1	●	●	●	●	●	●	2,1	Getriebeöl BS 75W-90	d	Spezialprodukt		d	1,4-2,8	Getriebeöl BS 75W-90	nf		10,5-12,8
Landcruiser 200 4.0 V6, 4.7 VVT-i V8	'08-	5,2/6,2	●	●	●	●	●	●	3	Getr.Öl SNS-B 75W-80	d	Spezialprodukt		d	4,1-4,25	Getriebeöl BS 75W-90	ln		11,2-16,9
<b>Diesel</b>																			
iQ 1.4 D-4D-F	'08-	4		●	●	●	●	●	2,4	Getr.Öl SNS-B 75W-80		-			↔	↔			-
iQ 1.4 D-4D-F DPF	'08-	4		●	●	●	●	●	2,4	Getr.Öl SNS-B 75W-80		-			↔	↔			-
Aygo 1.4 D	'05-'09	3,8	●	●	●	●	●	●	1,7	Getr.Öl EP Synth 75W-90		-			↔	↔			4
Yaris, Yaris/Echo Verso 1.4 D4-D	'01-'06	4,2		●	●	●	●	●	1,9	Getr.Öl SNS-B 75W-80		-			↔	↔			4,5
Yaris 1.4 D-4D	'05-'09	3,1		●	●	●	●	●	1,9	Getr.Öl EP Synth 75W-90		-			↔	↔			4,7-5
Yaris 1.4 D-4D	'09-'11	4,3		●	●	●	●	●	2,4	Getr.Öl SNS-B 75W-80		-			↔	↔			4,3-4,6
Yaris 1.4 D-4D DPF	'09-'11	4,3		●	●	●	●	●	2,4	Getr.Öl SNS-B 75W-80		-			↔	↔			4,3-4,6
Yaris 1.4 D-4D	'11-	3,9		●	●	●	●	●	2,4	Getr.Öl SNS-B 75W-80		-			↔	↔			4,9-5,3
Yaris 1.4 D-4D DPF	'11-	3,9		●	●	●	●	●	2,4	Getr.Öl SNS-B 75W-80		-			↔	↔			4,9-5,3
Verso S/ Ractis 1.4 D-4D DPF	'10-	4,1		●	●	●	●	●	2,4	Getr.Öl SNS-B 75W-80	j	-			↔	↔			4,3-4,6
Urban Cruiser 1.4 D-4D, 4WD	'09-	4,1		●	●	●	●	●	2,4	Getr.Öl SNS-B 75W-80	m	-			0,45	Getriebeöl BS 75W-90			4,3-4,6
Corolla 1.4 D4-D	'04-'07	4,3		●	●	●	●	●	1,9	Getr.Öl SNS-B 75W-80		-			↔	↔			5,3-5,5
Corolla 2.0 D, 1.9 D	'92-'00	5,1-5,3		●	●	●	●	●	2,6	Getr.Öl SNS-B 75W-80		-			↔	↔			7-7,5
Corolla, Corolla Verso 2.0 D4-D	'00-'07	5,9-6,4		●	●	●	●	●	2,5	Getr.Öl SNS-B 75W-80		-			↔	↔			7-7,6

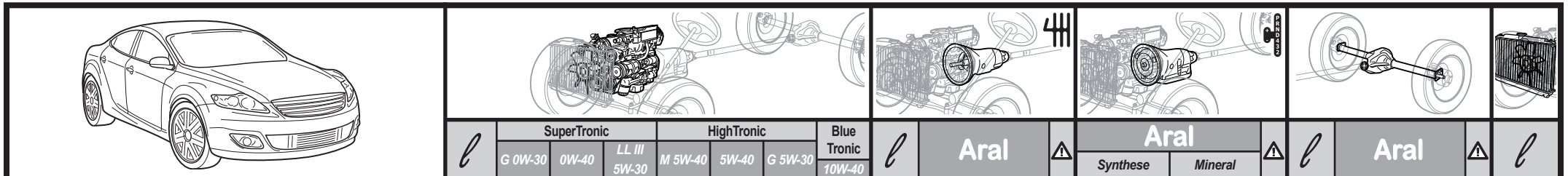

## TOYOTA

		5,9	SuperTronic			HighTronic			Blue Tronic 10W-40	2,3	Aral	⚠	Aral		⚠	Aral	⚠	
			G 0W-30	0W-40	LL III 5W-30	M 5W-40	5W-40	G 5W-30					Synthese	Mineral				
Corolla, Corolla Verso 2.2 D4-D, D-CAT	'05-'07	5,9	●	●			●	●	2,3	Getr.Öl EP Synth 75W-90	-			↔	↔		8-8,2	
Verso 2.0 D-4D-F	'09-	6,3		●			●	●	2,3	Getr.Öl SNS-B 75W-80	-			↔	↔		7,4-7,8	
Verso 2.0 D-4D-F DPF	'09-	6,3		●			●	●	2,3	Getr.Öl SNS-B 75W-80	-			↔	↔		7,4-7,8	
Verso 2.2 D-4D-F	'07-'09	5,9		●			●	●	2,3	Getr.Öl EP Synth 75W-90	-			↔	↔		7,4-7,8	
Verso 2.2 D-4D-F DPF, 2.2 D-4D-CAT	'07-'09	5,9		●			●	●	2,3	Getr.Öl EP Synth 75W-90	-			↔	↔		7,4-7,8	
Verso 2.2 D-4D-CAT	'09-	5,9		●			●	●	2,3	Getr.Öl SNS-B 75W-80	Spezialprodukt			↔	↔		7,4-7,8	
Auris, Corolla 1.4 D4-D	'07-'09	4,3		●			●	●	1,9	Getr.Öl EP Synth 75W-90	-			↔	↔		5,4	
Auris, Corolla 1.4 D-4D-F	'09-	4,1		●			●	●	2,4	Getr.Öl SNS-B 75W-80	-			↔	↔		5,6-6	
Auris, Corolla 2.0 D4-D, 2.2 D-Cat	'07-'09	5,9-6,3		●			●	●	2,3	Getr.Öl EP Synth 75W-90	-			↔	↔		7,4-7,8	
Auris, Corolla 1.4, 2.0, 2.2, D-4D-F DPF	'09-	4,1-6,3		●			●	●	2,3-2,4	Getr.Öl SNS-B 75W-80	j			↔	↔		-	
Auris 1.4, 2.0, D-4D	'13-	3,9-5,9		●			●	●	2,3-2,4	Getr.Öl SNS-B 75W-80		Getr.Öl SNS-B 75W-80		↔	↔		5,6-7,8	
Picnic 2.2 TD	'98-'01	5,1		●			●	●	2,2	Getr.Öl SNS-B 75W-80	Getr.Öl ATF E-S	Getriebeöl ATF 55		↔	↔		7,5-9	
Carina E 2.0 D, TD	'92-'97	5,3		●			●	●	2,6	Getr.Öl SNS-B 75W-80	-			↔	↔		7,5	
Avensis 2.0 TD, D4-D	'97-'02	5,1-6,4		●			●	●	2,2-2,5	Getr.Öl SNS-B 75W-80	-			↔	↔		7	
Avensis, Avensis Verso 2.0 D4-D	'03-'06	5,9	●	●			●	●	2,5	Getr.Öl SNS-B 75W-80	-			↔	↔		7,4-8,8	
Avensis, Avensis Verso 2.0 D4-D-F, 2.2 D4-D, D-CAT	'05-'09	5,9	●	●			●	●	2,3	Getr.Öl EP Synth 75W-90	-			↔	↔		8-8,2	
Avensis 2.0 D4-D-F DPF	'06-'09	5,9		●			●	●	2,3	Getr.Öl EP Synth 75W-90	-			↔	↔		8-8,2	
Avensis 2.0 D-4D-F, 2.2 D-4D, D-CAT	'09-	6,3/5,9		●			●	●	2,3	Getr.Öl SNS-B 75W-80	-			↔	↔		-	
Avensis 2.0 D-4D-F, 2.2 D-4D, D-CAT DPF	'09-	6,3/5,9		●			●	●	2,3	Getr.Öl SNS-B 75W-80	-			↔	↔		-	
Previa 2.0 D4-D	'01-'05	5,7		●			●	●	2,5	Getr.Öl SNS-B 75W-80	-			↔	↔		7	
RAV 4 2.0 D4-D	'01-'06	5,9		●			●	●	2,5	Getr.Öl SNS-B 75W-80	d			↔	↔	f	7	
RAV 4 2.2 D4-D, D-CAT	'06-'09	5,9	●	●			●	●	2,1	Getriebeöl BS 75W-90	d			↔	↔	f	7,3-7,7	
RAV 4 2.2 D4-D-F, D-CAT	'09-	5,9		●			●	●	2,1	Getr.Öl SNS-B 75W-80	-			↔	↔		-	
4Runner 2.4 TD	'89-'96	6,8		●			●	●	3,9	Getr.Öl SNS-B 75W-80	c	Getr.Öl ATF E-S	Getriebeöl ATF 55	e	1,6-2,2	Getriebeöl BS 75W-90	af	9
4Runner 3.0 TD	'96-'03	7		●			●	●	2,2	Getr.Öl SNS-B 75W-80	c	Getr.Öl ATF E-S	Getriebeöl ATF 55	e	1,1/2,5	Getriebeöl BS 75W-90	af	9
Landcruiser 60 3.4 D, 4.0 D	'85-'90	6,7/10,7		●			●	●	4,9	Getr.Öl EP Synth 75W-90	c	Getriebeöl ATF 22			3/2,5	Getriebeöl BS 75W-90	f	13,8-15,4
Landcruiser 70 2.5 TD, 2.8 D	'85-'96	5,7-5,8		●			●	●	2,8-3	Getr.Öl SNS-B 75W-80	d				1,8/2	Getriebeöl BS 75W-90	af	10,9-11,5
Landcruiser 70 3.0 TD, 3.5 TD, 4.2 D	'90-'96	8-9,5		●			●	●	3-4,9	Getr.Öl SNS-B 75W-80	d	Getr.Öl ATF E-S	Getriebeöl ATF 55	d	1,9-2,6	Getriebeöl BS 75W-90	af	10,1-10,5
Landcruiser 80 4.2 D, TD	'89-'98	9,3		●			●	●	2,6-2,7	Getr.Öl SNS-B 75W-80	d	Getr.Öl ATF E-S	Getriebeöl ATF 55	d	2,7-3,3	Getriebeöl BS 75W-90	af	11-12
Landcruiser 90 2.8 D, 3.0 TD	'96-'99	6,7		●			●	●	2,2	Getr.Öl SNS-B 75W-80	d	Getr.Öl ATF E-S	Getriebeöl ATF 55	d	1,1/2,3	Getriebeöl BS 75W-90	af	9,5-11
Landcruiser 90 2.8 D, 3.0 TD	'00-'02	5,3/7		●			●	●	2,2	Getr.Öl SNS-B 75W-80	d	Getr.Öl ATF E-S	Getriebeöl ATF 55	d	1,1/2,3	Getriebeöl BS 75W-90	af	9,5-11
Landcruiser 100 4.2 D, TD, D4-D	'98-'03	9,3/11,4		●			●	●	2,7	Getr.Öl SNS-B 75W-80	d	Getr.Öl ATF E-S	Getriebeöl ATF 55	d	1,6-3,3	Getriebeöl BS 75W-90	af	12-14,1
Landcruiser 100 4.2 D, TD, D4-D	'04-'08	9,3/11,4		●			●	●	2,7	Getr.Öl SNS-B 75W-80	d	Spezialprodukt		d	1,6-3,3	Getriebeöl BS 75W-90	af	12-14,1
Landcruiser 120 3.0 D4-D	'03-'09	7,4		●			●	●	2,2	Getr.Öl SNS-B 75W-80	d	Getr.Öl ATF E-S	Getriebeöl ATF J		1,4-3	Getriebeöl BS 75W-90	af	11-11,3
Landcruiser 150 3.0 D	'09-	6,1	●	●			●	●	2,2	Getr.Öl SNS-B 75W-80	d				1,4-2,75	Getriebeöl BS 75W-90	f	8
Landcruiser 150 3.0 D-4D	'09-	7	●	●			●	●	2,1	Getriebeöl BS 75W-90	d	Spezialprodukt		d	1,4-2,75	Getriebeöl BS 75W-90	f	13,1-15
Landcruiser 150 3.0 D-4D DPF	'09-	7		●			●	●	2,1	Getriebeöl BS 75W-90	d	Spezialprodukt		d	1,4-2,75	Getriebeöl BS 75W-90	f	13,1-15
Landcruiser 200 4.5 V8 D-4D	'08-	9		●			●	●	3	Getr.Öl SNS-B 75W-80	d	Spezialprodukt		d	1,85-4,25	Getriebeöl BS 75W-90	fn	14,8-18

a Sperrdifferential: Getriebeöl BS-LSX 75W-140, Getr.Öl HYP LS 85W-90  
 c Verteilergetriebe: 2,1/3,1 | Getr.Öl EP Synth 75W-90; Getriebeöl EP 85W-90  
 e Verteilergetriebe (Automatikgetriebe): 0,8 | Getr.Öl ATF E-S; Getriebeöl ATF 55  
 g Differential, Modelle mit Automatikgetriebe: 1,4-2 | Getriebeöl BS 75W-90  
 j Transaxle, halbautomatisch: Getr.Öl EP Synth 75W-90; Getriebeöl EP 80W  
 l Differential, vorn: 1,85-1,95 | Getriebeöl BS 75W-90; Getriebeöl HYP Synth 75W-90  
 n Sperrdifferential: Getriebeöl BS-LSX 75W-140, Getr.Öl HYP LS 85W-90

b 6-Ganggetriebe: 1,8 | Spezialprodukt, bitte auf Originalersatzteil des Herstellers zurückgreifen!  
 d Verteilergetriebe: Getriebeöl BS 75W-90; Getriebeöl SNA-C 75W-90  
 f Differentiale, vorn und hinten  
 h Differential, hinten (4WD/4x4): 0,5-1,1 | Getriebeöl BS 75W-90; Getriebeöl HYP Synth 75W-90  
 k CVT (Automat): Spezialprodukt, bitte auf Originalersatzteil des Herstellers zurückgreifen!  
 m Verteilergetriebe: Getriebeöl BS 75W-90; Getriebeöl SNA-C 75W-90

# TVR

Griffith, Griffith 500	'95-'02	6	●					1,4	Getr.Öl ATF E-S	-				2	Getr.Öl BS LSX 75W-140	5
Chimaera 4.0	'92-'00	5	●	●	●			1,4	Getr.Öl ATF E-S	-				2	Getriebeöl BS 75W-90	11
Cerbera 4.0, 4.2, 4.5	'94-'05	6,5-7							Spezialprodukt, bitte auf Originalersatzteil des Herstellers zurückgreifen!					1,65	Getr.Öl BS LSX 75W-140	-

# VOLKSWAGEN

Lupo 1.0, 1.4, 1.4 16V (55 kW)	'98-'05	3,2	●	●	●			2,4-2,7	Getr.Öl EP Synth 75W-90	Getr.Öl ATF E-S			↔	↔		5,5
Lupo 1.4 16V (74 kW), 1.4 FSI	'98-'05	3,2	●	●	●			2,1-2,7	Getr.Öl EP Synth 75W-90	-			↔	↔		5,5-6
Lupo 1.6 GTI	'02-'05	3,2	●	●	●			2,1	Getr.Öl EP Synth 75W-90	-			↔	↔		6
Fox 1.0, 1.2, 1.4, 1.6	'05-'07	3-4	●	●	●			2	Getr.Öl EP Synth 75W-90	-			↔	↔		5,6
Fox 1.0, 1.2, 1.4, 1.6	'07-'11	3-4	●	●	●			2	Getr.Öl EP Synth 75W-90	-			↔	↔		5,6
Polo 1.0, 1.4, 1.4 16V, 1.6, 1.6 16V	'94-'01	3,2-4,5		●	●			2,7/3,1	Getr.Öl EP Synth 75W-90	Getr.Öl ATF E-S			↔	↔		5,5-6
Polo 1.2 (12V), 1.4 16V, 1.4 FSI	'01-'06	3-3,5	●	●	●			2	Getr.Öl EP Synth 75W-90	Getr.Öl ATF E-S			↔	↔		3,9-5,6
Polo 1.2, 1.2 (12V)	'07-'09	2,4-2,8	●	●	●			2	Getr.Öl EP Synth 75W-90	-			↔	↔		5,6
Polo 1.4 16V, 1.6 16V	'06-'09	3,2-3,6	●	●	●			2	Getr.Öl EP Synth 75W-90	Getr.Öl ATF E-S			↔	↔		5,6-6
Polo GTi 1.8 Turbo	'05-'09	4,5	●	●	●			1,9	Getr.Öl EP Synth 75W-90	-			↔	↔		5
Polo V 1.2, 1.2 12V	'09-	2,8-3,2	●	●	●			2,1	Getr.Öl EP Synth 75W-90	-			↔	↔		-
Polo V 1.2 TSI, 1.4 16V	'09-	2,8-3,2	●	●	●			2,1	Spezialprodukt	Spezialprodukt			↔	↔		-
Golf III, Vento 1.4, 1.6, 1.8	'91-'99	3,4-4,3		●	●		●	1,7-3,1	Getr.Öl EP Synth 75W-90	Getriebeöl ATF-LD			↔	↔	e	5,5-6,5
Golf III, Vento 2.0, 2.0 16V	'91-'98	3,8-4,3		●	●		●	1,9-2,2	Getr.Öl EP Synth 75W-90	-			↔	↔		6,5
Golf III 1.8i Syncro	'93-'97	3,8		●	●		●	2,4	Getr.Öl EP Synth 75W-90	-			↔	↔	f	6,5
Golf III, Vento VR6 - 2.8	'91-'97	5,5-6		●	●		●	2	Getr.Öl EP Synth 75W-90	Getriebeöl ATF-LD			↔	↔	e	8/8,5
Golf III VR6 Syncro 2.9	'94-'97	5,5-6		●	●		●	2,4	Getr.Öl EP Synth 75W-90	-		0,7	↔	↔		10
Golf IV, Bora 1.4, 1.6, 1.8 20V (Turbo), 2.0	'97-'00	3,2-4,5		●	●		●	1,9-2	Getr.Öl EP Synth 75W-90	Getriebeöl ATF-LD			↔	↔	d	5-6
Golf IV, Bora 1.4, 1.6, 1.8 20V (Turbo 110kW), 2.0	'00-'04	3,3-4,5	●	●	●			1,9-2,4	Getr.Öl EP Synth 75W-90	Getriebeöl ATF-LD			↔	↔	d	5-6
Golf IV, Bora 1.6 FSI	'02-'04	3,5	●	●	●			2	Getr.Öl EP Synth 75W-90	-			↔	↔		6
Golf IV, Bora 2.3 V5	'97-'01	3,9		●	●			2	Getr.Öl EP Synth 75W-90	Getriebeöl ATF-LD			↔	↔	d	5-8,5
Golf IV, Bora 2.3 V5	'01-'04	4,5	●	●	●			2	Getr.Öl EP Synth 75W-90	Getr.Öl ATF E-S			↔	↔		8,5
Golf IV, Bora 1.8 20V Turbo (132kW), 2.8 V6 4Motion	'01-'04	4,5-5,5		●	●		●	2,3	Spezialprodukt	h -			1	↔	↔	8,5-11
Golf IV R32	'03-'04	5,5	●	●	●			2,6	Spezialprodukt	h -			1	↔	↔	9,2
Golf V, Golf Plus, CrossGolf, Jetta 1.4 (FSI), 1.4 16V (59kW), 1.6	'04-'11	3,2-4,5	●	●	●			2	Getr.Öl EP Synth 75W-90	Spezialprodukt	n		↔	↔		5,6-8
Golf V, Golf Plus, CrossGolf, Jetta 1.4 16V TSI	'04-'11	3,6	●	●	●			2-2,1	Spezialprodukt	Spezialprodukt	n		↔	↔		5,6
Golf V, Eos 1.4 16V TSI	'08-	3,6	●	●	●			2	Spezialprodukt	-			↔	↔		5,6
Golf V, Golf Plus, Jetta, Eos 1.6 FSI	'04-'08	3,5	●	●	●			2	Spezialprodukt	Spezialprodukt			↔	↔		5,6-8
Golf V, Golf Plus, Jetta, Eos 2.0 FSI, Turbo, 4Motion	'04-'08	4,6	●	●	●			2,1-2,3	Spezialprodukt	a -	o		↔	↔	b	5,6-8
Jetta 2.5	'05-	6	●	●	●			1,9	Getr.Öl EP Synth 75W-90	Spezialprodukt			↔	↔		-
Golf V R32, Eos 3.2 V6	'05-'08	5,5	●	●	●			2,3	Spezialprodukt	a -			↔	↔	b	9
Eos 3.6 V6	'09-	5,5	●	●	●			-	Spezialprodukt	Spezialprodukt			↔	↔		9
Golf VI, Jetta 1.2 TSI	'09-	-	●	●	●			2	Spezialprodukt	Spezialprodukt			↔	↔		-
Golf VI 1.4 16V, 1.6	'08-	-	●	●	●			2	Getr.Öl EP Synth 75W-90	Spezialprodukt			↔	↔		-
Golf VI, Jetta, Scirocco 1.4 TSI, 1.8 TSI	'08-	3,6-4,5	●	●	●			2-2,1	Spezialprodukt	Spezialprodukt			↔	↔		-
Golf VI, Jetta 2.5	'09-	6	●	●	●			1,9	Getr.Öl EP Synth 75W-90	Spezialprodukt			↔	↔		-
Golf VI, Jetta, Scirocco 2.0 TSI	'08-	-	●	●	●			2,3	Spezialprodukt	Spezialprodukt			↔	↔		-
Golf VI, Scirocco 2.0 TSI R, 4MOTION	'09-	-	●	●	●			2,3	Spezialprodukt	a -		0,95	↔	↔		-
Golf VII 1.2 TSI (66kW, 77kW)	'12-	-	●	●	●			-	Getr.Öl EP Synth 75W-90	p -			↔	↔		-
Golf VII 1.4 TSI (90kW)	'12-	-	●	●	●			-	Spezialprodukt	Spezialprodukt			↔	↔		-
Golf VII 1.4 TSI (103 kW)	'12-	-	●	●	●			-	Getr.Öl EP Synth 75W-90	Spezialprodukt			↔	↔		-
New Beetle 1.4 16V, 1.6, 2.0, 1.8 Turbo	'97-'10	3,5-4,5	●	●	●			1,9-2	Getr.Öl EP Synth 75W-90	Getriebeöl ATF-LD			↔	↔	d	5-6
New Beetle 2.3 V5	'00-'10	4,5	●	●	●			2	Getr.Öl EP Synth 75W-90	-			↔	↔		8,5
Touran 1.4 TSI (90kW, 103kW, 125kW)	'06-	3,6	●	●	●			2,1	Spezialprodukt	Spezialprodukt	n		↔	↔		5,6
Touran 1.6 FSI	'03-'06	3,5-4,5	●	●	●			2-2,1	Getr.Öl EP Synth 75W-90	Spezialprodukt			↔	↔		5,6-8
Touran 2.0 FSI	'03-'06	4,6	●	●	●			2,1	Spezialprodukt	Spezialprodukt			↔	↔		8
Passat 1.6, 1.8 20V (Turbo)	'96-'00	3,0-3,8		●	●		●	2,3	Getr.Öl EP Synth 75W-90	Getriebeöl ATF-LD			↔	↔	d	7
Passat 1.6, 1.8 20V Turbo, 2.0 4Motion	'00-'05	3,5-4	●	●	●			2,3-2,8	Getr.Öl EP Synth 75W-90	Getriebeöl ATF-LD			↔	↔	bd	5,5-7
Passat 2.3 VR5, 2.8 VR6, Syncro	'96-'00	3,7/6		●	●			2,3-2,8	Getr.Öl EP Synth 75W-90	Getriebeöl ATF-LD	k		↔	↔	dg	9
Passat 2.3 V5, 2.8 V6, 4Motion	'00-'05	4/5,5	●	●	●			2,3-2,8	Getr.Öl EP Synth 75W-90	Getriebeöl ATF-LD	k		↔	↔	dg	9
Passat W8	'01-'05	8,3		●	●			2,3	Getr.Öl EP Synth 75W-90	k -	k	1,5	↔	↔		8
Passat 1.6	'05-'10	3,8	●	●	●			1,9	Spezialprodukt	Spezialprodukt			↔	↔		8
Passat, Passat CC 1.4 16V TSI, 1.6 FSI, 1.8 16V TFSI, 2.0 16V TFSI	'08-	3,6-4,7	●	●	●			2-2,1	Spezialprodukt	Spezialprodukt	n		↔	↔		5,6

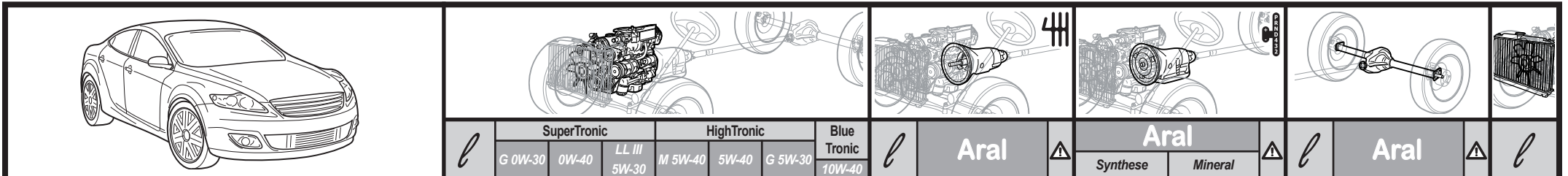

VOLKSWAGEN			SuperTronic			HighTronic			Blue Tronic	Aral	⚠	Aral		⚠	Aral	⚠	
			G 0W-30	0W-40	LL III 5W-30	M 5W-40	5W-40	G 5W-30	10W-40			Synthese	Mineral				
Passat 2.0 FSI (Turbo), 4Motion	'05-'10	4,6	●		●	●			2,1-2,3	Spezialprodukt	a	Spezialprodukt		↔	↔	b	8
Passat 3.2 V6 FSI 4Motion	'05-'10	5,5	●		●	●			-	-		Spezialprodukt	a	1	Getriebeöl BS 75W-90		9
Passat, Passat CC 3.2 V6 FSI, 3.6 V6 FSI 4Motion (R36)	'08-	5,5	●		●	●			-	-		Spezialprodukt		0,5-1	Getriebeöl BS 75W-90	l	9
Phaeton 3.2 V6, 4.2 V8	'02-	6-7,5	●		●	●			2,2	Getr.Öl EP Synth 75W-90	k	Spezialprodukt	jk	0,8-1,1	Getriebeöl BS 75W-90		9
Phaeton 6.0 W12	'02-	11,8	●		●	●			-	-		Spezialprodukt	k	-	Getriebeöl BS 75W-90	c	17
Sharan 1.8 20V Turbo, 2.0	'95-'00	3,5-4,5	●		●	●		●	2	Getriebeöl ATF-LD		Getriebeöl ATF-LD		↔	↔	d	6,5-8
Sharan 1.8 20V Turbo, 2.0, 2.8 VR6, 4Motion	'00-'10	4-5,7	●		●	●			2,3-2,8	Spezialprodukt		Getriebeöl ATF-LD		↔	↔	df	6,5-11
Sharan 2.8 VR6, Syncro	'95-'00	5,5	●		●	●			2	Getriebeöl ATF-LD		Getriebeöl ATF-LD		↔	↔	dg	9-11,5
Sharan 1.4 TSI, 2.0 TSI	'10-	3,6	●		●	●			2,3	Spezialprodukt		Spezialprodukt		↔	↔		-
Tiguan 1.4 TSI, 2.0 TSI	'08-	-	●		●	●			2,3	Spezialprodukt	a	Spezialprodukt		↔	↔	b	-
Touareg 3.2 V6, 3.6 V6, 4.2 V8	'03-'10	6,6-7,5	●		●	●			1,8	Spezialprodukt		Spezialprodukt	k	1	Getriebeöl BS 75W-90	c	9
Touareg 6.0 W12	'03-'10	14	●		●	●			-	-		Spezialprodukt	k	1	Getriebeöl BS 75W-90	c	10
Touareg 3.0 V6 TSI Hybrid, 3.6 V6 FSI	'10-	-	●		●	●			-	-		Spezialprodukt	rs	-	Getriebeöl BS 75W-90	q	-
Multivan 2.0	'03-'09	4			●	●			2	Getr.Öl EP Synth 75W-90		-		↔	↔		7,1
Multivan 2.0	'09-	4	●		●	●			2,2	Getr.Öl EP Synth 75W-90		-		↔	↔		-
Multivan 3.2 V6, 4Motion	'04-'09	6,1			●	●			2,7	Spezialprodukt	l	Spezialprodukt		↔	↔	b	7,1
<b>Diesel</b>																	
Lupo 3L 1.2 TDi	'99-'05	3,8			●	●			2,7	Spezialprodukt		-		↔	↔		6,5
Lupo 1.4 TDi (P-D)	'98-'05	3,8			●	●	●		1,9	Spezialprodukt		-		↔	↔		5
Lupo 1.7 SDi	'98-'05	4,7	●		●	●		●	2,7	Spezialprodukt		-		↔	↔		6,5
Fox 1.4 TDi (P-D)	'05-'11	3,8			●	●			2	Getr.Öl EP Synth 75W-90		-		↔	↔		5
Polo 1.3, 1.4, 1.9 Diesel	'86-'01	3,5/5			●	●			2,7/3,1	Getr.Öl EP Synth 75W-90		-		↔	↔		5,5-7
Polo 1.7, 1.9 SDi, 1.9 TDi	'96-'01	4,3-5	●		●	●		●	2,7	Getr.Öl EP Synth 75W-90		-		↔	↔		5,5-6,5
Polo 1.9 SDi	'02-'05	4,3			●	●			2	Getr.Öl EP Synth 75W-90		-		↔	↔		6
Polo 1.4 TDi, 1.9 TDi (P-D)	'99-'05	3,8-4,5			●	●			2	Getr.Öl EP Synth 75W-90		-		↔	↔		3,8-6
Polo 1.4 TDi (51 kW)	'05-'09	3,8			●	●			2	Getr.Öl EP Synth 75W-90		-		↔	↔		5
Polo 1.4 TDi (59 kW), 1.9 TDi (74 kW)	'05-'09	3,8-4,3			●	●			1,9	Getr.Öl EP Synth 75W-90		-		↔	↔		5
Polo 1.9 TDi (96 kW)	'05-'09	4,3			●	●			2,3	Spezialprodukt		-		↔	↔		5
Polo V 1.2 TDi, 1.6 TDi	'09-	-			●	●			1,9	Getr.Öl EP Synth 75W-90		Spezialprodukt		↔	↔		-
Golf III, Vento 1.9 Diesel, SDi	'91-'99	4,3-4,5			●	●			1,5-3,1	Getr.Öl EP Synth 75W-90		-		↔	↔		6,5
Golf III/IV, Vento, Bora 1.9 TD, TDi	'91-'00	4,5	●		●	●		●	1,9-3,1	Getr.Öl EP Synth 75W-90		Getriebeöl ATF-LD		↔	↔	e	6-6,5
Golf III 1.9 TDi Syncro	'94-'97	4,3			●	●		●	2,4	Getr.Öl EP Synth 75W-90		-		0,7	Getriebeöl BS 75W-90		6,5
Golf IV, Bora 1.9 TDi, 4Motion	'00-'04	4,5			●	●			2-2,4	Getr.Öl EP Synth 75W-90	h	Getriebeöl ATF-LD		↔	↔	df	6
Golf IV, Bora 1.9 TDi (P-D) (85 kW), 4Motion	'00-'04	4,5			●	●			2-2,4	Spezialprodukt	h	Getriebeöl ATF-LD		↔	↔	df	6
Golf IV, Bora 1.9 TDi (P-D) (74, 96, 110 kW), 4Motion	'00-'04	4,5			●	●			2,3-2,6	Spezialprodukt	h	Getr.Öl ATF E-S		↔	↔	df	6
Golf V, Golf Plus, CrossGolf, Jetta 1.9 TDi (P-D), 2.0 SDi (P-D)	'03-'09	4,3			●	●			1,9	Getr.Öl EP Synth 75W-90	p	Spezialprodukt	n	↔	↔		8
Golf V 1.9 TDi (P-D) 4Motion	'03-'09	4,3			●	●			2,3	Spezialprodukt	a	-		↔	↔	f	8
Golf V, Golf Plus, Jetta 1.9 TDi (P-D) DPF	'06-'09	4,3			●	●			1,9	Getr.Öl EP Synth 75W-90	p	Spezialprodukt	n	↔	↔		8
Golf V 1.9 TDi (P-D) DPF 4Motion	'06-'09	4,3			●	●			1,9	Spezialprodukt	a	-		↔	↔	f	8
Golf V, Golf Plus, Jetta 2.0 TDi (P-D), 4Motion	'03-'09	3,8			●	●			2,3	Spezialprodukt	a	Spezialprodukt		↔	↔	f	8
Golf V, Golf Plus, CrossGolf, Jetta, Eos 2.0 TDi (P-D) DPF(103kW, 125kW), 4Motion	'05-	3,8-4,3			●	●			2,3	Spezialprodukt	a	Spezialprodukt		↔	↔	f	8
Golf VI, Golf Plus, Jetta 1.6 TDi, 2.0 TDi (81 kW)	'08-	-			●	●			1,9	Getr.Öl EP Synth 75W-90		Spezialprodukt		↔	↔		-
Golf VI, Jetta, Scirocco 2.0 TDi, 4Motion	'08-	4-4,3			●	●			2,3	Spezialprodukt	a	Spezialprodukt		0,95	Getriebeöl BS 75W-90		-
Golf VII 1.6 TDi (66kW, 77kW, 81kW)	'12-	-			●	●			-	Getr.Öl EP Synth 75W-90		Spezialprodukt		↔	↔		-
Golf VII 1.6 TDi 4Motion (77kW, 81kW)	'12-	-			●	●			-	Spezialprodukt	v	-		-	Getriebeöl BS 75W-90	v	-
Golf VII 2.0 TDi, 4Motion	'12-	-			●	●			-	Spezialprodukt	v	Spezialprodukt		-	Getriebeöl BS 75W-90	v	-
Touran 1.9, 2.0 TDi (P-D)	'03-'06	3,8-4,3			●	●			2,1	Spezialprodukt		Spezialprodukt		↔	↔		8

Touran 1.9, 2.0 TDi (P-D) DPF	'03-	3,8-4,3						1,9-2,3	Spezialprodukt		Spezialprodukt						8
New Beetle 1.9 TDi	'97-'00	4,5	●					2	Getr.Öl EP Synth 75W-90		Getriebeöl ATF-LD					d	6
New Beetle 1.9 TDi	'00-'05	4,5						2	Getr.Öl EP Synth 75W-90		Getriebeöl ATF-LD					d	6
New Beetle 1.9 TDi (P-D)	'00-'05	4,5						2	Spezialprodukt		-						6
New Beetle 1.9 TDi (P-D)	'05-'10	4,3						1,9	Getr.Öl EP Synth 75W-90		-						6
Passat 1.6 TDi, 2.0 TDi (81 kW)	'09-	-						1,9	Getr.Öl EP Synth 75W-90		-						-
Passat 1.9 TDi, 4Motion	'96-'00	3,8-4,3	●					2-2,8	Getr.Öl EP Synth 75W-90		Getriebeöl ATF-LD					dg	7,5
Passat 1.9 TDi (P-D)	'98-'00	3,6						2,4	Getr.Öl EP Synth 75W-90		Getriebeöl ATF-LD					d	7
Passat 1.9 TDi (P-D) 4Motion	'98-'00	3,6						2,8	Getr.Öl EP Synth 75W-90		-					dg	7
Passat 1.9 TDi (P-D)	'00-'05	3,6						2,3	Getr.Öl EP Synth 75W-90		Getriebeöl ATF-LD					d	7
Passat 2.5 V6 TDi, 4Motion	'99-'00	6,5	●					2,4-2,7	Getr.Öl EP Synth 75W-90		Getriebeöl ATF-LD		k			dg	10
Passat 2.5 V6 TDi, 4Motion	'00-'05	6,5						2,4-2,7	Getr.Öl EP Synth 75W-90		Getriebeöl ATF-LD		k			dg	10
Passat 1.9 TDi (P-D)	'05-'08	3,8						1,9	Getr.Öl EP Synth 75W-90		-						8
Passat 1.9 TDi (P-D) DPF	'05-'08	4,3						1,9	Getr.Öl EP Synth 75W-90		-						8
Passat 2.0 TDi (P-D), 4Motion	'05-'08	4						2,3	Spezialprodukt	a	Spezialprodukt					b	8
Passat, Passat CC 2.0 TDi (P-D) DPF, 4Motion	'08-	4						2,3	Spezialprodukt	a	Spezialprodukt					b	8
Phaeton V10 TDi	'03-'07	10						-	-		Spezialprodukt		k	0,9	Getriebeöl BS 75W-90	c	13
Sharan 1.9 TDi	'95-'00	4,3						2-2,3	Getriebeöl ATF-LD		-						6,5-9
Sharan 1.9 TDi (P-D), 4Motion	'00-'08	4,3-4,5						2,3-2,8	Getr.Öl EP Synth 75W-90	h	Getriebeöl ATF-LD					df	6,8-9,2
Sharan 2.0 TDi (P-D)	'05-'10	4						2,3	Spezialprodukt		-						6,8-9,2
Sharan 2.0 TDi DPF (P-D)	'05-'10	4						2,3	Spezialprodukt		-						6,8-9,2
Sharan 2.0 TDi	'10-	4,3						2,3	Spezialprodukt		Spezialprodukt						-
Tiguan 2.0 TDi 100 kW, 103 kW, 125 kW	'08-	-						2,3	Spezialprodukt	a	Spezialprodukt		a			b	-
Touareg 2.5 TDi, 5.0 V10 TDi	'03-'07	8,9-11,5						1,8	Spezialprodukt	k	Spezialprodukt		k	1	Getriebeöl BS 75W-90	c	9-13
Touareg 2.5 TDi DPF, 5.0 V10 TDi DPF	'07-'10	8,9-11,5						1,8	Spezialprodukt	k	Spezialprodukt		k	1	Getriebeöl BS 75W-90	c	9-13
Touareg 3.0 V6 TDi DPF	'05-'10	8,3						1,8	Spezialprodukt	k	Spezialprodukt		k	1	Getriebeöl BS 75W-90	c	9
Touareg 4.2 V8 TDi	'10-	-						-	-		Spezialprodukt		rs	-	Getriebeöl BS 75W-90	q	-
Multivan 1.9 TDi	'03-'09	5,8						2	Getr.Öl EP Synth 75W-90		-						7,1
Multivan 2.5 TDi, 4Motion	'03-'06	7,4						2,7	Spezialprodukt	l	-					b	7,1
Multivan 2.5 TDi, 4Motion DPF	'06-'09	7,4						2,7	Spezialprodukt	l	-					b	7,1
Multivan 2.0 TDi 62 kW, 75 kW	'09-	-						2,2	Getr.Öl EP Synth 75W-90		-						-
Multivan 2.0 TDi 103 kW, 132 kW, 4Motion	'09-	-						2,7	Spezialprodukt	l	Spezialprodukt			1,2	Getriebeöl BS 75W-90		-

- a Haldex-Kupplung (4Motion): Spezialprodukt, bitte auf Originalersatzteil des Herstellers zurückgreifen!
- c Differentiale, vorn und hinten
- e Differential, Modelle mit Automatikgetriebe: 0,8/1 | Getriebeöl BS 75W-90
- g Differential, hinten (Synco, 4Motion): Getriebeöl BS 75W-90; Getriebeöl HYP Synth 75W-90
- j 5-Gang Automatikgetriebe: Getriebeöl ATF-LD
- l Haldex-Kupplung (4Motion): 1 | Spezialprodukt, bitte auf Originalersatzteil des Herstellers zurückgreifen!
- o Getriebe, Automatik DSG 6-Gang (02E): Spezialprodukt, bitte auf Originalersatzteil des Herstellers zurückgreifen!
- q Hinterachsgetriebe, Ausgleichgetriebe mit begrenztem Schlupf: Spezialprodukt, bitte auf Originalersatzteil des Herstellers zurückgreifen!
- s Verteilergetriebe, Sperrdifferential: Spezialprodukt, bitte auf Originalersatzteil des Herstellers zurückgreifen!

- b Differential, hinten (4Motion): Getriebeöl BS 75W-90
- d Differential, Modelle mit Automatikgetriebe: 0,8/1 | Getriebeöl BS 75W-90
- f Differential, hinten (Synco, 4Motion): Getriebeöl BS 75W-90
- h Haldex-Kupplung (4Motion): 0,25 | Spezialprodukt, bitte auf Originalersatzteil des Herstellers zurückgreifen!
- k Verteilergetriebe: Getriebeöl BS 75W-90
- n Getriebe, Automatik DSG 7-Gang (0AM): Spezialprodukt, bitte auf Originalersatzteil des Herstellers zurückgreifen!
- p Schaltgetriebe, 6-Gang: Spezialprodukt, bitte auf Originalersatzteil des Herstellers zurückgreifen!
- r Verteilergetriebe: Getriebeöl ATF-LD

Achtung: Alle Fahrzeuge mit LongLife-Service: Aral SuperTronic LongLife III 5W-30 verwenden!

## VOLVO

C30 1.6	'06-'09	4						2,3	Getr.Öl SNS-B 75W-80		-						6,2
C30 1.6	'09-	4						2,1	Spezialprodukt		-						6,2
C30 1.8, 1.8F	'06-'09	4,3						1,9	Spezialprodukt		-						7,5
C30 2.0, 2.0F	'06-	4,3						1,9	Spezialprodukt		-						6,5
C30 2.4i	'06-'08	5,8						2,1	Getr.Öl SNS-B 75W-80		Getriebeöl ATF 55	Getriebeöl ATF J					-
C30 2.4i	'08-	5,8						2,1	Getr.Öl SNS-B 75W-80		Getriebeöl ATF 55	Getriebeöl ATF J					-
C30 T5	'06-'07	5,8						2	Getr.Öl SNS-B 75W-80		Getriebeöl ATF 55	Getriebeöl ATF J					-
C30 T5	'07-	5,5						2	Spezialprodukt		-						-
S40, V40 1.6	'97-'04	4						3,4	Getr.Öl SNS-B 75W-80		-						5-6,5
S40, V40 1.8i (Direct inj.)	'98-'04	3,8						2,2	Getr.Öl SNS-A 75W-85		-						5-6
S40, V40 1.8, Bi-Fuel, 2.0	'95-'04	5,4-5,6						3,4	Getr.Öl SNS-B 75W-80		Getr.Öl ATF E-S	Getriebeöl ATF 55					6,5
S40, V40 2.0 T, T4	'97-'04	4,3						2,1	Getr.Öl SNS-B 75W-80		-						5-6
S40, V50 1.6, 1.8, 1.8 Flexifuel	'04-'10	4-4,3						1,9-2,1	Getr.Öl SNS-B 75W-80		-						6,2-7,5

		SuperTronic						HighTronic			Blue Tronic	Aral		Aral		Aral		
		G 0W-30	0W-40	LL III 5W-30	M 5W-40	5W-40	G 5W-30	10W-40		Synthese	Mineral							
<b>VOLVO</b>																		
S40, V50 1.6	'09-	4	SuperTronic E 0W-30; HighTronic F 5W-30						2,1	Spezialprodukt	-						6,2	
S40, V50 2.0, 2.0F	'06-	4,3	SuperTronic E 0W-30; HighTronic F 5W-30						1,9	Spezialprodukt	Spezialprodukt						6,5	
S40, V50 2.4, 2.4i	'04-'08	5,5-5,8	SuperTronic E 0W-30; HighTronic F 5W-30						2,1	Getr.Öl SNS-B 75W-80	Getriebeöl ATF 55	Getriebeöl ATF J					8-8,5	
S40, V50 2.4, 2.4i	'08-'10	5,5	SuperTronic E 0W-30; HighTronic F 5W-30						2,1	Getr.Öl SNS-B 75W-80	Getriebeöl ATF 55	Getriebeöl ATF J					8-8,5	
S40, V50 T5, AWD	'04-'07	5,5-5,8	SuperTronic E 0W-30; HighTronic F 5W-30						2,1	Getr.Öl SNS-B 75W-80	h Getriebeöl ATF 55	Getriebeöl ATF J	h Getriebeöl ATF J			d	8-8,5	
S40, V50 T5, AWD	'07-	5,5	SuperTronic E 0W-30; HighTronic F 5W-30						2	Spezialprodukt	h Getriebeöl ATF 55	Getriebeöl ATF J	h Getriebeöl ATF J			d	9,5-10	
S60, V70 2.0 T, 2.4, 2.4 T	'00-'05	5,5-5,8	●	●	●				2,1	Getr.Öl SNS-B 75W-80	Getriebeöl ATF 55	Getriebeöl ATF J					8-8,8	
S60, V70 2.0 T, 2.4	'05-'10	5,5-5,8	SuperTronic E 0W-30; HighTronic F 5W-30						2,1	Getr.Öl SNS-B 75W-80	Getriebeöl ATF 55	Getriebeöl ATF J					8-8,8	
S60, V70 2.4 Bi-Fuel	'00-'07	5,8	●	●	●				2,1	Getr.Öl SNS-B 75W-80	Getriebeöl ATF 55	Getriebeöl ATF J					8,8	
S60, V70 2.4 T AWD, 2.5 T, AWD	'00-'05	5,5-5,8	●	●	●				2,1	Getr.Öl SNS-B 75W-80	gh Getriebeöl ATF 55	Getriebeöl ATF J	gh Getriebeöl ATF J			d	-	
S60, V70 2.5 T, AWD	'05-'10	5,5-5,8	SuperTronic E 0W-30; HighTronic F 5W-30						2,1	Getr.Öl SNS-B 75W-80	gh Getriebeöl ATF 55	Getriebeöl ATF J	gh Getriebeöl ATF J			d	-	
S60, V60 T3, T4	'10-	4	SuperTronic E 0W-30; HighTronic F 5W-30						1,7	Spezialprodukt	Spezialprodukt						5,8	
S60, V60 2.0T, T5	'10-	5,4	SuperTronic E 0W-30; HighTronic F 5W-30						1,7	Spezialprodukt	Spezialprodukt						10,5	
S60, V60 T6 AWD	'10-	6,8	SuperTronic E 0W-30; HighTronic F 5W-30						-	-		Getriebeöl ATF J	0,7	Getriebeöl BS 75W-90			8,9	
V70 T6, 3.2, AWD	'07-'10	7,4-7,7	SuperTronic E 0W-30; HighTronic F 5W-30						-	-		Getriebeöl ATF 55	h Getriebeöl ATF J	0,7	Getriebeöl BS 75W-90	d	8,9	
S60, V70 T5	'00-'04	5,8	●	●	●				2,1	Getr.Öl SNS-B 75W-80	Getr.Öl ATF E-S	Getriebeöl ATF 55					8	
S60, V70 T5	'04-'07	5,8	SuperTronic E 0W-30; HighTronic F 5W-30						2,1	Getr.Öl SNS-B 75W-80	Getr.Öl ATF E-S	Getriebeöl ATF 55					8	
S60, V70 R AWD	'03-'08	5,5	●	●	●				2,1	Getr.Öl SNS-B 75W-80	gh Getriebeöl ATF 55	Getriebeöl ATF J	gh Getriebeöl ATF J			d	8	
XC60 2.0T, T5	'10-	5,4	SuperTronic E 0W-30; HighTronic F 5W-30						1,7	Spezialprodukt	Spezialprodukt						10,5	
XC60 3.2, AWD, T6 AWD	'08-	7,4	SuperTronic E 0W-30; HighTronic F 5W-30						-	-		Getriebeöl ATF J	ck	-	Getriebeöl BS 75W-90		8,9	
V70 T4	'10-	4	SuperTronic E 0W-30; HighTronic F 5W-30						1,7	Spezialprodukt	Spezialprodukt						5,8	
V70 2.0T, T5	'10-	5,4	SuperTronic E 0W-30; HighTronic F 5W-30						1,7	Spezialprodukt	Spezialprodukt						10,5	
V70 T6, 3.2, AWD	'10-	6,8	SuperTronic E 0W-30; HighTronic F 5W-30						-	-		Getriebeöl ATF J	h	0,7	Getriebeöl BS 75W-90		8,9	
S70, V70 2.0, 2.4, 2.5, 20V	'96-'00	5,8			●			●	2,1	Getr.Öl SNS-B 75W-80	Getr.Öl ATF E-S	Getriebeöl ATF 55					7/7,5	
S70, V70 2.0 T, 2.4 T, 2.5 T, AWD	'96-'00	5,8		●		●		●	2,1	Getr.Öl SNS-B 75W-80	g Getr.Öl ATF E-S	Getriebeöl ATF 55	g			f	7/7,5	
S70, V70 T5, R	'96-'00	6,2						●	2,1	Getr.Öl SNS-B 75W-80	Getr.Öl ATF E-S	Getriebeöl ATF 55					7	
C70 2.0 T, 2.4 T, 2.5 T, T5	'96-'05	5,8	SuperTronic E 0W-30; HighTronic F 5W-30						2,1	Getr.Öl SNS-B 75W-80	Getr.Öl ATF E-S	Getriebeöl ATF 55					7	
V70 Cross Country 2.4 T	'00-'02	5,8	●	●	●				2,1	Getr.Öl SNS-B 75W-80	h Getriebeöl ATF 55	Getriebeöl ATF J	h Getriebeöl ATF J			d	7	
C70 2.4, 2.4i	'05-'08	5,8	SuperTronic E 0W-30; HighTronic F 5W-30						2,1	Getr.Öl SNS-B 75W-80	Getriebeöl ATF 55	Getriebeöl ATF J					-	
C70 2.4, 2.4i	'08-'10	5,5	SuperTronic E 0W-30; HighTronic F 5W-30						2,1	Getr.Öl SNS-B 75W-80	Getriebeöl ATF 55	Getriebeöl ATF J					-	
C70 T5	'05-'09	5,8	SuperTronic E 0W-30; HighTronic F 5W-30						2	Getr.Öl SNS-B 75W-80	Getriebeöl ATF 55	Getriebeöl ATF J					-	
C70 T5	'09-	5,5	SuperTronic E 0W-30; HighTronic F 5W-30						2	Spezialprodukt		Getriebeöl ATF J					-	
940, 960, Polar	'90-'98	3,9		●		●		●	1,6/2,3	Spezialprodukt	Getr.Öl ATF E-S	Getriebeöl ATF 55	1,6	Getriebeöl BS 75W-90	e		9,5	
940 I.C., Turbo, 960 Turbo	'90-'98	3,9		●		●		●	1,6/2,3	Spezialprodukt	a Getr.Öl ATF E-S	Getriebeöl ATF 55	1,6	Getriebeöl BS 75W-90	e		9,5	
960 2.5	'90-'98	5,8		●		●		●	1,8	Getr.Öl SNS-B 75W-80	Getr.Öl ATF E-S	Getriebeöl ATF 55	1,3-1,6	Getriebeöl BS 75W-90	e		9,5	
S80 2.0, 2.0 Flexifuel	'07-'11	4,3	SuperTronic E 0W-30; HighTronic F 5W-30						1,9	Getr.Öl SNS-B 75W-80	-						7,8	
S80 2.4, Bi-Fuel	'99-'06	5,8-6	●	●	●				2,1	Getr.Öl SNS-B 75W-80	Getriebeöl ATF 55	Getriebeöl ATF J					8	
S80 2.0 T, T5, T6	'98-'00	5,5-6	●	●	●				2,1	Getr.Öl SNS-B 75W-80	Getr.Öl ATF E-S	Getriebeöl ATF 55	b				8,8-9,6	
S80 2.0 T, 2.4 T, 2.5 T, AWD	'00-'06	5,5-6	●	●	●				2	Getr.Öl SNS-B 75W-80	Getriebeöl ATF 55	Getriebeöl ATF J	hb			d	8,8-9,6	
S80 2.9	'98-'01	6	●	●	●				2,1	Getr.Öl SNS-B 75W-80	Getr.Öl ATF E-S	Getriebeöl ATF 55					8,8	
S80 2.9, T6	'01-'06	6-6,9	●	●	●				2	Getr.Öl SNS-B 75W-80	Getr.Öl ATF E-S	Getriebeöl ATF 55					8,8-9,6	
S80 T4, T4F, T5	'10-	4-5,4	SuperTronic E 0W-30; HighTronic F 5W-30						1,7	Spezialprodukt	Spezialprodukt						5,8	
S80 2.5 T, 4.4 V8 AWD	'06-'11	5,5-7	SuperTronic E 0W-30; HighTronic F 5W-30						-	Getr.Öl SNS-B 75W-80	Getriebeöl ATF 55	Getriebeöl ATF J	h Getriebeöl ATF J	0,7	Getriebeöl BS 75W-90	d	-	
S80 3.2, T6 AWD	'06-'10	7,4-7,7	SuperTronic E 0W-30; HighTronic F 5W-30						-	-	Getriebeöl ATF 55	Getriebeöl ATF J	h Getriebeöl ATF J	0,7	Getriebeöl BS 75W-90	d	-	
S80 3.2, T6 AWD	'10-	6,8	SuperTronic E 0W-30; HighTronic F 5W-30						-	-		Getriebeöl ATF J	h Getriebeöl ATF J	0,7	Getriebeöl BS 75W-90	d	8,9	
S90, V90 3.0	'96-'98	5,8		●		●		●	1,8	Getr.Öl SNS-B 75W-80	Getr.Öl ATF E-S	Getriebeöl ATF 55	1,3	Getriebeöl BS 75W-90			10	
XC70, XC90 2.5T	'02-'07	5,5-5,8	SuperTronic E 0W-30; HighTronic F 5W-30						2	Getr.Öl SNS-B 75W-80	h Getriebeöl ATF 55	Getriebeöl ATF J	h Getriebeöl ATF J	-	Getriebeöl BS 75W-90		-	



XC70, XC90 T6	'02-'06	6,6	●	●	●					2	-		Getr.Öl ATF E-S	Getriebeöl ATF 55	h	-	Getriebeöl BS 75W-90	-	
XC70, XC90 T6 AWD	'09-'10	7,4	SuperTronic E 0W-30; HighTronic F 5W-30								-	-		Getriebeöl ATF 55	Getriebeöl ATF J	h	0,7	Getriebeöl BS 75W-90	8,9
XC70 T6 AWD	'10-	6,8	SuperTronic E 0W-30; HighTronic F 5W-30								-	-			Getriebeöl ATF J	h	0,7	Getriebeöl BS 75W-90	8,9
XC70, XC90 3.2, V8 AWD	'04-'11	6,7-7,7	SuperTronic E 0W-30; HighTronic F 5W-30								-	-		Getriebeöl ATF 55	Getriebeöl ATF J	h	-	Getriebeöl BS 75W-90	8,9/10,2
XC70, XC90 3.2 AWD	'10-	6,8	SuperTronic E 0W-30; HighTronic F 5W-30								-	-			Getriebeöl ATF J	h	0,7	Getriebeöl BS 75W-90	8,9
<b>Diesel</b>																			
C30 1.6D, 2.0D	'06-'10	3,8/5,5	SuperTronic E 0W-30; HighTronic F 5W-30							1,7-1,9	Getr.Öl SNS-B 75W-80		Getriebeöl ATF 55	Getriebeöl ATF J	↔	↔			-
C30 D2	'10-	3,8	SuperTronic E 0W-30; HighTronic F 5W-30							1,6	Spezialprodukt	-			↔	↔			-
C30 D3, D4	'10-	5,9	SuperTronic E 0W-30; HighTronic F 5W-30							1,9	Spezialprodukt	-			↔	↔			-
C30 D5	'06-'10	5,5	SuperTronic E 0W-30; HighTronic F 5W-30							1,9	Spezialprodukt			Getriebeöl ATF J	↔	↔			11
S40, V40 1.9 D, TD	'95-'00	5		●			●			3,4	Getr.Öl SNS-B 75W-80	-			↔	↔			5-6,3
S40, V40 1.9 D	'01-'04	5,6		●			●			3,4	Getr.Öl SNS-B 75W-80	-			↔	↔			6,3
S40, V50 1.6 D, 2.0 D	'04-'10	3,8/5,2	SuperTronic E 0W-30; HighTronic F 5W-30							1,8-1,9	Getr.Öl SNS-B 75W-80				↔	↔			7,2-9,5
S40, V50 D2	'10-	3,9	SuperTronic E 0W-30; HighTronic F 5W-30							1,6	Spezialprodukt	-			↔	↔			-
S40, V50 D3, D4	'10-	5,9	SuperTronic E 0W-30; HighTronic F 5W-30							1,9	Spezialprodukt	-			↔	↔			-
S40, V50 D5	'06-'10	5,5	SuperTronic E 0W-30; HighTronic F 5W-30							1,9	Spezialprodukt			Getriebeöl ATF J	↔	↔			11
V70 2.0D	'07-'10	5,5	SuperTronic E 0W-30; HighTronic F 5W-30							1,75	Getr.Öl SNS-B 75W-80	-			↔	↔			9,4
S60, V70 2.4D, D5, AWD	'01-'05	6,5	●							2,1	Getr.Öl SNS-B 75W-80	gh	Getriebeöl ATF 55	Getriebeöl ATF J	gh	↔	↔	d	12,5
S60, V70 D, 2.4D, D5, AWD	'05-'10	6,2	SuperTronic E 0W-30; HighTronic F 5W-30							2-2,1	Getr.Öl SNS-B 75W-80		Getriebeöl ATF 55	Getriebeöl ATF J	gh	↔	↔	d	12,5
S60, V60 1.6D DRiVe	'10-	3,9	SuperTronic E 0W-30; HighTronic F 5W-30							1,7	Spezialprodukt	-			↔	↔			6,2
S60, V60 D3	'10-	5,9	SuperTronic E 0W-30; HighTronic F 5W-30							1,9	Spezialprodukt			Getriebeöl ATF J	↔	↔			8,9
S60, V60 D5, AWD	'10-	5,9	SuperTronic E 0W-30; HighTronic F 5W-30							1,9	Spezialprodukt			Getriebeöl ATF J	-	Getriebeöl BS 75W-90			8,9
XC60 D3, DRiVe	'10-	5,9	SuperTronic E 0W-30; HighTronic F 5W-30							1,9	Spezialprodukt			Getriebeöl ATF J	↔	↔			8,9
XC60 2.4D, D5	'08-'11	5,9	SuperTronic E 0W-30; HighTronic F 5W-30							1,9	Getr.Öl SNS-B 75W-80	ck		Getriebeöl ATF J	ck	-	Getriebeöl BS 75W-90		12,6
XC60 D5 AWD	'11-	5,9	SuperTronic E 0W-30; HighTronic F 5W-30							1,9	Spezialprodukt			Getriebeöl ATF J	↔	↔			8,9
V70 1.6D DRiVe	'09-	3,7-3,9	SuperTronic E 0W-30; HighTronic F 5W-30							1,9	Spezialprodukt	-			↔	↔			7,2
V70 D3, 2.4D	'10-	5,9-6	SuperTronic E 0W-30; HighTronic F 5W-30							1,9	Spezialprodukt			Getriebeöl ATF J	↔	↔			8,9
V70 D5, AWD	'09-'11	5,9	SuperTronic E 0W-30; HighTronic F 5W-30							2	Getr.Öl SNS-B 75W-80	gh	Getriebeöl ATF 55	Getriebeöl ATF J	gh	0,7	Getriebeöl BS 75W-90		8,9
V70 D5, AWD	'11-	5,9	SuperTronic E 0W-30; HighTronic F 5W-30							1,9	Spezialprodukt	gh		Getriebeöl ATF J	gh	0,7	Getriebeöl BS 75W-90		8,9
S70, V70 2.5 TDi	'96-'00	5,4		●			●			2,1	Getr.Öl SNS-B 75W-80		Getr.Öl ATF E-S	Getriebeöl ATF 55		↔	↔		8-8,5
V70 2.5 TDi	'00-'01	6		●			●			2,1	Getr.Öl SNS-B 75W-80	-			↔	↔			12,5
C70 2.0D	'07-'10	5,5	SuperTronic E 0W-30; HighTronic F 5W-30							1,75	Getr.Öl SNS-B 75W-80		Spezialprodukt		↔	↔			9,5
C70 D3, D4	'10-	5,9	SuperTronic E 0W-30; HighTronic F 5W-30							1,9	Spezialprodukt	-			↔	↔			8,5-8,9
C70 D5	'06-'10	5,5	SuperTronic E 0W-30; HighTronic F 5W-30							2	Getr.Öl SNS-B 75W-80		Getriebeöl ATF 55	Getriebeöl ATF J	↔	↔			11
S80 1.6D DRiVe	'09-'10	3,7	SuperTronic E 0W-30; HighTronic F 5W-30							1,9	Spezialprodukt	-			↔	↔			7,2
S80 1.6D DRiVe	'10-	3,9	SuperTronic E 0W-30; HighTronic F 5W-30							1,9	Spezialprodukt	-			↔	↔			7,2
S80 2.0D	'07-'10	5,5	SuperTronic E 0W-30; HighTronic F 5W-30							1,75	Getr.Öl SNS-B 75W-80	-			↔	↔			9,4
S80 D3	'11-	5,9	SuperTronic E 0W-30; HighTronic F 5W-30							1,9	Spezialprodukt	-			↔	↔			8,9
S80 2.5 TDi	'99-'01	6	●	●			●			2,1	Getr.Öl SNS-B 75W-80		Getr.Öl ATF E-S	Getriebeöl ATF 55		↔	↔		12,5
S80 2.4D, D5	'01-'06	6,5	●	●			●			2,1	Getr.Öl SNS-B 75W-80		Getr.Öl ATF E-S	Getriebeöl ATF 55		↔	↔		12,5
S80 2.4D, D5, AWD	'06-'11	6	SuperTronic E 0W-30; HighTronic F 5W-30							-	Getr.Öl SNS-B 75W-80		Getriebeöl ATF 55	Getriebeöl ATF J	hj	0,7	Getriebeöl BS 75W-90	d	12,5
S80 D5, AWD	'11-	5,9	SuperTronic E 0W-30; HighTronic F 5W-30							1,9	Spezialprodukt			Getriebeöl ATF J	hj	0,7	Getriebeöl BS 75W-90	d	8,9
940 Diesel	'90-'98	6		●			●			2,3	Spezialprodukt		Getr.Öl ATF E-S	Getriebeöl ATF 55		1,6	Getriebeöl BS 75W-90	e	10
940, 960 2.4 Turbo Diesel	'90-'98	6		●			●			2,3	Spezialprodukt	a	Getr.Öl ATF E-S	Getriebeöl ATF 55		1,6	Getriebeöl BS 75W-90	e	11,5
XC70, XC90 2.4D, D5	'03-'05	6,5	●	●			●			2	Getr.Öl SNS-B 75W-80	h	Getriebeöl ATF 55	Getriebeöl ATF J	h	-	Getriebeöl BS 75W-90	-	
XC70, XC90 D5	'05-'10	6-6,2	SuperTronic E 0W-30; HighTronic F 5W-30							2	Getr.Öl SNS-B 75W-80	h	Getriebeöl ATF 55	Getriebeöl ATF J	h	-	Getriebeöl BS 75W-90	-	
XC70 D3, D5	'09-	5,9	SuperTronic E 0W-30; HighTronic F 5W-30							1,9	Spezialprodukt	h		Getriebeöl ATF J	h	-	Getriebeöl BS 75W-90	-	
XC90 D3, D5	'10-	5,7-5,9	SuperTronic E 0W-30; HighTronic F 5W-30							2	Getr.Öl SNS-B 75W-80	h		Getriebeöl ATF J	h	-	Getriebeöl BS 75W-90	-	

a Getriebe Type M90, 940 ab 1994 und 960 ab 1995: 1,8 | Getr.Öl SNS-B 75W-80  
c Verteilergetriebe: Getriebeöl BS 75W-90  
e Sperrdifferential: Getr.Öl BS-LSX 75W-140, Getr.Öl HYP LS 85W-90  
g Verteilergetriebe: 0,8 | Getriebeöl BS 75W-90; Getriebeöl Hyp Synth 75W-90  
j Verteilergetriebe: 0,8 | Getriebeöl BS 75W-90

b Automatikgetriebe AW 55-50 (5-Gang): Getriebeöl ATF 55; Getriebeöl ATF J  
d Differential, hinten (AWD): Getriebeöl BS 75W-90; Getriebeöl Hyp 80W; AW 70/AW 71, ZF-4 HP 22, 4-Gang (1982->): Getr.Öl ATF E-S; Getriebeöl ATF 55  
f Differential, hinten (AWD): Getriebeöl BS 75W-90; Getriebeöl Hyp Synth 75W-90  
h Haldex Kupplung (AWD) Spezialprodukt, bitte auf Originalersatzteil des Herstellers zurückgreifen!  
k Haldex Kupplung (AWD) Spezialprodukt, bitte auf Originalersatzteil des Herstellers zurückgreifen!

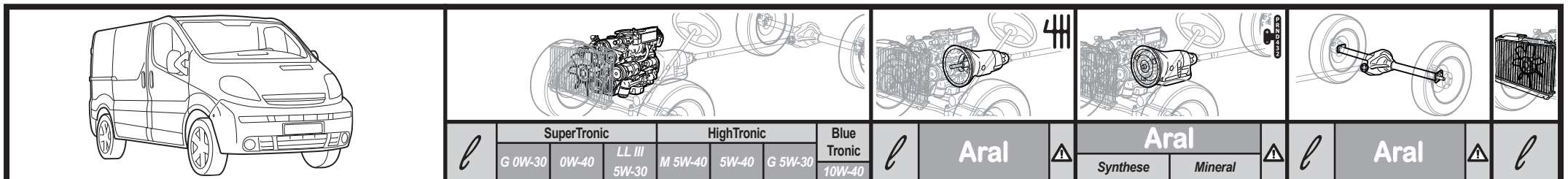

## CHEVROLET USA & GMC

			SuperTronic			HighTronic			Blue Tronic 10W-40	Aral	⚠	Aral		⚠	Aral	⚠			
			G 0W-30	0W-40	LL III 5W-30	M 5W-40	5W-40	G 5W-30				Synthese	Mineral						
Astro 4.3 V6 4x2, 4x4	'95-'05	4,3		●		●			●	-	-	Getr.Öl ATF E-S	Getriebeöl ATF 55		1,2/1,7	Getriebeöl BS 75W-90	d	12,8/15,5	
S10, Blazer/Jimmy 2.2, 4.3 (V6)	'90-'02	3,8-4,3		●		●			●	1,9	ac	Getr.Öl ATF E-S	Getriebeöl ATF 55	c	1,2-1,8	Getriebeöl BS 75W-90	de	9	
Suburban, Tahoe V8	'88-'99	4,7/5,7		●		●			●	1,9-3,8	bc	Getriebeöl SNS 75W-80	Getriebeöl ATF 55	c	1,7-2,8	Getriebeöl BS 75W-90	d	16,5	
G 10/20/30 (Sport)van V6, V8	'88-'96	3,8-5,7		●		●			●	1,9-3,8		Getriebeöl SNS 75W-80	Getriebeöl ATF 55	c	1,7-2,8	Getriebeöl BS 75W-90	d	11,5	
Express 4.3 V6, 5.0 V8, 5.7 V8	'97-'02	4,3-4,8	●	●		●			●	-		Getr.Öl ATF E-S	Getriebeöl ATF 55		2,5-3	Getriebeöl BS 75W-90		10,4-18,9	
Express 7.4 V8, 8.1 V8	'97-'02	5,6-6,15	●	●		●			●	-		Getr.Öl ATF E-S	Getriebeöl ATF 55		-	Getriebeöl BS 75W-90		21,8-24,6	
Express 4.3 V6, 4,8 V8, 5,3 V8, 6,0 V8	'03-'04	4,3-5,7		●		●			●	-		Getr.Öl ATF E-S	Getriebeöl ATF 55	c	2-3,15	Getriebeöl BS 75W-90	d	10,4-17	
Express 4.3 V6, 4,8 V8, 5,3 V8, 6,0 V8	'05-'05	4,3-5,7		●		●			●	-		Getriebeöl ATF 55	Getriebeöl ATF J	f	2-3,15	Getriebeöl BS 75W-90	d	10,4-17	
Express 4.3 V6, 4,8 V8, 5,3 V8, 6,0 V8	'06-'06	4,3-5,7		●		●			●	-		Spezialprodukt		f	2-3,15	Getriebeöl BS 75W-90	d	10,4-17	
Express 4.3 V6, 4,8 V8, 5,3 V8, 6,0 V8	'07-'08	4,3-5,7		●		●			●	-		Spezialprodukt		g	2-3,15	Getriebeöl BS 75W-90	d	10,4-17	
Express 4.3 V6, 4,8 V8, 5,3 V8, 6,0 V8	'09-'10	4,3-5,7		●		●			●	-		Spezialprodukt		h	2-3,15	Getriebeöl BS 75W-90	d	10,4-17	
Express 4.3 V6, 4,8 V8, 5,3 V8, 6,0 V8	'11-	4,3-5,7		●		●		●	●	-		Spezialprodukt		h	2-3,15	Getriebeöl BS 75W-90	d	10,4-17	
C/K 1500/10, 2500/20 Pickup V6, V8	'88-'99	3,8-5,7		●		●			●	1,9-3,8	bc	Getriebeöl SNS 75W-80	Getriebeöl ATF 55	c	1,7-2,8	Getriebeöl BS 75W-90	d	11,5	
<b>Diesel</b>																			
Express 6.5L V8 Diesel	'97-'02	6,6	Tronic 15W-40; ExtraTurboral 10W-40; MultiTurboral 15W-40								-		Getr.Öl ATF E-S	Getriebeöl ATF 55		2,6-6	Getriebeöl BS 75W-90		20,8-24,6
C/K 1500/10, 2500/20 Pickup 6.2, 6.5 V8	'88-'99	6,6				●		●	●	1,9-3,8	bc	Getriebeöl SNS 75W-80	Getriebeöl ATF 55	c	1,7-2,8	Getriebeöl BS 75W-90	d	16,5	

a 5-Ganggetriebe mit geteiltem Gehäuse: Getriebeöl SNS 75W-80; Getriebeöl EP 80W

c Verteilergetriebe: Getr.Öl ATF E-S; Getriebeöl ATF 55

e Sperrdifferential: Getr.Öl BS-LSX 75W-140, Getr.Öl HYP LS 85W-90

g Verteilergetriebe: Spezialprodukt, bitte auf Originalersatzteil des Herstellers zurückgreifen!

b Getriebe NV4500, 1991->: Getr.Öl SNS-B 75W-80; Getriebeöl SNS 75W-80

d Differentiale, vorn und hinten

f Verteilergetriebe: Getriebeöl ATF 55; Getriebeöl ATF J

h Verteilergetriebe: Spezialprodukt, bitte auf Originalersatzteil des Herstellers zurückgreifen!

## CITROËN

Nemo 1.4	'07-'09	3	●	●		●			●	2	Getr.Öl EP Synth 75W-90	-			↔	↔		5,3	
Nemo 1.4	'09-	3	HighTronic J 5W-30							●	2	Getr.Öl EP Synth 75W-90	-			↔	↔		5,3
Berlingo 1.1, 1.4, 1.4i	'96-'99	3,5		●		●			●	2	Getr.Öl EP Synth 75W-90	-			↔	↔		7	
Berlingo 1.4i, 1.4i CNG	'00-'09	3,5	●	●		●			●	2	Getr.Öl EP Synth 75W-90	-			↔	↔		6	
Berlingo 1.6 16V, 1.6 16V Vti	'08-	3,3	HighTronic J 5W-30							●	1,8	Getr.Öl EP Synth 75W-90	-			↔	↔		5,9
Berlingo 1.8i	'99-'01	5		●		●			●	1,8	Getr.Öl EP Synth 75W-90	-			↔	↔		8	
Jumpy, Dispatch 1.6i	'95-'01	3,8		●		●			●	1,8	Getr.Öl EP Synth 75W-90	-			↔	↔		8,5	
Jumpy, Dispatch 2.0i	'01-'07	4,25	●	●		●			●	1,8	Getr.Öl EP Synth 75W-90	-			↔	↔		7	
Jumpy, Dispatch 2.0i 16V	'07-'09	5		●		●			●	1,8	Getr.Öl EP Synth 75W-90	-			↔	↔		-	
Jumpy, Dispatch 2.0i 16V	'09-	5	HighTronic J 5W-30							●	1,8	Getr.Öl EP Synth 75W-90	-			↔	↔		-
Jumper, Relay 2.0i, 4x4	'94-'00	4,5-4,8		●		●			●	1,9	Getr.Öl EP Synth 75W-90	a			↔	↔	b	9,5	
Jumper, Relay 2.0i, 4x4	'00-'07	4,5-4,75	●	●		●			●	1,85-2,7	Getr.Öl EP Synth 75W-90	-			↔	↔		9,0	
<b>Diesel</b>																			
Nemo 1.3 Hdi	'10-	3,2	HighTronic J 5W-30							●	2	Getr.Öl EP Synth 75W-90	Spezialprodukt		c	↔	↔		7,6
Nemo 1.4 Hdi	'07-'09	3,8	●	●		●		●	●	2	Getr.Öl EP Synth 75W-90	-			↔	↔		7,4	
Nemo 1.4 Hdi, 1.4 Hdi SensoDrive	'09-	3,8	HighTronic J 5W-30							●	2	Getr.Öl EP Synth 75W-90	-			↔	↔		7,4
Berlingo 1.6 HDi	'05-'09	4,7	●	●		●		●	●	1,9	Getr.Öl EP Synth 75W-90	-			↔	↔		11	
Berlingo 1.6 HDi	'08-	4,7		●		●		●	●	1,8	Getr.Öl EP Synth 75W-90	-			↔	↔		11	
Berlingo 1.6 HDi DPF	'08-	4,7	HighTronic J 5W-30							●	1,8	Getr.Öl EP Synth 75W-90	-			↔	↔		11
Berlingo 1.8 D, 1.9 D	'96-'98	5		●		●		●	●	1,8	Getr.Öl EP Synth 75W-90	-			↔	↔		8	
Berlingo 1.9 D	'99-'05	4,8	●	●		●		●	●	1,8	Getr.Öl EP Synth 75W-90	-			↔	↔		8	
Berlingo 2.0 HDi	'00-'05	4,5	●	●		●		●	●	1,8	Getr.Öl EP Synth 75W-90	-			↔	↔		7-9	
Jumpy, Despatch 1.6 HDi	'07-	6,1	HighTronic J 5W-30							●	1,9	Getr.Öl EP Synth 75W-90	-			↔	↔		10,2
Jumpy, Despatch 1.9 D, Turbo D	'95-'07	4-5		●		●		●	●	1,8	Getr.Öl EP Synth 75W-90	-			↔	↔		9	

Jumpy, Despatch 2.0 HDi	'00-'07	4,5	●	●			●	●	1,8	Getr.Öl EP Synth 75W-90	-			↔	↔		8,5
Jumpy, Despatch 2.0 HDi	'07-	5							1,9	HighTronic J 5W-30 Getr.Öl EP Synth 75W-90	-			↔	↔		-
Jumpy, Despatch 2.0 HDi DPF	'07-	5							1,9	HighTronic J 5W-30 Getr.Öl EP Synth 75W-90	-			↔	↔		-
Jumper, Relay 1.9 D, Turbo D	'94-'02	4,2-5,3		●			●	●	1,9	Getr.Öl EP Synth 75W-90	-			↔	↔		10
Jumper 2.0 HDi, 2.2 HDi	'02-'07	5,3	●	●			●	●	1,85-2,7	Getr.Öl EP Synth 75W-90	-			↔	↔		10,5-11
Jumper 2.2 HDi	'07-	6							2,7-2,9	HighTronic J 5W-30 Getr.Öl EP Synth 75W-90	-			↔	↔		10,5-11
Jumper, Relay 2.5 D, Turbo D	'94-'02	9		●			●	●	1,9	Getr.Öl EP Synth 75W-90	-			↔	↔		13
Jumper, Relay 2.5 TDi, 4x4	'97-'01	8		●			●	●	2,8	Getr.Öl EP Synth 75W-90	a			↔	↔	b	13-13,5
Jumper 2.8 HDi	'02-'07	7	●	●			●	●	1,85-2,7	Getr.Öl EP Synth 75W-90	-		Spezialprodukt	↔	↔		10
Jumper 3.0 HDi	'07-	7							2,9	HighTronic J 5W-30 Getr.Öl EP Synth 75W-90	-			↔	↔		11,1-11,6

a Verteilergetriebe: 0.5 l Getr.Öl HYP LS 85W-90

b Differential, hinten (4x4): 2,3 l Getr.Öl HYP LS 85W-90

c Hydraulisch betätigtes Automatikgetriebe MCP: Spezialprodukt, bitte auf Originalersatzteil des Herstellers zurückgreifen!

## DACIA

Logan Van 1.4	'07-	3,3					●		2,5	Getr.Öl EP Synth 75W-90	-			↔	↔		5,5
Logan Van/Pick-up 1.6, 16 16V	'07-	3,3-4,8					●		2,5	Getr.Öl EP Synth 75W-90	-			↔	↔		4,5-5,5
<b>Diesel</b>																	
Logan Van/Pick-up 1.5 dCi	'07-	4,5					●		2,5	Getr.Öl EP Synth 75W-90	-			↔	↔		4,5-5,5

## DAEWOO-FSO

Caro 1.9 D, Car-go 1.9 D	'93-'03	5					●	●	1,6	Getr.Öl EP Synth 75W-90	-			1,4	Getriebeöl BS 75W-90		7,5-10,5
--------------------------	---------	---	--	--	--	--	---	---	-----	-------------------------	---	--	--	-----	----------------------	--	----------

## DAIHATSU

Hijet 1000/1300	'93-'05	3,1/3,5					●	●	1,6/1,1	Getriebeöl SNS 75W-80	-			1,2/1,15	Getriebeöl BS 75W-90		4,5/5,7
<b>Diesel</b>																	
Hijet 1000/1200 D	'96-'05	3,9					●	●	1,1	Getriebeöl SNS 75W-80	-			1,15	Getriebeöl BS 75W-90		5,5

## DODGE

(Grand) Caravan 2.4 16V	'95-'00	4,3		●		●			-	-				↔	↔		9
(Grand) Caravan 2.4i 16V	'01-'04	4,7	●	●		●		●	2,2	Spezialprodukt				↔	↔		10,7
(Grand) Caravan 3.3 V6, 3.8 V6, AWD	'95-'01	4,3		●		●			-	-			a	-	Getriebeöl BS 75W-90		12,5
(Grand) Caravan 3.3i V6	'01-'08	4	●	●		●		●	-	-				↔	↔		12,6/15,4
(Grand) Caravan 3.3	'08-'10	4,7							-	-				↔	↔		12,6/15,4
(Grand) Caravan 3.6	'11-	5,6							-	-				↔	↔		12,6/15,4
(Grand) Caravan 3.8	'05-'10	4,7							-	-				↔	↔		12,6/15,4
(Grand) Caravan 4.0	'08-'10	4,7							-	-				↔	↔		12,6/15,4
Ram Van 2.4i	'96-'01	4,3		●		●		●	2,2	HighTronic M 5W-40				↔	↔		9/13,4
Ram Van 2.4i 16V, 3.3i V6, AWD	'01-'08	4-4,7	●	●		●		●	2,2	Spezialprodukt			d	0,7	Getriebeöl BS 75W-90		10,7-15,4
Ram 1500, 3.7 V6, 4.7 V8, 5.7 V8 (4x4)	'04-	4,7-5,6	●	●		●			2,2	Spezialprodukt	b			1,6-3,6	Getriebeöl BS 75W-90	a	15,4
Sprinter 2500 3.5 V6; 3500 3.5 V6	'07-'09	9,5	●	●		●			-	-				1,6-2,8	Getriebeöl SNA-C 75W-90		7
<b>Diesel</b>																	
Ram Van 2.5 TD	'96-'00	6,8		●		●		●	2,2	HighTronic 5W-40	-			↔	↔		10
Ram Van 2.5 CRD	'01-'05	6	●	●		●		●	2,2-2,7	Spezialprodukt				↔	↔		13,8/16,6
Ram Van 2.8 CRD	'04-'08	6		●		●		●	-	-				↔	↔		13,8/16,6
Ram 2500/3500 5.9 TD, AWD	'06-	8,2		●		●		●	4,5	Getr.Öl SNS-B 75W-80	b			1,6-3,6	Getriebeöl BS 75W-90	c	28
Sprinter 2500 CDI, 3500 CDI	'03-'06	9		●		●		●	1,6	Getr.Öl SNS-B 75W-80				1,5-1,8	Getriebeöl HYP 85W-90		10
Sprinter 2500 CDI, 3500 CDI	'07-'09	11	●	●	●	●		●	-	-				2,6	Getriebeöl SNA-C 75W-90		9,5-10
Sprinter 2500 CDI + DPF, 3500 CDI + DPF	'07-'09	11		●	●	●		●	-	-				2,6	Getriebeöl SNA-C 75W-90		9,5-10

a Sperrdifferential: Getr.Öl BS LSX 75W-140

b Verteilergetriebe: Spezialprodukt, bitte auf Originalersatzteil des Herstellers zurückgreifen!

c Differentiale, vorn und hinten

d Verteilergetriebe: Getriebeöl BS 75W-90; Getriebeöl SNA-C 75W-90

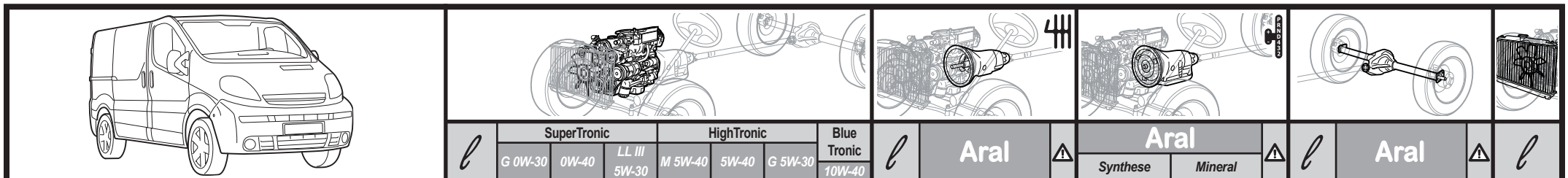
**FIAT**

			SuperTronic			HighTronic			Blue Tronic 10W-40	ℓ	Aral	⚠	Aral		⚠	ℓ	Aral	⚠	ℓ
			G 0W-30	0W-40	LL III 5W-30	M 5W-40	5W-40	G 5W-30					Synthese	Mineral					
Fiorino 1.1	'88-'94	3,4		●		●		●	3	Getriebeöl EP 85W-90	-				↔	↔		4,8	
Fiorino 1,3, 1.4, 1.6	'94-'98	3,7-4,25		●		●		●	2,4-3,1	Getriebeöl EP 85W-90	-				↔	↔		5,5-6,5	
Fiorino 1.5 i.e.	'91-'94	4,1		●		●		●	3,4	Getriebeöl EP 85W-90	-				↔	↔		7	
Fiorino 1.4 8V	'08-'10	3	HighTronic F 5W-30							1,9	Getr.Öl EP Synth 75W-90	-			↔	↔		7,4	
Fiorino 1.4 8V	'10-	3		●			●		1,9	Getr.Öl EP Synth 75W-90	-				↔	↔		7,4	
Fiorino 1.4 8V Natural Power	'09-	3		●			●		1,7	Getr.Öl EP Synth 75W-90	-				↔	↔		7,4	
Doblò 1.2 8V, 1.6 16V	'00-	2,8/3,9		●			●		2	Getr.Öl EP Synth 75W-90	-				↔	↔		4,2	
Doblò 1.4 8V	'04-'09	2,6				●		●	2	Getr.Öl EP Synth 75W-90	-				↔	↔		7	
Doblò 1.4 16V	'09-	2,7		●			●		1,75	Getr.Öl EP Synth 75W-90	-				↔	↔		-	
Strada 1.2 8V	'97-	2,8		●			●		2	Getr.Öl EP Synth 75W-90	-				↔	↔		4,2	
Scudo 1.6	'95-'01	3,6		●			●		1,9	Getr.Öl EP Synth 75W-90	-				↔	↔		8,5	
Scudo 2.0 16V	'00-'07	4,25		●			●		1,9	Getr.Öl EP Synth 75W-90	Getr.Öl ATF E-S	Getriebeöl ATF 55			↔	↔		8,5	
Ducato 2.0, 4x4	'94-'02	5		●			●		1,9-2,5	Getr.Öl EP Synth 75W-90	b				↔	↔	a	9	
Ducato 2.0	'02-'07	5		●			●		2,45	Getr.Öl EP Synth 75W-90	-				↔	↔		9	
Ducato Natural Power	'09-	-		●			●		2,9	Getr.Öl EP Synth 75W-90	-				↔	↔		-	
<b>Diesel</b>																			
Fiorino 1.7 D	'94-'98	5		●			●		3,1	Getriebeöl EP 85W-90	-				↔	↔		8	
Fiorino 1.7 TD	'97-'98	5		●			●		3,1	Getriebeöl EP 85W-90	-				↔	↔		8	
Fiorino 1.3 Multijet	'08-	3,2	HighTronic C 5W-30; HighTronic J 5W-30							2	Getr.Öl EP Synth 75W-90	Spezialprodukt		d	↔	↔		7,6	
Doblò 1.3 Multijet 51kW	'04-'05	3		●			●		2	Getr.Öl EP Synth 75W-90	-				↔	↔		6,2	
Doblò 1.3 Multijet 55kW, Doblò 1.3 Multijet 62kW	'05-'09	3,2		●			●		2	Getr.Öl EP Synth 75W-90	-				↔	↔		6,5	
Doblò 1.3 Multijet	'09-	3,2	HighTronic C 5W-30; HighTronic J 5W-30							2	Getr.Öl EP Synth 75W-90	-			↔	↔		-	
Doblò 1.6 Multijet	'09-	4,9	HighTronic C 5W-30; HighTronic J 5W-30							2	Getr.Öl EP Synth 75W-90	Spezialprodukt		d	↔	↔		-	
Doblò 1.9 D, 1.9 JTD 77kW	'00-'09	4,3		●			●		2	Getr.Öl EP Synth 75W-90	-				↔	↔		6,2	
Doblò 1.9 JTD 88kW	'06-'09	4,3		●			●		2	Getr.Öl EP Synth 75W-90	-				↔	↔		6,5	
Doblò 2.0 Multijet	'09-	4,9	HighTronic C 5W-30; HighTronic J 5W-30							2	Getr.Öl EP Synth 75W-90	-			↔	↔		-	
Strada 1.9 D, 1.9 JTD	'97-	4,3		●			●		2	Getr.Öl EP Synth 75W-90	-				↔	↔		6,2	
Scudo 1.9 D, 1.9 TD	'96-'99	4,5-5		●			●		1,9	Getr.Öl EP Synth 75W-90	-				↔	↔		8,5-9	
Scudo 2.0 JTD	'99-'06	4,5-4,75		●			●		1,85	Getr.Öl EP Synth 75W-90	-				↔	↔		9	
Scudo 2.0 MultiJet	'06-	5,25		●			●		1,9	Getr.Öl EP Synth 75W-90	-				↔	↔		9	
Ducato 1.9 D, 1.9 TD	'94-'02	4,6		●			●		2	Getr.Öl EP Synth 75W-90	-				↔	↔		9-10	
Ducato 2.5 D, 2.5 TD, 2.5 TDi, 4x4	'94-'02	7,3		●			●		2-2,5	Getr.Öl EP Synth 75W-90	b				↔	↔	a	10-11	
Ducato 2.8 TDid	'98-'02	7,3		●			●		2,7	Getr.Öl EP Synth 75W-90	-				↔	↔		10	
Ducato 2.0 JTD, 2.3 JTD, 2.8 JTD, 2.8 JTD Power	'02-'07	5,25-6,3		●			●		2	Getr.Öl EP Synth 75W-90	Getr.Öl ATF E-S	Getriebeöl ATF 55			↔	↔		9-10	
Ducato 2.0 MultiJet 115 Euro 5	'11-	5,7	HighTronic C 5W-30; HighTronic J 5W-30							2,9	Getr.Öl EP Synth 75W-90	-			↔	↔		8	
Ducato 2.2 MultiJet 100, 2.3 MultiJet 120, 150	'07-'11	6,4-6,5	HighTronic C 5W-30; HighTronic J 5W-30							2,4-2,7	Getr.Öl EP Synth 75W-90	c			↔	↔		11-11,9	
Ducato 2.3 MultiJet 130, 150 Euro 5	'11-	5,9	HighTronic C 5W-30; HighTronic J 5W-30							2,7	Getr.Öl EP Synth 75W-90	c			↔	↔		9,6	
Ducato 3.0 MultiJet	'07-'11	9,7	HighTronic C 5W-30; HighTronic J 5W-30							2,9	Getr.Öl EP Synth 75W-90	-			↔	↔		11-11,9	
Ducato 3.0 MultiJet EURO V	'10-'11	9	HighTronic J 5W-30							2,9	Getr.Öl EP Synth 75W-90	-			↔	↔		11-11,9	
Ducato 3.0 MultiJet 180 Euro 5	'11-	9	HighTronic C 5W-30; HighTronic J 5W-30							2,9	Getr.Öl EP Synth 75W-90	-			↔	↔		10	

a Differential, hinten (4x4): 2,3 | Getr.Öl HYP LS 85W-90

c Getriebe M38: 2,9 | Getr.Öl SNS-A 75W-85

b Verteilergetriebe: 0,5 | Getr.Öl HYP LS 85W-90

d Hydrauliksystem: Spezialprodukt, bitte auf Originalersatzteil des Herstellers zurückgreifen!

# FORD (EU)

Fiesta Van 1.25	'09-'11	4,05	EcoTronic F 5W-20; HighTronic F 5W-30	2,3	Getriebeöl SNS 75W-80	-				↔	↔		5,5	
Fiesta Van 1.25	'12-	4,05	EcoTronic F 5W-20	2,3	Getriebeöl SNS 75W-80	-				↔	↔		5,5	
Courier 1.3 (endura)	'96-'02	3,3	HighTronic F 5W-30	2,8	Getriebeöl SNS 75W-80	-				↔	↔		7	
Transit Connect/Tourneo Connect 1.8	'02-'07	4,25	●   ●   ●	1,9	Getriebeöl SNS 75W-80	-				↔	↔		6,5	
Transit Connect Electric	'10-	-	-	-	-	-	Spezialprodukt			↔	↔		7	
Transit 2.0	'92-'95	3,8/4,5	●     ●     ●     ●	1,2	Getriebeöl SNS 75W-80	Getriebeöl ATF 55	Getriebeöl ATF 22	1,7/2,7	Getr.Öl BS LSX 75W-140				8/8,5	
Transit 2.0 8v	'98-'00	4,25	HighTronic F 5W-30	1,3	Getriebeöl SNS 75W-80	Getr.Öl ATF E-S		1,9	Getr.Öl BS LSX 75W-140				8,5	
Transit 2.3 DOHC 16V	'00-'06	4,25	HighTronic F 5W-30	1,3	Getriebeöl SNS 75W-80	-		2,6	Getr.Öl BS LSX 75W-140				7,8-10,1	
Transit 2.3 Duratec	'06-'11	3,9	EcoTronic F 5W-20; HighTronic F 5W-30	1,3	Getriebeöl SNS 75W-80	-		3	Getr.Öl BS LSX 75W-140				7,8-10,1	
Ranger 2.5	'11-	6,7	●     ●	2,6	Spezialprodukt	-						3-3,45	Getr.Öl BS LSX 75W-140	11
<b>Diesel</b>														
Fiesta 1.4 TDCi, 1.6 TDCi	'09-'11	3,8	HighTronic F 5W-30	2,3	Getriebeöl SNS 75W-80	-				↔	↔		-	
Fiesta 1.5 TDCi	'12-	-	HighTronic F 5W-30	2,3	Getriebeöl SNS 75W-80	-				↔	↔		5,5	
Fiesta 1.4 TDCi, 1.5 TDCi, 1.6 TDCi	'12-	3,8	HighTronic F 5W-30	2,3	Getriebeöl SNS 75W-80	-				↔	↔		-	
Courier 1.8 D	'96-'98	4,5	●         ●     ●	2,8	Getriebeöl SNS 75W-80	-				↔	↔		9,5	
Courier 1.8 D/1.8 Di	'99-'02	5	HighTronic F 5W-30	-	Getriebeöl SNS 75W-80	-				↔	↔		9,3	
Escort Van/Express 1.8 D, 1.8 TD	'97-'05	4,5-5,1	HighTronic F 5W-30	2,6-2,8	Getriebeöl SNS 75W-80	-				↔	↔		9,3	
Transit Connect 1.8 TDDi	'02-'07	5,6	HighTronic F 5W-30	1,9	Getriebeöl SNS 75W-80	-				↔	↔		7	
Transit Connect 1.8 TDCi	'02-	5,6	HighTronic F 5W-30	1,9	Getriebeöl SNS 75W-80	-				↔	↔		7	
Transit 2.5 Di	'92-'98	6	●         ●     ●	1,2	Getriebeöl SNS 75W-80	Getriebeöl ATF 55	Getriebeöl ATF 22	1,7/2,7	Getriebeöl SNS 75W-80				11,5	
Transit 2.5 Di	'98-'00	6	●         ●     ●	1,3	Getriebeöl SNS 75W-80	Getr.Öl ATF E-S		1,7/2,7	Getr.Öl BS LSX 75W-140				11,5	
Transit 2.5 TD	'92-'00	6	●         ●     ●	1,2	Getriebeöl SNS 75W-80	Getriebeöl ATF 55	Getriebeöl ATF 22	1,7/2,7	Getriebeöl BS 75W-90				12	
Transit 2.5 TDi	'98-'00	6	●         ●     ●	1,3	Getriebeöl SNS 75W-80	Getr.Öl ATF E-S		1,7/2,7	Getr.Öl BS LSX 75W-140				12	
Transit 2.0 TDi, 2.0 TDCi	'00-'06	6,7	HighTronic F 5W-30	-	Getriebeöl SNS 75W-80	-				↔	↔		10-13	
Transit 2.2 TDCi	'06-'11	6,14	HighTronic F 5W-30	2,15	Getriebeöl SNS 75W-80	-				↔	↔		10-13	
Transit 2.2 TDCi (140KW)	'07-'11	6,14	HighTronic F 5W-30	2,1	Spezialprodukt	-				↔	↔		10-13	
Transit 2.2 TDCi FWD Euro 5	'11-'11	6,2	HighTronic F 5W-30	2,1	Spezialprodukt	-				↔	↔		10-13	
Transit 2.2 TDCi FWD Euro 5	'12-	6,2	HighTronic F 5W-30	2,1	Spezialprodukt	-				↔	↔		10-13	
Transit 2.2 TDCi RWD Euro 5	'11-'11	10,1	HighTronic F 5W-30	2,3	Getriebeöl SNS 75W-80	-		3	Getr.Öl BS LSX 75W-140				10-13	
Transit 2.2 TDCi RWD Euro 5	'12-	10,1	HighTronic F 5W-30	2,3	Getriebeöl SNS 75W-80	-		3	Getr.Öl BS LSX 75W-140				10-13	
Transit 2.2 TDCi AWD Euro 5	'11-'11	10,1	HighTronic F 5W-30	2,3	Getriebeöl SNS 75W-80	h	-	3	Getr.Öl BS LSX 75W-140		j		10-13	
Transit 2.2 TDCi AWD Euro 5	'12-	10,1	HighTronic F 5W-30	2,3	Getriebeöl SNS 75W-80	h	-	3	Getr.Öl BS LSX 75W-140		j		10-13	
Transit 2.4 Tddi	'00-'06	6,5-7,1	HighTronic F 5W-30	1,3	Getriebeöl SNS 75W-80	-		2,6	Getr.Öl BS LSX 75W-140				10-13	
Transit 2.4 Tddi (90/125)	'03-'06	6,5	HighTronic F 5W-30	1,3/2,3	Getriebeöl SNS 75W-80	e	-	2,6	Getr.Öl BS LSX 75W-140				10-13	
Transit 2.4 TDCi (137)	'03-'06	6,5	HighTronic F 5W-30	2,2	Getriebeöl SNS 75W-80	-		2,6	Getr.Öl BS LSX 75W-140				10-13	
Transit 2.4 TDCi, AWD	'06-'11	6,86-8,8	HighTronic F 5W-30	2,3	Getriebeöl SNS 75W-80	h	-	3	Getr.Öl BS LSX 75W-140		j		10-13	
Transit 3.2 TDCi	'07-	11,4	HighTronic F 5W-30	2,2	Getriebeöl SNS 75W-80	-		3	Getr.Öl BS LSX 75W-140				10,5-13,5	
Ranger 2.5 D, TD	'98-'02	6,3	HighTronic F 5W-30	2	Getriebeöl SNS 75W-80	c	-	1,2/1,7	Getriebeöl BS 75W-90		d		9,4	
Ranger 2.5 TD, 4x4	'03-'06	6,3	●     ●         ●     ●	2	Getr.Öl SNS-B 75W-80	f	-	1,2-1,85	Getriebeöl BS 75W-90		g		8,8-9,4	
Ranger 2.5 TDCi	'06-'11	7	●     ●         ●     ●	2,8	Getr.Öl SNS-B 75W-80	a	Spezialprodukt	n	1,3-2,6	Getriebeöl BS 75W-90		b	9,4	
Ranger 3.0 TDCi	'06-'11	7	●     ●         ●     ●	2,8	Getr.Öl SNS-B 75W-80	a	Spezialprodukt	n	1,3-2,6	Getriebeöl BS 75W-90		b	9,4	
Ranger 2.2 TDCi, 3.3 TDCi, 4x4	'11-	8,6-9,8	HighTronic F 5W-30	2,6	Spezialprodukt	o	Spezialprodukt			3-3,45	Getr.Öl BS LSX 75W-140		p	11,5

a Verteilergetriebe: 1,8-2 l Getr.Öl ATF E-S; Getriebeöl ATF 55

c Verteilergetriebe: 2 l Getriebeöl SNS 75W-80; Getr.Öl EP Synth 75W-90

e 6-Gang Getriebe MT82; 2,2 l Getriebeöl SNS 75W-80; Getr.Öl EP Synth 75W-90

g Sperrdifferential: 1,85 l Getr.Öl BS LSX 75W-140; Getr.Öl HYP LS 85W-90

j Differential vorn (4x4): 3,8 l Getr.Öl BS LSX 75W-140; Getr.Öl HYP LS 85W-90

o Verteilergetriebe: 1,2 l Spezialprodukt, bitte auf Originalersatzteil des Herstellers zurückgreifen!

b Differential vorn (4x4): 1,85 l Getr.Öl BS LSX 75W-140; Getr.Öl HYP LS 85W-90

d Sperrdifferential: 1,7 l Getr.Öl BS LSX 75W-140

f Verteilergetriebe: 2 l Getr.Öl SNS-B 75W-80; Getriebeöl SNS 75W-80

h Verteilergetriebe: 3,2 l Getriebeöl SNS 75W-80; Getr.Öl EP Synth 75W-90

n Verteilergetriebe von Automatik: 1,2 l Spezialprodukt, bitte auf Originalersatzteil des Herstellers zurückgreifen!

p Differential vorn (4x4): 1,27-1,32 l Getr.Öl BS LSX 75W-140; Getr.Öl HYP LS 85W-90

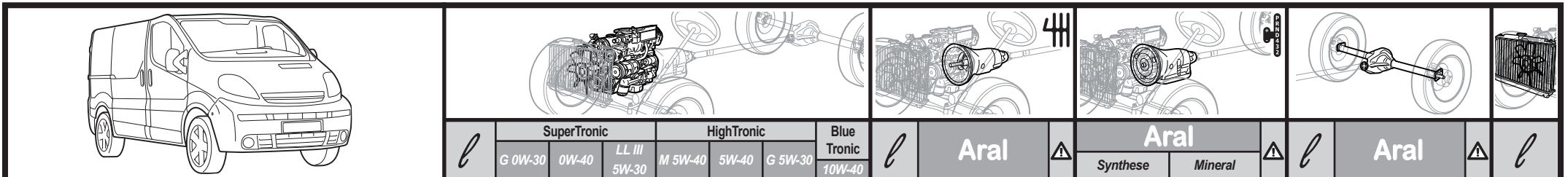
**FORD (USA)**

			SuperTronic			HighTronic			Blue Tronic 10W-40	Aral	⚠	Aral		⚠	Aral	⚠		
			G 0W-30	0W-40	LL III 5W-30	M 5W-40	5W-40	G 5W-30				Synthese	Mineral					
Transit Connect 2.0	'10-	4,3															5,7	
Transit Connect Electric	'10-	-															-	
Explorer 4.0 V6	'91-'02	4,7-5	●			●		●	2,6	Getr.Öl ATF E-S	ab	Getr.Öl ATF E-S	Getriebeöl ATF 55	b	0,5-1,7	Getriebeöl BS 75W-90	de	8-10
E-150/250 4.2 V6, 4.6 V8, 5.4 V8	'01-'08	5,7							5,5	Getr.Öl ATF E-S		Spezialprodukt		n	2,6-3,9		k	20,9-30,8
E-150/250 4.2 V6, 4.6 V8, 5.4 V8	'08-'11	5,7							-	-		Spezialprodukt			2,8-3,1		k	22,6-24,6
E-150/250 4.2 V6, 4.6 V8, 5.4 V8	'12-	5,7							-	-		Spezialprodukt			2,8-3,1		k	22,6-29,1
E-350/450 5.4 V8, 6.8 V10	'01-'08	5,7							-	-		Spezialprodukt	n	2,8-3,1		k	27,2-29,1	
E-350/450 5.4 V8, 6.8 V10	'08-'11	5,7							-	-		Spezialprodukt		2,8-3,1		k	27,2-29,1	
E-350/450 5.4 V8, 6.8 V10	'12-	5,7							-	-		Spezialprodukt		2,8-3,1		k	27,2-29,1	
F-150 3.5 EcoBoost V6, 4x4	'11-	5,7							-	-		Spezialprodukt		h	2,6	Getr.Öl BS LSX 75W-140	gj	15,6
F-150 3.7 V6 Ti-VCT, 5.0 V8 Ti-VCT, 4x4	'11-	5,7/7,3							-	-		Spezialprodukt		h	2,6	Getr.Öl BS LSX 75W-140	gj	15,1/16,1
F-150 4.2L V6, 4.6L V8	'97-'04	5,7-6,6							3,5	Getr.Öl ATF E-S	f	Getr.Öl ATF E-S	Getriebeöl ATF 55	f	2,6	Getr.Öl BS LSX 75W-140	c	16,4-18,4
F-150 4.2 V6, 4.6 V8, 5.4 V8, 4x4	'04-'08	5,7-6,6							3,5	Getr.Öl ATF E-S	f	Spezialprodukt		f	2,6-3,3	Getr.Öl BS LSX 75W-140	j	16,7-19,4
F-150 4.6 V8, 5.4 V8, E85, 4x4	'09-'10	5,7-6,6							-	-		Spezialprodukt		h	2,6	Getr.Öl BS LSX 75W-140	gj	15-16
F-150 6.2 V8, 4x4	'10-	6,6							-	-	h	Spezialprodukt		h	2,6	Getr.Öl BS LSX 75W-140	gj	18,5
F-250/350/450/550 5.4 V8, 4x4	'98-'04	6,6							-	-	f	Spezialprodukt		f	4-6,6		jim	25
F-250/350/450/550 5.4 V8, 4x4	'04-'08	6,6							5,5	Getr.Öl ATF E-S	f	Spezialprodukt		f	3,3	Getr.Öl BS LSX 75W-140	gjm	25
F-250/350/450/550 5.4 V8, 4x4	'08-'10	6,6							5,5	Spezialprodukt	f	Spezialprodukt		f	3,3	Getr.Öl BS LSX 75W-140	gjm	25,3
F-250/350/450/550 6.2 V8, 4x4	'11-	6,6							-	-		Spezialprodukt			3,3	Getr.Öl BS LSX 75W-140	gjm	20,2
F-250/350/450/550 6.8 V10, 4x4	'98-'04	6,6	●			●		●	5,5	Getr.Öl ATF E-S	h	Spezialprodukt		h	4-6,6		jim	26
F-250/350/450/550 6.8 V10, 4x4	'04-'08	6,6							5,5	Getr.Öl ATF E-S	h	Spezialprodukt		h	3,3	Getr.Öl BS LSX 75W-140	gjm	25,3
F-250/350/450/550 6.8 V10, 4x4	'08-'10	6,6							5,5	Spezialprodukt	h	Spezialprodukt		h	3,3	Getr.Öl BS LSX 75W-140	gjm	25,3
F-250/350/450/550 6.8 V10, 4x4	'11-	6,6							-	-		Spezialprodukt		h	3,3	Getr.Öl BS LSX 75W-140	gjm	25,3
<b>Diesel</b>																		
F-250/350/450/550 6.0 TD, 4x4	'03-'06	14,2		●				●	5,5	Getr.Öl ATF E-S	f	Spezialprodukt		f	4-6,6		jim	26
F-250/350/450/550 6.4 TD, 4x4	'08-'10	14,2							5,5	Getriebeöl SNS 75W-80	h	Spezialprodukt		h	3,3	Getr.Öl BS LSX 75W-140	gjm	28
F-250/350/450/550 6.7 TD, 4x4	'11-	12,4							-	-		Spezialprodukt		h	3,3	Getr.Öl BS LSX 75W-140	gjm	27,8
F-250/350/450/550 7.3 TD, 4x4	'98-'03	14,2		●				●	5,5	Getr.Öl ATF E-S	j	Spezialprodukt		j	3,3-6,6		gjlm	31

a 5-Gang Getriebe Mitsubishi: 2,3 | Getriebeöl SNS 75W-80; Getr.Öl EP Synth 75W-90

c Differential vorne: 1,7 | Getriebeöl BS 75W-90

e Differentiale, vorn und hinten

g Sperrdifferential: Getr.Öl BS LSX 75W-140

j Differential vorne: Getriebeöl HYP 85W-90

k Visteon 8.8/9.75: 2,6-2,7 | Getr.Öl HYP LS 85W-90; Getr.Öl BS LSX 75W-140; Differential, konventionell Hinterachse Dana M60 (2,8 I), M70FF (3,1 I), M70HD (4,3 I); Getr.Öl BS LSX 75W-140; Hinterachsgetriebe, Ausgleichgetriebe mit begrenztem Schlupf Dana M60 (2,8 I), M70FF (3,1 I), M70HD (4,3 I);

Getr.Öl BS LSX 75W-140, Getr.Öl HYP LS 85W-90

m Hinterachsgetriebe, Ausgleichgetriebe mit begrenztem Schlupf Dana M60, 4.10: 1,2, 8 | Getr.Öl BS LSX 75W-140

n Automatikgetriebe 4R100 Getr.Öl ATF E-S; Getriebeöl ATF 55; Automatikgetriebe 4R75E Spezialprodukt, bitte auf Originalersatzteil des Herstellers zurückgreifen!; Automatikgetriebe TorqShift Spezialprodukt, bitte auf Originalersatzteil des Herstellers zurückgreifen!

b Verteilergetriebe: 1,2-3,1 | Getr.Öl ATF E-S; Getriebeöl ATF 55

d Sperrdifferential: Getr.Öl HYP LS 85W-90

f Verteilergetriebe: 1,9 | Getr.Öl ATF E-S; Getriebeöl ATF 55

h Verteilergetriebe: Getriebeöl ATF 55; Getriebeöl ATF 22

l Differential, hinten Dana S110/S130: 6,6 | Getr.Öl BS LSX 75W-140; Differential, konventionell Hinterachse Dana M80: 4 | Getriebeöl BS 75W-90

**HYUNDAI**

H 100 / Sattelitte 2.4	'93-'00	3,9		●				●	2	Getr.Öl SNS-A 75W-85		Getr.Öl ATF E-S			1,2-2,6	Getriebeöl BS 75W-90		7
H 200 / H-1 / Starex 2.4	'97-'03	3,9		●				●	2	Getr.Öl SNS-A 75W-85		Getr.Öl ATF E-S			1,2	Getriebeöl BS 75W-90		7
H 200 / H-1 / Starex 2.4	'03-'05	4,3		●				●	2-2,4	Getr.Öl SNS-A 75W-85		Getr.Öl ATF E-S			2,6	Getriebeöl BS 75W-90		7,2-13
H 200 / H-1 / Starex 2.4	'05-'07	4,3		●				●	2-2,4	Getr.Öl SNS-A 75W-85		Getr.Öl ATF E-S			2,6	Getriebeöl BS 75W-90		7,2-13
H 300 / H-1 / Grand Starex 2.4 MPI	'07-'09	4,3-4,4		●				●	1,95	Getr.Öl SNS-A 75W-85		Getr.Öl ATF E-S	Getriebeöl ATF 55		1,8-2,4	Getriebeöl BS 75W-90		7,1-10,2
H 300 / H-1 / Grand Starex 2.4 MPI	'09-	5,1		●					1,95	Getr.Öl SNS-A 75W-85		Getr.Öl ATF E-S	Getriebeöl ATF 55		1,8-2,4	Getriebeöl BS 75W-90		7,1-10,2

<b>Diesel</b>																	
H 100/150/200 2.5 D	'93-'00	4,9-5,4		●				●	●	2	Getr.Öl SNS-A 75W-85		Getr.Öl ATF E-S		1,2-1,6	Getriebeöl BS 75W-90	8,5-9,5
H 100/150/200 2.5 TD, H150 Pick-up	'97-'03	5,4		●				●	●	2	Getr.Öl SNS-A 75W-85		Getr.Öl ATF E-S		1,2-1,6	Getriebeöl BS 75W-90	8,5-9
H 100 2.5 TCI, 2.5 CRDi WGT, 2.6 D	'10-	5,7/7,4		●				●		1,95-2,4	Getr.Öl SNS-A 75W-85		-		1,5-1,7	Getriebeöl BS 75W-90	8
H 200 / H-1 / Starex 2.5 TCI	'01-'03	6,1		●				●	●	2,4	Getr.Öl SNS-B 75W-80		Getr.Öl ATF E-S	Getriebeöl ATF 55	1,2	Getriebeöl BS 75W-90	7
H 200 / H-1 / Starex 2.5 TCI, 2.6 D, AWD	'03-'07	5,4-6,1		●				●	●	2-2,4	Getr.Öl SNS-B 75W-80	a	Getr.Öl ATF E-S		a 2,6	Getriebeöl BS 75W-90	7,2-13
H 200 / H-1 / Starex 2.5 CRDi, AWD	'02-'07	7,4		●				●	●	3,2	Getr.Öl SNS-A 75W-85	a	Getr.Öl ATF E-S		a 2,6	Getriebeöl BS 75W-90	7,2-13
H 300 / H-1 / Grand Starex 2.5 CRDi WGT	'07-	7,4		●				●		3-3,2	Getr.Öl SNS-A 75W-85		Getriebeöl ATF 55	Getriebeöl ATF J	1,8-2,4	Getriebeöl BS 75W-90	10-13
H 300 / H-1 / Grand Starex 2.5 CRDi VGT	'07-	7,4		●				●		3-3,2	Getr.Öl SNS-A 75W-85		Getriebeöl ATF 55	Getriebeöl ATF J	1,8-2,4	Getriebeöl BS 75W-90	10-13
Maxivan 2.5 D	'94-'00	4,9		●				●	●	2	Getr.Öl SNS-B 75W-80		Getr.Öl ATF E-S	Getriebeöl ATF 55	1,2-1,5	Getriebeöl BS 75W-90	8,5-9,5
H 350/600 3.3 TD	'94-'97	8,5		●				●	●	3,4-4,0	Getriebeöl EP 80W		-		2,7	Getriebeöl BS 75W-90	14-16

a Verteilergetriebe: Getr.Öl ATF E-S

## ISUZU

Rodeo/D-max 2.4 RWD/AWD	'03-'06	-	●	●		●			●	-	SuperTronic G 0W-30		-		-	Getriebeöl BS 75W-90	abc -
Rodeo/D-max 3.5 V6 RWD/AWD	'03-'06	-	●	●		●			●	-	SuperTronic G 0W-30		-		-	Getriebeöl BS 75W-90	abc -
<b>Diesel</b>																	
Rodeo/D-max 2.5 Turbo/Turbo Intercooler RWD/AWD	'03-'06	-	●	●		●		●	●	-	SuperTronic G 0W-30		-		-	Getriebeöl BS 75W-90	abc -
Rodeo/D-max 3,0 Turbo Intercooler AWD	'03-'06	-	●	●		●		●	●	-	SuperTronic G 0W-30		Getr.Öl ATF E-S	Getriebeöl ATF 55	-	Getriebeöl BS 75W-90	abc -
NKR85	'06-	-		●		●		●	●	-	SuperTronic G 0W-30		-		-	Getriebeöl BS 75W-90	-
NPR85	'06-	-		●		●		●	●	-	BlueTronic G 10W-40		-		-	Getriebeöl BS 75W-90	-

a Sperrdifferential: Getr.Öl HYP LS 85W-90; Getr.Öl BS LSX 75W-140

b Differential vorne: 1,7 l Getriebeöl BS 75W-90; Getriebeöl SNA-C 75W-90

c Verteilergetriebe: SuperTronic G 0W-30; HighTronic M 5W-40

## IVECO

<b>Diesel</b>																	
Massif 3.0 HPI Euro 4, 3.0 HPT Euro 4	'08-'11	-								-	Getr.Öl EP Synth 75W-90	b	-		-	Getriebeöl BS 75W-90	a -
Daily 29, 35, 40, 50, 65	'99-'02	6,3								2	MultiTurboral 15W-40 ; PlusTurboral 15W-40; Turboral 15W-40		-		1,8	Getriebeöl BS 75W-90	9
Daily (29, 35, 40) -10, -12	'02-'04	5,5								2	SuperTurboral 5W-30; PlusTurboral 15W-40; Turboral 15W-40		-		1,85	Getr.Öl SNA-B 80W-140	9
Daily (29, 35, 40, 50, 65) -13, -15	'02-'04	6,5		●				●		2,7	Getr.Öl EP Synth 75W-90		-		1,85	Getr.Öl SNA-B 80W-140	9
Daily (29, 35, 40) -10, -12	'05-'06	5,7								2	SuperTurboral 5W-30; PlusTurboral 15W-40; Turboral 15W-40		-		1,8-1,9	Getriebeöl BS 75W-90	9
Daily (29, 35, 40, 50, 65) -14, -17	'05-'06	7,6								2-2,2	SuperTurboral 5W-30; PlusTurboral 15W-40; Turboral 15W-40		-		1,9/3	Getriebeöl BS 75W-90	9
Daily (29 L, 35 C, 35 S) -10, -12, D, P, V, SV	'06-'09	5,7								2	SuperTurboral 5W-30; MegaTurboral S 10W-40; SuperTronic E 0W-30		-		1,9	Getriebeöl BS 75W-90	9
Daily (29 L) -10 D, -12 D, (40 C) -10, -12, D, P, V	'06-'09	5,7								2	SuperTurboral 5W-30; MegaTurboral S 10W-40; SuperTronic E 0W-30		-		1,9	Getriebeöl BS 75W-90	9
Daily (29 L, 35 C, S) -14, P, V, SV	'06-'09	5,7								2	SuperTronic E 0W-30; HighTronic F 5W-30		-		1,9	Getriebeöl BS 75W-90	9
Daily (29 L, 35 C, S) -14 D	'06-'09	5,7								2	SuperTronic E 0W-30; HighTronic F 5W-30		-		1,9	Getriebeöl BS 75W-90	9
Daily (35 C, S, 40 C, 50 C) -15, D, P, V	'06-'09	7,6								2,2	SuperTronic E 0W-30; HighTronic F 5W-30		-		1,9	Getriebeöl BS 75W-90	9
Daily (35 C, S, 40 C, 50 C) -18, D, P, V	'06-'09	7,6								2,2	SuperTronic E 0W-30; HighTronic F 5W-30		-		1,9	Getriebeöl BS 75W-90	9
Daily (65 C) -15, D, V	'06-'09	7,6								2,2	SuperTurboral 5W-30; MegaTurboral S 10W-40; SuperTronic E 0W-30		-		3	Getriebeöl BS 75W-90	9
Daily (65 C) -18, D, V	'06-'09	7,6								2,2	SuperTronic E 0W-30; HighTronic F 5W-30		-		3	Getriebeöl BS 75W-90	9
Daily (29 L, 35 C, 35 S) -10, -12, D, P, V, SV	'09-'11	5,7								2	Hightronic J 5W-30		-		1,9	Getriebeöl BS 75W-90	9
Daily (29 L) -10 D, -12 D, (40 C) -10, -12, D, P, V	'09-'11	5,7								2	Hightronic J 5W-30		-		1,9	Getriebeöl BS 75W-90	9
Daily (29 L, 35 C, S) -14, P, V, SV	'09-'11	5,7								2	Hightronic J 5W-30		-		1,9	Getriebeöl BS 75W-90	9
Daily (29 L, 35 C, S) -14 D	'09-'11	5,7								2	SuperTronic E 0W-30; HighTronic F 5W-30		-		1,9	Getriebeöl BS 75W-90	9
Daily (29 L, 35 C, 35 S) 11, -13, V, L, SV	'11-	-								-	Hightronic J 5W-30		Spezialprodukt		-	Getr.Öl SNA-B 80W-140	-
Daily (35 C, 35 S) 15, 17, 21, L, -SV, -V	'11-	-								-	Hightronic J 5W-30		Spezialprodukt		-	Getr.Öl SNA-B 80W-140	-
Daily (50 C, 60 C, 65 C, 70 C) 15, 17, 21 L, -V	'11-	-								-	Hightronic J 5W-30		Spezialprodukt		-	Getr.Öl SNA-B 80W-140	-
Scam SM(T) 35/4, 55/4 -Euro 3	'05-'09	-								-	SuperTronic E 0W-30; HighTronic F 5W-30		Spezialprodukt	c	-	Getr.Öl SNA-B 80W-140	ad -
<b>CNG</b>																	
Daily CNG	'98-'05	7		●				●	●	1,5	Getriebeöl EP 85W-90		-		1,9	Getr.Öl SNA-B 80W-140	7-14
Daily Bi-Fuel 35 S 14G	'09-'11	-								-	SuperTronic E 0W-30; HighTronic F 5W-30		-		-	Getr.Öl SNA-B 80W-140	-
Daily Bi-Fuel 35, 50, 60, 65 C, S -14G, GV	'11-	-								-	SuperTronic E 0W-30; HighTronic F 5W-30		-		-	Getr.Öl SNA-B 80W-140	-

a Differentiale, vorn und hinten

b Verteilergetriebe: Getriebeöl BS 75W-90; Getriebeöl SNA-C 75W-90

c Verteilergetriebe: Getriebeöl BS 75W-90

d Hydraulische Betätigung Differentialsperre: Spezialprodukt, bitte auf Originalersatzteil des Herstellers zurückgreifen!

			SuperTronic			HighTronic			Blue Tronic	ℓ	Aral	⚠	Aral		⚠	ℓ	Aral	⚠	ℓ
			G 0W-30	0W-40	LL III 5W-30	M 5W-40	5W-40	G 5W-30	10W-40				Synthese	Mineral					
<b>KIA</b>																			
<i>Diesel</i>																			
Pregio 2.5 TCI	'02-'05	5						●	2,4	Getr.Öl SNS-B 75W-80	-				1,3	Getriebeöl BS 75W-90		9	
Pregio 2.5 TCI	'05-	6,1	●					●	2,4	Getr.Öl SNS-A 75W-85	-				1,7	Getriebeöl BS 75W-90		8	
Pregio 2.7 D	'97-'02	7						●	2,2	Getr.Öl SNS-B 75W-80	-				1,3	Getriebeöl BS 75W-90		9,5	
Pregio 2.7 D, 3.0 D	'05-	6,4	●					●	2,2	Getr.Öl SNS-A 75W-85	-				1,3	Getriebeöl BS 75W-90		9,5-10	
Ceres 2.4 D	'97-'02	6						●	2,2	Getr.Öl SNS-B 75W-80	-				1,3	Getriebeöl BS 75W-90		9,5	
K 2700, K3600	'97-'04	7,4-7,9						●	2,2	Getr.Öl SNS-B 75W-80	-				1,2	Getriebeöl BS 75W-90		9,5	
K 2500	'02-'04	5						●	2,2	Getr.Öl SNS-B 75W-80	-				1,2	Getriebeöl BS 75W-90		9	
K 2500 TCI, K2700, K3000	'04-	6,1-7,4	●					●	2,2-2,4	Getr.Öl SNS-A 75W-85	-				1,7	Getriebeöl BS 75W-90		8	
<b>LDV</b>																			
Cub 1.6 16V	'95-'98	2,9		●		●		●	2,1	Getr.Öl SNS-B 75W-80	-				1,3	Getriebeöl HYP LS 85W-90		9	
Pilot, V200 2.0	'89-	4,3				●		●	2,1	Spezialprodukt	-				1,9	Getriebeöl BS 75W-90		5,8	
Convoy, V400 (L4)	'89-	4,3		●		●		●	-	Spezialprodukt	a			1,7/2,4	Getriebeöl BS 75W-90		6/7		
Convoy, V400 (V8 3.5)	'89-'99	5,5				●		●	-	Getr.Öl ATF E-S	-			-	Getriebeöl BS 75W-90		9,7		
Convoy, V400 2.0 LPG	'00-	4,4	SuperTronic E 0W-30; HighTronic F 5W-30							1,3	Getriebeöl SNS 75W-80	-			2,4	Getriebeöl HYP LS 85W-90		9,3	
<i>Diesel</i>																			
Pilot 1.9d City van (DW8)	'02-'02.5	4,8	●	●				●	2,4	Getriebeöl SNS 75W-80	c				1,9	Getriebeöl BS 75W-90		10,6	
Pilot 1.9d City van (DW8)	'02.5-	4,8	●	●				●	2,4	Getriebeöl SNS 75W-80	-				1,9	Getriebeöl HYP LS 85W-90		10,6	
Convoy 2.5 Di/TDi, V400	'97-'01	7		●				●	1,3	Getriebeöl SNS 75W-80	b				2,4	Getriebeöl BS 75W-90		11	
Convoy 2.4 dt/dti (Duratorq dt75/dti90)	'01-	7	HighTronic F 5W-30							1,8	Getriebeöl SNS 75W-80	-			1,7	Getriebeöl HYP LS 85W-90		10	
Cub 2.3 D	'98-'01	5,7		●				●	2,1	Getr.Öl EP Synth 75W-90	-				1,3	Getriebeöl BS 75W-90		11,3	
LD100 CRD Combi/Van 70kW/88kW	'05-	6,5		●				●	2,4	Getr.Öl SNS-B 75W-80	-				↔	↔		11	
Maxus Combi/Van 70kW/88kW	'05-	6,5		●				●	2,4	Getr.Öl SNS-B 75W-80	-				↔	↔		11	
a Getriebe Ford MT75: 1,2   Getriebeöl SNS 75W-80										b Getriebe P 5100: 1,6   HighTronic M 5W-40; BlueTronic 10W-40									
c Getriebe R 380L: 1,6   Getriebeöl SNS 75W-80																			
<b>MAZDA</b>																			
B 2600, 4x4	'85-'06	4,7		●		●		●	2-3,2	Getriebeöl BS 75W-90	d				1,2-1,85	Getriebeöl BS 75W-90	a	6,9-7,5	
E 1800, E 2000	'84-'06	3,6		●		●		●	1,7-2,5	Getriebeöl BS 75W-90	-				1,3	Getriebeöl BS 75W-90		6,6/7	
E 2000, 4x4	'87-'06	3,6		●		●		●	1,7-2,5	Getriebeöl BS 75W-90	b				1,2/1,3	Getriebeöl BS 75W-90	c	6,6-7,5	
<i>Diesel</i>																			
B 2500 D, DT	'97-'06	6,3						●	2-2,8	Getriebeöl BS 75W-90	-				1,3-1,4	Getriebeöl BS LSX 75W-140		8,8-9,4	
B 2500 4WD	'97-'06	6,3						●	2,5-3,2	Getriebeöl BS 75W-90	d				1,2/1,85	Getriebeöl Hyp 80W	a	8,8-9,4	
B 2600 D 4x4	'92-'06	5,8						●	2,5	Getriebeöl BS 75W-90	b				1,2/1,3	Getriebeöl BS 75W-90	c	7,5	
E 2200 D	'84-'99	5,4						●	2,5	Getriebeöl BS 75W-90	-				1,2/1,3	Getriebeöl BS 75W-90		9	
E 2200 D	'99-'06	6,4						●	2,5	Getriebeöl BS 75W-90	-				1,2	Getriebeöl BS 75W-90		7,5	
BT-50 2.5, 3.0 CDVi	'06-'11	7	●	●				●	3,6	Spezialprodukt					1,8-3	Getriebeöl BS 75W-90	c	8,8-9,4	
BT-50 2.2 TDCi, 3.2 TDCi, 4x4	'11-	8,6-9,75	SuperTronic E 0W-30; HighTronic F 5W-30							2,7	Spezialprodukt	e			e	2,8-3	Getriebeöl BS LSX 75W-140	f	11,5-13,3
a Differential, hinten: 1,7-1,85   Getriebeöl BS 75W-90; Getriebeöl SNA-C 75W-90										b Verteilergetriebe (4WD): 1,6   Getriebeöl BS 75W-90; Getriebeöl SNA-C 75W-90									
c Differentiale, vorn und hinten; Sperrdifferential: Getr.Öl BS LSX 75W-140, Getr.Öl HYP LS 85W-90										d Verteilergetriebe (4WD): 2,0   Getriebeöl BS 75W-90; Getriebeöl SNA-C 75W-90									
e Verteilergetriebe (4WD): Spezialprodukt, bitte auf Originalersatzteil des Herstellers zurückgreifen!										f Differential vorne: Getriebeöl BS 75W-90; Getriebeöl SNA-C 75W-90									



## MERCEDES-BENZ

Vito 113, V230 (M 111)	'95-'99	7,9	●	●	●	●	●	●	2	Getriebeöl EP 80W		Getr.Öl ATF E-S			↔	↔	9	
Vito 113 (M 111)	'99-'03	7,5	●	●	●	●	●	●	2,2	Getr.Öl SNS-B 75W-80		Getr.Öl ATF E-S			↔	↔	8,7	
V230, V280	'99-'03	6,4-8,9	●	●	●	●	●	●	2,2	Getr.Öl SNS-B 75W-80		Getr.Öl ATF E-S			↔	↔	6-12,5	
Vito 119, 122, 123, 126	'03-'	10	●	●	●	●	●	●	1,2-1,5	Getr.Öl SNS-B 75W-80			Getr.Öl ATF M 14	1,3-1,5	Getr.Öl BS LSX 75W-140	b	8,1-10	
Viano 3.0, 3.2, 3.5	'03-'	10	●	●	●	●	●	●	1,2-1,5	Getr.Öl SNS-B 75W-80			Getr.Öl ATF M 14	1,3	Getr.Öl BS LSX 75W-140		8,1-9,9	
Sprinter 214, 314, 414 (M 111)	'94-'06	8,9	●	●	●	●	●	●	2,2	Getr.Öl SNS-B 75W-80	d		Getr.Öl ATF M 14	1,5-1,8	Getriebeöl SNA-C 75W-90		6	
Sprinter 216, 316, NGT, LNG (M 271)	'10-'	8	●	●	●	●	●	●	1,5-2,6	Getr.Öl SNS-B 75W-80			Getr.Öl ATF M 14	1,6-2,8	Getriebeöl SNA-C 75W-90		7	
Sprinter 224, 324, 424, 524 (M 272)	'10-'	9,5	●	●	●	●	●	●	-	-			Getr.Öl ATF M 14	1,6-2,8	Getriebeöl SNA-C 75W-90		7	
<b>Diesel</b>																		
Vito 108 D, 110 D, V230 TD (OM 601, LA)	'95-'99	9,5	●	●	●	●	●	●	2	Getriebeöl EP 80W		Getr.Öl ATF E-S			↔	↔	9	
Vito 108/110/112 CDI, V200, 220 CDI (OM 611)	'99-'03	7,5	●	●	●	●	●	●	1,8	Getr.Öl SNS-B 75W-80		Getr.Öl ATF E-S			↔	↔	11	
Vito 109/111/115 CDI, Viano 2.0/2.2 CDI (OM 646)	'03-'10	8,5-9	●	●	●	●	●	●	1,2-1,5	Getr.Öl SNS-B 75W-80			Getr.Öl ATF M 14	1,3	Getr.Öl BS LSX 75W-140	b	8,6-10,5	
Vito 109/111/115 CDI, 4x4, Viano 2.0/2.2 CDI, 4x4 (OM 646) DPF	'05-'10	8,5-9	●	●	●	●	●	●	1,2-1,5	Getr.Öl SNS-B 75W-80	e		Getr.Öl ATF M 14	e	1,3	Getr.Öl BS LSX 75W-140	ab	8,6-10,5
Vito 110/113/116 CDI, Viano 2.0/2.2 CDI (OM 651)	'10-'	9	●	●	●	●	●	●	1,2-1,5	Getr.Öl SNS-B 75W-80			Getr.Öl ATF M 14	e	1,5	Getr.Öl BS LSX 75W-140		-
Vito 110/113/116 CDI, 4x4, Viano 2.0/2.2 CDI, 4x4 (OM 651) DPF	'10-'	9	●	●	●	●	●	●	1,2-1,5	Getr.Öl SNS-B 75W-80	e		Getr.Öl ATF M 14	e	1,5	Getr.Öl BS LSX 75W-140	a	-
Vito 120 CDI, Viano 3.0 CDI (OM 642) DPF	'06-'10	10	●	●	●	●	●	●	1,2-1,5	Getr.Öl SNS-B 75W-80			Getr.Öl ATF M 14	1,3	Getr.Öl BS LSX 75W-140	b	9,9-11,4	
Vito 122 CDI, Viano 3.0 CDI (OM 642) DPF	'10-'	10	●	●	●	●	●	●	1,2-1,5	Getr.Öl SNS-B 75W-80			Getr.Öl ATF M 14	1,5	Getr.Öl BS LSX 75W-140		-	
Sprinter 208 D, 308 D, 408 D (OM 601)	'94-'00	9,5	●	●	●	●	●	●	1,8	Getr.Öl SNS-B 75W-80		Getr.Öl ATF E-S	Getriebeöl ATF-LD	1,8	Getriebeöl SNA-C 75W-90		7	
Sprinter 210 D, 310 D, 410 D (OM 602)	'94-'00	9,5	●	●	●	●	●	●	2,2	Getr.Öl SNS-B 75W-80	d	Getr.Öl ATF E-S	Getriebeöl ATF-LD	1,8	Getriebeöl SNA-C 75W-90		7,5	
Sprinter 212 D, 312 D, 412 D, 512 D (OM 602)	'94-'00	9,5	●	●	●	●	●	●	2,2	Getr.Öl SNS-B 75W-80	d	Getr.Öl ATF E-S	Getriebeöl ATF-LD	1,8	Getriebeöl SNA-C 75W-90		7,5	
Sprinter CDI	'00-'06	7,5-9	●	●	●	●	●	●	1,6-1,7	Getr.Öl SNS-B 75W-80	d	Getr.Öl ATF E-S	Getriebeöl ATF-LD	1,5/1,8	Getriebeöl SNA-C 75W-90		9,5-11,1	
Sprinter CDI SPRINTSHIFT	'00-'06	7,5-8,5	●	●	●	●	●	●	1,5	Getr.Öl SNS-B 75W-80	c	-		1,5/1,8	Getriebeöl SNA-C 75W-90		9,5-11,1	
Sprinter CDI	'06-'08	11	●	●	●	●	●	●	1,5-2	Getr.Öl SNS-B 75W-80			Getr.Öl ATF M 14	2,6	Getriebeöl SNA-C 75W-90		9,5-10	
Sprinter CDI, 4x4	'09-'	11,5-12,5	●	●	●	●	●	●	1,5-2,6	Getr.Öl SNS-B 75W-80	e		Getr.Öl ATF M 14	e	1,6-2,8	Getriebeöl SNA-C 75W-90	a	10

a Differential vorne: Getriebeöl SNA-C 75W-90; Getriebeöl SNA-E 75W-90

c Hydraulikanlage Sprintshift 0,51 Spezialprodukt, bitte auf Originalersatzteil des Herstellers zurückgreifen!

e Verteilerge triebe: Getr.Öl ATF M 14; Getr.Öl ATF M 12

b Differential hinten

d Mit Nebenantrieb: 2,6l Getr.Öl SNS-B 75W-80; Getriebeöl SNS 75W-80

## MITSUBISHI

L 200 2.0i	'97-'06	4	●	●	●	●	●	●	2,3	Getr.Öl SNS-A 75W-85		Getr.Öl ATF E-S	Getriebeöl ATF 55	1,6/2,6	Getriebeöl BS 75W-90	c	6,7
L 200 2.4, 4x4	'97-'06	4	●	●	●	●	●	●	2,2	Getr.Öl SNS-A 75W-85	b	-		0,9/2,6	Getriebeöl BS 75W-90	ac	7
L 300 2.0, 2.0 16V, 2.4, 2.4 16V	'96-'	4	●	●	●	●	●	●	2	Getr.Öl SNS-A 75W-85	b	-		1,1/1,8	Getriebeöl BS 75W-90	ac	7,3
L 400 2.0i, 2.4	'97-'01	4	●	●	●	●	●	●	2,3	Getr.Öl SNS-A 75W-85	b	-		1,2	Getriebeöl BS 75W-90	c	8
<b>Diesel</b>																	
L 200 2.5 D	'97-'06	5	●	●	●	●	●	●	2,3	Getr.Öl SNS-A 75W-85		-		1,6/2,6	Getriebeöl BS 75W-90	ac	7
L 200 2.5 TDi, 4x4	'97-'06	5,3	●	●	●	●	●	●	2,2	Getr.Öl SNS-A 75W-85	b	Getr.Öl ATF E-S	Getriebeöl ATF 55	0,9/2,6	Getriebeöl BS 75W-90	ac	7,1
L 300 2.5 D, 2.5 TDi, 4x4	'96-'	5,5	●	●	●	●	●	●	2	Getr.Öl SNS-A 75W-85	b	-		1,1/1,8	Getriebeöl BS 75W-90	ac	8,7
L 400 2.5 TDi, 4x4	'97-'01	5,5	●	●	●	●	●	●	2,2/3,7	Getr.Öl SNS-A 75W-85	b	-		0,9/1,8	Getriebeöl BS 75W-90	ac	9
Canter FB 35 2.8 D (FB 631)	'97-'01	7	●	●	●	●	●	●	3,1	Getriebeöl SNS 75W-80		-		2,2	Getriebeöl BS 75W-90	c	10
Canter FE 35 3.9 TD (FE 649)	'97-'01	9	●	●	●	●	●	●	3,1	Getriebeöl SNS 75W-80		-		4,5	Getriebeöl BS 75W-90	c	13
Canter FE 63 Ti (FE 649), FE 75 Ti (FE 659)	'96-'01	9	●	●	●	●	●	●	3,1	Getriebeöl SNS 75W-80		-		4,5	Getriebeöl BS 75W-90	c	13
Canter FB 634, FE 534	'01-'06	7,5	●	●	●	●	●	●	3,8	Getriebeöl SNS 75W-80		-		2,2	Getriebeöl BS 75W-90		11
Canter FE 649, FE 659	'01-'06	9,0	●	●	●	●	●	●	4,4	Getriebeöl SNS 75W-80		-		4,5	Getriebeöl BS 75W-90		13

a Differentiale, vorn und hinten

c Sperrdifferential: Getr.Öl HYP LS 85W-90

b Verteilerge triebe (4WD): 2,2-2,6 l : Getr.Öl SNS-B 75W-80; Getriebeöl SNS 75W-80

## NISSAN

Q-bic 1.6	'92-'96	3,2/3,4	●	●	●	●	●	●	2,8-3,7	Getr.Öl SNS-B 75W-80		Getr.Öl ATF E-S	Getriebeöl ATF 55	↔	↔		5,5-7	
King Cab, Pick-up 2.0, 2.4, 4x4 (D21)	'85-'97	3,8-4,3	●	●	●	●	●	●	1,7-4	Getr.Öl SNS-B 75W-80	b	Getr.Öl ATF E-S	Getriebeöl ATF 55	1,3-2,8	Getriebeöl BS 75W-90	c	6,7-8,2	
King Cab, Pick-up 2.4, 4x4	'97-'02	3,9	●	●	●	●	●	●	2	Getr.Öl SNS-B 75W-80	b	-		1,3	Getr.Öl HYP LS 85W-90	e	6,7	
King Cab, Pick-up, Navara 2.4, 4x4	'02-'07	4,1	●	●	●	●	●	●	4,9	Getr.Öl SNS-A 75W-85	b	-		1,3	Getr.Öl HYP LS 85W-90	e	6,9	
Vanette, Vanette Cargo 1.6, 2.4 (C220)	'95-'02	3,1/4,1	●	●	●	●	●	●	1,2/2	Getr.Öl SNS-B 75W-80		Getr.Öl ATF E-S	Getriebeöl ATF 55	1	Getriebeöl BS 75W-90		5/9	
Vanette 1.6 (GA16DE)	'96-'02	2,9	●	●	●	●	●	●	2,1	Getr.Öl SNS-B 75W-80		-		1,3	Getriebeöl BS 75W-90		9	
NV200 1.6	'09-'	4,3	●	●	●	●	●	●	2,3	Spezialprodukt		-		↔	↔		6,8	
Patrol 5.6 V8	'10-'	6,5	●	●	●	●	●	●	-	-			Getriebeöl ATF J	a	2,3	Getriebeöl BS 75W-90	e	9,2-11
Urvan 2.0, 2.4 (E24)	'87-'01	4,5	●	●	●	●	●	●	2	Getr.Öl SNS-B 75W-80		Getr.Öl ATF E-S	Getriebeöl ATF 55	1,3	Getriebeöl BS 75W-90		10,5/11	

			SuperTronic						HighTronic			Blue Tronic 10W-40	4H	Aral		Aral		Aral	Aral
			G 0W-30	0W-40	LL III 5W-30	M 5W-40	5W-40	G 5W-30	Synthese	Mineral									
											⚠			⚠					
<b>NISSAN</b>																			
Cabstar 2.0 (F23)	'93-'02	3,8		●		●			●	2	Getr.Öl SNS-B 75W-80	-		1,3/2	Getriebeöl BS 75W-90		8,8-9,8		
Kubistar 1.2, 1.6 16V	'03-	3,7/3,9	●	●		●			●	3,4	Getr.Öl EP Synth 75W-90	Getr.Öl ATF E-S	Getriebeöl ATF 55	↔	↔		5/7,9		
Primastar 2.0 16V	'02-'07	5,25	●	●		●			●	2,7	Getr.Öl EP Synth 75W-90	-		↔	↔		5,4		
Primastar 2.0 16V	'07-'11	5,4	●	●		●			●	2,7	Getr.Öl EP Synth 75W-90	-		↔	↔		6,5		
<b>Diesel</b>																			
Q-bic 1.7 D	'92-'96	3,8						●	●	2,8-3,7	Getr.Öl SNS-B 75W-80	-		↔	↔		6,5		
Terrano II 2.7 TD	'00-	6,2		●		●			●	3,5	Getr.Öl SNS-B 75W-80	-		2,8	Getr.Öl HYP LS 85W-90	e	10		
King Cab, Pick-up 2.5 D, 4x4 (D21)	'85-'97	6				●			●	2,1	Getr.Öl SNS-B 75W-80	b		1,3-2	Getriebeöl BS 75W-90	c	8		
King Cab 2.5 D, 4x4 (D21)	'90-'97	6				●			●	2/4	Getr.Öl SNS-B 75W-80	b		1,3-2,8	Getriebeöl BS 75W-90	d	10,5		
Pick-up 2.5 TD 2wd/4wd, 2.5 TD (Ti) 2wd/4wd	'98-'02	7,2				●			●	2/4,9	Getr.Öl SNS-B 75W-80	b		1,3	Getriebeöl BS 75W-90	e	10,6		
Pick-up 2.5 DiTD 2wd	'02-'07	5,3		●		●			●	2-2,8	Getr.Öl SNS-A 75W-85	-		1,3	Getriebeöl BS 75W-90		8,6		
Pick-up 2.5 DiTD 4wd	'02-'07	4		●		●			●	4,9/5,1	Getr.Öl SNS-A 75W-85	b		1,3	Getriebeöl BS 75W-90	de	8,6		
NP300 Pickup 2.5 DDTI 4WD	'07-	4,3		●		●			●	5,1	Getr.Öl SNS-A 75W-85	b		1,3-2,8	Getriebeöl BS 75W-90	de	9,4		
Vanette, Vanette Cargo 2.3 D (C220)	'95-'01	5,9				●			●	2	Getr.Öl SNS-B 75W-80	-		1/1,3	Getriebeöl BS 75W-90		8-11		
Vanette 2.3 D (LD23) (C23)	'95-'01	5,7				●			●	2,1	Getr.Öl SNS-B 75W-80	-		1,5	Getriebeöl BS 75W-90		11,3		
NV200 1.5 dCi	'09-	4,4	HighTronic R 5W-30							2,3	Spezialprodukt	-		↔	↔		7,5		
Urvan 2.0 D, 2.5 D (E24)	'87-'01	5,9				●			●	2	Getr.Öl SNS-B 75W-80	Getr.Öl ATF E-S	Getriebeöl ATF 55	1,3	Getriebeöl BS 75W-90		13		
Cabstar 2.5, 2.7 (F23)	'93-'02	6,2				●			●	2,7	Getr.Öl SNS-B 75W-80	-		1,3/2	Getriebeöl BS 75W-90		13,8-15,3		
Cabstar E, 2.7 TD, 3.0 TDi	'02-'06	7,2		●		●			●	2/2,2	Getr.Öl SNS-B 75W-80	-		2/3	Getriebeöl BS 75W-90	d	10/15		
Cabstar 2.5, 3.0 dCi	'06-	7,1/9,5		●		●			●	2,2/2,7	Spezialprodukt	-		3-5,1	Getriebeöl BS 75W-90	d	9,8-13,2		
Trade 2.3 D, 3.0 TDi	'97-'01	7-7,5				●			●	1,7-2	Getr.Öl SNS-B 75W-80	-		2	Getriebeöl BS 75W-90	d	10/15		
Kubistar 1.5 dCi	'03-	5,5	●	●		●			●	3,4	Getr.Öl EP Synth 75W-90	-		↔	↔		5		
Primastar 1.9 dCi, 2.5 dCi	'02-'07	4,6/8	●	●		●			●	2,35-2,7	Getr.Öl EP Synth 75W-90	-		↔	↔		6,4-7		
Primastar 2.0 dCi	'07-	5,2-7,7	●	●		●			●	2,7	Getr.Öl EP Synth 75W-90	-		↔	↔		6,3		
Primastar 2.0 dCi DPF	'09-	7,7	●	●		●			●	2,7	Getr.Öl EP Synth 75W-90	-		↔	↔		6,3		
Primastar 2.5 dCi DPF	'07-'11	7,5	●	●		●			●	2,7	Getr.Öl EP Synth 75W-90	-		↔	↔		6,4		
Interstar 1.9 dCi, 2.2 CDI, 2.5 CDI, 3.0 dCi	'02-'06	4,8-8,3	●	●		●			●	1,95-2,6	Getr.Öl EP Synth 75W-90	-		↔	↔		9,5-11		
Interstar 2.5 dCi	'06-'10	8	●	●		●			●	2,7	Getr.Öl EP Synth 75W-90	Spezialprodukt		↔	↔		10		
Interstar 2.5 dCi DPF	'06-'10	8	●	●		●			●	2,7	Getr.Öl EP Synth 75W-90	Spezialprodukt		↔	↔		10		
NV400 2.3 dCi Euro 4, RWD	'10-	8,-8,9				●			●	2,7	Spezialprodukt	Spezialprodukt		2,7-3	Getriebeöl BS 75W-90		7,8-8,6		
NV400 2.3 dCi DPF Euro 5, RWD	'10-	8,-8,9	HighTronic R 5W-30							2,7	Spezialprodukt	Spezialprodukt		2,7-3	Getriebeöl BS 75W-90		7,8-8,6		
Navara 2.5 dCi	'05-'10	7,6		●		●			●	4-4,3	Getr.Öl SNS-A 75W-85	h	Getriebeöl ATF J	h	0,9/2	Getriebeöl BS 75W-90	fg	9,9-10,2	
Navara 2.5 dCi DPF	'07-'10	7,6		●		●			●	4-4,3	Getr.Öl SNS-A 75W-85	h	Getriebeöl ATF J	h	0,9/2	Getriebeöl BS 75W-90	fg	9,9-10,2	
Navara 2.5 dCi	'10-	6,9	●	●		●			●	4-4,3	Getr.Öl SNS-A 75W-85	h	Getriebeöl ATF J	h	2	Getr.Öl BS LSX 75W-140	de	10,1	
Navara 2.5 dCi DPF	'10-	6,9		●		●			●	4-4,3	Getr.Öl SNS-A 75W-85	h	Getriebeöl ATF J	h	2	Getr.Öl BS LSX 75W-140	de	10,1	
Navara 3.0 dCi V6	'10-	7,1	HighTronic R 5W-30							4-4,3	Getr.Öl SNS-A 75W-85	h	Getriebeöl ATF J	h	2	Getr.Öl BS LSX 75W-140	de	13,2	
<p>a Verteilergetriebe: Spezialprodukt, bitte auf Originalersatzteil des Herstellers zurückgreifen!</p> <p>c Differentiale, vorn und hinten; Sperrdifferential: Getr.Öl HYP LS 85W-90</p> <p>e Differential vorne: Getriebeöl BS 75W-90; Getriebeöl SNA-C 75W-90</p> <p>g Differentiale, vorn und hinten</p> <p>b Verteilergetriebe (4x4): 2,2 l Getr.Öl SNS-B 75W-80; Getriebeöl SNS 75W-80</p> <p>d Sperrdifferential: Getr.Öl HYP LS 85W-90</p> <p>f Sperrdifferential: Getr.Öl BS LSX 75W-140</p> <p>h Verteilergetriebe: 2 l Getriebeöl ATF J</p>																			
<b>OPEL</b>																			
Combo 1.2, 1.4	'92-'02	3/3,5				●			●	1,6	Getriebeöl SNS 75W-80	Getr.Öl ATF E-S	Getriebeöl ATF 55	↔	↔		5,5/6		
Combo C 1.6	'02-	3,5	●	●		●			●	1,6	Getriebeöl SNS 75W-80	-		↔	↔		5,8		
Campo 2.3, 4x4	'92-'99	3,5				●			●	1,6/4,4	SuperTronic 0W-40	-		1/1,5	Getriebeöl BS 75W-90	b	9		
Vivaro 2.0 16V	'01-	5,25	●	●		●			●	2,35	Getr.Öl EP Synth 75W-90	-		↔	↔		6		

<b>Diesel</b>															
Combo 1.7 D	'92-'01	4,5/5	●	●		●		●	1,6	Getriebeöl SNS 75W-80	-		↔	↔	7,5
Combo C 1.3 CDTi 51, 55 kW	'04-	3,2	●	●		●	●	1,6	Getr.Öl EP Synth 75W-90	-		↔	↔	6,3-6,7	
Combo C 1.7 DI 16V, 1.7 DTI 16V	'02-'04	4,5	●			●		1,6	Getr.Öl EP Synth 75W-90	-		↔	↔	7,1	
Combo C 1.7 DI 16V, 1.7 DTI 16V	'04-	4,5	●	●		●	●	1,6	Getr.Öl EP Synth 75W-90	-		↔	↔	6,1-7,1	
Campo 2.5 D, 2.5 TDi, 4x4	'92-'99	4,3				●		1,6/4,4	SuperTronic 0W-40	-		1/1,5	Getriebeöl BS 75W-90	b	7
Campo 3.1 TD, 4x4	'94-'99	4,3/6				●		3	SuperTronic 0W-40	a	-	1/1,5	Getriebeöl BS 75W-90	b	8,5
Vivaro 1.9 DI, 1.9 DTI	'01-	4,6				●	●	2,4	Getr.Öl EP Synth 75W-90	-		↔	↔	6,4	
Vivaro 2.0 CDTi (66 kW), 2.0 CDTi (84 kW)	'06-'09	6,6	●			●	●	2,6	Getr.Öl EP Synth 75W-90	c	-	↔	↔	-	
Vivaro 2.0 CDTi (66 kW), 2.0 CDTi (84 kW) DPF	'09-	7,7		●		●	●	2,6	Getr.Öl EP Synth 75W-90	c	-	↔	↔	-	
Vivaro 2.5 DTI, 2.5 DTI Tecshift	'03-'06	8				●	●	2,4-2,85	Getr.Öl EP Synth 75W-90	c	-	↔	↔	11	
Vivaro 2.5 CDTi	'06-'12	8	●			●	●	-	Getr.Öl EP Synth 75W-90	c	-	↔	↔	-	
Vivaro 2.5 CDTi DPF	'06-'12	8		●		●	●	-	Getr.Öl EP Synth 75W-90	c	-	↔	↔	-	
Arena 1.9 D, 2.5 D	'99-'99	5/6,5		●		●	●	-	Getriebeöl Hyp 80W	-	-	-	Getr.Öl SNA-B 80W-140		11
Movano 2.5 D	'00-'02	6,5		●		●	●	2,8	Getr.Öl EP Synth 75W-90	-		↔	↔	11	
Movano 1.9 DTI	'00-'04	4,8-5,5				●	●	2,4-2,8	Getr.Öl EP Synth 75W-90	-		↔	↔	11	
Movano 1.9 CDTi	'05-'06	4,6	●	●		●	●	2,3-2,6	Getr.Öl EP Synth 75W-90	-		↔	↔	9,5	
Movano 2.2 DTI, 2.8 DTI, 2.5 DTI	'00-'04	6,7-8,3				●	●	2,4-2,8	Getr.Öl EP Synth 75W-90	-		↔	↔	10-11	
Movano 2.2 CDTi, 2.5 CDTi, 2.5 CDTi Tecshift	'04-'06	8	●	●		●	●	2,3-2,65	Getr.Öl EP Synth 75W-90	c	-	↔	↔	10	
Movano 2.5 CDTi 100, 2.5 CDTi 120	'06-'10	8	●			●	●	8	Getr.Öl EP Synth 75W-90	c	-	↔	↔	-	
Movano 2.5 CDTi 120 DPF, 2.5 CDTi 146 DPF	'06-'10	8		●		●	●	2,7	Getr.Öl EP Synth 75W-90	Spezialprodukt		↔	↔	-	
Movano 3.0 CDTi	'04-'06	7,3	●	●		●	●	2,3-2,6	Getr.Öl EP Synth 75W-90	-		↔	↔	10,5	
Movano B 2.3 CDTi	'10-	8,9	●	●		●	●	2,8	Getr.Öl EP Synth 75W-90	Spezialprodukt		↔	↔	-	
Movano B 2.3 CDTi RWD	'10-	8,9	●	●		●	●	2,2	Getr.Öl EP Synth 75W-90	Spezialprodukt		↔	↔	-	
Movano B 2.3 CDTi DPF	'10-	8,9		●		●	●	2,8	Getr.Öl EP Synth 75W-90	Spezialprodukt		↔	↔	-	
Movano B 2.3 CDTi RWD DPF	'10-	8,9		●		●	●	2,2	Getr.Öl EP Synth 75W-90	Spezialprodukt		↔	↔	-	

a Verteilergetriebe: 1.4 | BlueTronic 10W-40; Tronic 15W-40

b Differentiale, vorn und hinten; Sperrdifferential: Getr.Öl BS LSX 75W-140, Getr.Öl HYP LS 85W-90

c Hydraulikanlage Tecshift: 0.6 | Spezialprodukt, bitte auf Originalersatzteil des Herstellers zurückgreifen!

## PEUGEOT

Bipper 1.4	'07-'09	2,75	●	●		●		2	Getr.Öl EP Synth 75W-90	-		↔	↔	5,3	
Bipper 1.4	'09-	2,75				●		2	Getr.Öl EP Synth 75W-90	-		↔	↔	5,3	
Partner 1.1, 1.4, 1.8	'96-'98	3,5-4,75		●		●		2	Getr.Öl EP Synth 75W-90	-		↔	↔	6,5-7	
Partner 1.1, 1.4, 1.6 16V, 1.8	'98-'08	3-3,5	●	●		●		2	Getr.Öl EP Synth 75W-90	-		↔	↔	6,5-7	
Partner 1.6 16V, 1.6 16V VTi	'09-	3,3	HighTronic J 5W-30					1,9	Getr.Öl EP Synth 75W-90	-		↔	↔	5,9	
Expert 1.6	'95-'01	4-4,5		●		●		1,9	Getr.Öl EP Synth 75W-90	-		↔	↔	9,5	
Expert 2.0i	'02-'07	4,25				●	●	1,85	Getr.Öl EP Synth 75W-90	Spezialprodukt		↔	↔	7	
Expert 2.0i	'07-	5	HighTronic J 5W-30					1,8	Getr.Öl EP Synth 75W-90	-		↔	↔	8,5	
Boxer, Express 2.0	'94-'02	4,5-5		●		●		1,85	Getr.Öl EP Synth 75W-90	-		↔	↔	9-9,5	
Boxer 2.0i	'02-'06	5		●		●		1,85-2,7	Getr.Öl EP Synth 75W-90	-		↔	↔	9	
<b>Diesel</b>															
Bipper 1.3 HdI	'10-	3,2	HighTronic J 5W-30					2	Getr.Öl EP Synth 75W-90	Spezialprodukt		c	↔	↔	7,6
Bipper 1.4 HdI	'07-'09	3,75	●	●		●		2	Getr.Öl EP Synth 75W-90	-		↔	↔	7,4	
Bipper 1.4 HdI	'09-	3,75				●		2	Getr.Öl EP Synth 75W-90	-		↔	↔	7,4	
Partner 1.6 HdI	'05-'09	3,8	●	●		●		1,9	Getr.Öl EP Synth 75W-90	-		↔	↔	11	
Partner 1.6 HdI	'08-	4,3	HighTronic J 5W-30					1,9	Getr.Öl EP Synth 75W-90	-		↔	↔	6,3	
Partner 1.6 HdI DPF	'08-	4,3	HighTronic J 5W-30					1,9	Getr.Öl EP Synth 75W-90	-		↔	↔	6,3	
Partner 1.8 D, 1.9 D	'96-'99	4,3/4,5	●	●		●		2	Getr.Öl EP Synth 75W-90	-		↔	↔	8	
Partner 1.8 D, 1.9 D	'00-'02	4,3/4,5	●	●		●		2	Getr.Öl EP Synth 75W-90	-		↔	↔	8	
Partner 2.0 HdI	'00-'05	4,5	●	●		●		1,8	Getr.Öl EP Synth 75W-90	-		↔	↔	8,5	
Expert 1.6 HdI	'07-'09	5	●	●		●		1,8	Getr.Öl EP Synth 75W-90	-		↔	↔	-	
Expert 1.6 HdI	'09-	5	HighTronic J 5W-30					1,8	Getr.Öl EP Synth 75W-90	-		↔	↔	-	
Expert 1.9 D, Turbo D	'96-'07	4-4,5	●	●		●		1,9	Getr.Öl EP Synth 75W-90	-		↔	↔	9	
Expert 2.0 HdI	'00-'07	4,5	●	●		●		1,85	Getr.Öl EP Synth 75W-90	-		↔	↔	8,5	
Expert 2.0 HdI	'07-'09	5	●	●		●		1,9	Getr.Öl EP Synth 75W-90	-		↔	↔	-	
Expert 2.0 HdI	'09-	5	HighTronic J 5W-30					1,9	Getr.Öl EP Synth 75W-90	-		↔	↔	-	
Expert 2.0 HDiF	'07-	5	HighTronic J 5W-30					1,9	Getr.Öl EP Synth 75W-90	-		↔	↔	-	
Boxer 1.9 D, Turbo D	'94-'99	4,3-5	●	●		●		1,9	Getr.Öl EP Synth 75W-90	-		↔	↔	10	

		SuperTronic						HighTronic			Blue Tronic	4H	Aral		Aral	Aral			
		G 0W-30	0W-40	LL III 5W-30	M 5W-40	5W-40	G 5W-30	10W-40	Aral	Aral									
										Synthese	Mineral								
<b>PEUGEOT</b>																			
Boxer 1.9 D, Turbo D	'00-'03	4,3-5	●	●			●		●	1,9	Getr.Öl EP Synth 75W-90	-				↕	↕	10	
Boxer 2.0 HDi, 2.2 HDi	'02-'06	5,3	●	●			●		●	1,85-2,7	Getr.Öl EP Synth 75W-90	-				↕	↕	10,5-11	
Boxer 2.2 HDi	'06-'09	6	●	●			●		●	2,7-2,9	Getr.Öl EP Synth 75W-90	-				↕	↕	11,5-12	
Boxer 2.2 HDi	'09-	6	HighTronic J 5W-30							●	2,4	Spezialprodukt	-				↕	↕	11,5-12
Boxer, Express 2.5 D, Turbo D	'94-'99	9	●	●			●		●	1,9	Getr.Öl EP Synth 75W-90	-				↕	↕	13	
Boxer, Express 2.5 D, Turbo D	'00-'03	9	●	●			●		●	1,9	Getr.Öl EP Synth 75W-90	-				↕	↕	13	
Boxer 2.5 TDi, 4x4	'98-'99	8,8	●	●			●		●	2,8	Getr.Öl EP Synth 75W-90	b	-			↕	↕	a 13	
Boxer 2.5 TDi, 4x4	'00-'02	8,8	●	●			●		●	2,8	Getr.Öl EP Synth 75W-90	b	-			↕	↕	a 13	
Boxer 2.8 HDi	'02-'06	7	●	●			●		●	1,85-2,7	Getr.Öl EP Synth 75W-90		Spezialprodukt			↕	↕	10	
Boxer 3.0 HDi	'06-'09	7	●	●			●		●	2,9	Getr.Öl EP Synth 75W-90	-				↕	↕	11,1-11,6	
Boxer 3.0 HDi	'09-	7	HighTronic J 5W-30							●	2,9	Getr.Öl EP Synth 75W-90	-				↕	↕	11,1-11,6
<b>CNG</b>																			
Partner 1.4 CNG	'03-'09	3	●	●			●	●	●	2	Getr.Öl EP Synth 75W-90	-				↕	↕	5,6	
Partner 1.4 CNG	'09-	3	HighTronic J 5W-30							●	2	Getr.Öl EP Synth 75W-90	-				↕	↕	5,6
a Differential, hinten (4x4): 2,3 l Getr.Öl HYP LS 85W-90																			
b Verteilergetriebe: 0,5 l Getr.Öl HYP LS 85W-90																			
c Hydraulisch betätigtes Automatikgetriebe MCP: Spezialprodukt, bitte auf Originalersatzteil des Herstellers zurückgreifen!																			
<b>PIAGGIO</b>																			
Piaggio Porter 1.0	'95-	2-3							●	1,6	Getriebeöl EP 85W-90	-					↕	↕	3-5
<b>Diesel</b>																			
APE Diesel / Celessino / Classic	-	3,5	Tronic 15W-40; MultiTurboral 15W-40; PlusTurboral 15W-40								-	Getriebeöl BS 75W-90	-				↕	↕	-
Porter Quargo / Quargo Disco	'05-	2,5	Tronic 15W-40; MultiTurboral 15W-40; PlusTurboral 15W-40								2,3	Getriebeöl BS 75W-90	-				↕	↕	5,5
<b>RENAULT</b>																			
Logan Van 1.4	'07-	3,3					●			2,5	Getr.Öl EP Synth 75W-90	-					↕	↕	5,5
Logan Van/Pick-up 1.6, 16 16V	'07-	3,3-4,8					●			2,5	Getr.Öl EP Synth 75W-90	-					↕	↕	4,5-5,5
Kangoo 1.2 (16V), 1.6 16V, 4x4	'97-'09	3,7-4,8	●	●			●		●	3,3-3,4	Getr.Öl EP Synth 75W-90	Getr.Öl ATF E-S	Getriebeöl ATF 55				↕	↕	c 4,3-7,9
Kangoo 1.4	'97-'03	2,9	●	●			●		●	3,4	Getr.Öl EP Synth 75W-90	-					↕	↕	5,5
Kangoo II 1.6 8V, 1.6 16V	'08-	3,4-4,8					●			2,5-2,8	Getr.Öl EP Synth 75W-90	Getr.Öl ATF E-S	Getriebeöl ATF 55				↕	↕	5
Trafic II 2.0 16V	'01-'07	5,4	●	●			●		●	2,7	Getr.Öl EP Synth 75W-90	-					↕	↕	6,5
Trafic II 2.0 16V	'07-	5,4					●			2,7	Getr.Öl EP Synth 75W-90	-					↕	↕	6,5
<b>Diesel</b>																			
Express 1.6 D, 1.9 D	'85-'01	5,3-5,5					●			3,2-3,4	Getr.Öl EP Synth 75W-90	-					↕	↕	6,6
Logan Van/Pick-up 1.5 dCi	'07-	4,5					●			2,5	Getr.Öl EP Synth 75W-90	-					↕	↕	4,5-5,5
Kangoo 1.5 dCi, 1.9 dTi, dCi, 4x4	'97-'09	4,6-5,5	●	●			●		●	3,1-3,4	Getr.Öl EP Synth 75W-90	-					↕	↕	c 6,5-7,5
Kangoo II 1.5 dCi	'08-	4,5					●			2,5-2,8	Getr.Öl EP Synth 75W-90	-					↕	↕	7,2
Kangoo II 1.5 dCi DPF	'08-	4,5	HighTronic R 5W-30							●	2,5-2,8	Getr.Öl EP Synth 75W-90	-				↕	↕	7,2
Trafic II 1.9 dCi	'01-'07	4,7	●	●			●		●	2,7	Getr.Öl EP Synth 75W-90	-					↕	↕	6,5
Trafic II 2.0 dCi	'07-'09	6,6	●	●			●			2,5-2,7	Getr.Öl EP Synth 75W-90	b	-				↕	↕	6,3
Trafic II 2.0 dCi	'09-	7,7					●			2,7	Getr.Öl EP Synth 75W-90	b	-				↕	↕	-
Trafic II 2.5 dCi, Quickshift	'01-'07	8	●	●			●		●	2,5-2,8	Getr.Öl EP Synth 75W-90	a	-				↕	↕	5,6-7,8
Trafic II 2.0 dCi DPF, 2.5 dCi DPF, Quickshift	'07-	7,5-7,7	HighTronic R 5W-30							●	2,5-2,7	Getr.Öl EP Synth 75W-90	b	-			↕	↕	-
Master T 35D	'89-'97	5,5-6					●			4	Getr.Öl EP Synth 75W-90	-					↕	↕	14
Master II T 28 - T35	'97-'00	6,7	●	●			●		●	2,5-2,8	Getr.Öl EP Synth 75W-90	-					↕	↕	11
Master II 1.9 dTi, dCi	'99-'07	5,5	●	●			●		●	2,6	Getr.Öl EP Synth 75W-90	-					↕	↕	9,5-11
Master II 2.2 dTi, dCi	'99-'07	6,5/8,3	●	●			●		●	2,5	Getr.Öl EP Synth 75W-90	-					↕	↕	10

Master II 2.5 D, 2.8 dTi	'99-'07	6,5	●	●		●	●	2,5-2,7	Getr.Öl EP Synth 75W-90	-			↔	↔	7	
Master II 2.5 dCi, Quickshift	'02-'07	7,5-8	●	●		●	●	2,3-2,7	Getr.Öl EP Synth 75W-90	a	-		↔	↔	10-10,5	
Master II 2.5 dCi, Quickshift	'07-'10	7,5				●		2,7	Getr.Öl EP Synth 75W-90	b	-		↔	↔	10	
Master II 2.5 dCi DPF, Quickshift	'07-	7,5-8	HighTronic R 5W-30					2,7	Getr.Öl EP Synth 75W-90	a	-			↔	↔	7,8-10
Master II 2.8 Dti, 3.0 dCi	'00-'07	6,5-7,3	●	●		●	●	2,55-2,7	Getr.Öl EP Synth 75W-90	-	-		↔	↔	7-10,5	
Master II Propulsion 3.0 dCi	'04-'07	7,3	●	●		●	●	2,7	Getr.Öl EP Synth 75W-90	-	-		↔	↔	10,5	
Master II Propulsion 3.0 dCi	'07-'10	10,9	SuperTurboral 5W-30; MegaTurboral S 10W-40					2,2-2,7	Getr.Öl EP Synth 75W-90	-	-	4,2-6	Getriebeöl BS 75W-90		12-13,2	
Master III 2.3 dCi	'10-	8-8,9				●		2,7	Getr.Öl EP Synth 75W-90	b	-	2,7-3	Getriebeöl BS 75W-90		7,8-8,6	
Master III 2.3 dCi DPF	'10-	8-8,9	HighTronic R 5W-30					2,7	Getr.Öl EP Synth 75W-90	b	-	2,7-3	Getriebeöl BS 75W-90		7,8-8,6	
Mascott 90, 110, 130, 140, 150	'99-'04	6,3	MegaTurboral 10W-40; ExtraTurboral 10W-40; Turboral 10W-40					2,2/2,7	BasicTurboral SAE 30	-	-	4,2-5,5	Getriebeöl BS 75W-90		12	

a Hydraulikanlage Quickshift: 0,6 l Spezialprodukt, bitte auf Originalersatzteil des Herstellers zurückgreifen!

b Hydraulikanlage Quickshift: Spezialprodukt, bitte auf Originalersatzteil des Herstellers zurückgreifen!

c Differential, hinten (4x4): 0,8 l Getriebeöl BS 75W-90; Getriebeöl SNA-C 75W-90

## SEAT

Inca 1.4, 1.6	'96-'03	3,5/4			●	●		3,1/2	Getr.Öl EP Synth 75W-90	-			↔	↔	5,5
Inca 1.4 16V	'01-'03	3,2	●		●	●		2,1	Getr.Öl EP Synth 75W-90	-			↔	↔	8
Alhambra 2.0	'96-'00	4,5			●	●	●	2,2	Getriebeöl ATF-LD		Getriebeöl ATF-LD		↔	↔	8,2
Alhambra 2.8	'00-'10	5,5	●		●	●		2,2	Spezialprodukt		Getr.Öl ATF E-S		↔	↔	9-11,4
<b>Diesel</b>															
Inca 1.9 D, SDI, TDI	'96-'03	4,5			●		●	2/2,7	Getr.Öl EP Synth 75W-90	-			↔	↔	5,5-6,5
Alhambra 1.9 TDI	'96-'00	4,3			●		●	2	Getriebeöl ATF-LD		Getriebeöl ATF-LD		↔	↔	9

## SKODA

Felicia Pick-up, Van, 1.3	'95-'01	4,5			●	●		2,4	Getr.Öl EP Synth 75W-90	-			↔	↔	6
Praktik 1.2, 1.4	'07-'10	2,8-3,2	●		●	●	●	2	Spezialprodukt				↔	↔	5,2
Praktik 1.2, 1.4, 1.2 TSI	'10-	2,8-3,2	●		●	●		2	Getr.Öl EP Synth 75W-90	-			↔	↔	5,2
Praktik 1.6	'07-'10	3,6	●		●	●	●	2	Spezialprodukt		Spezialprodukt		↔	↔	5,9
Praktik 1.6	'10-'11	3,6	●		●	●		2	Getr.Öl EP Synth 75W-90	-	Spezialprodukt		↔	↔	5,9
<b>Diesel</b>															
Felicia Pick-up, Van, 1.9 D	'95-'01	5			●		●	2,4	Getr.Öl EP Synth 75W-90	-			↔	↔	6
Praktik 1.2 TDI	'10-	-			●			1,9	Getr.Öl EP Synth 75W-90	-			↔	↔	-
Praktik 1.4 TDI	'07-'10	-			●			2	Spezialprodukt	-			↔	↔	-
Praktik 1.4 TDI DPF	'07-'10	-			●		●	2	Spezialprodukt	-			↔	↔	-
Praktik 1.6 TDI	'10-	-			●			1,9	Getr.Öl EP Synth 75W-90	-			↔	↔	-
Praktik 1.9 TDI	'07-'10	4,3			●		●	2	Spezialprodukt	-			↔	↔	-
Praktik 1.9 TDI DPF	'07-'10	4,3			●		●	2	Spezialprodukt	-			↔	↔	-

## SUBARU

E12, Sumo, Libero, 4x4	'90-'00	3		●		●		2,1	Getr.Öl SNS-B 75W-80	-			↔	↔	6,5
------------------------	---------	---	--	---	--	---	--	-----	----------------------	---	--	--	---	---	-----

## SUZUKI

Carry, Super Carry	'84-'99	3,5			●		●	1/1,3	Getr.Öl EP Synth 75W-90	-			1,3	Getriebeöl BS 75W-90	4
--------------------	---------	-----	--	--	---	--	---	-------	-------------------------	---	--	--	-----	----------------------	---

## TOYOTA

Hi-Ace 2.4i	'95-'00	6,2			●		●	2	Getr.Öl SNS-B 75W-80		Getr.Öl ATF E-S	Getriebeöl ATF 55	1,3	Getriebeöl BS 75W-90	e	11	
Hi-Ace 2.7i	'00-	5,5	●	●	●		●	2	Getr.Öl SNS-B 75W-80		Getr.Öl ATF E-S	Getriebeöl ATF 55	1,25	Getriebeöl BS 75W-90	e	-	
Hi-Ace 2.7 4x4	'00-	4,8	●	●	●		●	2,4-2,6	Getr.Öl SNS-B 75W-80	g	-		1,6-2,2	Getriebeöl BS 75W-90	e	-	
<b>Diesel</b>																	
Hi-Ace 2.4 D, TD	'95-'01	6,2			●		●	2-2,6	Getr.Öl SNS-B 75W-80		Getr.Öl ATF E-S	Getriebeöl ATF 55	1,3	Getriebeöl BS 75W-90	e	11-13	
Hi-Ace 2.5 D4-D 90, 100, 4x4	'01-'07	7,3-7,6	●	●	●		●	2-2,6	Getr.Öl SNS-B 75W-80	g	Getr.Öl ATF E-S	Getriebeöl ATF 55	1,35/1,25	Getriebeöl BS 75W-90	ce	8,8-12	
Hi-Ace 2.4 D4-D Euro4, 4x4	'07-	7,3	●	●	●		●	2-2,6	Getr.Öl SNS-B 75W-80	g	Getr.Öl ATF E-S	Getriebeöl ATF 55	1,25	Getriebeöl BS 75W-90	ce	8,8-12	
Hilux 2.4 D, 4x4	'88-'01	5,8			●		●	2,2/3,9	Getr.Öl SNS-B 75W-80	a	Getr.Öl ATF E-S	Getriebeöl ATF 55	2,2/2,3	Getriebeöl BS 75W-90	cd	9/10	
Hilux 2.4 D, 2.4 TD, 4x4	'98-'01	6,0-6,9			●		●	2,2	Getr.Öl SNS-B 75W-80	g	-		1,6-2,4	Getriebeöl BS 75W-90	ce	8,7-9,7	
Hilux 2.5 D4-D 90, 100 4x4	'01-'06	6,6-6,8	●	●	●		●	2,2	Getr.Öl SNS-B 75W-80	g	-		1,8	Getriebeöl BS 75W-90	bcf	10-10,4	
Hilux 2.5 D4-D, 3.0 D4-D, 3.0 D 4x4	'06-	6,9-7,2	●	●	●		●	2,2-2,6	Getr.Öl SNS-B 75W-80	g	Getr.Öl ATF E-S	Getriebeöl ATF J	g	1,4-3,4	Getriebeöl BS 75W-90	ce	9-11,1
Hilux 2.5 D4-D DPF, 3.0 D4-D DPF, 4x4	'11-	6,9			●		●	2,2	Getr.Öl SNS-B 75W-80	g	Getr.Öl ATF E-S	Getriebeöl ATF J	g	1,4-3,4	Getriebeöl BS 75W-90	ce	9-11,1
Dyna 100 2.5 D4-D 90	'01-'07	7,3	●	●	●		●	2,2	Getr.Öl SNS-B 75W-80	-			1,7	Getriebeöl BS 75W-90	e	10,7-11,5	
Dyna 100 3.0 D4-D Euro4	'07-	7	●	●	●		●	2,6	Getr.Öl SNS-B 75W-80	-			2,3	Getriebeöl BS 75W-90	e	10,7-11,5	

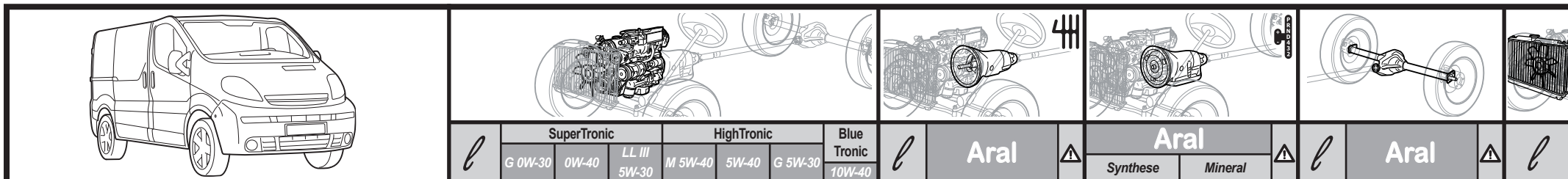

		SuperTronic			HighTronic			Blue Tronic	Aral	⚠	Aral		⚠	Aral	⚠		
		G 0W-30	0W-40	LL III 5W-30	M 5W-40	5W-40	G 5W-30	10W-40			Synthese	Mineral					
Dyna 150 2.5 D4-D 100	'01-'07	7,3	●	●		●		●	2,4	Getr.Öl SNS-B 75W-80	-			3,45	Getriebeöl BS 75W-90		10,7-11,5
Dyna 150 3.0 D4-D Euro4	'07-	7	●	●		●		●	2,6	Getr.Öl SNS-B 75W-80	-			3,45	Getriebeöl BS 75W-90	e	10,7-11,5

- a Verteilergetriebe: 1,2/1,6 I Getr.Öl SNS-B 75W-80; Getriebeöl SNS 75W-80
- c Differentiale, vorn und hinten
- d Sperrdifferential: Getr.Öl BS LSX 75W-140, Getr.Öl HYP LS 85W-90
- e Verteilergetriebe: 1-1.3 I Getriebeöl BS 75W-90; Getriebeöl SNA-C 75W-90

- b Differential hinten (4x4): 2.5 I Getriebeöl BS 75W-90; Getriebeöl HYP Synth 75W-90
- d Sperrdifferential: Getr.Öl BS LSX 75W-140, Getr.Öl HYP LS 85W-90
- f Differential vorn (4x4): 1,85 I Getriebeöl BS 75W-90; Getriebeöl SNA-C 75W-90

### VOLKSWAGEN

Caddy 1.2 TSI	'10-	-	●	●	●				2	Getr.Öl EP Synth 75W-90	-			↔	↔		-
Caddy 1.4, 1.6	'95-'04	3,4-4	●	●	●			●	2,7	Getr.Öl EP Synth 75W-90	-			↔	↔		5,5
Caddy 1.4, 1.6, 2.0, EcoFuel (CNG)	'04-'10	3,2-4,5	●	●	●			●	2,1	Getr.Öl EP Synth 75W-90	-			↔	↔		8
Caddy 2.0 EcoFuel (CNG)	'10-	4	●	●	●				2	Getr.Öl EP Synth 75W-90	-			↔	↔		-
Transporter, Bus, Caravelle	'90-'03	4,5		●	●			●	2,5	Getr.Öl EP Synth 75W-90	Getr.Öl ATF E-S	Getriebeöl ATF 55	e		↔	↔	9-11,5
Transporter Syncro 2.5	'93-'03	4,5	●	●	●			●	3	Getr.Öl EP Synth 75W-90	-			1,0	Getriebeöl BS 75W-90	g	11,5
Caravelle 2.8 V6 (VR6)	'97-'00	5,5		●	●			●	2	Getr.Öl EP Synth 75W-90	Getriebeöl ATF-LD			↔	↔	f	9-11,4
Caravelle 2.8 V6 (VR6)	'01-'03	5,5		●	●				-	-	Getriebeöl ATF-LD			↔	↔	f	11
Transporter 2.0i	'03-'09	5		●	●				2	Getr.Öl EP Synth 75W-90	-			↔	↔		7,1
Transporter 2.0i	'09-	5	●	●	●				2	Getr.Öl EP Synth 75W-90	-			↔	↔		7,1
Transporter 3.2, 4Motion	'04-'09	6,1		●	●				2,7	Spezialprodukt	c			1,2	Getriebeöl BS 75W-90	b	7,1
LT, 4x4	'90-'96	7,0		●	●			●	2,5-3,5	Getr.Öl EP Synth 75W-90	d			1,8/3,5	Getriebeöl BS 75W-90	k	13
LT 28 / 35 / 46(A) 2.3i	'97-'06	8,9		●	●			●	2,2	Getr.Öl EP Synth 75W-90	-			1,8	Getriebeöl BS 75W-90		13
<b>Diesel</b>																	
Caddy 1.6 TDI, BlueMotion	'10-	-		●	●				1,9	Getr.Öl EP Synth 75W-90	Spezialprodukt			↔	↔		-
Caddy 1.9 D, SDI	'95-'04	4,5	●	●	●			●	2,7	Getr.Öl EP Synth 75W-90	-			↔	↔		5,5
Caddy 1.9 TDI	'97-'04	4,5	●	●	●			●	2,7	Getr.Öl EP Synth 75W-90	-			↔	↔		5,5
Caddy 1.9 TDI	'04-'10	4,3		●	●				1,8	Getr.Öl EP Synth 75W-90	Spezialprodukt			↔	↔		8
Caddy 1.9 TDI DPF	'06-'10	4,3		●	●				1,8	Getr.Öl EP Synth 75W-90	Spezialprodukt			↔	↔		8
Caddy 2.0 SDI	'04-'04	4,3		●	●				2,1	Getr.Öl EP Synth 75W-90	-			↔	↔		8
Caddy 2.0 SDI	'05-'10	4,3		●	●				2,1	Getr.Öl EP Synth 75W-90	-			↔	↔		8
Caddy 2.0 TDI	'07-'10	4,3		●	●			●	2,3	Spezialprodukt	Spezialprodukt			↔	↔		8
Caddy 2.0 TDI (62 kW)	'10-	4,3		●	●				2,3	Spezialprodukt	-			↔	↔		-
Caddy 2.0 TDI (81 kW)	'10-	4,3		●	●				1,9	Getr.Öl EP Synth 75W-90	-			↔	↔		-
Caddy 2.0 TDI (81 kW) 4MOTION	'10-	4,3		●	●				2,3	Spezialprodukt	n			1,8	Getriebeöl BS 75W-90		-
Caddy 2.0 TDI (103 kW)	'10-	4,3		●	●				2,3	Spezialprodukt	-			↔	↔		-
Transporter, Bus, Caravelle 1.9 D, 2.4 D, Syncro	'90-'03	4,5	●	●	●			●	2,5-3	Getr.Öl EP Synth 75W-90	Getr.Öl ATF E-S	Getriebeöl ATF 55	e	1	Getr.Öl EP Synth 75W-90		9
Transporter, Bus, Caravelle 2.5 TDI, Syncro	'96-'99	5,5	●	●	●			●	2,5-3	Getr.Öl EP Synth 75W-90	Getriebeöl ATF-LD			↔	↔	gj	11,5
Transporter, Bus, Caravelle 2.5 TDI, Syncro	'99-'03	5,5		●	●			●	2,5-3	Getr.Öl EP Synth 75W-90	Getriebeöl ATF-LD			↔	↔	gj	11,5
Transporter 1.9 TDI	'03-'10	5,8		●	●			●	2	Getr.Öl EP Synth 75W-90	-			↔	↔		7,1
Transporter 2.0 TDI, 4MOTION	'09-	-		●	●				2,7	Spezialprodukt	Spezialprodukt			1,2	Getriebeöl BS 75W-90	c	-
Transporter 2.5 TDI	'03-'06	7,4		SuperTronic LongLife II 0W-30					2,7	Spezialprodukt	-			↔	↔		7,1
Transporter 2.5 TDI DPF	'06-'10	7,4		SuperTronic LongLife II 0W-30					2,7	Spezialprodukt	-			↔	↔		7,1
Transporter 2.5 TDI 4MOTION	'03-'06	7,4		SuperTronic LongLife II 0W-30					2,7	Spezialprodukt	c			1,2	Getriebeöl BS 75W-90	b	7,1
Transporter 2.5 TDI 4MOTION DPF	'06-'10	7,4		SuperTronic LongLife II 0W-30					2,7	Spezialprodukt	c			1,2	Getriebeöl BS 75W-90	b	7,1
LT 28/35/45 (A) 2.5 SDi	'96-'99	7,8	●	●	●			●	1,6	Getr.Öl EP Synth 75W-90	-			1,5	Getriebeöl BS 75W-90		11
LT 28/35/45 (A) 2.5 TDI, 2.8 TDI	'97-'00	7/7,8	●	●	●			●	1,6/2,2	Getr.Öl EP Synth 75W-90	-			1,5-2,2	Getriebeöl BS 75W-90		13
LT 2.5 TDI, 2.8 TDI CR	'02-'06	7,8-8,5	●	●	●			●	1,6/2,2	Getr.Öl EP Synth 75W-90	-			1,5-1,8	Getriebeöl BS 75W-90		-

b Differential, hinten (4x4), Verteilergetriebe: 1,2 l Getriebeöl BS 75W-90

d Verteilergetriebe: 2,2 l Getr.Öl ATF E-S; Getriebeöl ATF 55

f Differential, Automatikgetriebe: 0,8-1,3 l Getriebeöl BS 75W-90

h Hydraulikanlage Shiftmatic: 0,5 l Spezialprodukt, bitte auf Originalersatzteil des Herstellers zurückgreifen!

k Differential, vorn (4x4): 3,1 l Getriebeöl BS 75W-90; Getriebeöl HYP Synth 75W-90

c Haldex Kupplung (4x4): 1 l Spezialprodukt, bitte auf Originalersatzteil des Herstellers zurückgreifen!

e Modelle mit Automatikgetriebe ab 1995: Getriebeöl ATF-LD; Differential 0,8/1 l Getriebeöl BS 75W-90

g Differential, hinten (4x4): 1 l Getriebeöl BS 75W-90

j Differential, Automatikgetriebe: 1,15 l Getriebeöl BS 75W-90

n Haldex-Kupplung (4Motion): Spezialprodukt, bitte auf Originalersatzteil des Herstellers zurückgreifen!

*Achtung: Alle Fahrzeuge mit LongLife-Service: Aral SuperTronic LongLife III 5W-30 verwenden!*

Stand: März 2015

Der Inhalt dieser Schrift entsprach bei Herausgabe dem Stand der Technik. Änderungen der technischen Daten und der Anwendungshinweise bleiben vorbehalten.

Version: March 2015

The content of this brochure meets current status of technology. Changes of technical data or instructions for use are subject to modifications and amendments.



## Aral Extranet: Rund um die Uhr erreichbar.

Unter [www.aral-lubricants.de](http://www.aral-lubricants.de) erhalten Sie aktuell und allgemein zugänglich alle wichtigen Informationen rund um unsere Schmierstoffe. Im geschützten Bereich können Sie z. B. zu jeder Zeit Ihre Bestellungen vornehmen und verwalten oder Ihre Prämienpunkte einlösen.

Ihr Aral Außendienstmitarbeiter gibt Ihnen selbstverständlich gerne Auskunft zu Sortiment, Bestellmengen, Preisen usw.

## Aral Extranet: Available 24/7 for most up to date information

Go to [www.aral-lubricants.de](http://www.aral-lubricants.de) for detailed product information. Please ask your Aral representative for questions around order quantities, prices etc.

### Verkauf in Deutschland:

Aral Aktiengesellschaft  
Geschäftsbereich Schmierstoffe  
Überseeallee 1  
20457 Hamburg

Tel. 0800 / 723 71 14\*  
[inboundaral@bp.com](mailto:inboundaral@bp.com)  
[www.aral-lubricants.de](http://www.aral-lubricants.de)  
[www.aral.de](http://www.aral.de)

\*Kostenfrei innerhalb Deutschlands für alle Anrufe aus dem deutschen Fest- und Mobilfunknetz

Aral zeigt sich seiner Verantwortung bewusst. Daher wurde diese Broschüre auf FSC zertifiziertem Material gedruckt. Die dabei verwendeten Druckfarben sind auf der Basis nachwachsender Rohstoffe aufgebaut.

