

# AMMORTIZZATORI

SHOCK ABSORBERS

AMORTISSEURS

STOSSDÄMPFER

AMORTIGUADORES



# WIKTORI



edition 7



### Ammortizzatori idraulici (oil)

Hydraulic shock absorbers  
Amortisseurs hydrauliques  
Hydraulische Stossdämpfer  
Amortiguadores hidraulicos

### Ammortizzatori a gas

Gas charged shock absorbers  
Amortisseurs à gaz  
Gasdruck Stossdämpfer  
Amortiguadores de gas

#### ① Ammortizzatore tubolare

- ⓐ Telescopic shock absorber
- ⓑ Amortisseur conventionnel
- Ⓓ Konventionelle Stossdämpfer
- Ⓔ Amortiguador telescopico



SERIE T



SERIE TG

#### ① Ammortizzatore con sede molla

- ⓐ Shock absorber with spring seat
- ⓑ Amortisseur à siège de ressort
- Ⓓ Stossdämpfer mit Federsitzteller
- Ⓔ Amortiguador con asiento para muelle



SERIE S



SERIE SG

#### ① Cartuccia MacPherson

- ⓐ MacPherson insert
- ⓑ Jambe de force type MacPherson
- Ⓓ Komplettes MacPherson Federbein
- Ⓔ Cartucho MacPherson



SERIE C



SERIE CG

#### ① Montante MacPherson

- ⓐ Complete MacPherson strut
- ⓑ Cartouche type MacPherson
- Ⓓ MacPherson Federbeineinsatz
- Ⓔ Column MacPherson



SERIE M



SERIE MG

#### ① Tubolare rinforzato

- ⓐ Extra heavy duty shock absorber
- ⓑ Amortisseur super renforcé
- Ⓓ Extra verstärkte Stossdämpfer
- Ⓔ Amortiguador telescopico reforzado



SERIE H



SERIE HG

stossdämpfer  
 shock absorbers  
**ammortizzatori**  
 amortiguadores  
 amortisseurs



amortisseurs

stossdämpfer

shock absorbers

ammortizzatori

sho

ammortizzatori

am

amortiguadores

amortisseurs

amortiguadores

ammortizzatori



**WKTORY,  
la scelta migliore...  
in strada!**

Osrav opera con assoluta competenza ed efficacia, progettando e realizzando prodotti su misura, adeguati alle aspettative e richieste del mercato e della clientela, anche in attuazione della normativa sistema qualità ISO 9001. Fermamente convinta che studiando con impegno e costanza si possano trovare soluzioni nuove ed efficaci, Osrav valorizza e investe nel proprio reparto di Ricerca & Sviluppo per assicurare un progresso costante, senza porre limiti alla capacità di scoperta e di invenzione.

**WKTORY,  
a winning choice...  
on the road!**

Osrav works with absolute expertise and affectiveness, designing and executing customized products that meet market expectations and demand, whilst implementing all the requirements of international quality standard ISO 9001. In the firm conviction that new and effective solutions can be found through endeavour and commitment, Osrav invests heavily in its Research and Development division, to ensure constant progress without placing restrictions on the ability to discover and invent.



amortiguadores  
ori  
ck absorbers  
amortiguadores  
amortisseurs

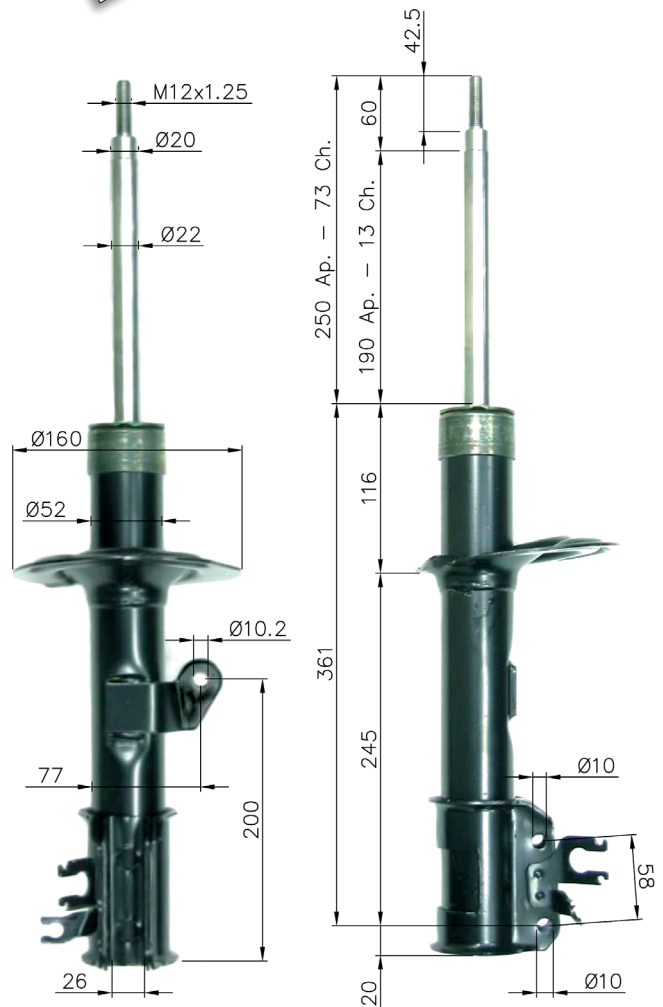
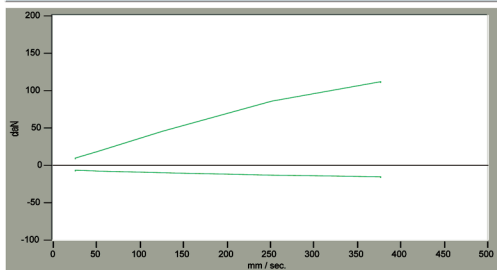
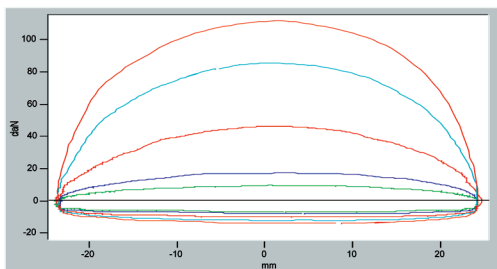
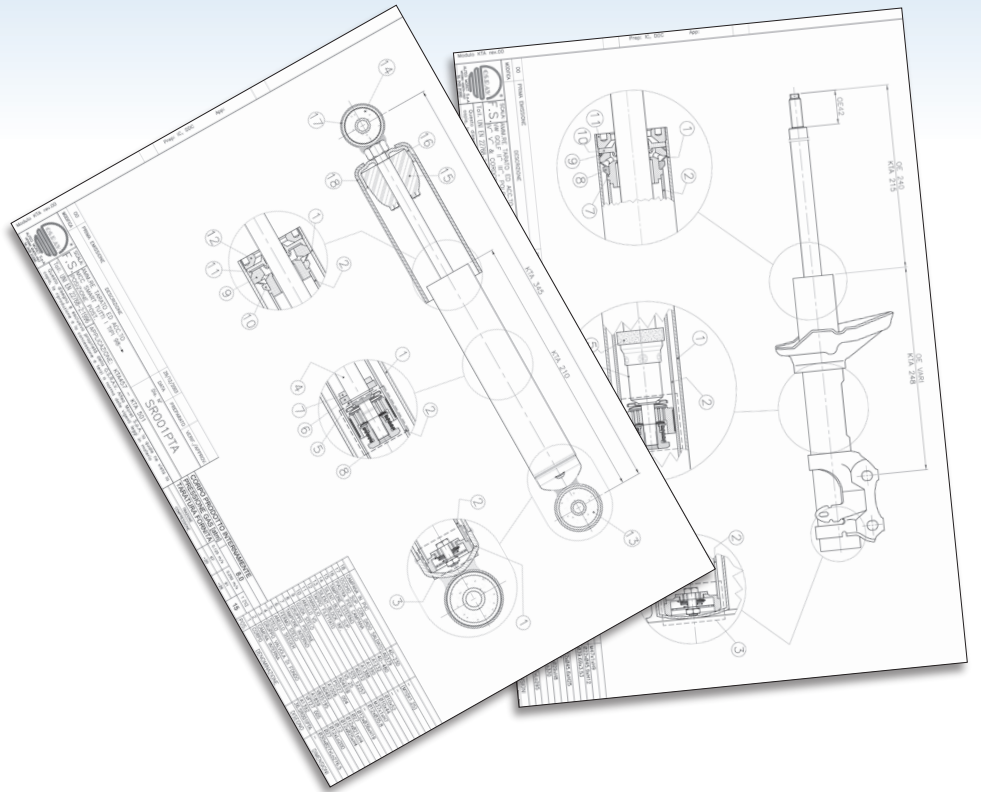
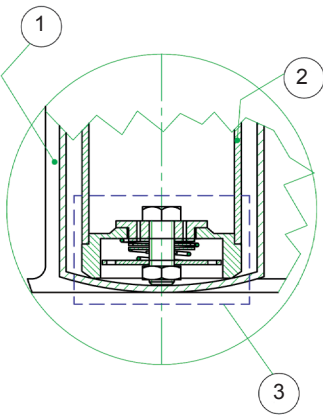
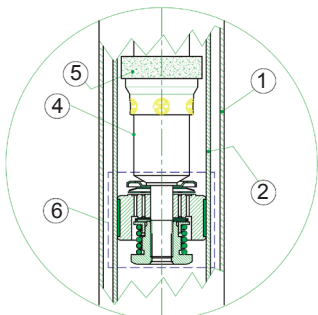
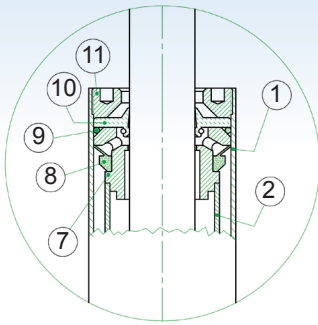

## ATTACCHI AMMORTIZZATORI

Shock absorber mounting diagram - Type de fixations des amortisseurs  
Befestigungsarten der Stossdämpfer - Esquema de anclajes



- Tipo di applicazione
- Mounting diagram
- Type de fixations
- Befestigungsarten der Stossdämpfer
- Esquema de anclajes



- Sospensione MacPherson
- Complete MacPherson strut
- Jambe de force type MacPherson
- MacPherson komplettes Federbein
- Columna de suspensión

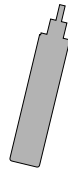

- Cartuccia di ricambio MacPherson
- MacPherson insert
- Cartouche type MacPherson
- MacPherson komplettes Federbein Einsatz
- Cartucho accesorio para columna de suspensión



- Ammortizzatore con piattello portamolla
- Shock absorber with spring seat
- Amortisseur à siège de ressort
- Stossdämpfer mit Federsitzteller
- Amortiguador con asiento para muelle



- Tempo di montaggio (min) per asse
- Min. assembly time for the axle.
- Temps de montage (min.) pour axe.
- Einbauzeit (Min) für Achse.
- Tiempo de montaje (min) para eje.

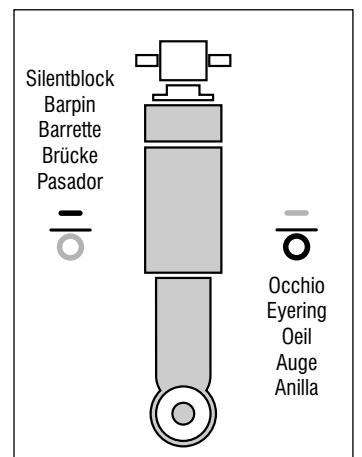
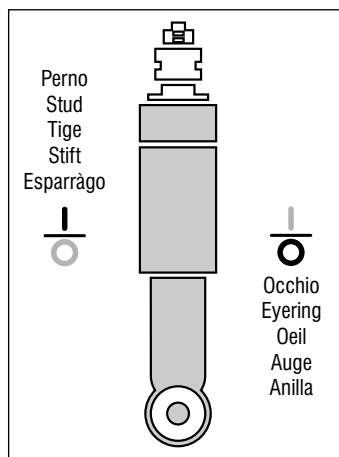
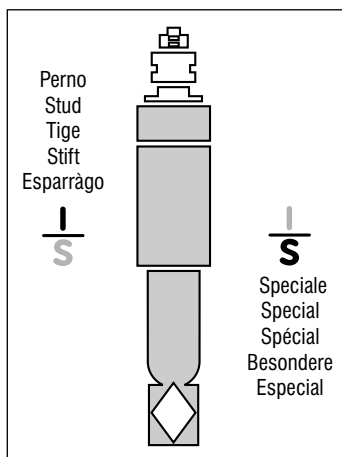
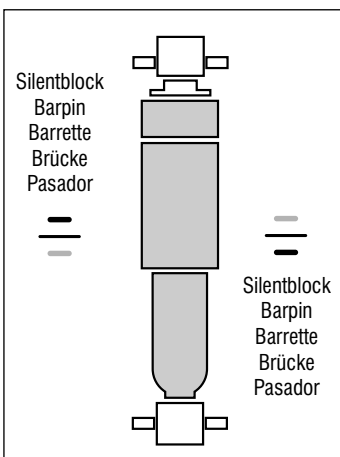
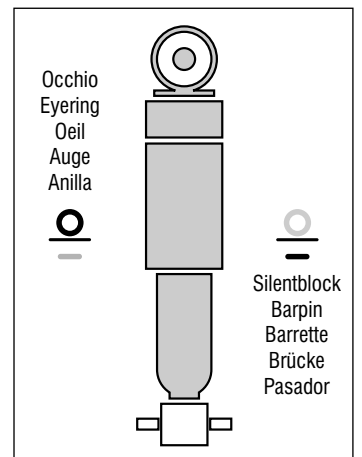
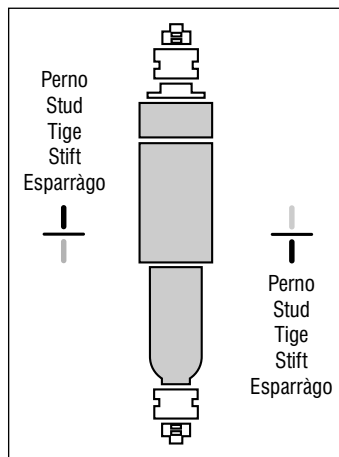
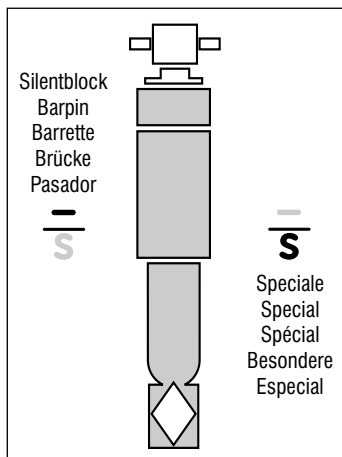
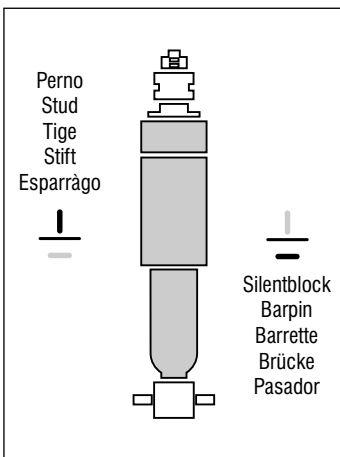
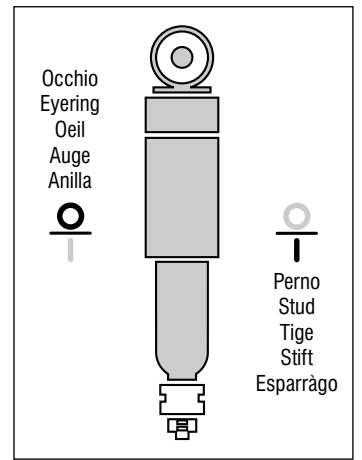
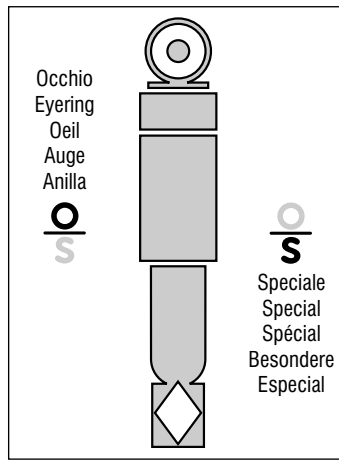
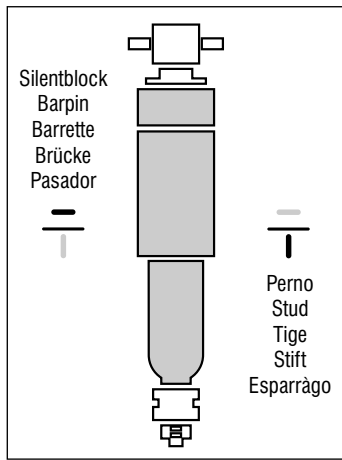
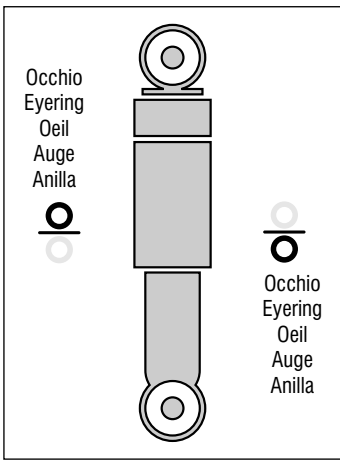

**ATTACCHI AMMORTIZZATORI**

pag. **II**

Shock absorber mounting diagram - Type des fixations des amortisseurs - Befestigungsarten der Stoßdämpfer - Esquema de anclajes

**CATALOGO APPLICAZIONI**

pag. **1**

Applications - Applications - Anwendungsliste - Aplicaciones

ALFA ROMEO	pag.	<b>1</b>	MERCEDES BENZ	pag.	<b>50</b>
ARO	pag.	<b>4</b>	MITSUBISHI	pag.	<b>57</b>
AUDI	pag.	<b>5</b>	MORRIS	pag.	<b>64</b>
AUSTIN	pag.	<b>7</b>	MOSKVITCH	pag.	<b>64</b>
AUTOBIANCHI	pag.	<b>8</b>	NISSAN	pag.	<b>64</b>
BARKAS	pag.	<b>8</b>	OPEL	pag.	<b>72</b>
BEDFORD	pag.	<b>9</b>	PEUGEOT	pag.	<b>77</b>
BMW	pag.	<b>10</b>	PIAGGIO	pag.	<b>84</b>
CHRYSLER	pag.	<b>16</b>	POLSKI	pag.	<b>84</b>
CITROËN	pag.	<b>16</b>	PORSCHE	pag.	<b>85</b>
DACIA	pag.	<b>19</b>	PROTON	pag.	<b>85</b>
DAEWOO	pag.	<b>19</b>	RANGER	pag.	<b>85</b>
DAF	pag.	<b>19</b>	RENAULT	pag.	<b>86</b>
DAIHATSU	pag.	<b>20</b>	ROVER	pag.	<b>98</b>
FIAT	pag.	<b>21</b>	SAAB	pag.	<b>100</b>
FORD	pag.	<b>26</b>	SANTANA	pag.	<b>101</b>
GAZ	pag.	<b>32</b>	SEAT	pag.	<b>102</b>
HANOMAG-HENSCHEL	pag.	<b>32</b>	SKODA	pag.	<b>104</b>
HONDA	pag.	<b>32</b>	SSANG YONG	pag.	<b>105</b>
HYUNDAI	pag.	<b>35</b>	SUBARU	pag.	<b>106</b>
INNOCENTI	pag.	<b>37</b>	SUZUKI	pag.	<b>107</b>
ISUZU	pag.	<b>37</b>	TALBOT	pag.	<b>110</b>
IVECO	pag.	<b>38</b>	TOYOTA	pag.	<b>111</b>
JAGUAR	pag.	<b>39</b>	TRABANT	pag.	<b>123</b>
JEEP	pag.	<b>40</b>	TRIUMPH	pag.	<b>123</b>
KIA	pag.	<b>41</b>	UMM	pag.	<b>123</b>
LADA	pag.	<b>42</b>	VAUXHALL	pag.	<b>123</b>
LANCIA	pag.	<b>42</b>	VOLKSWAGEN	pag.	<b>127</b>
LAND ROVER	pag.	<b>44</b>	VOLVO	pag.	<b>137</b>
LEYLAND	pag.	<b>45</b>	WARTBURG	pag.	<b>140</b>
MAZDA	pag.	<b>45</b>	ZASTAVA	pag.	<b>140</b>
MCC	pag.	<b>49</b>			

**CONDIZIONI GENERALI DI VENDITA**

pag. **141**

General sales terms and conditions

**LISTA NUMERICA**

pag. **143**

Numerical listing - Liste numérique - Numerisches Typenverzeichnis - Lista numérica

**ARTICOLI NUOVI**

pag. **152**

New part number - Nouvelle référence - Neue Stoßdämpfer - Nuevo número de pieza

**ARTICOLI IN FASE DI REALIZZAZIONE**

pag. **152**

Item shortly available - Article disponible à bref délai - In Kürze verfügbarer Artikel - Articulo disponible dentro de un rato de tiempo

**ARTICOLI AD ESAURIMENTO**

pag. **152**

Until stocks depleted - Jusqu'à épuisement du stock - Bis bestände aufgebraucht - Hasta agotar existencias

**ARTICOLI NON DISPONIBILI**

pag. **153**

Not available item - Article non disponible - Nicht verfügbarer Artikel - Articulo no disponible

**ARTICOLI ELIMINATI**

pag. **153**

Discontinued part numbers - Références hors production - Artikel ausser Produktion - Referencia agotada

**ARTICOLI SOSTITUITI**

pag. **153**

Superseded part numbers - Références remplacées - Artikel ersetzt - Referencia sustituida

**LEGENDA**

pag. **156**

Legend - Legende - Bemerkung - Leyenda



ANTERIORE  
FRONT



POSTERIORE  
REAR

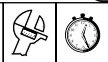

OIL

GAS

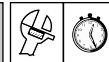

OIL

GAS

## ALFA ROMEO

6

2.0, 2.5 Turbo Diesel	1979 - 1986		50		T 0101	TG0101		50			TG0117
-----------------------	-------------	--	----	--	--------	--------	--	----	--	--	--------

33

1.2	08.86 - 02.87		85			MG0103		75		T 0107	TG0107
1.3, 1.3 S	06.83 - 02.87					MG0104					
1.5 excl. 4x4	06.83 - 02.87			<b>1 - 3</b>							
1.7	06.83 - 02.87										
1.8 TD	06.83 - 02.87										
1.5 4x4	06.83 - 02.87		85			<i>MG0123</i>		105		T 0107	TG0107
						<i>MG0122</i>					
1.2	03.87 - 01.90		85			MG0103		75		T 0107	TG0107
1.3	03.87 - 01.90					MG0104					
1.5	04.88 - 01.90			<b>1</b>							
1.7	03.87 - 01.90										
1.8 TD	03.87 - 1990										
1.3 excl. 4x4	01.90 - 01.93		85			MG0105		75		T 0107	TG0107
1.3S	01.90 - 01.93					MG0106					
1.4	01.90 - 01.93			<b>2</b>							
1.5ie excl. 4x4	01.90 - 01.93										
1.7ie	01.90 - 01.93										
1.7ie 16V	01.90 - 03.90										
1.7ie 16V (4x2)	04.90 - 01.93		85								
1.7ie 16V (4x2)	04.90 - 01.93										
1.7ie 16V (4x4)	04.90 - 01.93							75		T 0107	TG0107
1.7ie 16V (4x4)	04.90 - 01.93										
1.8TD	04.90 - 01.93							75		T 0107	TG0107
1.3	02.93 -		90			MG0125		75		T 0107	TG0107
1.4	02.93 -					MG0124					
1.5	02.93 -										
1.7ie excl. 16V	02.93 -										
1.7ie 16V	02.93 -		90			MG0143		75		T 0107	TG0107
						MG0144					

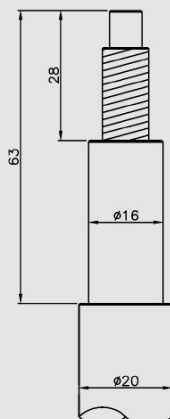

**1**

MG0103  
MG0104

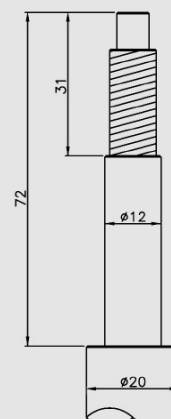

**2**

MG0105  
MG0106





ANTERIORE  
FRONT



POSTERIORE  
REAR

				OIL	GAS					OIL	GAS
--	--	--	--	-----	-----	--	--	--	--	-----	-----

## ALFA ROMEO

### 75

	06.85 - 1992		45		T 0108	TG0108		45		T 0109	TG0109
--	--------------	--	----	--	--------	--------	--	----	--	--------	--------

### 90

	09.84 - 1989		45		T 0108	TG0108		45		T 0109	TG0109
--	--------------	--	----	--	--------	--------	--	----	--	--------	--------

### 145

	1.3 (Boxer)	03.95 - 1997		90			MG0129		55	N.D.		TG0149
	1.6 (Boxer)	03.95 - 1997					MG0128			H.D.		TG0130
	1.7ie 16V (Boxer)	03.95 - 1997										
	1.4, 1.6, 1.8, 2.0 (Twin Spark)	11.96 - 2001		70			MG0131		55	N.D.		TG0149
	1.9 TDS	07.94 - 2001								H.D.		TG0130
	1.9 JTD	1999 - 2001		70			MG0114		55	N.D.		TG0149
										H.D.		TG0130

### 146

	1.3 (Boxer)	03.95 - 1997		90			MG0129		55	N.D.		TG0149
	1.6 (Boxer)	03.95 - 1997					MG0128			H.D.		TG0130
	1.7ie 16V (Boxer)	03.95 - 1997										
	1.4, 1.6, 1.8, 2.0 (Twin Spark)	11.96 - 2001		70			MG0131		55	N.D.		TG0149
	1.9 TDS	07.94 - 2001								H.D.		TG0130
	1.9 JTD	1999 - 2001		70			MG0114		55	N.D.		TG0149
										H.D.		TG0130

### 147

	excl. Sport	11.00 -					SG0135					MG0147
--	-------------	---------	--	--	--	--	--------	--	--	--	--	--------

### 155

	1.7, 1.8, 1.9TD excl.	1991 - 1998		100			MG0110		50	N.D.		TG0624
	2.0, 2.0TD excl.	1991 - 1998								H.D.		TG1375
	2.5 V6 excl.	1991 - 1998		100			MG0114		50	N.D.		TG0624
	2.5TD excl.	1991 - 1998								H.D.		TG1375
	2.0 Turbo 4x4 excl.	1991 - 1998		100			MG0114					TG0127

### 156

	excl. Sport (Ch. → VET0116245)	1997 - 10.98					SG0135					MG0136
	excl. Sport (Ch. VET0116246 →)	10.98 -					SG0135					MG0147
	Sport (Ch. → VET0116245)	1997 - 10.98					SG0145					
	Sport (Ch. VET0116246 →)	10.98 -					SG0145					MG0146
	excl. Sport,	03.00 -					SG0135					MG0147



ANTERIORE  
FRONT



POSTERIORE  
REAR

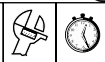

OIL

GAS

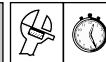

OIL

GAS

## ALFA ROMEO

### 164

2.0i TS, 2.0 Turbo (Ch. → 6183988)	1987 - 04.90		85	ACC47	MG0111		110	excl.	ACC27	MG0113
2.5TD (Ch. → 6183988)	1987 - 04.90			<b>4</b>						
3.0i V6 (Ch. → 6183988) excl.	1987 - 04.90									
2.0i TS, 2.0 Turbo (Ch. 6183989 →)	05.90 - 1998		85	ACC47	MG0112		110	excl.	ACC27	MG0113
2.5TD (Ch. 6183989 →)	05.90 - 1998			<b>5</b>						
3.0i V6 (Ch. 6183989 →) excl.	05.90 - 1998									

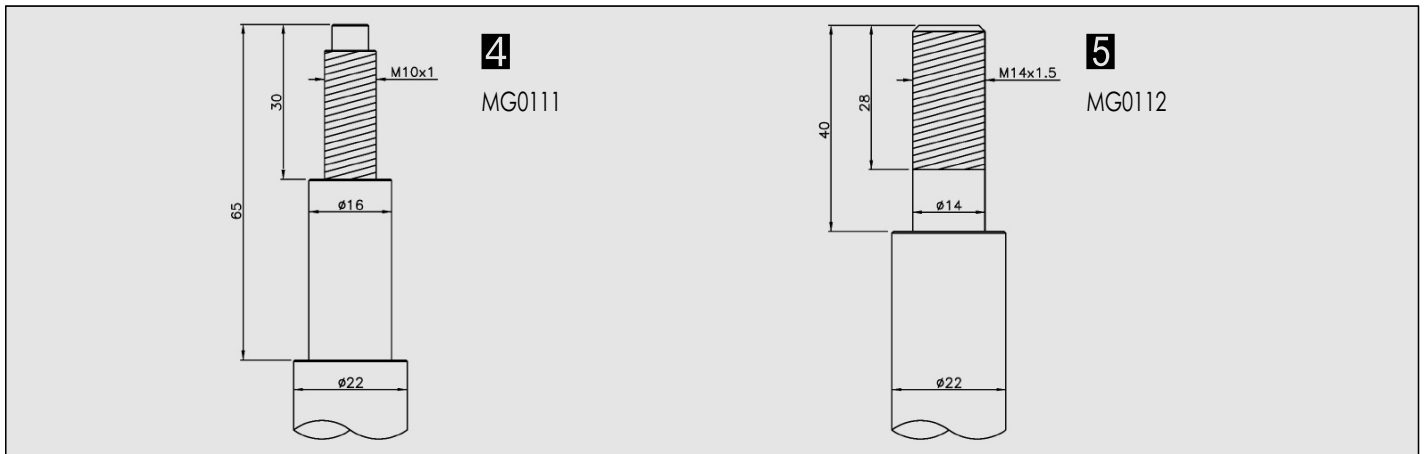

### 166

	1998 -				SG0137					SG0138
--	--------	--	--	--	--------	--	--	--	--	--------

### 1750

1750, GT, Spider	1968 - 1972				T 0119					T 0121
------------------	-------------	--	--	--	--------	--	--	--	--	--------

### 2000

2000, GT, GTV	1971 - 1976				T 0119					T 0121
---------------	-------------	--	--	--	--------	--	--	--	--	--------

## ALFASUD

1.2, 1.3, 1.5Ti	1971 - 1984		100	ACC46	C 0115		40			T 0116
Sprint	1976 - 03.82									
Sprint Veloce 1.3, 1.5Ti	1979 - 1990									
Sprint, Sprint Ti (Susp. Type Alfa 33)	1984 - 1990		85	<b>3 - 1</b> <b>3 - 1</b> ACC46	MG0103 MG0104		75			T 0107 TG0107

**1** Vedi disegno Alfa Romeo 33 a pagina 1 - See drawing Alfa Romeo 33 on page 1

## ALFETTA

1.6, 1.8, 2.0, 2.0TD	1972 - 1986		45		T 0101	TG0101		45		T 0102	TG0102
1.6, 1.8, 2.0 (GT)	1974 - 12.84										
1.6, 1.8, 2.0 (GTV)	1974 - 12.84										
2.0 Turbo, 2.5 (GT)	1974 - 12.84										
2.0 Turbo, 2.5 (GTV)	1974 - 12.84										
2.0, 2.5 (GT)	01.85 - 1989		45		T 0108	TG0108		45		T 0109	TG0109
2.0, 2.5 (GTV)	01.85 - 1989										

**ANTERIORE  
FRONT****POSTERIORE  
REAR****ALFA ROMEO****ARNA**

1.2	10.84 - 1986		85	3-1 3-1 ACC46		MG0103 MG0104		45		T 0118	TG0118
-----	--------------	--	----	---------------------	--	------------------	--	----	--	--------	--------

1 Vedi disegno Alfa Romeo 33 a pagina 1 - See drawing Alfa Romeo 33 on page 1

**GIULIA**

	1962 - 1965		50		T 0119			50		T 0120	
	1966 - 1980		50		T 0119			50		T 0121	

**GIULIETTA**

2000 GTV	1971 - 1976				T 0119					T 0121	
1.3, 1.6, 1.8, 2.0	1977 - 1986		45		T 0101	TG0101		45		T 0102	TG0102
2.0 TD	1983 - 1986										

**GTV**

1.6, 1.8, 2.0	1974 - 12.84		45		T 0101	TG0101		45		T 0102	TG0102
2.0 Turbo, 2.5	1974 - 12.84										
2.0, 2.5	01.85 - 1989		45		T 0108	TG0108		45		T 0109	TG0109
1.8 TS, 2.0 TS	03.95 -		80			MG0132		60			TG0134
2.0 V6 Turbo	03.95 -		80			MG0133		60			TG0134
3.0 V6	1997 -		80			MG0148		60			TG0134

**MONTREAL**

Montreal, Zagato	1972 - 1976		50		T 0119			50		T 0121	
------------------	-------------	--	----	--	--------	--	--	----	--	--------	--

**SPIDER**

1300, 1600, 1750, 2000 (Duetto)	1968 - 1994		55		T 0119			70		T 0121	
1.8 TS, 2.0 TS	02.95 -		80			MG0132		60			TG0134
2.0 Turbo V6	02.95 -		80			MG0133		60			TG0134
3.0 V6	02.95 -										

**ARO****240**

240, 243, 244	1976 -										HG0201



ANTERIORE  
FRONT



POSTERIORE  
REAR

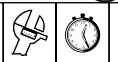

OIL

GAS

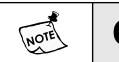

OIL

GAS

## AUDI

### 50

	1974 - 1978		155		ACC18	C 0301	CG0301		55		ACC82	S 0302	SG0302
--	-------------	--	-----	--	-------	--------	--------	--	----	--	-------	--------	--------

### 80

L, S, LS, GLS, GT (Type 82,B1)	1972 - 08.78				ACC18	C 0303	CG0303				ACC84	S 0304	
GTE (Type 82, B1)	1977 - 08.78				ACC18	C 0303	CG0303				ACC84	S 0304	
Avant	1975 - 08.78				ACC18	C 0303	CG0303				ACC84	T 0305	
,  excl. Quattro (Type 81, 85, B2)	09.78 - 1986		195		ACC19	C 0306	CG0306		85		ACC84	S 0307	SG0307
,  Quattro (Type 81, 85, B2)	1983 - 1986		195		ACC19		CG0306						
excl. Quattro,  (Type 89, 8A, B3)	1986 - 07.91		220		ACC19	C 0306	CG0306		85		ACC84	S 0307	SG0307
excl. Quattro (Type 89, 8A, B3)	1986 - 07.91		220		ACC19		CG0306		85		ACC84		SG0308
,  Quattro (Type 89Q, 8A, B3)	1986 - 07.91		220		ACC19		CG0306						
excl. Quattro, V6, S2, Sport Susp. (Type 8C, B4)	08.91 - 09.94		220		ACC19	C 0306	CG0306		55		ACC84	S 0310	SG0310
V6 excl. Sport Susp. (Type 8C, B4)	08.91 - 09.94		220		ACC19		CG0306		55		ACC84		SG0310
Sport Susp. (Type 8C, B4)	08.91 - 09.94		220		ACC19		CG0306						
Quattro (Type 8C, B4)	08.91 - 09.94												
excl. V6, Quattro, Sport Susp. (Type 8C, B4)	08.91 - 09.95		220		ACC19	C 0306	CG0306		55		ACC84	S 0310	SG0310
V6 excl. RS2, Sport Susp. (Type 8C, B4)	08.91 - 09.95		220		ACC19		CG0306		55		ACC84		SG0310
Quattro (Type 8C, B4) excl. RS2	08.91 - 09.95		220		ACC19		CG0306						
Sport Susp. (Type 8C, B4) excl. RS2	08.91 - 09.95		220		ACC19		CG0306						
	08.91 -		220		ACC19		CG0306						
excl. Quattro	1980 - 1989		195		ACC19	C 0306	CG0306		85		ACC84	S 0307	SG0307
excl. Quattro, S2, Sport Susp.	1989 -		220		ACC19		CG0306		85		ACC84		SG0308
Quattro	1984 -		220		ACC19		CG0306						

### 90

excl. Quattro	1984 - 1986		195		ACC19	C 0306	CG0306		85		ACC84	S 0307	SG0307
excl. 2.3L, Quattro,	1987 - 07.91		220		ACC19	C 0306	CG0306		85		ACC84	S 0307	SG0307
excl. 2.3L, Quattro	1987 - 07.91		220		ACC19		CG0306		85		ACC84		SG0308
Quattro	1985 - 07.91				ACC19		CG0306						

### 100

1600, 1800, 2200 (Type 43, C2)	1976 - 08.82		110		ACC62	C 0326	CG0326		50			T 0312	TG0312
1600, 1800, 2200 (Type 43, C2)	1976 - 08.82				ACC62								
excl. Quattro, V8 (Type 44, C3)	09.82 - 10.90		110		ACC62	C 0326	CG0326		135	excl.		S 0313	SG0313
excl. Quattro, V8 (Type 44, C3)	09.82 - 10.90												
Quattro (Type 44Q, C3)	10.84 - 10.90		110		ACC62		CG0326						
excl. Quattro, V8, S4 (Type 4A, C4)	11.90 - 10.94		110		ACC62	C 0326	CG0326		135	excl.		S 0313	SG0313
excl. Quattro, S4 (Type 4A, C4)	09.91 - 10.94												
Quattro excl. S4 (Type 4A, C4)	11.90 - 10.94		110		ACC62		CG0326						
Quattro excl. S4 (Type 4A, C4)	09.91 - 10.94												



ANTERIORE  
FRONT



POSTERIORE  
REAR



## AUDI

### 200

	1980 - 08.82		110	ACC62	C 0326	CG0326		50		T 0312	TG0312
excl. Quattro, V8	06.83 - 10.90		110	ACC62	C 0326	CG0326		135	excl.	S 0313	SG0313
Quattro	10.84 - 10.90		110	ACC62		CG0326					

### A2

	2000 -					MG0330					TG0331
--	--------	--	--	--	--	--------	--	--	--	--	--------

### A3

excl. Quattro, S3, Sport Susp. (Type 8L)	1996 -		100		M 0316	MG0316		40		T 0317	TG0317
Sport Susp. excl. Quattro, S3 (Type 8L)	1996 -		100			MG0316		40			TG0320
Quattro excl. S3 (Type 8L) (Ch. → BL#X#140000)	09.97 - 06.99		100			MG0316					
Quattro excl. S3 (Type 8L) (Ch. BL#X#140001 →)	06.99 -		100			MG0316					

### A4

,  excl. Quattro, Sport Susp.	10.94 - 01.99		80		S 0314	SG0314		135		S 0315	SG0315
excl. Quattro, Sport Susp.	02.99 - 10.00		80		S 0314	SG0314					
excl. Quattro, Sport Susp.	02.99 - 09.01		80		S 0314	SG0314					
,  Sport Susp. excl. Quattro	10.94 - 01.99		80			SG0321		135			SG0315
Sport Susp. excl. Quattro	02.99 - 10.00		80			SG0321					
Sport Susp. excl. Quattro	02.99 - 09.01		80			SG0321					
Quattro excl. Sport Susp.	10.94 - 10.00		80			SG0314					
Quattro excl. Sport Susp.	10.94 - 09.01										
Quattro Sport Susp.	10.94 - 10.00		80			SG0321					
Quattro Sport Susp.	10.94 - 09.01										
excl. Sport Susp.	11.00 -		80			SG0332					TG0334
Quattro excl. Sport Susp.	11.00 -										
excl. Sport Susp.	09.01 -										
Quattro excl. Sport Susp.	09.01 -										
Sport Susp.	11.00 -		80			SG0333					TG0335
Quattro Sport Susp.	11.00 -										
Sport Susp.	09.01 -										
Quattro Sport Susp.	09.01 -										

### A6

excl. Quattro, Sport susp., S6	06.94 - 1997		110	ACC62	C 0326	CG0326		135	excl.	S 0313	SG0313
excl. Quattro, Sport susp., S6 (Type 4A)	06.94 - 1997										
,  excl. Quattro, Sport susp. (Type 4B) Ch. → X070000	05.97 - 01.99		70			SG0322		55	excl.		TG0323
,  excl. Quattro, S6, Sport susp. (Type 4B) Ch. X070001 → Y200000	01.99 - 04.00		70					55	excl.		TG0323
,  excl. Quattro, S6, Sport susp. (Type 4B-1)	04.00 -		70			SG0339		55	excl.		TG0323



ANTERIORE  
FRONT



POSTERIORE  
REAR

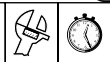

OIL

GAS

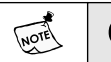
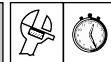

OIL

GAS

## AUDI

### A6

Sport Susp. excl. Quattro (Type 4B) Ch. → Y200000	05.97 - 04.00		70			SG0321		55	excl.		TG0323
Sport Susp. excl. Quattro (Type 4B-1)	04.00 -		70			SG0340		55	excl.		TG0323
Quattro excl. S6, Sport susp. Quattro excl. S6, Sport susp. (Type 4A)	06.94 - 1997 06.94 - 1997		110	ACC62		CG0326			excl.		
Quattro excl. Sport susp. (Type 4B) Ch. → X070000	05.97 - 01.99		70			SG0322		55	excl.		TG0341
Quattro excl. S6, Sport susp. (Type 4B) Ch. X070000 → Y200000	01.99 - 04.00		70					55	excl.		TG0341
Quattro excl. Sport susp. (Type 4B-1)	04.00 -		70			SG0339		55	excl.		TG0342

### A8

	06.94 -		80			SG0324		120	excl.		TG0325
--	---------	--	----	--	--	--------	--	-----	-------	--	--------

### TT

,  excl. Quattro	1998 -		120			MG0327		80			TG0328
,  Quattro	1998 -		120			MG0327		80			TG0329

### V8

	10.88 - 1994		110			CG0326					
--	--------------	--	-----	--	--	--------	--	--	--	--	--

## AUSTIN

### MAESTRO

excl.	1983 - 1994		90	<b>7</b> ACC18	M 0401	MG0401		100	<b>8</b> ACC68	S 0403	SG0403
excl.	1983 - 1994		90	<b>7</b> ACC18	M 0402	MG0402		100	<b>8</b> ACC68	S 0404	SG0404
	1985 - 1990		90	<b>7</b>	M 0405			50		T 0406	
	1990 - 1994		90	<b>7</b>	M 0405			50		T 0407	

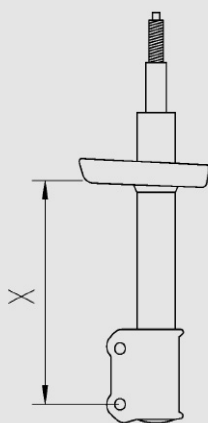

**7**

M 0401 X=264 mm.  
MG0401 X=264 mm.

M 0402 X=250 mm.  
MG0402 X=250 mm.

M 0405 X=271 mm.

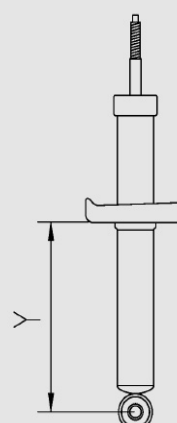

**8**

S 0403 Y=157mm.  
SG0403 Y=157mm.

S 0404 Y=181mm.  
SG0404 Y=181mm.



ANTERIORE  
FRONT



POSTERIORE  
REAR



## AUSTIN

### METRO

	1980 - 1990		75		T 0408					
--	-------------	--	----	--	--------	--	--	--	--	--

### MINI

850, Cooper, Cooper "S"	1965 - 1969		40		T 0409			90		T 0411
850, 1.100, 1.300, GT, Cooper	1970 -									
Innocenti	1974 - 1981									
,  ,	1961 - 1981		40		T 0409			90		T 0410

### MONTEGO

excl. 2.0 MG Turbo,	1984 - 1994		90	<b>7</b> ACC18	M 0401	MG0401		100	<b>8</b> ACC68	S 0403	SG0403
excl. 2.0 MG Turbo,	1984 - 1994		90	<b>7</b> ACC18	M 0402	MG0402		100	<b>8</b> ACC68	S 0404	SG0404
2.0 MG Turbo excl.	1985 - 02.87		90	<b>7</b> ACC18		MG0401		100			SG0412
2.0 MG Turbo	03.87 - 1994		90	<b>7</b> ACC18		MG0402					
	1984 - 1994		90	<b>7</b> ACC18	M 0401	MG0401		100	<b>8 - 9</b> ACC68	S 0403	SG0403
	1984 - 1994		90	<b>7</b> ACC18	M 0402	MG0402		100	<b>8 - 9</b> ACC68	S 0404	SG0404

**7 - 8** Vedi disegni Austin Maestro a pagina 7 - See drawings Austin Maestro on page 7

## AUTOBIANCHI

### A 112

A 112 (Ch. 47201 →)	1969 - 1987		40		M 0503			75		M 0504	MG0504
---------------------	-------------	--	----	--	--------	--	--	----	--	--------	--------

### Y 10

4x2 (156)	03.85 - 1992		80	← → ACC43	M 0505 M 0506	MG0505 MG0506		40		T 0507	TG0507
4x2 (156)	1993 - 1996		80	← → ACC43	M 0505 M 0506	MG0505 MG0506		40		T 0509	TG0509
4x4 (156)	03.85 - 1992		80	← → ACC43	M 0505 M 0506	MG0505 MG0506		40		T 0508	TG0508
4x4 (156)	1993 - 1996		80	← → ACC43	M 0505 M 0506	MG0505 MG0506		40		T 0510	TG0510

## BARKAS

### B 1000

	1962 - 1965				T 2921	TG2921				T 2921	TG2921
	1965 -									T 2921	TG2921



ANTERIORE  
FRONT



POSTERIORE  
REAR



OIL

GAS

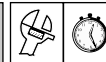

OIL

GAS

## BEDFORD

### ASTRA

	1982 - 1984		145		C 2927	CG2927		50		T 2928	
	1984 - 07.91		145		C 2927	CG2927		50		T 2909	TG2909
Astra Max	1985 - 07.91		145		C 2927	CG2927		50		T 2929	

### CF

14,18, 22, 25, 35 CWT	1970 - 1975		45		H 2910			25		T 0703	TG0703
220, 250, 280	1976 - 1982		45		H 2910			25		H 2911	
340	1976 -										
350	1976 -		45		H 2910			25			
230, 250, 280	1983 -		45		H 2910			25			
			45		H 0705						
18, 22, 25 CWT	1984 -		45		H 2910			25		T 1303	TG1303
			45		H 0705						
35 CWT	1983 - 1984		45		H 2910			25		H 2911	
35 CWT	1984 -		45		H 0705			25		H 2911	
CF electric			45		H 2910						
97170, CF 97370			45		H 2910			25		T 1303	TG1303
			45		H 0705						
97760, CF97 K60			45		H 2910			25		H 2911	
			45		H 0705						

### CHEVANNE

9 CWT	1976 -				T 2903					T 2921	
-------	--------	--	--	--	--------	--	--	--	--	--------	--

### KB

	1980 -		40		H 1901	HG1901		30		H 2616	HG2616
--	--------	--	----	--	--------	--------	--	----	--	--------	--------

### MIDI

4x2	1985 -		30		H 0701			25		H 0702	
4x4	1985 -							25		H 0702	

### RASCAL

	1986 -		120		M 0709			25		H 0706	
					M 0708						
	1986 -		120		M 0709			25		H 0707	
					M 0708						





ANTERIORE  
FRONT



POSTERIORE  
REAR



## BMW

### 3 SERIES (E21)

excl. 323i, Sport Susp.	1975 - 08.82		165	ACC57	C 0805	CG0805		110	ACC84	S 0806	SG0806
323i	09.77 - 08.82		170	ACC57		CG0807		110	ACC84		SG0806
Sport Susp.	1975 - 08.82										

### 3 SERIES (E30) Excl. M-Technik

316 excl. Sport Susp.	09.82 - 08.90		140	<b>11</b>	C 0808	CG0808		50		T 0809	TG0809
318i excl. Sport Susp.	09.82 - 08.90			ACC57							
320i excl. Sport Susp.	09.82 - 08.90										
324d excl. Sport Susp.	09.85 - 08.90										
318iS excl. Sport Susp.	10.87 - 08.90										
323i	09.82 - 09.87		140	<b>10</b>		CG0810		50			TG0809
325e	02.85 - 09.87			ACC57							
325i	09.85 - 09.87										
325iX excl. Sport Susp.	09.85 - 1991							50			TG0809
	09.86 - 02.93		140	<b>10</b>		CG0810		50			TG0809
				ACC57							
320is	1988 - 08.90		140	<b>10</b>		CG0810		50			TG0809
324 td	10.87 - 08.90			ACC57							
316, 316i Sport Susp.	09.82 - 08.90		140	<b>10</b>	C 0810	CG0810		50			TG0809
318i, 318iS Sport Susp.	09.82 - 08.90			ACC57							
320i Sport Susp.	09.82 - 08.90										
324d Sport Susp.	09.85 - 08.90										
324 td Sport Susp.	10.87 - 08.90										
325i, 325e Sport Susp.	10.87 - 08.90										
316i excl. Sport Susp.	03.89 - 09.89		140	<b>11</b>		CG0808		50			TG0809
318i excl. Sport Susp.	03.89 - 09.89			ACC57							
316i, 318i Sport Susp.	03.89 - 1995		140	<b>10</b>	C 0810	CG0810		50			TG0809
316i, 318i	10.89 - 1995			ACC57							
320i	1988 - 1995										
324 td	06.88 - 1995										
325i	1988 - 1995										
325iX	06.88 - 1993							50			TG0809

### 3 SERIES (E36) Excl. M-Technik

316i	1991 - 05.92		160	<b>12</b>	M 0811	MG0811		60		T 0819	TG0819
318i	1991 - 05.92			<b>12</b>	M 0812	MG0812					
				ACC57							
320i	11.90 - 05.92		160	<b>13</b>		MG0813		60		T 0819	TG0819
325i	11.90 - 05.92			<b>13</b>		MG0814					
325 td	11.90 - 05.92			ACC57							
316i	06.92 - 1998		160	<b>14</b>	M 0815	MG0815		60		T 0819	TG0819
318i, 318is	06.92 - 1998			<b>14</b>	M 0816	MG0816					
318 tds	06.92 - 1998			ACC57							
320i, 325i, 325 td	06.92 - 1998		160	<b>15</b>		MG0817		60		T 0819	TG0819
323i, 328i	08.94 - 1998			<b>15</b>		MG0818					
325 tds	1993 - 1998			ACC57							

**12 - 13 - 14 - 15** Vedi disegni BMW 3 Series E36 a pagina 11 - See drawings BMW 3 Series E36 on page 11



ANTERIORE  
FRONT



POSTERIORE  
REAR

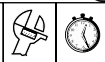

OIL

GAS

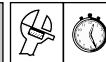

OIL

GAS

## BMW

### 3 SERIES (E36) Excl. M-Technik

318is	01.92 - 05.92		160	<b>12</b> <b>12</b> ACC57	M 0811 M 0812	MG0811 MG0812	60		T 0819	TG0819
320i 325i	10.91 - 05.92 10.91 - 05.92		160	<b>13</b> <b>13</b> ACC57		MG0813 MG0814	60		T 0819	TG0819
316i 318is	10.93 - 1998 06.92 - 1998		160	<b>14</b> <b>14</b> ACC57	M 0815 M 0816	MG0815 MG0816	60		T 0819	TG0819
320i, 323i 325i, 328i	06.92 - 1998 06.92 - 1998		160	<b>15</b> <b>15</b> ACC57		MG0817 MG0818	60		T 0819	TG0819
Compact 316i Compact 318Ti Compact 318 tds	04.94 - 1998 04.94 - 1998 04.94 - 1998		160	<b>14</b> <b>14</b> ACC57	M 0815 M 0816	MG0815 MG0816	60			TG0834
318i 320i, 325i 323i, 328i	1994 - 01.95 03.93 - 11.94 -		160	<b>15</b> <b>15</b> ACC57		MG0817 MG0818	60		T 0819	TG0819
318i	02.95 -			<b>14</b> <b>14</b>			60		T 0819	TG0819
318i, 318 tds 320i 325 tds 323i, 328i	01.95 - 10.99 01.95 - 10.99 01.95 - 10.99 01.95 - 10.99		160	<b>14</b> <b>14</b> ACC57	M 0815 M 0816	MG0815 MG0816	60			TG0835

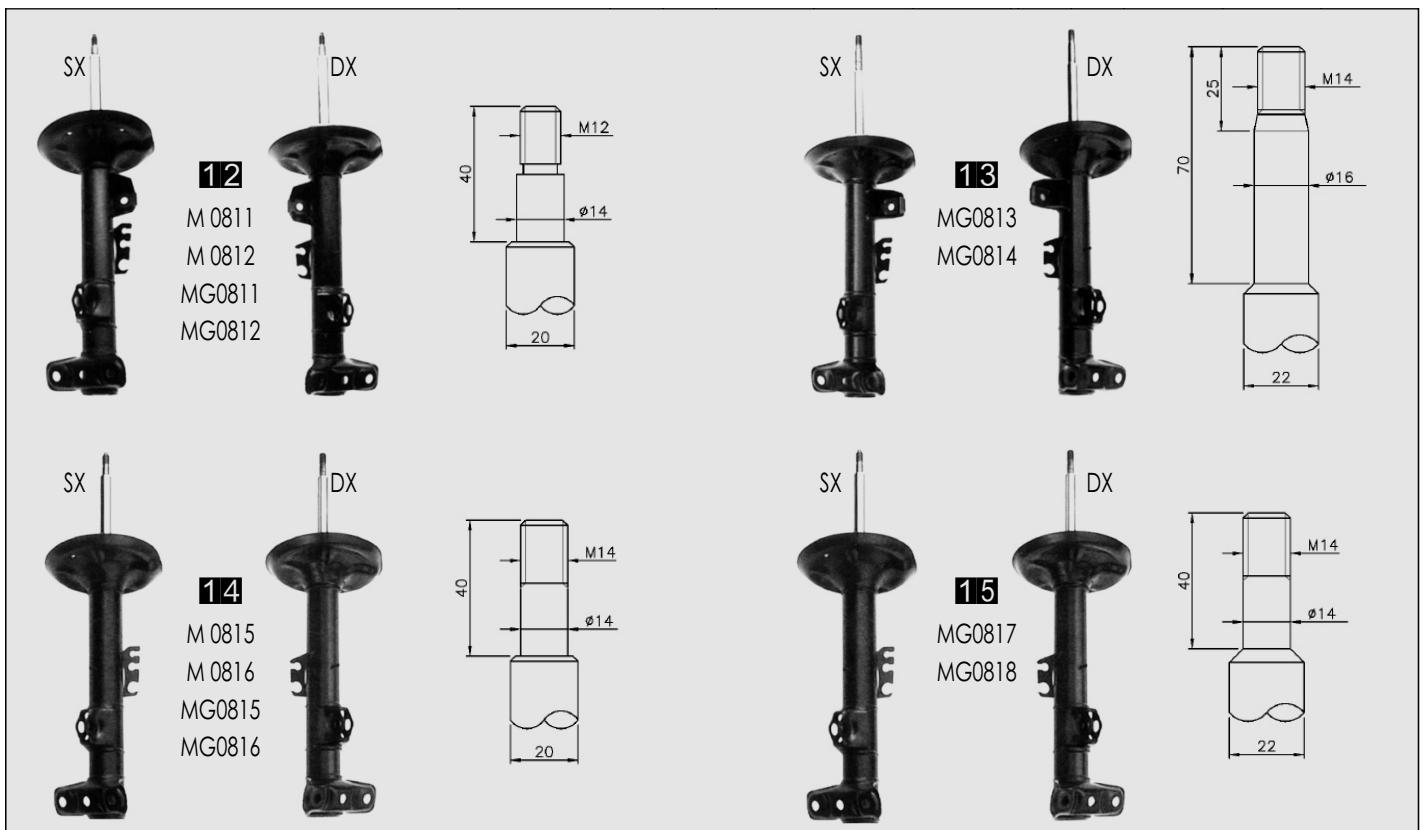



ANTERIORE  
FRONT



POSTERIORE  
REAR



## BMW

### 3 SERIES (E46) Excl. M-Technik

316i, 318i excl. Sport Susp.	1998 -		160			MG0847		60			TG0819
320d excl. Sport Susp.	1998 -					MG0848					
320i, 323i excl. Sport Susp.	1998 -		160			MG0851		60			TG0819
328i excl. Sport Susp.	1998 -					MG0852					
330d excl. Sport Susp.	10.99 -										
318 Ci excl. Sport Susp.	10.99 -		160			MG0847		60			TG0819
						MG0848					
320 Ci excl. Sport Susp.	08.99 -		160			MG0851		60			TG0819
323 Ci, 328 Ci excl. Sport Susp.	04.99 -					MG0852					
318i excl. Sport Susp.	10.99 -		160			MG0847		60			TG0862
320d excl. Sport Susp.	2000 -					MG0848					
320i excl. Sport Susp.	10.99 -		160			MG0851		60			TG0862
328i excl. Sport Susp.	10.99 -					MG0852					
excl. Sport Susp.	2000 -		160			MG0851		60			TG0819
						MG0852					
Compact excl. Sport Susp.	2001 -		160			MG0851		60			TG0819
						MG0852					

### 5 SERIES (E12)

518 (Ch. → 4632973)	1974 - 1976		150		C 0803	CG0803					
520 (Ch. → 4717725)	1972 - 1976										
520A (Ch. → 4413736)	1972 - 1976										
520i (Ch. → 4454062)	1972 - 1976										
525 (Ch. → 4829406)	1973 - 07.76										
525A (Ch. → 4516704)	1973 - 07.76										
528 (Ch. → 4757067)	1973 - 07.76										
528A (Ch. → 4551948)	1973 - 07.76										
530i (Ch. → 5012010)	1973 - 07.76										
530iA (Ch. → 5031674)	1973 - 07.76										
518 (Ch. 4632973 →)	08.76 - 06.81		150		C 0803	CG0803		60		S 0820	SG0820
520 (Ch. 4717725 →)	08.76 - 06.81										
520A (Ch. 4413736 →)	08.76 - 06.81										
520i (Ch. 4454062 →)	08.76 - 06.81										
525 (Ch. 4829406 →)	08.76 - 06.81										
525A (Ch. 4516704 →)	08.76 - 06.81										
528 (Ch. 4757067 →)	08.76 - 06.81										
528A (Ch. 4551948 →)	08.76 - 06.81										
530i (Ch. 5012010 →)	08.76 - 1980										
530iA (Ch. 5031674 →)	08.76 - 1980										
518, 520i, 520/4	08.76 - 06.81										
528i, 520/6	09.77 - 06.81										

### 5 SERIES (E28) Excl. M-Technik

518, 518i, 520i, 525i, 528i	07.81 - 1988		150		C 0821	CG0821		60		S 0822	SG0822
524d, 524td, 525e	1983 - 1988										



ANTERIORE  
FRONT



POSTERIORE  
REAR



OIL

GAS



OIL

GAS

## BMW

### 5 SERIES (E34) Excl. M-Technik

518i, 520i excl. Sport Susp., ,	1988 - 07.90		165	<b>16</b> ACC57	C 0823 CG0823		90	ACC58		SG0824
524td, 525i, 530i, 535i excl. ,	1988 - 07.90		165	<b>17</b> ACC57		CG0825		90	ACC58	SG0824
524td, 524 tds excl. ,	08.90 - 08.92		165	<b>18</b> ACC57		CG0826		90	ACC58	SG0824
525i 24V, 525td, 525 tds excl. ,	08.90 - 08.92									
530i, 535i excl. ,	08.90 - 1995									
540i excl. ,	08.90 - 1995									
518i, 520i 24V excl. Sport Susp., ,	08.90 - 1995		165	<b>19</b> ACC57		CG0833		90	ACC58	SG0824
525i 24V, 525td, 525 tds excl. ,	09.92 - 1995									
518i, 520i Sport Susp. excl. ,	1988 - 07.90		165	<b>17</b> ACC57		CG0825		90	ACC58	SG0824
518i, 520i Sport Susp. excl. ,	08.90 - 08.92		165	<b>18</b> ACC57		CG0826		90	ACC58	SG0824
518i, 520i Sport Susp. excl. ,	09.92 - 1995		165	<b>19</b> ACC57		CG0833		90	ACC58	SG0824
518i, 520i, 525td excl. Sport Susp., ,	08.91 - 1995		165	<b>19</b> ACC57		CG0833		90	ACC58	SG0824
525tds excl. ,	08.91 - 1995		165	<b>18</b> ACC57		CG0826		90	ACC58	SG0824
525i, 530i excl. ,	08.91 - 1995		165	<b>18</b> ACC57		CG0826				
535i, 540i excl. ,	08.91 - 1995									
518i, 520i, 525td Sport Susp. excl. ,	08.91 - 1995		165	<b>18</b> ACC57		CG0826		90	ACC58	SG0824
,  525iX excl. ,	05.91 - 1995							90	ACC58	SG0824

**16**

C 0823  
CG0823

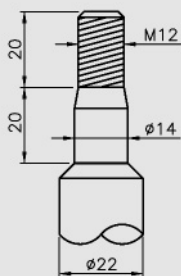

**17**

CG0833

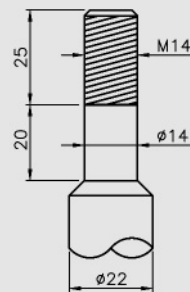

**18**

CG0825

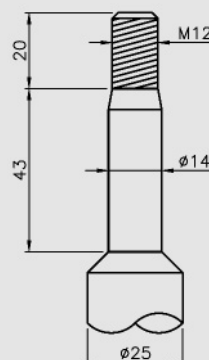

**19**

CG0826

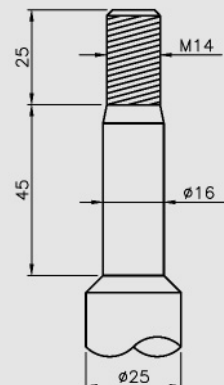

### 5 SERIES (E39) Excl. M-Technik

520i, 523i, 528i	09.95 -		140			MG0841		120		SG0842
525td, 525 tds, 530d	09.95 -									
520i, 523i, 525 tds, 530d	03.97 -		140			MG0841		80		TG0843
535i, 540i	09.95 -		140			MG0844		120		SG0842
528i, 535i, 540i	03.97 -		140			MG0844		60		TG0843



ANTERIORE  
FRONT



POSTERIORE  
REAR



## BMW

### 6 SERIES (E24) Excl. M-Technik

	1976 - 06.78		150		C 0803	CG0803		110		S 0820	SG0820
	06.78 - 05.82		150		C 0827	CG0827		110		S 0820	SG0820
excl. ,	06.82 - 1990		150		C 0821	CG0821		110		S 0822	SG0822

### 7 SERIES (E23)

728, 728i, 730, 733i	1977 - 09.79		180		C 0827	CG0827		110			SG0804
728, 728i, 730, 732i	09.79 - 09.81		180		C 0827	CG0827					
733i, 735i, 735iL	09.79 - 09.81										
745i, 745 Turbo	07.79 - 08.86										
728i, 732i, 735i, 735iL	10.81 - 08.86		180		C 0827	CG0827		110			SG0828
728, 730, 733i	10.81 - 08.84										

### 7 SERIES (E32) Excl. M-Technik

730i excl. , Sport Susp.	09.86 - 02.88		165			CG0830		80	excl.		SG0829
735i, 735iL excl. , Sport Susp.	09.86 - 02.88										
730i excl. , Sport Susp.	03.88 - 07.90		165			CG0831		80	excl.		SG0829
735i, 735iL excl. , Sport Susp.	03.88 - 07.90										
730i, 735i, 735iL excl.	08.90 - 07.94		165			CG0832		80	excl.		SG0829
740i, 740iL excl.	1992 - 1994										

### 7 SERIES (E38) Excl. M-Technik

725 tds excl.	04.96 -								excl.		
728i, 728iL, 735iL excl.	06.95 -								excl.		
730i, 730iL, 735i excl.	04.94 -								excl.		
740i, 740iL, 750i excl.	04.94 -								excl.		
730d excl.	1998 -								excl.		

### 8 SERIES (E31) Excl. M-Technik

excl.	1989 -					CG0849			excl.		TG0850
-------	--------	--	--	--	--	--------	--	--	-------	--	--------

### E3 SERIES

2.5, 2.5A, 2.8L, 2.8LA	1971 - 77		130		C 0803	CG0803					
3.0L, 3.0S, 3.0LA, 3.0SA, 3.0Si, 3.0SiA	04.71 - 77										
3.3L, 3.3LA	09.73 - 77										
2.5, 2.8L, 3.3 Li	1977 -		130		C 0803	CG0803		75			SG0804
3.0L, 3.0S, 3.0Si	1977 -										

### E6 SERIES

1.6, 1.8, 2.0, 2.0Tii	1971 - 02.75				C 0802					T 0801	
-----------------------	--------------	--	--	--	--------	--	--	--	--	--------	--

### E9 SERIES

2.5 CS	09.74 - 1977				C 0803	CG0803					
2.8 CS	1969 -										
3.0 CS, 3.0 Csi	05.71 - 1977										



ANTERIORE  
FRONT



POSTERIORE  
REAR



OIL

GAS



OIL

GAS

## BMW

### E10 SERIES

1600 GT	1968 - 1969										T 0801	
1502, 1802	1971 - 1977		165			C 0802		30			T 0801	
1600, 1602, 1600/2, 1600Ti	1966 - 10.75											
2002, 2002Ti, 2002Tii, 2002 Turbo	1968 - 10.75											

### MINI

Cooper excl. Sport Susp.	2001 -					MG0853 MG0854						SG0855
ONE excl. Sport Susp.	2001 -					MG0859 MG0860						SG0861
Cooper Sport Susp.	2001 -					MG0857 MG0858						SG0856
ONE Sport Susp.	2001 -					MG0853 MG0854						SG0855

### X5

3.0, 3.0d excl.	2000 -											
4.4, 4.6iS excl.	2000 -											

### Z3

1.8 excl. Sport Susp.	1995 -		160		14	MG0815		60				TG0840
1.9 excl. Sport Susp.	1995 - 1999				14	MG0816						
2.8 excl. Sport Susp.	1995 - 2000											
1.8 Sport Susp. (M-Technik)	1995 -											
1.9 Sport Susp. (M-Technik)	1995 - 1999											
2.8 excl. Sport Susp. (M-Technik)	1995 - 2000											
1.9 24V, 2.2 24V excl. Sport Susp.	09.01 -											
3.0 excl. Sport Susp.	2000 -											
1.9 24V Sport Susp. (M-Technik)	09.01 -											
2.2 24V Sport Susp. (M-Technik)	09.01 -											
3.0 Sport Susp. (M-Technik)	2000 -											
M3 3.2	1997 -											
M3 3.2	1997 -											
2.8, 3.0	1996 -											



ANTERIORE  
FRONT

POSTERIORE  
REAR



## CHRYSLER

### NEON

excl. Sport Susp.	10.93 -					MG1003					MG1004
-------------------	---------	--	--	--	--	--------	--	--	--	--	--------

### STRATUS / CIRRUS

,  (JA, JX)	1995 -					MG1007					SG1008
-------------	--------	--	--	--	--	--------	--	--	--	--	--------

### VOYAGER

(ES)	1984 - 1985										HG1002
4x2, 4x4 (ES)	1986 - 02.95			ACC18		MG1001					HG1002
4x2 (GS) excl.  (incl. Grand Voyager)	03.95 -					MG1005					HG1006
4x4 (GS) excl.  (incl. Grand Voyager)	1997 -					MG1005					HG1006

## CITROËN

### 2CV

2CV, 2CV 4, 2CV 6	1965 - 08.74		85		T 0901			60		T 0902	
AK 250	1965 -		85		T 0901			60		T 0902	
AK 400, AK 350	1965 -		60		T 0901			40		T 0903	
AKS 400	07.76 -		75		T 0904			45		T 0904	

### ACADIANE

	1978 - 1983		75		T 0904			45		T 0905	
--	-------------	--	----	--	--------	--	--	----	--	--------	--

### AMI

Ami 6	1961 - 05.63		85		T 0901			60		T 0902	
Ami 6	1963 - 1969		85		T 0901			40		T 0903	
Ami 8 excl. Super	1969 - 1978										
Ami 6 Fourgonette	1963 - 1970		85		T 0901			40		T 0903	
Ami 6	1963 - 1969										
Ami 8 excl. Super	1969 - 1978										
Ami 8 Super	1973 -		75		T 0904			45		T 0904	

### AX

excl. GTi, 4x4, 1.3 Sport	1986 -		160	N.D. H.D.	C 0906 C 0907	CG0906 CG0907		60	N.D. H.D.	T 0908	TG0908 TG0921
1.3 Sport, GTi	1986 -		160	ACC52		CG0907		60			TG0921
4x4	1986 -										

### AXEL / OLTCIT

	1981 - 1991		80		T 0909			80		T 0910	
--	-------------	--	----	--	--------	--	--	----	--	--------	--

### BERLINGO

(MF, M4)	1996 -		120		M 0949 M 0948	MG0949 MG0948		60		T 3027	TG3027



ANTERIORE  
FRONT



POSTERIORE  
REAR



OIL

GAS

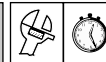

OIL

GAS

## CITROËN

### C15

C15E (XW7, VDPA) Ch. → 4195 excl. 4x4	10.84 - 05.88		170	ACC56	M 0914	MG0914		160		S 0919
C15E (TU, VDPY) Ch. 4196 → excl. 4x4	05.88 -		170	ACC56	M 0918	MG0918		160		S 0919
C15E (G1A, VDPV) Ch. 3887 → 4237	07.87 - 06.88		200	ACC56	M 0918	MG0918		160		S 0919
C15D 475 Kg (XUD7) excl. 4x4	1985 -									
C15D 600 Kg (XUD7) excl. 4x4	1985 -									
C15D 760Kg (XUD7) excl. 4x4	1985 -		200	ACC56	M 0920			160		S 0919

### C25

excl.	1981 - 12.85		150	ACC100	M 0932			50	<b>21</b>	H 0934
	1981 - 12.85		150	ACC100	M 0932			50	<b>21</b>	H 0935
excl. 1800 Kg. ,	01.86 - 1994		200	ACC100	M 0933			50	<b>21</b>	H 0934
1800 Kg.	01.86 - 1994		200	ACC100	M 0601			50	<b>21</b>	H 0602
	01.86 - 1994		200	ACC100	M 0933			50	<b>21</b>	H 0935

**21** Vedi disegno Fiat Ducato a pagina 23 - See drawing Fiat Ducato on page 23

### C32, C35

	1974 -		60		T 0930			60		H 0931
--	--------	--	----	--	--------	--	--	----	--	--------

### DYANE

Dyane 4, Dyane 6	1967 -		85		T 0901			60		T 0902
------------------	--------	--	----	--	--------	--	--	----	--	--------

### EVASION / SYNERGIE

(22) Ch. → 7608	03.94 - 09.97		90		M 1366	MG1366		45		T 1367 TG1367
(22) Ch. 7609 →	10.97 -		90		M 1366	MG1366		45		T 0944 TG0944

### JUMPER / RELAY

1000 Kg. (230L)	1994 -		170	ACC100	M 1355			45		HG1356
1400 Kg. (230L)	1994 -									
1800 Kg. (230L)	1994 -		170	ACC100	M 1385			45		HG1383
(230P)	1994 -		170	ACC100	M 1355			45		

### JUMPY / DISPATCH

(U64) Ch. → 7608	1995 - 09.97		90		M 0943			45		T 1367 TG1367
(U64) Ch. 7609 →	10.97 -		90		M 0943			45		T 0944 TG0944

### LN

602 cc.	- 04.77		200		C 0911	CG0911		115		S 0912
602 cc., 652 cc.	05.77 - 1980		200		C 0911	CG0911		115	<b>32</b>	S 0913

**32** Vedi disegno Peugeot 104 a pagina 78 - See drawing Peugeot 104 on page 78

### LNA

652 cc., 1124 cc.	11.78 - 1986		170	ACC56	M 0914	MG0914		115	<b>32</b>	S 0913
-------------------	--------------	--	-----	-------	--------	--------	--	-----	-----------	--------

**32** Vedi disegno Peugeot 104 a pagina 78 - See drawing Peugeot 104 on page 78





ANTERIORE  
FRONT



POSTERIORE  
REAR



## CITROËN

### MEHARI

Mehari	1969 - 1975		85		T 0901			60		T 0902	
Mehari Pistes	- 1975										
Mehari 4x4 (F.A.F.)	1978 -		75		T 0904			45		T 0904	

### PICASSO

	10.98 -		220		M 0945 M 0946	MG0945 MG0946		55		T 0947	TG0947
--	---------	--	-----	--	------------------	------------------	--	----	--	--------	--------

### SAXO

excl. 1.6, VTS	1996 -		160	N.D. H.D. 	C 0906 C 0907	CG0906 CG0907		60	N.D. H.D.	T 0908	TG0908 TG0921
1.6i, 1.6i 16V, 1.6 VTS	1996 -		160		C 0907	CG0907		60			TG0921

### VISA

excl. GT, GTI, Chrono, Diesel	1978 - 1991		170		M 0914	MG0914		135		S 0915	
Chrono, GT (incl. Challenger)	1978 - 1988		170		M 0914	MG0914		135		S 0916	
1.6 GTI	1984 - 1991				M 3011 M 3010	MG3011 MG3010		135		S 0916	
1.7 D, 1.7 RD	06.84 - 1991		170		M 0918	MG0918		135		S 0915	

### XSARA

1.1, 1.4, 1.6, 1.8	1997 -		220		M 0949	MG0949		55	N.D.	T 0929	TG3020
1.9D, 1.9TD, Hdi	1997 -				M 0948	MG0948			H.D.		TG0942
VTS	1997 -		220			MG0951 MG0950		55			TG0942
	1997 -		220		M 0949 M 0948	MG0949 MG0948		55			TG0942

### ZX

1.1, 1.4	1990 - 1998		220		M 0953	MG0953		55		T 0929	TG3020
1.1, 1.4	1990 - 1998				M 0952	MG0952					
1.6, 1.8	1990 - 1998		220		M 0949	MG0949		55	N.D.	T 0929	TG3020
1.8D, 1.9D	1991 - 1996				M 0948	MG0948			H.D.		TG0942
1.9TD excl. Volcane	1991 - 1996										
1.9i, 2.0i (Ch. → 5683)	1990 - 05.91		220			MG0923		55			TG0942
1.9i, 2.0i (Ch. → 5683)	1990 - 05.91					MG0924					
1.9i, 2.0i (Ch. 5684 →)	06.91 - 1998		220			MG0951		55			TG0942
1.9i, 2.0i (Ch. 5684 →)	06.91 - 1998					MG0950					
1.9TD Volcane (Ch. 5684 →)	1991 - 1998										
2.0i 16V	1993 - 1998										
	1994 - 1998		220		M 0949 M 0948	MG0949 MG0948		55		T 0936	TG0936



ANTERIORE  
FRONT



POSTERIORE  
REAR

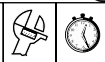

OIL

GAS

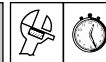

OIL

GAS

## DACIA

### 1000 SERIES

	1.3 (1210, 1310, 1410)	1970 -		125		S 3322			85		T 3323	
	1.3 (1210, 1310, 1410)	1970 -										

## DAEWOO

### ESPERO

		01.95 -			ACC59	C 2927	CG2927				T 2908	TG2908
--	--	---------	--	--	-------	--------	--------	--	--	--	--------	--------

### LANOS

		1997 -			ACC59	C 2927	CG2927				T 2908	TG2908
--	--	--------	--	--	-------	--------	--------	--	--	--	--------	--------

### LEGANZA

		1997 -					MG5913					MG5915
							MG5914					MG5916

### MATIZ

		1998 -				M 5901	MG5901				T 5903	TG5903
						M 5902	MG5902					

### NEXIA / CIELO / RACER

		01.95 -			ACC59	C 2927	CG2927				T 2908	TG2908
--	--	---------	--	--	-------	--------	--------	--	--	--	--------	--------

### NUBIRA

	(EV)	1997 -					MG5907					MG5909
	(EV)	1997 -					MG5908					MG5910
	(EW, EX, EY)	1997 -					MG5911					MG5909
	(EW, EX, EY)	1997 -					MG5912					MG5910

### TACUMA

SE, SX, CDX		09.00 -										

### TICO

		1995 -				M 5905	MG5905				T 5906	TG5906
						M 5904	MG5904					

## DAF

### 200

		1987 -		30		H 1101			30		H 1103	
		1987 -		30		H 1102			30		H 1103	

### 400

		1987 -		30		H 1104			30		H 1105	
		1987 -		30		H 1104			30		H 1106	



ANTERIORE  
FRONT



POSTERIORE  
REAR

				<b>OIL</b>	<b>GAS</b>				<b>OIL</b>	<b>GAS</b>
--	--	--	--	------------	------------	--	--	--	------------	------------

## DAIHATSU

### APPLAUSE

(101) excl. ABS, 4x4	1989 -											
ABS (111) excl. 4x4	1989 -											

### CHARADE

(G11, G21)	1983 - 1986				M 1201			65		T 1203	
,  Diesel (G30)	1983 - 1986				M 1202						
(G100, G101, G102) excl. 4x4, GTi	01.87 - 12.92										
(G200, G202, G203) excl. ABS	01.93 -										
ABS (G200, G202, G203)	01.93 -										
1.6 GTi (G201)	01.93 -										

### CHARMANT

(A10, A20, A30, A40)	1974 - 1982				C 1204						
(A10, A20, A40)	1974 - 1982										
1.3 (A35)	10.81 - 08.83		180		C 1205	CG1205		50		T 1206	TG1206
1.3 (A35)	09.83 - 1988		180			CG1207		50		T 1206	TG1206
1.6 (A45)	10.81 - 08.83										
1.6 (A60)	09.83 - 1988										

### FEROZA

F 300 series excl. F310,	10.88 -		85			HG1208		85			HG1209
F 310 series excl.	06.92 -										

### FOUR TRAK / ROCKY / TAFT

(F10, F20, F50, F60)	1974 - 1984				H 1210	HG1210				H 1211	
(F25, F55, F65)	1979 - 1984		60		H 1210	HG1210				H 2836	
(F70, F75, F80, F85)	1984 - 04.93		60			HG1209		85			HG1209
(F77, F87)	1984 - 04.93		60			HG1209					
(F73, F78, F98)	05.93 -					HG1213					HG1214
	1984 - 04.93				T 1212						

### SIRION / STORIA

1.0, 1.3	1999 -										
1.3 4WD	1999 -										

### TERIOS

	03.97 -					MG1215 MG1216					TG1217
--	---------	--	--	--	--	------------------	--	--	--	--	--------

### WIDE CAB (850-1000)

(S65V)	04.81 - 11.83									T 0703	TG0703
(S70, S75)	01.83 -							40	N.D. H.D.	T 1704	TG1704 HG1210
4x4 (S76)	05.84 -							40			HG1210



ANTERIORE  
FRONT



POSTERIORE  
REAR

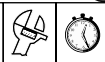

OIL

GAS

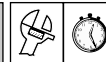

OIL

GAS

## FIAT

### 124

,  ,	1968 - 1977		40		T 1301			40		T 1302	
	1966 - 1975		40		T 1301			40		T 1303	TG1303

### 125

(incl. Special)	1967 - 1972		60		T 1304					T 1305	
-----------------	-------------	--	----	--	--------	--	--	--	--	--------	--

### 126

excl. 126 Bis	1972 - 08.87		45		T 1306			45		T 1307	
Bis	09.87 -		45		T 1306			45		T 1364	

### 127

excl. Panorama, Diesel	1971 - 1984		75		M 1308	MG1308		70		M 0504	MG0504
1.1, 1.3 Sport	1978 - 1984										
Panorama	1979 - 1984		75		M 1308	MG1308		70		M 1310	
Diesel	1979 - 1984		75		M 1309			70		M 1310	

### 128

	1969 - 1981		70		M 1311			70		M 1312	
--	-------------	--	----	--	--------	--	--	----	--	--------	--

### 131

excl. Diesel (Ch. → 4214186)	1974 - 02.78		80		M 1313			70		T 1302	
excl. Diesel (Ch. 4214186 →)	03.78 - 02.81		80		M 1314			70		T 1302	
excl. Diesel	03.81 - 1985		80		M 1315			70		T 1302	
Diesel (Ch. → 1012810)	03.78 - 09.79		80		M 1316			70		T 1302	
Diesel (Ch. 1012811 → 1061527)	10.79 - 09.81		80		M 1317			70		T 1302	
Diesel	10.81 - 1984		80		M 1317			70		T 1302	
131 S	1975 - 1978		80		M 1313			70		T 1302	
131 Racing	1978 - 1984		80		M 1314			70		T 1302	
excl. Diesel (Ch. → 4214186)	1974 - 02.78		80		M 1313			40		T 1319	
excl. Diesel (Ch. 4214186 →)	03.78 - 02.81		80		M 1314			40		T 1319	
excl. Diesel	03.81 - 1985		80		M 1315			40		T 1319	
Diesel	10.81 - 1984		80		M 1317			40		T 1319	

### 132

	1972 - 1986		40		T 1304			70		T 1320	
--	-------------	--	----	--	--------	--	--	----	--	--------	--

### 147

(Ch. → 359244)	1976 -		75		M 1309			70		M 0504	MG0504
(Ch. 359245 →)	1976 -		75		M 1309			70			

### 238

	1969 - 1983				T 1346					T 1347	
--	-------------	--	--	--	--------	--	--	--	--	--------	--

### 242

	-		60		T 0930			60		H 0931	



ANTERIORE  
FRONT

POSTERIORE  
REAR



## FIAT

### 500

D, F, L, N, R	1959 - 1975		45		T 1306			45		T 1307	
---------------	-------------	--	----	--	--------	--	--	----	--	--------	--

### 600

600, 600D	1955 - 1971		60		T 1321			60		T 1322	
-----------	-------------	--	----	--	--------	--	--	----	--	--------	--

### 850 / 900

(incl. 850 L) Special, Sport	1964 - 1971		60		T 1323			60		T 1324	
(850T, 600T, 900T)	-		60					60			

### ARGENTA

	1981 - 1986		40		T 1304			70		T 1320	
--	-------------	--	----	--	--------	--	--	----	--	--------	--

### BARCETTA

(183)	03.95 -		80	ACC61		MG1370		45			TG1371
-------	---------	--	----	-------	--	--------	--	----	--	--	--------

### BRAVA / BRAVO

1.4 (Ch. → 4085697)	1995 - 1996		40	ACC78	M 1338	MG1338		45	N.D. H.D.	T 1375	TG0624 TG1375
1.4 (Ch. 4085697 →)	1996 - 2001		40	ACC78	M 1372	MG1372		45	N.D. H.D.	T 1375	TG0624 TG1375
1.6, 1.9D, 2.0D excl. Sport Pack	1995 - 2001										
1.2 16V	1998 - 2001										
1.8, 1.9TD, 1.9 JTD excl. Sport Pack	1995 - 2001		40	ACC78	M 1374	MG1374		45	N.D. H.D.	T 1375	TG0624 TG1375
2.0 20V excl. Sport Pack	1995 - 2001		40	ACC78		MG1376		45			TG1399
Sport Pack	1995 - 2001		40					45			TG1399

### CINQUECENTO

700 cc., 900 cc.	1992 -		135	ACC42	M 0608	MG0608		40		T 1326	
1.1i Sporting	1994 -		135	ACC42		MG0608		40			TG1318

### COUPE

1.8 16V, 2.0 16V	11.93 -		80			MG1368		25			TG1369
2.0 20V excl. Turbo	1996 -										
2.0 16V Turbo	11.93 -		80			MG1378		25			TG1369
2.0 20V Turbo	1996 -		80			MG0603		25			TG1369

### CROMA

	1985 - 09.86		70	ACC92		MG1329		130	ACC27		MG1328
excl.	10.86 -		70	ACC92		MG1329		130	ACC27		MG1330

### DOBLO'

1.2 (SX, ELX)	08.00 -		110		M 0620	MG0620		50		T 0622	TG0622
1.2 (SX, ELX)	08.00 -										
1.9D, 1.9 JTD (SX, ELX)	08.00 -		110		M 0621	MG0621		50		T 0623	TG0623
1.9D, 1.9 JTD (SX, ELX)	08.00 -										



ANTERIORE  
FRONT



POSTERIORE  
REAR

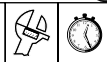

OIL

GAS

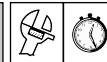

OIL

GAS

## FIAT

### DUCATO

(280, Ch. → 284529)	1980 - 04.84		150	ACC100	M 0932		45	<b>21</b>	H 0934	
10 Q.li (280, 290) Ch. 284530 →	04.84 - 1994		150	ACC100	M 0933		45	<b>21</b>	H 0934	
14 Q.li (280, 290) Ch. 284530 →	04.84 - 1994									
18 Q.li Maxi (280, 290)	1986 - 1994		150	ACC100	M 0601		45	<b>21</b>	H 0602	
4x4 (280, 290)	1985 - 1994		150	ACC100	M 0933					
,  4x4 (280, 290)	1990 - 1994									
,  (280) Ch. → 284529	1980 - 04.84		150	ACC100	M 0932		45	<b>21</b>	H 0602	
,  (280, 290) Ch. 284530 → excl. 18 Q.li Maxi	04.84 - 1994		150	ACC100	M 0933		45	<b>21</b>	H 0935	
, Panorama (280, 290) Combinato (280, 290)	04.84 - 1994 1990 - 1994		150	ACC100	M 0933		45	<b>21</b>	H 0934	
Camping Car	1990 - 1994		150	ACC100	M 0933					
Express (10, 13, 15)	04.84 - 1994		150	ACC100	M 0933		45	<b>21</b>	H 0934	
							45	<b>21</b>	H 0935	
,  10 Q.li (230)	01.94 - 2002		170	ACC100	M 1355		45			HG1356
,  14 Q.li (230)	01.94 - 2002									
18 Q.li (230)	01.94 - 2002		170	ACC100	M 1385		45			HG1383
18 Q.li (230)	01.94 - 2002		170	ACC100	M 1385		45			HG1383
Panorama 4x2 (230) excl. 18 Q.li	01.94 - 2002		170	ACC100	M 1355					
Panorama 4x4 (230)	01.94 - 2002									
Combinato 4x2 (230) excl. 18 Q.li	01.94 - 2002		170	ACC100	M 1355		45			HG1356
Combinato 4x4 (230) excl. 18 Q.li	01.94 - 2002									
Camping Car	01.94 - 2002		170	ACC100	M 1385					
Grand Export	01.94 - 2002									

**21**

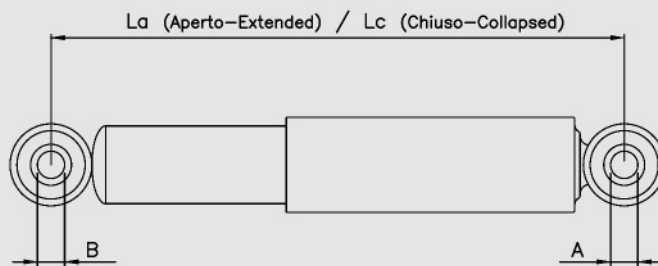

**H 0934**

A=10 mm.  
B=16 mm.  
La=570 mm.  
Lc=360 mm.

**H 0935**

A=16 mm.  
B=10 mm.  
La=535 mm.  
Lc=342 mm.

**H 0602**

A=10 mm.  
B=16 mm.  
La=590 mm.  
Lc=367 mm.

### DUNA

	1987 - 1991		90		M 1331		70		M 1332	
, Penny Ch. → 3400630	1987 - 1993		90		M 1331		70		M 1332	
, Penny Ch. 3400631 →	1993 -		90		M 1360		70		M 1332	



ANTERIORE  
FRONT



POSTERIORE  
REAR



## FIAT

### FIORINO

EU (Ch. → 7017071)	1977 - 06.82		75		M 1308	MG1308		70		M 0504	MG0504
EU (Ch. 7017072 →)	07.82 - 1984		75		M 1308	MG1308		60		M 1310	
,  BR	07.82 - 1987		70		M 1309			60		M 1310	
BR (Type 147)	1987 - 1988		70		M 1331			60		M 1332	
,  BR (Ch. 8000001 → 8149536)	1988 - 1990		70		M 1331			60		M 1359	
,  BR (Ch. 8149537 →)	1991 - 1993		80		M 1360			60		M 1359	
,  BR	1993 -		80		M 1360			30		T 1361	TG1361

### MAREA

,  1.4, 1.6, 1.8	1996 -		85			MG1394		45	N.D.		TG0624
,  1.9TD, 1.9 JTD	1996 -								H.D.	T 1375	TG1375
,  2.0	1996 -		85			MG1395		45			TG1399
,  2.4TD, 2.4 JTD	1996 -										

### MULTIPLA

excl. Bipower, Bluepower	1998 -		80			MG0606		25			TG0607
--------------------------	--------	--	----	--	--	--------	--	----	--	--	--------

### PALIO / SIENA

	1999 -		80			MG0605		50			TG0614
	1997 -		80			MG0605		25		T 1375	TG1375

### PANDA

excl. 4x4	1980 - 1986		70	ACC45	M 1333	MG1333		30		T 1334	
excl. 4x4	1986 -		70	ACC45	M 1333	MG1333		30		T 0507	TG0507
4x4	1985 -		70	ACC45	M 1365	MG1365		30		T 0508	TG0508

### PUNTO

1.1, 1.2, 1.6, 1.7D	11.93 - 1999		85	ACC60	M 1349	MG1349		50	N.D. H.D.	T 1351	TG0626 TG1351
1.4 Turbo GT	11.93 - 1999		85			MG1354		50	N.D. H.D.	T 1351	TG0626 TG1351
1.7 TD	11.93 - 1999		85	ACC60	M 1350	MG1350		50	N.D. H.D.	T 1351	TG0626 TG1351
1.2 (60, 80) excl. Sporting	09.99 -		85			MG0609		50			TG0610
1.9 D, 1.9 JTD	09.99 -		85			MG0611		50			TG0610
1.2 16V Sporting	09.99 -		85			MG0612		50			TG0613
1.8 16V	09.99 -										

### REGATA

	1983 - 1990		70	ACC43	M 1337	MG1337		70		M 3702	MG3702
Weekend	1984 - 1990		70	ACC43	M 1337	MG1337		70		M 1353	MG1353

### RITMO / STRADA

excl. 125 TC	1978 - 10.82		70	ACC21	M 1335	MG1335		70		M 3702	MG3702
125 TC	1982 - 10.82					MG0627		70		M 3702	MG3702
excl. Abarth	11.82 - 1988		70	ACC43	M 1337	MG1337		70		M 3702	MG3702
Abarth 125, 130 TC	11.82 - 1988					MG0628		70		M 3702	MG3702



ANTERIORE  
FRONT



POSTERIORE  
REAR



OIL

GAS



OIL

GAS

## FIAT

### SCUDO

(220L, 220P) Ch. → 7609	1995 - 09.97		90		M 0943			45		T 1367	TG1367
(220L, 220P) Ch. 7610 →	10.97 -		90		M 0943			45		T 0944	TG0944

### SEICENTO

excl. Sporting	1998 -		80	ACC42	M 0608	MG0608		40		T 1326	
Sporting	1998 -		80	ACC42		MG0608		40			TG1318
Van	1998 -		80	ACC42	M 0608	MG0608		40		T 1326	

### STILO

1.2 16V, 1.6 16V	10.01 -		90			MG0615		45			TG0618
1.8, 1.9 JTD	10.01 -		90			MG0616		45			TG0618
2.0 20V Abarth	10.01 -		90			MG0617		45			TG0619

### TALENTO

excl.	1988 -		150	ACC100	M 0933			45	<b>21</b>	H 0934	
	1988 -		150	ACC100	M 0933			45	<b>21</b>	H 0935	

**21** Vedi disegno Fiat Ducato a pagina 23 - See drawing Fiat Ducato on page 23

### TEMPRA

1.4, 1.6, 1.9D (159)	1990 - 1996		70	ACC78	M 1338	MG1338		45	N.D.		TG0625
									H.D.	T 1340	TG1340
1.8, 2.0, 1.9TD (159)	1990 - 1996		70	ACC49	M 1339	MG1339		45	N.D.		TG0625
									H.D.	T 1340	TG1340
1.4, 1.6, 1.9D (159) excl. 4x4	1990 - 1996		70	ACC78	M 1338	MG1338		45	excl.		TG1348
1.8, 2.0, 1.9TD (159) excl. 4x4	1990 - 1996		70	ACC49	M 1339	MG1339		45	excl.		TG1348
	1990 -		70	ACC49	M 1339	MG1339					
4x4	1990 -		70	ACC49	M 1339	MG1339		45			TG1399

### TIPO

1.1, 1.4, 1.6, 1.7 D, 1.9 D	1988 - 1996		70	ACC78	M 1338	MG1338		45	N.D.		TG0625
									H.D.	T 1340	TG1340
1.8, 2.0, 1.9 TD	1988 - 1995		70	ACC49	M 1339	MG1339		45	N.D.		TG0624
1.8 16V, 2.0 16V	1990 - 1995								H.D.	T 1375	TG1375

### ULYSSE

(220) Ch. → 7609	03.94 - 09.97		90		M 1366	MG1366		45		T 1367	TG1367
(220) Ch. 7610 →	10.97 -		90		M 1366	MG1366		45		T 0944	TG0944

### UNO

(146A, 146E) excl. ABS, CS	1983 - 1995		80	ACC63	M 1341	MG1341		50		T 1343	TG1343
Turbo (146A, 146E) excl. ABS, CS	1983 - 1995		80	ACC63		MG1341		50			TG1343
CS	1988 - 1991		90		M 1331			70		M 1332	

### X 1/9

1.3	1972 - 1978		90		M 1379			90		M 1380	
1.5 Europa	1972 - 1980		90		M 1379			90		M 1381	
1.5	-		90		M 1379			90		M 0629	





ANTERIORE  
FRONT



POSTERIORE  
REAR



## FORD

### CAPRI

excl. 2.8, 3.0	1972 - 1987		150	ACC19	C 1401	CG1401		50		T 1402	
2.8, 3.0	1978 - 1988							50		T 1402	

### CONSUL

	1971 - 1975		55		T 1403	TG1403		50		T 1404	TG1404
--	-------------	--	----	--	--------	--------	--	----	--	--------	--------

### CORTINA

,  1.3, 1.6 (MK II)	09.67 - 08.70				C 1405						
1.3, 1.6, 2.0, 2.3 (MK III, MK IV)	09.70 - 1982				T 1403	TG1403				T 1406	TG1406

### COUGAR

	1998 -					MG1505					MG1506
--	--------	--	--	--	--	--------	--	--	--	--	--------

### COURIER

	1991 - 12.93		120	ACC69	M 1436	MG1436		50		T 1466	TG1466
	01.94 - 1996		120	ACC69	M 1471	MG1471		50		T 1466	TG1466
excl. 1.8 D	11.95 -		120		M 1476	MG1476		50		T 1466	TG1466
1.8 D	11.95 -		120		M 1482	MG1482		50		T 1466	TG1466

Vedi disegno Ford Fiesta a pagina 29 - See drawing Ford Fiesta on page 29

### ESCORT I

,  900, 1100, 1300, GT	1968 - 09.73				C 1407					T 1408	
Lotus Twin Cam	1968 - 1973			ACC19	C 1401	CG1401				T 1408	
RS 1600, Mexico	1971 - 1973										
900, 1100, 1300, Sport	10.73 - 1974				C 1409	CG1409				T 1410	TG1410
900, 1100, 1300	10.73 - 1974				C 1409	CG1409				T 1408	
RS 2000	1973 - 1974			ACC19	C 1401	CG1401					

### ESCORT II

900, 1100, 1300, 1600, Sport	01.75 - 1980		90		C 1409	CG1409		40		T 1410	TG1410
900, 1100, 1300, 1600	01.75 - 1980		90		C 1409	CG1409		40		T 1408	
RS 1800	1975 - 1980			ACC19	C 1401	CG1401		40		T 1410	TG1410
RS Mexico	1976 - 1980										
RS 2000	1975 - 1980							40		T 1410	TG1410

### ESCORT III - IV

,  excl. XR3	1980 - 05.83		60	ACC69	M 1411	MG1411		55		M 1412	MG1412
,  excl. Diesel, XR3, RS	06.83 - 07.90		60	ACC69	M 1413	MG1413		55		M 1412	MG1412
,  Diesel	06.83 - 07.90		60	ACC69	M 1414	MG1414		55		M 1412	MG1412
XR 3i	10.82 - 05.83										MG1412
XR 3i	06.83 - 07.90			ACC69		MG1413					MG1412
RS Turbo	1984 - 07.90										
	06.83 - 07.90			ACC69	M 1413	MG1413				M 1412	MG1412
(35, 55)	1980 - 05.83							40		T 1425	
	06.83 - 09.90		60		M 1426			40		T 1425	



ANTERIORE  
FRONT



POSTERIORE  
REAR



OIL

GAS

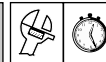

OIL

GAS

## FORD

**26**

M 1484  
M 1485  
MG1484  
MG1485

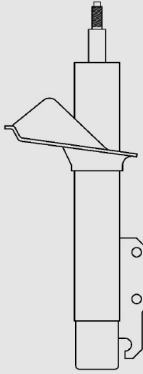

**27**

M 1417  
MG1417

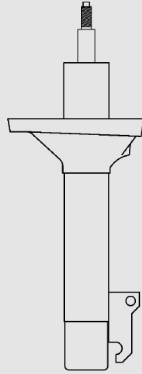

**28**

M 1421  
MG1421

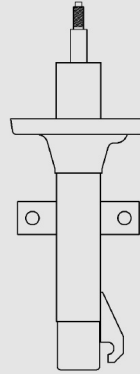

**29**

T 1419  
TG1419  
Ø 10 mm.

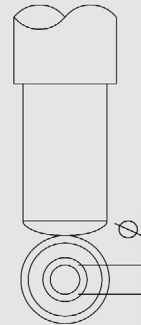

T 1500  
TG1500  
Ø 12 mm.

## ESCORT V

1.1, 1.3	08.90 - 1995		90	<b>27</b>	M 1417	MG1417		45		S 1418	SG1418
1.4, 1.8 D	08.90 - 10.90			ACC69							
1.4, 1.8 D, 1.8 TD	10.90 - 1995		90	<b>28</b>	M 1421	MG1421		45		S 1418	SG1418
1.6	08.90 - 1995			ACC69							
1.8i excl. Sport	01.92 - 1995										
1.4i, 1.6i	08.90 - 1995		90	<b>28</b>	M 1421	MG1421		45		S 1423	SG1423
1.8i Sport	01.92 - 1995			ACC69							
1.3i, 1.4i, 1.6i	01.95 - 1999			<b>26</b>	M 1484	MG1484		45		S 1474	SG1474
1.6i 16V, 1.8i, 1.8i 16V excl. 4x4	01.95 - 1999			<b>26</b>	M 1485	MG1485		45		S 1475	SG1475
1.8 D, 1.8 TD	01.95 - 1999										
XR3i	1992 - 1995		90	<b>28</b>		MG1421		45			SG1423
2.0 16V RS excl. 4x4	1992 - 1995					MG1469		45			SG1470
2.0 16V RS excl. 4x4	01.95 - 1999			<b>26</b>		MG1485					
RS Turbo 4x4 excl. Cosworth	1991 - 1995					MG1469					
1.6i 4x4	1995 - 1999										
2.0 RS 4x4 excl. Cosworth	1995 - 1999										
Cosworth 4x4	1993 - 1995					MG1488					TG1490
1.3	08.90 - 08.95		90	<b>27</b>	M 1417	MG1417		45	<b>29</b>	T 1419	TG1419
1.4, 1.8 D	08.90 - 10.90			ACC69							
1.4, 1.4i, 1.6, 1.6i, 1.6i 16V	08.90 - 1995		90	<b>28</b>	M 1421	MG1421		45	<b>29</b>	T 1419	TG1419
1.8i	01.92 - 1995			ACC69							
1.8 D, 1.8 TD	10.90 - 1995										
1.3i	08.95 - 1999		90	<b>27</b>	M 1417	MG1417		45	<b>29</b>	T 1500	TG1500
				ACC69							
1.4i, 1.6i	01.95 - 08.95			<b>26</b>	M 1484	MG1484		45	<b>29</b>	T 1419	TG1419
1.4i, 1.6i	08.95 - 1999			<b>26</b>	M 1484	MG1484			<b>29</b>	T 1500	TG1500
1.6i 16V, 1.8i, 1.8i 16V	01.95 - 08.95			<b>26</b>	M 1485	MG1485		45	<b>29</b>	T 1419	TG1419
1.8 D, 1.8 TD	01.95 - 08.95										
1.6i 16V, 1.8i, 1.8i 16V	08.95 - 1999			<b>26</b>	M 1485	MG1485			<b>29</b>	T 1500	TG1500
1.8 D, 1.8 TD	08.95 - 1999										
1.4, 1.6i, 1.8i, XR3i	08.90 - 1995		90	<b>28</b>		MG1421		45			SG1423
				ACC69							
1.4i, 1.6i, 1.8 TD, XR3i	01.95 - 1999			<b>26</b>	M 1485	MG1485		45		S 1475	SG1475



ANTERIORE  
FRONT

POSTERIORE  
REAR



## FORD

### ESCORT EXPRESS

Express 500 Kg	1991 - 1995		90	<b>27</b> ACC69	M 1417	MG1417		45		T 1427	
Express 500 Kg - 700 Kg	01.95 - 1999			<b>26</b>	M 1485	MG1485		45		T 1427	
Express 700 Kg	1991 - 1995		90	<b>28</b> ACC69	M 1421	MG1421		45		T 1427	

**26** - **27** - **28** Vedi disegno Ford Escort a pagina 27 - See drawing Ford Escort on page 27

### EXPLORER

	1991 - 1994					HG1493					HG1494
	1995 -					HG1495					HG1496

### FIESTA I

excl. XR2	1976 - 08.83		120		M 1429	MG1429		50		M 1430	MG1430
XR2	1981 - 08.83		120			MG1431		50			MG1430

### FIESTA II

excl. XR2	09.83 - 12.88		120	ACC69	M 1432	MG1432		50		M 1430	MG1430
XR2	09.83 - 12.88		120	ACC69		MG1433		50			MG1430
	09.83 - 12.88		120	ACC69	M 1432	MG1432		50		M 1430	MG1430

### FIESTA III

1.0, 1.1, 1.3	01.89 - 12.93		120	<b>22</b> ACC69	M 1434	MG1434		50		S 1435	SG1435
1.4, 1.6				ACC69							
1.3 SX, 1.4 S, 1.4 Si, 1.6 S	01.89 - 12.93		120	<b>23</b>	M 1436	MG1436		50		S 1435	SG1435
1.8 Si, 1.8 D, 1.8 TD	01.89 - 12.93			ACC69							
1.1, 1.3, 1.4 (C, CLX)	01.94 - 1995		120	<b>22</b> ACC69	M 1464	MG1464		50		S 1465	SG1465
1.1, 1.3, 1.4 (Ghia)	01.94 - 1995			ACC69							
1.1, 1.3, 1.4 (Youth)	01.94 - 1995										
1.8D	01.94 - 1995										
1.1, 1.3, 1.4 (C, CLX)	01.94 - 1995		120	<b>23</b> ACC69	M 1471	MG1471		50		S 1465	SG1465
1.1, 1.3, 1.4 (Ghia)	01.94 - 1995			ACC69							
1.1, 1.3, 1.4 (Youth)	01.94 - 1995										
1.8D	01.94 - 1995										
1.1, 1.3, 1.4 (SX)	01.94 - 1995		120	<b>23</b> ACC69	M 1471	MG1471		50		S 1465	SG1465
1.4 Si, 1.4 Futura	01.94 - 1995			ACC69							
1.6 Ghia	01.94 - 1995										
1.6 Si, 1.6 LX, 1.6 Futura	01.94 - 1997										
XR2i	01.89 - 12.93		120	<b>23</b> ACC69		MG1436		50			SG1435
RS 1.8	01.89 - 12.93			ACC69							
XR2i	01.94 - 1997		120	<b>23</b> ACC69	M 1471	MG1471		50		S 1465	SG1465
RS 1.8	01.94 - 1997			ACC69							
Turbo	1990 - 12.93		120	<b>23</b> ACC69		MG1436		50			SG1468
excl. Courier	01.89 - 12.93		120	<b>22</b> ACC69	M 1434	MG1434		50		S 1435	SG1435
excl. Courier	01.94 - 1995		120	<b>23</b> ACC69	M 1471	MG1471		50		S 1465	SG1465



ANTERIORE  
FRONT



POSTERIORE  
REAR

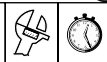

OIL

GAS

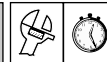

OIL

GAS

## FORD

### FIESTA IV

1.0, 1.3 (JAS, JBS)	08.95 - 10.98		120		M 1476	MG1476		60	<b>25</b>	S 1477	SG1477
1.2 16V, 1.4 16V (JAS, JBS)	08.95 - 10.98										
1.8 D (JAS, JBS)	08.95 - 10.98		120		M 1482	MG1482		60	<b>25</b>	S 1477	SG1477
1.0, 1.3 (JAS, JBS)	10.98 - 2002		120		M 1476	MG1476		60	<b>24</b>	S 1507	SG1507
1.2 16V, 1.4 16V (JAS, JBS)	10.98 - 2002										
1.8 D, 1.8 TDDi (JAS, JBS)	10.98 - 2002		120		M 1482	MG1482		60	<b>24</b>	S 1507	SG1507
1.6 16V Sport	2000 - 2002		120								
Van excl. 1.8 D	08.95 - 06.97		120		M 1476	MG1476		60	<b>25</b>	S 1477	SG1477
Van 1.0, 1.3	07.97 - 10.98		120		M 1482	MG1482		60	<b>25</b>	S 1477	SG1477
Van 1.2 16V, 1.4 16V	07.97 - 10.98										
Van 1.8 D	08.95 - 10.98										
Van	10.98 -		120		M 1482	MG1482		60	<b>24</b>	S 1507	SG1507

### FIESTA CLASSIC

1.1, 1.3, 1.4 (C, CLX)	1996 - 1997		120	<b>22</b>	M 1464	MG1464		50		S 1465	SG1465
1.1, 1.3, 1.4 (Ghia)	1996 - 1997										
1.1, 1.3, 1.4 (Youth)	1996 - 1997										
1.8 D, 1.8 TD	1996 - 1997										
1.1, 1.3, 1.4 (C, CLX)	1996 - 1997		120	<b>23</b>	M 1471	MG1471		50		S 1465	SG1465
1.1, 1.3, 1.4 (Ghia)	1996 - 1997										
1.1, 1.3, 1.4 (Youth)	1996 - 1997										
1.8 D, 1.8 TD	1996 - 1997										
1.1, 1.3, 1.4 (SX)	1996 - 1997		120	<b>23</b>	M 1471	MG1471		50		S 1465	SG1465
1.4 Si, 1.4 Futura	1996 - 1997										
1.6 Ghia	1996 - 1997										

<b>22</b>	<b>23</b>	<b>24</b>	<b>25</b>
M 1434 MG1434 Ø 44,5 mm.	M 1436 MG1436 Ø 44,5 mm.	S 1507 SG1507 S 1504 SG1504	S 1477 SG1477 S 1481 SG1481
M 1464 MG1464 Ø 45,5 mm.	M 1471 MG1471 Ø 45,5 mm.		

### FOCUS

	06.98 -		120		M 1501	MG1501		50		T 1498	TG1498
	06.98 -		120		M 1502	MG1502		50		T 1503	TG1503
					M 1501	MG1501		50			
					M 1502	MG1502		50			



ANTERIORE  
FRONT



POSTERIORE  
REAR



## FORD

### GALAXY

	02.95 -		70		M 1478	MG1478		40	excl.	T 1479	TG1479
--	---------	--	----	--	--------	--------	--	----	-------	--------	--------

### GRANADA

	1971 - 1985		55		T 1403	TG1403				T 1404	TG1404
excl. V6, 4x4	03.85 - 10.94		85		M 1439	MG1439		50	excl.	T 1440	TG1440
2.9 24V excl. 4x4	1991 - 10.94		85			MG1441		50	excl.		TG1440
	1992 - 10.94		85		M 1441	MG1441					

### KA

	1996 - 10.98		120		M 1480	MG1480		60	<b>25</b>	S 1481	SG1481
	10.98 - 03.00		120		M 1480	MG1480		60	<b>24</b>	S 1504	SG1504
	04.00 -		120		M 1480	MG1480		60			

**24** - **25** Vedi disegno Ford Fiesta a pagina 29 - See drawing Ford Fiesta on page 29

### MAVERICK

	02.93 -		30			HG2861		40			HG2880
--	---------	--	----	--	--	--------	--	----	--	--	--------

### MONDEO

excl. , 4x4	03.93 - 05.93					MG1459		120		M 1460	MG1460
excl. , 4x4	06.93 - 1996		90		M 1461	MG1461		120		M 1460	MG1460
excl.	09.96 - 2000				M 1491	MG1491		120		M 1460	MG1460
CLIPPER excl. , 4x4	03.93 - 05.93					MG1459			excl.		TG1463
CLIPPER excl. , 4x4	06.93 - 1996		90		M 1461	MG1461			excl.		TG1463
excl.	09.96 - 2000				M 1491	MG1491			excl.		TG1463
,  4x4 excl.	10.94 - 10.96		90		M 1461	MG1461					MG1487
excl. Sport Susp.	09.01 -					MG1508			excl.		MG1509
excl. Sport Susp.	09.01 -					MG1508			excl.		TG1510

### ORION

excl. Diesel, 1.6i	1983 - 07.90		90		M 1413	MG1413		55		M 1412	MG1412
Diesel	1983 - 07.90		90		M 1414	MG1414		55		M 1412	MG1412
1.6i	1983 - 07.90		90			MG1413		55			MG1412
1.3	08.90 - 1995		90	<b>27</b>	M 1417	MG1417		45		S 1418	SG1418
1.4	08.90 - 10.90										
1.4	10.90 - 1995		90	<b>28</b>	M 1421	MG1421		45		S 1418	SG1418
1.4i, 1.6, 1.6i, 1.8i excl. Ghia	08.90 - 1995										
1.4i, 1.6i (Ghia)	08.90 - 1995		90	<b>28</b>	M 1421	MG1421		45		S 1423	SG1423
1.8i (Ghia)											
1.8 D	08.90 - 10.90		90	<b>27</b>	M 1417	MG1417		45		S 1418	SG1418
1.8 D, 1.8 TD	11.90 - 1995		90	<b>28</b>	M 1421	MG1421		45		S 1418	SG1418

**27** - **28** Vedi disegno Ford Escort a pagina 27 - See drawing Ford Escort on page 27



ANTERIORE  
FRONT



POSTERIORE  
REAR

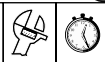

OIL

GAS

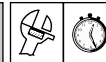

OIL

GAS

## FORD

### PICK UP

Cortina, Taunus (1000 Kg)	1982 - 07.83		60		H 1455						
Cortina, Taunus (1000 Kg)	08.83 - 1988		60		H 1455			45		H 1456	
Sierra	1988 -		100		M 1458			45		H 1457	

### PROBE

GL, LX excl.	1989 - 1992				ACC16	MG2413				ACC19	MG2414
	1993 - 1997		55			MG2415		50			MG2417
						MG2416					

### PUMA

	1997 - 10.98		120			MG1492		50	<b>25</b>		SG1477
	10.98 -		120			MG1492		50	<b>24</b>		SG1507

**24 - 25** Vedi disegno Ford Fiesta a pagina 29 - See drawing Ford Fiesta on page 29

### SCORPIO

excl. 24V, 4x4	03.85 - 10.94		85		M 1439	MG1439		50	excl.	T 1440	TG1440
2.9 24V excl. 4x4	1991 - 10.94		85			MG1441		50	excl.		TG1440
	10.94 -		60					50	excl.		TG1440
	1992 - 10.94		85		M 1441	MG1441					
	10.94 -		60								

### SIERRA

excl. XR4i	1982 - 04.84		60		ACC81	M 1442	MG1442		50		T 1443	TG1443
XR4i	1983 - 04.84		60				MG1442		50			TG1443
excl. 2.8i, 2.9i, 4x4, XR4i, Cosworth	05.84 - 1993		60		ACC81	M 1445	MG1445		50		T 1443	TG1443
2.8i, 2.9i, XR4i excl. 4x4, Cosworth	05.84 - 1993		60		ACC81		MG1445		50			TG1443
4x4 excl. Cosworth	05.84 - 1993						MG1489					TG1490
4x2 Cosworth	1986 - 1990						MG1472					TG1490
4x4 Cosworth	1990 - 1993						MG1489					TG1490
excl. 4x4	1982 - 04.84		60		ACC81	M 1442	MG1442		75	<b>31</b>	T 1444	TG1444
excl. 4x4	05.84 - 1993		60		ACC81	M 1445	MG1445		75	<b>31</b>	T 1444	TG1444
4x4	05.84 - 1993						MG1489		75	<b>31</b>		TG1444

### TAUNUS

17M (P3), 20M (P5)	1964 - 08.70				C 1473						
26M (P7)	1964 - 08.70										
1.3, 1.6, 2.0, 2.3	09.70 - 1982		55		T 1403	TG1403		50		T 1406	TG1406
	09.70 - 1982										



ANTERIORE  
FRONT

POSTERIORE  
REAR



## FORD

### TRANSIT

FT75, FT100 (●-●2.7 m)	09.70 - 1977			N.D.	T 1447				T 1448	
FT80, FT100, FT120 (●-●2.7 m)	1978 - 1985			H.D.	H 1447					
FT125, FT130, FT150, FT175 (●-●3 m)	09.70 - 1977			N.D.	T 1447				N.D.	T 1449
FT100L, FT130, FT160, FT190 (●-●3 m)	1978 - 1985			H.D.	H 1447				H.D.	H 1449
	09.70 - 1985			N.D.	T 1447				N.D.	T 1449
				H.D.	H 1447				H.D.	H 1449
, Combinato	09.70 - 1985				H 1447					
80, 100, 115, 120 (●-●2.84 m)	1986 - 08.91		75		M 1450			50		H 1451
100L, 130, 160, 190 (●-●3 m)	1986 - 08.91		40		H 1452			50		H 1451
80, 100, 115, 120 (●-●2.84 m)	09.91 - 08.94		60		M 1453			50		H 1447
150 S (●-●2.84 m)	09.91 - 2000		60		M 1453			50		H 1454
100L, 130, 150L, 190L (●-●3.57 m)	09.91 - 08.94									
190 (●-●3.57 m)	09.91 - 08.94		60		M 1453			50		H 1447
80, 100S, 120 (●-●2.84 m)	09.94 - 2000		60		M 1453			50		H 1447
100L, 130, 150L, 190L (●-●3.57 m)	09.94 - 2000		60		M 1453			50		H 1454
190, 190EF (●-●3.57 m)	09.94 - 2000		60		M 1453					
,  FWD	2001 -				M 1511					H 1512
FWD	2001 -				M 1511					H 1513
,  ,  RWD	2001 -				M 1511					H 1514

## GAZ

### GAZEL

					HG3204					HG3204
--	--	--	--	--	--------	--	--	--	--	--------

### VOLGA

M21, M24	1963 -				T 3203	TG3203				T 3201	TG3201
----------	--------	--	--	--	--------	--------	--	--	--	--------	--------

## HANOMAG - HENSCHEL

### F SERIES

F40, 45KA	1971 -				T 2526					T 2526	
-----------	--------	--	--	--	--------	--	--	--	--	--------	--

## HONDA

### ACCORD / VIGOR

(SY, AC, AD)	10.81 - 05.85		85	ACC18		MG1602		145	ACC18		MG1603
(CA4, CA5)	06.85 - 1989		85			MG1604		145			MG1605
1.8, 2.0 (CB1, CB3) excl. 4WS	1990 - 1993		145			MG1606		145			MG1607
2.2 4WS (CB7)	1990 - 1993		145			MG1606					
(CC7)	1993 - 1995					MG1606		145			MG1607
1.8, 2.0, 2.3 (CC7)	01.96 - 1998					MG1606					MG1642
1.8, 2.0 (CE7, CE8)	01.96 - 1998										
2.0 Turbo Diesel (CF1)	01.96 - 1998										
2.2 V-Tec (CE9)	01.96 - 1998										
1.6, 1.8 (CG7, CG8)	1999 -					MG1643					MG1644
2.0, 2.0D (CG9, CH2)	1999 -										



ANTERIORE  
FRONT



POSTERIORE  
REAR

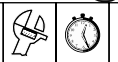

OIL

GAS

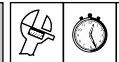

OIL

GAS

## HONDA

### ACCORD / VIGOR

Aerodeck (CB8)	1990 - 1993		145			MG1606		145			MG1608
Aerodeck (CE1, CE2)	1994 - 1998					MG1606					MG1636
2.0 (CC1)	1992 - 1996					MG1606					<u>MG1642</u>
2.0, 2.2 (CD7, CD9)	1993 - 1998					MG1606					MG1636
2.0, 2.3 Vti (CG3, CG4)	1999 -					<i>MG1655</i>					<i>MG1656</i>

### CIVIC / BALLADE

(OS)	1979 - 1983		135			MG1609		135			MG1610
1.2 (AL, AM)	1984 - 1987		85			MG1611		75			SG1612
1.3 (AJ, AG)	1984 - 1987										
1.5 (AH, AK)	1984 - 1987										
1.2 (EC7, ED1) Ch. → S100001	10.87 - 1988		135			MG1613		135			MG1614
1.3 (EC8) Ch. → S100001	10.87 - 1988										
1.4 (EC9, ED2) Ch. → S100001	10.87 - 1988										
1.5 (ED3, ED6) Ch. → S100001	10.87 - 1988										
1.6 (ED4, ED7) Ch. → S100001	10.87 - 1988										
1.2 (EC7, ED1) Ch. S100002 →	1989 - 11.91		135			MG1615		135			MG1616
1.3 (EC8) Ch. S100002 →	1989 - 11.91										
1.4 (EC9, ED2) Ch. S100001 →	1989 - 11.91										
1.5 (ED3, ED6) Ch. S100002 →	1989 - 11.91										
1.6 (ED4, ED7) Ch. S100002 →	1989 - 11.91										
1.6 4x4 (EE5) Ch. S100001 → S200001	1989 - 1990					MG1617					MG1618
1.6 4x4 (EE5) Ch. S200001 →	1990 - 11.91					MG1617					MG1619
,  1.3 (EG3)	12.91 - 1996		120			MG3514		120			MG1622
,  1.5 (EG4, EG8)	12.91 - 1996							135			MG1614
,  1.6 (EG5, EH9) incl. V-Tec	12.91 - 1996										
,  1.6 (EG6, EG9) incl. V-Tec, VTi	12.91 - 1996										
1.4 (MA8, MB2)	1995 - 2001		120			MG3514		120			MG1625
1.5 (MA9, MB3)	1995 - 2001										
1.6 (MB1, MB4)	1995 - 2001										
1.8 (MB6)	1995 - 2001										
2.0 TD (MB7)	1997 - 2001										
,  1.4 (EJ9)	1996 - 2001					<u>MG1645</u>					<u>MG1646</u>
,  1.5 (EK3)	1996 - 2001										
,  1.6 (EK1)	1996 - 2001										
,  1.6 VTi (EK4)	1996 - 2001										
incl. V-Tec											
1.5 CRX (AF)	1984 - 1987					MG1611					SG1612
1.6 CRX (AS)	1984 - 1987										
1.6 CRX (ED9) Ch. → 100001	10.87 - 1988		85			MG1613		130			MG1614
1.4 CRX (EE6) Ch. S200001 →	1990 - 1992		85			MG1615					MG1616
1.6 CRX DOHC (ED9) Ch. S100002 →	1989 - 1992										
1.6 CRX V-Tec (EE8) Ch. S100002 →	1990 - 1992										
1.6 CRX SOHC (ED9) Ch. S100002 →	1989 - 1992		85			MG1615					MG1614
1.6 CRX Esi (EH6)	1992 -		120			MG3514		120			MG1622
1.6 CRX VTi (EG2)	1992 -										





ANTERIORE  
FRONT



POSTERIORE  
REAR

				<b>OIL</b>	<b>GAS</b>					<b>OIL</b>	<b>GAS</b>
--	--	--	--	------------	------------	--	--	--	--	------------	------------

## HONDA

### CIVIC / BALLADE

1.5 (EJ1)	1994 - 1996		120			MG3514		120			MG1622
1.6 (EJ2)	1994 - 1996										
1.6 (EJ6)	1996 - 2001					MG1645					MG1646
1.6 VTi (EJ8, EM1)	1996 - 2001										
1.6 V-Tec (EJ7)	1996 - 2001										
	1979 - 1983		135	ACC11		MG1609		100			
1.4 (EE1) Ch. → S100001	1988 - 1989			←		MG1647		135			MG1619
1.5 (EE2) Ch. → S100001	1988 - 1989			→		MG1648					
1.6 4x4 (EE4) Ch. → S100001	1988 - 1989										
1.4 (EE1) Ch. S100002 → S200000	1989 - 1990		135			MG1617		135			MG1618
1.5 (EE2) Ch. S100002 → S200000	1989 - 1990										
1.6 4x4 (EE4) Ch. S100002 → S200000	1989 - 1990										
1.4 (EE1) Ch. S200001 →	1990 - 1994		135			MG1617		135			MG1619
1.5 (EE2) Ch. S200001 →	1990 - 1994										
1.6 4x4 (EE4) Ch. S200001 →	1990 - 1994										
1.4, 1.5, 1.6, 1.8	1995 -			←		MG1649					SG1651
2.0, 2.0TD	1995 -			→		MG1650					

### CONCERTO

1.4, 1.5, 1.8 TD (HW)	1990 -		105	←		MG1623		85			MG1625
1.6, 1.6 16V (HW)	1990 -			→		MG1624					

### CR-V

	1997 -					SG1641					TG1652
--	--------	--	--	--	--	--------	--	--	--	--	--------

### HR-V

1.6 4x2 (GH1)	1998 -			←		MG1661					TG1660
1.6 4x4 (GH2)	1998 -			→		MG1662					

### INTEGRA / QUINT

(AV, DA)	02.85 - 04.89		135			MG1626		100			SG1612
----------	---------------	--	-----	--	--	--------	--	-----	--	--	--------

### LEGEND

2.5 (HS)	1985 - 1988		135			MG1627					
2.7 (KA3)	1987 - 1990		135			MG1627		75			MG1629
2.7 (KA4)	1989 - 1990										
(KA7)	1991 -										
(KA8)	1991 -										

### LOGO

	1998 -			←	M 1657					T 1659	
				→	M 1658						

### PASSPORT / JAZZ

	1994 - 1997					HG1639					HG1638
	1998 -					HG1639					HG1640



ANTERIORE  
FRONT



POSTERIORE  
REAR



OIL

GAS



OIL

GAS

## HONDA

### PRELUDE

(SN)	1979 - 1983										
1.8 (AB)	1983 - 09.87		85			MG1630		135	ACC18		MG1603
2.0 (BA1, BA2, BA3)	1983 - 09.87										
2.0 (BA4)	10.87 - 1992		135			MG1631		145			MG1632
2.0 (BB3)	1992 - 1996		120			MG1634		140			MG1633
2.2 V-Tec (BB1)	1992 - 1996										
2.3 (BB2)	1992 - 1996										
2.0 (BB9)	1997 -				←			140			MG1633
2.2 (BB5)	1997 -				→						
2.2 V-Tec (BB6, BB8)	1997 -										
2.2 VTi, 2.2 VTi-R (BB6)	1997 -										
2.2 VTi-S (BB6)	1997 -										

### QUINTET

(SU, TU, TL, TS)	1980 - 1985		85	ACC11		MG1609		95	ACC18		MG1610
------------------	-------------	--	----	-------	--	--------	--	----	-------	--	--------

### SHUTTLE / ODYSSEY

1.5 4x2 (AN)	1984 - 1987										
1.5 4x4 (AR)	1985 - 1987										
2.2 (RA1)	1995 -				←	MG1653					MG1637
2.3 (RA3)	1995 -				→	MG1654					

## HYUNDAI

### ACCENT / PONY / EXCEL

1.2, 1.4	1977 - 1984				C 1703						T 1704	TG1704
1.3 (Ch. KMHL..)	1985 - 08.89		145	ACC18		CG1705		40			T 1706	TG1706
1.6 (Ch. KMHL..)	1985 - 08.89											
,  1.3, 1.5 (X2) Ch. KMHU..	09.89 - 08.94		110			MG1707		40			T 1706	TG1706
,  1.3, 1.5 (X2) Ch. KMHV..	09.89 - 08.94											
(X3)	09.94 - 04.97				M 1718	MG1718			<b>33</b>		M 1724	MG1724
(X3)	05.97 - 1999				M 1718	MG1718			<b>34</b>		M 1728	MG1728

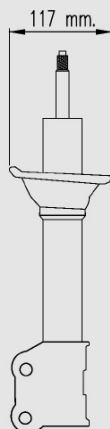

**33**

M 1724  
MG1724

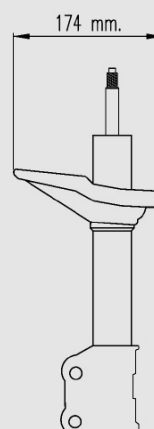

**34**

M 1728  
MG1728



ANTERIORE  
FRONT



POSTERIORE  
REAR



## HYUNDAI

### ATOS / SANTRO

	1998 -			M 1719 M 1720	MG1719 MG1720			T 1721	TG1721
--	--------	--	--	------------------	------------------	--	--	--------	--------

### COUPE'

(J2, Ch. KMJ..)	1996 -				MG1723				MG1733
(J2, Ch. KMHK..)	1996 -				MG1722				MG1732

### GALOPPER

	08.97 -				TG1729				TG1730
--	---------	--	--	--	--------	--	--	--	--------

### H1 / SATELLITE

(KMJ)	1997 -				TG1726				TG1727
(KMJ)	1997 -				TG1726				
(KMF)	1997 -								
(KMF)	1997 -								

### H 100

FD Series	1993 -				HG1711				HG1712
-----------	--------	--	--	--	--------	--	--	--	--------

### LANTRA / ELANTRA

(J1)	1990 - 09.95		110		MG1701		85	S 1702	SG1702
,  ,  (J2)	09.95 - 07.00				MG1723				MG1733
					MG1722				MG1732
,  ,	08.00 -								

### S COUPE'

(SLC KMHU)	09.89 -		110		MG1707		40	T 1706	TG1706
(SLC KMHV)	09.89 -								

### SANTA FE

	06.00								
--	-------	--	--	--	--	--	--	--	--

### SANTAMO

	2000 -		110		MG2620		70		TG2621
--	--------	--	-----	--	--------	--	----	--	--------

### SONATA / SONICA

(Y2 KMhaf)	10.88 - 04.93		100		MG1708		75		SG1709
(Y2 KMhBF)	10.88 - 04.93								
(Y3 KMhCF)	07.93 - 03.94				MG1715		75		TG1731
(Y3 KMhDF)	07.93 - 03.94								
	04.94 -				MG1715		75		TG1731

### STELLAR

	1983 - 1986		60		T 1403	TG1403		40	T 1406	TG1406
	1987 - 1989		75			CG1710		40	T 1406	TG1406



ANTERIORE  
FRONT



POSTERIORE  
REAR

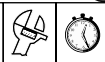

OIL

GAS

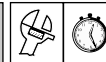

OIL

GAS

## INNOCENTI

### ELBA

	1992 -		70		M 1331			70		M 1363
--	--------	--	----	--	--------	--	--	----	--	--------

### KORAL

	1980 -		70	ACC21	M 4601			90		M 1312
--	--------	--	----	-------	--------	--	--	----	--	--------

### MILLE

	1994 -				M 1803					M 1804
--	--------	--	--	--	--------	--	--	--	--	--------

### MINI

1001, 1300	1974 - 1982				T 0409					T 0411
90, 120	1974 - 1982									
De Tomaso	1974 - 1982									
Tre Cilindri	1990 -				M 1801					M 1802

## ISUZU

### ELF

TL 20 (250)	1970 - 1974				T 2801	TG2801				
TL 20 (250)	1975 - 1979				T 2801	TG2801				T 1704 TG1704
TL10, TL30 (250)	1970 - 1979				T 2801	TG2801				
TL40, TL50, TL60 (250)	1970 - 1979				T 2801	TG2801				HG2302
KS (350)	1970 - 1979									

### FASTER

(KB20, KBD20, KB30, KBD30)	1972 -					HG2835				T 1303 TG1303
4x2 (KBD 2, KBG 2)	1980 -				H 1901	HG1901				H 2616 HG2616
4x4 (KBD 4, KBG 4)	1980 -					HG2835				

### FLORIAN

PA10, PA20	1967 - 1968				T 2920	TG4257				T 2801 TG2801
PA20, PA30, PA90, PA95, PA96	1968 - 1981				T 2920	TG4257				T 3201
PA20V, PA30V	1967 - 1981									

### GEMINI

,  1.6, 1.8 (PF 50, PF 60)	1974 - 1979				T 2903	TG2903				T 2922 TG2922
1.6, 1.8 (PF 60)	1980 - 1984									

### LIGHT ELF

KA20, KA40, KA50 (150)	1968 - 08.72				T 2801	TG2801				T 1303 TG1303
KA41, KA51 (150)	09.72 -				T 2801	TG2801				

### MIDI / FARGO

,  4x2 (WFR)	1980 - 1988		40		H 0701			40		H 0702
,  4x2 (9800)	1988 -		40		H 0701			40		H 0702
,  4x4 (WSF)	1984 - 1988				H 1905			40		H 0702
,  4x4 (9400)	1988 -									



ANTERIORE  
FRONT



POSTERIORE  
REAR



## ISUZU

### PIAZZA

JR 130	1981 - 1982		40		T 2903	TG2903		30		T 2921	TG2921
--------	-------------	--	----	--	--------	--------	--	----	--	--------	--------

### PICK UP / CAMPO / BRAVA

4x2 (KB 2, KBD 2)	1980 - 07.86				H 1901	HG1901				H 2616	HG2616
4x2 (KB 2, KBD 2)	08.86 -									H 2616	HG2616
4x4 (KB 4, KBD 4)	1980 -				H 1901	HG1901					HG1902
4x2 (TFR)	04.88 -				H 2914					H 2915	
4x4 (TFS)	04.88 -					HG2916					HG1902

### TROOPER / BIG HORN

4x4 (UBS)	1983 - 10.86		40		H 1901	HG1901		40			HG1902
4x4 (UBS) excl.	11.86 - 1991		40		H 1903	HG1903		40		H 1904	HG1904
excl.	1992 - 1996					HG1903					HG2930
2B excl.	1996 -					HG2949					HG2930
4B excl.	1996 -					HG2949					HG2950

## IVECO

### DAILY

28F8, 28U8	- 08.89		45	<b>35</b>	T 1344			45	<b>35</b>	T 1345	
35.8, 35.9, 35.10	- 08.89										
40.8, A40.8, 40.10, A40.10	- 08.89										
30.8 (Ch. → 304675)	- 08.89										
30.8 (Ch. 304676 →)	- 08.89		45	<b>35</b>	T 1386			45	<b>35</b>	T 1345	
35.8 CB5			45	<b>35</b>	T 1387			45	<b>35</b>	T 1345	
40.8, A40.8											
35.10 V			45	<b>35</b>	T 1387			45	<b>35</b>	T 1388	
45.10, A45.10											
49.10, 49.12			45	<b>35</b>	T 1387			45	<b>35</b>	T 1388	
40 NC 35			45	<b>35</b>	T 1345			45	<b>35</b>	T 1344	
40.10 W 4x4			45					45			

### NEW DAILY

30.8, 30.9	09.89 -		45	<b>35</b>	T 1386			45	<b>35</b>	T 1388	
35.8, 35.12	09.89 -								<b>35</b>	T 1387	
40.8, A40.8	09.89 -										

### NEW TURBO DAILY

35.10			45	<b>35</b>	T 1386			45	<b>35</b>	T 1388	
									<b>35</b>	T 1387	
45.10, A 45.10			45	<b>35</b>	T 1387			45	<b>35</b>	T 1387	
49.10											

**35** Vedi disegno Iveco Daily a pagina 39 - See drawing Iveco Daily on page 39



ANTERIORE  
FRONT



POSTERIORE  
REAR



OIL

GAS



OIL

GAS

## IVECO

**35**

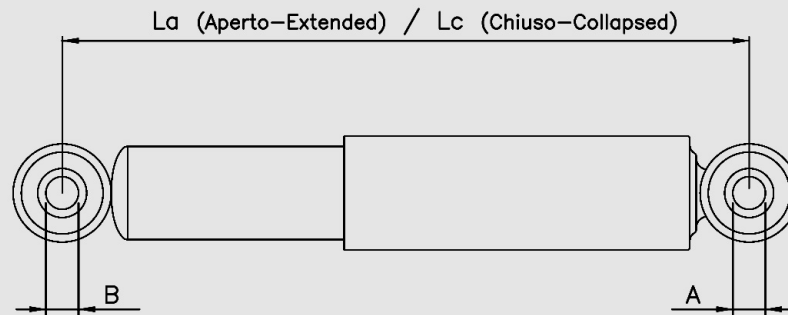

**T 1344**

A=16 mm.  
B=16 mm.  
La=504 mm.  
Lc=312 mm.

**T 1345**

A=12 mm.  
B=12 mm.  
La=576 mm.  
Lc=352 mm.

**T 1386**

A=16 mm.  
B=16 mm.  
La=416 mm.  
Lc=266 mm.

**T 1387**

A=16 mm.  
B=16 mm.  
La=442 mm.  
Lc=280 mm.

**T 1388**

A=16 mm.  
B=16 mm.  
La=587 mm.  
Lc=355 mm.

## JAGUAR

### XJ SERIES

Model	Year Range	Oil Level	Oil Capacity	Oil Type	Oil Quantity	Notes	Oil Type	Oil Quantity	Notes	Oil Type	Oil Quantity
XJ-6	1968 - 1986	1/0	60	TG2001	75						
Daimler Sovereign	1969 - 1984										
XJ-12, Sovereign V12	1972 - 02.93										
XJS, XJSC	1975 - 1996										
Daimler Double Six	1972 - 02.93										



ANTERIORE  
FRONT



POSTERIORE  
REAR



## JEEP

### CHEROKEE / WAGONEER

(XJ)	1976 - 1983		40			HG3358		40			HG3358
(XJ)	1984 - 1990		40			HG3361		40			HG3362
(XJ)	1990 - 2001		40					40			HG3362

### CJ

CJ-5, CJ-6	1972 - 1981					HG1210				H 1211	
CJ-7 excl. Lift Kit	1976 - 1981										
CJ-5, CJ-6	1982 - 1983					HG3358				H 1211	
CJ-7 excl. Lift Kit	1982 - 1986										

### COMANCHE

4x2 (MJ)	- 1986					HG3361					HG4238
4x2 (MJ)	1987 - 1992					HG3361					HG2702
4x4 (MJ)	1986 - 1992										

### DJ

DJ-5, DJ-6	1972 - 1975					HG1210				H 1211	
------------	-------------	--	--	--	--	--------	--	--	--	--------	--

### GLADIATOR / PIONEER

J-10, J-20	1974 - 1988					HG3358					HG3358
------------	-------------	--	--	--	--	--------	--	--	--	--	--------

### GRAND CHEROKEE

(ZJ)	1993 - 1994		40			HG3361		40			HG3377
(ZJ)	1995 -		40			HG3361		40			HG3414

### GRAND WAGONEER

(SJ)	1984 - 1990		40			HG3358		40			HG3358
------	-------------	--	----	--	--	--------	--	----	--	--	--------

### SCRAMBLER

	- 1981					HG1210				H 1211	
	1982 - 1986					HG3358				H 1211	

### WRANGLER / LAREDO

(YJ)	1987 - 1995		40			HG3359		40			HG3360
(TJ)	1996 -		40			HG3361					



ANTERIORE  
FRONT



POSTERIORE  
REAR



OIL

GAS



OIL

GAS

## KIA

### BESTA

	-										
--	---	--	--	--	--	--	--	--	--	--	--

### CARENS

1.8i 16V	-										

### CARNIVAL

2.5 V6	1998 -					MG5507					MG5509
2.9 TD, 2.9 HPDi	1998 -					MG5508					MG5510

### CLARUS / CREDOS

	1996 -										

### JOICE

2.0i 16V	1999 -					SG5518					SG5519
----------	--------	--	--	--	--	--------	--	--	--	--	--------

### PREGIO

	1998 -										
--	--------	--	--	--	--	--	--	--	--	--	--

### PRIDE

1.1i (DA)	1996 -					MG2427		75			SG2426
1.3i 16V (DA)	10.96 -										

### RIO

1.3i	2000 -					MG5515					TG5517
1.5i	2000 -					MG5516					

### SEPHIA / MENTOR

,  1.5i 16V (FA) excl. ABS	05.93 - 09.96					M 5521					M 5520
,  1.6i (FA) excl. ABS	05.93 - 09.96					M 5522					
,  1.8i 16V (FA) excl. ABS	05.93 - 09.96										
,  1.5i 16V (FA) excl. ABS	10.96 - 1997					M 5523					M 5525
,  1.6i (FA) excl. ABS	10.96 - 1997					M 5524					M 5526
,  1.8i 16V (FA) excl. ABS	10.96 - 1997										
,  1.5i 16V (FA) excl. ABS	02.98 - 1998										
,  1.8i 16V (FA) excl. ABS	02.98 - 1998										

### SHUMA

1.5 incl. ABS	1999 -					MG5511					MG5513
						MG5512					MG5514

### SPORTAGE

2.0i (K00)	09.94 -					SG5506					HG5505
2.0i 16V (K00)	09.94 -										
2.0 TD (K00)											





ANTERIORE  
FRONT



POSTERIORE  
REAR



## LADA

### DIVA / FORMAN / SAGONA

1.5 (2109, 21099)	1991 -		100		C 2103	CG2103		50		S 2104	SG2104
1.5 (2109, 21099)	1991 -										

### NIVA

4x4 (2121, 21215)	1976 -		55		H 2105	HG2105		45		H 2106	HG2106
-------------------	--------	--	----	--	--------	--------	--	----	--	--------	--------

### SAMARA / NATACHA

1.1, 1.3 (2108)	1985 -		100		C 2103	CG2103		50		S 2104	SG2104
1.1, 1.3 (2108)	1985 -										

### VAZ / KALINKA

1.2 (2101)	1972 -		55		T 2101	TG2101		50		T 2102	TG2102
1.3 (21011)	1972 -										
1.5 (2103)	1972 -										
1.6 (2106)	1972 -										
(2105, 2107)	1980 -										
(2102, 2104, 2105)	1972 -		55		T 2101	TG2101		50		T 2102	TG2102
1.1, 1.3, 1.5 (2110, 2112)	1985 -				C 2107	CG2107				S 2108	SG2108

## LANCIA

### A 112 → vedi AUTOBIANCHI

### DEDRA

,  1.6, 1.8 excl. 4x4, MPI 16V	1989 - 12.97		80		M 1339	MG1339		50	N.D.		TG0624
,  1.9 TD excl. 4x4	1989 - 12.97								H.D.	T 1375	TG1375
,  2.0 excl. 4x4	1989 - 12.97										
,  2.0 16V excl. 4x4	09.94 - 12.97										
,  1.6, 1.8 excl. 4x4, MPI 16V	01.98 - 2000		80			MG1394		50	N.D.		TG0624
,  1.9 TD excl. 4x4	01.98 - 2000								H.D.	T 1375	TG1375
,  2.0 excl. 4x4	01.98 - 2000										
,  2.0 16V excl. 4x4	01.98 - 2000										
4x4	09.94 - 12.97		80		M 1339	MG1339					
4x4	01.98 -		80			MG1394					

### DELTA

1.3, 1.5 (831)	1980 - 01.86		110		M 2201	MG2201		175		M 2203	MG2203
1.6 (831)	02.83 - 01.86									M 2204	MG2204
1.3, 1.5 (831) excl. 4x4	02.86 - 1993		110		M 2202	MG2202		175		M 2205	MG2205
1.6i, 1.6 GT ie, 1.6 TD (831) excl. 4x4	02.86 - 1993									M 2206	MG2206
1.9 D, 1.9 TD, 2.0 TD (831) excl. 4x4	02.86 - 1993										
2.0 HF 8V Integrale	02.86 - 1993		110			MG2212		175			MG2213
2.0 HF 16V Integrale	1987 - 1993										
2.0 HF Integrale Evoluzione	1987 -		110			MG2214		175			MG2215
1.4, 1.6, 1.8 (836) excl. 4x4	1993 - 1999		80			MG1339		50	N.D.		TG0625
									H.D.		TG1340



ANTERIORE  
FRONT



POSTERIORE  
REAR

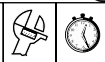

OIL

GAS

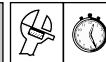

OIL

GAS

## LANCIA

### DELTA

1.6 16V (836)	1993 - 1999		80	ACC49		MG1339		50	N.D.		TG0624
1.8 ie, 1.8 16V (836)	1993 - 1999								H.D.	T 1375	TG1375
2.0 16V (836) excl. HF, HPE, GT	1993 - 1999										
1.9 TD (836)	09.93 - 1999		80	ACC49		MG2232		50	N.D.		TG0624
									H.D.	T 1375	TG1375
2.0 16V HF Turbo (836) excl.	1993 - 1999		80	ACC49		MG2218		50	N.D.		TG0624
2.0 16V GT (836) excl.	1993 - 1999								H.D.		TG1375
2.0 16V HPE (836) excl.	1993 - 1999										

### KAPPA

2.0, 2.0 20V (Ch. → 2050295)	10.94 -		120			MG2220		240			MG2222
2.4 TD, 2.4 JTD (Ch. → 2050295)	10.94 -										
3.0 V6 24V (Ch. → 2050295)	10.94 -										
2.0 Turbo (Ch. → 2087505)	10.94 - 02.96		120			MG2220		240			MG2222
2.4 20V (Ch. → 2087505)	10.94 - 02.96										
2.0, 2.0 20V (Ch. 2050295 → 2087505)	- 02.96		120			MG2221		240			MG2222
2.4 TD (Ch. 2050295 → 2087505)	- 02.96										
2.4 JTD (Ch. 2050295 → 2087505)	- 02.96										
3.0 V6 24V (Ch. 2050295 → 2087505)	- 02.96										
2.0, 2.0 20V (Ch. 2087506 →)	03.96 -		120			MG2221					MG2237
2.4 TD, 2.4 JTD (Ch. 2087506 →)	03.96 -										
3.0 V6 24V (Ch. 2087506 →)	03.96 -										
2.0 Turbo (Ch. 2087506 →)	03.96 -		120			MG2220					MG2237
2.4 20V (Ch. 2087506 →)	03.96 -										
excl.	10.94 -		120			MG2220					
2.4 20V, 2.4 TD excl.	1996 -		120			MG2221					MG2238
3.0 V6 24V excl.	1996 -										
2.0 16V Turbo excl.	1996 -		120			MG2220					MG2238
2.0 20V Turbo excl.	1998 -										

### LYBRA

1.6 16V, 1.8 16V	1999 -		120			MG2234		60			TG2235
1.6 16V, 1.8 16V	1999 -										
2.0 20V	1999 -		120			MG2236		60			TG2235
1.9 JTD, 2.4 JTD	1999 -										
2.0 20V	1999 -										
1.9 JTD, 2.4 JTD	1999 -										

### PRISMA

1.3, 1.5, 1.6	02.83 - 01.86		110	ACC39	M 2201	MG2201		175		M 2203	MG2203
1.9 D, 1.9 TD	02.83 - 01.86									M 2204	MG2204
										ACC28	
1.3, 1.5, 1.6 excl. 4x4	02.86 - 1993		110	ACC39	M 2202	MG2202		175		M 2205	MG2205
1.9 D, 1.9 TD excl. 4x4	02.86 - 1993									M 2206	MG2206
										ACC28	
2.0 8V Integrale	02.86 - 1993		110			MG2212		175			MG2213



ANTERIORE  
FRONT



POSTERIORE  
REAR



## LANCIA

### THEMA

(Ch. → 29408) excl. 8.32,	11.84 - 10.86		75			MG1329		130	excl.		MG1328
(Ch. 29409 →) excl. 8.32,	11.86 - 1994		75			MG1329		130	excl.		MG1330

### Y

(840)	1996 -		85			MG2223		50			TG2224
-------	--------	--	----	--	--	--------	--	----	--	--	--------

Y 10 → vedi AUTOBIANCHI

### ZETA

(Ch. → 7608)	03.94 - 12.97		90		M 1366	MG1366		45		T 1367	TG1367
(Ch. 7609 →)	01.98 -		90		M 1366	MG1366		45		T 0944	TG0944

## LAND ROVER

### DEFENDER

90, 110, 130	1983 -		95		H 2304	HG2304		50		H 2305	HG2305
--------------	--------	--	----	--	--------	--------	--	----	--	--------	--------

### DISCOVERY

(Ch. → MA135957)	1989 - 1994		90		H 2306	HG2306		45		H 2307	HG2307
(Ch. MA135958 →)	1994 - 1999		70			HG2304		45			HG2309
excl.  Active roll	1999 -					TG2317					TG2318
excl. Active roll	1999 -					TG2317					TG2319
	1989 -				T 2308						

### FREELANDER

(3 )	1997 -					MG2313					MG2315
(5 )	1997 -					MG2314					MG2316

## LAND ROVER

(86" )	1953 - 1956		180			HG2301		60			HG2302
Series I, II, IIA, IIB, III (88" )	1956 - 1983										
(107" )	1953 - 1958										
Series I (109" )	1953 - 1958										
Series II, IIA, IIB, III (109" )	1958 - 1984					HG2301					HG2303
(119" )	1958 - 1984										
	1953 -				T 2308						

## RANGE ROVER

(100" ) excl.	06.70 - 1994		105		H 2306	HG2306		45		H 2307	HG2307
excl. Classic	10.92 - 08.94		70			HG2310		45			HG2309
excl. Classic	09.94 -					HG2311					HG2312
Classic excl.	1994 -		105		H 2306	HG2306		45		H 2307	HG2307
Classic	1994 -		70			HG2310		45			HG2309
(100" )	1970 - 1994				T 2308						
Classic	1994 -										



ANTERIORE  
FRONT



POSTERIORE  
REAR

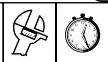

OIL

GAS

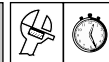

OIL

GAS

## LAND ROVER

### SANTANA

(88" ) 2.5 DC, 2500 DC						HG2301					HG2302
(109" ) (119" ) 2.5 DE, 2.5 DL, 2500 DL 3.5 DL, 3500 DL						HG2301					HG2303

## LEYLAND - FREIGHT ROVER

### SHERPA 200 SERIES

200, 230, 250, 280	1983 -		30			H 1101		30		H 1103
255, 280	1983 -					H 1102				

### SHERPA 300 SERIES

285, 310, 350  (2.90 m)	1983 -		30					30		H 4702
285, 310  (3.20 m)	1983 -									

## MAZDA

### 121 / REVUE

(DA)	10.87 - 02.91		100		ACC18		MG2427		75			SG2426
(DB)	03.91 - 1996		180		ACC18		MG2427		160			SG2428
1250 (JA, JB)	1996 - 09.98					M 1476	MG1476			<b>25</b>	S 1477	SG1477
1.3 16V (JA, JB)	1996 - 09.98											
1.4 16V (JA, JB)	1996 -											
1.8 D (JA, JB)	1996 - 09.98					M 1482	MG1482			<b>25</b>	S 1477	SG1477
1250 (JA, JB)	10.98 -					M 1476	MG1476			<b>24</b>	S 1507	SG1507
1.3 16V (JA, JB)	10.98 -											
1.8 D (JA, JB)	10.98 -					M 1482	MG1482			<b>24</b>	S 1507	SG1507

**24 - 25** Vedi disegni Ford Fiesta a pagina 29 - See drawing Ford Fiesta on page 29

### 323

1.0 (FA 4 PS) Ch. → 532270	1977 - 1979		100		ACC18	C 2401			155		T 2402		
1.3 (FA 4 TS) Ch. → 781083	1977 - 1979												
1.4 (FA 4 US) Ch. → 574839	1977 - 1979												
1.0 (FA 4 PS) Ch. 532271 →	1980 - 10.80								155		T 2402		
1.3 (FA 4 TS) Ch. 781084 →	1980 - 10.80												
1.4 (FA 4 US) Ch. 574840 →	1980 - 10.80												
,  1.1 (BD1011, BD1012)	11.80 - 07.85		100		ACC19	M 2403	MG2403		155		ACC19	M 2404	MG2404
,  1.3 (BD1031, BD1032)	11.80 - 07.85												
,  1.5 (BD1051, BD1052)	11.80 - 07.85												
,  1.1, 1.3 (BF1) excl.	08.85 - 05.89		100		ACC19	M 2403	MG2403		115		ACC19	M 2404	MG2404
,  1.5 (BF1) excl. XG,	08.85 - 05.89												
,  1.7D (BF1) excl.	08.85 - 05.89												
,  1.5 XG (BF5P) excl.	08.85 - 05.89		100		ACC19	M 2403	MG2403						
,  1.6i (BFMP) excl. , 4x4	08.85 - 05.89												



ANTERIORE  
FRONT



POSTERIORE  
REAR



## MAZDA

### 323

,  1.6 Turbo 4x4 (BF8)	1986 - 05.89											
(BG) excl. 4x4	06.89 - 08.94		100			MG2405			115			MG2407
(BG) excl. 4x4, 323F	06.89 - 08.94					MG2406						MG2408
,  1.3 (BA) excl. 323F	10.94 - 09.00					<u>MG2439</u>						<u>MG2441</u>
,  1.5 (BA) excl. 323F	10.94 - 09.00					<u>MG2440</u>						<u>MG2442</u>
,  1.8 (BA) excl. 323F	10.94 - 09.00											
,  1.7 TD , 2.0 D (BA)	10.94 - 09.00											
1.3, 1.5, 1.8 (BJ) Ch. → 304194	05.98 - 12.99					<u>MG2461</u>						<u>MG2463</u>
2.0 D, 2.0 TD (BJ) Ch. → 304194	05.98 - 12.99					<u>MG2462</u>						<u>MG2464</u>
1.3, 1.5, 1.8 (BJ)	01.00 - 12.00					<u>MG2465</u>						<u>MG2467</u>
2.0 D, 2.0 TD (BJ)	01.00 - 12.00					<u>MG2466</u>						<u>MG2468</u>
Ch. 304195 → 400000												
1.3 (FA 4 TV) Ch. → 504906	1978 - 1979		100		C 2401				155		T 0120	TG0120
1.4 (FA 4 UV) Ch. → 528946	1978 - 1979											
1.3 (FA 4 TV) Ch. 504907 →	1980 - 10.80								155		T 0120	TG0120
1.4 (FA 4 UV) Ch. 528947 →	1980 - 10.80											
1.3 (FA4T6)	1980 - 1985											
1.3 (FA4T)	1981 - 11.85								155		T 0120	TG0120
1.5 (FA4S)	1981 - 11.85											
(BW 12) excl. 4x4,	11.85 - 1994		100		M 2403	MG2403						<u>MG2443</u>
												<u>MG2444</u>

### 323 F

5⊖ (BG) excl. 4x4	06.89 - 08.94					<u>MG2445</u>			115			MG2407
						<u>MG2446</u>						MG2408
1.6i excl. 4x4,	06.89 - 08.94								115			MG2407
1.9i excl. 4x4,	06.89 - 08.94											MG2408
5⊖ 1.3 (BA)	08.94 - 04.98					<u>MG2439</u>						<u>MG2441</u>
5⊖ 1.5, 1.8 (BA)	08.94 - 04.98					<u>MG2440</u>						<u>MG2442</u>
1.3, 1.5, 1.8 (BJ) Ch. → 304194	05.98 - 12.99					<u>MG2461</u>						<u>MG2463</u>
2.0 D, 2.0 TD (BJ) Ch. → 304194	05.98 - 12.99					<u>MG2462</u>						<u>MG2464</u>
1.3, 1.5, 1.8 (BJ)	01.00 - 12.00					<u>MG2465</u>						<u>MG2467</u>
2.0 D, 2.0 TD (BJ)	01.00 - 12.00					<u>MG2466</u>						<u>MG2468</u>
Ch. 304195 → 400000												

### 626 / MONTROSE

,  1.6 (CB2 NS)	1978 - 1982		225		C 2409				40			TG1206
,  1.8 (CB2 VS)	1978 - 1982											
,  2.0 (CB2 MS)	1978 - 1982											
,  (GB1)	1979 - 1982											
,  (GC1) excl.	1983 - 05.87		90			MG2411			150			MG2412
,  (GD1) excl. 4WS, 4x4	06.87 - 12.91		90			MG2413			150			MG2414
,  (GE1) excl. 4WS, 4x4	01.92 - 1996		260			MG2415			200			MG2417
						MG2416						



ANTERIORE  
FRONT



POSTERIORE  
REAR

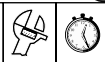

OIL

GAS

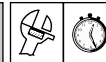

OIL

GAS

## MAZDA

### 626 / MONTROSE

(GF1) excl. , 4x4	1997 - 07.99					MG2447					MG2449
(GF1) excl. , 4x4	1997 - 07.99					MG2448					MG2450
excl. , 4x4	08.99 -					MG2451					MG2453
excl. , 4x4	08.99 -					MG2452					MG2454
(GC 1) excl.	1983 - 05.87		90		ACC18	MG2411		150		ACC18	MG2412
(GD 1) excl. 4WS, 4x4	06.87 - 12.91		90		ACC16	MG2413		150		ACC18	MG2414
(GV 1) excl. 4x4,	03.88 - 1996		90		ACC16	MG2413					
(GW 1) excl. ,	1997 - 07.99					MG2447					
						MG2448					
excl. ,	08.99 -					MG2451					
						MG2452					

### 808 / 818

,  1.3, 1.6 (S 124A)	1971 - 1978		105		ACC18	C 2401					
,  RX3 (S 124A)	1971 - 1978										
(S 124W)	1972 - 1978		105		ACC18	C 2401				T 0120	TG0120

### 929 / LUCE

,  1.8 (LA2, LA22) excl.	08.72 - 09.77							40		T 2418	
,  1.8 (LA3, LA33) excl.	08.72 - 09.77										
1.8, 2.0, 2.0D (LA4, LA43) excl.	10.77 - 09.81							40			TG1206
2.0 (LA425) excl.	1978 - 09.81										
excl.	10.81 - 08.86		105					40		ACC83	SG2421
excl.	10.81 - 08.86										
2.0 (HC12) excl.	09.86 - 1989		105			MG2422		40			SG2423
2.2 (HC12) Ch. → 200000 excl.	1987 - 05.89										
2.2 (HC12) Ch. 200001 → excl.	06.89 - 1991					MG2424		40			SG2423
3.0 (HC12) excl.	06.89 - 1991										
2.0 (LA2 V, LA3 V)	08.72 - 1978							40		T 2418	
2.0 (LA33 W)	08.72 - 1978										
2.0 (LA4 MV)	1978 - 10.81							40		T 2418	
2.0 (LA4 SV)	11.81 - 1983										

### B SERIES

B 1600, B 1800, B 2000 (BNA)	1970 - 1985					T 2920	TG4257				
B 1600, B 2000 excl. 4x4	1985 - 03.96		50				HG2916		50	N.D.	T 1303
B 2200, B 2600 excl. 4x4	1985 - 03.96									H.D.	HG4238
B 2200 excl. 4x4	04.96 -		50				HG2916		50	N.D.	T 1303
B 2500, B 2600 excl. 4x4	04.96 -									H.D.	HG4238

### DEMIO

	1998 -										



ANTERIORE  
FRONT



POSTERIORE  
REAR



## MAZDA

### E SERIES / BONGO

E 1600 (BA 2)	1978 - 1984				T 2920	TG4257					HG1210
E 2200D (BA 2)	1978 - 1984				T 2920	TG4257				T 1303	TG1303
E1400, E1800 (H-H, 4x2)	1984 -		50			HG2432		40		T 2702	HG2702
E1400, E1800 (H-H, 4x2)	1984 -										
E2000, E2200D (H-H, 4x2)	1984 -										
E2000, E2200D (H-H, 4x2)	1984 -										
E2000, E2200D (H-H, 4x2)	1984 -										
E1400, E1800 (H-H, 4x2)	1984 -		50			HG2432		40	N.D.	T 1303	TG1303
E1400, E1800 (H-H, 4x2)	1984 -								H.D.		HG4238
E1800 (H-H, 4x2)	1984 -										
E2000, E2200D (H-H, 4x2)	1984 -										
E2000, E2200D (H-H, 4x2)	1984 -										
E2000, E2200D (H-H, 4x2)	1984 -										

### FAMILIA

,  1.2	1968 - 1970									T 2418	
,  1.0, 1.3	1970 - 1977										

### MPV

4B (LV52) excl. 4x4	1993 -					MG2435					HG2436
5B (LV12) excl. 4x4	1993 -										
4x4	1993 -					MG2437					HG2438

### MX3

1.6 (EC)	1991 -					MG2455					MG2457
1.9 (EC)	1991 -					MG2456					MG2458

### MX5 / MIATA

1.6, 1.9 (NA) excl. ABS	1990 - 1998		160			SG2429		180			SG2430
1.6, 1.9 (NA) ABS	1990 - 1998		160					180			SG2430
	1999 -					SG2459					SG2460

### MX6

2.0 4x2 (GE1) excl. 4WS,	1992 -		260			MG2415		200			MG2417
2.5 4x2 (GE1) excl. 4WS,	1992 -					MG2416					
2.5 4WS (GE7) excl. 4x4,	1992 -		260			MG2415					
						MG2416					

### PREMACY

1.8 16V	1999 -					MG2469					MG2471
2.0 TD	1999 -					MG2470					MG2472

### T SERIES

T2000, T2500, T2600	1984 -				H 2433					H 2434	
T3000, T3500, T4100	1984 -										







ANTERIORE  
FRONT

POSTERIORE  
REAR



## MERCEDES

### 170

170DA, 170DE 170VA, 170VB					T 0703	TG0703				T 1704	TG1704
------------------------------	--	--	--	--	--------	--------	--	--	--	--------	--------

### W 108

230 S	1965 - 1967								excl.	T 2501	
250 S, 250 SE	1965 - 08.72										
280 S, 280 SE, 280 SEL	1968 - 08.72										
300 SE, 300 SEL	1965 - 1967										

### W 110 - W111

190C, 190DC (W110)	1962 - 1965								excl.	T 2501	
200, 200D (W111)	1965 - 1968										
220B, 220SB (W111)	1961 - 1968										
220SE, 220SEB (W111)	1961 - 1968										
230 (W111)	1961 - 1968										
190C, 190DC (W110)	1961 - 1965										
200, 200D (W111)	1965 - 1968										
220B, 220SB (W111)	1961 - 1968										
230, 230S (W111)	1965 - 1968										
(W110)	1962 - 1965				T 2532						
(W111)	1961 - 1968										

### W 114 - W115

200, 200D (W115)	01.68 - 1976		50		T 2504	TG2504		65		T 2505	TG2505
220, 220D (W115)	01.68 - 1976										
230.4, 230.6 (W115)	01.68 - 1976										
240D (W114) excl.	1973 - 1976										
250 (W114)	01.68 - 1976										
280, 280 E (W114)	1973 - 1976										
220  (W115)	1968 - 1979		50		T 2504	TG2504					
240D  (W114)	1973 -										
250C, 250CE (W114)	1973 - 1976				T 2504	TG2504		75		T 2505	TG2505
280C, 280CE (W115)	1973 - 1976										
220, 220D (W115)	1968 - 1978		70			TG2504		90			TG2505
230/4 (W115)	1973 - 1978										
240D (W115)	1973 - 1978										
(W114)	1968 - 1978				T 2532						
(W115)	1968 - 1978										

### W 116

280 S, 280 SE	09.72 - 1980		50	N.D.		TG2506		65	excl.		TG2505
280 SEL	09.72 - 1980			H.D.		TG2507					
350 SE, 350SEL	09.72 - 1980										
450 SE, 450 SEL	03.73 - 1980										
(W 116)	1972 - 1980				T 2532						



ANTERIORE  
FRONT



POSTERIORE  
REAR

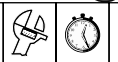

OIL

GAS

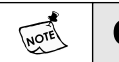
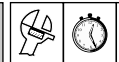

OIL

GAS

## MERCEDES

### W 123

200, 200D	1976 - 11.84		50	N.D.		TG2506		65			TG2505
220, 220D	1976 - 11.84			H.D.		TG2507					
230, 240D, 250	1976 - 11.84										
280, 280E	1976 - 11.84										
300D, 300TD	1976 - 11.84										
200T	1978 - 1985		50	N.D.		TG2506					
230T, 230TE	1978 - 1985			H.D.		TG2507					
240TD, 250T, 280TE	1978 - 1985										
300TD, 300T Turbo Diesel	1978 - 1985										
(W123)	1976 - 1985				T 2532						

### C 123

230C, 230CE	1976 - 1987		50	N.D.		TG2506		75			TG2505
280C, 280CE	1976 - 1987			H.D.		TG2507					
(C123)	1976 - 1987				T 2532						

### W 124

200, 200D, 200E	11.84 - 06.93		105	ACC18	M 2502	MG2502		65		T 2503	TG2503
230E, 260E	11.84 - 06.93										
250D, 250D Turbo	11.84 - 06.93										
300E, 300D, 300D Turbo	11.84 - 06.93										
320E	11.84 - 06.93										
400E	1992 - 06.93										
excl. 4-Matic, Sportline											
Sportline	- 06.93		105	ACC18		MG2508		65			TG2509
260E 4-Matic	1986 - 06.93										
300E 4-Matic	1986 - 06.93										
300D 4-Matic	1986 - 06.93										
300D Turbo 4-Matic	1986 - 06.93										
200T, 200TE, 200TD	1985 - 06.93		145	ACC18	M 2502	MG2502					
230TE, 250TD	1985 - 06.93										
260TE, 280TE	1985 - 06.93										
300TE, 300TD	1985 - 06.93										
300TD Turbo	1985 - 06.93										
320TE	1985 - 06.93										
excl. 4-Matic, Sportline											
Sportline	1985 - 06.93		145	ACC18		MG2508					
300TE 4-Matic	1986 - 06.93										
300TD Turbo 4-Matic	1986 - 06.93										

### C 124

excl. Sportline	1987 - 06.93		145	ACC18	M 2502	MG2502		75	excl.	T 2503	TG2503
excl. Sportline	1991 - 06.93							75	excl.	T 2503	TG2503
Sportline	1987 - 06.93										
Sportline	1991 - 06.93										



ANTERIORE  
FRONT

POSTERIORE  
REAR



## MERCEDES

### W 126

260 SE	1985 - 1991		50	N.D.		TG2506		65	excl.		TG2505
280 S, 280 SE, 280 SEL	1980 - 1985			H.D.		TG2507					
300 SE, 300 SEL	1985 - 1991										
300 SD Turbo Diesel	1981 -										
380 SE, 380 SEL	1980 - 1985										
420 SE, 420 SEL	1985 - 1991										
500 SE, 500 SEL	1980 - 1991										
560 SEL	1985 - 1991										
,  380 SEC	1981 - 1985		60	N.D.		TG2506		80	excl.		TG2505
,  500 SEC	1981 - 1985			H.D.		TG2507					
(W126)	1980 - 1991				T 2532						

### C 126

,  420 SEC	1985 - 1992		60	N.D.		TG2506		80	excl.		TG2505
,  500 SEC	1985 - 1992			H.D.		TG2507					
,  560 SEC	1985 - 1992										

### W 201

190E excl. 2.3-16, 2.5-16, Sportline	11.82 - 1993		105	ACC18	M 2502	MG2502		65	excl.	T 2503	TG2503
190D excl. Sportline	11.82 - 1993										
190E 2.3-16	1983 - 1993		105	ACC18		MG2508		65	excl.		TG2528
190E 2.5-16	1983 - 1993										
Sportline	11.82 - 1993										

### A - Klasse (W168)

A 140	1997 -					MG2554				T 2553	TG2553
A 160	1997 -										
A 170 CDI	1998 -										
A 190	1999 -										

### C - Klasse (W202)

C180	05.93 - 2000		90			TG2510		100	excl.		TG2511
C200, C200D	05.93 - 2000										
C220, C220D	05.93 - 2000										
C230, C250D	05.93 - 2000										
excl. Esprit, Sportline											
C250 TD	05.93 - 2000		90			TG2547		100			TG2548
C280	05.93 - 2000										
excl. Esprit, Sportline											
C180	1996 - 2000		90			TG2547					
C200, C200 CDI	1996 - 2000										
C220, C220 D, C220 CDI	1996 - 2000										
C230, C240	1996 - 2000										
C250TD, C280	1996 - 2000										
excl. Esprit, Sportline											
,  Esprit, Sportline	05.93 - 2000		90			TG2533		100			TG2534



ANTERIORE  
FRONT



POSTERIORE  
REAR



OIL

GAS



OIL

GAS

## MERCEDES

### C - Klasse (W203)

C180	2000 -										
C200 K, C200 CDi	2000 -										
C240, C320	2000 -										
C220 CDi, C270 CDi	2000 -										
C180	04.01 -										
C200 K, C200 CDi	04.01 -										
C240, C320	04.01 -										
C220 CDi, C270 CDi	04.01 -										
C180	04.01 -										
C200 K, C230 K	04.01 -										
C220 CDi	04.01 -										

### CL - Klasse (W140)

200, 230, 320	1996 -		90			TG2545		100			TG2546
---------------	--------	--	----	--	--	--------	--	-----	--	--	--------

### CLK - Klasse (W208)

CLK 200, CLK 200K	1996 -		90			TG2535		100			TG2536
CLK 230K, CLK 320	1996 -										
CLK 430	1996 -										
CLK 200, CLK 200K	1998 -		90			TG2535		100			TG2536
CLK 230K, CLK 320	1998 -										
CLK 430	1998 -										

### E - Klasse (W124)

E200, E200 D	1993 - 06.95		105		M 2502	MG2502		65		T 2503	TG2503
E220, E280	1993 - 06.95										
E250 D, E250 Turbo D	1993 - 06.95										
E300 D, E300 Turbo D	1993 - 06.95										
E320, E420	1993 - 06.95										
excl. Sportline, 4-Matic											
E500	1993 - 06.95		105		M 2502	MG2502					
Sportline	1993 - 06.95		105			MG2508		65			TG2509

### E - Klasse (V124)

E250 D	1993 - 1995		105		M 2502	MG2502					
E280	1993 - 1995										

### E - Klasse (S124)

E200, E220	1993 - 1995		105		M 2502	MG2502					
E280, E320	1993 - 1995										
E250 D	1993 - 1995										
E300 D, E300 Turbo D	1993 - 1995										
excl. Sportline, 4-Matic											
Sportline	1993 - 1995		105			MG2508					



ANTERIORE  
FRONT



POSTERIORE  
REAR

				<b>OIL</b>	<b>GAS</b>				<b>OIL</b>	<b>GAS</b>
--	--	--	--	------------	------------	--	--	--	------------	------------

## MERCEDES

### E - Klasse (C124)

E220 excl. Sportline	1993 - 1995		105	ACC18	M 2502	MG2502		65		T 2503	TG2503
E320 excl. Sportline	1993 - 1995										
Sportline	1993 - 1995		105	ACC18		MG2508		65			TG2509

### E - Klasse (A124)

E200, E220 excl. Sportline	1993 -							65		T 2503	TG2503
E300, E320 excl. Sportline	1993 -										
Sportline	1993 -							65			TG2509

### E - Klasse (W210)

E200, E220 D	05.95 - 03.02		90			TG2537		100	excl.		TG2538
E240, E280	05.95 - 03.02										
E290 TD, E300 D	05.95 - 03.02										
E320, E420 excl. Sportline,	05.95 - 03.02										
E230	05.95 - 03.02		90			TG2537		100	excl.		TG2539
E250 D	05.95 - 03.02										
E200 CDi, E220 CDi	05.95 - 03.02										
E270 CDi, E320 CDi excl. Sportline,	05.95 - 03.02										
E200, E230	05.95 - 03.02		90			TG2537		100			
E250 D, E290 TD	05.95 - 03.02										
E300 TD	05.95 - 03.02										
E320, E420 excl. Sportline,	05.95 - 03.02										

### G - Klasse (W460 - W463)

230 G, 230 GE (W460)	02.79 - 1990		60			HG2512		85			HG2513
240 GD, 250 GD (W460)	02.79 - 1990										
280 GE (W460)	02.79 - 1990										
300 GD (W460)	02.79 - 1990										
200 GE, 230 GE (W463)	1990 -		60			HG2514		85			HG2515
250 GD, 300 GD (W463)	1990 -										
290 GD, 350 GD (W463)	1990 -										
300 GE, 500 GE (W463)	1990 -										

### MB - Klasse

90, 100, 120	05.84 -		60		H 2519			60		H 2520	
140, 160, 180	05.84 -		60		H 2521			60		H 2522	

### M - Klasse

ML 320	1997 -		150			SG2549		120			SG2550
ML 430	1997 -										



ANTERIORE  
FRONT



POSTERIORE  
REAR



OIL

GAS



OIL

GAS

## MERCEDES

### S - Klasse (W140)

S280, S320	1993 - 1999					TG2529			excl.		TG2530
S300 TD, S350 TD	1993 - 1999										
S420, S500	1993 - 1999										
excl. ,											

### SL - Klasse

230 SL	1963 - 1966								excl.	T 2501	
250 SL	1967 - 1981										
280 SL	1968 - 1971										
280 SL	1968 - 1971										

### SL - Klasse (W107)

350 SL	04.71 - 1981		70		T 2504	TG2504		90	excl.	T 2505	TG2505
280 SL	07.74 - 1985										
350 SL (4500 cc.)	1972 - 1973										
450 SL	1973 - 1981										
380 SL, 500 SL	1980 - 1985										
300 SL, 420 SL, 500 SL	1985 - 1989										

### SL - Klasse (W129 - R129)

,  300 SL, 500 SL (W129)	1989 - 1993										
,  280 SL, 320 SL, 500 SL (R129)	1993 - 2000										

### SLC - Klasse (W107)

350 SL	04.71 - 1981		55		T 2504	TG2504		75	excl.	T 2505	TG2505
280 SL	07.74 - 1985										
350 SL (4500 cc.)	1972 - 1973										
450 SL	1973 - 1981										

### SLK - Klasse (W170)

	1996 -					TG2540					TG2541
--	--------	--	--	--	--	--------	--	--	--	--	--------

### SPRINTER

208D, 210D (901, 903)	1995 -					MG2551				T 2542	
212D, 214 (901, 903)	1995 -										
308, 310D (901, 903)	1995 -										
312D, 314 (901, 903)	1995 -										
408D, 410D (904)	1995 -					MG2552				H 2543	
412D, 414 (904)	1995 -										
408D, 410D (4,5 T)	1995 -										
412D, 414 (4,5 T)	1995 -										

### V - Klasse / VIANO (638)

excl. ,	1996 -									T 2544	TG2544



ANTERIORE  
FRONT



POSTERIORE  
REAR

				<b>OIL</b>	<b>GAS</b>				<b>OIL</b>	<b>GAS</b>
--	--	--	--	------------	------------	--	--	--	------------	------------

## MERCEDES

### VITO (638)

108D, 110D excl.	1996 -					MG2555			N.D.	T 2544	TG2544
113 excl.	1996 -								H.D.	H 2544	



L 207, L 208, L 208D (601) L 209D, L 209DE (601) L 210, L 210C, L 210D (601) L 307, L 307D, L 308 (602) L 309D, L 309DC (602) L 310, L 310C, L 310D (602)			25	<b>37</b>	T 2524			25	<b>37</b>	T 2525	
L 319, L 319B, L 319D (309) L 405, L 406, L 406D (309) L 408, L 408G, L 409 (309) L 408D L 393 L 406DG, L 407D (309) L 406G, LT 406, L 407			25	<b>37</b>	T 2526			25	<b>37</b>	T 2526	
L 406D, L 409 L 408, L 408D (310) L 408G, L 408DG L 508, L 508DG O 508D L 608, L 608D (310) L 613, L 613D (313) LP 808 (316) LP 913 (318)	1972 - 1972 - 1972 - 1972 - 1972 - 1970 - 1970 - 1976 - 1976 -		25	<b>37</b>	T 2527			25	<b>37</b>	T 2527	
O 309B, O 309D O 319B, O 319D OL 406, OL 407			25	<b>37</b>	T 2526			25	<b>37</b>	T 2526	

**37**

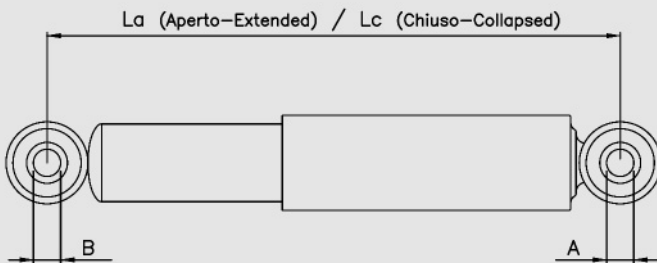

#### T 2524

A = 12 mm.  
B = 12 mm.  
La = 588 mm.  
Lc = 350 mm.

#### T 2525

A = 14 mm.  
B = 12 mm.  
La = 485 mm.  
Lc = 300 mm.

#### T 2526

A = 14 mm.  
B = 14 mm.  
La = 588 mm.  
Lc = 350 mm.

#### T 2527

A = 14 mm.  
B = 14 mm.  
La = 626 mm.  
Lc = 370 mm.

## MINI → BMW

--	--	--	--	--	--	--	--	--	--	--



ANTERIORE  
FRONT



POSTERIORE  
REAR



OIL

GAS

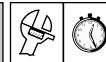

OIL

GAS

## MITSUBISHI

### CANTER

T90, T91, T94	1968 - 11.78				T 2921					
T95, T96, T97	1968 - 11.78									
T200, T204, T207	1968 - 11.78									
T210, T214, T217	1968 - 11.78									
T220	1973 - 11.78									
T92, T93, T98	1968 - 11.78				T 2921					HG1210
T215	1968 - 11.78									
FE111	12.78 - 09.82									T 0703
FE111 3000 Kg.	12.78 - 09.82									TG0703
FC432	1986 - 1990									T 0703
FE111 (BZ, BZ1, BZB)	10.82 - 1985									TG0703
FE111 (E, EW, EZ)	10.82 - 1985									
FE111 (EZC, EZCW)	10.82 - 1985									
FE114 (BZ, E, EW)	10.82 - 1985									
FE114 (EZ, EZC, EZCW)	10.82 - 1985									
FE131, FE134	12.78 - 1985									T 0703
FE211, FE214	12.78 - 1985									
FE231, FE234	12.78 - 1985									
FE331, FE431	1986 - 04.96									T 0703
FE441, FE444	1986 - 04.96									TG0703
FE531, FE649	05.96 -									T 0703

### CARISMA

1.6, 1.9TD (DA)	05.96 - 02.99					MG4519					SG4523
1.8, 1.8GDI (DA)	05.96 - 02.99					MG4524					
1.6, 1.9TD	03.99 -					MG2639					TG2647
1.8GDI	03.99 -					MG2640					

### CELESTE

1.4 (A72)	1975 - 1981				C 2601	CG2601					T 1704	TG1704
1.6 (A73)	1975 - 1981											
2.0 (A78)	1975 - 1981											

### COLT / MIRAGE

1.3, 1.5 (A50, A60, A110)	1969 - 1977				C 2601	CG2601						
,  (FTO, GTO)	1971 - 1977											
1.3 (A51, A52, A53, A54)	1969 - 1977				C 2601	CG2601					T 1303	TG1303
1.5 (A51, A52, A53, A54)	1969 - 1977											
,  1.2 (A15)	1978 - 12.83		120		C 2602			50			T 1706	TG1706
,  1.4 (A15) excl. 1.4 Turbo	1978 - 12.83											
,  1.4 Turbo (A152A)	03.82 - 12.83							50				TG1706
,  1.2 (C15A)	01.84 - 05.86		85			MG2603		50			T 2604	TG2604
,  1.5 (C12A)	01.84 - 05.86											
,  1.6 Turbo (C13A)	01.84 - 05.86											
,  1.8D (C14A)	01.84 - 05.86											





ANTERIORE  
FRONT



POSTERIORE  
REAR

				<b>OIL</b>	<b>GAS</b>				<b>OIL</b>	<b>GAS</b>
--	--	--	--	------------	------------	--	--	--	------------	------------

## MITSUBISHI

### COLT / MIRAGE

,  1.2 (C15A)	06.86 - 1988		85		ACC95		MG2605		50		T 2604	TG2604
,  1.3 (C11A)	06.86 - 1988											
,  1.5 (C12A) excl.	06.86 - 1988											
,  1.6 Turbo (C13A) excl.	06.86 - 1988											
,  1.8D (C14A)	06.86 - 1988											
,  1.5  (C12A)	1986 - 05.87		85		ACC18		MG2603		50		T 2604	TG2604
,  1.6 Turbo  (C13A)	1986 - 05.87											
,  1.3 (C51A, C51V) excl. ABS	04.88 - 12.91		85		ACC96		MG1701		90		S2606	SG2606
,  1.5 (C52A) excl. ABS	04.88 - 12.91											
,  1.6 GTi (C53A) excl. ABS	04.88 - 1990											
,  1.8 GTi (C58A) excl. ABS	1990 - 12.91											
,  1.8 D (C54A) excl. 4x4, ABS	04.88 - 12.91											
,  1.3 (CA1A)	01.92 - 04.96						MG2641		90		S 2607	SG2607
,  1.6 (CA4A) excl. ABS	01.92 - 04.96						MG2642					
,  1.6 4x4 (CC4A)	01.92 - 1996						MG2641		90		S 2607	SG2607
							MG2642					
,  1.8 GTi (CA5A) excl. ABS	01.92 - 04.96						MG2643		90			SG2607
							MG2644					
,  1.3 (CJ1) excl. 4x4	05.96 -						MG2645		90			SG2607
,  1.5 (CJ2) excl. 4x4	05.96 -						MG2646					
,  1.6 (CJ4) excl. 4x4	05.96 -											

### CORDIA / TREDIA

1.4 4x2 (A211A)	1982 - 1987		80		ACC18		MG2608		50		T 1706	TG1706
1.5 4x2 (A214A)	1982 - 1987											
1.6 4x2 (A212A)	1982 - 1987											
1.6 Turbo 4x2 (A212A)	1982 - 1987											
1.8 4x2 (A213A)	1982 - 1987											
1.8 Turbo (A213A)	1982 - 1987											
1.8 4x4 (A215G)	1985 - 1987								50		T 1706	TG1706
2.0 4x4 (A217G)	1985 - 1987											

### DELICIA

T100, T100V, T120V	1968 - 1979										T 1704	HG1210
T100, T100V, T120V	1968 - 1979											
(LO31PV, LO32PV)	06.79 - 05.86											
(LO33PW, LO34P)	06.79 - 05.86											

### ECLIPSE

(D21A, D22A) excl. 4x4	1991 - 1995						MG2626		80			SG2609
------------------------	-------------	--	--	--	--	--	--------	--	----	--	--	--------

### FORTE

(LO21P)	1978 -										T 1303	TG1303



ANTERIORE  
FRONT



POSTERIORE  
REAR

				<b>OIL</b>	<b>GAS</b>					<b>OIL</b>	<b>GAS</b>
--	--	--	--	------------	------------	--	--	--	--	------------	------------

## MITSUBISHI

### GALANT / SIGMA / SAPORRO / LAMBDA

1.6 (A110)	1973 - 1976		150		C 2601	CG2601					
1.8 (A112H)	1973 - 1976										
2.0 (A115H)	1973 - 1976										
1.6, 1.8, 2.0 (A120, A130)	1976 - 06.80		150		C 2601	CG2601		50			TG2610
1.6, 1.8, 2.0 (A120, A130)	1976 - 06.80										
1.6, 1.8, 2.0 (A120, A130)	1976 - 06.80										
1.6 (A161A)	07.80 - 07.84		150		C 2601	CG2601		50			TG2610
1.8 (A162A)	07.80 - 07.84										
2.0 (A163A)	07.80 - 07.84										
2.0 GLS (A164A) excl. Turbo	07.80 - 07.84		150		C 2601	CG2601					
2.6 (A166) excl. Turbo	07.80 - 07.84										
2.3 GLX Turbo Diesel (A167A)	1981 - 09.83		150		C 2601	CG2601		50			TG2610
1.6 (E11A)	09.83 - 08.87		110			MG2608		145		S 2611	SG2611
1.8 (E14A)	09.83 - 08.87										
1.8 Turbo (E14A)	09.83 - 08.87										
1.8 TD (E14A)	09.83 - 08.87										
2.0 (E15A)	09.83 - 08.87										
2.0 Turbo (E15A)	09.83 - 08.87										
2.4 (E16A)	09.83 - 08.87										
excl. □, ABS											
1.6 (E31A) excl. 4x4, 4WS, □	09.87 - 10.92		110			MG2612		145		S 2611	SG2611
1.8 (E32A) excl. 4x4, 4WS, □	09.87 - 10.92										
1.8TD (E34A) excl. 4x4, 4WS, □	09.87 - 10.92										
2.0 (E33A) excl. 4x4, 4WS, □	09.87 - 10.92										
1.8 (E52A) excl. ☼, □	11.92 - 1996					SG2648		110			SG2635
2.0 (E55A, E75A) excl. ☼, □	11.92 - 1996										
2.0 24V (E54A, E64A) excl. ☼, □	11.92 - 1996										
2.0TD (E57A) excl. ☼, □	11.92 - 1996										
2.5 V6 (E88A) excl. ☼, □	11.92 - 1996										
Incl. 4x4, 4WS											
2.0 (EA2A, EA2W) excl. ☼	10.96 -					SG2648					TG2649
2.5 (EA5A, EA5W) excl. ☼	10.96 -										
2.0 TD (EA6A, EA6W) excl. ☼	10.96 -										
1.6 (A112V)	1973 - 1976		150		C 2601	CG2601		50		T 1303	TG1303
1.6 (A121V, A123V)	1976 - 1980		150		C 2601	CG2601		50		T 1303	TG1303
1.8 (A121V, A123V)	1976 - 1980										
2.0 (A121V, A123V)	1976 - 1980										
1.6 (A161V)	1980 - 09.83		150		C 2601	CG2601		50		T 1303	TG1303
2.0 (A163V)	1980 - 09.83										
2.3 TD (A167V)	1980 - 09.83										

### JEEP

J52, J3, J3R	1954 - 1975					HG1210					HG1210
J54, J56, J58	1974 - 04.77										
J20, J30, J40	1961 -				T 1303	TG1303				T 1303	TG1303
J54, J56, J57, J58, J59	05.77 -										





ANTERIORE  
FRONT



POSTERIORE  
REAR



OIL

GAS



OIL

GAS

## MITSUBISHI

### LANCER

1.2 (A75)	1973 - 02.79		80							T 1704	TG1704
1.4 (A72)	1973 - 02.79										
1.6 (A73)	1973 - 02.79										
2.0 (A70, A71)	1973 - 02.79										
Mitsubishi no MT002060 - MT400701											
1.2 (A75)	1973 - 02.79		80		C 1703					T 1704	TG1704
1.4 (A72)	1973 - 02.79										
1.6 (A73)	1973 - 02.79										
2.0 (A70, A71)	1973 - 02.79										
Mitsubishi no MT400703											
1.2 (A75)	1973 - 02.79			ACC11	C 2601	CG2601				T 1704	TG1704
1.4 (A72)	1973 - 02.79										
1.6 (A73)	1973 - 02.79										
2.0 (A70, A71)	1973 - 02.79										
Mitsubishi no MT001670 - MB001671											
1.2 (A171, Ch. -> 6102532)	03.79 - 12.79			ACC11	C 2601	CG2601					
1.4 (A172, Ch. -> 6503419)	03.79 - 12.79										
1.6 (A174, Ch. -> 6402713)	03.79 - 12.79										
Mitsubishi no MB001672											
1.2 (A171, Ch. 6102533 ->)	01.80 - 10.82		90	ACC11	C 2601	CG2601		90		T 2613	
1.4 (A172, Ch. 6503420 ->)	01.80 - 10.82										
1.6 (A174, Ch. 6402714 ->)	01.80 - 10.82										
1.8 (A175) excl. Turbo	01.80 - 09.83										
Mitsubishi no MB001672											
1.2 (A171, Ch. 6102533 ->)	01.80 - 10.82							90		T 2613	
1.4 (A172, Ch. 6503420 ->)	01.80 - 10.82										
1.6 (A174, Ch. 6402714 ->)	01.80 - 10.82										
1.8 (A175) excl. Turbo	01.80 - 09.83										
Mitsubishi no MB002190											
1.8 Turbo (A175)	10.80 - 03.83									T 2613	
2.0 Turbo (A176A)	10.80 - 03.83										
1.2 (A155A)	09.82 - 1984		195	ACC18	C 2602			50		T 1706	TG1706
1.4 (A156A)	09.82 - 1984										
1.2 (C15A)	1984 - 05.86		85	ACC18		MG2603		50		T 2604	TG2604
1.5 (C12A)	1984 - 05.86										
1.6 Turbo (C13A)	1984 - 05.86										
1.8 D (C14A)	1984 - 05.86										
1.2 (C15A)	06.86 - 1988		85	ACC95		MG2605		50		T 2604	TG2604
1.3 (C11A)	06.86 - 1988										
1.5 (C12A) excl.	06.86 - 02.89										
1.6 Turbo (C13A) excl.	06.86 - 02.89										
1.8 D (C14A)	06.86 - 1988										
(C60 Series) excl. ABS, 4x4	1988 - 04.92		85	ACC96		MG1701		75		S 2606	SG2606



ANTERIORE  
FRONT

POSTERIORE  
REAR



				OIL	GAS				OIL	GAS
--	--	--	--	-----	-----	--	--	--	-----	-----

## MITSUBISHI

### LANCER

1.3 4x2 (CB1A) excl. ABS	05.92 - 1996					<u>MG2641</u>		90		S 2607	SG2607
1.5 4x2 (CB2A) excl. ABS	05.92 - 1996					<u>MG2642</u>					
1.6 4x2 (CB4A) excl. ABS	05.92 - 1996										
2.0 D 4x2 (CB8A) excl. ABS	05.92 - 1996										
1.6 4x4 (CD4A) excl. ABS	05.92 - 1993					<u>MG2641</u> <u>MG2642</u>		90		S 2607	SG2607
1.8 GTI 4x2 (CB5A) excl. ABS	05.92 - 1996					<u>MG2643</u> <u>MG2644</u>		90			SG2607
1.3 (CK1)	1996 -					<u>MG2645</u>		90		S 2607	SG2607
1.5 (CK2)	1996 -					<u>MG2646</u>					
1.6 (CK4)	1996 -										
1.2 (A75V)	1973 - 02.79				ACC11	C 2601					
1.4 (A72V)	1973 - 02.79										
1.6 (A73V)	1973 - 02.79										
2.0 (A70V, A71V)	1973 - 02.79										
Mitsubishi no MB001670 - MB001671											
1.2 (A75V)	1973 - 02.79					C 1703					
1.4 (A72V)	1973 - 02.79										
1.6 (A73V)	1973 - 02.79										
2.0 (A70V, A71V)	1973 - 02.79										
Mitsubishi no MT400703											
1.2 (A75V)	1973 - 02.79										
1.4 (A72V)	1973 - 02.79										
1.6 (A73V)	1973 - 02.79										
2.0 (A70V, A71V)	1973 - 02.79										
Mitsubishi no MT002060 - MT400701											
1.5 (C12V)	1984 - 05.86		85		ACC18			50		T 1303	TG1303
1.8D (C14V)	1984 - 05.86										
1.5 (C12V) excl.	06.86 - 1991		85		ACC95			50		T 1303	TG1303
1.8D (C14V) excl.	06.86 - 1991										
1.5 (C12V)	06.86 - 1988		85		ACC18			50		T 1303	TG1303
1.8D (C14V)	06.86 - 1988										
1.6 4x2 (CB4W) excl. ABS	06.92 - 1996					<u>MG2641</u>				T 2614	TG2614
2.0D 4x2 (CB8W) excl. ABS	06.92 - 1996					<u>MG2642</u>					
1.6 4x4 (CD4W) excl. ABS	06.92 - 1996									T 2614	TG2614



ANTERIORE  
FRONT



POSTERIORE  
REAR

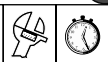

OIL

GAS

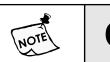
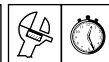

OIL

GAS

## MITSUBISHI

### PAJERO / MONTERO / SHONGUN

2.3 D (LO43G, LO48G) ⚡	1982 - 1986	⚡	50		H 2615	HG2615	⚡	50		H 2616	HG2616
2.5 D (LO44G, LO49G) ⚡	1986 - 1991										
2.6 (LO42G, LO47G) ⚡	1982 - 1991										
P25L	1985 - 1991										
2.5 D (L144G, L149G) ⚡	1988 - 1991	⚡	85		H 2615	HG2615	⚡	75			HG2617
3.0 (L141G, L146G) ⚡	1988 - 1991										
2.4 (V21, V41) excl. ⚡	1991 - 1999	⚡	50		H 2618	HG2618	⚡	50		H 2619	HG2619
2.5 DT (V24, V44) excl. ⚡	1991 - 1999										
3.0 (V23, V43) excl. ⚡	1991 - 1999										
2.8 DT (V26, V46) excl. ⚡	1991 - 1999										
3.5 (V25, V45) excl. ⚡	1991 - 1999										
Sport (K94, K96)	1999 -	⚡	50		H 2618	HG2618	⚡				
V64W, V65W, V68W	1999 -	⚡			<i>H 2650</i>		⚡			<i>H 2651</i>	
V74W, V75W, V78W	1999 -										
Pinin (H66W, H67W, H77W)	1999 -	⚡				<i>MG2652</i>	⚡			<i>H 2653</i>	

### SPACE RUNNER

1.8 4x2 (N11W)	06.91 - 1999	⚡	110			MG2620	⚡	70			TG2621
2.0 TD 4x2 (N18W)	06.91 - 1999										
1.8 4x4 (N21W)	06.91 - 1999										

### SPACE WAGON

🚗 4x2	02.83 - 10.91	⚡	85			MG2608	⚡	50		T 1706	TG1706
🚗 4x4	02.85 - 10.91						⚡	50		T 1706	TG1706
🚗 4x2	11.91 - 06.98	⚡	110			MG2620	⚡	70			TG2621
🚗 4x4	11.91 - 06.98						⚡	70			TG2621
🚗 4x2	07.98 -	⚡		⚡			⚡				
🚗 4x4	07.98 -	⚡		⚡			⚡				



ANTERIORE  
FRONT



POSTERIORE  
REAR



## MORRIS

### ITAL

	05.80 - 1984							40		T 4901	
--	--------------	--	--	--	--	--	--	----	--	--------	--

### MARINA

MK I, MK II	1971 - 1981							40		T 4901	
-------------	-------------	--	--	--	--	--	--	----	--	--------	--

## MOSKVITCH

### 400 / SCALDIA / 2000 SERIES

400 Series	1956 -				T 2701					T 2702	HG2702
Scaldia	1963 -										
2138, 2136	12.74 -										
2140, 2137	12.74 -										

### ALEKO

					CG2705						TG0312
--	--	--	--	--	--------	--	--	--	--	--	--------

## NISSAN

### 100 NX

1.6 (B13) excl.	1991 -		150		M 2857	MG2857					MG2887
2.0 (B13) excl.	1991 -				M 2858	MG2858					MG2886

### ALMERA

1.4, 1.6 (N15)	07.95 - 12.97			38		MG2889			39		SG2890
2.0 D (N15)	07.95 - 12.97			38		MG2888					
2.0 GTI (N15)	07.95 - 08.97										
2.0 GTI (N15)	08.97 - 12.97			38		MG2889					
				38		MG2888					
1.4, 1.6 (N15)	01.98 - 01.00			38		MG4815			39		SG4821
2.0 D (N15)	01.98 - 01.00			38		MG4816					
2.0 GTI (N15)	01.98 - 01.00										
1.5, 1.8 (N16)	02.00 -					MG4817					SG4822
2.2 D (N16)	02.00 -					MG4818					

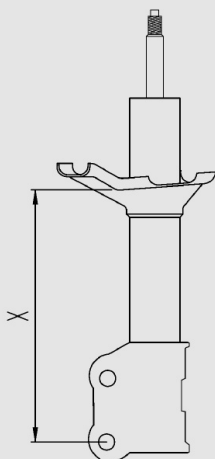

**38**

MG2888 X = 215 mm.

MG2889 X = 215 mm.

MG4815 X = 244 mm.

MG4816 X = 244 mm.

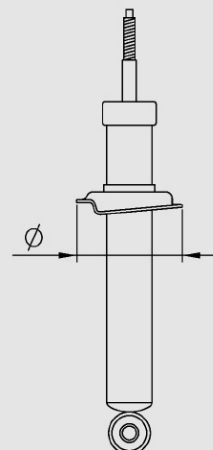

**39**

SG2890 Ø = 103 mm.

SG4821 Ø = 93 mm



ANTERIORE  
FRONT



POSTERIORE  
REAR



OIL

GAS



OIL

GAS

## NISSAN

### BLUEBIRD

,  160B, 200B (L610)	1971 - 06.76									T 2801	TG2801
,  180B, 180B SSS (L610)	1971 - 06.76										
,  200 GTX, 200 GTXE (L610)	1973 - 06.76										
160B, 180B (810, )	07.76 - 1980				C 2802					S 2803	SG2803
180B SSS (810, )	07.76 - 1980										
160 B (810, )	07.76 - 1980				C 2802						
180 B (810, )	07.76 - 1980										
,  1.6, 1.8 (910, )	1980 - 1983		240		C 2804	CG2804		70		S 2803	SG2803
,  2.0, 2.0D (910, )	1980 - 1983										
,  1.6 (U11, )	1984 - 1986							180			CG2809
,  1.8, 1.8 Turbo (U11, )	1984 - 1986										
,  2.0, 2.0 Turbo (U11, )	1984 - 1986										
,  2.0D (U11, )	1984 - 1986										
,  1.6, 1.8 (T12) excl. Turbo,	1986 - 1990		195			MG2808		180			CG2809
,  2.0, 2.0 D (T12) excl.	1986 - 1990										
,  1.6, 1.8 (T72) excl. Turbo,	1988 - 1990		195			MG2808		180			CG2809
,  2.0, 2.0 D (T72) excl.	1988 - 1990										
(GB)											
, 160B, 180B (V810, )	07.76 - 1980				C 2802						
1.8, 2.0 (J910, )	1980 - 1983		240		C 2804	CG2804		60			
2.0 D (J910, )	1980 - 1983										
1.8, 2.0 (J910, )	02.82 - 1983		240		C 2804	CG2804		60		T 1303	TG1303
2.0 D (J910, )	02.82 - 1983										
1.8, 1.8 Turbo, 2.0 (U11, )	1983 - 1985							180			CG2809
2.0 D, 2.0 Turbo D (U11, )	1983 - 1985										
(U11, ) excl.	1986 - 1990		195			MG2808		180			CG2809

### CAB / KING CAB / PICK-UP

(520, 521)	1965 - 1979					HG2835			N.D.	T 2836	TG2836
(620)	1965 - 1979								H.D.	H 2836	
4x2 (720)	10.79 - 08.85		50			HG2837		50	N.D.	T 2836	TG2836
4x4 (720)	10.79 - 12.81								H.D.	H 2836	
King Cab											
4x4 (720)	01.82 - 08.85		50			HG2837		50		H 2616	HG2616
King Cab											
4x2 (GD21)	09.85 - 01.98		40	N.D.	H 1901	HG1901		40			HG2838
				H.D.		HG4805					
4x4 (MD21)	09.85 - 01.98		40			HG2839		40			HG2838
4x2 (D22)	02.98 -					TG4809		40	N.D.		TG4811
								40	H.D.		HG2838
4x4 (D22)	02.98 -					TG4810					TG4812





ANTERIORE  
FRONT

POSTERIORE  
REAR



				<b>OIL</b>	<b>GAS</b>				<b>OIL</b>	<b>GAS</b>
--	--	--	--	------------	------------	--	--	--	------------	------------

## NISSAN

### CABSTAR

A320, A321	1969 - 1975									T 2836	TG2836
(F20)	1976 - 1982						40			T 1303	TG1303
(F22)	1983 - 1992		50		H 1901	HG1901		40		H 2868	

### CARAVAN-HOMY / E SERIES

(E20)	04.78 - 09.80					HG2835					
(E21)	04.78 - 09.80										
(E22)	04.78 - 09.80										
(E23)	10.80 - 08.86					HG2835			N.D.	T 2836	TG2836
									H.D.	H 2836	

### CEDRIC / GLORIA

2.0, 2.4 (130)	1967 - 1971									T 2801	TG2801
,  220C, 240C (230)	1972 - 06.75									T 1303	TG1303
,  220D (L230)	1972 - 06.75										
,  260C, 280C (230)	1972 - 06.75										
,  200C, 220C (L230)	06.75 - 06.79									T 1303	TG1303
,  260C, 280C (L230)	06.75 - 06.79										
200C, 240C (W230)	1972 - 1975									T 2702	
260C, 280C (W230)	1972 - 1975										
200C, 220C (L330)	1975 - 1979									T 2702	
220D (L330)	1975 - 1979										
260C, 280C (L330)	1975 - 1979										
200C, 280C (L430)	1979 - 1983										

### CHERRY / PULSAR / LANGLEY

,  100A (E10)	1971 - 1975									T 2812	
120A (E10)	1973 - 1975										
,  100A FII (F10, F11)	1975 - 1978		195		ACC11	C 2813		60		T 2812	
,  120A FII (F10, F11)	1975 - 1978										
140A FII (F10, F11)	1975 - 1978										
,  100A, 120A (N10)	1979 - 01.82		195		ACC11	C 2813		60		T 2812	
100A, 120A (N10)	1979 - 01.82										
,  1.3, 1.5 (N12) excl. Turbo	02.82 - 1986		140			MG2815		60		T 0118	TG0118
,  1.7D (N12)	02.82 - 1986										
1.3, 1.5, 1.7D (N12) excl. Turbo	02.82 - 1986										
excl. Alfa 33 Susp.											
,  ,  1.5 Turbo (N12)	02.82 - 1986							60			TG0118
1.2 (Alfa 33 susp.)	08.83 - 1985				<b>1 - 3</b>	MG0103		60		T 0118	TG0118
1.5 GTI (Alfa 33 susp.)	08.83 - 1985				<b>1 - 3</b>	MG0104					
,  (N13) excl. 4x4,	1986 - 1991		180			M 2816		120		ACC67	M 2817
100A, 120A (VE10)	1971 - 09.74									T 2418	
100A FII, 120A FII (VF10)	10.74 - 1978		195		ACC11	C 2813		60		T 2418	
100A, 120A, 140A (N10)	1979 - 01.82		195		ACC11	C 2813		60		T 2840	TG2840

Vedi disegno Alfa Romeo 33 a pagina 1 - See drawing Alfa Romeo 33 on page 1



ANTERIORE  
FRONT



POSTERIORE  
REAR



OIL

GAS



OIL

GAS

## NISSAN

### CLIPPER

662H, 663H	1969 - 05.76				T 2801	TG2801				T 1303	TG1303
YT, TWT, YHWT40	1974 - 1982									T 1303	TG1303

### ECOT-T

ECOT-T 100	04.96 -				T 4813					T 4814	
------------	---------	--	--	--	--------	--	--	--	--	--------	--

### FAIRLADY / ZX SERIES

240Z, 260Z (S30)	1970 - 06.74				C 2804	CG2804					
260Z, 280Z (S30)	07.74 - 06.78										
280 ZX (S130)	07.78 - 08.81		240		C 2804	CG2804					
280 ZX (S130)	09.81 - 09.83		240		C 2804	CG2804		105		S 2803	SG2803
300 ZX excl.	09.81 - 1989							80			TG2819
300 ZX Turbo excl.	09.81 - 1989										

### HOMER

1.5 T (T641, T642, 20)	1968 - 1976									T 1303	TG1303
1.25 T (T641, T20, F20)	1968 - 12.81										

### LAUREL

1.8 (C30)	1968 - 02.70				C 2802					T 2801	TG2801
1.8 (C30)	03.70 - 1972									T 2801	TG2801
180L, 200L (C130, C131)	1972 - 01.77		60		C 2802					T 2402	
260L, 280L (C130, C131)	1972 - 01.77										
180L, 200L (KC130, KC131)	1972 - 01.77		60		C 2802						
260L, 280L (KC130, KC131)	1972 - 01.77										
,  180L, 200L (C230, C231)	02.77 - 1980		60		C 2802						
,  240L, 260L (C230, C231)	02.77 - 1980										
,  280L (C230, C231)	02.77 - 1980										
,  1.8, 2.0 (C31)	1981 - 1985		60		C 2802			120		S 2820	
,  2.4, 2.8 D (C31)	1981 - 1985										
,  1.8, 2.0 (C32, )	1985 - 1989		255			CG2821		120		S 2803	SG2803
,  2.4, 2.8 D (C32, )	1985 - 1989										

### LEOPARD

1.8 (JF30)	1980 - 1982				C 2804	CG2804				S 2803	SG2803
2.0, 2.8 SFL (PF30, HF30)	1980 - 1982				C 2804	CG2804					
3.0 Turbo (PF30, HF30)	1980 - 1982										

### MAXIMA

(J30) excl.	10.88 - 09.94		195			MG2823 MG2822		160	excl.		CG2824
(A32) excl.	10.94 - 05.00		195			MG2891 MG2892					SG2893



ANTERIORE  
FRONT



POSTERIORE  
REAR



## NISSAN

### MICRA / MARCH

(K10)	1983 - 1992				M 2881			50		S 2827	
(K11)	08.92 -				M 2869	MG2869		30		T 2828	TG2828
					M 2870	MG2870					

### PATROL / SAFARI

2.8, 3.3D, 3.3TD (160)	06.80 - 08.85		40			HG2829		50			HG2830
2.8, 3.3D, 3.3TD (L160)	07.82 - 1987										
2.8, 3.3D, 3.3TD (260)	07.82 - 1987										
2.8 D, 2.8 TD (260)	04.89 -		50			HG2831		50			HG2833
3.0 (260)	04.89 -										
Patrol GR 2.8TD (Y60,	08.87 - 1997		50			HG2831		50			HG2832
Patrol GR 2.8TD (Y61)	1998 -				H 4801					H 4802	
	06.80 - 03.89				T 2895						
	04.89 -				T 2896						

### PRAIRE

(BM10) excl. 4x4	08.82 - 1988		180			MG2815				T 2840	TG2840
(PM10) excl. 4x4	08.82 - 1988										
(M11) excl. 4x4	10.88 - 07.94		195			MG2823		160			CG2841
						MG2822					
4x4 (NM11)	10.88 - 07.94		195			MG2823					
						MG2822					

### PRESIDENT

3.0, 4.0 (H150)	1965 - 1973									T 2801	TG2801
4.4 (H250)	1973 - 1983										

### PRIMERA

1.6 (P10) excl. ABS	1990 - 1996		120		S 2842	SG2842		135		M 2843	MG2843
2.0 D (P10) excl. ABS	1990 - 1996									M 2844	MG2844
1.6 ABS (P10)	1990 - 1996		120		S 2842	SG2842					
2.0 D ABS (P10)	1990 - 1996										
2.0 (P10)	1990 - 1996		120		S 2842	SG2842		135			MG2871
2.0 GT, 2.0 GTi (P10)	1990 - 1996										MG2872
,  1.6, 2.0 (P11) excl. GTi, SRi	1996 - 03.02			N.D.		SG2897			N.D.		SG2898
,  2.0 D (P11)	1996 - 03.02			H.D.		SG4803			H.D.		SG4804
,  2.0 GTi (P11)	1996 - 03.02					SG4803					SG4804
,  2.0 SRi (P11)	1996 - 03.02										
1.6, 2.0 (W10)	1991 - 1997					MG2845		50			TG2847
2.0 D (W10)	1991 - 1997					MG2846					
1.6, 2.0 (WP11)	1998 - 03.02			N.D.		SG2897			N.D.		SG2898
2.0 D (WP11)	1998 - 03.02			H.D.		SG4803			H.D.		SG4804

Vedi disegno Nissan Primera a pagina 69 - See drawing Nissan Primera on page 69



ANTERIORE  
FRONT



POSTERIORE  
REAR



OIL

GAS



OIL

GAS

## NISSAN

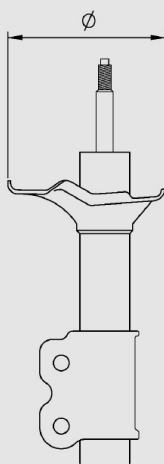

**40**

M 2843 ∅ = 152 mm.

M 2844 ∅ = 152 mm.

MG2843 ∅ = 152 mm.

MG2844 ∅ = 152 mm.

MG2871 ∅ = 170 mm.

MG2872 ∅ = 170 mm.

## SERENA

1.6 (C23 M)	07.92 -			←		MG2875		30	←		HG1210
2.0 D (C23 M) excl. SGX	07.92 -			→		MG2876					
2.3 D (C23 M) excl. SGX	1995 -										
2.0 (C23 M)	07.92 - 05.96			←		MG2875		30	←		HG2879
2.0 D SGX (C23 M)	07.92 -			→		MG2876					
2.3 D SGX (C23 M)	1995										
2.0 (C23 M)	06.96 -			←		MG2875			←		
				→		MG2876					
1.6 (C23 M)	07.92 -			←		MG2875		30	←		HG1210
2.0 D, 2.3 D (C23 M)	07.92 -			→		MG2876					

## SILVIA / GAZELLE

200 SX	1975 - 07.79			ACC18	C 2802						
(S110)	08.79 - 07.83				C 2848					T 2849	TG2849
(S12)	08.83 - 04.88		240	ACC18	C 2804	CG2804		50			TG2850
200 SX (S13)	09.88 - 1994			←	M 4807						SG4808
				→	M 4806						

## SKYLINE

,  1.8 (C10)	1968 - 1972			ACC18	C 2802					T 2921	
,  2.0 GT (C10)	1968 - 1972			ACC18	C 2802						
,  160 K (C110)	1972 - 1977			ACC18	C 2802					T 2402	
,  180 K (C10)	1972 - 1977										
,  200 KGT (C110)	1972 - 1977			ACC18	C 2802						
,  240 KGT (C110)	1972 - 1977										
1.8 (C10)	1968 - 1972			ACC18	C 2802					T 3602	TG3602
160 K (C110)	1972 - 1977			ACC18	C 2802						
180 K (C110)	1972 - 1977										



ANTERIORE  
FRONT



POSTERIORE  
REAR

				<b>OIL</b>	<b>GAS</b>					<b>OIL</b>	<b>GAS</b>
--	--	--	--	------------	------------	--	--	--	--	------------	------------

## NISSAN

### STANZA

,  1.6, 1.8 (T11)	06.81 - 1986		180		C 2852			160		C 2853	
,  1.7 D (T11)	06.81 - 1986										
,  1.6, 1.8 (T12) excl. Turbo	1986 - 1990		120			MG2808		160			CG2854
,  2.0, 2.0 D (T12) excl. Turbo	1986 - 1990										

### SUNNY / SENTRA

1.2 (B110)	1970 - 1974					CG2855					
1.2 (KB110)	1970 - 1974										
Excellent 1.4 (PB110)	1971 - 02.73				C 2802					T 2849	TG2849
120 Y (B210, B211)	1973 - 1975					CG2855					
120 Y (B310)	1978 - 1981		195		C 2848			70		T 2849	TG2849
140 Y (B310)	1978 - 1980										
150 Y (B310)	1980 - 1981										
1.3, 1.5 (B11, )	1982 - 09.85		120			MG2815		60		T 0118	TG0118
1.7 D (B11, )	1982 - 05.86										
,  (B12) excl. 4x4,	1986 - 1991		180		M 2816	MG2816		120		M 2817	MG2817
,  (N13) excl. 4x4,	1986 - 1991										
,  1.4 (N14) excl.	1991 - 1995		150		M 2857	MG2857		150		M 2859	MG2859
,  2.0 D (N14) excl.	1991 - 1995				M 2858	MG2858					
,  1.6 (N14) excl. 4x4,	1991 - 1995		150		M 2857	MG2857					MG2887
,  2.0 (N14) excl. 4x4, Diesel,	1991 - 1995				M 2858	MG2858					MG2886
Excellent 1.4 (PB110)	1971 - 02.73				C 2802						
120 Y (B210)	1973 - 1975		195			CG2855					
120 Y, 140 Y (B310)	1978 - 1981		195		C 2848			70		T 2849	TG2849
1.3, 1.5 (B11)	1982 - 09.85		120			MG2815		60		T 0118	TG0118
1.7 D (B11)	1982 - 05.86										
,  1.2 (VB110)	1970 - 1973					CG2855					
,  1.2 (B120)	1970 - 1973										
120 Y (B210)	1973 - 1975		195			CG2855					
140 Y (B310)	1978 - 1981		195			CG2855		70		T 1303	TG1303
1.3, 1.5, 1.6 (WB11, )	1982 - 1986		120			MG2815		60		T 0118	TG0118
1.7 D (WB11, )	1982 - 1986										
1.3, 1.5, 1.6 (B11, )	1983 - 1986		120			MG2815		60			TG2856
1.7 D (B11, )	1983 - 1986										
1.5, 1.6 (WB12) excl. , 4x4	1986 - 1991		180		M 2816	MG2816		120		M 2817	MG2817
1.7 D (WB12) excl.	1986 - 1991										
(Y10) excl. 4x4	1991 -		150		M 2857	MG2857		50			TG2860
1.2 (B110)	1970 - 1974					CG2855					
120 Y (B310, )	1978 - 1981					CG2855					
140 Y (B310, )	1978 - 1981										
(B11, )	1983 - 1991		120			MG2815		60			TG2856
(Y10, Q-BIC) excl. 4x4	12.91 -		150		M 2857	MG2857		50			TG2860
					M 2858	MG2858					



ANTERIORE  
FRONT



POSTERIORE  
REAR



OIL

GAS



OIL

GAS

## NISSAN

### TERRANO / PATHFINDER

(WD21) excl.	1987 - 1993					HG2861					HG2702
	1987 - 1989				T 2894						
Terrano II  (R20) excl.	02.93 -					HG2861		40			HG2880
Terrano II  (R20) excl.	02.93 -										
(R50)	10.97 -					MG4819 MG4820					TG4823

### TINO

	2000 - 12.00					MG4825 MG4826					TG4824
	01.01 -					MG4827 MG4828					TG4824

### TRADE

2.0					H 2882					H 2883
2.8	- 03.93				H 2884					H 2883
2.8	- 03.93				H 2884					H 2885

### URVAN

E 20								40		H 2836
E 23	1980 - 10.86		40		H 2862			40		H 2836
E 24	11.86 -		40		H 2863			40		H 2625

### VANETTE

,  (C120)	1978 - 06.87				T 2864					T 2865
(C220)	1987 -									
(GC22, )	1986 -		50		H 2866			50		H 1210
(GC22, )	1986 -		50		H 2866			50		H 2867
(GC32M)	1991 -									
1.6 (C23 M)	1994 -					MG2875		30		HG1210
2.0 D (C23 M) excl. SGX	1994 -					MG2876				
2.3 D (C23 M) excl. SGX	1994 -									
2.0 (C23 M)	1994 -					MG2875		30		HG2879
2.0 D SGX (C23 M)	1994 -					MG2876				
2.3 D SGX (C23 M)	1994 -									

### VIOLET

140J, 160J (710, 711; )	1973 - 04.77									T 3201
140J, 160J (710, 711; )	1973 - 04.77									
140 J SSS (710, 711; )	1973 - 04.77									T 2801
160 J SSS (710, 711; )	1973 - 04.77									TG2801
140 J SSS (710, 711; )	1973 - 04.77									
160 J SSS (710, 711; )	1973 - 04.77									
140J, 160J (A10, A11)	05.77 - 1981		240		C 2848			60		T 2849
140J, 160J (A10, A11)	05.77 - 1981									TG2849
Incl. SSS										
160 J (A10, VA11)	05.77 - 1981		240		C 2848			60		T 1303
										TG1303



ANTERIORE  
FRONT



POSTERIORE  
REAR



## OPEL

### AGILA

	2000 -					MG2968					TG2969
--	--------	--	--	--	--	--------	--	--	--	--	--------

### ASCONA

(Type A)	1970 - 08.75		35					40		T 2902	TG2902
(Type B)	09.75 - 08.81		35		T 2903	TG2903		40		T 2902	TG2902
(Type C) , Ch. → F1003026	08.81 - 08.84		120	ACC59	C 2904	CG2904		35		T 2905	TG2905
(Type C) , Ch. → F5000000	08.81 - 08.84										
(Type C) , Ch. → F6000000	08.81 - 08.84										
(Type C) , Ch. F1003027 →	09.84 - 1988		120	ACC59	C 2906	CG2906		35		T 2905	TG2905
(Type C) , Ch. F5000001 →	09.84 - 1988										
(Type C) , Ch. F6000001 →	09.84 - 1988										

### ASTRA

(Type F) excl. GT, GSi	09.91 - 03.98		150	ACC88	C 2907	CG2907		40		T 2908	TG2908
(Type F) excl. GT, GSi	09.91 - 03.98										
,  1.6 GT (Type F)	09.91 - 03.98		150	ACC88		CG2907		40			TG2908
,  2.0 Gsi (Type F)	09.91 - 03.98		150	ACC59		CG2907		40			TG2939
(Type G)	04.98 -		130	←	M 2953	MG2953		80		T 2955	TG2955
(Type G)	04.98 -			→	M 2954	MG2954					
Caravan (Type F)	09.91 - 03.98		150	ACC88	C 2907	CG2907		40	excl.	T 2909	TG2909
(Type G) excl.	04.98 -		130	←	M 2953	MG2953		80	excl.	T 2956	TG2956
				→	M 2954	MG2954					
1.8 16V (Type G)	2000 -		130	←	M 2953	MG2953		80			
2.2 16V (Type G)	2000 -			→	M 2954	MG2954					
(Type F)	09.91 - 1998		150			CG2907		40			TG2908

### BLITZ

Blitz (Bedford CF)	1974 - 1980		45		H 2910			25		H 2911	
--------------------	-------------	--	----	--	--------	--	--	----	--	--------	--

### CALIBRA

2.0, 2.0 16V excl. Turbo,	1990 - 1998		145			CG2912		45	excl.		TG2913
2.5 V6 excl.	1993 - 1998										

### CAMPO / BRAVA

4x2 (TFR Series)	1992 -		60		H 2914			60		H 2915	
4x4 (TFS Series)	1992 -		60			HG2916		60			HG1902

### COMMODORE

2.2, 2.5 (Type A)	1967 - 1972				T 2920					T 2921	TG2921
2.5, 2.8 (Type B)	1972 - 1977				T 2920					T 2922	TG2922
2.5, 2.8 (Type B)	1972 - 1977										
2.5 S (Type C)	1978 - 1982		145		C 2923	CG2923		60		T 2922	TG2922



ANTERIORE  
FRONT



POSTERIORE  
REAR



OIL

GAS

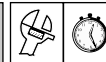

OIL

GAS

OIL

GAS

## OPEL

### CORSA

(Type A) excl. GSi	09.82 - 12.92		150		M 2917	MG2917		50		T 2918	TG2918
GSi (Type A)	1988 - 12.92		150			MG2943		50			TG2919
(Type B) excl. GSi	01.93 - 1999		150		M 2942	MG2942		50		T 2944	TG2944
GSi 16V (Type B)	01.93 - 1999		150			MG2943		50			TG2944
(Type C) excl. Sport	2000 -		150			MG2965		50			TG2967
						MG2966					
COMBO	1985 - 1993		140		C 2927	CG2927		25		T 2929	
COMBO	1993 -		140		M 2943	MG2943		25		T 2929	

### FRONTERA

2B (Type A, )	1991 - 08.95		60		H 2924	HG2924		60		H 2925	HG2925
4B (Type A, )	1991 - 08.95										
2B (Type A, )	09.95 - 1998		60			HG2947		60			HG2930
4B (Type A, )	09.95 - 1998										
2B (Type B)	1999 -		60			HG2960		60			HG2961
4B (Type B)	1999 -										

### GT

1.1, 1.9	1968 - 1973				T 2926						
----------	-------------	--	--	--	--------	--	--	--	--	--	--

### KADETT

(Type A)	1963 - 1967				T 2926					T 2921	TG2921
(Type B)	1965 - 08.73										
1.0, 1.2, 1.6 (Type C)	09.73 - 1979		50		T 2903	TG2903		40		T 2922	TG2922
Aero (Type C)	09.73 - 1979										
City (Type C)	1975 - 1979		50		T 2903	TG2903		40		T 2921	TG2921
,  (Type D) excl. GTE	1979 - 08.84		140		C 2927	CG2927		25		T 2905	TG2905
,  1.8 GTE (Type D)	1982 - 1985		140			CG2927		25			TG2905
(Type E) Ch. → J2791967 excl. GSi	08.84 - 07.88		140		C 2927	CG2927		25		T 2905	TG2905
(Type E) Ch. → J5273427 excl. GSi	08.84 - 07.88										
(Type E) Ch. → J2791967 excl. GSi	08.84 - 07.88										
(Type E) Ch. → J5273427 excl. GSi	08.84 - 07.88										
(Type E) Ch. J2791968 → excl. GSi	08.88 - 07.91		140		C 2927	CG2927		25		T 2908	TG2908
(Type E) Ch. J5273428 → excl. GSi	08.88 - 07.91										
(Type E) Ch. J2791967 → excl. GSi	08.88 - 07.91										
(Type E) Ch. J5273428 → excl. GSi	08.88 - 07.91										
GSi (Type E) Ch. → J2791967	08.84 - 07.88		140			CG2927		25			TG2905
GSi (Type E) Ch. → J5273427	08.84 - 07.88										
GSi (Type E) Ch. → J2791967	08.84 - 07.88										
GSi (Type E) Ch. → J5273427	08.84 - 07.88										
GSi (Type E) Ch. J2791968 →	08.88 - 07.91		140			CG2927		25			TG2908
GSi (Type E) Ch. J5273428 →	08.88 - 07.91										
GSi (Type E) Ch. J2791968 →	08.88 - 07.91										
GSi (Type E) Ch. J5273428 →	08.88 - 07.91										
Caravan (Type C)	09.73 - 1979		50		T 2903	TG2903		40		T 2921	TG2921
Caravan (Type D)	1979 - 08.84		140		C 2927	CG2927		25		T 2928	
Caravan (Type E)	08.84 - 07.91		140		C 2927	CG2927		25		T 2909	TG2909





ANTERIORE  
FRONT



POSTERIORE  
REAR

				<b>OIL</b>	<b>GAS</b>				<b>OIL</b>	<b>GAS</b>
--	--	--	--	------------	------------	--	--	--	------------	------------

## OPEL

### KADETT

(Type C) excl. GT/E, Rallye	09.73 - 1979		50		T 2903	TG2903		40		T 2922	TG2922
GT/E (Type C)	1975 - 1979		50		T 2903	TG2903					
Rallye (Type C)	1977 - 1979										
(Type E) excl. GSi	1986 - 1993		140		C 2927	CG2927		25		T 2908	TG2908
COMBO (Type E)	1985 - 1993		140		C 2927	CG2927		25		T 2929	

### MANTA

(Type A)	1970 - 08.75		85					45		T 2922	TG2922
(Type B) excl. GT/E, GSi	09.75 - 1988		40		T 2903	TG2903		45		T 2902	TG2902
GT/E, GSi (Type B)	09.75 - 1988		40			TG2903		45			TG2902

### MONTEREY

	1992 - 03.95		30			HG1903		25			HG2930
2B	04.95 -		30			HG2949		25			HG2930
4B	04.95 -		30			HG2949		25			HG2950

### MONZA

2.0, 3.0	1978 - 1986		140		C 2923	CG2923		60			TG2931
----------	-------------	--	-----	--	--------	--------	--	----	--	--	--------

### MOVANO

,  28 Q.li	1997 -		80		H 3411			60		H 3412	
,  30 Q.li	1997 -										
,  35 Q.li	1997 -										
35 Q.li (HD, UD)	1997 -		80		H 3411			60		H 3413	
	1997 -		80		H 3411			60			

### OMEGA

1.8, 2.0 (Type A) excl.	1986 - 1994		215		M 2932	MG2932		40		T 2933	TG2933
2.4 (Type A) excl.	1986 - 1994										
2.3 D 2.3 TD (Type A) excl.	1986 - 1994										
2.6, 2.8 excl.  (Type A)	1987 - 1994		215			MG2934		40			TG2933
3.0 (Type A) excl.	1987 - 1994										
3.0 24V (Type A) excl. Lotus,	1987 - 1994										
2.0 (Type B) excl.	05.94 -		215			MG2940		40			TG2933
2.5 V6 (Type B) excl.	05.94 -		215			MG2941		40			TG2933
2.5 TD (Type B) excl.	05.94 -										
3.0 V6 24V (Type B) excl.	05.94 -										
Caravan (Type B) excl.	1986 - 1994		215		M 2932	MG2932		40		T 2935	TG2935
2.0 (Type B) excl.	05.94 -		215			MG2940		40			TG2935
2.5 V6 (Type B) excl.	05.94 -		215			MG2941		40			TG2935
2.5 TD (Type B) excl.	05.94 -										
3.0 V6 24V (Type B) excl.	05.94 -										



ANTERIORE  
FRONT



POSTERIORE  
REAR



OIL

GAS



OIL

GAS

## OPEL

### REKORD

(Type A)	1963 - 1972		35		T 2920			40		T 2921	TG2921
(Type B)	1963 - 1972										
(Type C)	1963 - 1972										
(Type D) excl. 2.1 D	1971 - 1976		35		T 2920			40		T 2922	TG2922
Sprint (Type D)	1971 - 1976										
2.1 D (Type D)	1972 - 1976		35		T 2920			40		T 2902	TG2902
(Type E) excl. Diesel	1977 - 10.82		130		C 2923	CG2923		40		T 2922	TG2922
Diesel (Type E)	1977 - 10.82		130		C 2923	CG2923		40		T 2902	TG2902
(Type E)	10.82 - 1986		130		C 2923	CG2923		40		T 2922	TG2922
Caravan (Type D)	1972 - 1976		35		T 2920			40		T 2936	TG2936
Caravan (Type E)	1977 - 1986		130		C 2923	CG2923		40		T 2936	TG2936

### SENATOR

	1978 - 1986		140		C 2923	CG2923		60			TG2931
excl. 3.0i 24V,	1987 - 04.94		215		M 2932	MG2932		40		T 2933	TG2933
3.0i 24V excl.	1987 - 04.94		215			MG2934		40			TG2933

### SINTRA

	1998 -		140			MG2958		60	excl.		HG2959
--	--------	--	-----	--	--	--------	--	----	-------	--	--------

### SPEEDSTER

	2001 -										
--	--------	--	--	--	--	--	--	--	--	--	--

### TIGRA

1.4 16V	1994 -		70			MG2943		30			TG2944
1.6 16V	1994 -										

### VECTRA

,  1.4, 1.6 (Type A)	09.88 - 1995		145		C 2912	CG2912		40	excl.	T 2908	TG2908
,  1.8, 2.0 (Type A) excl. 1.6V, 4x4	09.88 - 1995										
,  1.7 D, 1.7 TD (Type A)	09.88 - 1995										
,  2.0 16V (Ch. → NV199999)	09.88 - 1992		145			CG2912		40	excl.	T 2933	TG2933
,  2.0 16V (Ch. → N1999999)	09.88 - 1992										
,  2.0 16V (Ch. → N5999999)	09.88 - 1992										
(Type A) excl. 4x4											
,  2.0 16V (Ch. NV199999 →)	1993 - 1995		145			CG2912		40	excl.	T 2908	TG2908
,  2.0 16V (Ch. N1999999 →)	1993 - 1995										
,  2.0 16V (Ch. N5999999 →)	1993 - 1995										
(Type A) excl. 4x4											
,  1.8 4x4	09.88 - 1995		145			CG2912		40	excl.	T 2933	TG2933
,  2.0 4x4	09.88 - 1995										
,  2.0 16V 4x4 excl. Turbo	09.88 - 1995										
(Type A)											
,  2.5 24V (Type A)	1993 - 1995		145			CG2912		40			
,  1.6, 1.8 (Type B)	08.95 -		160		M 2945	MG2945		100		S 2946	SG2946
,  2.0 (Type B)	08.95 -				M 2948	MG2948					





ANTERIORE  
FRONT



POSTERIORE  
REAR

				OIL	GAS					OIL	GAS
--	--	--	--	-----	-----	--	--	--	--	-----	-----

## PEUGEOT

### 104 Anteriore

	L, GL (A01) Ch. → 5675804	1972 - 01.79		300		C 0911	CG0911					
	GL6, SL (A11) Ch. → 7182579	1972 - 01.79										
	ZS (C12) Ch. → 5684067	1972 - 02.78										
	ZA (S01) Ch. → 5684441	1977 - 02.78										
	ZL (C01) Ch. → 5684483	1972 - 02.78										
	GL6, SL (A11) Ch. 7182580 →	02.79 - 1985		240		C 3001	CG3001					
	GR (A11)	1979 - 1985		240		M 0914	MG0914					
	L, GL (A01) Ch. 5675805 →	02.79 - 1985										
	S (A31) Ch. → 5852871	02.79 - 1980										
	SR (A21)	02.79 - 1984										
	Sundgau	1978 - 1980										
	Style Z	1983 - 1986										
	Z (S11)	1981 - 1986										
	ZA (S01) Ch. 5684442 →	04.78 - 1986										
	ZL (C01) Ch. 5684484 →	04.78 - 1986										
	ZR	1978 - 1984										
	ZS (C12) Ch. 5684068 →	04.78 - 1986										
	S (A31) Ch. 5852872 →	1980 - 1985		240		M 0914	MG0914					
	GLS	1985 - 1987										

### 104 Posteriore

	L, GL (A01) Ch. → 5132734	1972 - 1974										
	L, GL (A01) Ch. 5132735 → 5534418	1974 - 08.76							180	<b>32</b>	S 3002	
	GL6, SL (A11) Ch. → 7070747	1974 - 08.76										
	L, GL (A01) Ch. 5534419 →	09.76 - 1985							180	<b>32</b>	S 0915	
	GL6, SL (A11) Ch. 7070748 →	09.76 - 1985										
	GR (A11)	03.79 - 1985										
	SR (A21)	03.79 - 1984										
	S (A31)	02.79 - 1985										
	Sundgau	1978 - 1980										
	ZL (C01, C11) Ch. → 5534418	1974 - 1977										
	ZS (C12, C31) Ch. → 5534418	1974 - 1977										
	ZL (C01, C11) Ch. 5534419 →	1977 - 1986							180	<b>32</b>	S 0913	
	ZS (C12, C31) Ch. 5534419 →	1977 - 1986										
	ZA (S01, S11)	1977 - 1986										
	ZR	1978 - 1984										
	Style Z	1983 - 1986										
	Z (S11)	1981 - 1986										
	GLS	1985 - 1987										

**32** Vedi disegno Peugeot 104 a pagina 78 - See drawing Peugeot 104 on page 78



ANTERIORE  
FRONT



POSTERIORE  
REAR

OIL  
 GAS  
 NOTE  
 OIL  
 GAS  
 NOTE

## PEUGEOT

32

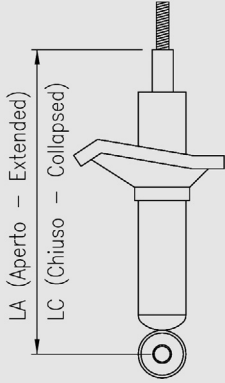

**S 3002**

La = 596 mm.  
Lc = 370 mm.

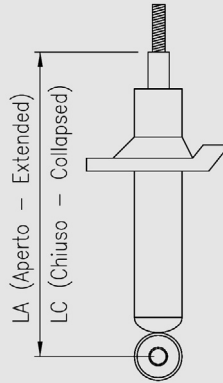

**S 0913**

La = 585 mm.  
Lc = 401 mm.

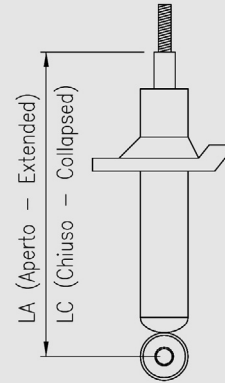

**S 0915**

La = 645 mm.  
Lc = 401 mm.

## 106

	1.0, 1.1	1991 - 1996		80	N.D.	C 0906	CG0906		40	N.D.	T 0908	TG0908
	1.4, 1.4i	1991 - 1996			H.D.	C 0907	CG0907			H.D.		TG0921
	1.4 D, 1.5 D	1991 - 1996			ACC52							
	1.3 Rallye	1991 - 1996		80	ACC52	C 0907	CG0907		40			TG0921
	1.4 XSi	1991 - 1996										
	1.6i, 1.6 XSi	1991 - 1996										
	1.0, 1.1	1996 -		80	N.D.	C 0906	CG0906		40	N.D.	T 0908	TG0908
	1.4i, 1.6i	1996 -			H.D.	C 0907	CG0907			H.D.		TG0921
	1.5 D	1996 -			ACC52							
	1.6 Rallye	1996 -		80	ACC52	C 0907	CG0907		40			TG0921
	1.6 S16, 1.6 GTi	1996 -										
	Entreprise	1991 -		80	ACC52	C 0907	CG0907		40			TG0921

## 204

		1965 - 01.70									S 3004	
		1965 - 01.70									S 3004	
		02.70 - 06.72				C 3005					S 3004	
		07.72 - 1976				C 3005					S 3006	

## 205

	1.0, 1.1, 1.3	1983 - 1998		135	ACC56	M 0918	MG0918		50		T 0929	TG3020
	1.4, 1.6	1983 - 1998										
	1.8 D, 1.9 D	1983 - 1998										
	1.6 GTi	1984 - 1998		135		M 3011	MG3011		50		T 3008	TG3008
	1.9 GTi	1985 - 1998				M 3010	MG3010					
	1.6 Rallye	1988 - 1998			ACC55							
	1.8 Turbo Diesel	1990 - 1998		180		M 3013	MG3013		50		T 0929	TG3020
	Gentry	1991 - 1998				M 3012	MG3012					
	1.0 CT, 1.1 CT	1988 - 1998		180	ACC55	M 3009	MG3009		50		T 0929	TG3020
	1.4 CT, 1.6 CT	1983 - 1998										
	1.6 CTi, 1.9 CTi	1985 - 1998										
	Entreprise	1994 - 1998		180	ACC55	M 3009	MG3009		50		T 3044	



ANTERIORE  
FRONT

POSTERIORE  
REAR



				<b>OIL</b>	<b>GAS</b>					<b>OIL</b>	<b>GAS</b>
--	--	--	--	------------	------------	--	--	--	--	------------	------------

## PEUGEOT

### 206

1.1	1998 -		150		M 3054	MG3054		50		T 3056	TG3056
1.4, 1.6	1998 -		150		M 3067	MG3067		50		T 3057	TG3057
1.9 D	1998 -				M 3066	MG3066					
2.0 Hdi	1999 -		150		M 3059	MG3059		50	N.D.	T 3057	TG3057
					M 3058	MG3058			H.D.		TG3060
2.0 S16	1999 -		150			MG3061		50			TG3060
2.0 GTI	1999 -					MG3062					
CC 1.6 16V	2000 -		150			MG3061		50			TG3060
CC 2.0 S16	2000 -					MG3062					
Entreprise	1998 -		150		M 3067	MG3067					
					M 3066	MG3066					

### 304

,	1968 - 02.70							150		S 3004	
	1968 - 02.70										
,	03.70 - 06.72		330		C 3005			150		S 3004	
,  (Ch. → 4031500)	07.72 - 08.77		330		C 3005			150		S 3006	
,  (Ch. 4031501 →)	08.77 - 1978		330		C 3014	CG3014		150		S 3006	
S (Ch. → 329800)	03.70 - 02.73		330		C 3005			150		S 3004	
S (Ch. 329801 →)	03.73 - 1976		330		C 3005			150		S 3006	
	03.70 - 06.72		330		C 3005						
S	07.72 - 1974		330		C 3005			150		S 3006	

### 305

GL, GR, SR, GLS	1977 - 1982		480		C 3014	CG3014		150		S 3015	
GLD, GRD	1979 - 1982										
S, SRD	1981 - 1982										
Ch. → 8870212											
GL, GR, SR, GLS	1982 - 06.82		480		C 3014	CG3014		150		S 3016	
GLD, GRD, SRD	1982 - 06.82										
Ch. 8870213 → 8987000											
1.1 GL, 1.3 GL, 1.5 GL	07.82 - 1988		240		M 3017	MG3017		150		S 3016	
1.1 GR, 1.3 GR	07.82 - 1988										
1.5 GLS	07.82 - 1988										
1.5 SR	07.82 - 1986										
GLD, GRD, SRD	07.82 - 1988										
Ch. 8987001 →											
1.6 GL (Ch. 9370001 →)	1985 - 1988		240		M 3017	MG3017		150		S 3018	
1.6 GLS (Ch. 9370001 →)	1985 - 1988										
1.6 GR (Ch. 9524001 →)	1985 - 1988										
1.6 SR (Ch. 9524001 →)	1985 - 1988										
1.6 GT	1983 - 1987		240		M 3017	MG3017		150		S 3018	
1.9 GT	1986 - 1987										
1.9 GTX	1985 - 1987										
(Ch. → 8987000)	1978 - 06.82		480		C 3014	CG3014		180		S 0919	
(Ch. → 8987000)	1978 - 06.82										



ANTERIORE  
FRONT



POSTERIORE  
REAR



## PEUGEOT

### 305

(Ch. 8987001 →)	07.82 - 1988		240		M 3017	MG3017		180		S 0919	
(Ch. 8987001 →)	07.82 - 1988										

### 306

,  1.1	01.93 -		220		M 0953 M 0952	MG0953 MG0952		55		T 0929	TG3020
1.4 4B	1994 -		220		M 0949 M 0948	MG0949 MG0948		55		T 0929	TG3020
1.4 3B-5B excl.  175/70x13" excl.  175/65x14"	01.93 -		220		M 0953 M 0952	MG0953 MG0952		55	N.D. H.D.	T 0929	TG3020 TG0942
1.4 3B-5B 175/70x13" 175/65x14"	01.93 -		220		M 0949 M 0948	MG0949 MG0948		55	N.D. H.D.	T 0929	TG3020 TG0942
,  1.6 ,  1.8, 1.8 D ,  1.9 D, 1.9 TD ,  2.0 Hdi	01.93 - 01.93 - 01.93 - 1999 -		220		M 0949 M 0948	MG0949 MG0948		55	N.D. H.D.	T 0929	TG3020 TG0942
,  2.0i, 2.0 XSi ,  2.0 S16	01.93 - 01.93 -		220			MG0951 MG0950		55			TG0942
	1997 -		220		M 0949 M 0948	MG0949 MG0948		55		T 3048	TG0942
excl. H.D.	1994 -		220			MG0949 MG0948		55			TG3020
H.D.	1994 -		220			MG0951 MG0950		55			TG0942
Entrepise	1993 -		220		M 0949 M 0948	MG0949 MG0948		55		T 0929	TG3020

### 307

1.4 (TU)	07.01 -		180			MG3069		80			TG3068
1.6 16V (TU)	05.01 -					MG3070					
2.0 16V (EW)	05.01 -		180			MG3071 MG3072		80			TG3068
1.4 HDi (DW4, DW8)	09.01 -		180			MG3071		80			TG3073
2.0 HDi (DW4, DW8)	05.01 -					MG3072					
2.0 HDi FAP (DW4, DW8)	09.01 -										



ANTERIORE  
FRONT



POSTERIORE  
REAR



OIL

GAS



OIL

GAS

## PEUGEOT

### 309

1.1, 1.3, 1.4 (TU)	1985 -		135		M 3009	MG3009		40	N.D.	T 0929	TG3020
1.6 (XU5) excl. GT	1985 - 10.89								H.D.		TG0942
1.9 (XU9) excl. GTI	1985 - 07.88										
1.8 D, 1.9 D	1985 -										
1.6 (XU5) excl. GT	10.89 -		180		M 3013	MG3013		40	N.D.	T 0929	TG3020
1.8 TD (XUD7T)	1989 -				M 3012	MG3012			H.D.		TG0942
1.9 (XU9) excl. GTI	07.88 -										
1.6 GT (XU5JA)	08.88 -		135		M 3011	MG3011		40		T 3008	TG3008
1.9 GTI (XU9J)	1986 -				M 3010	MG3010					
1.9 GTI 16V (XU9J4)	1989 -										

### 403

	1959 - 1966									T 3021	
--	-------------	--	--	--	--	--	--	--	--	--------	--

### 404

,  ,	1960 - 08.64									T 3021	
,  ,	09.64 - 1975				C 3025					T 3021	
	1964 - 08.64									T 3022	
	09.64 - 1976				C 3025					T 3022	
U8	09.64 - 1976				C 3025				N.D.	T 3023	
U10	09.64 - 1976								H.D.	H 3023	

### 405

1.4, 1.6, 1.8 (GL)	1987 - 1995		180		M 3026	MG3026		40		T 3027	TG3027
1.4, 1.6, 1.8 (GR)	1987 - 1995										
1.4, 1.6, 1.8 (SR)	1987 - 1995										
1.9 D excl. Turbo	1988 - 1995										
1.9, 2.0	1987 - 1995										
1.8 TD, 1.9 TD	1987 - 1995		180		M 3028	MG3028		40		T 3027	TG3027
GRi	1987 - 1995		180			MG3028		40	N.D.	T 3027	TG3027
STi, SRi	1987 - 1995								H.D.		TG3029
Mi16S	1987 - 1995		180			MG3028		40			TG3029
GRX4 (4x4)	1989 - 1995		180		M 3026	MG3026					
SRX4 (4x4)	1989 - 1995										
Mi16X4 (4x4)	1989 - 1995		180			MG3028					
Turbo16S	1989 - 1995										
1.4 excl. 4x4	1987 -		180		M 3026	MG3026		40		T 3027	TG3027
1.6 excl. 4x4	1987 -										
1.8 excl. 4x4	1987 -										
1.8 D, 1.9 D excl. Turbo, 4x4	1987 -										
GRi, SRi, STi excl. 4x4	1987 -		180		M 3028	MG3028		40		T 3027	TG3027
1.8 TD, 1.9 TD excl. 4x4	1987 -										
4x4	1988 -		180		M 3028	MG3028					
Enterprise	1988 -		180			MG3028		40			TG3029





ANTERIORE  
FRONT

POSTERIORE  
REAR



				<b>OIL</b>	<b>GAS</b>				<b>OIL</b>	<b>GAS</b>
--	--	--	--	------------	------------	--	--	--	------------	------------

## PEUGEOT

### 406

1.6i, 1.8	1996 -		100		M 3049	MG3049		60		T 3047	TG3047
1.9 D, 1.9 TD	1996 -				M 3046	MG3046					
2.0i, 2.0 HDi	1996 -										
2.0i Turbo	1996 -		100			MG3049		60			TG3047
2.1TD, 2.2 HDi	1996 -					MG3046					
3.0 V6 excl.	1996 -		100			MG3051		60			TG3047
						MG3050					
1.6i, 1.8	1996 -		100		M 3049	MG3049				T 3052	TG3052
1.9 D, 1.9 TD	1996 -				M 3046	MG3046					
2.0i, 2.0 HDi	1996 -										
2.0i Turbo	1996 -		100			MG3049					TG3052
2.1TD, 2.2 HDi	1996 -					MG3046					
3.0 V6 excl.	1996 -		100			MG3051				T 3052	TG3052
						MG3050					
2.0 excl.	1996 -		100			MG3051					TG3053
3.0 V6 excl.	1996 -					MG3050					

### 504

L, LD (Ch. → 2181356)	1973 - 1976				C 3031					T 3021	
GL, TI, GLD (Ch. → 2181356)	1968 - 1976				C 3031					H 3033	HG3033
L, LD (Ch. 2181357 →)	1976 - 1980				C 3032	CG3032				T 3021	
GR, GRD	1980 - 1984										
SR, SRD	1980 - 1984										
GL, TI, GLD (Ch. 2181357 →)	1976 - 1983				C 3032	CG3032				H 3033	HG3033
L, GL (Ch. → 2181356)	1972 - 1976				C 3031			60		T 3022	
LD, GLD (Ch. → 2181356)	1972 - 1976										
GL, GLD (Ch. 2181357 →)	1976 - 1980				C 3032	CG3032		60		T 3022	
L, LD (Ch. 2181357 →)	1976 - 1984										
GR, GRD (Ch. 2181357 →)	1976 - 1984										
(Ch. → 2085065)	1968 - 1976				C 3031					H 3033	HG3033
(Ch. → 2085065)	1968 - 1976										
(Ch. 2085066 →)	1976 - 1983				C 3032	CG3032				H 3033	HG3033
(Ch. 2085066 →)	1976 - 1983										
U01 (Ch. → 3610000)	- 07.81							60	N.D.	T 3023	
U20 (Ch. → 3610000)	- 07.81								H.D.	H 3023	
U01 (Ch. 3610001 → 3972015)	08.81 - 05.85		360		C 3032			60	N.D.	T 3023	
U20 (Ch. 3610001 → 3972015)	08.81 - 05.85								H.D.	H 3023	
U01 (Ch. 3972016 →)	06.85 -		360		C 3035			60	N.D.	T 3023	
U20 (Ch. 3972016 →)	06.85 -								H.D.	H 3023	



ANTERIORE  
FRONT



POSTERIORE  
REAR



OIL

GAS



OIL

GAS

## PEUGEOT

### 505

(Ch. → 1845000) excl. Turbo Inj.	1979 - 1985		280		C 3032	CG3032		50		H 3033	HG3033
Turbo Injection (Ch. → 1887751)	1983 - 1986										
(Ch. 1845001 →) excl. V6, Turbo Inj.	1986 - 1989		360	ACC86	C 3036	CG3036		50		H 3033	HG3033
Turbo Inj. (Ch. 1887752 →) excl. ABS	1987 - 1989										
Turbo Inj. ABS (Ch. 1965001 →)	1987 - 1989		360			CG3045		50		H 3033	HG3033
2.8 V6	1987 - 1989										
(Ch. → 1845000)	1982 - 1985		280		C 3032	CG3032		50		H 3037	HG3037
(Ch. 1845001 →)	1986 -		360	ACC86	C 3036	CG3036		50		H 3037	HG3037

### 604

2.0 SR	1981 - 1986		360		C 3032	CG3032		90	excl.	H 3033	HG3033
2.3 TD, 2.5 TD	1980 - 1986										
2.7 SL, 2.7 TI	1974 - 1983										
2.7 GTI, 2.8 GTI	1974 - 1986										
2.7 STI, 2.8 STI	1974 - 1986										
GRD, SRD	1974 - 1986										

### 605

excl.	10.89 - 1999		200		M 3039	MG3039		80		T 3040	TG3040
					M 3038	MG3038					

### 607

2.2 excl.	1999 -					MG3065					TG3063
2.2 HDi excl.	1999 -					MG3064					

### 806

(Ch. → 7609)	03.94 - 12.97		90		M 1366	MG1366		45		T 1367	TG1367
(Ch. 7610 →)	01.98 -		90		M 1366	MG1366		45		T 0944	TG0944

### BOXER

1000 Kg, 1400 Kg	1994 -		170		M 1355			45			HG1356
1800 Kg	1994 -		170		M 1385			45			HG1383
	1994 -		170		M 1355			45			

### EXPERT

(Ch. → 7609)	1995 - 12.97		90		M 0943			45		T 1367	TG1367
(Ch. 7610 →)	01.98 -		90		M 0943			45		T 0944	TG0944

### J5

(Ch. → 0244300) excl.	1981 - 1985		150		M 0932			50	<b>21</b>	H 0934	
(Ch. 0244301 →) excl.	1985 - 1994		200		M 0933			50	<b>21</b>	H 0934	
excl. 1800 Kg	1981 - 1984		150		M 0932			50	<b>21</b>	H 0934	
excl. 1800 Kg	1985 - 1987		200		M 0933			50	<b>21</b>	H 0934	
excl. 1800 Kg	1987 - 1994		200		M 0933			50	<b>21</b>	H 0935	

**21** Vedi disegno Fiat Ducato a pagina 23 - See drawing Fiat Ducato on page 23



ANTERIORE  
FRONT



POSTERIORE  
REAR



## PEUGEOT

### J7

	1966 - 1980				H 3043				H 3042	
--	-------------	--	--	--	--------	--	--	--	--------	--

### J9

	1979 - 1994				H 3043				H 3042	
--	-------------	--	--	--	--------	--	--	--	--------	--

### P4

					HG2512				HG2513	
--	--	--	--	--	--------	--	--	--	--------	--

## PARTNER / RANCH

excl. 4x4	1996 -		170		M 0949 M 0948	MG0949 MG0948		55	T 3027	TG3027
-----------	--------	--	-----	--	------------------	------------------	--	----	--------	--------

## PIAGGIO

### PORTER

	1992 - 05.98				M 5603 M 5604				T 5605	
excl. 16V	05.98 -				M 5603 M 5604				T 5605	
16V	05.98 -				M 5603 M 5604					
	1992 - 05.98				M 5601 M 5602				T 5605	
excl. 16V	05.98 -				M 5601 M 5602				T 5605	
16V	05.98 -				M 5601 M 5602					

## POLSKI

### 100

101 P Zastava					M 1311				M 1312	
---------------	--	--	--	--	--------	--	--	--	--------	--

### 125

,	1968 - 1978				T 1304					
---	-------------	--	--	--	--------	--	--	--	--	--

### 126

			45		T 1306			45	T 1307	
--	--	--	----	--	--------	--	--	----	--------	--

### 127

			75		M 1308	MG1308		70	M 0504	MG0504
--	--	--	----	--	--------	--------	--	----	--------	--------

### 132

			40		T 1304			70	T 1320	





ANTERIORE  
FRONT

POSTERIORE  
REAR



				<b>OIL</b>	<b>GAS</b>				<b>OIL</b>	<b>GAS</b>
--	--	--	--	------------	------------	--	--	--	------------	------------

## RENAULT

### CLIO

1.1 RL (B571, C571, S571)	1989 - 12.93		145	ACC54	M 3348	MG3348		60		T 3350	TG3350
1.1 RN (B571, C571, S571)	1989 - 12.93			41							
1.1 RC (C571, S571)	01.94 - 05.97			44							
1.2 (B572, C572, S572)	1989 - 05.97		145	ACC54	M 3348	MG3348		60		T 3350	TG3350
1.2 (357F, 557F) excl. Autom.	10.92 - 12.93			41							
1.2 (B57A, B57R) excl. Autom.	10.92 - 12.93			44							
1.2 (C57A, C57R) excl. Autom.	10.92 - 12.93										
1.2 (S57A, S57R) excl. Autom.	10.92 - 12.93										
1.2 (357F, 357L)	01.94 - 05.97										
1.2 (357G, 357J) excl. ABS	01.94 - 05.97										
1.2 (357K, 357Y) excl. ABS	01.94 - 05.97										
1.2 (B57A, C57A, S57A)	01.94 - 05.97										
1.2 (B57R, C57R, S57R)	01.94 - 05.97										
1.2 (B57S, C57S, S57S)	01.94 - 05.97										
1.2 (C572, S572)	01.94 - 05.97										
1.2 (C577, S577)	01.94 - 05.97										
1.2 (B57A, B57R)	1989 - 09.92		145	ACC54	M 3349	MG3349		60		T 3350	TG3350
1.2 (B57L, C57L, S57L)	1989 - 12.93			42							
1.2 (C57A, C57R)	1989 - 09.92			44							
1.2 (S57A, S57R)	1989 - 09.92										
1.2 Automatic	10.92 - 12.93										
1.2 (357G, 357J) ABS	01.94 - 05.97										
1.2 (357K, 357Y) ABS	01.94 - 05.97										
1.2 (B57L)	01.94 - 05.97										
1.4 Baccara (B573, B57T)	10.92 - 12.93		145	ACC54	M 3348	MG3348		60		T 3350	TG3350
1.4 Baccara (B57B, C57B)	10.92 - 12.93			41							
1.4 Baccara (C573, C57T)	10.92 - 12.93			44							
1.4 RL, 1.4 RN, 1.4 RT (B57B, C57B)	10.92 - 12.93										
1.4 RL, 1.4 RN, 1.4 RT (B573, B57T)	10.92 - 12.93										
1.4 RT (C573, C57T)	10.92 - 12.93										
excl. Autom.											
1.4 (C573) excl. Autom.	01.94 - 05.97		145	ACC54	M 3348	MG3348		60		T 3350	TG3350
1.4 Be Pop (B577, C577, S577)	01.94 - 05.97			41							
1.4 Be Pop (B57T, C57T) excl. Autom.	01.94 - 05.97			44							
1.4 Be Pop (B57Y, C57Y)	01.94 - 05.97										
1.4 RL (B577, C577, S577)	01.94 - 05.97										
1.4 RL (B57Y, C57Y)	01.94 - 05.97										
1.4 RL (C57B) excl. Autom.	01.94 - 05.97										
1.4 RN (B57T, C57T) excl. Autom.	01.94 - 05.97										
1.4 RN (B57Y, C57Y)	01.94 - 05.97										
1.4 RN (C57B) excl. Autom.	01.94 - 05.97										
1.4 RT (B577, C577, S577)	01.94 - 05.97										
1.4 RT (B57T, C57T) excl. Autom.	01.94 - 05.97										
1.4 RT (B57Y, C57Y)	01.94 - 05.97										
1.4 RT (C57B) excl. Autom.	01.94 - 05.97										

**41** - **42** - **44** Vedi disegni Renault Clio a pagina 87 - See drawings Renault Clio on page 87

--	--	--	--	--	--	--	--	--	--	--	--



ANTERIORE  
FRONT



POSTERIORE  
REAR

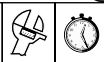

OIL

GAS

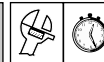

OIL

GAS

## RENAULT

### CLIO

1.4 Automatic (B57B, C57B)	1989 - 09.92		145		M 3349	MG3349		60		T 3350	TG3350
1.4 Automatic (B573, B57T)	1989 - 09.92			<b>42</b>							
1.4 Automatic (C573, C57T)	1989 - 09.92			<b>44</b>							
1.4 Automatic	10.92 - 12.93										
1.4 S (B57B, C57B)	1989 - 12.93										
1.4 S (C57T, C573)	1989 - 12.93										
1.4 RTi (C57B, C57T)	1989 - 12.93										
1.4 RL, 1.4 RN, 1.4 RT (B57B, 557B)	01.94 - 05.97										
1.4 S (C57B)	01.94 - 05.97										
1.4 RTi (C57B)	01.94 - 05.97										
1.4 Automatic (C573, C57B, C57T)	01.94 - 05.97										
1.7 (B574, C574)	1989 - 12.93		145		M 3349	MG3349		60		T 3350	TG3350
1.7 (B57L, C57L, S57L)	1989 - 12.93			<b>42</b>							
1.8 Baccara (B57C, C57C)	1989 - 12.93			<b>44</b>							
1.8 RT (B57C, C57C)	1989 - 12.93										
1.8 (557A, 557D)	01.94 - 05.97										
1.8 (B578, C578)	01.94 - 05.97										
1.8 RT (B57C)	01.94 - 05.97										
1.8 RSi (C579, C57E, C57H)	1992 - 05.97		145		<i>M 3379</i>						<i>TG3381</i>
1.8 16V (C575, C57D)	1989 - 05.97		145			MG3351					TG3415
1.8 S16 (C575, C57D)	1989 - 05.97										
1.9 D 3 $\Delta$ (C57I, S57I)	01.94 - 05.97		145		M 3348	MG3348		60		T 3350	TG3350
				<b>41 - 44</b>							
1.9 D (B571, C571, S571)	1989 - 12.93		145		M 3349	MG3349		60		T 3350	TG3350
1.9 D (B576, S576)	1989 - 12.93			<b>42</b>							
1.9 D (B57U, C57U)	1989 - 12.93			<b>44</b>							
1.9 D 5 $\Delta$ (B57I)	01.94 - 05.97										
1.9 D (C576, S576)	01.94 - 05.97										
2.0 16V Williams (C57M)	1993 - 05.97		145		<i>M 3380</i>						<i>TG3382</i>
	05.97 - 03.98		145	<b>43</b>	M 3406	MG3406		60		T 3350	TG3350

**41**

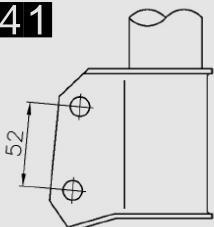

**M 3348**  
**MG3348**

O.E:  
7700 808 490  
7700 816 045  
7700 828 680  
7700 838 084

**42**

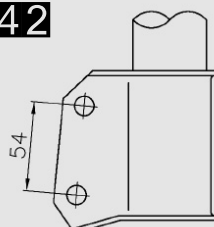

**M 3349**  
**MG3349**

O.E:  
7700 808 491 - 7700 823 131  
7700 808 492 - 7700 828 681  
7700 816 046 - 7700 828 682  
7700 823 129 - 7700 838 083  
7700 838 087

**43**

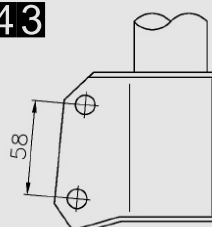

**M 3406**  
**MG3406**

O.E:  
7700 423 726  
7700 423 727  
7700 423 729

OLD  
VECCHIO

NEW  
NUOVO

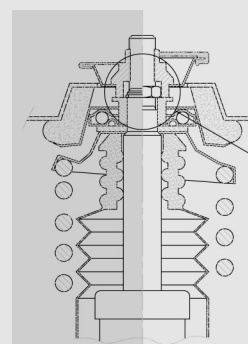

**44**

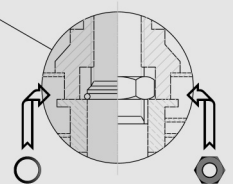



ANTERIORE  
FRONT



POSTERIORE  
REAR



## RENAULT

### CLIO II

1.2 8V	03.98 -		150	ACC54	M 3407	MG3407		80		T 3409	TG3409
1.2 16V	06.01 -		150	ACC54	M 3408	MG3408		80		T 3409	TG3409
1.4 8V	03.98 - 06.01										
1.4 16V (E2, E3, E5)	03.98 -										
1.5 DCi (E1, E2, E3)	06.01 -										
1.6 8V (E2, E3, E5)	03.98 - 06.01										
1.6 16V (E3, E5)	03.98 -										
1.9 dTi (E1, E2, E3)	03.98 - 06.01										
1.4 16V (ES, ES2)	03.98 -		150	ACC54		MG3416		80			TG3417
1.5 DCi (ES)	06.01 -										
1.6 8V (ES2)	03.98 - 06.01										
1.6 16V (ES3)	03.98 -										
1.9 dTi (ES2)	03.98 - 06.01										
2.0 RS	1998 -					MG3434					TG3436
3.0 V6 RS	06.01 -					MG3435					TG3437

### ESPACE

2.0 (J112) Ch. → T005812	1984 - 12.84							60			TG3357
2.0 (J112) Ch. T005813 → T036434	01.85 - 12.87		150		S 3353			60			TG3357
2.0 (S112) Ch. → T000620	01.85 - 12.87										
2.0 D (S112) Ch. → T000620	01.85 - 12.87										
2.1 TD (J115) Ch. → T020896	01.85 - 12.87										
2.1 TD (S115) Ch. → T000841	01.85 - 12.87										
2.2 (J117) Ch. → T003258	01.85 - 12.87										
2.0 (J112) Ch. K000001 → excl. ☐	01.88 - 1991		150		S 3354	SG3354		60			TG3355
2.0 (J112) Ch. T036435 → excl. ☐	01.88 - 1991										
2.0 (J116) Ch. K000001 → excl. ☐	01.88 - 1991										
2.0 (J116) Ch. T000001 → excl. ☐	01.88 - 1991										
2.0 (S112) Ch. T000621 → excl. ☐	01.88 - 1991										
2.0 D (S112) Ch. T000621 → excl. ☐	01.88 - 1991										
2.1 TD (J115) Ch. T020897 → excl. ☐	01.88 - 1991										
2.1 TD (S115) Ch. T000842 → excl. ☐	01.88 - 1991										
2.2 (J117) Ch. T003259 → excl. ☐	01.88 - 1991										
2.0, 2.1TD (J63)	1991 - 1996		150		S 3354	SG3354		60			TG3357
2.1D (S635)	1991 - 1996										
2.2 (J637, S637)	1991 - 1996										
excl. V6, 4x4, ☐											
2.9 V6 (J638) excl. 4x4, ☐	1991 - 1996		150			SG3391		60			TG3355
3.0 V6 (J638) excl. 4x4, ☐	1991 - 1996										
2.0 (JEOA)	11.96 -				M 3421	MG3421			excl.		TG3401
2.2dT (JEOD)	11.96 -				M 3420	MG3420					
3.0 V6 (JEOE)	11.96 -										



ANTERIORE  
FRONT



POSTERIORE  
REAR



OIL

GAS



OIL

GAS

## RENAULT

### EXPRESS / RAPID / EXTRA / COMBI

excl. CU+ (775 Kg)	1985 - 09.96		195		M 3315			60			TG3316
CU+ (775 Kg)	1991 - 09.96		195		M 3315			60			TG3393
excl. CU+ (775 Kg)	10.96 -		195		M 3410			60			TG3316
CU+ (775 Kg)	10.96 -		195		M 3410			60			TG3393

### FUEGO

	1980 - 1985		115		S 3329			95		T 3328	TG3328
--	-------------	--	-----	--	--------	--	--	----	--	--------	--------

### KANGOO

excl. Pampa	1997 -		150		M 3402			60		T 3403	
Pampa	1997 -		150		M 3402			60			
(600Kg) excl. CU+	1997 -		150		M 3402			60		T 3403	
CU+ (800 Kg)	1997 -		150		M 3402			60			

### LAGUNA

1.8 (B56A, B56B)	12.93 - 02.95		130	<b>46</b>	M 3392	MG3392		45		T 3384	TG3384
1.8 (B56S, B56Z)	12.93 - 02.95										
1.9 dTi	1998 - 12.00										
2.0 (B56C, B56H)	12.93 - 02.95										
2.2D (B56F, B562)	12.93 - 12.00										
2.2TD (B56F, B562)	12.93 - 12.00										
3.0 V6 (B56E, B56R)	12.93 - 12.00										
1.8 (B56A, B56B)	02.95 - 12.00		130	<b>45</b>	M 3383	MG3383		45		T 3384	TG3384
1.8 (B56S, B56Z)	02.95 - 12.00										
1.8 (B56T, B560) excl. ABS	02.95 - 12.00										
2.0 (B56L) excl. ABS, Autom.	02.95 - 12.00										
2.0 (B56C, B56H) excl. ABS	02.95 - 12.00										
1.8 ABS (B56T, B560)	02.95 - 12.00		130	<b>46</b>	M 3392	MG3392		45		T 3384	TG3384
2.0 ABS (B56L)	02.95 - 12.00										
2.0 Autom. (B56L)	02.95 - 12.00										
2.0 (B56D, B56M)	02.95 - 12.00										
2.0 ABS (B56C, B56H)	02.95 - 12.00										
Nevada excl. V6.	1995 - 12.00			<b>46</b>	M 3392	MG3392			excl.	T 3404	TG3404
Nevada 3.0 V6 excl.	1995 - 12.00			<b>46</b>	M 3392	MG3392			excl.		

**46**

M 3392  
MG3392

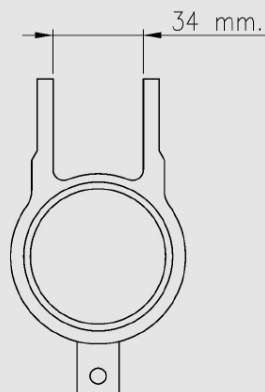

24 mm.

**45**

M 3383  
MG3383







ANTERIORE  
FRONT

POSTERIORE  
REAR



## RENAULT

### LAGUNA II

excl.	2001 -					MG3433			excl.		TG3428
excl.	2001 -					MG3433			excl.		TG3429

### MASTER II

28 Q.li (FD, JD)	1997 -		80		H 3411			60		H 3412	
30 Q.li (ED, FD, JD)	1997 -										
35 Q.li (ED, FD, JD)	1997 -										
35 Q.li (HD, UD)	1997 -		80		H 3411			60		H 3413	

### MASTER Q-SERIES (RWD)

	05.80 - 1997				H 3366			75		H 3364	
	05.80 - 1997										

### MASTER R-SERIES (FWD)

(R2, R4)	05.80 - 1997		160		H 3366			75		H 3365	
(R3) excl. Minicar	05.80 - 02.89										
(RL7, RC7)	05.80 - 1997										
Minicar (R3)	05.80 - 02.89		160		H 3366			75			
	05.80 - 1997										
Ambulanza (RCA)	05.80 - 1997										
(RC9, RD9, RL9)	05.80 - 1997		160		H 3366			75		H 3364	
excl. Minicar	03.89 - 1997		160		H 3366			75		H 3365	
Minicar	03.89 - 1997		160		H 3366						

### MEGANE

1.4, 1.4 16V (BAO)	09.95 -		100		M 3394	MG3394		35		T 3395	TG3395
1.6, 1.6 16V (BAO)	09.95 -										
1.9 D, 1.9 dTi (BAO)	09.95 -										
1.9 D, 1.9 dTi (SAO)	09.95 -										
2.0 (BA) excl. 16V	09.95 -										
2.0i 16V	09.95 - 10.98		100			MG3397		35			TG3398
2.0i 16V	11.98 -		100					35			TG3398
1.4, 1.4 16V (KAO)	1997 - 06.99		100		M 3394	MG3394		35		T 3419	TG3419
1.6, 1.6 16V (KAO)	1998 - 06.99										
1.9 D, 1.9 dTi (KAO)	1998 - 06.99										
4x4 (VAO)	1997 - 06.99										
1.4, 1.4 16V (KAO)	06.99 -		100		M 3422	MG3422		35		T 3423	TG3423
1.6, 1.6 16V (KAO)	06.99 -										
1.9 D, 1.9 dTi (KAO)	06.99 -										
4x4 (VAO)	06.99 -										
1.4 16V (EAO)	1996 -		100		M 3394	MG3394		35			TG3398
1.6, 1.6 16V (EAO)	1996 -										
2.0 (EA) excl. 16V	1996 -										
2.0 16V (EAO)	1996 - 10.98		100			MG3397		35			TG3424
2.0 16V (EAO)	10.98 -		100			MG3425		35			TG3424



ANTERIORE  
FRONT



POSTERIORE  
REAR



OIL

GAS



OIL

GAS

## RENAULT

### MEGANE CLASSIC

1.4, 1.4 16V (LAO) excl. ⚡	09.96 -		100		M 3394	MG3394		35		T 3395	TG3395
1.6, 1.6 16V (LAO) excl. ⚡	09.96 -										
1.9 D, 1.9 TD (LAO) excl. ⚡	09.96 -										
1.9 dTi (LAO) excl. ⚡	09.96 -										
2.0 (LAO)	09.96 -										

### MEGANE COACH

1.4 16V (DAO)	09.95 -		100		M 3394	MG3394		35		T 3395	TG3395
1.6, 1.6 16V (DAO)	09.95 -										
1.9 dTi (DAO)	1997 -										
2.0 (DA) excl. 16V	09.95 -										
2.0 16V (DAO)	09.95 -		100			MG3397		35			TG3398

### MEGANE SCENIC

1.4, 1.4 16V (JAOE)	11.96 - 06.98		100		M 3394	MG3394		35		T 3396	TG3396
1.6, 1.6 16V (JAOL)	11.96 - 06.98										
1.6e (JAOF) excl. Autom.	11.96 - 06.98										
1.6e Autom. (JAOF)	11.96 - 06.98		100		M 3405	MG3405		35		T 3396	TG3396
1.9 TD (JAOK)	11.96 - 06.98										
1.9 dTi (JAON)	11.96 - 06.98										
2.0 (JAOG)	11.96 - 06.98										
1.4, 1.4 16V (JA)	07.98 -		100		M 3394	MG3394		35		T 3396	TG3396
1.6 (JAO)	07.98 -										
1.9 TD, 1.9 dTi (JA)	07.98 -										
2.0 (JAO)	07.98 -										
1.9 dCi RX4 (4X4)	2000 -				<i>M 3438</i>	<i>MG3438</i>				<i>S 3439</i>	<i>SG3439</i>
2.0 16V RX4 (4X4)	2000 -										

### R 4

(R1120, R1121)	1961 - 08.68				T 3301			85		T 3302	
(R1123, R1124)	1961 - 08.68										
(112C)	1987 - 1992		110		T 3303	TG3303		85		T 3302	
(R1120)	09.68 - 1992										
(R1123)	09.68 - 1992										
(R1126)	09.68 - 1992										
GLT (R1128)	1978 - 1992		110		T 3303	TG3303		85		T 3304	
Rodeo (112C)	1973 - 1992										
(R2102, R2104)	1961 - 08.68							75		T 3375	
(R2105, R2106)	1961 - 08.68										
(R2105 F4)	09.68 - 1986		105		T 3303	TG3303		75		T 3375	
(R2106 F4)	09.68 - 1986										
(R2108)	1970 - 1986										
(R2109 F4)	09.68 - 1986										
(R2391, R2392)	1970 - 1986										
(R2340 F6)	1975 - 1986										
(R2370, R2430 F6)	1975 - 1986										



ANTERIORE  
FRONT

POSTERIORE  
REAR



## RENAULT

### R 5 / SUPER 5

L, TL, GTL LS, TS, TX Société	02.72 - 09.84 1972 - 1984 1974 - 1984		110		T 3303	TG3303		60		T 3306	TG3306
Alpine (R1223) Alpine (R122 B)	03.76 - 09.84 03.76 - 09.84		110		T 3307			60		T 3308	
(B40) excl. GT Turbo, GTE (C40) excl. GT Turbo, GTE (S40) excl. GT Turbo, GTE	09.84 - 05.88 09.84 - 05.88 1986 - 05.88		195	<b>48</b>	M 3309	MG3309		60		T 3310	TG3310
(B40) excl. GT Turbo, GTE (C40) excl. GT Turbo, GTE (S40) excl. GT Turbo, GTE	06.88 - 1996 06.88 - 1996 06.88 - 1996		195	<b>48</b> <b>47</b>	M 3309 M 3311	MG3309		60		T 3310	TG3310
1.4 GT Turbo (C405)	09.84 - 07.85							60			TG3312
1.4 GT Turbo (C405)	08.85 - 05.87		195		M 3313			60			TG3312
1.4 GT Turbo (C405)	06.87 -		195		M 3314			60			TG3312
1.7 GTE (C409)	1987 -		195		M 3313			60			TG3312

**47**

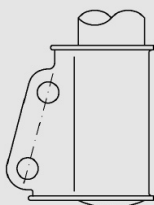

**M 3311**

O.E:  
7700 786 597  
7700 807 873  
7702 150 468

**48**

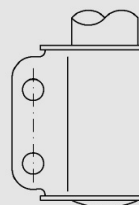

**M 3309  
MG3309**

O.E:  
7700 732 743  
7700 732 744  
7700 807 874  
7702 145 122  
7702 145 523

### R 6

800 cc. (R1180) 1100 cc. (R1181) Rodeo	1968 - 1981 1968 - 1981 1973 -		100		T 3303	TG3303		75		T 3304	
--	--------------------------------------	--	-----	--	--------	--------	--	----	--	--------	--

### R 9

1.1 (L421) 1.2 (L42S, L42J) 1.4 (L422, L423) 1.6 D, 1.6 TD (L424) 1.7 (L42F, L42L) Ch. → D00000525 1.7 (L426) Ch. → D00003950 1.7 (L426) Ch. → H00005600	1981 - 1990 1981 - 1990 1981 - 1990 1981 - 1990 1981 - 1986 1981 - 1986 1981 - 1986				M 3319	MG3319		60		T 3320	TG3320
1.7 (L42F, L42L) Ch. D00000526 → 1.7 (L42N) 1.7 (L426) Ch. D00003951 → 1.7 (L426) Ch. H00005601 → GTE, Turbo (L42E, L425)	1986 - 1990 1986 - 1990 1986 - 1990 1986 - 1990 1985 - 1990				M 3319	MG3319		60		T 3321	TG3321



ANTERIORE  
FRONT



POSTERIORE  
REAR

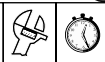

OIL

GAS

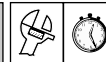

OIL

GAS

## RENAULT

### R 11

	1983 - 1990				M 3319	MG3319		60		T 3320	TG3320
	1984 - 1990				M 3319	MG3319		60		T 3320	TG3320
	1986 - 1990				M 3319	MG3319		60		T 3321	TG3321

### R 12

1.3 (1170)	1969 - 04.70							100		T 3323	
1.3, 1.4 (R1170, R1177, R1337)	05.70 - 1979		100		S 3322			100		T 3323	
1.3 (R1177, R1191, R1330)	05.70 - 1979										

### R 14

L, TL, GTL (R1210) Ch. → 0345946	1976 - 1978		195		C 0911	CG0911		60		T 3306	TG3306
LS, TS (R1211) Ch. → 0007533	1977 - 1978										
L, TL, GTL (R1210) Ch. 0345947 →	1978 - 1985		195		C 3324			60		T 3306	TG3306
LS, TS (R1211) Ch. 0007534 →	1978 - 1985										
L, TL, GTL (R1213)	1978 - 1985										
LS, TS (R1212)	1978 - 1985										

### R 15

TL, GTL (R1300)	10.71 - 1979				S 3322					T 3323	
TS (R1302)	10.71 - 1979										

### R 16

L, TL (R115)	11.64 - 1979		75		T 3325			85		T 3326	
TA, TS, TX (R115)	11.64 - 1979										

### R 17

	04.72 - 1979				S 3322					T 3323	
--	--------------	--	--	--	--------	--	--	--	--	--------	--

### R 18

1.6 TS, 1.6 GTS (R1342) Ch. → 10709	- 1982		110		S 3330			100		T 3328	TG3328
2.0 TX, 2.0 GTX (R1343) Ch. → 3200	- 1983										
2.1 TD, 2.1 GTD (R1344) Ch. → 190905	- 1984										
1.4 TL, 1.4 GTL (R1340) Ch. → 552000	1978 - 1984		110		S 3327			100		T 3328	TG3328
1.6 TS (R1341) Ch. → 559400	1978 - 1984										
1.6 GTL, 1.6 GTS (R1341) Ch. → 559400	1978 - 1984										
1.6 TS (R1342) Ch. 10709 → 20609	1982 - 1983										
1.6 GTS (R1342) Ch. 10709 → 20609	1982 - 1983										
TL (R1349)	1980 - 1982										
1.4 TL, 1.4 GTL (R1340) Ch. 552001 →	1984 - 1986		110		S 3329			100		T 3328	TG3328
1.6 GTL, 1.6 GTS (R1341) Ch. 559401 →	1984 - 1986										
1.6 TS (R1341) Ch. 559401 →	1984 - 1986										
1.6 TS, 1.6 GTS (R1342) Ch. 20610 →	1983 - 1986										
2.0 TX, 2.0 GTX (R1343) Ch. 3201 →	1983 - 1986		110		S 3329			100		T 3328	TG3328
2.1 TD, 2.1 GTD (R1344) Ch. 190906 →	1984 - 1986										
1.6 Turbo Essence (R1345)	1982 - 1986		110		S 3329			100		T 3328	TG3328
Turbo Diesel (R1346)	1984 - 1986										
Turbo Inj. Essence (R134A)	1984 - 1986										



ANTERIORE  
FRONT

POSTERIORE  
REAR



				<b>OIL</b>	<b>GAS</b>				<b>OIL</b>	<b>GAS</b>
--	--	--	--	------------	------------	--	--	--	------------	------------

## RENAULT

### R 18

1.4 TL (R1350) Ch. → 122600	- 1984		110		S 3327			100		T 3328	TG3328
1.4 TL (R1359) Ch. → 200	- 1982										
1.6 GTL, 1.6 GTS (R1351) Ch. → 118200	- 1984										
1.6 TS, 1.6 GTS (R1352) Ch. → 3929	- 1983										
1.6 LS, 1.6 TS (R1351) Ch. → 118200	- 1984										
1.4 TL (R1350) Ch. 122601 →	1984 - 1986		110		S 3329			100		T 3328	TG3328
1.4 TL (R1359) Ch. 201 →	1982 - 1986										
1.6 GTL, 1.6 GTS (R1351) Ch. 118201 →	1984 - 1986										
1.6 TS, 1.6 GTS (R1352) Ch. 3930 →	1983 - 1986										
1.6 LS, 1.6 TS (R1351) Ch. 118201 →	1984 - 1986										
2.0 TX, 2.0 GTX (R1353) Ch. → 2000	- 1982		110		S 3330			100		T 3328	TG3328
2.1 TD, 2.1 GTD (R1354) Ch. → 63219	- 1984										
2.0 TX, 2.0 GTX (R1353) Ch. 2001 →	1982 - 1986		110		S 3329			100		T 3328	TG3328
2.1 TD, 2.1 GTD (R1354) Ch. 63220 →	1984 - 1986										
1.6 Turbo Essence (R1355)	1983 - 1986		110		S 3329			100		T 3328	TG3328
2.1 Turbo Diesel (R1356)	1984 - 1986										
1.6 Turbo Inj. Essence (R135A)	1984 - 1986										
Turbo Inj. Essence (R135B)	1984 - 1986										
1.4 Société (R2350) Ch. → 4600	- 1983		110		S 3327			100		T 3328	TG3328
2.1D Société (R2354) Ch. → 3499	- 1983		110		S 3330			100		T 3328	TG3328
1.4 Société (R2350) Ch. 4601 →	1983 - 1986		110		S 3329			100		T 3328	TG3328
2.1D Société (R2354) Ch. 3500 →	1983 - 1986		110		S 3329			100		T 3328	TG3328

### R 19

	05.88 - 1996		145		M 3331	MG3331		60		T 3332	TG3332
Chamade excl. 16V	1989 - 1996							60		T 3352	TG3333
Chamade 1.8 16V	1989 - 1996		145		M 3390	MG3390		60			TG3333
Chamade 1.8 S16	1989 - 1996										
excl. 16V	1992 -		145		M 3331	MG3331		60		T 3352	TG3333
1.8 16V	1992 -		145		M 3390	MG3390		60			TG3333

### R 20

1.4 L, 1.4 TL (R1271) Ch. → 187000	1976 - 1980		120		S 3334			110		M 3335	MG3335
1.4 GTL (R1271) Ch. → 187000	1976 - 1980										
1.4 L, 1.4 TL (R1271) Ch. 187001 →	1981 - 1984		120		S 3336			110		M 3335	MG3335
1.4 GTL (R1271) Ch. 187001 →	1981 - 1984										
2.0 TS (R1272)	1976 - 1980		120		S 3337			110		M 3335	MG3335
2.0 LS (R1272)	1976 - 1980										
2.0 TS (R1272)	1981 - 1984		120		S 3338			110		M 3335	MG3335
2.0 LS (R1272)	1981 - 1984										
2.2 TX (R1279)	1981 - 1984										
2.0 TS (R1277)	1981 - 1984		120		S 3336			110		M 3335	MG3335
2.0 LS (R1277)	1981 - 1984										
2.1TD (R1276)	1976 - 1984										
2.1GTD (R1276)	1976 - 1984										
2.1 Turbo Diesel (R1270)	1982 - 1984										



ANTERIORE  
FRONT



POSTERIORE  
REAR



OIL

GAS



OIL

GAS

## RENAULT

### R 21

1.4 TL, 1.4 GTL (L48D)	1986 - 1994		195	<b>49</b>	M 3339	MG3339		60		T 3340	TG3340
1.7 L, 1.7 TL, 1.7 GTL (L481)	1986 - 1994										
1.7 RS, 1.7 GTS (L482, L48M, L48N)	1986 - 1994										
1.7 TL, 1.7 GTL (L48E, L48F, L48M, L48N)	1986 - 1994										
1.7 TS, 1.7 GTS (L48E, L48F)	1986 - 1994										
1.7 TS, 1.7 TSE (L482)	1986 - 1994										
1.9 SD, 1.9 GSD (L48H)	1989 - 1994										
2.0 TX, 2.0 GTX, 2.0 GTS (L48J)	1986 - 1994										
1.4 TL, 1.4 GTL (B48D)	1989 - 1994										
1.7 GTL (B481)	1989 - 1994										
1.7 GTS (B482, B48N)	1989 - 1994										
1.7 L, 1.7 TL (B481)	1989 - 1994										
1.7 TL, 1.7 GTL (B48F, B48M)	1989 - 1994										
1.7 TS, 1.7 TSE (B482)	1989 - 1994										
1.9 SD, 1.9 GSD (B48H)	1989 - 1994										
excl. 4x4											
1.7 TL (L48K)	1986 - 1994		195	<b>49</b>	M 3341			60		T 3340	TG3340
2.0 TI, 2.0 GTX (L48K)	1986 - 1994			<b>50</b>	M 3342						
2.0 RX, 2.0 GTX (L483, L489)	1986 - 1994										
2.0 RX, 2.0 TXE (L48K)	1986 - 1994										
2.0 TI, 2.0 TXE (L483, L489)	1986 - 1994										
2.1 TBD, 2.1 TDX (L488)	1986 - 1994										
2.1 TD, 2.1 GTD (L486)	1986 - 1994										
2.2 GTX, 2.2 TXE (L48S)	1986 - 1989										
2.0 Baccara (B483)	1989 - 1994										
2.0 GTX, 2.0 TXE (B483)	1989 - 1994										
2.1 TD (B488)	1989 - 1994										
2.2 GTX, 2.2 TXE (B48K)	1989 - 1994										
excl. 4x4											
2.0 GTS (L489)	1989 - 1994		195	<b>49</b>	M 3343			60		T 3340	TG3340
2.0 RX, 2.0 GTX (L483, L489)	1989 - 1994			<b>50</b>	M 3344						
2.0 RX, 2.0 TXE (L48K)	1989 - 1994										
2.0 TI, 2.0 GTX (L48K)	1989 - 1994										
2.0 TI, 2.0 TXE (L483, L489)	1989 - 1994										
2.0 TXI (L48Q)	1986 - 1994										
2.1 GTD (L48V, L48O)	1989 - 1994										
2.1 TBD, 2.1 TDX (L488)	1989 - 1994										
2.1 TD, 2.1 GTD (L486)	1989 - 1994										
2.2 GTX, 2.2 TXE (L48K, L48S)	1989 - 1994										
excl. 4x4											
2.0 Baccara (B483)	1989 - 1994		195	<b>49</b>	M 3343			60		T 3340	TG3340
2.0 GTX, 2.0 TXE (B483)	1989 - 1994			<b>50</b>	M 3344						
2.1 GTD (B48V)	1989 - 1994										
2.1 TD (B488)	1989 - 1994										
2.1 Turbo D (B487, B488, B48P)	1989 - 1994										
2.1 Turbo DX (B487, B488, B48P)	1989 - 1994										
excl. 4x4											



ANTERIORE  
FRONT

POSTERIORE  
REAR



				<b>OIL</b>	<b>GAS</b>					<b>OIL</b>	<b>GAS</b>
--	--	--	--	------------	------------	--	--	--	--	------------	------------

## RENAULT

### R 21

2.2 GTX, 2.2TXE (B48C, B48K)	1989 - 1994		195		M 3343			60		T 3340	TG3340
RX, GTX (B48Y)	1989 - 1994				M 3344						
TL, TXE (B48Y)	1989 - 1994										
excl. 4x4				<b>50</b>							
Turbo 4x2 (L485)	1988 - 1994										
Turbo 4x4 (L485)	1988 - 1994										
Nevada 1.6 RX (K48U)	1988 -		195		M 3339	MG3339		60	<b>64</b>	T 3345	TG3345
Nevada 1.7 TL (K48E, K48F, K48M, K48N)	1986 -										
Nevada 1.7 TL, 1.7 GTL (K481, K482)	1986 -										
Nevada 1.7 TS, 1.7 GTS (K481, K482)	1986 -										
Nevada 1.7 TS, 1.7 GTS (K48E, K48F)	1986 -										
Nevada 1.7 TS, 1.7 GTS (K48M, K48N)	1986 -										
Nevada 1.9 D (K48H)	1989 -										
Nevada 2.0 RX (K48J)	1986 -										
Societ� 1.7 TL, 1.7 TS (S481, S482)	1986 -										
Societ� 1.9 D (S48H)	1989 -										
excl. 4x4											
Nevada 2.0 GTX (K480, K483)	1986 -		195		M 3341			60	<b>64</b>	T 3345	TG3345
Nevada 2.0 RX (K480, K483)	1986 -				M 3342						
Nevada 2.0 TXE (K480, K483)	1986 -										
Nevada 2.1D (K488, K489)	1986 -										
Nevada 2.1D, 2.1TD (K486)	1986 -										
Nevada 2.2 GTX, 2.2TXE (K48K, K48V)	1986 -										
Societ� 2.1TD (S486, S48V)	1986 -										
excl. 4x4											
Nevada 2.0 GTX, 2.0TXE (K480, K483)	1989 -		195		M 3343			60	<b>64</b>	T 3345	TG3345
Nevada 2.1D, 2.1TD (K486, K488)	1989 -				M 3344						
Nevada 2.2 GTX, 2.2 TXE (K48K)	1989 -										
Nevada 2.2 GTX, 2.2 TXE (K48S)	1989 -										
Nevada 2.2 GTX, 2.2 TXE (K48V)	1989 -										
excl. 4x4				<b>50</b>							

### R 25

excl. V6 (B29)	11.83 - 1992		200		S 3346	SG3346		120		M 3347	MG3347
2.5 V6 Turbo (B295)	11.83 - 1992		200		S 3346	SG3346		120		M 3347	MG3347
2.7i V6 (B298)	11.83 - 1992										
2.9i V6 (B29A)	1986 - 1992										
2.9i V6 (B29F) excl. , Autom.	1987 - 1992										
2.9i V6 (B293) excl. , Autom.	1987 - 1992										
2.9i V6 Autom. (B29F) excl.	1989 - 1992							120		M 3347	MG3347
2.9i V6 Autom. (B293) excl.	1989 - 1992										
V6 turbo (B29G) excl.	1989 - 1992										



ANTERIORE  
FRONT



POSTERIORE  
REAR



OIL

GAS



OIL

GAS

## RENAULT

### R 30

TS (R1273, R1275)	1975 - 1984		120		S 3337			110		M 3335	MG3335
TX (R1278) Ch. → 22200	1979 - 1980										
TX (R1278) Ch. 22201 →	1980 - 1984		120		S 3338			110		M 3335	MG3335
2.1 Turbo D (R1270)	1982 - 1984		120		S 3336			110		M 3335	MG3335

### SAFRANE

excl. 4x4,	1992 - 1996		180		M 3385	MG3385		180		M 3387	MG3387
excl.	1996 -				M 3386	MG3386					

### TRAFIC P-SERIES (RWD)

1000 Kg (P3)	09.80 - 02.89		145		M 3367						
Microcar (P5)	09.80 - 1985				M 3368						
Microcar (P6)	09.80 - 02.89										
Microcar (P8)	09.80 - 1986										
1200 Kg (PA) Ch. → 154	09.80 - 1986										
(P6C)	1981 - 1986										
1400 Kg (PC)	1984 -										

### TRAFIC T-SERIES (FWD)

800 Kg (T1) Ch. → 25270 excl. Ambulanza	09.80 - 02.89		145		M 3367			75		H 3372	
(T1)	03.89 -				M 3368						
(T2)	1986 -										
1000 Kg (T3) Ch. → 25270	09.80 -										
1000 Kg (T4) Ch. → 25270 excl. Ambulanza	09.80 - 02.89										
1000 Kg Surélevé (T42) Ch. → 25270	09.80 - 12.82										
(T4, T5B)	03.89 -										
Ambulanza (T1) 800 Kg	09.80 - 02.89		145		M 3367			75		H 3373	
Ambulanza (T4) 1000 Kg	09.80 - 02.89				M 3368						
(T5)	09.80 - 02.89										
(T53, TE)	03.89 -										
1200 Kg (T6)	1983 - 1986										
(T7, TB)	1986 -										
1200 Kg (T9)	1983 - 1989										
1200 Kg (TA)	09.80 - 1986		145		M 3367						
					M 3368						
1000 Kg Surélevé (T46, Ch. 25271 →	1983 - 02.89							75		H 3372	

### TWINGO

	1993 - 1998		90	<b>44 - 51</b>	M 3388	MG3388		80		S 3389	SG3389
	1999 - 08.00		100			<u>MG3427</u>		80		S 3389	SG3389
						<u>MG3426</u>					
	09.00 -		100			<u>MG3431</u>		80			<u>TG3430</u>
						<u>MG3432</u>					
				<b>52</b>							

**44** Vedi disegno Renault Clio a pagina 87 - See drawing Renault Clio on page 87





ANTERIORE  
FRONT



POSTERIORE  
REAR

				OIL	GAS				OIL	GAS
--	--	--	--	-----	-----	--	--	--	-----	-----

## ROVER

### 25

	1.1, 1.4	1999 -					MG3523						SG3515
	1.6, 1.8	1999 -											
	2.0 TD	1999 -											

### 45

	,  1.4, 1.6	1999 -					MG3514		85				MG1625
	,  1.8, 2.0	1999 -											
	,  2.0 Diesel	1999 -											

### 75

		1999 -					MG3521						TG3520
	Tourer	2001 -					MG3522						

### 100

		1990 -		75		T 0408							
--	--	--------	--	----	--	--------	--	--	--	--	--	--	--

### 200

	213 (SD3)	06.84 - 09.89		60			MG1611		50				SG1612
	216 (SD3)	06.84 - 09.89											
	214	10.89 - 1995		105			MG1623		85				MG1625
	216	10.89 - 1995					MG1624						
	216 GTi	10.89 - 1995											
	218 SD (Ch. → VIN 605481)	10.89 - 10.92											
	218 SLD (Ch. → VIN 605481)	10.89 - 10.92											
	220 GTi	10.89 - 1995											
	218 D (Ch. VIN 605482 →)	10.92 - 1995		105			MG3507		85				MG1625
	218 TD (Ch. VIN 605482 →)	10.92 - 1995					MG3508						
	211, 214 (RF)	10.95 - 1999					MG1623						SG3515
	216 (RF)	10.95 - 1999					MG1624						
	220 D, 220 SD, 220 SDi (RF)	10.95 - 1999											
	200 Vi (RF)	10.95 - 1999											SG3515
	216 (XW) Ch. → 911247	10.92 - 02.96		105			MG1623		85				MG1625
	220 GSi (XW) Ch. → 911247	10.92 - 02.96					MG1624						
	220 Turbo (XW) Ch. → 911247	10.92 - 02.96											
	216 (XW) Ch. 911248 →	03.96 -											
	220 GSi (XW) Ch. 911248 →	03.96 -											
	220 Turbo (XW) Ch. 911248 →	03.96 -											
	214 (XW) Ch. → 911247	10.92 - 02.96		105			MG1623		85				MG1625
							MG1624						
	216 (XW) Ch. → 911247	10.92 - 02.96		105			MG3507		85				MG1625
							MG3508						
	(XW) Ch. 911248 →	03.96 -							85				MG1625





ANTERIORE  
FRONT

POSTERIORE  
REAR



				<b>OIL</b>	<b>GAS</b>				<b>OIL</b>	<b>GAS</b>
--	--	--	--	------------	------------	--	--	--	------------	------------

## SAAB

### 9.3

,  2.0 S excl. Turbo	1998 -				CG3609					TG3610
,  2.2 TiD	1998 -									
,  2.3 S	1998 -									
,  2.0 SE	1998 -				CG3611					TG3610
,  2.0 Turbo	1998 -									
,  2.3 SE	1998 -									
,  2.5 V6	1998 -									
	1998 -				CG3609					TG3610

### 9.5

excl.	1997 -				MG3613					SG3612
excl.	1998 -				MG3613					SG3612

### 90

(Ch. → G6000885)	- 09.84		40		T 0703	TG0703		45		T 3601	TG3601
(Ch. G6000886 →)	10.84 - 1988							45		T 3601	TG3601

### 93

(93, 93B)	1956 - 1959		40		T 0703	TG0703		45		T 1704	TG1704
-----------	-------------	--	----	--	--------	--------	--	----	--	--------	--------

### 95

	1960 - 1978		40		T 0703	TG0703					
--	-------------	--	----	--	--------	--------	--	--	--	--	--

### 96

	1960 - 1979		40		T 0703	TG0703		45		T 3602	TG3602
GT 750, 850, 896 Sport	1960 - 1966										
Sonett 90 Sport	1967 - 1974										

### 99

	1967 - 04.78		40		T 0703	TG0703		50		T 0120	TG0120
Turbo, GLE	1977 - 04.78										
	1975 - 1978										
GL, EMS, Turbo	05.78 - 1987		40		T 0703	TG0703		50		T 3601	TG3601

### 600

	1980 - 1982				M 2201	MG2201					
	1983 - 1993				M 2201	MG2201				M 2203	MG2203
										M 2204	MG2204

### 900

,  C	1984 - 1993		40	N.D.	T 3603	TG3603		50	N.D.	T 3601	TG3601
,  GL	06.78 - 1993			H.D.		TG3604			H.D.		TG3605
,  GLS	06.78 - 1993										
,  GLi	06.78 - 1993										
,  CD, EMS	06.78 - 1993		40			TG3604		50			TG3605
,  GLE	06.78 - 1993										
,  Turbo	06.78 - 1993										



ANTERIORE  
FRONT



POSTERIORE  
REAR

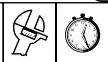

OIL

GAS

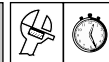

OIL

GAS

## SAAB

### 900

,  Turbo 16	1984 - 1993		40	<b>51</b>		TG3604		50			TG3605
,  Turbo 16 Aero	1984 - 1993										
,  Turbo 16 S excl. Sport	1984 - 1993										
,  Turbo 16	1984 - 1993			<b>52</b>				50			TG3605
,  Turbo 16 Aero	1984 - 1993										
,  Turbo 16 S excl. Sport	1984 - 1993										
,  2.0 S excl. Turbo	07.93 - 1998					CG3609					TG3610
,  2.3 S	07.93 - 1998										
,  2.0 SE	07.93 - 1998					CG3611					TG3610
,  2.0 Turbo	07.93 - 1998										
,  2.3 SE	07.93 - 1998										
,  2.5 V6	07.93 - 1998										
Turbo 16	1984 - 1993		40	<b>51</b>		TG3604		50			TG3605
	07.93 - 1998					CG3609					TG3610

### 9000

(Ch. → H 1015469)	1984 - 1987		100	ACC19		MG3606		90	excl.		TG3608
(Ch. → H 8000555)	1984 - 1987										
(Ch. H 1015470 →)	1987 -		100			MG3607		90	excl.		TG3608
(Ch. H 8000556 →)	1987 -										

## SANTANA

### SANTANA

2.5DC (●-● 88")						HG2301					HG2302
2500 DC (●-● 88")											
2.5DE (●-● 109", 119")						HG2301					HG2303
2.5DL (●-● 109", 119")											
3.5DL (●-● 109", 119")											
2500 DL (●-● 109", 119")											
3500 DL (●-● 109", 119")											

### SJ SERIES

(SJ 410)	1981 - 1987		50		H 4002	TG3602		50		H 1210	TG1704
(SJ 413) excl. Samurai	1981 - 1987										
Samurai (SJ 413)	1987 -		50		H 4002	TG3602		50		H 4003	TG1704

### VITARA / ESCUDO / SANTANA / SIDEKICK

2B (●-●)	1989 -		110			MG4011 MG4010		50			HG4012
4B (●-●)	1991 -		110			MG4011 MG4010		50			HG4013



ANTERIORE  
FRONT

POSTERIORE  
REAR



## SEAT

### 124

1.6, 1.8, Sport	1967 -				T 1301					T 1302	
1430, 1430 Especial	1968 -										
Diesel Pamplona	1976 -										
Familiar	1967 -				T 1301					T 1303	TG1303

### 127 / FURA

excl. Crono	1971 -		50		M 1308	MG1308		70		M 0504	MG0504
Crono	1982 -							70		M 0504	MG0504

### 128

	1969 -		70		M 1311			70		M 1312	
--	--------	--	----	--	--------	--	--	----	--	--------	--

### 131

	- 12.78		85		M 1313			70		T 1302	
	01.79 - 09.81		85		M 1314			70		T 1302	
excl. Diesel	10.81 -		135		M 1315			70		T 1302	
Diesel	10.81 -							70		T 1302	
	- 12.78		85		M 1313			40		T 1319	
	01.79 - 09.81		85		M 1314			40		T 1319	
excl. Diesel	10.81 -		135		M 1315			40		T 1319	

### 132

	1972 - 1982		70		T 1304			70		T 1320	
--	-------------	--	----	--	--------	--	--	----	--	--------	--

### ALHAMBRA

	02.95 -		70		M 1478	MG1478		40		T 1479	TG1479
--	---------	--	----	--	--------	--------	--	----	--	--------	--------

### AROSA

	1997 -		120	ACC19	M 4432	MG4432		60		T 3714	
--	--------	--	-----	-------	--------	--------	--	----	--	--------	--

### CORDOBA

1.0, 1.4, 1.6	10.93 -		120	ACC64	M 4410	MG4410		60		S 3710	SG3710
1.8 excl. 16V	10.93 -										
1.9 D, 1.9 TD	10.93 -										
1.8 16V (Ch. → 6K-ZR082 400)	10.93 - 05.94		120	ACC64		MG4410		60		S 3711	SG3711
1.8 16V (Ch. → 6K-ZR599 964)	10.93 - 05.94										
2.0 GTI (Ch. → 6K-ZR082 400)	10.93 - 05.94										
2.0 GTI (Ch. → 6K-ZR599 964)	10.93 - 05.94										
1.8 16V (Ch. 6K-ZR082 401 →)	06.94 -		120	ACC51		MG4411		60		S 3711	SG3711
1.8 16V (Ch. 6K-ZR599 965 →)	06.94 -										
2.0 GTI (Ch. 6K-ZR082 401 →)	06.94 -										
2.0 GTI (Ch. 6K-ZR599 965 →)	06.94 -										
Vario	1997 -		120	ACC64	M 4410	MG4410		60		S 4445	SG4445

Vedi disegno Volkswagen Golf a pagina 129 - See drawing Volkswagen Golf on page 129



ANTERIORE  
FRONT



POSTERIORE  
REAR

			<b>OIL</b>	<b>GAS</b>				<b>OIL</b>	<b>GAS</b>
--	--	--	------------	------------	--	--	--	------------	------------

## SEAT

### IBIZA

(Ch. → 9146536)	1984 - 05.86		100	ACC50	M 3701					M 3702	MG3702
(Ch. 9146537 →)	06.86 - 08.89		100	ACC50	M 3703	MG3703		70		M 3702	MG3702
	09.89 - 1993		100	ACC50	M 3704	MG3704		70		M 3705	MG3705
1.0, 1.3	05.93 - 1999		120	ACC64	M 4410	MG4410		60		S 3710	SG3710
1.4, 1.6	05.93 - 1999			<b>56</b>							
1.8 excl. 16V	05.93 - 1999										
1.9 D, 1.9 TD	05.93 - 1999										
1.8 16V (Ch. → 6K-ZR082 400)	10.93 - 05.94		120	ACC64		MG4410		60		S 3711	SG3711
1.8 16V (Ch. → 6K-ZR599 964)	10.93 - 05.94			<b>56</b>							
2.0 GTI (Ch. → 6K-ZR082 400)	10.93 - 05.94										
2.0 GTI (Ch. → 6K-ZR599 964)	10.93 - 05.94										
1.8 16V (Ch. 6K-ZR082 401 →)	06.94 - 1999		120	ACC51		MG4411		60		S 3711	SG3711
1.8 16V (Ch. 6K-ZR599 965 →)	06.94 - 1999			<b>56</b>							
2.0 GTI (Ch. 6K-ZR082 401 →)	06.94 - 1999										
2.0 GTI (Ch. 6K-ZR599 965 →)	06.94 - 1999										
1.0	2000 - 2002		120	<b>56</b>	M 4432	MG4432		60		S 4445	SG4445
1.4, 1.4 16V	2000 - 2002			ACC19							
1.6	2000 - 2002										
1.9 SDI, 1.9 TDI	2000 - 2002										
1.8 20VT	2000 - 2002		120	<b>56</b>		MG4411		60			SG4445
				ACC51							
	2002 -				M 3715	MG3715				T 3716	TG3716

**56** Vedi disegno Volkswagen Golf a pagina 129 - See drawing Volkswagen Golf on page 129

### INCA

	1995 -		70		M 4432	MG4432		30		T 3713	
--	--------	--	----	--	--------	--------	--	----	--	--------	--

### LEON

	2000 -				M 0316	MG0316					TG0320
--	--------	--	--	--	--------	--------	--	--	--	--	--------

### MALAGA / CREDOS

(Ch. → 9071599)	05.85 - 08.86		100	ACC50	M 3706			70		M 3707	
(Ch. 9071600 →)	09.86 - 08.89		100	ACC50	M 3703	MG3703		70		M 3702	MG3702
	09.89 -		100	ACC50	M 3704	MG3704		70		M 3705	MG3705

### MARBELLA

	1987 - 03.89		70	ACC45	M 1333	MG1333		30		T 1334	
	04.89 -		70	ACC45	M 3708			30		T 1334	

### PANDA

	1980 -		70	ACC45	M 1333	MG1333		30		T 1334	
--	--------	--	----	-------	--------	--------	--	----	--	--------	--

### RONDA / RITMO

	1978 - 09.83		100	ACC21	M 1335	MG1335		70		M 3702	MG3702
excl. Crono	10.83 - 03.86		100	ACC50	M 3701			70		M 3702	MG3702
Crono	10.83 - 03.86		100	ACC50	M 3706			70		M 3702	MG3702
excl. Crono	05.86 -		100	ACC50	M 3703	MG3703		70		M 3702	MG3702



ANTERIORE  
FRONT



POSTERIORE  
REAR



## SEAT

### TERRA

	1987 - 03.89		70		M 1333	MG1333		30		T 1334	
	04.89 -		70		M 3708			30		T 1334	

### TOLEDO

1.6 (1L)	1991 - 1998		60		M 4410	MG4410		50			SG4404
1.8 (1L) excl. GT 16V	1991 - 1998									S 4404	SG4434
1.9 D, 1.9 TD (1L)	1991 - 1998										
2.0 (1L) excl. GT	1991 - 1998										
1.8 GT 16V (1L)	1991 - 1998		60			MG4408		50			SG4404
2.0 GT (1L)	1991 - 1998										SG4434
	1999 -		100		M 0316	MG0316		40		T 0317	TG0317

Vedi disegno Volkswagen a pagina 129 - See drawing Volkswagen on page 129

### TRANS

	1985 -		70		M 1333	MG1333		30		T 1334	
--	--------	--	----	--	--------	--------	--	----	--	--------	--

## SKODA

### 100 SERIES

100, 105	1970 - 1983		30		T 3801			45		T 3802	
110, 120	1970 - 1983										
105, 120	1984 - 1990										

### 130

	1970 - 1983		30		T 3801			45		T 3802	
130, 130L	1984 - 1990		30		T 3801						
	1983 - 1990										

### 135

	1988 -		30		T 3801			45		T 3802	
--	--------	--	----	--	--------	--	--	----	--	--------	--

### 1000

1000, 1000 MB	1964 - 1969				T 3801					T 3802	
Octavia	1967 - 1970				T 3801						
Octavia	1967 - 1970										

### FABIA

	01.00 -				M 3810	MG3810				T 3811	TG3811
	11.00 -										

### FAVORIT

(781)	1988 -				C 3803			60		S 3804	
(781)	1988 -		75		M 3803	MG3803					



ANTERIORE  
FRONT



POSTERIORE  
REAR



OIL

GAS

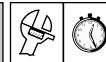

OIL

GAS

## SKODA

### FELICIA

(791) excl. ABS	10.94 -				C 3803			60		S 3804	
(795) excl. ABS	10.94 -				M 3805						
excl. ABS	10.94 -										
ABS (791)	10.94 -				C 3803			60		S 3804	
ABS (795)	10.94 -				M 3808	MG3808					
ABS	10.94 -										

### FORMAN

(785)	1990 - 10.94			75	C 3803			60		S 3804	
					M 3803	MG3803					

### OCTAVIA

1.4 (1U) excl. 4x4	1997 -		120		M 4441	MG4441		60		T 0317	TG0317
1.6 (1U) excl. 4x4	10.96 -										
1.9 SDi (1U) excl. 4x4	10.96 -										
1.8 (1U) excl. 4x4	10.96 -		120		M 0316	MG0316		60		T 0317	TG0317
1.8 20V (1U) excl. 4x4	10.96 - 1999										
1.9 TDi (1U) excl. 4x4	10.96 -										
2.0 (1U) excl. 4x4	1999 -										
1.4 (1U) excl. 4x4	1997 -		120		M 4441	MG4441		60		T 4444	TG4444
1.6 (1U) excl. 4x4	1997 -										
1.9 SDi (1U) excl. 4x4	1997 -										
1.8 (1U) excl. 4x4	1997 -		120		M 0316	MG0316		60		T 4444	TG4444
1.8 20V (1U) excl. 4x4	1997 -										
1.9 TDi (1U) excl. 4x4	1997 -										
2.0 (1U) excl. 4x4	1997 -										
4x4 (1U)	1997 -		120		M 0316	MG0316		60			TG3809

### RAPID

1.2, 1.3 Rapid	1983 - 1990		30		T 3801						
----------------	-------------	--	----	--	--------	--	--	--	--	--	--

## SSANG YONG

### KORANDO

(KJ)	1996 -					TG5703					TG5704
------	--------	--	--	--	--	--------	--	--	--	--	--------

### MUSSO

	10.93 -					TG5701					TG5702





ANTERIORE  
FRONT



POSTERIORE  
REAR



## SUBARU

### FORESTER

2.0 4WD (SF5) excl. Turbo,	1997 -					MG3923					MG3925
						MG3924					MG3926
2.0 Turbo 4WD (SF5)	1997 -					MG3923					
						MG3924					

### IMPREZA

,  1.6 2WD (GC3, GF3)	1992 -					MG3927					MG3929
,  1.8 2WD (GC5, GF5)	1992 -					MG3928					MG3930
,  2.0 2WD (GC7, GF7)	1992 -										
,  1.6 4WD (GC4, GF4)	1992 -					MG3927					MG3933
,  1.8 4WD (GC4, GF4)	1992 -					MG3928					MG3934
,  2.0 4WD (GC8, GF8)	1992 -										
excl. 2.0 GT Turbo											
,  2.0 GT Turbo 4WD (G L8)	1992 -					MG3931					MG3933
						MG3932					MG3934

### JUSTY

1.3 4WD (HSJ, HSN)	09.96 -					MG3935					MG3922
--------------------	---------	--	--	--	--	--------	--	--	--	--	--------

### LEGACY

4x2 (BC)	1989 - 1991					MG3911					MG3919
4x2 (BJ, BF)	1989 - 1991					MG3910					MG3918
4WD (BC)	1989 - 1991					MG3911					MG3915
4WD (BJ, BF)	1989 - 1991					MG3910					MG3914
4x2 (BC)	1992 - 1994					MG3913					MG3921
4x2 (BJ, BF)	1992 - 1994					MG3912					MG3920
4WD (BC)	1992 - 1994					MG3913					MG3917
4WD (BJ, BF)	1992 - 1994					MG3912					MG3916
,  2.0 2WD (BD, BG)	1994 -					MG3927					
,  2.2 2WD (BD, BG)	1994 -					MG3928					
,  2.0 4WD (BD5, BG5)	1994 -					MG3927					
,  2.2 4WD (BD7, BG7)	1994 -					MG3928					

### LEONE / LOYALE / L

,  (AB, AF)	09.80 - 08.84										T 3901	TG3901
(AW)	09.80 - 08.84											
(AM)	09.80 - 08.84											
4x2 (AC)	09.84 - 1993		40			MG3903		25				SG3904
4x2 (AG)	09.84 - 1989					MG3902						
4WD (AC) excl. Turbo,	09.84 - 1993					MG3905						
4WD (AG) excl.	09.84 - 1986					MG3906						
4WD (AN) excl.	09.84 - 1986											
4WD Turbo (AC) excl.	1987 - 1989					MG3905						SG3907
4WD (AG) excl.	1987 - 1989					MG3906						
4WD (AN) excl.	1987 - 1993											



ANTERIORE  
FRONT



POSTERIORE  
REAR

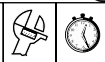

OIL

GAS

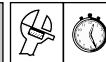

OIL

GAS

## SUBARU

### LEONE / LOYALE / L

4x2 (AN)	09.84 - 1993		40			MG3903 MG3902					SG3907
----------	--------------	--	----	--	--	------------------	--	--	--	--	--------

### XT

4x2 (AX) excl. □	09.84 - 1989										SG3904
4x2 (AX) excl. XT6, □	1990 - 1991					MG3905 MG3906					SG3904
4WD (AX) excl. XT6, □	09.84 - 1991					MG3905 MG3906					SG3904

## SUZUKI

### ALTO / FRONTE

(SS 80)	1981 - 1985							50		T 4001	
SB308  (CA91, CB91)	12.85 - 12.87				M 4020	MG4020				T 4021	TG4021
SB308  (CA91, CB91)	1988 - 1992				M 4020	MG4020				T 4022	TG4022
SH410 (FA11, FB11)	10.94 -					MG4029 MG4030					TG4028

### BALENO

,  ,  1.3 (SY413)	01.95 -					MG4031					MG4033
,  ,  1.5 (SY415)	01.95 -					MG4032					MG4034
,  ,  1.6 (SY416)	01.95 -										
,  ,  1.6 4WD (SY416)	01.95 -										
,  ,  1.8 (SY418)	01.95 -										
excl.											

### CARRY

Van (ST90V)	1980 - 1985							50	N.D.	T 4001	
(SK408, SK410)	1986 -							50	N.D.	T 4001	
(SK408, SK410)	1986 -								H.D.	H 0706	
(SK408, SK410)	1986 -									H 0707	
(SK408, SK410)	1986 -										

### GRAND VITARA

1.6 (SQ416 - TAO)	1998 -										
2.0 3B (SQ420 - TA5)	1998 -										
2.0 5B (SQ420 - TL5)	1998 -										
2.0 TD (SQ420 - TD3)	1998 -										
2.5 (SQ425 - TD6)	1998 -										



ANTERIORE  
FRONT



POSTERIORE  
REAR



## SUZUKI

### JIMNY

LJ 10, SJ 10 (550) LJ 20 LJ 81 (550)	1970 - 06.77 1970 - 06.77 1970 - 06.77				H 4002	TG3602				H 1210	TG1704
SJ 10 SJ 20 LJ 80, LJ 80Q, LJ 80V (550) LJ 81, LJ 81K, LJ 81P (550)	06.77 - 1981 06.77 - 1981 06.77 - 1981 06.77 - 1981		50		H 4002	TG3602					
(SJ 30) (SJ 410) (SJ 413)	1981 - 1987 1981 - 1987 1981 - 1987		50		H 4002	TG3602		50		H 1210	TG1704
1.3 (SJ413) Samurai	1987 - 1998 1987 - 1998		50		H 4002	TG3602		50		H 4003	TG1704
1.9 (SJ419) Samurai	1998 - 1998 -					TG4035					TG4036
1.3 (SN 413) 1.3 4WD (SN 413)	1998 - 1998 -					TG4023					TG4024

### MARUTI

			50		M 4015 M 4014			20		T 4016	
--	--	--	----	--	------------------	--	--	----	--	--------	--

### SWIFT

1.0 (SA 310 - AA41) 1.3 (SA 413 - AA51)	1983 - 1985 1983 - 1985		110			MG4004		50			TG4005
1.0 (SA 310 - AA43) 1.3 (SA 413 - AA53) 1.3 GTI (SA 413 - AA33)	1986 - 1988 1986 - 1988 1986 - 1988		110			MG4004		50			TG4006
1.0 3B-5B (SF310 - A44) 1.3 3B-5B (SF413 - A35) 1.3 GTI (SF413 - AA34) Ch. → S00104275 excl. 4WD	1989 - 1995 1989 - 1995 1989 - 1990		110			MG4007		100			MG4008
1.3 4B (SF413 - AH35) 1.6 4B (SF416 - AH14) 1.6 4B (SF416 - AJ14) 1.3 GTI (SF413 - AA34) Ch. S00104276 →	1989 - 1995 1989 - 1995 1989 - 1995 1991 - 1995		110			MG4009		100			MG4008

### VITARA / ESCUDO / SANTANA / SIDEKICK

1.6 2B (SE416 - TA0) Ch. → 1110000 1.6 3B (SE416 - TA0) Ch. → 1110000 1.6 5B (SE416 - TD0) Ch. → 1110000	1989 - 1994 1989 - 1994 1991 - 1994		110			MG4011 MG4010		50			HG4012
1.6 2B (JJ61, JV61) (E) 1.6 3B (TV0) (E) 1.6 5B (TW0) (E)	1989 - 1989 - 1989 -										
1.6 2B (SE416 - TA0) Ch. 1110001 → 1.6 3B (SE416 - TA0) Ch. 1110001 → 1.6 5B (SE416 - TD0) Ch. 1110001 →	1995 - 1995 - 1995 -										





ANTERIORE  
FRONT



POSTERIORE  
REAR



## TALBOT

### 150

	1977 - 1979				T 4101					T 4102	TG4102
--	-------------	--	--	--	--------	--	--	--	--	--------	--------

### 1100 / 1200

,	1967 - 1980		30		T 0119			30		T 4102	TG4102
VF 1	03.76 - 1980										
VF 2	1967 -		30		T 0119						

### 1307 / 1308 / 1309

	1974 - 1980		25		T 4101			30		T 4102	TG4102
--	-------------	--	----	--	--------	--	--	----	--	--------	--------

### 1510

incl. Alpine	1979 - 1984		25		T 4103	TG4103		30		T 4102	TG4102
--------------	-------------	--	----	--	--------	--------	--	----	--	--------	--------

## ALPINE

Serie I, II, III	1959 - 1964				T 4104						
	1970 - 1975				C 4106						
1.3 GL	1976 - 1980		35		T 4101			40		T 4102	TG4102
1.4 S, 1.4 GLS	1976 - 1980										

## AVENGER

1.3, 1.6	1977 - 1981				C 4105						
1.3, 1.6	1977 - 1981										

## EXPRESS

	1983 -									H 0934	
--	--------	--	--	--	--	--	--	--	--	--------	--

## GAZELLE

Serie I, II	1957 - 1963				T 4104						
Serie III A, III B, III C	1957 - 1963										
	1968 - 1970				C 4106						

## HORIZON

	1977 - 1986		40		T 4103	TG4103		50		T 4102	TG4102
--	-------------	--	----	--	--------	--------	--	----	--	--------	--------

## HUNTER

	01.67 - 1977				C 4106						
	01.67 - 1977				C 4106					T 1704	
1.5, 1.7	1977 - 1980				C 4106						
De Lux, Super	1977 - 1980										

## MATRA / SIMCA

Bagheera S	1973 - 1980				T 0119						
Bagheera X	1973 - 1980										



ANTERIORE  
FRONT



POSTERIORE  
REAR

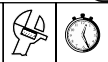

OIL

GAS

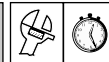

OIL

GAS

## TALBOT

### MINX / RAPIER / SOLARA

Serie I, II	1956 - 1963				T 4104						
Serie III A, III B, III C	1956 - 1963										
H 120 (Rapier)	01.67 - 10.70				C 4106						
	01.67 - 10.70				C 4106					T 1704	
LS, GL	1979 - 1986		40		T 4103	TG4103		40		T 4102	TG4102
GLS, SX	1979 - 1986										
Alpine	1979 - 1986										

### SAMBA

excl. Rallye	10.81 - 1986		200		M 0914	MG0914		120		S 0913	
Rallye	10.81 - 1986							120		S 0913	

### SCEPTRE

MK III	1968 - 1976				C 4106						
MK III	1974 - 1976				C 4106					T 1704	

### SUNBEAM

excl. Lotus, Ti	1977 - 1982				C 4105						
-----------------	-------------	--	--	--	--------	--	--	--	--	--	--

### TAGORA

	1980 - 1985		350		C 3032	CG3032		60		H 3033	HG3033
--	-------------	--	-----	--	--------	--------	--	----	--	--------	--------

### VOGUE

	1967 - 1970				C 4106						
	1967 - 1970				C 4106					T 1704	

## TOYOTA

### 4 RUNNER

(RN61)	12.87 - 1989					HG4243					HG0201
2.4 TD 4x4 (LN130)	1989 -					HG4243					HG4244
3.0 V6 4x4 (VZN130)	1989 -										
3.0 TD 4x4 (KZN130)	1993 -										
(RZN180, RZN185)	11.95 -										
(VZN185)	11.95 -										

### AVENSIS

,  ,  1.6 (AT220)	1998 -					MG4295					MG4297
,  ,  1.8 (AT221)	1998 -					MG4296					MG4298
,  ,  2.0 (ST220)	1998 -										
,  ,  2.0 D (CT220)	1998 -										



ANTERIORE  
FRONT



POSTERIORE  
REAR

				<b>OIL</b>	<b>GAS</b>					<b>OIL</b>	<b>GAS</b>
--	--	--	--	------------	------------	--	--	--	--	------------	------------

## TOYOTA

### CAMRY

1.8 (SV10)	10.82 - 09.86		190		ACC19		CG4201		110		ACC18		MG4220
1.8 Turbo D (CV10)	06.83 - 09.86												
2.0 (SV11)	12.82 - 09.86												
2.0 Turbo D (CV11)	05.85 - 09.86												
1.8 (SV20) excl. 4x4	10.86 - 08.91		220		ACC19		CG4203		205		ACC19		CG4204
2.0 (SV21) excl. 4x4	10.86 - 08.91												
2.0 Turbo D (CV20) excl. 4x4	10.86 - 08.91												
2.5 V6 (ZV21) excl. 4x4	1989 - 08.91												
2.2 (SXV10)	10.91 - 08.96		75				CG4206						CG4207
3.0 V6 (VCV10)	10.91 - 08.96												
2.2 (SXV20)	09.96 - 2001				←		MG5021				←		MG5023
3.0 V6 (MCV20)	09.96 - 2001				→		MG5020				→		MG5022
1.8 (SV20)	10.86 - 02.92		220		ACC19		CG4203		205		ACC19		CG4205
2.0 (SV21)	10.86 - 02.92												
2.0 Turbo D (CV20)	10.86 - 02.92												
2.2 (SXV10)	03.92 - 08.96				←		MG4275				←		MG4277
3.0 V6 (VCV10)	03.92 - 08.96				→		MG4276				→		MG4278

### CARINA

1.4 (TA10)	12.70 - 07.77				ACC18	C 4208	CG4208					T 2801	TG2801
1.6 (TA12)	12.70 - 1975												
1.6 (TA14)	1976 - 07.77												
,  1.6 (TA40, TA60)	08.77 - 09.83		255		ACC18	C 4208	CG4208		60			T 2921	TG2921
,  1.8 (TA47, TA62)	08.81 - 09.83												
,  1.8 Diesel (CA60)	04.82 - 09.83												
1.4 (TA16)	08.77 - 09.83				ACC18	C 4208	CG4208					T 2921	TG2921
1.6 (TA40, TA60)	08.77 - 09.83												
1.8 (TA47, TA62)	04.82 - 09.83												
1.8 Diesel (CA60)	08.77 - 09.83												

### CARINA II / CORONA

,  ,  1.6 (AT151)	10.83 - 12.87		230			C 4209	CG4209		180		ACC19		MG4202
,  ,  1.8 (ST150)	10.83 - 12.87		230			C 4210	CG4211		180		ACC19		MG4202
,  ,  2.0 D (CT150)	10.83 - 12.87												
,  ,  2.0 (ST151)	08.85 - 12.87												
,  ,  1.5 (AT171)	12.87 - 1992		205				CG4209		180				MG4212
,  ,  1.6 (AT171)	12.87 - 1992												
,  ,  1.8 (ST171)	12.87 - 1992		205				CG4203		180				MG4212
,  ,  2.0 (ST171)	12.87 - 1992												
,  ,  1.8 D (CT170)	12.87 - 1992												
,  ,  2.0 D (CT170)	12.87 - 1992												
1.5 (AT171)	12.87 - 10.92		205				CG4209		180				MG4212
1.6 (AT171)	12.87 - 10.92												
1.8 (ST171)	12.87 - 10.92		205				CG4203		180				MG4212
2.0 (ST171)	12.87 - 10.92												
1.8 D (CT170)	12.87 - 10.92												
2.0 D (CT170)	12.87 - 10.92												



ANTERIORE  
FRONT



POSTERIORE  
REAR

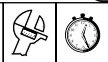

OIL

GAS

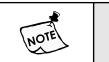
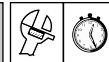

OIL

GAS

## TOYOTA

### CARINA E / CORONA

,  1.6 (AT190)	02.92 - 01.96					MG5003 MG5004					MG5005 MG5006
,  2.0 (ST191) excl. GTI	02.92 - 01.96					CG4213					MG5005
,  2.0 D (CT190)	02.92 - 01.96					MG5003 MG5004					MG5006
,  2.0 GTI (ST191)	02.92 - 01.96										MG5005 MG5006
,  1.6 GTI (AT190 - SB1)	02.96 -					MG5003					MG5005
,  1.8 GTI (AT191 - SB1)	02.96 -					MG5004					MG5006
,  2.0 (ST191 - SB1)	02.96 -										
,  2.0 DI (CT190 - SB1)	02.96 -										
1.6 (AT190 - JT1)	11.92 - 02.94					MG5003 MG5004					MG4297 MG4298
1.6 (AT190 - JT1)	02.92 - 01.96					MG5003					MG5005
1.8 (AT191 - JT1)	02.92 - 01.96					MG5004					MG5006
2.0 (ST191 - JT1)	11.92 - 01.96					CG4213					MG4297
2.0 D (CT190 - JT1)	11.92 - 02.94					MG5003 MG5004					MG4298
2.0 D (CT190 - JT1)	02.94 - 01.96					CG4213 MG5003 MG5004					MG5005 MG5006
1.6 (AT190 - SB1)	1995 -					MG5003					MG4297
1.8 (AT191 - SB1)	1995 -					MG5004					MG4298
2.0 (ST191 - SB1)	1995 -										
2.0 D (CT190 - SB1)	1995 -										

### CELICA

1.6 (TA22)	12.70 - 09.75										T 2801 TG2801	
1.6 (TA23, TA28)	10.75 - 07.77				ACC18	C 4208	CG4208				T 2801 TG2801	
2.0 (RA23, RA28)	10.75 - 07.77											
1.6  13" (TA40)	08.77 - 07.81		190		ACC18	C 4208	CG4208		40		T 2921 TG2921	
2.0  13" (RA40)	08.77 - 07.81											
1.6  14" (TA40)	08.77 - 07.81		190		ACC19		CG1207		40		T 2921 TG2921	
2.0  14" (RA40)	08.77 - 07.81											
1.6 LT, 1.6 ST (TA60)	08.81 - 08.85		190		ACC18	C 4208	CG4208		40		T 2921 TG2921	
2.0 XT, 2.0 ST (RA60)	08.81 - 08.83				ACC19		CG1207				T 2921 TG2921	
1.6 GT, 1.6 GTS (AA63)	09.83 - 08.85		200		ACC19		CG1207		40		T 4215 TG4215	
2.0 GT (RA63)	09.81 - 08.83											
2.0 XT, 2.0 ST (RA61)	09.81 - 08.85											
2.0 GT, 2.0 ST (SA63)	09.83 - 08.84											
2.0 XT, 2.0 ST (RA65)	09.84 - 08.85											
2.8 Supra (MA61)	1981 - 05.83						CG4226		40		TG4215	
2.8 Supra (MA61)	06.83 - 1985						CG4208		40		TG4215	
1.6 (AT160)	08.85 - 08.87		200		ACC19		CG4211		150		ACC18	MG4217
1.8 (ST160)	08.85 - 08.87											
2.0 (ST162)	08.85 - 08.87											





ANTERIORE  
FRONT



POSTERIORE  
REAR

				<b>OIL</b>	<b>GAS</b>					<b>OIL</b>	<b>GAS</b>
--	--	--	--	------------	------------	--	--	--	--	------------	------------

## TOYOTA

### CELICA

1.6 (AT160) excl. Turbo, 4x4	08.87 - 08.89		200			CG4203		150			MG4212
2.0 (ST162) excl. Turbo, 4x4	08.87 - 08.89										
1.6 (AT180) excl. ABS	09.89 - 10.93		160			CG4218		195			MG4219
2.0 (ST182) excl. ABS	09.89 - 10.93										
2.0 Turbo 4x4 (ST185)	09.89 - 10.93		160			CG4218					MG4281 MG4282
1.8 (AT200)	11.93 - 1999					CG4279					MG5019
,  2.0 (ST202) excl. 2.0 GT 4x4	11.93 - 1999										MG5018
	1999 -										

### COASTER

RU 19, BU 19	1972 - 1977					HG1210				T 1303	TG1303
RB 10, RB 11, RB 12	08.77 - 04.82					T 1303	TG1303			T 1303	TG1303
RB 13, BB 10	08.77 - 04.82										

### COROLLA

1.2 (KE20)	05.70 - 07.74				ACC18	C 1204						
,  1.2 (KE25)	05.70 - 07.74											
,  1.4 (TE25)	09.70 - 07.74											
1.2 (KE30)	08.74 - 07.81				ACC18	C 1204					T 3201	
1.2 (KE35)	08.74 - 07.81											
1.2 (KE50)	03.76 - 08.79											
,  1.3 (KE55)	05.78 - 07.81				ACC18	C 1204					T 2921 TG2921	
,  1.4 (TE30, TE40)	07.74 - 1979				ACC19		CG1207				T 3201	
1.6 (TE31)	03.75 - 04.80											
1.6 (TE37)	03.75 - 04.80											
1.6 (TE51)	03.76 - 08.79											
,  1.3 (KE70)	08.79 - 05.83		175			C 1205	CG1205		30		T 2801 TG2801	
,  1.5 (AE70)	08.79 - 05.83											
1.6 (AE71)	05.83 - 10.84											
,  1.6 (TE71)	08.79 - 05.83				ACC19		CG1207				T 2801 TG2801	
,  1.8 (TE72)	08.79 - 05.83											
1.8 Diesel (CE70)	10.82 - 05.83											
,  1.3 (AE80)	05.83 - 05.87		190			C 4209	CG4209		135		M 4220 MG4220	
,  1.5 (EE80)	05.83 - 05.87											
,  1.6 (AE82) excl. GT	05.83 - 05.87											
,  1.6 GT (AE82)	1984 - 05.87					C 4210	CG4211				M 4220 MG4220	
,  1.8 Diesel (CE80)	05.83 - 05.87											
,  1.3 (EE90)	06.87 - 1992		250		54	C 4209	CG4209		100		ACC19	M 4221 MG4221
,  1.6 (AE92) excl. GTi	06.87 - 1992											
,  1.6 GTi (AE92)	06.87 - 1992		250				CG4203					
,  1.8 Diesel (CE90, CE92)	06.87 - 1992		250				CG4203		100		ACC19	M 4221 MG4221
,  1.3 (EE100, EE101)	05.92 - 1997		150				MG4223		240			MG4225
,  1.6 (AE101)	05.92 - 1997						MG4222					MG4224
,  2.0 Diesel (CE100)	05.92 - 1997											



ANTERIORE  
FRONT



POSTERIORE  
REAR

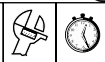

OIL

GAS

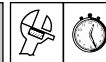

OIL

GAS

## TOYOTA

### COROLLA

,  1.3 (EE110)	1997 -		150			CG5007					MG4225
,  1.3 (EE111)	1997 - 09.99					MG4223					MG4224
,  1.6 (AE111)	1997 - 09.99					MG4222					
,  1.8 (AE115)	1997 -										
,  2.0 Diesel (CE110), 1.8 (AE115)	1997 -										
,  2.0 Diesel (CE111)	1997 -										
,  1.4 (ZE111)	10.99 - 2001		150			CG5007					MG4225
,  1.6 (ZE112)	10.99 - 2001					MG4223					MG4224
,  1.9 Diesel (ZE110)	1999 - 2001					MG4222					
1.6 Trueno (TE27)	03.72 - 03.74				ACC18	C 4208	CG4208				
1.6 Trueno (TE47)	08.74 - 02.79				ACC19		CG1207				
1.6 GTi (AE86)	05.83 - 05.87		180		ACC19		CG1207		40		T 2801
Twin Cam 16V (AE86)	05.83 - 05.87										TG2801
1.2 (KE26 V)	05.70 - 07.74				ACC18	C 1204					
1.2 (KE36 V)	08.74 - 09.79				ACC18	C 1204					T 2921
1.4 (TE36 V)	04.74 - 1979				ACC19		CG1207				T 2921
1.3 (KE70)	08.79 - 05.83		175			C 1205	CG1205		30		T 2921
1.6 (TE71)	08.79 - 05.83		255		ACC19		CG1207		50		T 2921
1.8 Diesel (CE70)	08.81 - 05.83										
1.3 (KE70)	06.83 - 05.87		200		ACC19	C 1207	CG1207				
1.6 (AE71, TE71)	09.83 - 05.87										
1.6 4x4 (AE95)	10.87 - 1992								85		TG2801
1.3 (EE90)	06.87 - 1992		250			C 4209	CG4209		100		M 4221
1.6 (EE92)	06.87 - 1992										MG4221
1.8 Diesel (CE90, CE92)	06.87 - 1992		250				CG4203		100		M 4221
1.3 (EE100, EE101)	05.92 - 1997		150				MG4223		240		MG4225
1.6 (AE101)	05.92 - 1997						MG4222				MG4224
2.0 Diesel (CE100)	05.92 - 1997										
1.3 (EE110)	1997 -		150				CG5007				MG4225
1.3 (EE111)	1997 - 09.99						MG4223				MG4224
1.6 (AE111)	1997 - 09.99						MG4222				
2.0 Diesel (CE110)	1997 -										
2.0 Diesel (CE111)	1997 -										
1.4 (ZE111)	10.99 - 2001		150				CG5007				MG4225
1.6 (ZE112)	10.99 - 2001						MG4223				MG4224
1.9 Diesel (ZE110)	1999 - 2001						MG4222				

### CORONA MK I

1.5 (RT40, RT80)	09.64 - 01.71					T 2920	TG4257				T 3201
1.6 (RT81, RT82)	02.70 - 07.73										
,  1.6 (RT51)	1965 - 1968										
1.7 (RT84)	02.71 - 07.73										
,  1.7 (RT94)	09.70 - 07.73										
1.9 (RT83)	02.71 - 04.72										
2.0 (RT85)	05.72 - 07.73										
,  2.0 (RT95)	05.72 - 07.73										



ANTERIORE  
FRONT

POSTERIORE  
REAR



## TOYOTA

### CORONA MK I

1.6 (RT100)	08.73 - 08.78				T 2920	TG4257				T 2801	TG2801
,  1.6 (RT110)	07.74 - 11.75										
1.8 (RT102)	08.73 - 05.79										
,  1.8 (RT112)	08.73 - 11.75										
2.0 (RT104)	08.73 - 05.79										
,  2.0 (RT114)	11.75 - 08.78										
1.6 (RT130, TT133)	09.78 - 12.81			⊗ 13"		CG4226				T 2921	TG2921
,  ,  1.8 (TT132)	09.78 - 12.81										
1.9 (XT130)	09.78 - 12.81										
,  ,  2.0 (RT132, RT133)	09.78 - 12.81										
1.6 (RT130, TT133)	09.78 - 12.81			⊗ 14"						T 2921	TG2921
,  ,  1.8 (TT132)	09.78 - 12.81										
1.9 (XT130)	09.78 - 12.81										
,  ,  2.0 (RT132, RT133)	09.78 - 12.81										
,  ,  1.5 (AT140, RT140)	01.82 - 12.86			⊗ 13"		CG4226			⊗ 13"	T 2921	TG2921
,  ,  1.8 (ST140)	01.82 - 12.86										
1.8 Diesel (CT140)	01.82 - 12.86										
,  ,  1.6 (RT140, TT140)	01.82 - 12.86			⊗ 14"					⊗ 14"	T 4215	TG4215
,  ,  1.8 (RT140, TT140)	01.82 - 12.86										
,  ,  2.0 (RT140, TT140)	01.82 - 12.86										
,  1.5 (RT46 V)	1965 - 1970				T 2920	TG4257				T 1303	TG1303
1.5 (RT86 V)	02.70 - 01.71				T 2920	TG4257					
1.6 (RT87 V)	02.71 - 07.73										
1.6 (RT116)	08.73 - 08.78				T 2920	TG4257				T 1303	TG1303
1.8 (RT117)	08.73 - 09.75										
2.0 (RT118)	09.74 - 08.78										
1.6 (RT130, TT133)	09.78 - 12.81					CG4226				T 3201	
1.8 (TT132)	09.78 - 12.81										
2.0 (RT132, RT133)	09.78 - 12.81										
1.6 (CT140, TT140)	01.82 - 12.86					CG4226				T 3201	
1.8 (CT140, TT140)	01.82 - 12.86										

### CORONA MK II

1.6 (RT60, RT70)	09.68 - 01.70				T 2920	TG4257				T 1303	TG1303
1.7 (RT61, RT71)	02.70 - 12.71										
1.9 (RT62, RT72)	04.69 - 12.71										
,  2.0 (RX12, RX22)	01.72 - 11.76				T 2920	TG4257				T 3201	
,  2.0 (MX10)	01.72 - 11.76										
,  2.3 (MX12, MX22)	01.72 - 08.74										
,  2.6 (MX13, MX23)	08.72 - 11.76										
1.5 (RT66)	06.68 - 01.71				T 2920	TG4257				T 1303	TG1303
1.6 (RT69)	02.71 - 12.71										
1.6 (RT76)	09.68 - 01.70				T 2920	TG4257				T 1303	TG1303
1.7 (RT77)	02.70 - 12.71										
2.0 (RX28)	01.72 - 11.76				T 2920	TG4257				T 1303	TG1303
2.3 (MX28)	08.73 - 08.74										



ANTERIORE  
FRONT



POSTERIORE  
REAR

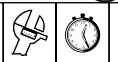

OIL

GAS

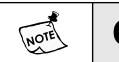

OIL

GAS

## TOYOTA

### CRESSIDA

1.8 (TX30)	01.80 - 08.80									T 4215	TG4215
2.0 (RX30)	12.76 - 08.80										
2.6 (MX32)	12.76 - 08.80										
1.8 (TX62)	07.81 - 07.84		175			CG4226		30		T 4215	TG4215
2.0 (RX60)	09.80 - 07.84										
2.0 (GX60)	09.82 - 07.84										
2.2 Diesel (LX60)	09.80 - 07.84										
2.8 (MX62)	09.80 - 08.82										
2.0 (GX61)	09.82 - 07.84					CG4226				T 4215	TG4215
2.8 (MX63)	08.83 - 07.84										
2.0 (GX71)	08.84 - 09.86					CG4226					TG4215
2.4 D (LX70)	08.84 - 09.86										
2.4 TD (LX71)	08.84 - 09.86										
2.8 (MX73)	08.84 - 09.86										
2.0 (RX35)	12.76 - 08.80									T 3201	
2.6 (MX36)	12.76 - 08.80										
2.0 (RX60, RX62)	09.80 - 07.84					CG4226				T 2921	TG2921
2.2 Diesel (LX60)	09.80 - 07.84										
2.8 (MX62)	09.80 - 07.84										
2.8 (MX72)	08.84 - 09.86					CG4226				T 2921	TG2921
2.4 TD (LX70)	08.84 - 09.86										

### CROWN

1.9 (RS41)	1965 - 08.67					TG2622					
2.0 (MS41)	1965 - 08.67										
2.3 (MS45)	1965 - 08.67										
2.0 (RS50, RS60)	09.67 - 09.74					TG2622					
2.3 (MS51, MS55)	09.67 - 01.71										
2.0 (RS80)	10.74 - 08.79					TG2622					
2.3 (MS64)	02.71 - 09.74										
2.6 (MS65, MS75)	02.71 - 09.74										
2.6 (MS85, MS95)	10.74 - 08.79										
2.0 (RS110)	09.79 - 07.83		50			TG2622		40		T 2936	TG2936
2.2 Diesel (LS110)	09.79 - 07.83										
2.6 (MS111)	09.79 - 07.80										
2.8 (MS112)	09.79 - 07.83										
2.0 (YS120)	08.83 - 09.87		50			TG2622		40		T 2936	TG2936
2.5 Diesel (LS120)	08.83 - 09.87										
2.8 (MS122)	08.83 - 09.87										
2.8 (MS123, MS125)	08.83 - 09.87				T 4230						
2.0 (MS46)	1965 - 07.67					TG2622				T 2702	
,  2.0 (MS56, RS56)	08.67 - 01.71					TG2622				T 2702	
,  2.3 (MS57, RS57)	08.67 - 01.71										
,  2.3 (MS67)	02.71 - 01.73					TG2622				T 2702	
,  2.6 (MS63, MS68)	02.71 - 09.74										
,  2.6 (MS83, MS88)	01.75 - 08.79										



ANTERIORE  
FRONT



POSTERIORE  
REAR



## TOYOTA

### CROWN

2.2 Diesel (LS110)	09.79 - 07.81		50			TG2622		40		T 2936	TG2936
2.6 (MS111)	09.79 - 07.80										
2.8 (MS112)	09.79 - 07.83										
2.8 (MS122)	08.83 - 09.87										

### DYNA

BU 10, BU 12, BU 15	1972 - 07.77					HG1210				T 1303	TG1303
BU 10H, BU 12H, BU 15H	1972 - 07.77										
JU 10, JU 12, JU 15	1969 - 07.77										
JU 10H, JU 12H, JU 15H	1969 - 07.77										
RU 10, RU 12, RU 15	1969 - 07.77										
RU 10H, RU 12H, RU 15H	1969 - 07.77										
HU 15H	1972 - 07.77				T 1303	TG1303				T 1303	TG1303
BU 20, BU 30	07.77 - 11.84				T 2801	TG2801				T 1303	TG1303
BU 35, BU 36	08.80 - 11.84										
RU 20, RU 30	07.77 - 11.84										
HU 30, HU 50	07.77 - 11.84										
JU 20	07.77 - 11.84										
1.8 (YH81)	08.85 -				H 2862					H 4283	
2.4 D (LH80)	08.85 -										
BU75, BU85	08.87 -				H 4228					H 4229	

### HI-ACE

(PH10)	1967 - 1977		60		T 4230			50		T 1303	TG1303
(LH10, RH10)	1967 - 1977										
(LH20, LH30, LH40)	1977 - 1982										
(RH20, RH30, RH40) excl. RH22, RH24	1977 - 1982										
Van (RH22)	1977 - 1982		60		T 4230						
1.8 (YH50, YH60)	11.82 - 12.83		60			HG2837		50			HG1210
2.0 (LH50, LH60)	11.82 - 12.83										
2.2 D (LH70, YH71)	11.82 - 12.83										
1.8 (YH50, YH60)	01.84 - 08.86		60			HG2837		50			HG4231
2.0 (YH51)	01.84 - 08.86										
2.0 (YH61)	01.84 - 08.89										
2.2 D (LH71)	01.84 - 08.89										
2.4 D (LH51, LH61)	01.84 - 08.89										
excl. 4x4											
2.2 4x4 (YH56)	08.86 - 08.89		60			HG4232					
2.2 4x4 Long (YH66)	08.86 - 08.89										
2.4 D 4x4 (LH56)	08.86 - 08.89										
2.4 D 4x4 Long (LH66)	08.86 - 08.89										
2.0 (RZH 102, RZH 112)	08.89 - 1995		40			HG4233		25			HG4234
2.4 (RZH 103, RZH 113, RZH 115)	08.89 - 1995										
2.4 D (LH 102, LH 112)	08.89 - 1995										
excl. 4x4											



ANTERIORE  
FRONT



POSTERIORE  
REAR

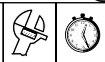

OIL

GAS

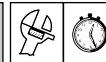

OIL

GAS

## TOYOTA

### HI-ACE

2.4 4x4 (RZH 109, RZH 119)	08.89 - 1995		40			HG4232		25			HG4235
2.4 D 4x4 (LH 108, LH 118)	08.89 - 1992										
2.4 (RCH 12, RCH 22)	08.95 - 03.98		40			HG4233					
2.4 D (LXH 12, LXH 22)	08.96 -										
2.4 TD (LCH 12, LCH 22)	08.96 -										
2.7 (RCH 19, RCH 29)	04.98 -										
excl. 4x4											
2.4 4x4 (RCH 18, RCH 28)	08.96 - 03.98		40			HG4232					
2.4 D 4x4 (LXH 18, LXH 28)	08.96 -										
2.4 TD 4x4 (LCH 18, LCH 28)	08.96 -										
2.7 4x4 (RCH 19, RCH 29)	04.98 -										
1.6 (RH10, RH20, RH30)	1977 - 1982		60		T 4230			50		T 1303	TG1303
2.0 (RH25, RH32, RH42)	1977 - 1982										
2.4 (RZH 115)	08.89 - 1992		40			HG4233		25			HG4234

### HI-LUX

4x2 (RN10, RN13)	1968 - 1979		80		T 4230			60		T 1303	TG1303
4x2 (RN15, RN16, RN20)	1968 - 1979										
4x2 (RN22, RN25)	1968 - 1979										
4x2 (RN27, RN28)	1968 - 1979										
4x2 (RN30, RN31, RN32)	1978 - 03.84		80		T 4230			60		T 1303	TG1303
4x2 (RN33, RN34, RN35)	1978 - 03.84										
4x2 (RN40, RN41)	1978 - 03.84										
4x2 (RN42, RN44)	1978 - 03.84										
4x2 (LN30, LN40)	1978 - 03.84										
4x4 (RN36, RN39, RN46)	1979 - 07.83		60			HG4236		60			HG2616
4x4 (LN36, LN46)	1979 - 07.83										
4x2 (LN50, LN51)	08.83 - 08.88		85		T 4237	HG4237		60	N.D.	T 1303	TG1303
4x2 (LN55, LN56)	08.83 - 08.88								H.D.		HG4238
4x2 (YN50, YN51)	08.83 - 08.88										
4x2 (YN52, YN55)	08.83 - 08.88										
4x2 (YN56, YN57, YN58)	08.83 - 08.88										
4x2 (RN50, RN55)	08.83 - 08.88										
4x4 (LN60, LN61, LN65)	08.83 - 08.88		60			HG4236		60			HG4239
4x4 (YN61, YN62)	08.83 - 08.88										
4x4 (YN65, YN67)	08.83 - 08.88										
1.8 4x2 (LN85, YN85, YN90)	08.88 -		45			HG4237		25			HG4240
2.4 D 4x2 (LN85, YN85, LN90)	08.88 -										
2.4 D 4x2 Cabina Singola (LN85)	10.91 -										
2.4 D 4x2 Cabina Doppia (LN85)	10.91 -										
4x4 (LN105)	08.88 -		45			HG4241		25			HG4242
4x4 (YN106)	08.88 -										
2.2 4x4 (YN110)	08.88 -		45			HG4243		25			HG4242
2.4 4x4 (RN106, RN110)	08.88 -										
2.4 D 4x4 (LN108, LN110)	08.88 -										



ANTERIORE  
FRONT



POSTERIORE  
REAR

				<b>OIL</b>	<b>GAS</b>					<b>OIL</b>	<b>GAS</b>
--	--	--	--	------------	------------	--	--	--	--	------------	------------

## TOYOTA

### HI-LUX

2.4 D 4x2 (LN145)	08.97 - 07.99		45			HG4237					
2.4 D 4x2 (LN150)	08.97 - 07.99										
2.4 4x4 (RZN168, RZN173)	08.97 - 12.98					HG4243					
2.4 TD 4x4 (LN165, LN170)	08.97 - 12.98										

### LAND CRUISER

(BJ40, BJ43)	1970 - 10.84		60			HG1210		60		H 2616	HG2616
(BJ42, BJ44)	08.80 - 10.84										
(BJ45, BJ46)	08.80 - 10.84										
(FJ40, FJ42)	03.69 - 10.84										
(FJ43, FJ45)	03.69 - 10.84										
(HJ45, HJ47)	04.72 - 06.85										
(BJ55)	03.69 - 03.71									T 1303	
(FJ55)	03.69 - 03.71										
(BJ55)	04.71 - 07.80							60		H 2616	HG2616
(FJ55, FJ56 V)	04.71 - 07.80										
(BJ70, BJ71, BJ73)	1984 - 12.89		50			HG4245		40			HG4239
(BJ75)	1984 - 12.89		50			HG4245					
(HJ75)	1984 - 12.89										
(LJ70, LJ73, LJ77)	1984 - 12.89		50			HG4247		60			HG4249
(RJ70, RJ73)	1984 - 12.89										HG4248
Station Wagon (FJ60, FJ62)	08.80 - 10.85		50			HG4250		30		H 2616	HG2616
Station Wagon (HJ60, HJ61)	08.80 - 10.85										
Station Wagon (BJ60)	08.80 - 10.85										
Chassis #J6##G.. (WGG)											
Van (BJ60)	08.80 - 10.85		50			HG4245		30		H 2616	HG2616
Van (FJ60, FJ62)	08.80 - 10.85										
Van (HJ60, HJ61)	08.80 - 10.85										
Chassis #J6##V.. (WGV)											
Station Wagon (FJ62)	10.85 - 08.87		50			HG4250		50			HG0201
Station Wagon (HJ60, HJ61)	10.85 - 08.87										
Station Wagon (BJ60)	10.85 - 08.87										
Chassis #J6##G.. (WGG)											
Van (BJ60)	10.85 - 08.87		50			HG4245		50			HG0201
Van (FJ60, FJ62)	10.85 - 08.87										
Van (HJ60, HJ61)	10.85 - 08.87										
Chassis #J6##V.. (WGV)											
(HJ60, HJ61)	08.87 - 12.89		50			HG4250		50			HG0201
(HZJ70, HZJ73)	01.90 -		50			HG4251		50			HG4252
(PZJ70, PZJ73)	01.90 -										
(FJ80)	01.90 - 08.92		50			HG4255		50			HG4256
(HDJ80, HDJ81)	01.90 - 08.92										
(HZJ80)	01.90 - 1998										
(LJ70, LJ73)	01.90 - 04.96		50			HG4253		50			HG4254
(LJ77, LJ79)	01.90 - 04.96										
(RJ70, RJ73)	01.90 - 04.96										
(KZJ70, KZJ73, KZJ77)	05.93 - 05.96										



ANTERIORE  
FRONT



POSTERIORE  
REAR

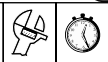

OIL

GAS

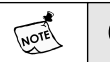
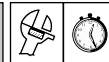

OIL

GAS

## TOYOTA

### LAND CRUISER

(KZJ90, KZJ95)	1996 -				S 5009					H 5011	
(VZJ90, VZJ95)	1996 -										
(HDJ100, HDJ105) excl. ☐	1998 -				H 5010					H 5012	
(UZJ100, UZJ105) excl. ☐	1998 -										

### LITE-ACE

Van (KM10, KM11)	1970 - 09.79		75		T 2920	TG4257		50		T 1303	TG1303
(KM10, KM11)	1970 - 09.79										
(CM20, KM20)	09.79 - 10.85		75		T 4230			50			HG1210
Van H (CM20, KM20)	09.79 - 10.85										
Van H-H (CM20, KM20)	09.79 - 10.85		75		T 4230			50		T 1303	TG1303
H (CM20, KM20)	09.79 - 10.85		75		T 4230			50		T 1303	TG1303
H (CM20, KM20)	09.79 - 10.85										
H-H (CM20, KM20)	09.79 - 10.85		75		T 4230			50		T 1704	TG1704
H-H (CM20, KM20)	09.79 - 10.85										
(CM30, KM30, KM31)	10.85 - 12.91		75		T 4230						
(CM35, CM36, KM36)	10.85 - 12.91		75		T 4230			50		H 4258	
(CR27, KR27, YR29)	01.92 -										HG4280
(CR21, KR21, YR22)	01.92 -		50			HG2623					

### MR 2

1.6 (AW10, AW11)	1985 - 08.86		175		ACC18		CG4263				
1.6 (AW11)	09.86 - 1990		175		ACC18		CG4263				

### PASEO

1.5 (EL54)	08.95 -						MG4287			S 4291	SG4291
							MG4288				

### PICNIC

2.0 4x2 (XM10)	1997 -						MG5001				TG5008
2.2 TD 4x2 (XM10)	1997 -						MG5002				

### PREVIA

4x2 (TCR10)	06.90 -		155				MG4265		70		HG4274
4x4 (TCR20)	06.90 -						MG4264				
4x2 (TCR11)	06.90 -		155				MG4265		70		HG4266
4x4 (TCR21)	06.90 -						MG4264				

### RAV 4 / FUN CRUISER

3B (SXA10)	04.94 - 04.00				54		CG4284				HG4286
5B (SXA11)	04.95 - 04.00										

### SPACE CRUISER / MODEL F

1.8 4x2 (YR20)	1983 - 07.84		50			T 4259			30	T 4260	
2.0 4x2 (YR21)	08.84 - 1990										
2.0D 4x2 (CR21)	1983 - 07.84										
4x4 (YR31)	09.85 -						HG4261				HG4262





ANTERIORE  
FRONT



POSTERIORE  
REAR



## TOYOTA

### STARLET

1.0 (KP60)	02.78 - 10.84		200		C 4267			40		T 4215	TG4215
1.2 (KP62)	07.78 - 10.84										
1.3 (KP61)	08.81 - 1985										
1.0 (EP70)	10.84 - 11.89		220		C 4268	CG4268		55		S 4285	SG4285
1.3 (EP71)	10.84 - 11.89										
1.3 Turbo (EP71)	1986 - 11.89										
1.5 D (NP70, NR70)	1987 - 11.89										
1.0 (EP80)	12.89 - 04.94				M 4293	MG4293		55		S 4285	SG4285
1.3 (EP81, EP82)	12.89 - 04.94				M 4294	MG4294					
1.3 Turbo (EP81)	12.89 - 04.94										
1.5 D (NP80)	12.89 - 04.94										
1.0 (EP80)	05.94 - 01.96				M 4293	MG4293		55		S 5013	SG5013
1.3 (EP81, EP82)	05.94 - 01.96				M 4294	MG4294					
1.3 Turbo (EP81)	05.94 - 01.96										
1.5 D (NP80)	05.94 - 01.96										
1.3 (EP91)	02.96 -				M 4293	MG4293				S 4291	SG4291
					M 4294	MG4294					
1.0 (KP60 V)	10.78 - 1985		200		C 4267			40		T 2921	TG2921
1.2 (KP62 V)	10.78 - 08.82										
1.3 (KP61 V)	08.82 - 1985										
1.0 (EP70)	10.84 - 11.89		220		C 4268	CG4268		55		S 4285	SG4285
1.3 (EP71)	10.84 - 11.89										
1.3 Turbo (EP71)	1986 - 11.89										
1.5 D (NP70, NR70)	1987 - 11.89										

### STOUT

RK 45, RK 47	1960 - 1968									T 1303	TG1303
RK 100, RK 101	1963 - 1968										
RK 40, RK 40V, RK 43	1963 - 1968				T 2920	TG4257				T 1303	TG1303

### SUPRA / SOARER

2.8 Supra SPR (MA61)	12.81 - 05.83					CG4226					TG4215
2.8 Supra SPR (MA61)	06.83 - 01.86					CG4208					TG4215

### TERCEL

1.3 (AL10)	01.79 - 04.82									T 4270	
1.3 (AL11, AL12)	01.79 - 04.82							60		T 4270	
1.5 (AL11, AL12)	01.79 - 04.82										
1.3 (AL20, AL21)	05.82 - 08.84		205			CG4271		115			MG4272
1.5 (AL20, AL21)	09.82 - 08.84										
1.5 4x4 (AL25)	09.82 - 1988		205			CG4273		60		T 2801	TG2801

### YARIS

excl. Verso	1999 -				M 5014	MG5014				T 5016	TG5016
Verso	1999 -				M 5015	MG5015				T 5017	TG5017



ANTERIORE  
FRONT



POSTERIORE  
REAR

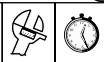

OIL GAS

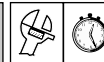

OIL GAS

## TRABANT

### TRABANT

601	1965 - 1991				T 5101					T 5101
-----	-------------	--	--	--	--------	--	--	--	--	--------

## TRIUMPH

### ACCLAIM

	1981 - 1984		110		MG1609			120		MG1610
--	-------------	--	-----	--	--------	--	--	-----	--	--------

### DOLOMITE

1300, 1500, 1850	1972 - 1980				S4305					S 4304
------------------	-------------	--	--	--	-------	--	--	--	--	--------

### GT6

GT 6 MK I	1966 - 1968									T 4302
GT 6	1974 - 1980									
GT 6 MK III	1973 - 1976									

## SALOONS

Herald 12/30, 13/60	1959 - 1971									T 4302
Vitesse 2	1962 - 1968									
1.5, 1.5 TC, Toledo	1971 - 1974									S 4304

## SPITFIRE

MK I, MK II, MK III, MK IV	1962 - 1982									T 4302
----------------------------	-------------	--	--	--	--	--	--	--	--	--------

## UMM

### ALTER

4x4	1980 - 1987				H 5401					H 4258
-----	-------------	--	--	--	--------	--	--	--	--	--------

## VAUXHALL

### ASTRA / BELMONT

	1980 - 1984		140		C 2927	CG2927		25		T 2905	TG2905
(Ch. → J2791967) excl. GSi, GTE	1984 - 07.88		140		C 2927	CG2927		25		T 2905	TG2905
(Ch. → J5273427) excl. GSi, GTE	1984 - 07.88										
GSi, GTE (Ch. → J2791967)	1984 - 07.88		140			CG2927		25			TG2905
GSi, GTE (Ch. → J5273427)	1984 - 07.88										
(Ch. J2791968 →) excl. GSi, GTE	08.88 - 08.91		140		C 2927	CG2927		25		T 2908	TG2908
(Ch. J5273428 →) excl. GSi, GTE	08.88 - 08.91										
GSi, GTE (Ch. J2791968 →)	08.88 - 08.91		140			CG2927		25			TG2908
GSi, GTE (Ch. J5273428 →)	08.88 - 08.91										
excl. GT, GSi	09.91 - 1998		150		C 2907	CG2907		40		T 2908	TG2908
GT	09.91 - 1998		150			CG2907		40			TG2908
GSi	09.91 - 1998		150			CG2907		40			TG2939
,  ,	04.98 -				M 2953	MG2953				T 2955	TG2955
					M 2954	MG2954					
	1980 - 1984		140		C 2927	CG2927		25		T 2928	



ANTERIORE  
FRONT



POSTERIORE  
REAR

				<b>OIL</b>	<b>GAS</b>					<b>OIL</b>	<b>GAS</b>
--	--	--	--	------------	------------	--	--	--	--	------------	------------

## VAUXHALL

### ASTRA / BELMONT

	1984 - 08.91		140		C 2927	CG2927		25		T 2909	TG2909
	09.91 - 1998		150		C 2907	CG2907		40	excl.	T 2909	TG2909
	04.98 -				M 2953	MG2953				T 2956	TG2956
	09.91 - 1998		150		M 2954	MG2954		40			TG2908

### CALIBRA

	2.0 excl.	1990 - 1998		145		CG2912		45	excl.		TG2913
	2.0 16V excl. Turbo,	1990 - 1998									
	2.5 V6 excl. Turbo,	1990 - 1998									

### CARLTON / OMEGA

		1978 - 1986		130		C 2923	CG2923		40		T 2922	TG2922
	1.8, 2.0 excl.	1986 - 04.94		215		M 2932	MG2932		40		T 2933	TG2933
	2.3D, 2.3 TD excl.	1986 - 04.94										
	2.4 excl.	1986 - 04.94										
	2.6 excl.	1987 - 04.94		215			MG2934		40			TG2933
	3.0i, 3.0 24 V excl. Lotus,	1987 - 04.94										
	2.0, 2.0 16V excl.	05.94 -					MG2940		40			TG2933
	2.5 V6 excl.	05.94 -					MG2941		40			TG2933
	2.5 TD excl.	05.94 -										
	3.0 V6 excl.	05.94 -										
		1978 - 1986		130		C 2923	CG2923		40		T 2936	TG2936
	excl.	1986 - 04.94		215		M 2932	MG2932		40		T 2935	TG2935
	2.0, 2.0 16V excl.	05.94 -					MG2940		40			TG2935
	2.5 V6 excl.	05.94 -					MG2941		40			TG2935
	2.5 TD excl.	05.94 -										
	3.0 V6 excl.	05.94 -										

### CAVALIER

		1975 - 08.81		35		T 2903	TG2903		40		T 2902	TG2902
	(Ch. → F1003026)	09.81 - 1985		120		C 2904	CG2904		40		T 2905	TG2905
	(Ch. → F5000000)	09.81 - 1985										
	(Ch. → F6000000)	09.81 - 1985										
	(Ch. F1003027 →)	1985 - 1988		120		C 2906	CG2906		40		T 2905	TG2905
	(Ch. F5000001 →)	1985 - 1988										
	(Ch. F6000001 →)	1985 - 1988										
	1.4, 1.6, 1.8	09.88 - 1995		145		C 2912	CG2912		40	excl.	T 2908	TG2908
	1.7D, 1.7TD	09.88 - 1995										
	2.0 excl. 16V	09.88 - 1995										
	excl. 4x4											
	2.0 16V (Ch. → NV1999999)	09.88 - 1992		145		C 2912	CG2912		40	excl.	T 2933	TG2933
	2.0 16V (Ch. → N1999999)	09.88 - 1992										
	2.0 16V (Ch. → N5999999)	09.88 - 1992										
	excl. 4x4											



ANTERIORE  
FRONT



POSTERIORE  
REAR

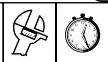

OIL

GAS

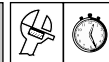

OIL

GAS

## VAUXHALL

### CAVALIER

,  2.0 16V (Ch. P1000001 →)	1993 - 1995		145			CG2912		40	excl.	T 2908	TG2908
,  2.0 16V (Ch. P5000001 →)	1993 - 1995										
,  2.0 16V (Ch. P7000001 →)	1993 - 1995										
excl. 4x4											
,  1.8 4x4	09.88 - 1995		145			CG2912		40	excl.	T 2933	TG2933
,  2.0 4x4	09.88 - 1995										
,  2.0 16V 4x4 excl. Turbo	09.88 - 1995										
(Ch. → F1003026)	09.81 - 1985		120		C 2904	CG2904		50		T 5201	
(Ch. → F5000000)	09.81 - 1985										
(Ch. → F6000000)	09.81 - 1985										
(Ch. F1003027 →)	1985 - 1988		120		C 2906	CG2906		50		T 5201	
(Ch. F5000001 →)	1985 - 1988										
(Ch. F6000001 →)	1985 - 1988										

### CHEVETTE

	1976 - 1984		50		T 2903	TG2903		40		T 2922	TG2922
	1975 - 1984		50		T 2903	TG2903		40		T 2921	TG2921
	1976 - 1984										
	1976 - 1984										

### CORSA / NOVA

excl. GT	1983 - 1993		150		M 2917	MG2917		50		T 2918	TG2918
GT	1988 - 1993		150			MG2943		50			TG2919
excl. GSi	1993 - 1999		150		M 2942	MG2942		50		T 2944	TG2944
GSi, GSi 16V	1993 - 1999		150			MG2943		50			TG2944
excl. Sport	2000 -		150			MG2965 MG2966		50			TG2967
COMBO	1993 -		150		M 2943	MG2943		25		T 2929	

### FRONTERA

2B (Type A, )	1991 - 08.95		60		H 2924	HG2924		60		H 2925	HG2925
4B (Type A, )	1991 - 08.95										
2B (Type A, )	09.95 - 1998		60			HG2947		60			HG2930
4B (Type A, )	09.95 - 1998										
2B (Type B)	1999 -		60			HG2960		60			HG2961
4B (Type B)	1999 -										

### MONTEREY

	1992 - 03.95		60			HG1903		60			HG2930
2B	04.95 - 1997		60			HG2949		60			HG2930
4B	04.95 - 1997		60			HG2949		60			HG2950
	1998 -		60					60			



ANTERIORE  
FRONT



POSTERIORE  
REAR



## VAUXHALL

### MOVANO

,  28 Q.li	1997 -				H 3411					H 3412	
,  30 Q.li	1997 -										
,  35 Q.li	1997 -										
35 Q.li (HD, UD)	1997 -				H 3411					H 3413	
	1997 -				H 3411						

### RASCAL

	1986 -				M 0709			25		H 0706	
					M 0708						
	1986 -				M 0709			25		H 0707	
					M 0708						

### ROYALE / SENATOR

excl.	1978 - 1987		140		C 2923	CG2923		60			TG2931
excl.	1978 - 1982										
excl. 3.0 24V,	1987 - 04.94		215		M 2932	MG2932		40		T 2933	TG2933
3.0 24V excl.	1987 - 04.94		215			MG2934		40			TG2933

### SINTRA

	1998 -					MG2958			excl.		HG2959
--	--------	--	--	--	--	--------	--	--	-------	--	--------

### TIGRA

1.4 16V	1994 -		150			MG2943		50			TG2944
1.6 16V	1994 -										

### VECTRA

1.6, 1.8	08.95 -				M 2945	MG2945				S 2946	SG2946
2.0	08.95 -				M 2948	MG2948					
1.7 TD	01.96 -				M 2951	MG2951			N.D.	S 2946	SG2946
2.0 TDi	01.96 -				M 2952	MG2952			H.D.	S 2957	SG2957
2.5 V6	08.95 -										
1.6, 1.8	08.95 -				M 2945	MG2945			excl.	S 2946	SG2946
2.0	08.95 -				M 2948	MG2948					
1.7 TD	08.95 -				M 2951	MG2951			excl.	S 2957	SG2957
2.0 TDi	08.95 -				M 2952	MG2952					
2.5 V6	08.95 -										

### VICTOR / VENTORA / VX

Series FE	1972 - 02.74									T 2902	TG2902
Cresta PA	1952 - 1957				T 4104						

### ZAFIRA

	1999 -					MG2963					TG2964
						MG2962					





ANTERIORE  
FRONT



POSTERIORE  
REAR



## VOLKSWAGEN

### GOLF II

1.0, 1.1, 1.3	09.83 - 1989		100		C 4403	CG4403		40	<b>58</b>		SG4404
1.6, 1.6 D, 1.6 TD	09.83 - 1989								<b>57</b>	S 4404	SG4434
1.8 excl. 16V, Syncro	09.83 - 1989										
1.8 16V GTI excl. Syncro	09.83 - 1989		100			CG4405		40			SG4406
1.0, 1.1	1990 - 08.91		100		C 4403	CG4403		40	<b>58</b>		SG4404
1.3, 1.6	1990 - 08.91			<b>56</b>	M 4410	MG4410			<b>57</b>	S 4404	SG4434
1.6 D, 1.6 TD	1990 - 08.91										
1.8 excl. 16V, G60, Syncro, Country	1990 - 08.91										
1.8 16V GTI excl. G60, Syncro, Country	1990 - 08.91		100			MG4408		40			SG4406
1.8 G60 excl. Syncro	1990 - 08.91		100	<b>55</b>		MG4409		40			SG4406
1.8 Syncro excl. Country	1986 - 1989		100		C 4403	CG4403		40			
1.8 Syncro excl. G60, Country, Rallye	1990 - 08.91		100	<b>56</b>	M 4410	MG4410					

**55** - **56** Vedi disegno Volkswagen Golf a pagina 129 / 134 - See drawing Volkswagen Golf on page 129 / 134

### GOLF III

1.4, 1.6	09.91 - 08.94		120		M 4410	MG4410		60	<b>58</b>		SG4404
1.8 excl. GT	09.91 - 08.94			<b>56</b>					<b>57</b>	S 4404	SG4434
1.9 D, 1.9 TD excl. TDi	09.91 - 08.94										
2.0 (Ch. → 1H SW062 538) (Ch. → 1H SB019 474)	09.91 - 08.94										
1.4, 1.6	09.94 - 1998		120		M 4432	MG4432		60	<b>58</b>		SG4404
1.8 excl. GT	09.94 - 1998			<b>56</b>					<b>57</b>	S 4404	SG4434
1.9 D, 1.9 TD excl. TDi, SDi	09.94 - 1998										
2.0 (Ch. 1H SW062 539 →) (Ch. 1H SB019 475 →)	09.94 - 1998										
1.8 GT	09.91 - 08.94		120			MG4410		60	<b>58</b>		SG4404
1.9 TDi (Ch. → 1H SW062 538) (Ch. → 1H SB019 474)	09.91 - 08.94			<b>56</b>					<b>57</b>		SG4434
1.8 GT	09.94 - 1998		120			MG4432		60	<b>58</b>		SG4404
1.9 TDi, 1.9 SDi (Ch. 1H SW062 539 →) (Ch. 1H SB019 475 →)	09.94 - 1998			<b>56</b>					<b>57</b>		SG4434
2.0 GTI	09.91 - 1998		120			MG4411		60			SG4406
2.0 16V GTI	08.92 - 1998			<b>56</b>							
2.8 VR6	1992 - 1998										
1.8 Syncro (Ch. → 1H SW062 538) (Ch. → 1H SB019 474)	01.93 - 08.94		120		M 4410	MG4410					
				<b>56</b>							
1.8 Syncro (Ch. 1H SW062 539 →) (Ch. 1H SB019 475 →)	09.94 - 1998		120		M 4432	MG4432					
				<b>56</b>							
1.9 TDi Syncro	1995 - 1998		120		M 4432	MG4432					
2.0 Syncro	08.95 - 1998			<b>56</b>							

**56** Vedi disegno Volkswagen Golf a pagina 129 - See drawing Volkswagen Golf on page 129



ANTERIORE  
FRONT



POSTERIORE  
REAR



OIL

GAS

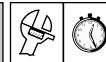

OIL

GAS

## VOLKSWAGEN

### GOLF III

2.9 VR6 Syncro	1995 - 1998		120	ACC51 <b>56</b>		MG4411					
1.4, 1.6, 1.8 1.9 D, 1.9 TD 1.9 TDi, 1.9 SDi excl. Syncro (Ch. → 1H SW062 538) excl. Syncro (Ch. → 1H SB019 474)	09.93 - 08.94 09.93 - 08.94 09.93 - 08.94		120	ACC64 <b>56</b>	M 4410	MG4410		60			SG4437
1.4, 1.6, 1.8 1.9 D, 1.9 TD 1.9 TDi, 1.9 SDi excl. Syncro (Ch. 1H SW062 539 →) excl. Syncro (Ch. 1H SB019 475 →)	09.94 - 1998 09.94 - 1998 09.94 - 1998		120	ACC64 <b>56</b>	M 4432	MG4432		60			SG4437
2.0 GL, 2.0 GLT excl. Syncro	09.93 - 1998		120	ACC51 <b>56</b>		MG4411		60			SG4437
1.8, 2.0 Syncro 1.9 TDi Syncro 2.9 VR6 Syncro	1995 - 1998 1995 - 1998 1995 - 1998		120	ACC51 <b>56</b>		MG4411					
1.6, 1.8 1.9 TDi	09.93 - 08.94 09.93 - 08.94		120	ACC64 <b>56</b>	M 4410	MG4410		60	<b>58</b> <b>57</b> ACC68	S 4404	SG4404 SG4434
1.6, 1.8 1.9 TDi	09.94 - 09.94 -			ACC64 <b>56</b>	M 4432	MG4432		60	<b>58</b> <b>57</b> ACC68	S 4404	SG4404 SG4434
2.0	09.93 -		120	ACC51 <b>56</b>		MG4411		60	<b>58</b> <b>57</b> ACC68		SG4404 SG4434

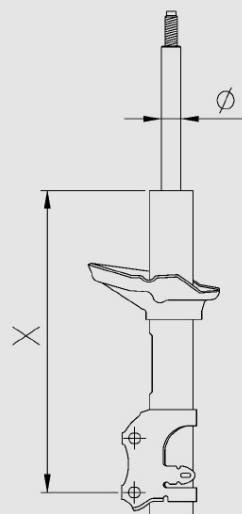

**56**

M 4410 X = 320 mm. Ø=20 mm.

MG4410 X = 320 mm. Ø=20 mm.

MG 4411 X = 342 mm. Ø=22 mm.

M 4432 X = 336 mm. Ø=20 mm.

MG4432 X = 336 mm. Ø=20 mm.









ANTERIORE  
FRONT

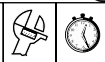

POSTERIORE  
REAR



OIL

GAS

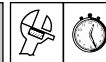

OIL

GAS

## VOLKSWAGEN

### JETTA

1.1, 1.3	1973 - 08.83		100		C 4401	CG4401		40		S 4402	SG4402
1.5, 1.5 D	1973 - 08.83										
1.6, 1.6 D	1973 - 08.83										
1.6 GTI, 1.6 TD	1973 - 08.83		100			CG4401		40			SG4402
1.8 Li, 1.8 GLi	1973 - 08.83										
1.0, 1.1	08.83 - 1988		100		C 4403	CG4403		40		<b>58</b>	SG4404
1.3, 1.6	08.83 - 1988									<b>57</b>	SG4434
1.6 D, 1.6 TD	08.83 - 1988									S 4404	
1.8 excl. 16V, GT, Syncro	08.83 - 1988										
1.8 GT, 1.8 GTI excl. Syncro	1986 - 1989					CG4405		40			SG4406
1.8 16V GTX excl. Syncro	1986 - 1989										
1.0, 1.1	1989 - 1992		100		C 4403	CG4403		40		<b>58</b>	SG4404
1.3, 1.6	1989 - 1992			<b>56</b>	M 4410	MG4410				<b>57</b>	SG4434
1.6 D, 1.6 TD	1989 - 1992									S 4404	
1.8 excl. 16V, GT, Syncro	1989 - 1992										
1.8 GT excl. Syncro	1989 - 1992		100			CG4403		40		<b>58</b>	SG4404
1.8 GTI excl. 16V, Syncro	1989 - 1992			<b>56</b>		MG4410				<b>57</b>	SG4434
1.8 GTI 16V excl. Syncro	1990 - 1992		100			MG4408		40			SG4406
1.8 Syncro	1986 - 1989				C 4403	CG4403					
1.8 Syncro	1990 - 1992			<b>56</b>	M 4410	MG4410					

### LT SERIES

2.0 (LT28, LT31, LT35)	1975 - 12.82		50		T 4416			40		T 4429	
2.4 (LT28, LT31, LT35)	1975 - 12.82										
2.4 D (LT28, LT31, LT35)	1978 - 12.82										
2.5 D (LT28, LT31, LT35)	1976 - 12.82										
excl. 4000 Kg.											
4000 Kg. (LT35 - M512)	1975 - 12.82		50		T 4416						
2.0 (LT40, LT45)	1975 - 12.82		50		H 4433			40		T 4429	
2.4 (LT40, LT45)	1975 - 12.82										
2.4 D (LT40, LT45)	1978 - 12.82										
2.4 D (LT50, LT55)	1978 - 12.82										
2.5 D (LT40, LT45)	1976 - 12.82										
excl. 4000 Kg.											
4000 Kg. (LT40 - M512)	1975 - 12.82		50		H 4433						
4000 Kg. (LT45 - M512)	1975 - 12.82										
2.4 (LT28, LT31, LT35)	12.82 - 12.96		50		T 4416			40		H 4417	
2.4 D (LT28, LT31, LT35)	12.82 - 12.96										
2.0 (LT40, LT45)	12.82 - 12.96		50		H 4433						
2.4 (LT40, LT45)	12.82 - 12.96										
2.4 (LT50, LT55)	12.82 - 12.96										
2.4 D (LT40, LT45)	12.82 - 12.96										
2.4 D (LT50, LT55)	12.82 - 12.96										
2.4 TD (LT40, LT45)	12.82 - 12.96										
2.4 TD (LT50, LT55)	12.82 - 12.96										



ANTERIORE  
FRONT

POSTERIORE  
REAR



				<b>OIL</b>	<b>GAS</b>				<b>OIL</b>	<b>GAS</b>
--	--	--	--	------------	------------	--	--	--	------------	------------

## VOLKSWAGEN

### LT SERIES

,  ,  2.3 (LT28, LT35)	1997 -									T 2542	
,  ,  2.5 TDi (LT28, LT35)	1997 -										
,  ,  2.5 SDi (LT28, LT35)	1997 -										
,  ,  2.8 TDi (LT28, LT35)	1997 -										
,  ,  2.3 (LT46)	1997 -									H 2543	
,  ,  2.5 TDi (LT46)	1997 -										
,  ,  2.8 TDi (LT46)	1997 -										

### LUPO

	1998 -		55		ACC19	M 4432	MG4432		70		T 3714	
--	--------	--	----	--	-------	--------	--------	--	----	--	--------	--

### NEW BEETLE

	1998 -		100				MG0316		40			TG0320
--	--------	--	-----	--	--	--	--------	--	----	--	--	--------

### PASSAT

	1973 - 1980		195		ACC18	C 0303	CG0303		30		T 0305		
excl. Syncro	10.80 - 04.88		195		ACC19	C 0306	CG0306		70		ACC41	S 4418 SG4418	
excl. Syncro, VR6	05.88 - 07.91		195			ACC51	C 4409 M 4409	CG4409 MG4409		60		ACC68	S 4420 SG4420
excl. Syncro, VR6,	08.91 - 1993		100			ACC51	M 4409	MG4409		60		ACC68	S 4420 SG4420
(Ch. → 31-P-026435)													
excl. Syncro, VR6,	1994 - 07.96		100			ACC51	M 4430	MG4430		60		ACC68	S 4420 SG4420
(Ch. 31-P-026436 →)													
2.8 VR6 excl.	08.91 - 07.96		100			ACC51		MG4430		60		ACC68	SG4420
1.6	08.96 - 09.99		80				S 0314	SG0314		60		T 4436 TG4436	
1.8, 1.8 T	08.96 - 09.99												
1.9 SDi, 1.9 TDi	08.96 - 09.99												
excl. 4-Motion (Ch. → 3B-WE113561)													
2.3 VR5	08.96 - 09.99		80					SG0321		60		T 4436 TG4436	
2.5 V6 TDi	08.96 - 09.99												
2.8 V6	08.96 - 09.99												
excl. 4-Motion (Ch. → 3B-WE113561)													
1.6	10.99 -		80					SG4449		60		T 4436 TG4436	
1.8, 1.8 T	10.99 -												
1.9 SDi, 1.9 TDi	10.99 -												
excl. 4-Motion (Ch. 3B-WE113562 →)													
2.3 VR5	10.99 -		80					SG4450		60		T 4436 TG4436	
2.5 V6 TDi	10.99 -												
2.8 V6	10.99 -												
excl. 4-Motion (Ch. 3B-WE113562 →)													
Syncro excl.	1989 - 07.91		195			ACC51	C 4409 M 4409	CG4409 MG4409		70		ACC68	SG4421
Syncro excl.	08.91 - 1993		100			ACC51	M 4409	MG4409		70		ACC68	SG4421
(Ch. → 31-P-026435)													

Vedi disegno Volkswagen Passat a pagina 134 - See drawing Volkswagen Passat on page 134

--	--	--	--	--	--	--	--	--	--	--	--	--



ANTERIORE  
FRONT



POSTERIORE  
REAR

				<b>OIL</b>	<b>GAS</b>					<b>OIL</b>	<b>GAS</b>
--	--	--	--	------------	------------	--	--	--	--	------------	------------

## VOLKSWAGEN

### PASSAT

Syncro excl. □ (Ch. 31-P-026436 →)	1994 - 09.96		100	<b>55</b> ACC51	M 4430	MG4430		70	ACC68		SG4421
1.8 4-Motion (4x4)	1997 - 09.99				S 0314	SG0314					
1.9 TDi 4-Motion (4x4) (Ch. → 3B-WE113561)	1997 - 09.99										
2.3 VR5 4-Motion (4x4)	1997 - 09.99					SG0321					
2.5 V6 TDi 4-Motion (4x4)	1997 - 09.99										
2.8 V6 4-Motion (4x4) (Ch. → 3B-WE113561)	1997 - 09.99										
	1973 - 1980		195	ACC18	C 0303	CG0303		30		T 0305	
excl. Syncro	10.80 - 04.88		195	ACC19	C 0306	CG0306		70	ACC41	S 4418	SG4418
excl. Syncro, VR6, □	05.88 - 07.91		195	<b>55</b> ACC51	C 4409 M 4409	CG4409 MG4409		70	ACC68	S 4420	SG4420
excl. Syncro, VR6, □ (Ch. - > 31-P-026435)	08.91 - 1993		100	<b>55</b> ACC51	M 4409	MG4409		60	ACC68	S 4420	SG4420
excl. Syncro, VR6, □ (Ch. 31-P-026436 →)	1994 - 02.97		100	<b>55</b> ACC51	M 4430	MG4430		60	ACC68	S 4420	SG4420
2.8 VR6 excl. □	08.91 - 02.97		100	<b>55</b> ACC51		MG4430		60	ACC68		SG4420
1.6 1.8, 1.8 T 1.9 SDi, 1.9 TDi excl. 4-Motion (Ch. → 3B-WE113561)	03.97 - 09.99 03.97 - 09.99 03.97 - 09.99		80		S 0314	SG0314		60			TG0323
2.3 VR5 2.5 V6 TDi 2.8 V6 excl. 4-Motion (Ch. → 3B-WE113561)	03.97 - 09.99 03.97 - 09.99 03.97 - 09.99		80			SG0321		60			TG0323
1.6 1.8, 1.8 T 1.9 SDi, 1.9 TDi excl. 4-Motion (Ch. 3B-WE113562 →)	10.99 - 10.99 - 10.99 -		80			SG4449		60			TG0323
2.3 VR5 2.5 V6 TDi 2.8 V6 excl. 4-Motion (Ch. 3B-WE113562 →)	10.99 - 10.99 - 10.99 -		80			SG4450		60			TG0323
Syncro excl. □	1989 - 07.91		195	<b>55</b> ACC51	C 4409 M 4409	CG4409 MG4409		70	ACC68		SG4421
Syncro excl. □ (Ch. → 31-P-026435)	08.91 - 1993		100	<b>55</b> ACC51	M 4409	MG4409		70	ACC68		SG4421
Syncro excl. □ (Ch. 31-P-026436 →)	1994 - 02.97		100	<b>55</b> ACC51	M 4430	MG4430		70	ACC68		SG4421
1.8 4-Motion (4x4) 1.9 TDi 4-Motion (4x4) (Ch. → 3B-WE113561)	1997 - 09.99 1997 - 09.99		80		S 0314	SG0314					

**55** Vedi disegno Volkswagen Passat a pagina 134 - See drawing Volkswagen Passat on page 134



ANTERIORE  
FRONT



POSTERIORE  
REAR



## VOLKSWAGEN

### PASSAT

2.3 VR5 4-Motion (4x4)	1997 - 09.99						SG0321					
2.5 V6 TDi 4-Motion (4x4)	1997 - 09.99											
2.8 V6 4-Motion (4x4)	1997 - 09.99											
(Ch. → 3B-WE113561)												

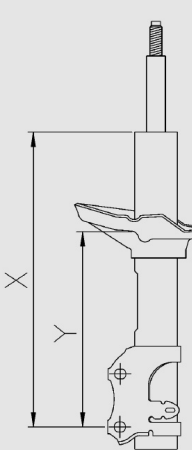

**55**

M 4409      X = 318 mm. Y = 228 mm.  
MG4409      X = 318 mm. Y = 228 mm.

M 4430      X = 340 mm. Y = 250 mm.  
MG4430      X = 340 mm. Y = 250 mm.

### POLO

excl. G40	1974 - 08.94		155		C 0301	CG0301		55		S 0302	SG0302
1.05, 1.3	09.94 - 10.01		120	<b>56</b>	M 4432	MG4432		55		S 4438	SG4438
1.4, 1.6	09.94 - 10.01										
1.7 D, 1.9 D	09.94 - 10.01										
1.9 SDi, 1.9 TDi	1996 - 10.01										
1.2, 1.4	11.01 -				M 3715	MG3715				T 4451	TG4451
1.4 TDi	11.01 -										
1.9 SDi, 1.9 TDi	11.01 -										
Classic 1.4, 1.6	11.95 -		120	<b>56</b>	M 4432	MG4432		55		S 3710	SG3710
Classic 1.7 SDi	1997 -										
Classic 1.8	1997 -										
Classic 1.9 SDi, 1.9 TDi	11.95 -										
excl. Classic S											
Classic S 1.4, 1.6	11.95 -		120	<b>56</b>		MG4411		55		S 4445	SG4445
Classic S 1.9 D, 1.9 SDi	11.95 -										
Variant	1997 -		120	<b>56</b>	M 4432	MG4432		55		S 4445	SG4445
Caddy	1995 -		120	<b>56</b>	M 4432	MG4432		40		T 3713	

**56** Vedi disegno Volkswagen Golf a pagina 129 - See drawing Volkswagen Golf on page 129

### SANTANA

	1982 - 1986		195		C 0306	CG0306		100		S 4418	SG4418
--	-------------	--	-----	--	--------	--------	--	-----	--	--------	--------

### SCIROCCO

	1974 - 1992		100		C 4401	CG4401		40		S 4402	SG4402
--	-------------	--	-----	--	--------	--------	--	----	--	--------	--------



ANTERIORE  
FRONT



POSTERIORE  
REAR

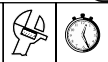

OIL

GAS

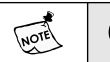
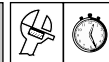

OIL

GAS

## VOLKSWAGEN

### SHARAN

4x2	02.95 -		70		M 1478	MG1478		40		T 1479	TG1479
4x4	02.95 -										

### T4 / TRANSPORTER / CARAVELLE

(incl. Syncro)	09.90 -				H 4443					H 4427	
(incl. Syncro)	09.90 -										
(incl. Syncro)	09.90 -										
Ambulanza	09.90 -										

### TARO

4x2	1989 -		60			HG4237		40			HG4240
4x4 Standard Cabine	1989 -		60			HG4241		40			HG4242
4x4 Double Cabine	1989 -										
4x4 Extra Cabine	1989 -		60			HG4243		40			HG4242

### TYPE I / MAGGIOLINO / KAFER

1.2, 1.3, 1.5	08.65 - 1967				T 4412					T 4413	TG4413
1.2 Mexico	08.65 -										
1.2, 1.3, 1.5	1967 - 1979										
1.3 1302	1970 - 1972				C 4414					T 4413	TG4413
1.5 1303	1970 - 07.73										
1.6 1302	1970 - 07.73										
(Ch. → F1333200000)											
1.5 1303 (Ch. → F1342000000)	08.73 -									T 4413	TG4413
1.5 1303	- 1979				C 4415	CG4415				T 4413	TG4413
1.6	- 1979										
1303	- 1979										
(Ch. F1342000001 →)											

### TYPE II / TRANSPORTER / CARAVELLE

,	1955 - 07.67				T 4413	TG4413				T 4413	TG4413
,	08.67 - 07.69									T 4422	
,	08.69 - 1979		60		T 4423			40		T 4422	
,  excl. Syncro	1980 - 1992		60		H 4424			40		T 4425	

### TYPE III

1.5, 1.6	1962 - 1973				T 4413	TG4413				T 4413	TG4413
1.5, 1.6	1962 - 1973										





ANTERIORE  
FRONT



POSTERIORE  
REAR

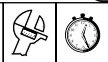

OIL

GAS

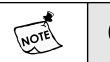
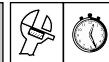

OIL

GAS

## VOLVO

### 140 SERIES

142	1966 - 08.74				T 4503	TG4503				T 4504	TG4504
144, 144 S	1966 - 08.74										
145, 145 NT	1968 - 08.74										

### 164

	1968 - 08.74				T 4503	TG4503				T 4504	TG4504
--	--------------	--	--	--	--------	--------	--	--	--	--------	--------

### 240 / 260 SERIES

excl. GTE, GLT, GLE, Turbo	1974 - 1993		105	ACC18	C 4505	CG4505		25		T 4506	TG4506
GLT, GLE	1980 - 1993		105	ACC18	C 4505	CG4505		25	<b>59</b>	T 4506	TG4506
GTE	1980 - 1993			<b>63</b>							
Turbo	1980 - 1993		105	ACC18		CG4505		25			TG4506

### 300 SERIES

340 (343, 344, 345)	1976 - 1991		130	ACC19	C 4507	CG4507		50		T 4508	TG4508
360 (343, 344, 345)	1976 - 1991										

### 440 / 460

	1988 - 1997		125		M 4509	MG4509		40		T 4510	TG4510
--	-------------	--	-----	--	--------	--------	--	----	--	--------	--------

### 480 ES

excl. Engine B18E (Ch. → 520381)	1986 - 1995		125		M 4509	MG4509		40		T 4510	TG4510
----------------------------------	-------------	--	-----	--	--------	--------	--	----	--	--------	--------

### 740

(Ch. → F0081679)	1983 - 04.84		120	ACC18	C 4511	CG4511		25	<b>60</b>	T 4512	TG4512
(Ch. F0081680 →) excl. Turbo	05.84 - 1992		120	ACC18	C 4513	CG4513		25	<b>60</b>	T 4512	TG4512
Turbo	05.84 - 1992		120	ACC18	C 4513	CG4513		25	<b>60</b>	T 4512	TG4512
Turbo	1987 - 1992		120	ACC18	C 4513	CG4513					
Turbo 16V	1987 - 1992								Nivomat		
	05.84 - 1992		120	ACC18	C 4513	CG4513		25	<b>60</b>	T 4512	TG4512

### 760

(Ch. → F0081679)	02.82 - 04.84		120	ACC18	C 4511	CG4511		25	<b>60</b>	T 4512	TG4512
(Ch. F0081680 →)	05.84 - 08.87		120	ACC18	C 4513	CG4513		25	<b>60</b>	T 4512	TG4512
	09.87 - 1992		120	ACC18	C 4513	CG4513					
	05.84 - 1990		120	ACC18	C 4513	CG4513		25	<b>60</b>	T 4512	TG4512





ANTERIORE  
FRONT



POSTERIORE  
REAR

				<b>OIL</b>	<b>GAS</b>				<b>OIL</b>	<b>GAS</b>
--	--	--	--	------------	------------	--	--	--	------------	------------

## VOLVO

### 780

	1985 - 08.87		120		C 4513	CG4513		25	<b>60</b> —	T 4512	TG4512
	09.87 - 1991		120		C 4513	CG4513			— Nivomat		

### 850

(Ch. → LS-R174999) excl. T5, R,	1991 - 1994			<b>61</b>		MG4515			excl.		TG4517
(Ch. LS-S175000 →) excl. T5, R,	1994 - 1996			<b>62</b>		MG4528			excl.		TG4517
(Ch. → LS-R174999) excl. T5, R,	1992 - 1994			<b>61</b>		MG4515			excl.		TG4517
(Ch. LS-S175000 →) excl. T5, R,	1994 - 1996			<b>62</b>		MG4528			excl.		TG4517

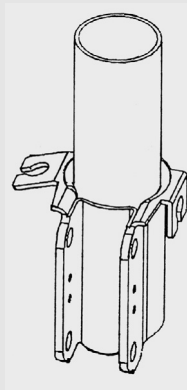

**61**  
MG4515

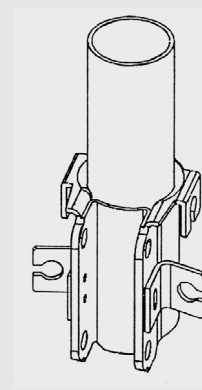

**62**  
MG4528

### 940

excl. Turbo 16V	1990 - 1996		120			CG4513		25	<b>60</b> —		TG4512
Turbo 16V	1990 - 1996		120			CG4513		25	— Nivomat		
	1990 - 1996		120			CG4513		25	<b>60</b> —		TG4512

### 960

(Ch. → YV1964-R048299)	1990 - 09.94		120			CG4513			— Nivomat		
(Ch. YV1964-R048300 →)	09.94 - 1996								— excl.		TG4520
(Ch. → YV1965-R018099)	1990 - 09.94		120			CG4513			<b>60</b> —		TG4512
(Ch. YV1965-R018100 →)	09.94 - 1996								— Nivomat		



ANTERIORE  
FRONT



POSTERIORE  
REAR



OIL

GAS



OIL

GAS

## VOLVO

### C 70

excl.	01.97 -			<b>62</b>		MG4528			excl.		TG4517
-------	---------	--	--	-----------	--	--------	--	--	-------	--	--------

**62** Vedi disegni Volvo 850 a pagina 138 - See drawings Volvo 850 on page 138

### P SERIES

(PV444, PV544)	1945 - 1966				T 4501					T 2921	
(PV444, PV544)	1945 - 1966										
(PV445, P 210 Duett)	1957 - 1969				T 4501					T 2702	
(PV445, P 210 Duett)	1957 - 1969										
,  (P 120)	1957 - 1970				T 4104					T 0120	TG0120
,  (P 130 Amazon)	1957 - 1970										
,  (P 1800)	1961 - 1973				T 4104					T 0120	TG0120
(P 220 Amazon)	1962 - 1970				T 4104					T 1704	TG1704

### S 40 / V 40

excl. Sport Susp.	05.95 - 05.99					MG4519			excl.		SG4523
excl. Sport Susp.	05.95 - 05.99					MG4524					
Sport Susp.	05.95 - 05.99					MG4525			excl.		SG4527
Sport Susp.	05.95 - 05.99					MG4526					
excl. T4, Turbo 16V, Sport Susp.	06.99 - 04.00					MG4529			excl.		SG4523
excl. T4, Turbo 16V, Sport Susp.	06.99 - 04.00					MG4530					
Sport Susp. excl. T4, Turbo 16V	06.99 - 04.00					MG4531			Nivomat		
Sport Susp. excl. T4, Turbo 16V	06.99 - 04.00					MG4532					
,  1.9 16V Turbo	06.99 - 04.00					MG4531			excl.		SG4527
,  T4 Dynamic	06.99 - 04.00					MG4532					
excl. T4, Turbo 16V, Sport Susp.	05.00 -					MG4533			excl.		TG 4537
excl. T4, Turbo 16V, Sport Susp.	05.00 -					MG4534					
Sport Susp. excl. T4, Turbo 16V	05.00 -					MG4535			Nivomat		
Sport Susp. excl. T4, Turbo 16V	05.00 -					MG4536					
,  1.9 16V Turbo	05.00 -					MG4535			excl.		TG 4538
,  T4 Dynamic	05.00 -					MG4536					

### S 60

excl.	2000 -					MG4541			excl.		TG4542
-------	--------	--	--	--	--	--------	--	--	-------	--	--------

### S 70

4x2	01.97 - 08.00			<b>62</b>		MG4528			excl.		TG4517
AWD 4x4	01.97 - 08.00										
excl. T5, R,											

**62** Vedi disegni Volvo 850 a pagina 138 - See drawings Volvo 850 on page 138

### S 80

excl.	1998 -					MG4541			excl.		TG4542
-------	--------	--	--	--	--	--------	--	--	-------	--	--------

### S 90

	1997 - 1998										TG4520
									excl.		



**ORDINI:** Gli ordini devono pervenire presso la nostra sede a mezzo fax o posta elettronica.  
Solo in via del tutto eccezionale possono essere accettati ordini verbali, in tal caso si declina ogni responsabilità per inesattezze, incomprensioni o interpretazioni errate. Tutti gli ordini sono subordinati all'approvazione da parte dell'azienda che si riserva la facoltà di accettarli.

**PREZZI:** Per tutti gli ammortizzatori a catalogo fanno fede i prezzi indicati a listino. Tutti i prezzi si intendono IVA esclusa e franco nostro stabilimento.  
L'azienda si riserva la facoltà di modificare i prezzi convenuti senza obbligo di preavviso. Invitiamo la gentile clientela a verificare tutte le condizioni indicate nella conferma d'ordine.

**CONSEGNE:** Tutti i termini di consegna del materiale ordinato, anche se indicati nella conferma d'ordine, sono da considerarsi indicativi e non impegnativi per l'azienda. I ritardi o le mancate consegne del materiale eventualmente non disponibile presso il nostro magazzino non potranno dare consenso all'annullamento dell'ordine in corso, né potranno costituire pretesto per risarcimento di danni. Eventuali deroghe alle presenti condizioni di consegna devono essere concordate ed accettate per iscritto da entrambe le parti.

**CONFEZIONAMENTO:** Tutto il materiale verrà consegnato adeguatamente confezionato, secondo gli standard previsti per l'azienda.  
Eventuali variazioni in questo senso devono essere concordate con l'ufficio commerciale e regolamentate per iscritto.  
Le spese di confezionamento si intendono addebitate al costo degli ammortizzatori.

**IMBALLO:** L'imballo verrà effettuato secondo gli standard in uso e fatturato al costo. Eventuali variazioni in tal senso devono essere preventivamente concordate per iscritto da entrambe le parti.

**SPEDIZIONE:** La merce viaggia sempre a rischio e pericolo del committente, anche se spedita in porto franco.  
In mancanza di precise indicazioni del committente tutto il materiale verrà spedito con il mezzo ritenuto più opportuno.  
La nostra responsabilità, per tutto il materiale spedito, si conclude alla consegna del medesimo al vettore.  
Eventuali danni, furti, manomissioni o quant'altro possa arrecare inconvenienti al committente vanno gestiti direttamente dallo stesso con il trasportatore.  
Il destinatario rimane comunque vincolato al pagamento totale della merce spedita.  
L'azienda non risponde per eventuali ritardi nelle consegne derivanti da cause di forza maggiore o da circostanze dipendenti dal vettore.

**RECLAMI:** Eventuali reclami, dovuti a discordanze riscontrate nella documentazione, o di qualsiasi altra natura, devono essere notificati entro e non oltre 8 giorni dalla data di ricevimento del materiale a mezzo lettera raccomandata.  
Fanno eccezione tutti i reclami considerati motivo di garanzia per i quali rimandiamo alla sezione "garanzia del prodotto".

**PAGAMENTI:** Il pagamento delle fatture deve essere fatto entro il termine prescritto ed indicato in fattura.  
Il mancato rispetto dei termini di pagamento comporterà l'addebito delle spese di insoluto e degli interessi di mora, calcolati in base al tasso EURIBOR maggiorato di 6 punti; renderà inoltre le altre fatture in corso, ancorché non scadute, immediatamente esigibili. Il mancato pagamento autorizza pure l'azienda a sospendere tutte le forniture con effetto immediato.  
I pagamenti sono validi solo se effettuati, direttamente all'azienda o a persona da noi espressamente autorizzata, secondo le disposizioni concordate con il nostro ufficio amministrativo.

**CONTROVERSIE:** Per qualsiasi controversia, nessuna esclusa, sarà competente il Foro di Treviso.

**TUTELA DELLA PRIVACY:** Tutti i dati relativi al committente, ivi compresi quelli inerenti gli ordinativi e le condizioni in uso, saranno custoditi ed elaborati, anche elettronicamente, per i soli scopi di statistica, degli adempimenti di legge e per l'invio di materiale informativo o promozionale; secondo quanto stabilito dalla legge 675/95 in materia.

Tutte le condizioni riportate, ivi incluse quelle seguenti, relative alla garanzia del prodotto, si ritengono accettate integralmente al momento del ricevimento dell'ordine, sia esso scritto o verbale.

### GARANZIA DEL PRODOTTO

L'intera gamma WKTORY è offerta con una garanzia di due anni a chilometraggio illimitato.  
Tale garanzia si ritiene subordinata alle condizioni, elencate di seguito, che l'acquirente è tenuto a verificare e rispettare durante l'intero periodo garantito.

**CONDIZIONI DI GARANZIA:** La garanzia di due anni applicata a tutti gli ammortizzatori copre esclusivamente le non conformità, verificate sugli ammortizzatori stessi, relativamente a vizi di fabbricazione e di funzionamento.  
La garanzia del prodotto, in quanto tale, vale esclusivamente nei termini di sostituzione gratuita del materiale riconosciuto difettoso.  
Tale garanzia inoltre si ritiene valida per il solo prodotto riconosciuto non conforme, pertanto non prevede estensioni a coppie o insiemi di ammortizzatori, anche se installati sul medesimo veicolo.

Non sussistono risarcimenti, o pretese di qualsiasi natura, ulteriori a quelle precedentemente espresse; anche qualora direttamente o indirettamente collegate alla non conformità del prodotto.

La garanzia non comprende:

- La normale usura dell'ammortizzatore.
- Le non conformità derivanti da incidenti, di qualsivoglia natura, subiti dal veicolo.
- I danni provocati all'ammortizzatore da un montaggio scorretto o dall'impiego di attrezzature non idonee (es. stelo rovinato dalle pinze).
- I danni provocati dall'utilizzo dell'ammortizzatore su veicoli diversi da quelli per i quali è stato realizzato, in conformità a quanto riportato sullo stesso catalogo corrente.
- I danni causati da manomissioni di qualsiasi natura effettuate all'ammortizzatore.
- Le non conformità dovute all'impiego dell'ammortizzatore su sistemi di sospensione speciali per i quali non è previsto il suo impiego (sospensioni autolivellanti, sospensioni regolabili elettronicamente, ecc.).
- I danni arrecati all'ammortizzatore dall'utilizzo del veicolo in competizioni automobilistiche di qualsiasi natura.
- I danni causati all'ammortizzatore dal montaggio su sospensioni con caratteristiche e componenti diversi dall'originale, quali ad esempio molle tagliate, tamponi e parapolvere modificati o eliminati, ecc.
- Eventuali montaggi abbinati a molle di assetto sportivo, eccezione fatta per le molle di assetto di nostra produzione e per i pacchetti sportivi forniti dalla casa produttrice.
- I danni arrecati da manutenzione scorretta o insufficiente del mezzo.

**RICHIESTA DI GARANZIA:** La richiesta di garanzia del prodotto deve essere presentata al concessionario presso il quale è stato acquistato. Il concessionario stesso provvederà direttamente, dopo l'accertamento della non conformità, alla sostituzione del materiale difettoso.

Al concessionario dovranno essere consegnati tutti i dati indispensabili alla verifica della garanzia, e più precisamente:

- Estremi dell'acquirente o dell'ufficio di montaggio.
- Articolo non conforme.
- Quantità non conforme.
- Data di acquisto e di montaggio.
- Dati di riconoscimento del veicolo.
- Condizione del veicolo al momento del montaggio.
- Descrizione dettagliata della non conformità.

Il concessionario successivamente avrà cura di trasmettere i suddetti dati all'ufficio di Controllo Qualità del produttore il quale avvierà il processo di verifica.  
Dopo l'acquisizione dei dati forniti dal cliente verrà data l'autorizzazione al reso del materiale difettoso.

Il prodotto ritenuto non conforme dovrà quindi pervenire presso di noi, in porto franco, corredato di bolla in conto garanzia (qualora il materiale non fosse spedito dal distributore la bolla dovrà recare come intestatario il distributore stesso).  
Sarà respinto tutto il materiale spedito senza il benestare a procedere da parte dell'azienda.

Il ripristino, la sostituzione o l'accredito del prodotto in garanzia sarà fatto solo dopo l'accertamento della non conformità da parte del personale tecnico addetto al controllo qualità, nel rispetto delle condizioni sopra elencate. Lo stesso personale sarà a disposizione del cliente per ogni chiarimento in merito.

La possibilità di sostituzione immediata del materiale ritenuto non conforme, al fine di evitare il fermo del veicolo, è prerogativa esclusiva del distributore, il quale può eventualmente adottarla a sua discrezione, rimanendo tuttavia non vincolata alle condizioni generali di garanzia del prodotto.

Per conoscenza segnaliamo che tutti i reclami ed i certificati di garanzia verranno archiviati, unitamente ai dati a nostra disposizione (cliente, non conformità, riferimenti produttivi, ecc.), per disporne in qualunque momento e per verificare l'utilità di azioni correttive eventualmente necessarie su alcuni prodotti.  
Tutti i dati dei clienti verranno comunque custoditi ed elaborati esclusivamente per attività informatiche e di ricerca interne all'azienda, adempimenti di legge ed eventuale invio di materiale informativo-promozionale; in conformità a quanto richiesto dalla legge 675/95 sulla tutela della privacy.



## GENERAL SALES TERMS AND CONDITIONS

### Condizioni generali di vendita

**PURCHASE ORDERS:** Orders must be forwarded to our offices by fax or e-mail. Verbal orders will be accepted only in very special conditions, in which case we shall not be held responsible for inexactness, misunderstandings or erroneous interpretation. Orders are subject to approval by our offices who reserves the right to accept them.

**PRICES:** For all shock absorbers in our catalogue the prices applied are those contained in the relevant price-lists. All prices do not include VAT and are for goods available ex-works. We reserve the right to make changes to the prices agreed without notice. We therefore invite customers to check all conditions at the time of our order confirmation.

**LEAD TIME:** All lead times provided for the goods that have been ordered, even when stated in our order confirmation, should be considered approximate and are not binding on the supplier. Any delays or failure to deliver any goods not available in our warehouses shall not entitle to cancel the order in progress and claim indemnification for damage. Any derogation to these delivery terms shall be agreed and accepted in writing by both parties.

**PACKAGING:** All the goods are delivered suitably packed, according to our company's standards. Any variations shall be agreed with our sales department and made in writing. Goods are packed by our company according to our standards and invoiced according to cost. Any variations shall be agreed in writing by both parties.

**DELIVERY:** Goods travel always at the customer's own risk and danger, even when delivered free destination. Unless specifically stated by the customer, the goods will be delivered with the means of transport we consider most appropriate. Our liability regarding all the goods dispatched ends upon their delivery to the forwarding agent. Any damage, theft, tampering with or any other inconveniences caused to the customer shall be handled by the latter with the forwarding agent. The consignee shall always pay the total amount of the goods delivered. We shall not be held responsible for any delays due to acts of God or other circumstances depending on the forwarding agent.

**COMPLAINTS:** Any complaints due to discrepancies in the documents or of any other kind, shall be notified within no later than 8 days after receipt of the goods by registered letter. This clause does not apply in case of complaints considered warranty condition regarding which please see "Product warranty" section.

**PAYMENTS:** Invoices shall be paid within the prescribed term stated in the invoice itself. Non-compliance with payment terms shall cause unsettled payment expenses to be charged together with interest for delayed payment calculated according to the EURIBOR rate plus 6% and will also make any invoices in progress immediately due even if not overdue. Any failure to settle payments authorises us to suspend all deliveries immediately. Payments are valid only if made directly to our company or to any person we have clearly authorised and as agreed with our administration.

**DISPUTES:** Disputes of any kind shall be submitted to the jurisdiction of the Court of Treviso.

**PRIVACY:** All data concerning customers, including any information concerning orders and terms applied, shall be stored and processed, even electronically, only for statistical purposes, for law prescriptions and for dispatching informative or promotional material as prescribed by relevant Privacy Italian Law 675/95.

All the conditions, including the following ones, concerning product warranty are considered accepted in full upon receipt of a written or verbal order.

#### PRODUCT WARRANTY

Our whole range of **WKTOR** is offered with a two-year warranty with unlimited mileage. The warranty above is subject to the conditions stated below that the purchaser shall check and respect for the entire warranty period.

**WARRANTY CONDITIONS:** The two-year warranty applied to shock absorbers of the "improved" range covers exclusively non-compliance assessed on the shock absorber due to manufacturing or working defects. Our product warranty as such is applied exclusively in terms of replacement free of charge of the goods acknowledged as being faulty. In addition, the warranty applies in case of the sole product acknowledged as non-conforming and therefore cannot be extended to pairs or shock absorber groups, although they may be installed on the same vehicle. No compensation or claims of any kind besides those mentioned above are acceptable even if directly or indirectly related to the non-conforming product.

The warranty does not include:

- Normal wear of the shock absorber.
- Non-compliance due to accidents of any kind involving the vehicle.
- Damage caused to the shock absorber by improper installation or by the use of unsuitable equipment (e.g. stem ruined by pincers).
- Damage caused by using the shock absorber on a vehicle other than the model the shock absorber has been made for as mentioned in our current catalogue.
- Damage caused by any kind of tampering with the shock absorber.
- Non-compliance due to the use of the shock absorber in special suspension systems in which it should not be used (self-levelling suspensions, electronically adjustable suspensions, etc.).
- Damage caused to the shock absorber by the use of the vehicle in car competitions of any kind.
- Damage caused to the shock absorber by installation on suspensions with features and components differing from the original, such as cut springs, modified or eliminated bumpers and dust bellows, etc.
- Any installation combined with sports springs, apart from our own type and from sports kits supplied by the manufacturer.
- Damage due to improper or insufficient maintenance of the vehicle.

**WARRANTY REQUEST.** The product warranty request must be forwarded to the dealer where it has been purchased. After assessing non-compliance the dealer shall replace the faulty goods immediately. It is necessary to provide the dealer with all the information needed to check the warranty, i.e.:

- Customer or installation shop details.
- Non-conforming article.
- Non-conforming quantity.
- Date of purchase and installation.
- Vehicle identification data.
- Vehicle conditions at the time of installation.
- Detailed description of non-compliance.

The dealer shall then communicate the information above to the manufacturer's Quality Control Service that will start the control process. After receiving the information provided by the customer the return of the faulty goods will be authorised.

Any products considered non-conforming shall therefore be returned to us carriage paid together with a warranty delivery note (if the goods are not returned by the distributor the delivery note shall be sent with the distributor as consignee).

Any goods returned without our approval shall be rejected.

The repair, replacement or credit for the product under warranty shall occur only once non-compliance has been assessed by our quality control technicians in the full respect of the above-mentioned conditions. Our staff is at customers' disposal for any explanations regarding these matters.

The possibility of replacing immediately the goods considered non-conforming in order to avoid stopping the vehicle depends exclusively on the distributor who proceed at his own discretion, remaining however not bound by the product general warranty conditions.

We inform you that all complaints and warranty certificates will be filed together with the information available to us (customer, non-compliance, production references, etc.), so that we can use them at any time and to assess the utility of any corrective actions required for any products.

In any case all customer data will be filed and processed only for internal information and research activities, law prescriptions and dispatch of informative and promotional material in compliance with Italian Law 675/95 concerning the safeguard of privacy.



## LISTA NUMERICA

Numerical listing - Liste numérique  
Numerisches Typenverzeichnis - Lista numérica

C 0115	ALFA ROMEO	C 2923	OPEL	CG0833	BMW	CG4207	TOYOTA	H 1104	DAF
C 0301	AUDI		VAUXHALL	CG0849	BMW	CG4208	TOYOTA	H 1105	DAF
	VOLKSWAGEN	C 2927	BEDFORD	CG0906	CITROEN	CG4209	TOYOTA	H 1106	DAF
C 0303	AUDI		DAEWOO		PEUGEOT	CG4211	TOYOTA	H 1210	DAHIATSU
	VOLKSWAGEN		OPEL	CG0907	CITROEN	CG4213	TOYOTA		NISSAN
C 0306	AUDI		VAUXHALL		PEUGEOT	CG4218	TOYOTA		SANTANA
	VOLKSWAGEN	C 3001	PEUGEOT	CG0911	CITROEN	CG4226	TOYOTA		SUZUKI
C 0326	AUDI	C 3005	PEUGEOT		PEUGEOT	CG4263	TOYOTA	H 1211	DAHIATSU
C 0802	BMW	C 3014	PEUGEOT		RENAULT	CG4268	TOYOTA		JEEP
C 0803	BMW	C 3025	PEUGEOT	CG1205	DAHIATSU	CG4271	TOYOTA		MITSUBISHI
C 0805	BMW	C 3031	PEUGEOT		TOYOTA	CG4273	TOYOTA	H 1447	FORD
C 0808	BMW	C 3032	PEUGEOT	CG1207	DAHIATSU	CG4279	TOYOTA	H 1449	FORD
C 0821	BMW		TALBOT		TOYOTA	CG4284	TOYOTA	H 1451	FORD
C 0823	BMW	C 3035	PEUGEOT	CG1401	FORD	CG4401	VOLKSWAGEN	H 1452	FORD
C 0827	BMW	C 3036	PEUGEOT	CG1409	FORD	CG4403	VOLKSWAGEN	H 1454	FORD
C 0906	CITROEN	C 3324	RENAULT	CG1705	HYUNDAI	CG4405	VOLKSWAGEN	H 1455	FORD
	PEUGEOT	C 3505	ROVER	CG1710	HYUNDAI	CG4409	VOLKSWAGEN	H 1456	FORD
C 0907	CITROEN	C 3803	SKODA	CG2103	LADA	CG4415	PORSCHE	H 1457	FORD
	PEUGEOT	C 4105	TALBOT	CG2107	LADA		VOLKSWAGEN	H 1512	FORD
C 0911	CITROEN	C 4106	TALBOT	CG2601	MITSUBISHI	CG4505	VOLVO	H 1513	FORD
	PEUGEOT	C 4208	TOYOTA	CG2804	NISSAN	CG4507	VOLVO	H 1514	FORD
	RENAULT	C 4209	TOYOTA	CG2809	NISSAN	CG4511	VOLVO	H 1901	BEDFORD
C 1204	DAHIATSU	C 4210	TOYOTA	CG2821	NISSAN	CG4513	VOLVO		ISUZU
	TOYOTA	C 4267	TOYOTA	CG2824	NISSAN	CG5007	TOYOTA		NISSAN
C 1205	DAHIATSU	C 4268	TOYOTA	CG2841	NISSAN	H 0602	CITROEN	H 1903	ISUZU
	TOYOTA	C 4401	VOLKSWAGEN	CG2854	NISSAN		FIAT	H 1904	ISUZU
C 1207	TOYOTA	C 4403	VOLKSWAGEN	CG2855	NISSAN	H 0701	BEDFORD	H 1905	ISUZU
C 1401	FORD	C 4409	VOLKSWAGEN	CG2904	OPEL		ISUZU	H 2105	LADA
C 1405	FORD	C 4414	VOLKSWAGEN		VAUXHALL		MITSUBISHI	H 2106	LADA
C 1407	FORD	C 4415	VOLKSWAGEN	CG2906	OPEL	H 0702	BEDFORD	H 2304	LAND ROVER
C 1409	FORD	C 4505	VOLVO		VAUXHALL		ISUZU	H 2305	LAND ROVER
C 1473	FORD	C 4507	VOLVO	CG2907	OPEL		MITSUBISHI	H 2306	LAND ROVER
C 1703 6	HYUNDAI	C 4511	VOLVO		VAUXHALL	H 0705	BEDFORD	H 2307	LAND ROVER
	MITSUBISHI	C 4513	VOLVO	CG2912	OPEL	H 0706	BEDFORD	H 2433	MAZDA
C 2103	LADA	CG0301	AUDI		VAUXHALL		SUZUKI	H 2434	MAZDA
C 2107	LADA		VOLKSWAGEN	CG2923	OPEL		VAUXHALL	H 2519	MERCEDES
C 2401	MAZDA	CG0303	AUDI		VAUXHALL	H 0707	BEDFORD	H 2520	MERCEDES
C 2409	MAZDA		VOLKSWAGEN	CG2927	BEDFORD		SUZUKI	H 2521	MERCEDES
C 2601	MITSUBISHI	CG0306	AUDI		DAEWOO		VAUXHALL	H 2522	MERCEDES
C 2602	MITSUBISHI		VOLKSWAGEN		OPEL		CITROEN	H 2543	MERCEDES
C 2802	NISSAN	CG0326	AUDI		VAUXHALL	H 0931	FIAT		VOLKSWAGEN
C 2804	NISSAN	CG0803	BMW	CG3001	PEUGEOT	H 0934	CITROEN	H 2544	MERCEDES
C 2813	NISSAN	CG0805	BMW	CG3014	PEUGEOT		FIAT	H 2615	MITSUBISHI
C 2848	NISSAN	CG0807	BMW	CG3032	PEUGEOT		PEUGEOT	H 2616	BEDFORD
C 2852	NISSAN	CG0808	BMW		TALBOT		TALBOT		ISUZU
C 2853	NISSAN	CG0810	BMW	CG3036	PEUGEOT	H 0935	CITROEN		MITSUBISHI
C 2904	OPEL	CG0821	BMW	CG3045	PEUGEOT		FIAT		NISSAN
	VAUXHALL	CG0823	BMW	CG3609	SAAB		PEUGEOT		TOYOTA
C 2906	OPEL	CG0825	BMW	CG3611	SAAB	H 1101	DAF	H 2618	MITSUBISHI
	VAUXHALL	CG0826	BMW	CG4201	TOYOTA		LEYLAND	H 2619	MITSUBISHI
C 2907	OPEL	CG0827	BMW	CG4203	TOYOTA	H 1102	DAF	H 2625	MITSUBISHI
	VAUXHALL	CG0830	BMW	CG4204	TOYOTA		LEYLAND	H 2625	NISSAN
C 2912	OPEL	CG0831	BMW	CG4205	TOYOTA	H 1103	DAF	H 2636	MITSUBISHI
	VAUXHALL	CG0832	BMW	CG4206	TOYOTA		LEYLAND	H 2637	MITSUBISHI

H 2650	MITSUBISHI	H 4229	TOYOTA	HG2105	LADA		NISSAN	HG4239	TOYOTA	
H 2651	MITSUBISHI	H 4258	TOYOTA	HG2106	LADA		HG2879	NISSAN	HG4240	TOYOTA
H 2653	MITSUBISHI		UMM	HG2301	LAND ROVER		HG2880	FORD		VOLKSWAGEN
H 2836	DAHIATSU	H 4283	TOYOTA		SANTANA			NISSAN	HG4241	TOYOTA
	MITSUBISHI	H 4417	VOLKSWAGEN	HG2302	ISUZU		HG2916	ISUZU		VOLKSWAGEN
	NISSAN	H 4424	VOLKSWAGEN		LAND ROVER			MAZDA	HG4242	TOYOTA
H 2862	MITSUBISHI	H 4427	VOLKSWAGEN		SANTANA			OPEL		VOLKSWAGEN
	NISSAN	H 4433	VOLKSWAGEN	HG2303	LAND ROVER		HG2924	OPEL	HG4243	TOYOTA
	TOYOTA	H 4443	VOLKSWAGEN		SANTANA			VAUXHALL		VOLKSWAGEN
H 2863	NISSAN	H 4702	LEYLAND	HG2304	LAND ROVER		HG2925	OPEL	HG4244	TOYOTA
H 2866	NISSAN	H 4801	NISSAN	HG2305	LAND ROVER			VAUXHALL	HG4245	TOYOTA
H 2867	NISSAN	H 4802	NISSAN	HG2306	LAND ROVER		HG2930	ISUZU	HG4247	TOYOTA
H 2868	NISSAN	H 5010	TOYOTA	HG2307	LAND ROVER			OPEL	HG4248	TOYOTA
H 2882	NISSAN	H 5011	TOYOTA	HG2309	LAND ROVER			VAUXHALL	HG4249	TOYOTA
H 2883	NISSAN	H 5012	TOYOTA	HG2310	LAND ROVER		HG2947	OPEL	HG4250	TOYOTA
H 2884	NISSAN	H 5401	UMM	HG2311	LAND ROVER			VAUXHALL	HG4251	TOYOTA
H 2885	NISSAN	HG0201	ARO	HG2312	LAND ROVER		HG2949	ISUZU	HG4252	TOYOTA
H 2910	BEDFORD		TOYOTA	HG2432	MAZDA			OPEL	HG4253	TOYOTA
	OPEL	HG1002	CHRYSLER	HG2436	MAZDA			VAUXHALL	HG4254	TOYOTA
H 2911	BEDFORD	HG1006	CHRYSLER	HG2438	MAZDA		HG2950	ISUZU	HG4255	TOYOTA
	OPEL	HG1208	DAHIATSU	HG2512	MERCEDES			OPEL	HG4256	TOYOTA
H 2914	ISUZU	HG1209	DAHIATSU		PEUGEOT			VAUXHALL	HG4261	TOYOTA
	OPEL	HG1210	DAHIATSU	HG2513	MERCEDES		HG2959	OPEL	HG4262	TOYOTA
H 2915	ISUZU		JEEP		PEUGEOT		HG2960	OPEL	HG4266	TOYOTA
	OPEL		MAZDA	HG2514	MERCEDES			VAUXHALL	HG4274	TOYOTA
H 2924	OPEL		MITSUBISHI	HG2515	MERCEDES		HG2961	OPEL	HG4280	TOYOTA
	VAUXHALL		NISSAN		MITSUBISHI			VAUXHALL	HG4286	TOYOTA
H 2925	OPEL		TOYOTA	HG2616	BEDFORD		HG3033	PEUGEOT	HG4805	NISSAN
	VAUXHALL	HG1213	DAHIATSU		ISUZU			TALBOT	HG5505	KIA
H 3023	PEUGEOT	HG1214	DAHIATSU		MITSUBISHI		HG3037	PEUGEOT	M 0316	AUDI
H 3033	PEUGEOT	HG1356	CITROEN		NISSAN		HG3204	GAZ		SEAT
	TALBOT		FIAT		TOYOTA		HG3358	JEEP		SKODA
H 3037	PEUGEOT		PEUGEOT	HG2617	MITSUBISHI		HG3359	JEEP		VOLKSWAGEN
H 3042	PEUGEOT	HG1383	CITROEN	HG2618	MITSUBISHI		HG3360	JEEP	M 0401	AUSTIN
H 3043	PEUGEOT		FIAT	HG2619	MITSUBISHI		HG3361	JEEP	M 0402	AUSTIN
H 3364	RENAULT		PEUGEOT	HG2623	MITSUBISHI		HG3362	JEEP	M 0405	AUSTIN
H 3365	RENAULT	HG1493	FORD		TOYOTA		HG3377	JEEP	M 0503	AUTOBIANCHI
H 3366	RENAULT	HG1494	FORD	HG2624	MITSUBISHI		HG3414	JEEP	M 0504	AUTOBIANCHI
H 3372	RENAULT	HG1495	FORD	HG2702	JEEP		HG4012	SANTANA		FIAT
H 3373	RENAULT	HG1496	FORD		MAZDA			SUZUKI		POLSKI
H 3411	OPEL	HG1638	HONDA		MOSKVITCH		HG4013	SANTANA		SEAT
	RENAULT	HG1639	HONDA		NISSAN			SUZUKI	M 0505	AUTOBIANCHI
	VAUXHALL	HG1640	HONDA	HG2829	NISSAN		HG4019	SUZUKI	M 0506	AUTOBIANCHI
H 3412	OPEL	HG1711	HYUNDAI	HG2830	NISSAN		HG4231	TOYOTA	M 0601	CITROEN
	RENAULT	HG1712	HYUNDAI	HG2831	NISSAN		HG4232	TOYOTA		FIAT
	VAUXHALL	HG1901	BEDFORD	HG2832	NISSAN		HG4233	TOYOTA	M 0608	FIAT
H 3413	OPEL		ISUZU	HG2833	NISSAN		HG4234	TOYOTA	M 0620	FIAT
	RENAULT		NISSAN	HG2835	ISUZU		HG4235	TOYOTA	M 0621	FIAT
	VAUXHALL	HG1902	ISUZU		NISSAN		HG4236	TOYOTA	M 0708	BEDFORD
H 4002	SANTANA		OPEL	HG2837	NISSAN		HG4237	TOYOTA		VAUXHALL
	SUZUKI	HG1903	ISUZU	HG2837	TOYOTA		HG4237	VOLKSWAGEN	M 0709	BEDFORD
H 4003	SANTANA		OPEL	HG2838	NISSAN		HG4238	JEEP		VAUXHALL
	SUZUKI		VAUXHALL	HG2839	NISSAN			MAZDA	M 0811	BMW
H 4228	TOYOTA	HG1904	ISUZU	HG2861	FORD			TOYOTA	M 0812	BMW

M 0815	BMW	M 1333	FIAT	M 1476	FORD		VAUXHALL	M 3386	RENAULT
M 0816	BMW		SEAT		MAZDA	M 2945	OPEL	M 3387	RENAULT
M 0914	CITROEN	M 1335	FIAT	M 1478	FORD		VAUXHALL	M 3388	RENAULT
	PEUGEOT		SEAT		SEAT	M 2948	OPEL	M 3390	RENAULT
	TALBOT		ZASTAVA		VOLKSWAGEN		VAUXHALL	M 3392	RENAULT
M 0918	CITROEN	M 1337	FIAT	M 1480	FORD	M 2951	OPEL	M 3394	RENAULT
	PEUGEOT	M 1338	FIAT	M 1482	FORD		VAUXHALL	M 3402	RENAULT
M 0920	CITROEN	M 1339	FIAT		MAZDA	M 2952	OPEL	M 3405	RENAULT
M 0932	CITROEN		LANCIA	M 1484	FORD		VAUXHALL	M 3406	RENAULT
	FIAT	M 1341	FIAT	M 1485	FORD	M 2953	OPEL	M 3407	RENAULT
	PEUGEOT	M 1349	FIAT	M 1491	FORD		VAUXHALL	M 3408	RENAULT
M 0933	CITROEN	M 1350	FIAT	M 1501	FORD	M 2954	OPEL	M 3410	RENAULT
	FIAT	M 1353	FIAT	M 1502	FORD		VAUXHALL	M 3420	RENAULT
	PEUGEOT	M 1355	CITROEN	M 1511	FORD	M 3009	PEUGEOT	M 3421	RENAULT
M 0943	CITROEN		FIAT	M 1657	HONDA	M 3010	CITROEN	M 3422	RENAULT
	FIAT		PEUGEOT	M 1658	HONDA		PEUGEOT	M 3701	SEAT
	PEUGEOT	M 1359	FIAT	M 1718	HYUNDAI	M 3011	CITROEN	M 3702	FIAT
M 0945	CITROEN	M 1360	FIAT	M 1719	HYUNDAI		PEUGEOT		SEAT
M 0946	CITROEN	M 1363	INNOCENTI	M 1720	HYUNDAI	M 3012	PEUGEOT	M 3703	SEAT
M 0948	CITROEN	M 1365	FIAT	M 1724	HYUNDAI	M 3013	PEUGEOT	M 3704	SEAT
	PEUGEOT	M 1366	CITROEN	M 1728	HYUNDAI	M 3017	PEUGEOT	M 3705	SEAT
M 0949	CITROEN		FIAT	M 1801	INNOCENTI	M 3026	PEUGEOT	M 3706	SEAT
	PEUGEOT		LANCIA	M 1802	INNOCENTI	M 3028	PEUGEOT	M 3707	SEAT
M 0952	CITROEN		PEUGEOT	M 1803	INNOCENTI	M 3038	PEUGEOT	M 3708	SEAT
	PEUGEOT	M 1372	FIAT	M 1804	INNOCENTI	M 3039	PEUGEOT	M 3803	SKODA
M 0953	CITROEN	M 1374	FIAT	M 2201	LANCIA	M 3046	PEUGEOT	M 3805	SKODA
	PEUGEOT	M 1379	FIAT		SAAB	M 3049	PEUGEOT	M 3808	SKODA
M 1201	DAHIATSU	M 1380	FIAT	M 2202	LANCIA	M 3054	PEUGEOT	M 3810	SKODA
M 1202	DAHIATSU	M 1381	FIAT	M 2203	LANCIA	M 3058	PEUGEOT	M 4014	SUZUKI
M 1308	FIAT	M 1385	CITROEN		SAAB	M 3059	PEUGEOT	M 4015	SUZUKI
	POLSKI		FIAT	M 2204	LANCIA	M 3066	PEUGEOT	M 4020	SUZUKI
	SEAT		PEUGEOT		SAAB	M 3067	PEUGEOT	M 4220	TOYOTA
M 1309	FIAT	M 1411	FORD	M 2205	LANCIA	M 3309	RENAULT	M 4221	TOYOTA
M 1310	FIAT	M 1413	FORD	M 2206	LANCIA	M 3311	RENAULT	M 4293	TOYOTA
M 1311	FIAT	M 1414	FORD	M 2403	MAZDA	M 3313	RENAULT	M 4294	TOYOTA
	POLSKI	M 1417	FORD	M 2404	MAZDA	M 3314	RENAULT	M 4409	VOLKSWAGEN
	SEAT	M 1421	FORD	M 2502	MERCEDES	M 3315	RENAULT	M 4410	SEAT
	ZASTAVA	M 1426	FORD	M 2816	NISSAN	M 3319	RENAULT		VOLKSWAGEN
M 1312	FIAT	M 1429	FORD	M 2817	NISSAN	M 3331	RENAULT	M 4430	VOLKSWAGEN
	INNOCENTI	M 1430	FORD	M 2843	NISSAN	M 3335	RENAULT	M 4432	SEAT
	POLSKI	M 1432	FORD	M 2844	NISSAN	M 3339	RENAULT		VOLKSWAGEN
	SEAT	M 1434	FORD	M 2857	NISSAN	M 3341	RENAULT	M 4441	SKODA
	ZASTAVA	M 1436	FORD	M 2858	NISSAN	M 3342	RENAULT		VOLKSWAGEN
M 1313	FIAT	M 1439	FORD	M 2859	NISSAN	M 3343	RENAULT	M 4446	VOLKSWAGEN
	SEAT	M 1441	FORD	M 2869	NISSAN	M 3344	RENAULT	M 4509	VOLVO
M 1314	FIAT	M 1442	FORD	M 2870	NISSAN	M 3347	RENAULT	M 4601	INNOCENTI
	SEAT	M 1445	FORD	M 2881	NISSAN	M 3348	RENAULT		ZASTAVA
M 1315	FIAT	M 1450	FORD	M 2917	OPEL	M 3349	RENAULT	M 4603	ZASTAVA
	SEAT	M 1453	FORD		VAUXHALL	M 3367	RENAULT	M 4604	ZASTAVA
M 1316	FIAT	M 1458	FORD	M 2932	OPEL	M 3368	RENAULT	M 4806	NISSAN
M 1317	FIAT	M 1460	FORD	M 2932	VAUXHALL	M 3379	RENAULT	M 4807	NISSAN
M 1331	FIAT	M 1461	FORD	M 2942	OPEL	M 3380	RENAULT	M 5014	TOYOTA
	INNOCENTI	M 1464	FORD		VAUXHALL	M 3383	RENAULT	M 5015	TOYOTA
M 1332	FIAT	M 1471	FORD	M 2943	OPEL	M 3385	RENAULT	M 5520	KIA



M 5521	KIA	MG0506	AUTOBIANCHI	MG1001	CHRYSLER	MG1434	FORD	MG1618	HONDA
M 5522	KIA	MG0603	FIAT	MG1003	CHRYSLER	MG1436	FORD	MG1619	HONDA
M 5523	KIA	MG0605	FIAT	MG1004	CHRYSLER	MG1439	FORD	MG1622	HONDA
M 5524	KIA	MG0606	FIAT	MG1005	CHRYSLER	MG1441	FORD	MG1623	HONDA
M 5525	KIA	MG0608	FIAT	MG1007	CHRYSLER	MG1442	FORD		ROVER
M 5526	KIA	MG0609	FIAT	MG1215	DAHIATSU	MG1445	FORD	MG1624	HONDA
M 5601	PIAGGIO	MG0611	FIAT	MG1216	DAHIATSU	MG1459	FORD		ROVER
M 5602	PIAGGIO	MG0612	FIAT	MG1308	FIAT	MG1460	FORD	MG1625	HONDA
M 5603	PIAGGIO	MG0615	FIAT		POLSKI	MG1461	FORD		ROVER
M 5604	PIAGGIO	MG0616	FIAT		SEAT	MG1464	FORD	MG1626	HONDA
M 5901	DAEWOO	MG0617	FIAT	MG1328	FIAT	MG1469	FORD	MG1627	HONDA
M 5902	DAEWOO	MG0620	FIAT		LANCIA	MG1471	FORD	MG1629	HONDA
M 5904	DAEWOO	MG0621	FIAT	MG1329	FIAT	MG1472	FORD	MG1630	HONDA
M 5905	DAEWOO	MG0811	BMW		LANCIA	MG1476	FORD	MG1631	HONDA
MG0103	ALFA ROMEO	MG0812	BMW	MG1330	FIAT		MAZDA	MG1632	HONDA
	NISSAN	MG0813	BMW		LANCIA	MG1478	FORD	MG1633	HONDA
MG0104	ALFA ROMEO	MG0814	BMW	MG1333	FIAT		SEAT	MG1634	HONDA
	NISSAN	MG0815	BMW		SEAT		VOLKSWAGEN	MG1636	HONDA
MG0105	ALFA ROMEO	MG0816	BMW	MG1335	FIAT	MG1480	FORD	MG1637	HONDA
MG0106	ALFA ROMEO	MG0817	BMW		SEAT	MG1482	FORD	MG1642	HONDA
MG0110	ALFA ROMEO	MG0818	BMW	MG1337	FIAT		MAZDA	MG1643	HONDA
MG0111	ALFA ROMEO	MG0841	BMW	MG1338	FIAT	MG1484	FORD	MG1644	HONDA
MG0112	ALFA ROMEO	MG0844	BMW	MG1339	FIAT	MG1485	FORD	MG1645	HONDA
MG0113	ALFA ROMEO	MG0847	BMW		LANCIA	MG1487	FORD	MG1646	HONDA
MG0114	ALFA ROMEO	MG0848	BMW	MG1341	FIAT	MG1488	FORD	MG1647	HONDA
MG0122	ALFA ROMEO	MG0851	BMW	MG1349	FIAT	MG1489	FORD	MG1648	HONDA
MG0123	ALFA ROMEO	MG0852	BMW	MG1350	FIAT	MG1491	FORD	MG1649	HONDA
MG0124	ALFA ROMEO	MG0853	BMW	MG1353	FIAT	MG1492	FORD	MG1650	HONDA
MG0125	ALFA ROMEO	MG0854	BMW	MG1354	FIAT	MG1501	FORD	MG1653	HONDA
MG0128	ALFA ROMEO	MG0857	BMW	MG1365	FIAT	MG1502	FORD	MG1654	HONDA
MG0129	ALFA ROMEO	MG0858	BMW	MG1366	CITROEN	MG1505	FORD	MG1655	HONDA
MG0131	ALFA ROMEO	MG0859	BMW		FIAT	MG1506	FORD	MG1656	HONDA
MG0132	ALFA ROMEO	MG0860	BMW		LANCIA	MG1508	FORD	MG1701	HYUNDAI
MG0133	ALFA ROMEO	MG0914	CITROEN		PEUGEOT	MG1509	FORD		MITSUBISHI
MG0136	ALFA ROMEO		PEUGEOT	MG1368	FIAT	MG1602	HONDA	MG1707	HYUNDAI
MG0143	ALFA ROMEO		TALBOT	MG1370	FIAT	MG1603	HONDA	MG1708	HYUNDAI
MG0144	ALFA ROMEO	MG0918	CITROEN	MG1372	FIAT	MG1604	HONDA	MG1715	HYUNDAI
MG0146	ALFA ROMEO		PEUGEOT	MG1374	FIAT	MG1605	HONDA	MG1718	HYUNDAI
MG0147	ALFA ROMEO	MG0923	CITROEN	MG1376	FIAT	MG1606	HONDA	MG1719	HYUNDAI
MG0148	ALFA ROMEO	MG0924	CITROEN	MG1378	FIAT		ROVER	MG1720	HYUNDAI
MG0148	ALFA ROMEO	MG0945	CITROEN	MG1394	FIAT	MG1607	HONDA	MG1722	HYUNDAI
MG0316	AUDI	MG0946	CITROEN		LANCIA		ROVER	MG1723	HYUNDAI
	SEAT	MG0948	CITROEN	MG1395	FIAT	MG1608	HONDA	MG1724	HYUNDAI
	SKODA		PEUGEOT	MG1411	FORD	MG1609	HONDA	MG1728	HYUNDAI
	VOLKSWAGEN	MG0949	CITROEN	MG1412	FORD		TRIUMPH	MG1732	HYUNDAI
MG0327	AUDI		PEUGEOT	MG1413	FORD	MG1610	HONDA	MG1733	HYUNDAI
MG0330	AUDI	MG0950	CITROEN	MG1414	FORD		TRIUMPH	MG2201	LANCIA
MG0401	AUSTIN		PEUGEOT	MG1417	FORD	MG1611	HONDA		SAAB
MG0402	AUSTIN	MG0951	CITROEN	MG1421	FORD		ROVER	MG2202	LANCIA
MG0504	AUTOBIANCHI		PEUGEOT	MG1429	FORD	MG1613	HONDA	MG2203	LANCIA
MG0504	FIAT	MG0952	CITROEN	MG1430	FORD	MG1614	HONDA	MG2203	SAAB
	POLSKI		PEUGEOT	MG1431	FORD	MG1615	HONDA	MG2204	LANCIA
	SEAT	MG0953	CITROEN	MG1432	FORD	MG1616	HONDA		SAAB
MG0505	AUTOBIANCHI		PEUGEOT	MG1433	FORD	MG1617	HONDA	MG2205	LANCIA



## LISTA NUMERICA

Numerical listing - Liste numérique  
Numerisches Typenverzeichnis - Lista numérica

MG2206 LANCIA	MG2452 MAZDA	MG2869 NISSAN	MG3039 PEUGEOT	MG3514 HONDA
MG2212 LANCIA	MG2453 MAZDA	MG2870 NISSAN	MG3046 PEUGEOT	ROVER
MG2213 LANCIA	MG2454 MAZDA	MG2871 NISSAN	MG3049 PEUGEOT	MG3521 ROVER
MG2214 LANCIA	MG2455 MAZDA	MG2872 NISSAN	MG3050 PEUGEOT	MG3522 ROVER
MG2215 LANCIA	MG2456 MAZDA	MG2875 NISSAN	MG3051 PEUGEOT	MG3523 ROVER
MG2218 LANCIA	MG2457 MAZDA	MG2876 NISSAN	MG3054 PEUGEOT	MG3524 ROVER
MG2220 LANCIA	MG2458 MAZDA	MG2886 NISSAN	MG3058 PEUGEOT	MG3606 SAAB
MG2221 LANCIA	MG2461 MAZDA	MG2887 NISSAN	MG3059 PEUGEOT	MG3607 SAAB
MG2222 LANCIA	MG2462 MAZDA	MG2888 NISSAN	MG3061 PEUGEOT	MG3613 SAAB
MG2223 LANCIA	MG2463 MAZDA	MG2889 NISSAN	MG3062 PEUGEOT	MG3702 FIAT
MG2232 LANCIA	MG2464 MAZDA	MG2891 NISSAN	MG3064 PEUGEOT	SEAT
MG2234 LANCIA	MG2465 MAZDA	MG2892 NISSAN	MG3065 PEUGEOT	MG3703 SEAT
MG2236 LANCIA	MG2466 MAZDA	MG2917 OPEL	MG3066 PEUGEOT	MG3704 SEAT
MG2313 LAND ROVER	MG2467 MAZDA	VAUXHALL	MG3067 PEUGEOT	MG3705 SEAT
MG2314 LAND ROVER	MG2468 MAZDA	MG2932 OPEL	MG3069 PEUGEOT	MG3803 SKODA
MG2315 LAND ROVER	MG2469 MAZDA	VAUXHALL	MG3070 PEUGEOT	MG3808 SKODA
MG2316 LAND ROVER	MG2470 MAZDA	MG2934 OPEL	MG3071 PEUGEOT	MG3810 SKODA
MG2403 MAZDA	MG2471 MAZDA	VAUXHALL	MG3072 PEUGEOT	MG3902 SUBARU
MG2404 MAZDA	MG2472 MAZDA	MG2940 OPEL	MG3072 PEUGEOT	MG3903 SUBARU
MG2405 MAZDA	MG2502 MERCEDES	VAUXHALL	MG3309 RENAULT	MG3905 SUBARU
MG2406 MAZDA	MG2508 MERCEDES	MG2941 OPEL	MG3319 RENAULT	MG3906 SUBARU
MG2407 MAZDA	MG2551 MERCEDES	VAUXHALL	MG3331 RENAULT	MG3910 SUBARU
MG2408 MAZDA	MG2552 MERCEDES	MG2942 OPEL	MG3335 RENAULT	MG3911 SUBARU
MG2411 MAZDA	MG2554 MERCEDES	VAUXHALL	MG3339 RENAULT	MG3912 SUBARU
MG2412 MAZDA	MG2603 MITSUBISHI	MG2943 OPEL	MG3347 RENAULT	MG3913 SUBARU
MG2413 FORD	PROTON	VAUXHALL	MG3348 RENAULT	MG3914 SUBARU
MAZDA	MG2605 MITSUBISHI	MG2945 OPEL	MG3349 RENAULT	MG3915 SUBARU
MG2414 FORD	MG2608 MITSUBISHI	VAUXHALL	MG3351 RENAULT	MG3916 SUBARU
MAZDA	MG2612 MITSUBISHI	MG2948 OPEL	MG3383 RENAULT	MG3917 SUBARU
MG2415 FORD	MG2620 HYUNDAI	VAUXHALL	MG3385 RENAULT	MG3918 SUBARU
MAZDA	MITSUBISHI	MG2951 OPEL	MG3386 RENAULT	MG3919 SUBARU
MG2416 FORD	MG2626 MITSUBISHI	VAUXHALL	MG3387 RENAULT	MG3920 SUBARU
MAZDA	MG2639 MITSUBISHI	MG2952 OPEL	MG3388 RENAULT	MG3921 SUBARU
MG2417 FORD	MG2640 MITSUBISHI	VAUXHALL	MG3390 RENAULT	MG3922 SUBARU
MAZDA	MG2641 MITSUBISHI	MG2953 OPEL	MG3392 RENAULT	MG3923 SUBARU
MG2422 MAZDA	MG2642 MITSUBISHI	VAUXHALL	MG3394 RENAULT	MG3924 SUBARU
MG2424 MAZDA	MG2643 MITSUBISHI	MG2954 OPEL	MG3397 RENAULT	MG3925 SUBARU
MG2427 KIA	MG2644 MITSUBISHI	VAUXHALL	MG3405 RENAULT	MG3926 SUBARU
MAZDA	MG2645 MITSUBISHI	MG2958 OPEL	MG3406 RENAULT	MG3927 SUBARU
MG2435 MAZDA	MG2646 MITSUBISHI	MG2962 OPEL	MG3407 RENAULT	MG3928 SUBARU
MG2437 MAZDA	MG2652 MITSUBISHI	MG2963 OPEL	MG3408 RENAULT	MG3929 SUBARU
MG2439 MAZDA	MG2808 NISSAN	MG2965 OPEL	MG3416 RENAULT	MG3930 SUBARU
MG2440 MAZDA	MG2815 NISSAN	MG2966 OPEL	MG3420 RENAULT	MG3931 SUBARU
MG2441 MAZDA	MG2816 NISSAN	MG3009 PEUGEOT	MG3421 RENAULT	MG3932 SUBARU
MG2442 MAZDA	MG2817 NISSAN	MG3010 CITROEN	MG3422 RENAULT	MG3933 SUBARU
MG2443 MAZDA	MG2822 NISSAN	PEUGEOT	MG3425 RENAULT	MG3934 SUBARU
MG2444 MAZDA	MG2823 NISSAN	MG3011 CITROEN	MG3426 RENAULT	MG3935 SUBARU
MG2445 MAZDA	MG2843 NISSAN	PEUGEOT	MG3427 RENAULT	MG4004 SUZUKI
MG2446 MAZDA	MG2844 NISSAN	MG3012 PEUGEOT	MG3431 RENAULT	MG4007 SUZUKI
MG2447 MAZDA	MG2845 NISSAN	MG3013 PEUGEOT	MG3432 RENAULT	MG4008 SUZUKI
MG2448 MAZDA	MG2846 NISSAN	MG3017 PEUGEOT	MG3433 RENAULT	MG4009 SUZUKI
MG2449 MAZDA	MG2857 NISSAN	MG3026 PEUGEOT	MG3502 ROVER	MG4010 SANTANA
MG2450 MAZDA	MG2858 NISSAN	MG3028 PEUGEOT	MG3503 ROVER	SUZUKI
MG2451 MAZDA	MG2859 NISSAN	MG3038 PEUGEOT	MG3507 ROVER	MG4011 SANTANA
			MG3508 ROVER	SUZUKI

MG4020 SUZUKI	MG4524 MITSUBISHI	MG5908 DAEWOO	VAUXHALL	SG0315 AUDI
MG4025 SUZUKI	VOLVO	MG5909 DAEWOO	S 2957 OPEL	SG0321 AUDI
MG4026 SUZUKI	MG4525 VOLVO	MG5910 DAEWOO	VAUXHALL	VOLKSWAGEN
MG4029 SUZUKI	MG4526 VOLVO	MG5911 DAEWOO	S 3002 PEUGEOT	SG0322 AUDI
MG4030 SUZUKI	MG4528 VOLVO	MG5912 DAEWOO	S 3004 PEUGEOT	SG0324 AUDI
MG4031 SUZUKI	MG4529 VOLVO	MG5913 DAEWOO	S 3006 PEUGEOT	SG0332 AUDI
MG4032 SUZUKI	MG4530 VOLVO	MG5914 DAEWOO	S 3015 PEUGEOT	SG0333 AUDI
MG4033 SUZUKI	MG4531 VOLVO	MG5915 DAEWOO	S 3016 PEUGEOT	SG0339 AUDI
MG4034 SUZUKI	MG4532 VOLVO	MG5916 DAEWOO	S 3018 PEUGEOT	SG0340 AUDI
MG4202 TOYOTA	MG4533 VOLVO	S 0302 AUDI	S 3322 DACIA	SG0403 AUSTIN
MG4212 TOYOTA	MG4534 VOLVO	VOLKSWAGEN	RENAULT	SG0404 AUSTIN
MG4217 TOYOTA	MG4535 VOLVO	S 0304 AUDI	S 3327 RENAULT	SG0412 AUSTIN
MG4219 TOYOTA	MG4536 VOLVO	S 0307 AUDI	S 3329 RENAULT	SG0804 BMW
MG4220 TOYOTA	MG4539 VOLVO	S 0310 AUDI	S 3330 RENAULT	SG0806 BMW
MG4221 TOYOTA	MG4541 VOLVO	S 0313 AUDI	S 3334 RENAULT	SG0820 BMW
MG4222 TOYOTA	MG4815 NISSAN	S 0314 AUDI	S 3336 RENAULT	SG0822 BMW
MG4223 TOYOTA	MG4816 NISSAN	VOLKSWAGEN	S 3337 RENAULT	SG0824 BMW
MG4224 TOYOTA	MG4817 NISSAN	S 0315 AUDI	S 3338 RENAULT	SG0828 BMW
MG4225 TOYOTA	MG4818 NISSAN	S 0403 AUSTIN	S 3346 RENAULT	SG0829 BMW
MG4264 TOYOTA	MG4819 NISSAN	S 0404 AUSTIN	S 3353 RENAULT	SG0842 BMW
MG4265 TOYOTA	MG4820 NISSAN	S 0806 BMW	S 3354 RENAULT	SG0855 BMW
MG4272 TOYOTA	MG4825 NISSAN	S 0820 BMW	S 3389 RENAULT	SG0856 BMW
MG4275 TOYOTA	MG4826 NISSAN	S 0822 BMW	S 3710 SEAT	SG0861 BMW
MG4276 TOYOTA	MG4827 NISSAN	S 0912 CITROEN	VOLKSWAGEN	SG1008 CHRYSLER
MG4277 TOYOTA	MG4828 NISSAN	S 0913 CITROEN	S 3711 SEAT	SG1418 FORD
MG4278 TOYOTA	MG5001 TOYOTA	PEUGEOT	S 3804 SKODA	SG1423 FORD
MG4281 TOYOTA	MG5002 TOYOTA	TALBOT	S 4285 TOYOTA	SG1435 FORD
MG4282 TOYOTA	MG5003 TOYOTA	S 0915 CITROEN	S 4291 TOYOTA	SG1465 FORD
MG4287 TOYOTA	MG5004 TOYOTA	PEUGEOT	S 4304 TRIUMPH	SG1468 FORD
MG4288 TOYOTA	MG5005 TOYOTA	S 0916 6 CITROEN	S 4305 TRIUMPH	SG1470 FORD
MG4293 TOYOTA	MG5006 TOYOTA	S 0919 CITROEN	S 4402 VOLKSWAGEN	SG1474 FORD
MG4294 TOYOTA	MG5014 TOYOTA	PEUGEOT	S 4404 SEAT	SG1475 FORD
MG4295 TOYOTA	MG5015 TOYOTA	S 1418 FORD	VOLKSWAGEN	SG1477 FORD
MG4296 TOYOTA	MG5018 TOYOTA	S 1423 FORD	ZASTAVA	MAZDA
MG4297 TOYOTA	MG5019 TOYOTA	S 1435 FORD	S 4418 VOLKSWAGEN	SG1481 FORD
MG4298 TOYOTA	MG5020 TOYOTA	S 1465 FORD	VOLKSWAGEN	SG1504 FORD
MG4408 SEAT	MG5021 TOYOTA	S 1474 FORD	S 4420 VOLKSWAGEN	SG1507 FORD
VOLKSWAGEN	MG5022 TOYOTA	S 1475 FORD	S 4438 VOLKSWAGEN	MAZDA
MG4409 VOLKSWAGEN	MG5023 TOYOTA	S 1477 FORD	S 4445 SEAT	SG1612 HONDA
MG4410 SEAT	MG5507 KIA	MAZDA	VOLKSWAGEN	ROVER
VOLKSWAGEN	MG5508 KIA	S 1481 FORD	S 5009 TOYOTA	SG1641 HONDA
MG4411 SEAT	MG5509 KIA	S 1504 FORD	S 5013 TOYOTA	SG1651 HONDA
VOLKSWAGEN	MG5510 KIA	S 1507 FORD	SG0135 ALFA ROMEO	SG1702 HYUNDAI
MG4430 VOLKSWAGEN	MG5511 KIA	MAZDA	SG0137 ALFA ROMEO	SG1709 HYUNDAI
MG4432 SEAT	MG5512 KIA	S 2104 LADA	SG0138 ALFA ROMEO	SG2002 JAGUAR
VOLKSWAGEN	MG5513 KIA	S 2108 LADA	SG0145 ALFA ROMEO	SG2104 LADA
MG4441 SKODA	MG5514 KIA	S 2606 MITSUBISHI	SG0302 AUDI	SG2108 LADA
VOLKSWAGEN	MG5515 KIA	S 2607 MITSUBISHI	VOLKSWAGEN	SG2421 MAZDA
MG4446 VOLKSWAGEN	MG5516 KIA	S 2611 MITSUBISHI	SG0307 AUDI	SG2423 MAZDA
MG4447 VOLKSWAGEN	MG5901 DAEWOO	S 2803 NISSAN	SG0308 AUDI	SG2426 KIA
MG4509 VOLVO	MG5902 DAEWOO	S 2820 NISSAN	SG0310 AUDI	SG2426 MAZDA
MG4515 VOLVO	MG5904 DAEWOO	S 2827 NISSAN	SG0313 AUDI	SG2428 MAZDA
MG4519 MITSUBISHI	MG5905 DAEWOO	S 2842 NISSAN	SG0314 AUDI	SG2429 MAZDA
VOLVO	MG5907 DAEWOO	S 2946 OPEL	VOLKSWAGEN	SG2430 MAZDA



## LISTA NUMERICA

Numerical listing - Liste numérique  
Numerisches Typenverzeichnis - Lista numérica

SG2459	MAZDA	SG4804	NISSAN	T 0801	BMW	T 1321	FIAT	MERCEDES	
SG2460	MAZDA	SG4808	NISSAN	T 0809	BMW	T 1322	FIAT	MITSUBISHI	
SG2549	MERCEDES	SG4821	NISSAN	T 0819	BMW	T 1323	FIAT	SAAB	
SG2550	MERCEDES	SG4822	NISSAN	T 0901	CITROEN	T 1324	FIAT	TALBOT	
SG2606	MITSUBISHI	SG5013	TOYOTA	T 0902	CITROEN	T 1326	FIAT	TOYOTA	
SG2607	MITSUBISHI	SG5506	KIA	T 0903	CITROEN	T 1334	FIAT	VOLVO	
SG2609	MITSUBISHI	SG5518	KIA	T 0904	CITROEN		SEAT	T 1706	HYUNDAI
SG2611	MITSUBISHI	SG5519	KIA	T 0905	CITROEN	T 1340	FIAT		MITSUBISHI
SG2635	MITSUBISHI	SG6003	MCC	T 0908	CITROEN	T 1343	FIAT	T 1721	HYUNDAI
SG2648	MITSUBISHI	T 0101	ALFA ROMEO		CITROEN	T 1344	IVECO	T 2101	LADA
SG2803	NISSAN	T 0102	ALFA ROMEO		PEUGEOT	T 1345	IVECO	T 2102	LADA
SG2842	NISSAN	T 0107	ALFA ROMEO	T 0909	CITROEN	T 1346	FIAT	T 2308	LAND ROVER
SG2890	NISSAN	T 0108	ALFA ROMEO	T 0910	CITROEN	T 1347	FIAT	T 2402	MAZDA
SG2893	NISSAN	T 0109	ALFA ROMEO	T 0929	CITROEN	T 1351	FIAT		NISSAN
SG2897	NISSAN	T 0116	ALFA ROMEO		PEUGEOT	T 1361	FIAT	T 2418	MAZDA
SG2898	NISSAN	T 0118	ALFA ROMEO	T 0930	CITROEN	T 1364	FIAT		NISSAN
SG2946	OPEL		NISSAN		FIAT	T 1367	CITROEN	T 2501	MERCEDES
	VAUXHALL	T 0119	ALFA ROMEO	T 0936	CITROEN		FIAT	T 2503	MERCEDES
SG2957	OPEL		TALBOT	T 0944	CITROEN		LANCIA	T 2504	MERCEDES
	VAUXHALL	T 0120	ALFA ROMEO		FIAT		PEUGEOT	T 2505	MERCEDES
SG3346	RENAULT		MAZDA		LANCIA	T 1375	FIAT	T 2524	MERCEDES
SG3354	RENAULT		SAAB		PEUGEOT		LANCIA	T 2525	MERCEDES
SG3389	RENAULT		VOLVO	T 0947	CITROEN	T 1386	IVECO	T 2526	HANOMAG
SG3391	RENAULT	T 0121	ALFA ROMEO	T 1203	DAHIATSU	T 1387	IVECO		HENSCHEL
SG3501	ROVER	T 0305	AUDI	T 1206	DAHIATSU	T 1388	IVECO		MERCEDES
SG3513	ROVER		VOLKSWAGEN	T 1212	DAHIATSU	T 1402	FORD	T 2527	MERCEDES
SG3515	ROVER	T 0312	AUDI	T 1301	FIAT	T 1403	FORD	T 2532	MERCEDES
SG3612	SAAB		AUDI		SEAT		HYUNDAI	T 2542	MERCEDES
SG3710	SEAT	T 0317	SEAT	T 1302	FIAT	T 1404	FORD		VOLKSWAGEN
	VOLKSWAGEN		SKODA		SEAT	T 1406	FORD	T 2544	MERCEDES
SG3711	SEAT		VOLKSWAGEN		BEDFORD		HYUNDAI	T 2553	MERCEDES
SG3904	SUBARU	T 0406	AUSTIN		FIAT	T 1408	FORD	T 2604	MITSUBISHI
SG3907	SUBARU	T 0407	AUSTIN		ISUZU	T 1410	FORD	T 2613	MITSUBISHI
SG4285	TOYOTA	T 0408	AUSTIN		MAZDA	T 1419	FORD	T 2614	MITSUBISHI
SG4291	TOYOTA		ROVER	T 1303	MITSUBISHI	T 1425	FORD	T 2638	MITSUBISHI
SG4402	VOLKSWAGEN	T 0409	AUSTIN		MITSUBISHI		VOLKSWAGEN	T 2701	MOSKVITCH
SG4404	SEAT		INNOCENTI		NISSAN	T 1427	FORD	T 2702	MAZDA
	VOLKSWAGEN	T 0410	AUSTIN		SEAT	T 1440	FORD		MOSKVITCH
SG4406	VOLKSWAGEN	T 0411	AUSTIN		TOYOTA	T 1443	FORD		NISSAN
SG4418	VOLKSWAGEN		INNOCENTI		TOYOTA	T 1444	FORD		TOYOTA
SG4420	VOLKSWAGEN	T 0507	AUTOBIANCHI	T 1304	FIAT	T 1447	FORD		VOLVO
SG4421	VOLKSWAGEN		FIAT		POLSKI	T 1448	FORD	T 2801	ISUZU
SG4434	SEAT	T 0508	AUTOBIANCHI		SEAT	T 1449	FORD		ISUZU
	VOLKSWAGEN		FIAT		ZASTAVA	T 1466	FORD		NISSAN
SG4437	VOLKSWAGEN	T 0509	AUTOBIANCHI	T 1305	FIAT	T 1479	FORD		TOYOTA
SG4438	VOLKSWAGEN	T 0510	AUTOBIANCHI	T 1306	FIAT		SEAT	T 2812	NISSAN
SG4445	SEAT	T 0622	FIAT		POLSKI	T 1479	VOLKSWAGEN	T 2828	NISSAN
	VOLKSWAGEN	T 0623	FIAT	T 1307	FIAT	T 1498	FORD	T 2836	NISSAN
SG4449	VOLKSWAGEN		BEDFORD		POLSKI	T 1500	FORD	T 2840	NISSAN
SG4450	VOLKSWAGEN		DAHIATSU	T 1319	FIAT	T 1503	FORD	T 2849	NISSAN
SG4523	MITSUBISHI	T 0703	MERCEDES	T 1319	SEAT	T 1659	HONDA	T 2864	NISSAN
	VOLVO		MITSUBISHI	T 1320	FIAT	T 1704	DAHIATSU	T 2865	NISSAN
SG4527	VOLVO		PORSCHE		POLSKI		HYUNDAI	T 2894	NISSAN
SG4803	NISSAN		SAAB		SEAT		ISUZU	T 2895	NISSAN

## LISTA NUMERICA

Numerical listing - Liste numérique  
Numerisches Typenverzeichnis - Lista numérica

T 2896	NISSAN	T 2955	OPEL		NISSAN	T 5903	DAEWOO	TG0624	ALFA ROMEO
T 2902	OPEL		VAUXHALL		T 3602	T 5906	DAEWOO		FIAT
	OPEL	T 2956	OPEL		T 3603	TG0101	ALFA ROMEO		LANCIA
	VAUXHALL		VAUXHALL		T 3713	TG0102	ALFA ROMEO	TG0625	FIAT
T 2903	BEDFORD	T 3008	PEUGEOT			TG0107	ALFA ROMEO		LANCIA
	ISUZU	T 3021	PEUGEOT		T 3714	TG0108	ALFA ROMEO	TG0626	FIAT
	OPEL	T 3022	PEUGEOT			TG0109	ALFA ROMEO	TG0703	BEDFORD
	VAUXHALL	T 3023	PEUGEOT			TG0117	ALFA ROMEO		DAHIATSU
T 2905	OPEL	T 3027	CITROEN		T 3801	TG0118	ALFA ROMEO		MERCEDES
	VAUXHALL		PEUGEOT		T 3802		NISSAN		MITSUBISHI
T 2908	DAEWOO	T 3040	PEUGEOT		T 3811	TG0120	MAZDA		PORSCHE
	OPEL	T 3044	PEUGEOT		T 3901		SAAB		SAAB
	VAUXHALL	T 3047	PEUGEOT		T 4001		VOLVO	TG0809	BMW
T 2909	BEDFORD	T 3048	PEUGEOT		T 4016	TG0127	ALFA ROMEO	TG0819	BMW
	OPEL	T 3052	PEUGEOT		T 4021	TG0130	ALFA ROMEO	TG0834	BMW
	VAUXHALL	T 3056	PEUGEOT		T 4022	TG0134	ALFA ROMEO	TG0835	BMW
T 2918	OPEL	T 3057	PEUGEOT		T 4101	TG0149	ALFA ROMEO	TG0840	BMW
	VAUXHALL	T 3101	POLSKI		T 4102	TG0312	AUDI	TG0843	BMW
T 2920	ISUZU	T 3201	GAZ		T 4103		MOSKVITCH	TG0850	BMW
	MAZDA		ISUZU		T 4104	TG0317	AUDI	TG0862	BMW
	OPEL		NISSAN		T 4104		SEAT	TG0908	CITROEN
	RANGER		PORSCHE		T 4104		SKODA		PEUGEOT
	TOYOTA		TOYOTA		T 4215		VOLKSWAGEN	TG0921	CITROEN
T 2921	BARKAS	T 3203	GAZ		T 4230	TG0320	AUDI		PEUGEOT
	BARKAS	T 3301	RENAULT		T 4237		SEAT	TG0936	CITROEN
	BEDFORD	T 3302	RENAULT		T 4259		VOLKSWAGEN	TG0942	CITROEN
	ISUZU	T 3303	RENAULT		T 4260	TG0323	AUDI		PEUGEOT
	MITSUBISHI	T 3304	RENAULT		T 4270		VOLKSWAGEN	TG0944	CITROEN
	NISSAN	T 3306	RENAULT		T 4302		AUDI		FIAT
	OPEL	T 3307	RENAULT		T 4412	TG0325	AUDI		LANCIA
	RANGER	T 3308	RENAULT		T 4413	TG0328	AUDI		PEUGEOT
	TOYOTA	T 3310	RENAULT		T 4416	TG0329	AUDI		
	VAUXHALL	T 3320	RENAULT		T 4422		VOLKSWAGEN	TG0947	CITROEN
	VOLVO	T 3321	RENAULT		T 4423	TG0331	AUDI	TG1206	DAHIATSU
T 2922	ISUZU	T 3322	DACIA		T 4425	TG0334	AUDI		MAZDA
	OPEL		RENAULT		T 4429	TG0335	AUDI	TG1217	DAHIATSU
	RANGER	T 3325	RENAULT		T 4436	TG0336	AUDI	TG1303	BEDFORD
	VAUXHALL	T 3326	RENAULT		T 4444	TG0337	AUDI		FIAT
T 2926	OPEL	T 3328	RENAULT			TG0338	AUDI		ISUZU
T 2928	BEDFORD	T 3328	RENAULT		T 4501	TG0341	AUDI		MAZDA
	OPEL	T 3332	RENAULT		T 4503	TG0342	AUDI		MITSUBISHI
	VAUXHALL	T 3340	RENAULT		T 4504	TG0507	AUTOBIANCHI		NISSAN
T 2929	BEDFORD	T 3345	RENAULT		T 4506		FIAT		SEAT
	OPEL	T 3350	RENAULT		T 4508	TG0508	AUTOBIANCHI		TOYOTA
	VAUXHALL	T 3352	RENAULT		T 4510		FIAT	TG1318	FIAT
T 2933	OPEL	T 3375	RENAULT		T 4512	TG0509	AUTOBIANCHI	TG1340	FIAT
	VAUXHALL	T 3384	RENAULT		T 4813	TG0510	AUTOBIANCHI		LANCIA
T 2935	OPEL	T 3395	RENAULT		T 4814	TG0607	FIAT	TG1343	FIAT
	VAUXHALL	T 3396	RENAULT		T 4901	TG0610	FIAT	TG1348	FIAT
T 2936	OPEL	T 3403	RENAULT		T 5016	TG0613	FIAT	TG1351	FIAT
T 2936	TOYOTA	T 3404	RENAULT		T 5017	TG0614	FIAT	TG1361	FIAT
	VAUXHALL	T 3409	RENAULT		T 5101	TG0618	FIAT	TG1367	CITROEN
T 2944	OPEL	T 3419	RENAULT		T 5201	TG0619	FIAT		FIAT
	VAUXHALL	T 3423	RENAULT		T 5301	TG0622	FIAT		LANCIA
	VAUXHALL	T 3601	SAAB		T 5605	TG0623	FIAT		PEUGEOT



**LISTA NUMERICA**  
 Numerical listing - Liste numérique  
 Numerisches Typenverzeichnis - Lista numérica

TG1369	FIAT	TG2505	MERCEDES		VAUXHALL	TG3073	PEUGEOT	TG4005	SUZUKI
TG1371	FIAT	TG2506	MERCEDES	TG2909	BEDFORD	TG3201	GAZ	TG4006	SUZUKI
TG1375	ALFA ROMEO	TG2507	MERCEDES		OPEL	TG3202	PORSCHE	TG4021	SUZUKI
	FIAT	TG2509	MERCEDES		VAUXHALL	TG3203	GAZ	TG4022	SUZUKI
	LANCIA	TG2510	MERCEDES	TG2913	OPEL	TG3303	RENAULT	TG4023	SUZUKI
TG1399	FIAT	TG2511	MERCEDES		VAUXHALL	TG3306	RENAULT	TG4024	SUZUKI
TG1403	FORD	TG2528	MERCEDES	TG2918	OPEL	TG3310	RENAULT	TG4027	SUZUKI
	HYUNDAI	TG2529	MERCEDES		VAUXHALL	TG3312	RENAULT	TG4028	SUZUKI
TG1404	FORD	TG2530	MERCEDES	TG2919	OPEL	TG3316	RENAULT	TG4035	SUZUKI
TG1406	FORD	TG2533	MERCEDES		VAUXHALL	TG3320	RENAULT	TG4036	SUZUKI
	HYUNDAI	TG2534	MERCEDES	TG2921	BARKAS	TG3321	RENAULT	TG4102	TALBOT
TG1410	FORD	TG2535	MERCEDES		ISUZU	TG3328	RENAULT	TG4103	TALBOT
TG1419	FORD	TG2536	MERCEDES		OPEL	TG3332	RENAULT	TG4215	TOYOTA
TG1440	FORD	TG2537	MERCEDES		RANGER	TG3333	RENAULT	TG4257	ISUZU
TG1443	FORD	TG2538	MERCEDES		TOYOTA	TG3340	RENAULT		MAZDA
TG1444	FORD	TG2539	MERCEDES		VAUXHALL	TG3345	RENAULT		RANGER
TG1463	FORD	TG2540	MERCEDES	TG2922	ISUZU	TG3350	RENAULT		TOYOTA
TG1466	FORD	TG2541	MERCEDES		OPEL	TG3355	RENAULT	TG4413	VOLKSWAGEN
TG1479	FORD	TG2544	MERCEDES		RANGER	TG3357	RENAULT	TG4436	VOLKSWAGEN
	SEAT	TG2545	MERCEDES		VAUXHALL	TG3381	RENAULT	TG4444	SKODA
	VOLKSWAGEN	TG2546	MERCEDES	TG2931	OPEL	TG3382	RENAULT		VOLKSWAGEN
TG1490	FORD	TG2547	MERCEDES		VAUXHALL	TG3384	RENAULT	TG4448	VOLKSWAGEN
TG1498	FORD	TG2548	MERCEDES	TG2933	OPEL	TG3393	RENAULT	TG4503	VOLVO
TG1500	FORD	TG2553	MERCEDES		VAUXHALL	TG3395	RENAULT	TG4504	VOLVO
TG1503	FORD	TG2604	MITSUBISHI	TG2935	OPEL	TG3396	RENAULT	TG4506	VOLVO
TG1510	FORD	TG2610	MITSUBISHI		VAUXHALL	TG3398	RENAULT	TG4508	VOLVO
TG1704	DAHIATSU	TG2614	MITSUBISHI	TG2936	OPEL	TG3401	RENAULT	TG4510	VOLVO
	HYUNDAI	TG2621	HYUNDAI		TOYOTA	TG3404	RENAULT	TG4512	VOLVO
	ISUZU		MITSUBISHI		VAUXHALL	TG3409	RENAULT	TG4517	VOLVO
	MERCEDES	TG2622	MITSUBISHI	TG2939	OPEL	TG3415	RENAULT	TG4520	VOLVO
	MITSUBISHI		TOYOTA		VAUXHALL	TG3417	RENAULT	TG4537	VOLVO
	SAAB	TG2647	MITSUBISHI	TG2944	OPEL	TG3419	RENAULT	TG4538	VOLVO
	SANTANA	TG2649	MITSUBISHI		VAUXHALL	TG3423	RENAULT	TG4540	VOLVO
	SUZUKI	TG2801	ISUZU	TG2955	OPEL	TG3424	RENAULT	TG4542	VOLVO
	TOYOTA		NISSAN		VAUXHALL	TG3428	RENAULT	TG4543	VOLVO
	VOLVO		TOYOTA	TG2956	OPEL	TG3429	RENAULT	TG4809	NISSAN
TG1706	HYUNDAI	TG2819	NISSAN		VAUXHALL	TG3430	RENAULT	TG4810	NISSAN
	MITSUBISHI	TG2828	NISSAN	TG2964	OPEL	TG3506	ROVER	TG4811	NISSAN
TG1721	HYUNDAI	TG2836	NISSAN	TG2967	OPEL	TG3518	ROVER	TG4812	NISSAN
TG1726	HYUNDAI	TG2840	NISSAN	TG3008	PEUGEOT	TG3519	ROVER	TG4823	NISSAN
TG1727	HYUNDAI	TG2847	NISSAN	TG3020	CITROEN	TG3520	ROVER	TG4824	NISSAN
TG1729	HYUNDAI	TG2849	NISSAN		PEUGEOT	TG3601	SAAB	TG5008	TOYOTA
TG1730	HYUNDAI	TG2850	NISSAN	TG3027	CITROEN	TG3602	NISSAN	TG5016	TOYOTA
TG1731	HYUNDAI	TG2856	NISSAN		PEUGEOT		SAAB	TG5017	TOYOTA
TG2001	JAGUAR	TG2860	NISSAN	TG3029	PEUGEOT		SANTANA	TG5517	KIA
TG2101	LADA	TG2902	OPEL	TG3040	PEUGEOT		SUZUKI	TG5701	SSANG YONG
TG2102	LADA		VAUXHALL	TG3047	PEUGEOT	TG3603	SAAB	TG5702	SSANG YONG
TG2224	LANCIA	TG2903	ISUZU	TG3052	PEUGEOT	TG3604	SAAB	TG5703	SSANG YONG
TG2235	LANCIA		OPEL	TG3053	PEUGEOT	TG3605	SAAB	TG5704	SSANG YONG
TG2317	LAND ROVER		VAUXHALL	TG3056	PEUGEOT	TG3608	SAAB	TG5903	DAEWOO
TG2318	LAND ROVER	TG2905	OPEL	TG3057	PEUGEOT	TG3610	SAAB	TG5906	DAEWOO
TG2319	LAND ROVER		VAUXHALL	TG3060	PEUGEOT	TG3809	SKODA	TG6001	MCC
TG2503	MERCEDES	TG2908	DAEWOO	TG3063	PEUGEOT	TG3811	SKODA	TG6002	MCC
TG2504	MERCEDES		OPEL	TG3068	PEUGEOT	TG3901	SUBARU	TG6004	MCC



**LISTA NUMERICA**  
 Numerical listing - Liste numérique  
 Numerisches Typenverzeichnis - Lista numérica

**ARTICOLI NUOVI**

New part number - Nouvelle référence  
 Neue Stoßdämpfer - Nuevo número de pieza

**ARTICOLI IN FASE DI REALIZZAZIONE**

Item shortly available - Article disponible à bref délai  
 In Kürze verfügbarer Artikel - Artículo disponible dentro de un rato de tiempo

**ARTICOLI AD ESAURIMENTO**

Until stocks depleted - Jusqu'à épuisement du stock  
 Bis bestände aufgebraucht - Hasta agotar existencias

CG0849	MG5901	M 0620	MG2447	MG4034	T 0622	C 1703	S 4305
H 2618	MG5902	M 0621	MG2448	MG4529	T 0623	C 4105	T 2402
H 2619	S 4291	M 5520	MG2449	MG4530	TG0149	CG1401	T 2701
M 0945	S 5013	M 5521	MG2450	MG4531	TG0336	CG3001	T 3301
M 0946	SG1641	M 5522	MG2451	MG4532	TG0337	CG3014	T 3325
M 0948	SG3612	M 5523	MG2452	MG4533	TG0338	H 1102	T 3326
M 0949	SG4434	M 5524	MG2453	MG4534	TG0618	H 2434	T 3602
M 0952	SG5013	M 5525	MG2454	MG4535	TG0619	H 2868	TG1410
M 0953	T 0944	M 5526	MG2455	MG4536	TG0622	MG1353	TG4102
M 1728	T 0947	MG0148	MG2456	MG4539	TG0623	S 0912	TG4103
M 3058	T 2553	MG0615	MG2457	MG4815	TG0624	S 0916	TG4503
M 3059	T 3423	MG0616	MG2458	MG4816	TG0625	S 3334	TG4504
M 3066	T 3811	MG0617	MG2461	MG4817	TG0626	S 3337	
M 3067	T 5016	MG0620	MG2462	MG4818	TG1729		
M 3420	T 5017	MG0621	MG2463	MG4819	TG1730		
M 3421	T 5903	MG0853	MG2464	MG4820	TG1731		
M 3422	TG0614	MG0854	MG2639	MG5018	TG2235		
M 3810	TG0944	MG0857	MG2640	MG5019	TG2317		
M 4603	TG0947	MG0858	MG2641	MG5507	TG2318		
M 4604	TG2553	MG0859	MG2642	MG5508	TG2319		
M 5014	TG3060	MG0860	MG2643	MG5509	TG2647		
M 5015	TG3063	MG1642	MG2644	MG5510	TG2649		
M 5901	TG3423	MG1643	MG2645	MG5511	TG2967		
M 5902	TG3520	MG1644	MG2646	MG5512	TG4035		
MG0945	TG3811	MG1645	MG2871	MG5513	TG4036		
MG0946	TG4028	MG1646	MG2872	MG5514	TG4537		
MG0948	TG5016	MG1647	MG2875	MG5515	TG4538		
MG0949	TG5017	MG1648	MG2876	MG5516	TG4540		
MG0950	TG5903	MG1649	MG2965	MG5907	TG4823		
MG0951		MG1650	MG2966	MG5908	TG5517		
MG0952		MG1653	MG3426	MG5909	TG5703		
MG0953		MG1654	MG3427	MG5910	TG5704		
MG1365		MG1715	MG3523	MG5911			
MG1728		MG1722	MG3613	MG5912			
MG3058		MG1723	MG3922	MG5913			
MG3059		MG1732	MG3923	MG5914			
MG3061		MG1733	MG3924	MG5915			
MG3062		MG2234	MG3925	MG5916			
MG3064		MG2236	MG3926	SG0855			
MG3065		MG2313	MG3927	SG0856			
MG3066		MG2314	MG3928	SG0861			
MG3067		MG2315	MG3929	SG1651			
MG3420		MG2316	MG3930	SG2459			
MG3421		MG2439	MG3931	SG2460			
MG3422		MG2440	MG3932	SG2648			
MG3425		MG2441	MG3933	SG4449			
MG3810		MG2442	MG3934	SG4450			
MG4029		MG2443	MG3935	SG4821			
MG4030		MG2444	MG4031	SG4822			
MG5014		MG2445	MG4032	SG5518			
MG5015		MG2446	MG4033	SG5519			

**ARTICOLI NON DISPONIBILI**

Not available item - Article non disponible  
Nicht verfügbarer Artikel - Artículo no disponible

H 1512	MG1661	MG4541	TG3073
H 1513	MG1662	MG4825	TG3381
H 1514	MG2237	MG4826	TG3382
H 2650	MG2238	MG4827	TG3428
H 2651	MG2465	MG4828	TG3429
H 2653	MG2466	MG5020	TG3430
M 0629	MG2467	MG5021	TG3436
M 0708	MG2468	MG5022	TG3437
M 0709	MG2469	MG5023	TG3716
M 1511	MG2470	S 3439	TG4448
M 1657	MG2471	SG0332	TG4451
M 1658	MG2472	SG0333	TG4542
M 1803	MG2551	SG0339	TG4543
M 1804	MG2552	SG0340	TG4824
M 3379	MG2554	SG3439	TG6001
M 3380	MG2555	SG3513	TG6002
M 3438	MG2626	SG4808	TG6004
M 3715	MG2652	SG6003	
M 4446	MG2968	T 1659	
M 4806	MG3069	T 3716	
M 4807	MG3070	T 4451	
MG0122	MG3071	TG0331	
MG0123	MG3072	TG0334	
MG0330	MG3431	TG0335	
MG0603	MG3432	TG0341	
MG0627	MG3433	TG0342	
MG0628	MG3434	TG0862	
MG1215	MG3435	TG1217	
MG1216	MG3438	TG1490	
MG1472	MG3521	TG1510	
MG1488	MG3522	TG1652	
MG1489	MG3715	TG1660	
MG1508	MG4281	TG2547	
MG1509	MG4282	TG2548	
MG1655	MG4446	TG2969	
MG1656	MG4447	TG3068	

**ARTICOLI SOSTITUITI**

Superseded part numbers - Références remplacées  
Artikel ersetzt - Referencia sustituida

C 0309	→	C 0306	MG3712	→	MG4432
C 0311	→	C 0326	MG3908	→	MG3927 + MG3928
CG0309	→	CG0306	MG3908	→	MG3931 + MG3932
CG0311	→	CG0326	MG3909	→	MG3929 + MG3930
H 3021	→	T 3021	MG3909	→	MG3933 + MG3934
H 3022	→	T 3022	MG4017	→	MG4031 + MG4032
H 3041	→	H 3043	MG4018	→	MG4033 + MG4034
H 4426	→	H 4443	S 4292	→	S 4291
M 0327	→	MG0327	SG0140	→	SG0138
M 0926	→	M 0952 + M 0953	SG0845	→	SG0842
M 0941	→	M 0948 + M 0949	SG1498	→	TG1498
M 1325	→	M 0608	SG1499	→	SG1507
M 1342	→	M 1341	SG3356	→	SG3354
M 1357	→	M 1359	SG4292	→	SG4291
M 1358	→	M 1360	SG5009	→	S 5009
M 1725	→	M 1724	T 1804	→	M 1804
M 3055	→	M 3066 + M3067	TG0846	→	TG0843
M 3397	→	MG3397	TG1377	→	TG1399
M 3418	→	M 3394	TG1392	→	TG1399
M 3712	→	M 4432	TG1483	→	TG1490
M 4010	→	MG4010			
M 4011	→	MG4011			
MG0126	→	MG0114			
MG0137	→	SG0137			
MG0139	→	SG0137			
MG0141	→	MG0103			
MG0142	→	MG0104			
MG0926	→	MG0952 + MG0953			
MG0928	→	MG0950 + MG0951			
MG0941	→	MG0948 + MG0949			
MG1342	→	MG1341			
MG1393	→	MG1394			
MG1398	→	MG0608			
MG1486	→	MG1461			
MG1497	→	MG1501 + MG1502			
MG1620	→	MG3514			
MG1635	→	MG1606			
MG1714	→	MG1732 + MG1733			
MG1716	→	MG1722 + MG1723			
MG1717	→	MG1732 + MG1733			
MG1725	→	MG1724			
MG2225	→	MG1339			
MG2231	→	MG2232			
MG2425	→	MG2427			
MG2877	→	MG2875			
MG2878	→	MG2876			
MG3055	→	MG3066 + MG3067			
MG3400	→	MG3420 + MG3421			
MG3418	→	MG3394			
MG3516	→	MG1624			
MG3517	→	MG1623			

**ARTICOLI ELIMINATI**

Discontinued part numbers - Références hors production  
Artikel ausser Produktion - Referencia agotada

C 2703	MG1389
H 4704	MG1713
HG5801	SG0318
HG5802	SG0319
M 1362	T 2704
M 2226	TG1427
M 2227	TG2233
M 2228	TG4514
M 2229	







**1** Vedi disegno Alfa Romeo 33 a pagina 1.

See drawing Alfa Romeo 33 on page 1.  
Voir plan Alfa Romeo 33 à la page 1.  
Siehe Alfa Romeo 33 Zeichnung auf Seite 1.  
Ver dibujo Alfa Romeo 33 a la página 1.

**2** Vedi disegno Alfa Romeo 33 a pagina 1.

See drawing Alfa Romeo 33 on page 1.  
Voir plan Alfa Romeo 33 à la page 1.  
Siehe Alfa Romeo 33 Zeichnung auf Seite 1.  
Ver dibujo Alfa Romeo 33 a la página 1.

**3** Il cuscinetto a rulli originale deve essere sostituito con un cuscinetto a sfere art. 142040.

The original needle-bearing has to be replaced by bearing Nr. 142040.  
Le roulement à aiguilles d'origine doit être remplacé par un roulement à billes réf. 142040.  
Beim Einsatz von Federbeinen, muss das vorhandene Naddellager am Federbein durch ein Kugellager Nr. 142040 ersetzt werden.  
El rodamiento de agujas debe sustituirse por el rodamiento n° 142040.

**4** Vedi disegno Alfa Romeo 164 a pagina 3.

See drawing Alfa Romeo 164 on page 3.  
Voir plan Alfa Romeo 164 à la page 3.  
Siehe Alfa Romeo 164 Zeichnung auf Seite 3.  
Ver dibujo Alfa Romeo 164 a la página 3.

**5** Vedi disegno Alfa Romeo 164 a pagina 3.

See drawing Alfa Romeo 164 on page 3.  
Voir plan Alfa Romeo 164 à la page 3.  
Siehe Alfa Romeo 164 Zeichnung auf Seite 3.  
Ver dibujo Alfa Romeo 164 a la página 3.

**6** Per i modelli dal 1976 al 1978 sostituire l'ammortizzatore ed il parapolvere con

**Audi art. 431-412-131F e art. 431-412-135.**

For 76-78 models, replace bumper and dust shield with  
Audi Nr. 431-412-131F and 431-412-135.  
Pour les modèles de 76 à 78, remplacez la butée et la chace-poussière par  
Audi N° 431-412-131F et 431-412-135.  
Für Modelle 76-78, puffer und staubkappe durch  
Audi Nr. 431-412-131F und 431-412-135 ersetzen.  
En los modelos 76-78, sustituya el parachoques y el obturador antipolvo por la pieza  
Audi n° 431-412-131F y 431-412-135.

**7** Vedi disegno Austin Maestro anteriore a pagina 7.

See drawing of front side Austin Maestro on page 7.  
Voir plan Austin Maestro partie avant à la page 7.  
Siehe Austin Maestro vordere Zeichnung auf Seite 7.  
Ver dibujo anterior Austin Maestro a la página 7.

**8** Vedi disegno Austin Maestro posteriore a pagina 7.

See drawing of rear side Austin Maestro on page 7.  
Voir plan Austin Maestro partie arrière à la page 7.  
Siehe Austin Maestro hintere Zeichnung auf Seite 7.  
Ver dibujo posterior Austin Maestro a la página 7.

**9** Se il veicolo è munito di un correttore di assetto autolivellante, sostituire la molla con una Austin art. NAM6271 e l'anello con uno Austin art. NAM3580.

If the vehicle is equipped with a self-levelling suspension, replace the spring by a Austin one Nr. NAM6271 and collar Nr. NAM3580.  
Si le Véhicule est équipé d'un correcteur d'assiette, remplacez le ressort par un Austin réf. NAM6271 et bague NAM3580.  
Wenn das Fahrzeug mit automatischem Niveau-Ausgleich-System versehen ist, Originalfeder durch Austin Feder Nr. NAM6271 und Ringe NAM3580 ersetzen.  
Si el B156 autonivelada, sustituya el muelle por un muelle Austin n° NAM6271 y arandela n° NAM3580.

**10** Da impiegare su montante Mac-Pherson originale di diametro esterno 51 mm.

Fits vehicles with outside strut diameter of 51 mm.  
Pour une jambe dont le diamètre extérieur est de 51 mm.  
Bei einem äusseren Federbeindurchmesser von 51 mm. verwenden.  
Para vehiculos con diámetro exterior de columna de 51 mm.

**11** Da impiegare su montante Mac-Pherson originale di diametro esterno 45 mm.

Fits vehicles with outside strut diameter of 45 mm.  
Pour une jambe dont le diamètre extérieur est de 45 mm.  
Bei einem äusseren Federbeindurchmesser von 45 mm. verwenden.  
Para vehiculos con diámetro exterior de columna de 45 mm.

**12** Vedi disegno BMW 3 Series E36 a pagina 11.

See drawing BMW 3 Series E36 on page 11.  
Voir plan BMW 3 Series E36 à la page 11.  
Siehe BMW 3 Series E36 Zeichnung auf Seite 11.  
Ver dibujo BMW 3 Series E36 a la página 11.

**13** Vedi disegno BMW 3 Series E36 a pagina 11.

See drawing BMW 3 Series E36 on page 11.  
Voir plan BMW 3 Series E36 à la page 11.  
Siehe BMW 3 Series E36 Zeichnung auf Seite 11.  
Ver dibujo BMW 3 Series E36 a la página 11.

**14** Vedi disegno BMW 3 Series E36 a pagina 11.

See drawing BMW 3 Series E36 on page 11.  
Voir plan BMW 3 Series E36 à la page 11.  
Siehe BMW 3 Series E36 Zeichnung auf Seite 11.  
Ver dibujo BMW 3 Series E36 a la página 11.

**15** Vedi disegno BMW 3 Series E36 a pagina 11.

See drawing BMW 3 Series E36 on page 11.  
Voir plan BMW 3 Series E36 à la page 11.  
Siehe BMW 3 Series E36 Zeichnung auf Seite 11.  
Ver dibujo BMW 3 Series E36 a la página 11.

**16** Vedi disegno BMW 5 Series E34 a pagina 13.

See drawing BMW 5 Series E34 on page 13.  
Voir plan BMW 5 Series E34 à la page 13.  
Siehe BMW 5 Series E34 Zeichnung auf Seite 13.  
Ver dibujo BMW 5 Series E34 a la página 13.

**17** Vedi disegno BMW 5 Series E34 a pagina 13.

See drawing BMW 5 Series E34 on page 13.  
Voir plan BMW 5 Series E34 à la page 13.  
Siehe BMW 5 Series E34 Zeichnung auf Seite 13.  
Ver dibujo BMW 5 Series E34 a la página 13.

**18** Vedi disegno BMW 5 Series E34 a pagina 13.

See drawing BMW 5 Series E34 on page 13.  
Voir plan BMW 5 Series E34 à la page 13.  
Siehe BMW 5 Series E34 Zeichnung auf Seite 13.  
Ver dibujo BMW 5 Series E34 a la página 13.

**19** Vedi disegno BMW 5 Series E34 a pagina 13.

See drawing BMW 5 Series E34 on page 13.  
Voir plan BMW 5 Series E34 à la page 13.  
Siehe BMW 5 Series E34 Zeichnung auf Seite 13.  
Ver dibujo BMW 5 Series E34 a la página 13.

**20** Per le versioni GTE utilizzare la sede molla Audi art. 823-512-113.

Use Audi spring seat Nr. 823-512-113 for GTE models.  
Utiliser la coupelle Audi réf. 823-512-113 pour le modèle GTE.  
Für GTE ausführungen der Audi federsitzsteller Nr. 823-512-113 zu verwenden.  
En los modelos GTE utilice el asiento de muelle Audi n° 823-512-113 .

**21** Vedi disegno Fiat Ducato a pagina 23.

See drawing Fiat Ducato on page 23.  
Voir plan Fiat Ducato à la page 23.  
Siehe Fiat Ducato Zeichnung auf Seite 23.  
Ver dibujo Fiat Ducato a la página 23.

**22** Vedi disegno Ford Fiesta anteriore a pagina 29.

See drawing of front side Ford Fiesta on page 29.  
Voir plan Ford Fiesta partie avant à la page 29.  
Siehe Ford Fiesta vordere Zeichnung auf Seite 29.  
Ver dibujo anterior Ford Fiesta a la página 29.

**23** Vedi disegno Ford Fiesta anteriore a pagina 29.

See drawing of front side Ford Fiesta on page 29.  
Voir plan Ford Fiesta partie avant à la page 29.  
Siehe Ford Fiesta vordere Zeichnung auf Seite 29.  
Ver dibujo anterior Ford Fiesta a la página 29.

**24** Vedi disegno Ford Fiesta posteriore a pagina 29.

See drawing of rear side Ford Fiesta on page 29.  
Voir plan Ford Fiesta partie arrière à la page 29.  
Siehe Ford Fiesta hintere Zeichnung auf Seite 29.  
Ver dibujo posterior Ford Fiesta a la página 29.

**25** Vedi disegno Ford Fiesta posteriore a pagina 29.

See drawing of rear side Ford Fiesta on page 29.  
Voir plan Ford Fiesta partie arrière à la page 29.  
Siehe Ford Fiesta hintere Zeichnung auf Seite 29.  
Ver dibujo posterior Ford Fiesta a la página 29.

**26** Vedi disegno Ford Escort anteriore a pagina 28.

See drawing of front side Ford Escort on page 28.  
Voir plan Ford Escort partie avant à la page 28.  
Siehe Ford Escort vordere Zeichnung auf Seite 28.  
Ver dibujo anterior Ford Escort a la página 28.

**27** Vedi disegno Ford Escort anteriore a pagina 28.

See drawing of front side Ford Escort on page 28.  
Voir plan Ford Escort partie avant à la page 28.  
Siehe Ford Escort vordere Zeichnung auf Seite 28.  
Ver dibujo anterior Ford Escort a la página 28.

**28** Vedi disegno Ford Escort anteriore a pagina 28.

See drawing of front side Ford Escort on page 28.  
Voir plan Ford Escort partie avant à la page 28.  
Siehe Ford Escort vordere Zeichnung auf Seite 28.  
Ver dibujo anterior Ford Escort a la página 28.

**29** Vedi disegno Ford Escort posteriore a pagina 28.

See drawing of rear side Ford Escort on page 28.  
Voir plan Ford Escort partie arrière à la page 28.  
Siehe Ford Escort hintere Zeichnung auf Seite 28.  
Ver dibujo posterior Ford Escort a la página 28.

**30** Se il veicolo è munito di un correttore di assetto autolivellante, sostituire la molla con una Rover art. GSV 1034.

If the vehicle is equipped with a self-levelling suspension, replace the spring by a Rover one Nr. GSV 1034.  
Si le véhicule est équipé d'un correcteur d'assiette, remplacez le ressort par un Rover réf. GSV 1034.  
Wenn das fahrzeug mit automatischem niveau-ausgleich-system versehen ist, originalfeder durch Rover feder Nr. GSV 1034 ersetzen.  
Si el B288 autonivelada, sustituya el muelle por un muelle Rover n° GSV 1034.

**31** Se il veicolo è munito di un correttore di assetto autolivellante, sostituire la molla con una Ford art. 83 BB 5560 RC.

If the vehicle is equipped with a self-levelling suspension, replace the spring by a Ford one Nr. 83 BB 5560 RC.  
Si le véhicule est équipé d'un correcteur d'assiette, remplacez le ressort par un Ford réf. 83 BB 5560 RC.  
Wenn das fahrzeug mit automatischem niveau-ausgleich-system versehen ist, originalfeder durch Ford feder Nr. 83 BB 5560 RC ersetzen.  
Si el vehiculo está equipado con suspensión autonivelada, sustituya el muelle por un muelle Ford n° 83 BB 5560 RC.

**32** Vedi disegno Peugeot 104 a pagina 78.

See drawing Peugeot 104 on page 78.  
Voir plan Peugeot 104 à la page 78.  
Siehe Peugeot 104 Zeichnung auf Seite 78.  
Ver dibujo Peugeot 104 a la página 78.

**33 Vedi disegno Hyundai Accent a pagina 35.**

See drawing Hyundai Accent on page 35.  
Voir plan Hyundai Accent à la page 35.  
Siehe Hyundai Accent Zeichnung auf Seite 35.  
Ver dibujo Hyundai Accent a la página 35.

**34 Vedi disegno Hyundai Accent a pagina 35.**

See drawing Hyundai Accent on page 35.  
Voir plan Hyundai Accent à la page 35.  
Siehe Hyundai Accent Zeichnung auf Seite 35.  
Ver dibujo Hyundai Accent a la página 35.

**35 Vedi disegno Iveco Daily a pagina 38.**

See drawing Iveco Daily on page 38.  
Voir plan Iveco Daily à la page 38.  
Siehe Iveco Daily Zeichnung auf Seite 38.  
Ver dibujo Iveco Daily a la página 38.

**36 Questo veicolo monta posteriormente quattro ammortizzatori.**

Vehicle with 4 rear shock absorbers.  
Véhicule qui monte 4 amortisseurs arrière.  
An diesem Fahrzeug sind hinten 4 Stoßdämpfer montiert.  
Este vehículo cuenta con 4 amortiguadores en el lato trasero.

**37 Vedi disegno Veicoli Industriali Mercedes a pagina 56.**

See drawing commercial vehicle Mercedes on page 56.  
Voir plan camionette Mercedes à la page 56.  
Siehe Mercedes L.K.V. Zeichnung auf Seite 56.  
Ver dibujo Mercedes camión ligero a la página 56.

**38 Vedi disegno Nissan Almera anteriore a pagina 64.**

See drawing of front side Nissan Almera on page 64.  
Voir plan Nissan Almera partie avant à la page 64.  
Siehe Nissan Almera vordere Zeichnung auf Seite 64.  
Ver dibujo anterior Nissan Almera a la página 64.

**39 Vedi disegno Nissan Almera posteriore a pagina 64.**

See drawing of rear side Nissan Almera on page 64.  
Voir plan Nissan Almera partie arrière à la page 64.  
Siehe Nissan Almera hintere Zeichnung auf Seite 64.  
Ver dibujo posterior Nissan Almera a la página 64.

**40 Vedi disegno Nissan Primera a pagina 69.**

See drawing Nissan Primera on page 69.  
Voir plan Nissan Primera à la page 69.  
Siehe Nissan Primera Zeichnung auf Seite 69.  
Ver dibujo Nissan Primera a la página 69.

**41 Vedi disegno Renault Clio anteriore a pagina 87.**

See drawing of front side Renault Clio on page 87.  
Voir plan Renault Clio partie avant à la page 87.  
Siehe Renault Clio vordere Zeichnung auf Seite 87.  
Ver dibujo anterior Renault Clio a la página 87.

**42 Vedi disegno Renault Clio anteriore a pagina 87.**

See drawing of front side Renault Clio on page 87.  
Voir plan Renault Clio partie avant à la page 87.  
Siehe Renault Clio vordere Zeichnung auf Seite 87.  
Ver dibujo anterior Renault Clio a la página 87.

**43 Vedi disegno Renault Clio anteriore a pagina 87.**

See drawing of front side Renault Clio on page 87.  
Voir plan Renault Clio partie avant à la page 87.  
Siehe Renault Clio vordere Zeichnung auf Seite 87.  
Ver dibujo anterior Renault Clio a la página 87.

**44 Vedi disegno montaggio Renault Clio anteriore a pagina 87.**

See fitting diagram of front side Renault Clio on page 87.  
Voir plant d'installation Renault Clio partie avant à la page 87.  
Siehe Montagezeichnung Renault Clio auf Seite 87.  
Ver dibujo de montaje anterior Renault Clio a la página 87.

**45 Vedi disegno Renault Laguna a pagina 89.**

See drawing Renault Laguna on page 89.  
Voir plan Renault Laguna à la page 89.  
Siehe Renault Laguna Zeichnung auf Seite 89.  
Ver dibujo Renault Laguna a la página 89.

**46 Vedi disegno Renault Laguna a pagina 89.**

See drawing Renault Laguna on page 89.  
Voir plan Renault Laguna à la page 89.  
Siehe Renault Laguna Zeichnung auf Seite 89.  
Ver dibujo Renault Laguna a la página 89.

**47 Vedi disegno Renault Super 5 a pagina 92.**

See drawing Renault Super 5 on page 92.  
Voir plan Renault Super 5 à la page 92.  
Siehe Renault Super 5 auf Seite 92.  
Ver dibujo Renault Super 5 a la página 92.

**48 Vedi disegno Renault Super 5 a pagina 92.**

See drawing Renault Super 5 on page 92.  
Voir plan Renault Super 5 à la page 92.  
Siehe Renault Super 5 auf Seite 92.  
Ver dibujo Renault Super 5 a la página 92.

**49 Veicolo a motore trasversale.**

Vehicle with transversally mounted engine.  
Véhicule avec moteur transversal.  
Fahrzeug mit Transversalmotor.  
Vehículo de motor transversal.

**50 Veicolo a motore longitudinale.**

Vehicle with longitudinally mounted engine.  
Véhicule avec moteur longitudinal.  
Fahrzeug mit Längsmotor.  
Vehículo de motor longitudinal.



ALFEO MORET S.p.A.

Via dell'Industria, 13 - Zona Industriale - 31029 Vittorio Veneto (TV) Italy  
Tel. +39 0438 912090 r.a. Fax +39 0438 501640 Web: [www.osrav.it](http://www.osrav.it) E-mail: [osrav@osrav.it](mailto:osrav@osrav.it)

