

## Automotive Cooling Products



Water Pumps | Timing Kits | Fan Clutches

**USMW**

*Professional Series*



US Motor Works has combined the strengths of a technologically oriented manufacturer, superior sales and service organization with a sophisticated global distribution network to keep our company on the forefront of the automotive marketplace.

With the focus of providing Automotive and Heavy-Duty engine parts and components, US Motor Works is constantly looking for ways to support its customers by increasing the availability of quality parts and components. Currently, US Motor Works manufactures a complete line of Automotive Cooling parts, Fuel Pumps and Heavy-Duty parts.

Precision engineering and manufacturing are essential to creating quality products you can depend on. At US Motor Works, quality begins with highly skilled engineers utilizing materials that meet or exceed OEM specifications, highly complex computer assisted design tools and state of the art equipment to manufacture premium parts.

Our specially trained technician's apply stringent quality control standards utilizing sophisticated technology to make sure that all US Motor Works products meet the rigorous demands of our customers. When you buy US Motor Works manufactured items, you are investing in technology that has been meticulously engineered, manufactured from the highest quality materials and thoroughly tested to assure accuracy, reliability and workmanship.

With more than 100 years of combined experience, we are committed to providing an extensive line of high quality products, the finest customer service and the best support program available in the automotive and heavy-duty market.





# TABLE OF CONTENTS

## Water Pumps

Application Guide .....	5
Buyers Guide .....	81
Quick Reference .....	136
Cross Reference .....	151
Identification Guide .....	161

## Timing Kits

Application Guide .....	200
Buyers Guide .....	207
Cross Reference .....	211
Identification Guide .....	213

## Fan Clutches

Application Guide .....	224
Buyers Guide .....	282
Quick Reference .....	314
Cross Reference .....	320
Identification Guide .....	327

All Manufacturers names, numbers, symbols and descriptions are used for reference purposes only, and in no way does it imply that any parts listed in this catalog are the products of these manufacturers.

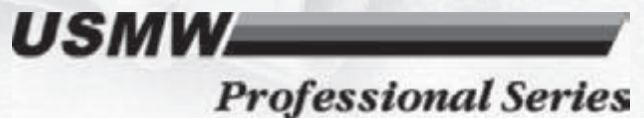

# WARRANTY POLICY

## US Motor Works, LLC

- USMW brand of US Motor Works, LLC products are warranted to be free from defects in material and manufacture, under normal use and service
- US Motor Works coverage will extend a full 12 months from the date of installation in an engine regardless of mileage or hours.
- US Motor Works will cover (replace free of charge or pay for) all labor and parts needed to repair the warrantable failure, including progressive damage to the engine concerned.

### **Conditions of the warranty are:**

1. US Motor Works must be notified by the customer before filing a warranty claim.
2. All warranty claims must be in writing and US Motor Works reserves the right to examine every single engine or part subject to a claim under this warranty
3. Price of parts will be based on the US Motor Works current price list or other accepted suppliers at US Motor Work's option. Cost of labor will be of reasonable hourly flat rate (overtime or holiday rates are not accepted).

### **The warranty is also subject to the following limitations:**

1. The provisions of this warranty shall not apply to any US Motor Works (USMW) brand part altered from its original specification (including but not limited to alterations in packaging and/or markings) or which has been misused, exposed to weather conditions, negligence or damage by accident.
2. The warranty shall be null and void, if the engine or vehicle is not maintained to the suggested OEM level. All receipts and record should be accounted for in the event it is requested for the warranty analysis.
3. This warranty is provided solely to direct customers of the US Motor Works and not any other party. It is the only agreement or obligation of US Motor Works. All other warranties, expressed or implied, including the warranties of merchantability and/or fitness for a particular purpose, are excluded.

**US Motor Works, LLC**

**14722 Anson Ave.**

**Santa Fe Springs, CA 90670 USA**

**Tel (562) 404-0488 Fax (562) 404-8770**

**[www.usmotorworks.com](http://www.usmotorworks.com)**



# WATER PUMPS

USMW Water Pumps are designed with quality in mind. All product applications have been designed and tested to meet or exceed original equipment specifications. Our advanced research has implemented the use of efficient impellers, hubs, bearings and seals that will provide optimum cooling with performance and longevity. We use the highest quality material to create a stronger body design with less corrosion.

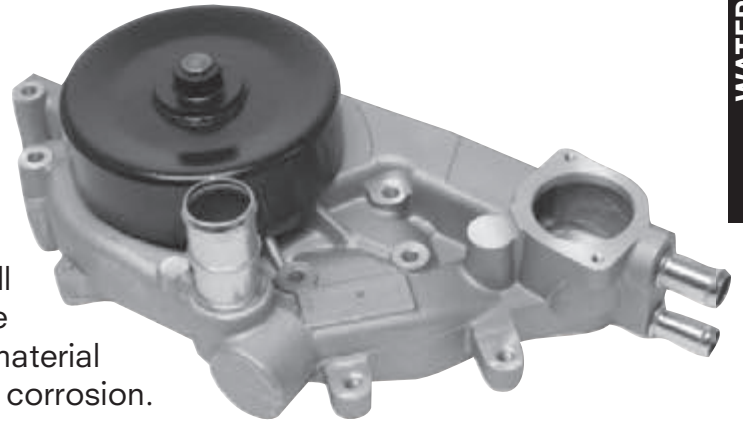

## GENERAL FEATURES:

- \* Leak tested and hub-pull tested to our high quality standards.
- \* Designed and manufactured with the best NEW unitized seals to ensure long, trouble-free performance.
- \* Each unit uses bearings designed as specified by the original equipment manufacturer to meet specific radial torque and axial load requirements of each application to give long bearing life.
- \* Every Water Pump is supplied with a quality mounting gasket and other accessories (seals/gaskets) necessary to properly complete the installation.
- \* Manufactured to original casting specifications for proper fit, easy installation and proper water flow for maximum cooling.



## INSTALLING YOUR NEW WATER PUMP.

please follow all instructions furnished with the pump. *Failure to follow instructions can void your warranty.*

Handle your new water pump with care. Never strike its shaft. This will damage its bearing. Always inspect the fan clutch, fan, belts and pulley when installing a new water pump. Before working on an engine, disconnect the battery ground cable. (Refer to the owner's manual and O.E.M. instructions for restarting after reconnecting it.)

### **CHECK EVERYTHING WHILE INSTALLING YOUR NEW WATER PUMP TO HELP AVOID FUTURE**

**NOTE:** The following can cause a water pump failure: Dirty or excessive coolant or systems; defective, bent or unbalanced fan; defective or unbalanced clutch; wrong belt tension; fan shroud or radiator interference; loose or broken motor mounts; striking the bearing shaft on its end.

Use a 50/50 mixture of new antifreeze and distilled water or its equivalent. (High mineral content, acid or alkaline water reduces pump life, voiding its warranty.) Increase the amount of antifreeze only if needed for your climate. A 50/50 ratio using low silicate antifreeze is best for optimum cooling and prolonged pump life.

**FOR YOUR PROTECTION, NEVER STAND IN LINE WITH THE FAN WHEN RUNNING THE ENGINE.**

## INSTALLATION INSTRUCTIONS:

### Follow this sequence:

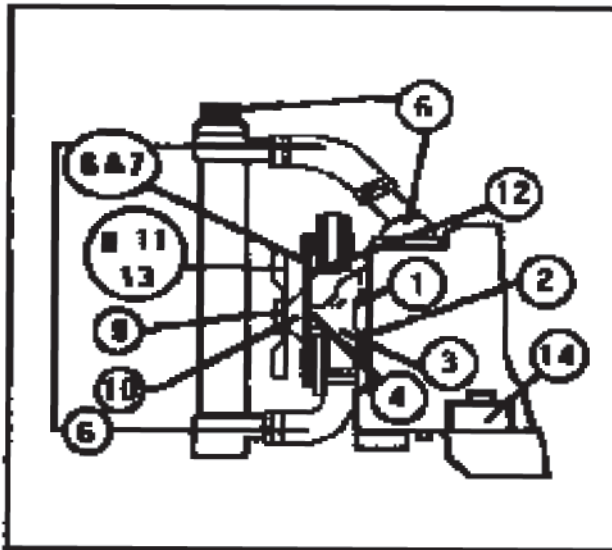

1. Always thoroughly clean the entire cooling system, engine cavity and paint surfaces. Tighten any backplate bolts, as needed.
2. Position new gaskets on the pump using sealer on both sides.
3. Carefully install the new pump. **DO NOT STRIKE THE SHAFT.** Tighten the bolts using a crisscross pattern.
4. Turn the pump by hand. Be sure it turns freely.
5. Inspect and replace the thermostat or radiator cap if they are sticking or leaking.
6. Inspect and replace any hoses and belts with signs of wear or visible defects. Rubber parts over 4 years old should always be replaced.
7. Reconnect the hoses. Refer to the owner's manual or O.E.M. instructions for any special fill procedures. Fill the cooling system and inspect it for leaks. Always dispose of used coolant according to EPA requirements.

8. Inspect and replace any fan with cracks, bends, loose rivets, etc. **NEVER STRAIGHTEN A BENT FAN.**
9. **INSPECT AND REPLACE ANY FAN CLUTCH WITH EXCESSIVE Wobble, LOOSENESS OR LOSS OF OIL. A BAD OR MIS-ALIGNED CLUTCH WILL DAMAGE A WATER PUMP.**
10. Make sure any pulley or clutch sits squarely on the pump hub. Using lockwashers, torque the bolts evenly so all parts turn without wobbling.
11. Rotate the fan by hand to see if it wobbles: Maximum to be 3/32" at the outer edge if no clutch, 1/4" with a clutch.
12. On engines without automatic tensioners, adjust belts to proper tension using a tension gauge. Refer to any manufacturer's specs. Or adjust the belts for a deflection of 1/2" to 3/4". Inspect and replace any defective automatic tensioner or idler pulley.  
(NOTE: Automatic tensioners will normally tighten with use.)
13. Check fan blade tip clearance to the radiator and any shroud. Check any electric cooling fan to insure it is functioning properly.
14. Inspect and replace the motor mounts if there are signs of wear or spilling. Tighten any loose bolts.
15. Start the engine and run it until it reaches normal operating temperature. Check for smooth operation. However, **NEVER STAND NEAR OR IN LINE WITH THE FAN WHEN RUNNING AN ENGINE. FOR YOUR OWN PROTECTION, THE HOOD SHOULD BE CLOSED WHEN REVVING THE ENGINE.** Turn the engine off and check for leaks.

**THIS PRODUCT IS INTENDED FOR USE ONLY AS ORIGINALLY SPECIFIED BY THE CATALOG AND THE O.E.M. MANUFACTURER.**

**IF THE HEAT WARNING LIGHT OR TEMPERATURE GAGES INDICATE OVERHEATING, CHECK THE COOLING SYSTEM TO AVOID DAMAGE.**

**CAUTION: NEVER REMOVE THE RADIATOR CAP WHEN THE SYSTEM IS HOT.**

**NOT RECOMMENDED FOR AIRCRAFT USE.**



ACURA.....	6	MG.....	63
ALFA ROMEO.....	6	MINI.....	63
AM GENERAL.....	6	MITSUBISHI.....	63
AMERICAN MOTORS.....	6	NISSAN.....	64
AUDI.....	7	OLDSMOBILE.....	66
AVANTI.....	8	OPEL.....	68
BMW.....	8	PEUGEOT.....	68
BUICK.....	10	PLYMOUTH.....	68
CADILLAC.....	12	PONTIAC.....	70
CHECKER.....	13	PORSCHE.....	73
CHERY.....	13	RAM.....	73
CHEVROLET.....	13	RENAULT.....	73
CHRYSLER.....	26	SAAB.....	73
CITROEN.....	28	SATURN.....	74
DAEWOO.....	28	SCION.....	74
DAIHATSU.....	28	SEAT.....	74
DODGE.....	28	STERLING.....	74
EAGLE.....	34	SUBARU.....	74
EDSEL.....	34	SUZUKI.....	75
FIAT.....	34	TOYOTA.....	75
FORD.....	34	VOLKSWAGEN.....	77
GENERAL MOTORS.....	43	VOLVO.....	79
GEO.....	43		
GMC.....	43		
HONDA.....	50		
HUMMER.....	51		
HYUNDAI.....	51		
INFINITI.....	51		
INTERNATIONAL.....	51		
ISUZU.....	53		
JAGUAR.....	53		
JEEP.....	54		
KIA.....	56		
LAND ROVER.....	56		
LEXUS.....	56		
LINCOLN.....	57		
MAZDA.....	57		
MERCEDES-BENZ.....	59		
MERCURY.....	61		
MERKUR.....	63		

Years	Engine	Disp.	Application Description	USMW
<b>ACURA</b>				
<b>CL</b>				
1997	L4-2.2L	2156cc	Base,Premium	US9209
1998-1999	L4-2.3L	2254cc	Base,Premium	US9209
1997-1999	V6-3.0L	2997cc	Base,Premium	US9383
2001-2003	V6-3.2L	3210cc	Premium,Type-S,Base	US9383
<b>INTEGRA</b>				
1986-1989	L4-1.6L	1590cc	LS,RS,LS Special Edition	US9115
1992-1993	L4-1.7L	1678cc	GS-R	US9321
1990-1995	L4-1.8L	1834cc	GS,LS,RS,Special Edition	US9224
1994-2001	L4-1.8L	1797cc	GS-R	US9289
1996-2001	L4-1.8L	1797cc	GS-R,Type R	US9468
1996-2001	L4-1.8L	1834cc	LS,RS,Special Edition,GS	US9349
<b>LEGEND</b>				
1986-1987	V6-2.5L	2494cc	Base,L	US9097
1987-1990	V6-2.7L	2675cc	Base,L,LS	US9097
1991-1995	V6-3.2L	3206cc	Coupe; Base,L,LS,GS	US9218
1993-1995	V6-3.2L	3206cc	Sedan; Base,L,LS,SE	US9288
<b>MDX</b>				
2001-2002	V6-3.5L	3471cc	Base,Touring	US9383
2003-2006	V6-3.5L	3471cc	Base,Touring	US9470
2007-2009	V6-3.7L	3664cc	Base	US9470
2010-2012	V6-3.7L	3664cc	Base	US9434
<b>NSX</b>				
1991-2005	V6-3.0L	2977cc	Base,T	US9219
1997-2005	V6-3.2L	3179cc	Base,T,Alex Zanardi Edition	US9219
<b>RDX</b>				
2007-2012	L4-2.3L	2300cc	Base,SH-AWD	US6223
<b>RL</b>				
1996-2004	V6-3.5L	3475cc	Base,Premium,SE	US9354
2005-2008	V6-3.5L	3471cc	Base	US9470
2009-2012	V6-3.7L	3664cc	Base	US9470
<b>RSX</b>				
2002-2006	L4-2.0L	1998cc	Base,L	US9434
2002-2006	L4-2.0L	1998cc	Type-S	US9495
<b>SLX</b>				
1996-1997	V6-3.2L	3165cc	Base,Premium	US9278
1998-1999	V6-3.5L	3494cc	Premium	US9365
<b>TL</b>				
1995	L5-2.5L	2451cc	Base,Premium	US9253
1996-1998	L5-2.5L	2451cc	Base,Premium	US9347
1996-1998	V6-3.2L	3206cc	Base,Premium	US9348
1999-2003	V6-3.2L	3210cc	Base,Type-S	US9383
2004-2008	V6-3.2L	3210cc	Base	US9470
2007-2008	V6-3.5L	3471cc	Type-S	US9470
2009-2012	V6-3.5L	3471cc	Base,SH-AWD	US9434
<b>TSX</b>				
2004-2008	L4-2.4L	2354cc		US9461
2009-2012	L4-2.4L	2354cc	Base,Special Edition	US6233
2010-2012	V6-3.5L	3471cc	V6	US9470
<b>VIGOR</b>				
1992-1994	L5-2.5L	2451cc	GS,LS	US9253
<b>ZDX</b>				
2010-2012	V6-3.7L	3664cc	Base	US9434
<b>ALFA ROMEO</b>				
<b>GTV-6</b>				
1981-1986	V6-2.5L	2492cc	2.5	US9396
<b>MILANO</b>				
1987-1989	V6-2.5L	2492cc	Gold,Platinum,Silver	US9396
1988-1989	V6-3.0L	2959cc	Verde	US9396
<b>SPIDER</b>				
1991-1994	L4-2.0L	1961cc	Base,Veloce	US9400
<b>AM GENERAL</b>				
<b>HUMMER</b>				
1995-1996	V8-5.7L	350 CID		US5049
1995-1996	V8-5.7L	350 CID	High Performance	US5049H

Years	Engine	Disp.	Application Description	USMW
1992-1993	V8-6.2L	379 CID		US5008
1994-1996	V8-6.5L	395 CID		US5062
1997-1998	V8-6.5L	395 CID		US5074
1999-2001	V8-6.5L	395 CID	Base	US5086
<b>AMERICAN MOTORS</b>				
<b>ALLIANCE (MEX)</b>				
1984-1986	L4-1.7L	104 CID	2BL	US8914
<b>AMERICAN (MEX)</b>				
1969-1970	L6-3.3L	199 CID	1BL	US843
1969-1973	L6-3.8L	232 CID	1BL	US843
1973-1974	L6-4.2L	258 CID	2BL	US986
1978-1979	L6-4.2L	258 CID	2BL	US1077
1980-1983	L6-4.2L	258 CID	2BL; V-Belt	US3403
1975-1979	L6-4.6L	282 CID	2BL ;,1BL	US1077
1980-1983	L6-4.6L	282 CID	1BL	US3403
<b>AMX</b>				
1978-1979	L6-4.2L	258 CID		US1077
1980	L6-4.2L	258 CID	Base	US3403
1978-1979	V8-5.0L	304 CID		US3401
1978-1979	V8-5.0L	304 CID	High Performance	US3401H
<b>CLASSIC (MEX)</b>				
1966-1970	L6-3.3L	199 CID	1BL	US843
1967-1973	L6-3.8L	232 CID	1BL	US843
1974	L6-3.8L	232 CID	1BL	US986
1972	L6-4.2L	258 CID	2BL	US843
1973-1974	L6-4.2L	258 CID	2BL	US986
1972	L6-4.6L	282 CID	2BL	US843
1973-1974	L6-4.6L	282 CID	2BL	US986
1975-1976	L6-4.6L	282 CID	2BL	US1077
<b>CONCORD</b>				
1978-1979	L4-2.0L	121 CID		US3400
1980-1982	L4-2.5L	151 CID	Base,DL,Limited	US1107
1978-1979	L6-3.8L	232 CID		US1077
1978-1979	L6-4.2L	258 CID		US1077
1980-1983	L6-4.2L	258 CID	Base,DL,Limited,V-Belt Drive; Base	US3403
1981-1983	L6-4.2L	258 CID	Serpentine Belt Drive; Base,DL,Limited	US3404
1978-1979	V8-5.0L	304 CID		US3401
1978-1979	V8-5.0L	304 CID	High Performance	US3401H
<b>EAGLE</b>				
1981-1983	L4-2.5L	151 CID	Base,DL SX4,DLamback,Kamback,Limited,SX4	US1107
1983	L4-2.5L	150 CID	Serpentine Belt Drive; Base,DL SX4,Limited,SX4	US3404
1983-1984	L4-2.5L	150 CID	V-Belt Drive; Base,DL SX4,Limited,SX4	US3403
1984	L4-2.5L	150 CID	Serpentine Belt Drive; Base,Limited	US3413
1980-1988	L6-4.2L	258 CID	V-Belt Drive; DL,Limited,Sport, V-Belt Drive; Base,DL SX4,DLamback, Kamback,SX4	US3403
1981-1983	L6-4.2L	258 CID	Serpentine Belt Drive; Base,DL SX4, DLamback,Kamback,Limited,SX4	US3404
1984-1988	L6-4.2L	258 CID	Serpentine Belt Drive; Base,Limited	US3413
<b>ENCORE (MEX)</b>				
1985-1986	L4-1.7L	104 CID	2BL	US8914
<b>GREMLIN</b>				
1977-1978	L4-2.0L	121 CID		US3400
1975-1978	L6-3.8L	232 CID		US1077
1975-1978	L6-4.2L	258 CID		US1077
1975-1976	V8-5.0L	304 CID		US3401
1975-1976	V8-5.0L	304 CID	High Performance	US3401H
<b>GREMLIN (MEX)</b>				
1973-1974	L6-4.2L	258 CID	2BL	US986
1975-1979	L6-4.2L	258 CID	2BL	US1077
1980-1983	L6-4.2L	258 CID	2BL	US3403
1979	L6-4.6L	282 CID	1BL	US1077
1980-1983	L6-4.6L	282 CID	1BL	US3403
<b>HORNET</b>				
1975-1977	L6-3.8L	232 CID		US1077
1975-1977	L6-4.2L	258 CID		US1077
1975-1977	V8-5.0L	304 CID		US3401
1975-1977	V8-5.0L	304 CID	High Performance	US3401H



Years	Engine	Disp.	Application Description	USMW
<b>JAVELIN (MEX)</b>				
1971-1973	L6-4.2L	258 CID	2BL	US986
1968-1973	L6-4.6L	282 CID	2BL	US986
<b>LERMA (MEX)</b>				
1980-1983	L6-4.6L	282 CID	2BL	US3403
<b>MATADOR</b>				
1975-1978	L6-4.2L	258 CID		US1077
1975-1977	V8-5.0L	304 CID		US3401
1975-1977	V8-5.0L	304 CID	High Performance	US3401H
1975-1978	V8-5.9L	360 CID		US3401
1975-1978	V8-5.9L	360 CID	High Performance	US3401H
1975-1976	V8-6.6L	401 CID		US3401
1975-1976	V8-6.6L	401 CID	High Performance	US3401H
<b>PACER</b>				
1975-1978	L6-3.8L	232 CID		US1077
1975-1979	L6-4.2L	258 CID		US1077
1980	L6-4.2L	258 CID	V-Belt Drive; DL,Limited	US3403
1978-1979	V8-5.0L	304 CID		US3401
1978-1979	V8-5.0L	304 CID	High Performance	US3401H
<b>PACER (MEX)</b>				
1975-1979	L6-4.6L	282 CID	2BL	US1077
<b>RALLY (MEX)</b>				
1981-1983	L6-4.2L	258 CID	2BL	US3403
1981-1983	L6-4.6L	282 CID	2BL	US3403
<b>SPIRIT</b>				
1979	L4-2.0L	121 CID		US3400
1980-1982	L4-2.5L	151 CID	Base,DL,Limited	US1107
1979	L6-3.8L	232 CID		US1077
1979	L6-4.2L	258 CID		US1077
1980-1983	L6-4.2L	258 CID	V-Belt Drive; Base,DL,Limited,V-Belt Drive; DL,GT	US3403
1981-1983	L6-4.2L	258 CID	Serpentine Belt Drive; Base,DL, Serpentine Belt Drive; DL,GT	US3404
<b>AUDI</b>				
<b>80</b>				
1988-1990	L4-2.0L	1983cc	30mm Hub; Base	US9065
1991-1992	L5-2.3L	2309cc	Base	US9171
<b>90</b>				
1988	L4-2.0L	1983cc	30mm Hub; Base	US9065
1988-1991	L5-2.3L	2309cc	From Chassis/VIN 89-7-396-703; Base,Base	US9171
1993-1994	V6-2.8L	2771cc	CS,S	US9263
1995	V6-2.8L	2771cc	From Chassis/VIN 8CS025821; Base,Sport,Base	US9333
<b>100</b>				
1989-1991	L5-2.3L	2309cc	Base,E	US9171
1992-1994	V6-2.8L	2771cc	Base,CS,S	US9263
<b>200</b>				
1989-1991	L5-2.2L	2226cc	Base	US9171
<b>4000</b>				
1980	L4-1.6L	1588cc	40mm Hub; Base	US9066
1982-1983	L4-1.6L	1588cc	30mm Hub; Base,S	US9065
1981	L4-1.7L	1715cc	40mm Hub; Base	US9066
1981-1983	L4-1.7L	1715cc	30mm Hub; From Chassis/VIN 81-B-149 001; Base,30mm Hub; Base,GT,S	US9065
1984-1987	L4-1.8L	1780cc	30mm Hub; S	US9065
1980-1983	L5-2.2L	2144cc	Base,GT,S	US9052
<b>5000</b>				
1979-1983	L5-2.0L	1986cc	Base,S	US9071
1980-1986	L5-2.2L	2144cc	Base,S,Turbo,S Turbo,CS	US9052
1987-1988	L5-2.2L	2226cc	CS,S	US9052
1987-1988	L5-2.3L	2309cc	S	US9052
<b>100 QUATTRO</b>				
1989-1991	L5-2.3L	2309cc	Base	US9171
1992-1994	V6-2.8L	2771cc	CS	US9263
<b>200 QUATTRO</b>				
1989-1991	L5-2.2L	2226cc	From Engine MC 039 951; Base,20v, 20v Avant	US9171
<b>4000 QUATTRO</b>				
1984-1987	L5-2.2L	2144cc	S,CS	US9052

Years	Engine	Disp.	Application Description	USMW
<b>5000 QUATTRO</b>				
1986-1988	L5-2.2L	2226cc	CS,S	US9052
1987	L5-2.3L	2309cc	S	US9052
<b>80 QUATTRO</b>				
1988-1992	L5-2.3L	2309cc	From Chassis/VIN 89-J-394 743; Base,Base	US9171
<b>90 (MEX)</b>				
1996-1997	V6-2.8L	2771cc	SFI	US9333
<b>90 QUATTRO</b>				
1988-1991	L5-2.3L	2309cc	From Chassis/VIN 89-J-394 743; Base,Base,20v	US9171
1993-1994	V6-2.8L	2771cc	CS	US9263
1995	V6-2.8L	2771cc	Base,Sport	US9333
<b>A3</b>				
1996-2012	L4-1.6L	1595cc	Sportsback	US8959
2006-2008	L4-2.0L	1984cc	Base	US6022
2008-2011	L4-2.0L	1984cc	Base	US9047
2010-2013	L4-2.0L	1984cc	TDI	US6034
2006-2009	V6-3.2L	3189cc	Quattro	US9471
<b>A3 (MEX)</b>				
1997	L4-1.8L	1754cc	Turbo	US9401
1999-2001	L4-1.8L	1754cc	Turbo	US9377
2002-2009	L4-1.8L	1781cc	Turbo DOHC	US9377
2004-2007	L4-2.0L	1984cc	SFI	US9377
2005	L4-2.0L	1998cc	Turbo DOHC	US9377
1997	L5-2.0L	1986cc	Turbo Dsl	US9378
<b>A3 QUATTRO (MEX)</b>				
2004-2005	V6-3.2L	3189cc	SFI DOHC	US9471
<b>A4</b>				
1997-2000	L4-1.8L	1781cc	Base	US9401
2001-2006	L4-1.8L	1781cc	Base,Cabriolet	US9377
2001-2007	L4-2.0L	1984cc		US8959
2005-2009	L4-2.0L	1984cc	Base,Cabriolet	US6022
2010-2012	L4-2.0L	1984cc	Base	US9047
1996-2001	V6-2.8L	2771cc	Base,Avant	US9333
2002-2005	V6-3.0L	2976cc	Base,Cabriolet	US9429
2006-2008	V6-3.2L	3123cc	Base	US6146
<b>A4 (MEX)</b>				
1995-1996	L4-1.8L	1754cc	Turbo	US9401
2007-2009	L4-1.8L	1781cc	Turbo DOHC	US9377
<b>A4 QUATTRO</b>				
1997-2000	L4-1.8L	1781cc	Base,Avant	US9401
2001-2005	L4-1.8L	1781cc	Avant,Base,Cabriolet	US9377
2005-2009	L4-2.0L	1984cc	Avant,Base,Cabriolet	US6022
2010-2012	L4-2.0L	1984cc	Avant,Base	US9047
1996-2001	V6-2.8L	2771cc	Base,Avant	US9333
2002-2006	V6-3.0L	2976cc	Avant,Base,Cabriolet	US9429
2005-2008	V6-3.2L	3123cc	Avant,Base,Cabriolet	US6146
2009	V6-3.2L	3123cc	Cabriolet,Base	US6249
<b>A5</b>				
2010-2012	L4-2.0L	1984cc	Cabriolet	US9047
<b>A5 (MEX)</b>				
2008	V6-3.2L	3200cc	SFI DOHC	US9471
<b>A5 QUATTRO</b>				
2010-2012	L4-2.0L	1984cc	Base,Cabriolet	US9047
2008-2010	V6-3.2L	3123cc	Base	US6249
<b>A6</b>				
2012	L4-2.0L	1984cc	Premium,Premium Plus	US9047
1995-2001	V6-2.8L	2771cc	From Chassis/VIN #4A-S-026 715; Avant,Base,Avant	US9333
2002-2004	V6-3.0L	2976cc	Base	US9429
2006-2009	V6-3.2L	3123cc	Base	US6146
2010-2011	V6-3.2L	3123cc	Base	US6249
<b>A6 (MEX)</b>				
2008-2009	L6-2.8L	2799cc	MFI DOHC	US9469
2005-2006	V6-3.0L	2976cc	SFI DOHC	US9429
<b>A6 QUATTRO</b>				
2000-2004	V6-2.7L	2671cc	Base	US9446
1995-2001	V6-2.8L	2771cc	From Chassis/VIN #4A-S-026 715; Avant,Base	US9333
2002-2004	V6-3.0L	2976cc	Avant,Base	US9429

WATER PUMPS



# WATER PUMP APPLICATION GUIDE



Years	Engine	Disp.	Application Description	USMW
2009-2011	V6-3.0L	2995cc	From Chassis/VIN 4F-9-047 001; Avant,Base	US6146
2005-2008	V6-3.2L	3123cc	Base,Avant	US6146
2000-2004	V8-4.2L	4172cc	Base	US9410
2007-2011	V8-4.2L	4163cc	Base	US9410
<b>A6 QUATTRO (MEX)</b>				
2005-2006	V6-3.0L	2976cc	SFI DOHC	US9429
<b>A8</b>				
1997-1999	V8-3.7L	3697cc	Base	US9362
<b>A8 (MEX)</b>				
1996-1999	V8-4.2L	4172cc	SFI DOHC	US9362
<b>A8 QUATTRO</b>				
1997-1999	V8-4.2L	4172cc	Base	US9362
2000-2006	V8-4.2L	4172cc	Base,L	US9410
2007-2012	V8-4.2L	4163cc	Base,L	US9410
<b>A8 QUATTRO (MEX)</b>				
2000	V8-3.7L	3704cc	SFI DOHC	US9362
<b>ALLROAD QUATTRO</b>				
2001-2005	V6-2.7L	2671cc	Base	US9446
<b>CABRIOLET</b>				
1994	V6-2.8L	2771cc	Base	US9263
1995-1998	V6-2.8L	2771cc	From Chassis/VIN 8G-S-001 303; Base	US9333
<b>COUPE</b>				
1981-1984	L5-2.2L	2144cc	Base	US9052
1984-1987	L5-2.2L	2226cc	Base,GT	US9052
1987	L5-2.3L	2309cc	GT	US9052
<b>COUPE QUATTRO</b>				
1990-1991	L5-2.3L	2309cc	20v	US9171
<b>FOX</b>				
1975-1979	L4-1.6L	1588cc	40mm Hub	US9066
<b>Q5</b>				
2011-2012	L4-2.0L	1984cc	Premium,Premium Plus	US9047
2009-2012	V6-3.2L	3123cc	Premium,Premium Plus,Prestige	US6249
<b>Q5 QUATTRO (MEX)</b>				
2010-2012	V6-3.2L	3200cc	SFI DOHC ; Elite,Luxury	US6249
<b>Q7</b>				
2009-2010	V6-3.0L	2967cc	Base,Premium	US6221
2009-2012	V6-3.0L	2967cc	TDI,TDI Premium,TDI Premium Plus,TDI Prestige	US6146
2011-2013	V6-3.0L	2995cc	Premium,Premium Plus,Prestige,	US6146
2007-2009	V6-3.6L	3597cc	Base,Premium	US6221
2007-2009	V8-4.2L	4163cc	Base,Premium	US9410
<b>Q7 30 ANIV QUATTRO (MEX)</b>				
2011	V6-3.0L	2967cc	Turbo Dsl ; 30 Anniversary	US6146
<b>Q7 AWD (MEX)</b>				
2008	V6-3.0L	2967cc	Turbo Dsl	US9471
2008-2009	V8-4.2L	4163cc	Turbo DSL	US9410
<b>Q7 QUATTRO (MEX)</b>				
2011-2012	V6-3.0L	2967cc	Turbo Dsl ; Elite,Luxury	US6146
<b>QUATTRO</b>				
1983-1985	L5-2.2L	2144cc	Base	US9052
<b>RS4</b>				
2007-2008	V8-4.2L	4172cc	Base,Cabriolet	US9410
<b>RS6</b>				
2003	V8-4.2L	4172cc	Base	US9410
<b>RS6 QUATTRO (MEX)</b>				
2004	V8-4.2L	4179cc	Twin Turbo	US9410
<b>S3 QUATTRO (MEX)</b>				
2000-2001	L4-1.8L	1754cc	Turbo	US9377
2002-2004	L4-1.8L	1781cc	Turbo DOHC	US9377
2008-2011	L4-2.0L	1998cc	Turbo DOHC	US9377
2004	V6-3.2L	3200cc	SFI DOHC	US9471
<b>S4</b>				
1992-1994	L5-2.2L	2226cc	Base	US9279
2000-2002	V6-2.7L	2671cc	Base,Avant	US9446
2010-2012	V6-3.0L	2995cc	Base	US6146
<b>S4 QUATTRO (MEX)</b>				
2000	V6-2.8L	2771cc	SFI	US9333

Years	Engine	Disp.	Application Description	USMW
<b>S5</b>				
2010-2012	V6-3.0L	2995cc	Cabriolet	US6146
2008-2012	V8-4.2L	4163cc	Base	US9410
<b>S6</b>				
1995	L5-2.2L	2226cc	Avant,Base	US9279
2007-2011	V10-5.2L	5204cc	Base	US9410
2002-2003	V8-4.2L	4172cc	Avant	US9410
<b>S6 QUATTRO (MEX)</b>				
2001-2004	V8-4.2L	4172cc	SFI DOHC	US9410
<b>S8</b>				
2007-2009	V10-5.2L	05204cc	Base	US9410
2001-2003	V8-4.2L	4172cc	Base	US9410
<b>TT</b>				
2000-2006	L4-1.8L	1781cc	Base	US9377
2008	L4-2.0L	1984cc	Base	US6022
2009	L4-2.0L	1984cc	Base	US6034
<b>TT (MEX)</b>				
2007-2010	L4-2.0L	1998cc	Turbo DOHC	US9377
<b>TT QUATTRO</b>				
2000-2006	L4-1.8L	1781cc	Base,ALMS Edition	US9377
2009	L4-2.0L	1984cc	Base	US6034
2009-2012	L4-2.0L	1984cc	S	US6022
2010-2012	L4-2.0L	1984cc	Base,Premium Plus,Prestige	US9047
2004-2009	V6-3.2L	3189cc	Base,Special Edition	US9471
<b>V8 QUATTRO</b>				
1990-1991	V8-3.6L	3562cc	Base	US9226
1992-1994	V8-4.2L	4172cc	Base	US9226
<b>AVANTI</b>				
<b>II</b>				
1965-1969	V8-5.3L	5358cc		US898
1965-1969	V8-5.3L	5358cc	High Performance	US898H
1968-1969	V8-5.4L	327 CID		US898
1968-1969	V8-5.4L	327 CID	High Performance	US898H
1969	V8-5.7L	350 CID	High Performance	US898H
1969	V8-5.7L	5736cc	High Performance	US898H
<b>BMW</b>				
<b>325</b>				
1986-1987	L6-2.7L	2693cc	Base	US9119
1988	L6-2.7L	2693cc	Base	US9120
<b>2002</b>				
1975-1976	L4-2.0L	1990cc		US9153
<b>130I (MEX)</b>				
2006-2010	L6-3.0L	2996cc	FI DOHC	US9261
<b>318I</b>				
1984-1985	L4-1.8L	1766cc	Base	US9152
1991-1995	L4-1.8L	1796cc	Base	US9275
1996-1998	L4-1.9L	1895cc	Base	US9275
<b>318I (MEX)</b>				
1997	L4-1.8L	1800cc	FI	US9275
<b>318IS</b>				
1991-1995	L4-1.8L	1796cc	Base	US9275
1996-1997	L4-1.9L	1895cc	Base	US9275
<b>318TI</b>				
1995	L4-1.8L	1796cc	Base	US9275
1996-1999	L4-1.9L	1895cc	Base	US9275
<b>320I</b>				
1980-1983	L4-1.8L	1766cc	Base	US9149
1977-1979	L4-2.0L	1990cc		US9149
<b>320I (MEX)</b>				
2001-2005	L6-2.2L	2171cc	FI DOHC	US9261
<b>323CI</b>				
2000	L6-2.5L	2494cc	Base	US9261
<b>323I</b>				
1998-2000	L6-2.5L	2494cc	Base	US9261



Years	Engine	Disp.	Application Description	USMW
<b>323I (MEX)</b>				
1997-2001	L6-2.5L	2494cc	FI DOHC	US9261
<b>323IS</b>				
1998-1999	L6-2.5L	2494cc	Base	US9261
<b>323TI (MEX)</b>				
2001	L6-2.5L	2494cc	EFI DOHC	US9261
<b>325 (MEX)</b>				
1997	L4-1.8L	1800cc	FI	US9275
<b>325CI</b>				
2001-2006	L6-2.5L	2494cc	Base	US9261
<b>325CI (MEX)</b>				
2007	L6-2.5L	2494cc	FI DOHC	US9261
<b>325E</b>				
1984-1987	L6-2.7L	2693cc	Base	US9119
<b>325ES</b>				
1986-1987	L6-2.7L	2693cc	Base	US9119
<b>325I</b>				
1987	L6-2.5L	2494cc	Base	US9119
1988-1993	L6-2.5L	2494cc	Base	US9120
1992-2005	L6-2.5L	2494cc	Base	US9261
<b>325I (MEX)</b>				
1995-1996	L4-1.8L	1800cc	FI	US9275
1996-2012	L6-2.5L	2494cc	FI DOHC	US9261
2006-2010	L6-2.5L	2497cc	FI DOHC	US9261
<b>325IS</b>				
1987	L6-2.5L	2494cc	Base	US9119
1988-1991	L6-2.5L	2494cc	Base	US9120
1992-1995	L6-2.5L	2494cc	Base	US9261
<b>325IX</b>				
1988-1991	L6-2.5L	2494cc	Base	US9120
<b>325XI</b>				
2001-2005	L6-2.5L	2494cc	Base	US9261
<b>328CI</b>				
2000	L6-2.8L	2793cc	Base	US9261
<b>328I</b>				
1996-2000	L6-2.8L	2793cc	Base	US9261
<b>328I (MEX)</b>				
1995	L6-2.8L	2788cc	FI	US9261
<b>328IS</b>				
1996-1999	L6-2.8L	2793cc	Base	US9261
<b>330CI</b>				
2001-2006	L6-3.0L	2979cc	Base	US9261
<b>330I</b>				
2001-2005	L6-3.0L	2979cc	Base	US9261
<b>330I (MEX)</b>				
2007	L6-3.0L	2996cc	FI DOHC	US9261
<b>330XI</b>				
2001-2005	L6-3.0L	2979cc	Base	US9261
<b>524TD</b>				
1985-1986	L6-2.4L	2443cc	Base	US9154
<b>524TD (MEX)</b>				
1987	L6-2.4L	2443cc	Turbo Dsl	US9154
<b>525I</b>				
1989-1990	L6-2.5L	2494cc	Base	US9120
1991-2005	L6-2.5L	2494cc	Base	US9261
<b>525I (MEX)</b>				
1986	L6-2.5L	2494cc	FI DOHC	US9234
2006-2010	L6-2.5L	2497cc	FI DOHC	US9261
<b>525IT</b>				
1993	L6-2.5L	2494cc	Base	US9261
<b>528 (MEX)</b>				
1996	L6-2.8L	2800cc	FI	US9261
<b>528E</b>				
1988	L6-2.5L	2494cc	Base	US9120
1982-1987	L6-2.7L	2693cc	Base	US9119

Years	Engine	Disp.	Application Description	USMW
<b>528I</b>				
1979	L6-2.8L	2788cc		US9122
1980-1981	L6-2.8L	2788cc	Base	US9117
1997-2000	L6-2.8L	2793cc	Base	US9261
<b>530I</b>				
1975-1978	L6-3.0L	2985cc		US9122
2001-2005	L6-3.0L	2979cc	Base	US9261
1994-1995	V8-3.0L	2997cc	Base	US9276
<b>530I (MEX)</b>				
2008-2010	L6-3.0L	2996cc	FI DOHC	US9261
<b>533I</b>				
1983-1984	L6-3.2L	3210cc	Base	US9117
<b>535I</b>				
1985-1993	L6-3.5L	3430cc	Base	US9117
<b>535IS</b>				
1988	L6-3.5L	3430cc	Base	US9117
<b>540I</b>				
1994-1995	V8-4.0L	3982cc	Base	US9276
1997-1998	V8-4.4L	4398cc	Base	US8926
1999-2003	V8-4.4L	4398cc	Base	US9465
<b>540I (MEX)</b>				
1996	V8-4.0L	3982cc	FI DOHC	US9332
<b>630CSI</b>				
1977-1978	L6-3.0L	2985cc		US9122
<b>633CSI</b>				
1978-1979	L6-3.2L	3210cc		US9122
1980-1984	L6-3.2L	3210cc	Base	US9117
<b>635CSI</b>				
1985-1989	L6-3.5L	3430cc	Base	US9117
<b>728I (MEX)</b>				
1997	L6-2.8L	2788cc	FI DOHC	US9261
<b>733I</b>				
1978-1979	L6-3.2L	3210cc		US9122
1980-1984	L6-3.2L	3210cc	Base	US9117
<b>735I</b>				
1985-1987	L6-3.5L	3430cc	Base	US9122
1988-1992	L6-3.5L	3430cc	Base	US9117
<b>735IL</b>				
1988-1992	L6-3.5L	3430cc	Base	US9117
<b>740I</b>				
1993-1994	V8-4.0L	3982cc	Base	US9276
1995	V8-4.0L	3982cc	Base	US9332
1997-1998	V8-4.4L	4398cc	Base	US8926
1999-2001	V8-4.4L	4398cc	Base	US9465
<b>740IL</b>				
1993-1994	V8-4.0L	3982cc	Base	US9276
1995	V8-4.0L	3982cc	Base	US9332
1996-1998	V8-4.4L	4398cc	Base	US8926
1999-2001	V8-4.4L	4398cc	Base	US9465
<b>750IL</b>				
1988-1994	V12-5.0L	4988cc	Base	US9128
1995-1997	V12-5.4L	5379cc	Base	US9464
1998-2001	V12-5.4L	5379cc	From 10-98; Base,Base	US9467
<b>750IL (MEX)</b>				
1995	V12-5.0L	5000cc	FI	US9128
<b>840CI</b>				
1994-1995	V8-4.0L	3982cc		US9332
1994-1995	V8-4.0L	3982cc	Base	US8926
1996-1997	V8-4.4L	4398cc	Base	US8926
<b>850 (MEX)</b>				
1995	V12-5.0L	5000cc	FI	US9236
<b>850CI</b>				
1993-1994	V12-5.0L	4988cc	Base	US9236
1995-1997	V12-5.4L	5379cc	Base	US9464
<b>850CI (MEX)</b>				
1996-1997	V12-5.0L	5000cc	FI	US9236

**WATER PUMPS**



# WATER PUMP APPLICATION GUIDE



Years	Engine	Disp.	Application Description	USMW
1998	V12-5.4L	5379cc	FI SOHC	US9464
<b>850CSI</b>				
1994-1995	V12-5.6L	5576cc	Base	US9236
<b>850I</b>				
1991-1992	V12-5.0L	4988cc	Base	US9236
<b>850I (MEX)</b>				
1990	V12-5.0L	5000cc	FI	US9236
<b>L6</b>				
1987	L6-3.5L	3430cc	Base	US9117
<b>L7</b>				
1986-1987	L6-3.5L	3430cc	Base	US9117
<b>M3</b>				
1995	L6-3.0L	2990cc	Base,Lightweight	US9261
1996-1999	L6-3.2L	3152cc	Base	US9261
<b>M3 (MEX)</b>				
1994-1996	L6-3.0L	2990cc	FI DOHC	US9261
<b>M5</b>				
1988	L6-3.5L	3453cc	Base	US9117
1991-1993	L6-3.6L	3553cc	Base	US9234
<b>M5 (MEX)</b>				
1993-1994	L6-3.4L	3430cc	FI	US9275
<b>M6</b>				
1987-1988	L6-3.5L	3453cc	Base	US9117
<b>X3</b>				
2004-2005	L6-2.5L	2494cc	2.5i	US9261
2004-2006	L6-3.0L	2979cc	3.0i	US9261
<b>X3 (MEX)</b>				
2006-2009	L6-2.5L	2494cc	FI DOHC ; AWD	US9261
<b>X5</b>				
2001-2006	L6-3.0L	2979cc	3.0i	US9261
2000-2003	V8-4.4L	4398cc	4.4i	US9465
2002-2003	V8-4.6L	4598cc	4.6is	US9465
<b>Z3</b>				
1996-1998	L4-1.9L	1895cc	Roadster	US9275
1999-2002	L6-2.5L	2494cc	Roadster	US9261
1997-2000	L6-2.8L	2793cc	Roadster,Coupe	US9261
2001-2002	L6-3.0L	2979cc	Coupe,Roadster	US9261
1998-2000	L6-3.2L	3152cc	M Roadster,M Coupe	US9261
<b>Z3 (MEX)</b>				
1999	L4-1.9L	1895cc	FI DOHC	US9275
2000	L6-2.0L	1991cc	FI DOHC	US9261
2001	L6-2.2L	2171cc	FI DOHC ; Roadster	US9261
<b>Z4</b>				
2003-2005	L6-2.5L	2494cc	2.5i	US9261
2003-2005	L6-3.0L	2979cc	3.0i	US9261
<b>Z4 (MEX)</b>				
2007-2009	L6-2.5L	2494cc	FI DOHC	US9261
<b>Z8</b>				
2003	V8-4.8L	4837cc	Alpina	US9465
<b>BUICK</b>				
<b>APOLLO</b>				
1975	V8-4.3L	260 CID	Air Cond; High Performance,;	US1120H
1975	V8-5.7L	350 CID	Air Cond; High Performance,;	US1120H
<b>CENTURY</b>				
1993-1996	L4-2.2L	134 CID	Custom,Limited,Special	US5032
1982-1986	L4-2.5L	151 CID	3 Groove pulley; Custom,Limited,Estate, Olympia Limited,Estate Wagon	US5000P
1982-1986	L4-2.5L	151 CID	W/O Pulley; Custom,Limited,Estate, Olympia Limited,Estate Wagon	US5000
1987-1992	L4-2.5L	151 CID	Custom,Estate Wagon,Limited,Special	US5041
1986	V6-2.8L	173 CID	Custom,Estate Wagon,Limited	US5001
1987-1989	V6-2.8L	173 CID	Custom,Estate Wagon,Limited	US5033
1982-1985	V6-3.0L	181 CID	Custom,Limited,T-Type,Estate, Olympia Limited, Estate Wagon	US5028
1994-2005	V6-3.1L	189 CID	Custom,Special,Limited,Special Edition	US5033
1978-1979	V6-3.2L	196 CID		US1018

Years	Engine	Disp.	Application Description	USMW
1978-1979	V6-3.2L	196 CID	High Performance	US1018H
1989-1993	V6-3.3L	204 CID	Custom,Estate Wagon,Limited,Special	US5050
1975-1981	V6-3.8L	231 CID	Base,Estate,Limited,Sport	US1018
1975-1981	V6-3.8L	231 CID	High Performance; Base,Estate,Limited,Sport	US1018H
1984-1985	V6-3.8L	231 CID	Custom,Estate,Limited,Olympia Limited,T-Type, Estate Wagon	US5028
1986-1988	V6-3.8L	231 CID	Custom,Estate Wagon,Limited,T-Type	US5050
1982-1985	V6-4.3L	260 CID	Custom,Limited,Estate, Olympia Limited,Estate Wagon	US5014
1980-1981	V8-4.3L	265 CID	Base,Estate,Limited,Sport	US975
1979-1980	V8-4.9L	301 CID	Base,Estate,Limited,Sport	US975
1977-1980	V8-5.0L	305 CID	Base,Estate,Limited	US1121
1977-1980	V8-5.0L	305 CID	High Performance; Base,Estate,Limited	US1121H
1975-1977	V8-5.7L	350 CID		US1018
1975-1978	V8-5.7L	350 CID	High Performance	US1018H
1975-1981	V8-5.7L	350 CID	Air Cond	US1120
1975-1981	V8-5.7L	350 CID	Air Cond; High Performance; Base,Estate,Limited	US1120H
1975-1981	V8-5.7L	350 CID	Exc.Air Cond; Base,Estate,Limited	US1100
1977	V8-5.7L	350 CID	High Performance,;	US1121H
1977	V8-6.6L	403 CID	Air Cond; High Performance,;	US1120H
<b>COMMERCIAL CHASSIS</b>				
1991-1993	V8-5.0L	305 CID	Base	US5051
1994-1996	V8-5.7L	350 CID	Base	US5069
<b>ELECTRA</b>				
1985	V6-3.0L	181 CID	Limited,T-Type	US5028
1985	V6-3.8L	231 CID	Limited,Park Avenue	US5028
1986-1990	V6-3.8L	231 CID	Limited,Park Avenue,T-Type,Park Avenue Ultra	US5050
1980-1984	V6-4.1L	252 CID	High Performance; Limited,Park Avenue	US1018H
1980-1984	V6-4.1L	252 CID	Limited,Park Avenue	US1018
1985	V6-4.3L	260 CID	Limited,Park Avenue	US5014
1980	V8-4.9L	301 CID	Estate Wagon	US975
1981-1985	V8-5.0L	307 CID	Air Cond; High Performance; Estate Wagon,Limited, Park Avenue	US1120H
1981-1985	V8-5.0L	307 CID	Exc.Air Cond; Estate Wagon,Limited,Park Avenue	US1100
1981-1987	V8-5.0L	307 CID	Air Cond	US1120
1976-1985	V8-5.7L	350 CID	Air Cond	US1120
1976-1985	V8-5.7L	350 CID	Exc.Air Cond;Exc.Air Cond; Estate Wagon,Limited, Park Avenue	US1100
1976-1987	V8-5.7L	350 CID	Air Cond; High Performance; Estate Wagon,Limited, Park Avenue	US1120H
1977-1980	V8-5.7L	350 CID	Estate Wagon,Limited,Park Avenue	US1018
1977-1980	V8-5.7L	350 CID	High Performance; Estate Wagon,Limited,Park Avenue	US1018H
1977-1979	V8-6.6L	403 CID	Air Cond	US1120
1977-1979	V8-6.6L	403 CID	Air Cond; High Performance	US1120H
1977-1979	V8-6.6L	403 CID	Exc.Air Cond	US1100
1975	V8-7.5L	455 CID		US1045
<b>ENCLAVE</b>				
2008-2011	V6-3.6L	217 CID	CX,CXL	US8932
<b>ENCORE</b>				
2013	L4-1.4L	83 CID		US6662
<b>ESTATE WAGON</b>				
1964	V8-4.9L	300 CID		US855
1980	V8-4.9L	301 CID	Base	US975
1981-1983	V8-5.0L	307 CID	Air Cond; Base	US1120
1981-1983	V8-5.0L	307 CID	Air Cond; High Performance; Base	US1120H
1981-1983	V8-5.0L	307 CID	Exc.Air Cond; Base	US1100
1970	V8-5.7L	350 CID		US855
1977-1983	V8-5.7L	350 CID	Air Cond; High Performance; Base	US1120H
1977-1983	V8-5.7L	350 CID	Air Cond; Base	US1120
1977-1983	V8-5.7L	350 CID	Exc.Air Cond; Base	US1100
1980	V8-5.7L	350 CID	High Performance; Base	US1018H
1977-1979	V8-6.6L	403 CID	Air Cond	US1120
1977-1979	V8-6.6L	403 CID	Air Cond; High Performance	US1120H
1977-1979	V8-6.6L	403 CID	Exc.Air Cond	US1100
1975	V8-7.5L	455 CID		US1045
<b>GRAN SPORT</b>				
1965	V8-4.9L	300 CID		US855
<b>GS</b>				
1970	V8-5.7L	350 CID		US855

Years	Engine	Disp.	Application Description	USMW
<b>GS 350</b>				
1968-1969	V8-5.7L	350 CID		US855
<b>LACROSSE</b>				
2010-2014	L4-2.4L	145 CID	CX,	US5092
2005-2011	V6-3.6L	217 CID	CXS,CX,CXL	US8932
2005-2009	V6-3.8L	231 CID	VIN 2; CX,CXL	US5075
2008-2009	V8-5.3L	325 CID	Super	US6154
<b>LESABRE</b>				
1986	V6-3.0L	181 CID	Custom,Limited	US5050
1976-1985	V6-3.8L	231 CID	Base,Limited,Sport,Custom,Limited Edition F/E, Collector's Edition	US1018
1976-1985	V6-3.8L	231 CID	High Performance; Base,Limited,Sport, Custom, Limited Edition F/E; Collector's Edition	US1018H
1986-1995	V6-3.8L	231 CID	Custom,Limited,Base,T-Type	US5050
1996-2005	V6-3.8L	231 CID	Custom,Limited	US5075
1980-1984	V6-4.1L	252 CID	Base,Limited,Sport,Custom,Limited Edition F/E	US1018
1980-1984	V6-4.1L	252 CID	Base,Limited,Sport,High Performance; Custom, Limited Edition F/E	US1018H
1964-1965	V8-4.9L	300 CID		US855
1977-1980	V8-4.9L	301 CID	Base,Limited	US975
1978	V8-5.0L	305 CID	High Performance;,,	US1121H
1981-1985	V8-5.0L	307 CID	Air Cond; Base,Air Cond; Custom	US1120
1981-1985	V8-5.0L	307 CID	Air Cond; High Performance; Base,Limited,Sport Custom,Limited Edition F/E; Collector's Edition Custom,Estate Wagon	US1120H
1981-1985	V8-5.0L	307 CID	Exc.Air Cond; Base,Limited,Sport,Custom, Limited Edition F/E; Collector's Edition,Estate Wagon	US1100
1968-1970	V8-5.7L	350 CID		US855
1975-1980	V8-5.7L	350 CID	Base,Limited	US1018
1975-1980	V8-5.7L	350 CID	High Performance; Base,Limited	US1018H
1975-1985	V8-5.7L	350 CID	Base,Limited,Sport,Exc.Air Cond; Custom Limited Edition F/E, Collector's Edition,Estate Wagon	US1100
1975-1990	V8-5.7L	350 CID	Base,Limited,Sport,Air Cond; High Performance; Custom,Limited Edition F/E, Collector's Edition Estate Wagon	US1120H
1975-1990	V8-5.7L	350 CID	Base,Air Cond; Custom,Air Cond; Estate Wagon	US1120
1978-1979	V8-5.7L	350 CID		US1121
1978-1979	V8-5.7L	350 CID	High Performance	US1121H
1975	V8-6.6L	400 CID	Air Cond; High Performance;,,	US1120H
1977-1978	V8-6.6L	403 CID	Air Cond	US1120
1977-1978	V8-6.6L	403 CID	Air Cond; High Performance	US1120H
1977-1978	V8-6.6L	403 CID	Exc.Air Cond	US1100
1975	V8-7.5L	455 CID		US1045
<b>LUCERNE</b>				
2006-2008	V6-3.8L	231 CID	CX,CXL	US5075
2009-2011	V6-3.9L	237 CID	CX,CXL,CXL Special Edition	US6020
2006-2011	V8-4.6L	281 CID	CXL,CXS,Super	US8956
<b>OPEL (MEX)</b>				
1959-1964	L4-1.7L	104 CID	1BL	US1061
1965-1972	L4-2.1L	128 CID	1BL	US1061
<b>PARK AVENUE</b>				
1991-1995	V6-3.8L	231 CID	Base,Ultra	US5050
1996-2005	V6-3.8L	231 CID	Base,Ultra	US5075
<b>RAINIER</b>				
2004-2007	L6-4.2L	256 CID	CXL,CXL Plus	US5097
2004-2005	V8-5.3L	323 CID	CXL,CXL Plus	US64
2004-2005	V8-5.3L	323 CID	Includes thermostat and thermostat housing; CXL,CXL Plus	US64-T
2006	V8-5.3L	325 CID	Includes thermostat and thermostat housing; CXL,CXL	US64-T
2007	V8-5.3L	325 CID	CXL	US6009
<b>REATTA</b>				
1988-1991	V6-3.8L	231 CID	Base	US5050
<b>REGAL</b>				
2011-2013	L4-2.0L	122 CID	CXL,	US5092
2011-2013	L4-2.4L	145 CID	CXL,	US5092
1988-1989	V6-2.8L	173 CID	Custom,Limited	US5033
1989-1996	V6-3.1L	189 CID	Custom,Gran Sport,Limited,Base	US5033

Years	Engine	Disp.	Application Description	USMW
1978-1979	V6-3.2L	196 CID		US1018
1978-1979	V6-3.2L	196 CID	High Performance	US1018H
1975-1987	V6-3.8L	231 CID	Base,Limited,Sport,Estate Wagon,Grand National, T-Type,GNX	US1018
1975-1987	V6-3.8L	231 CID	High Performance; Base,Limited,Sport,Estate Wagon, T-Type,Grand National,GNX	US1018H
1990-1995	V6-3.8L	231 CID	Base,Custom,Gran Sport,Limited	US5050
1996-2004	V6-3.8L	231 CID	Base,Custom,Gran Sport,Limited, Olympic Gold Edition,GS,LS,25th Anniversary Edition, GSE,LSE	US5075
1982-1984	V6-4.1L	252 CID	Base,Estate Wagon,Limited,Limited Turbo,Sport, T-Type,Grand National	US1018
1982-1984	V6-4.1L	252 CID	High Performance; Base,Estate Wagon,Limited, Limited Turbo	US1018H
1982-1984	V6-4.3L	260 CID	Base,Limited	US5012
1980-1981	V8-4.3L	265 CID	Base,Limited	US975
1979-1980	V8-4.9L	301 CID	Base,Limited	US975
1977-1980	V8-5.0L	305 CID	Base,Limited	US1121
1977-1980	V8-5.0L	305 CID	High Performance; Base,Limited	US1121H
1986-1987	V8-5.0L	307 CID	Air Cond; Base	US1120
1986-1987	V8-5.0L	307 CID	Air Cond; High Performance; Base,Limited	US1120H
1975-1977	V8-5.7L	350 CID		US1018
1975-1977	V8-5.7L	350 CID	High Performance	US1018H
1975-1983	V8-5.7L	350 CID	Exc.Air Cond; Exc.Air Cond; Base,Estate Wagon, Limited	US1100
1975-1985	V8-5.7L	350 CID	Air Cond; High Performance;,, Air Cond; High Performance; Base,Estate Wagon, Limited	US1120H
1975-1985	V8-5.7L	350 CID	Air Cond; Air Cond; Base	US1120
1977	V8-5.7L	350 CID	High Performance;,,	US1121H
<b>RENDEZVOUS</b>				
2002-2005	V6-3.4L	207 CID	CX,CX Plus,CXL,CXL Plus	US5033
2006-2007	V6-3.5L	213 CID	CX,CXL	US5033
2004-2006	V6-3.6L	217 CID	CXL,Ultra,CXL Plus,CX	US8932
<b>RIVIERA</b>				
1979-1985	V6-3.8L	231 CID	Base,S,T-Type,Luxury	US1018
1979-1985	V6-3.8L	231 CID	High Performance; Base,S,T-Type; T-Type,Luxury	US1018H
1986-1995	V6-3.8L	231 CID	Luxury,T-Type,Base	US5050
1996-1999	V6-3.8L	231 CID	Base	US5075
1981-1984	V6-4.1L	252 CID	Base,T-Type,Limited Edition,Luxury ,XX Anniversary Edition	US1018
1981-1984	V6-4.1L	252 CID	High Performance; Base,T-Type,Limited Edition Luxury,XX Anniversary Edition	US1018H
1980-1985	V8-5.0L	307 CID	Air Cond; Base	US1120
1980-1985	V8-5.0L	307 CID	Air Cond; High Performance; Base,S,T-Type, Limited Edition,Luxury,XX Anniversary Edition	US1120H
1980-1985	V8-5.0L	307 CID	Exc.Air Cond; Base,S,T-Type,Limited Edition, Luxury,XX Anniversary Edition	US1100
1977-1979	V8-5.7L	350 CID		US1018
1977-1979	V8-5.7L	350 CID	High Performance	US1018H
1977-1985	V8-5.7L	350 CID	Air Cond; High Performance; Base,S,Limited Edition, Luxury,XX Anniversary Edition	US1120H
1977-1985	V8-5.7L	350 CID	Air Cond; Air Cond; Base	US1120
1977-1985	V8-5.7L	350 CID	Exc.Air Cond; Base,S,Limited Edition ,Luxury XX Anniversary Edition	US1100
1977-1978	V8-6.6L	403 CID	Air Cond	US1120
1977-1978	V8-6.6L	403 CID	Air Cond; High Performance	US1120H
1977-1978	V8-6.6L	403 CID	Exc.Air Cond	US1100
1975	V8-7.5L	455 CID		US1045
<b>ROADMASTER</b>				
1991	V8-5.0L	305 CID	Estate Wagon	US5051
1992-1993	V8-5.7L	350 CID	Base,Estate Wagon,Limited	US5051
1994-1996	V8-5.7L	350 CID	Base,Estate Wagon,Limited,Collector's Edition Estate Wagon Collector's Edition	US5069
<b>SKYHAWK</b>				
1982	L4-1.8L	112 CID	Custom,Limited	US5007
1982-1986	L4-1.8L	112 CID	Custom,Limited,T-Type	US5036
1985-1986	L4-1.8L	112 CID	Custom,Limited,T-Type,Sport	US5017
1983-1986	L4-2.0L	122 CID	Custom,Limited,Sport	US5007



Years	Engine	Disp.	Application Description	USMW
1987-1988	L4-2.0L	122 CID	Custom,Limited,Sport,T-Type,SE	US5036
1987-1989	L4-2.0L	122 CID	Custom,Limited,Sport,T-Type,SE	US5032
1975-1980	V6-3.8L	231 CID	Base,Designers' Accent Edition,Road Hawk,S	US1018
1975-1980	V6-3.8L	231 CID	High Performance; Base,Designers' Accent Edition Road Hawk,S	US1018H
<b>SKYLARK</b>				
1988-1995	L4-2.3L	138 CID	Custom,Limited,Gran Sport,Luxury Edition,Base	US5043
1996-1998	L4-2.4L	146 CID	Custom,Limited,Olympic Gold Edition	US5076
1980-1985	L4-2.5L	151 CID	3 Groove pulley; Base,Limited,Sport,3 Groove pulley; Custom	US5000P
1980-1991	L4-2.5L	151 CID	W/O Pulley; Base,Limited,Sport,W/O Pulley; Custom, Gran Sport,Luxury Edition	US5000
1986-1991	L4-2.5L	151 CID	With Multi-Groove pulley	US5067
1980-1985	V6-2.8L	173 CID	Base,Limited,Sport,Custom,T-Type	US5001
1986-1988	V6-3.0L	181 CID	Custom,Limited	US5050
1994-1998	V6-3.1L	189 CID	Custom,Gran Sport,Limited,Olympic Gold Edition	US5033
1989-1993	V6-3.3L	204 CID	Custom,Limited,Gran Sport,Luxury Edition,Base	US5050
1964-1967	V6-3.7L	225 CID		US855
1975-1978	V6-3.8L	231 CID		US1018
1975-1979	V6-3.8L	231 CID	High Performance	US1018H
1975-1976	V8-4.3L	260 CID	Air Cond	US1120
1975-1976	V8-4.3L	260 CID	Air Cond; High Performance	US1120H
1975-1976	V8-4.3L	260 CID	Exc.Air Cond	US1100
1964-1967	V8-4.9L	300 CID		US855
1977	V8-4.9L	301 CID		US975
1977-1979	V8-5.0L	305 CID		US1121
1977-1979	V8-5.0L	305 CID	High Performance	US1121H
1968-1970	V8-5.7L	350 CID		US855
1975-1976	V8-5.7L	350 CID		US1018
1975-1977	V8-5.7L	350 CID	Air Cond	US1120
1975-1977	V8-5.7L	350 CID	Air Cond; High Performance	US1120H
1975-1977	V8-5.7L	350 CID	Exc.Air Cond	US1100
1975-1978	V8-5.7L	350 CID	High Performance	US1018H
1978-1979	V8-5.7L	350 CID		US1121
1978-1979	V8-5.7L	350 CID	High Performance	US1121H
<b>SOMERSET</b>				
1986	L4-2.5L	151 CID	W/O Pulley; Custom,Limited,T-Type	US5000
1986-1987	L4-2.5L	151 CID	With Multi-Groove pulley	US5067
1987	L4-2.5L	151 CID	3 Groove pulley; Custom,Limited,Custom	US5000P
1986-1987	V6-3.0L	181 CID	Custom,Limited,T-Type	US5050
<b>SOMERSET REGAL</b>				
1985	L4-2.5L	151 CID	With Multi-Groove pulley ; Base,Limited,	US5067
1985	V6-3.0L	181 CID	Base,Limited	US5050
<b>SPECIAL</b>				
1964-1967	V6-3.7L	225 CID		US855
1964-1967	V8-4.9L	300 CID		US855
1968-1969	V8-5.7L	350 CID		US855
<b>SPORTWAGON</b>				
1964-1967	V6-3.7L	225 CID		US855
1964-1965	V8-4.9L	300 CID		US855
1968-1970	V8-5.7L	350 CID		US855
<b>TERRAZA</b>				
2005-2006	V6-3.5L	213 CID	CX,CXL	US5033
2006-2007	V6-3.9L	237 CID	CX,CXL	US6020
<b>VERANO</b>				
2013	L4-2.0L	122 CID		US5092
2012-2013	L4-2.4L	145 CID		US5092
<b>CADILLAC</b>				
<b>60 SPECIAL</b>				
1993	V8-4.9L	300 CID	Base	US5023
<b>ALLANTE</b>				
1987-1992	V8-4.1L	250 CID	Base,Value Leader	US5023
1993	V8-4.6L	281 CID	Base,Indianapolis 500 Pace Car,Value Leader	US5064
<b>BROUGHAM</b>				
1987-1990	V8-5.0L	307 CID	Air Cond; High Performance; Base,d'Elegance	US1120H
1987-1990	V8-5.0L	307 CID	Air Cond; Air Cond; Base,d'Elegance	US1120
1991-1992	V8-5.0L	305 CID	Base,d'Elegance	US5049
1991-1992	V8-5.0L	305 CID	High Performance; Base,d'Elegance	US5049H

Years	Engine	Disp.	Application Description	USMW
1990-1992	V8-5.7L	350 CID	Base,d'Elegance	US5049
1990-1992	V8-5.7L	350 CID	High Performance; Base,d'Elegance	US5049H
<b>CALAIS</b>				
1968-1973	V8-7.7L	472 CID		US851
1970-1973	V8-8.2L	500 CID		US851
<b>CATERA</b>				
1997-2001	V6-3.0L	181 CID	Base,Sport	US5079
<b>CIMARRON</b>				
1982-1986	L4-2.0L	122 CID	Base,d'Oro	US5007
1985-1986	V6-2.8L	173 CID	Base,d'Oro	US5020
1987-1988	V6-2.8L	173 CID	Base	US5033
<b>COMMERCIAL CHASSIS</b>				
1985	V6-4.3L	260 CID	Base	US5014
1985-1990	V8-4.1L	250 CID	Base	US5023
1988-1989	V8-4.5L	273 CID	Base	US5023
1991-1993	V8-4.9L	300 CID	Base	US5023
1992-1993	V8-5.7L	350 CID	Brougham	US5049
1992-1993	V8-5.7L	350 CID	High Performance; Brougham	US5049H
1994-1996	V8-5.7L	350 CID	Base,Brougham	US5069
1980-1984	V8-6.0L	368 CID	Base	US5003
1968-1973	V8-7.7L	472 CID		US851
1970-1973	V8-8.2L	500 CID		US851
<b>CTS</b>				
2010-2011	V6-3.0L	182 CID	Base,Luxury,Performance	US8932
2003-2004	V6-3.2L	197 CID	Base,Luxury,Luxury Sport	US5079
2004-2011	V6-3.6L	217 CID	Base,Performance,Premium	US8932
2004-2005	V8-5.7L	346 CID	Includes thermostat and thermostat housing; V	US65-T
2004-2005	V8-5.7L	346 CID	V	US65
2009-2011	V8-6.2L	376 CID	V	US79
<b>DEVILLE</b>				
1980-1982	V6-4.1L	252 CID	Base,Cabriolet,d'Elegance	US1018
1980-1982	V6-4.1L	252 CID	High Performance; Base,Cabriolet,d'Elegance	US1018H
1985	V6-4.3L	260 CID	Base,Cabriolet,d'Elegance	US5014
1982-1984	V8-4.1L	250 CID	Base,Cabriolet,d'Elegance	US5010
1985-1987	V8-4.1L	250 CID	Base,Cabriolet,d'Elegance,Touring	US5023
1988-1990	V8-4.5L	273 CID	Base	US5023
1994	V8-4.6L	281 CID	Concours	US5064
1995-2005	V8-4.6L	281 CID	Concours,Base,d'Elegance,DHS,DTS	US5072
1991-1995	V8-4.9L	300 CID	Base,Spring Edition,Touring	US5023
1980-1984	V8-5.7L	350 CID	Air Cond; Base	US1120
1980-1984	V8-5.7L	350 CID	Air Cond; High Performance; Base,Cabriolet,d'Elegance	US1120H
1980-1981	V8-6.0L	368 CID	Base,Cabriolet,d'Elegance	US5003
1977-1979	V8-7.0L	425 CID		US5003
1968-1973	V8-7.7L	472 CID		US851
1970-1973	V8-8.2L	500 CID		US851
<b>DEVILLE (MEX)</b>				
1993	V8-4.6L	279 CID	MFI	US5072
1996-1997	V8-4.9L	300 CID	MFI	US5072
<b>DTS</b>				
2006-2011	V8-4.6L	281 CID	Base,L,Platinum	US8956
<b>ELDORADO</b>				
1981-1982	V6-4.1L	252 CID	Base,Biarritz,Brougham d'Elegance,Cabriolet,Touring	US1018
1981-1982	V6-4.1L	252 CID	High Performance; Base,Biarritz,Brougham d'Elegance, Cabriolet,Touring	US1018H
1982-1985	V8-4.1L	250 CID	Base,Biarritz,Cabriolet,Touring	US5010
1986-1987	V8-4.1L	250 CID	Base,Biarritz	US5023
1988-1990	V8-4.5L	273 CID	Base,Biarritz,Touring	US5023
1993-1994	V8-4.6L	281 CID	Sport,Touring,Base	US5064
1995-2002	V8-4.6L	281 CID	Base,ETC,ESC	US5072
1991-1993	V8-4.9L	300 CID	Base,Biarritz,Spring Edition,Touring	US5023
1980-1985	V8-5.7L	350 CID	Air Cond; Base,Brougham d'Elegance,Biarritz, Cabriolet,Touring	US1120
1980-1985	V8-5.7L	350 CID	Air Cond; High Performance; Base,Biarritz,Cabriolet, Brougham d'Elegance,Touring	US1120H
1980-1981	V8-6.0L	368 CID	Base,Biarritz,Cabriolet,Brougham d'Elegance	US5003
1977-1978	V8-7.0L	425 CID		US5003
1968-1969	V8-7.7L	472 CID		US851

Years	Engine	Disp.	Application Description	USMW
1970-1973	V8-8.2L	500 CID		US851
<b>ESCALADE</b>				
2002-2003	V8-5.3L	325 CID	Base	US5087
2004-2005	V8-5.3L	325 CID	Base	US64
2004-2005	V8-5.3L	325 CID	Includes thermostat and thermostat housing; Base	US64-T
1999-2000	V8-5.7L	350 CID	Base	US5077
2002-2003	V8-6.0L	364 CID	Base,EXT,Invalid ID	US5087
2004-2006	V8-6.0L	364 CID	Base	US64
2004-2006	V8-6.0L	364 CID	Includes thermostat and thermostat housing; Base	US64-T
2009-2011	V8-6.0L	364 CID	Hybrid,Hybrid Platinum	US6009
2007-2008	V8-6.2L	378 CID	Base,EXT,Platinum	US6009
2009-2011	V8-6.2L	376 CID	Base,EXT,Platinum,Luxury,Premium	US6009
<b>FLEETWOOD</b>				
1980-1982	V6-4.1L	252 CID	Brougham,Brougham d'Elegance	US1018
1980-1982	V6-4.1L	252 CID	High Performance; Brougham,Brougham d'Elegance	US1018H
1985	V6-4.3L	260 CID	75,75 Formal,Base,d'Elegance	US5014
1982-1984	V8-4.1L	250 CID	Brougham,Brougham d'Elegance	US5010
1985-1987	V8-4.1L	250 CID	Brougham,Brougham d'Elegance,75,75 Formal,Base,d'Elegance,60 Special	US5023
1988-1990	V8-4.5L	273 CID	60 Special,Base,d'Elegance	US5023
1991-1992	V8-4.9L	300 CID	60 Special,Base,d'Elegance	US5023
1980-1986	V8-5.7L	350 CID	Air Cond; Brougham,Brougham d'Elegance	US1120
1980-1986	V8-5.7L	350 CID	Air Cond; High Performance; Brougham,Brougham d'Elegance	US1120H
1993	V8-5.7L	350 CID	High Performance; Base,Brougham,Base	US5049H
1994-1996	V8-5.7L	350 CID	Base,Brougham	US5069
1980-1984	V8-6.0L	368 CID	Base,Brougham,Brougham d'Elegance,Formal	US5003
1977-1979	V8-7.0L	425 CID		US5003
1968-1973	V8-7.7L	472 CID		US851
1970-1973	V8-8.2L	500 CID		US851
<b>SEVILLE</b>				
1981-1982	V6-4.1L	252 CID	Base,Elegante	US1018
1981-1982	V6-4.1L	252 CID	High Performance; Base,Elegante	US1018H
1982-1985	V8-4.1L	250 CID	Base,Elegante	US5010
1986-1987	V8-4.1L	250 CID	Base,Elegante	US5023
1988-1990	V8-4.5L	273 CID	Base,STS	US5023
1993-1994	V8-4.6L	281 CID	STS,SLS	US5064
1995-2004	V8-4.6L	281 CID	SLS,STS	US5072
1991-1993	V8-4.9L	300 CID	Base,STS	US5023
1980-1985	V8-5.7L	350 CID	Air Cond; Base,Elegante	US1120
1980-1985	V8-5.7L	350 CID	Air Cond; High Performance; Base,Elegante	US1120H
1980-1981	V8-6.0L	368 CID	Base,Elegante	US5003
<b>SRX</b>				
2010-2011	V6-2.8L	170 CID	Performance,Premium	US8932
2010-2011	V6-3.0L	182 CID	Base,Luxury,Performance,Premium	US8932
2004-2009	V6-3.6L	217 CID	Base	US8932
2004-2009	V8-4.6L	281 CID	Base	US8955
<b>STS</b>				
2005-2011	V6-3.6L	217 CID	Base,Platinum	US8932
2006-2009	V8-4.4L	267 CID	V	US8955
2005-2010	V8-4.6L	281 CID	Base,Platinum	US8955
<b>XLR</b>				
2006-2009	V8-4.4L	267 CID	V	US8955
2004-2009	V8-4.6L	281 CID	Base,Platinum	US8955
<b>CHECKER</b>				
<b>DELUXE</b>				
1969	V8-5.0L	307 CID	High Performance;;	US898H
1969	V8-5.3L	327 CID	High Performance;;	US898H
<b>MARATHON</b>				
1965-1967	V8-4.6L	283 CID		US898
1965-1967	V8-4.6L	283 CID	High Performance	US898H
1968-1969	V8-5.0L	307 CID		US898
1968-1969	V8-5.0L	307 CID	High Performance	US898H
1965-1969	V8-5.3L	327 CID		US898
1965-1969	V8-5.3L	327 CID	High Performance	US898H

Years	Engine	Disp.	Application Description	USMW
<b>CHERY</b>				
<b>QQ</b>				
2003-2010	L4-1.1L	1083cc		US8943
<b>CHEVROLET</b>				
<b>400 (MEX)</b>				
1992-1995	V8-5.7L	350 CID	TBI ; SS	US5049
1992-1995	V8-5.7L	350 CID	TBI High Performance ; SS	US5049H
1996-1997	V8-5.7L	350 CID	TBI ; SS	US5077
<b>ASTRA</b>				
2000-2008	L4-1.8L	110 CID		US8933
<b>ASTRA (MEX)</b>				
2000	L4-1.8L	108 CID	FI	US8933
2001-2003	L4-1.8L	109 CID	EFI DOHC	US8933
2007-2008	L4-1.8L	110 CID	MFI DOHC	US8933
2004-2008	L4-2.0L	122 CID	MFI SOHC ; Turbo DOHC	US8925
2001-2003	L4-2.2L	134 CID	MFI DOHC	US8925
2004-2006	L4-2.4L	147 CID	SFI DOHC	US8925
<b>ASTRO</b>				
1985-1986	L4-2.5L	151 CID	Base,CL,CS	US5022
1987-1990	L4-2.5L	151 CID	Base,CL,CS,LT	US5040
1985-1986	V6-4.3L	262 CID	Base,CL,CS	US1121
1985-1986	V6-4.3L	262 CID	High Performance; Base,CL,CS	US1121H
1987-1995	V6-4.3L	262 CID	Base,CL,CS,LT,LS	US5049
1987-1995	V6-4.3L	262 CID	High Performance; Base,CL,CS,LT,LS	US5049H
1996-2005	V6-4.3L	262 CID	Base,LS,LT	US5077
<b>AVALANCHE</b>				
2007-2011	V8-5.3L	325 CID	LS,LT,LTZ	US6009
2007-2009	V8-6.0L	364 CID	LT,LTZ	US6009
<b>AVALANCHE (MEX)</b>				
2010	V8-5.3L	325 CID	Flex Fuel ; 4WD	US6009
<b>AVALANCHE 1500</b>				
2002-2003	V8-5.3L	323 CID	Base,On Road Edition,Z71,North Face,WHB	US5087
2004-2005	V8-5.3L	323 CID	Base,Z66,Z71,LS,LT	US64
2004-2005	V8-5.3L	323 CID	Includes thermostat and thermostat housing; Base,Z66,Z71,LS,LT	US64-T
2006	V8-5.3L	325 CID	Includes thermostat and thermostat housing; LS,LT,Z66,Z71,LS	US64-T
<b>AVALANCHE 2500</b>				
2002-2006	V8-8.1L	496 CID	Base,LS,LT	US5089
<b>AVEO</b>				
2004-2008	L4-1.6L	98 CID	Base,LS,LT,Special Value	US6046
2009-2011	L4-1.6L	98 CID	LS,LT	US6184
<b>AVEO (MEX)</b>				
2010	L4-1.6L	97 CID	MFI DOHC	US6184
<b>AVEO5</b>				
2007-2008	L4-1.6L	98 CID	LS,Special Value	US6046
2009-2011	L4-1.6L	98 CID	LS,LT	US6184
<b>BEL AIR</b>				
1959-1960	L6-4.3L	261 CID		US898
1959-1960	L6-4.3L	261 CID	High Performance	US898H
1955-1957	V8-4.3L	265 CID		US898
1955-1957	V8-4.3L	265 CID	High Performance	US898H
1957-1967	V8-4.6L	283 CID		US898
1957-1967	V8-4.6L	283 CID	High Performance	US898H
1968	V8-5.0L	307 CID	High Performance;;	US898H
1959	V8-5.3L	322 CID	High Performance;;	US898H
1962-1969	V8-5.3L	327 CID		US898
1962-1969	V8-5.3L	327 CID	High Performance	US898H
1968-1969	V8-5.4L	327 CID		US898
1968-1969	V8-5.4L	327 CID	High Performance	US898H
1958-1961	V8-5.7L	348 CID		US898
1958-1961	V8-5.7L	348 CID	High Performance	US898H
1969-1972	V8-5.7L	350 CID		US898
1969-1972	V8-5.7L	350 CID	High Performance	US898H
1975	V8-5.7L	350 CID	High Performance;;	US1109H
1966-1969	V8-6.5L	396 CID		US981
1970-1972	V8-6.6L	400 CID		US981



# WATER PUMP APPLICATION GUIDE



Years	Engine	Disp.	Application Description	USMW
1970-1972	V8-6.6L	402 CID		US981
1975	V8-6.6L	400 CID	High Performance,;	US1109H
1966-1969	V8-7.0L	427 CID		US981
1975	V8-7.4L	454 CID	High Performance; Base,Base	US1002H
<b>BERETTA</b>				
1987-1989	L4-2.0L	122 CID	Base,GT	US5032
1990-1996	L4-2.2L	134 CID	Base,Indianapolis 500 Pace Car,GT	US5032
1990-1994	L4-2.3L	140 CID	GTZ,Indianapolis 500 Pace Car,Z26	US5043
1987-1989	V6-2.8L	173 CID	Base,GT	US5033
1990-1996	V6-3.1L	189 CID	Base,GT,Indianapolis 500 Pace Car,GTZ,Z26	US5033
<b>BISCAYNE</b>				
1958-1967	V8-4.6L	283 CID		US898
1958-1967	V8-4.6L	283 CID	High Performance	US898H
1968	V8-5.0L	307 CID	High Performance,;	US898H
1962-1969	V8-5.3L	327 CID		US898
1962-1969	V8-5.3L	327 CID	High Performance	US898H
1968-1969	V8-5.4L	327 CID		US898
1968-1969	V8-5.4L	327 CID	High Performance	US898H
1958-1961	V8-5.7L	348 CID		US898
1958-1961	V8-5.7L	348 CID	High Performance	US898H
1969-1972	V8-5.7L	350 CID		US898
1969-1972	V8-5.7L	350 CID	High Performance	US898H
1966-1969	V8-6.5L	396 CID		US981
1970-1972	V8-6.6L	400 CID		US981
1970-1972	V8-6.6L	402 CID		US981
1966-1969	V8-7.0L	427 CID		US981
<b>BLAZER</b>				
1969-1974	L6-4.8L	292 CID		US896
1995	V6-4.3L	262 CID	High Performance; Base,LT,Base	US5049H
1996-2005	V6-4.3L	262 CID	Base,LS,LT,Trailblazer,Xtreme,ZR2	US5077
1969-1972	V8-5.0L	307 CID		US898
1969-1972	V8-5.0L	307 CID	High Performance	US898H
1987	V8-5.0L	305 CID	High Performance; Custom Deluxe,Silverado	US1121H
1969-1972	V8-5.7L	350 CID		US898
1969-1972	V8-5.7L	350 CID	High Performance	US898H
1987-1988	V8-5.7L	350 CID	Custom Deluxe,Silverado,Scottsdale	US1121
1987-1988	V8-5.7L	350 CID	High Performance; Custom Deluxe,Silverado Scottsdale	US1121H
1989-1994	V8-5.7L	350 CID	High Performance; Scottsdale,Silverado; Cheyenne,High Performance; Base,Silverado Sport	US5049H
1989-1994	V8-5.7L	350 CID	Scottsdale,Silverado,Cheyenne,Base,Silverado Sport	US5049
1987-1991	V8-6.2L	379 CID	Custom Deluxe,Silverado,Scottsdale	US5008
1994	V8-6.5L	395 CID	Base,Silverado,Silverado Sport	US5062
<b>BOSS TRUCK (MEX)</b>				
1996-1997	V8-5.7L	350 CID	TBI	US5077
<b>BROOKWOOD</b>				
1958-1961	V8-4.6L	283 CID		US898
1958-1961	V8-4.6L	283 CID	High Performance	US898H
1969-1972	V8-5.0L	307 CID		US898
1969-1972	V8-5.0L	307 CID	High Performance	US898H
1969	V8-5.3L	327 CID	High Performance,;	US898H
1958-1961	V8-5.7L	348 CID		US898
1958-1961	V8-5.7L	348 CID	High Performance	US898H
1969-1972	V8-5.7L	350 CID		US898
1969-1972	V8-5.7L	350 CID	High Performance	US898H
<b>C10</b>				
1975-1977	L6-4.1L	250 CID		US1110
1978-1984	L6-4.1L	250 CID	Big Ten,Cheyenne,Custom Deluxe,Scottsdale, Silverado,Custom,Deluxe	US1107
1980	L6-4.8L	292 CID	Big Ten,Cheyenne,Custom Deluxe,Scottsdale, Silverado	US5030
1985-1986	V6-4.3L	262 CID	Custom,Scottsdale,Silverado	US1121
1985-1986	V6-4.3L	262 CID	High Performance; Custom,Scottsdale,Silverado	US1121H
1976	V8-5.0L	305 CID	High Performance,;	US1109H
1977-1986	V8-5.0L	305 CID	Big Ten,Cheyenne,Custom Deluxe,Scottsdale, Silverado,Custom,Deluxe	US1121
1977-1986	V8-5.0L	305 CID	High Performance; Big Ten,Cheyenne,Custom Deluxe, Scottsdale,Silverado,High Performance; Custom Deluxe	US1121H

Years	Engine	Disp.	Application Description	USMW
1975-1976	V8-5.7L	350 CID		US1109
1975-1976	V8-5.7L	350 CID	High Performance	US1109H
1977-1986	V8-5.7L	350 CID	Big Ten,Cheyenne,Custom Deluxe,Scottsdale, Silverado	US1121
1977-1986	V8-5.7L	350 CID	High Performance; Big Ten,Cheyenne,Custom Deluxe, Scottsdale,Silverado;	US1121H
1982-1986	V8-6.2L	379 CID	Custom,Scottsdale,Silverado	US5008
1976	V8-6.6L	400 CID	High Performance,;	US1109H
1977-1980	V8-6.6L	400 CID	Big Ten,Cheyenne,Custom Deluxe,Scottsdale Silverado	US1121
1977-1980	V8-6.6L	400 CID	High Performance; Big Ten,Cheyenne,Custom Deluxe, Scottsdale,Silverado	US1121H
1975-1980	V8-7.4L	454 CID	Big Ten,Cheyenne,Custom Deluxe,Scottsdale,Silverado	US1002
1975-1980	V8-7.4L	454 CID	High Performance; Big Ten Cheyenne,Custom Deluxe,Scottsdale,Silverado	US1002H
<b>C10 (MEX)</b>				
1979-1984	L6-4.1L	250 CID	1BL ; 1/2 Ton	US1107
1981-1986	L6-4.8L	292 CID	1BL ; 1/2 Ton	US5030
1982-1986	L6-4.8L	292 CID	1BL ; 1/2 Ton	US896
1981-1987	V8-5.7L	350 CID	2BL ; 1/2 Ton,4BL ; 1/2 Ton	US1121
1981-1987	V8-5.7L	350 CID	2BL High Performance ; 1/2 Ton, 4BL High Performance ; 1/2 Ton	US1121H
<b>C10 PICKUP</b>				
1961-1962	L6-4.3L	261 CID		US898
1961-1962	L6-4.3L	261 CID	High Performance	US898H
1965-1974	L6-4.8L	292 CID		US896
1960-1967	V8-4.6L	283 CID		US898
1960-1967	V8-4.6L	283 CID	High Performance	US898H
1968-1972	V8-5.0L	307 CID		US898
1968-1972	V8-5.0L	307 CID	High Performance	US898H
1966-1969	V8-5.3L	327 CID		US898
1966-1969	V8-5.3L	327 CID	High Performance	US898H
1968	V8-5.4L	327 CID	High Performance,;	US898H
1960-1965	V8-5.7L	348 CID		US898
1960-1965	V8-5.7L	348 CID	High Performance	US898H
1969-1972	V8-5.7L	350 CID		US898
1969-1972	V8-5.7L	350 CID	High Performance	US898H
1968-1969	V8-6.5L	396 CID		US981
1970-1972	V8-6.6L	402 CID		US981
<b>C10 SUBURBAN</b>				
1975-1977	L6-4.1L	250 CID		US1110
1978-1980	L6-4.1L	250 CID	Custom Deluxe,Scottsdale,Silverado	US1107
1961-1962	L6-4.3L	261 CID		US898
1961-1962	L6-4.3L	261 CID	High Performance	US898H
1965-1974	L6-4.8L	292 CID		US896
1960-1967	V8-4.6L	283 CID		US898
1960-1967	V8-4.6L	283 CID	High Performance	US898H
1968-1972	V8-5.0L	307 CID		US898
1968-1972	V8-5.0L	307 CID	High Performance	US898H
1976	V8-5.0L	305 CID	High Performance,;	US1109H
1977-1986	V8-5.0L	305 CID	Custom Deluxe,Scottsdale,Silverado,Custom,Deluxe	US1121
1977-1986	V8-5.0L	305 CID	High Performance; Custom Deluxe,Scottsdale Silverado,High Performance; Custom,Deluxe	US1121H
1966-1969	V8-5.3L	327 CID		US898
1966-1969	V8-5.3L	327 CID	High Performance	US898H
1968	V8-5.4L	327 CID	High Performance,;	US898H
1960-1965	V8-5.7L	348 CID		US898
1960-1965	V8-5.7L	348 CID	High Performance	US898H
1969-1972	V8-5.7L	350 CID		US898
1969-1972	V8-5.7L	350 CID	High Performance	US898H
1975-1976	V8-5.7L	350 CID		US1109
1975-1976	V8-5.7L	350 CID	High Performance	US1109H
1977-1986	V8-5.7L	350 CID	Custom Deluxe,Scottsdale,Silverado,Custom,Deluxe	US1121
1977-1986	V8-5.7L	350 CID	High Performance; Custom Deluxe,Scottsdale, Silverado,High Performance; Custom,Deluxe	US1121H
1982-1986	V8-6.2L	379 CID	Custom,Scottsdale,Silverado	US5008
1968-1969	V8-6.5L	396 CID		US981
1970-1972	V8-6.6L	402 CID		US981



Years	Engine	Disp.	Application Description	USMW
1975-1980	V8-7.4L	454 CID	Custom Deluxe,Scottsdale,Silverado	US1002
1975-1980	V8-7.4L	454 CID	High Performance; Custom Deluxe, Scottsdale,Silverado	US1002H
<b>C1405 (MEX)</b>				
1966	L6-4.8L	292 CID	1BL ; Panel 1/2 Ton	US896
1965	V6-4.8L	292 CID	1BL ; Panel 1/2 Ton	US896
1965-1966	V8-4.7L	283 CID	2BL ; Panel 1/2 Ton	US898
1965-1966	V8-4.7L	283 CID	2BL High Performance ; Panel 1/2 Ton	US898H
<b>C1500</b>				
1988-1995	V6-4.3L	262 CID	Cheyenne,Scottsdale,Silverado,WT,Base	US5049
1988-1995	V6-4.3L	262 CID	High Performance; Cheyenne,Scottsdale,Silverado, WT,High Performance; Base,Cheyenne	US5049H
1996-1998	V6-4.3L	262 CID	Base,Cheyenne,Silverado,WT	US5077
1988-1995	V8-5.0L	305 CID	Cheyenne,Scottsdale,Silverado,WT,Base	US5049
1988-1995	V8-5.0L	305 CID	High Performance; Cheyenne,Scottsdale,Silverado WT,High Performance; Base,Cheyenne	US5049H
1996-1999	V8-5.0L	305 CID	Base,Cheyenne,Silverado,WT,LS	US5077
1988-1995	V8-5.7L	350 CID	Cheyenne,Scottsdale,Silverado,WT,Base	US5049
1988-1995	V8-5.7L	350 CID	High Performance; Cheyenne,Scottsdale,Silverado WT,High Performance; Base,Cheyenne	US5049H
1992	V8-5.7L	350 CID	5.8" Hub height; Cheyenne,Silverado,WT	US5073
1996-1999	V8-5.7L	350 CID	Base,Cheyenne,Silverado,WT,LS	US5077
1988-1993	V8-6.2L	379 CID	Cheyenne,Scottsdale,Silverado,WT	US5062
1994-1995	V8-6.5L	395 CID	Base,Cheyenne,Silverado,WT	US5062
1996-1998	V8-6.5L	395 CID	Base,Cheyenne,Silverado,WT	US5074
1990-1993	V8-7.4L	454 CID	454 SS,Cheyenne,Scottsdale,Silverado,WT	US5038
1990-1993	V8-7.4L	454 CID	High Performance; 454 SS,Cheyenne,Scottsdale, Silverado,WT	US5038H
<b>C1500 (MEX)</b>				
1994-1997	L6-4.1L	250 CID	TBI ; 1/2 Ton	US895
1998	L6-4.1L	250 CID	MFI ; 1/2 Ton	US5030
1999	V8-4.3L	262 CID	MFI ; 1/2 Ton	US5077
1988-1991	V8-5.7L	350 CID	4BL ; 1/2 Ton	US5049
1988-1991	V8-5.7L	350 CID	4BL High Performance ; 1/2 Ton	US5049H
2000	V8-5.7L	350 CID	MFI ; 1/2 Ton	US5077
<b>C1500 SUBURBAN</b>				
1992	V8-5.7L	350 CID	5.8" Hub height; Base,Silverado	US5073
1992-1995	V8-5.7L	350 CID	Base,Silverado,LS,LT	US5049
1992-1995	V8-5.7L	350 CID	High Performance; Base,Silverado,LS,LT	US5049H
1996-1999	V8-5.7L	350 CID	Base,LS,LT	US5077
1995	V8-6.5L	395 CID	Base,LS,LT	US5062
1996-1998	V8-6.5L	395 CID	Base,LS,LT	US5074
1999	V8-6.5L	395 CID	Base,LS	US5086
<b>C20</b>				
1975-1984	L6-4.1L	250 CID	Cheyenne,Custom Deluxe,Scottsdale,Silverado, Custom,Deluxe	US1107
1975-1977	L6-4.8L	292 CID		US1137
1978-1986	L6-4.8L	292 CID	Cheyenne,Custom Deluxe,Scottsdale,Silverado, Custom,Deluxe	US5030
1985-1986	V6-4.3L	262 CID	Custom,Scottsdale,Silverado	US1121
1985-1986	V6-4.3L	262 CID	High Performance; Custom,Scottsdale,Silverado	US1121H
1977-1986	V8-5.0L	305 CID	Cheyenne,Custom Deluxe,Scottsdale,Silverado, Custom,Deluxe	US1121
1977-1986	V8-5.0L	305 CID	High Performance; Cheyenne,Custom Deluxe, Scottsdale,Silverado,High Performance; Custom, Deluxe	US1121H
1975-1976	V8-5.7L	350 CID		US1109
1975-1976	V8-5.7L	350 CID	High Performance	US1109H
1977-1986	V8-5.7L	350 CID	Cheyenne,Custom Deluxe,Scottsdale,Silverado, Custom,Deluxe	US1121
1977-1986	V8-5.7L	350 CID	High Performance; Cheyenne,Custom Deluxe, Scottsdale,Silverado,High Performance; Custom, Deluxe	US1121H
1982-1986	V8-6.2L	379 CID	Custom,Scottsdale,Silverado	US5008
1976	V8-6.6L	400 CID	High Performance;;	US1109H
1977-1980	V8-6.6L	400 CID	Cheyenne,Custom Deluxe,Scottsdale,Silverado	US1121
1977-1980	V8-6.6L	400 CID	High Performance; Cheyenne,Custom Deluxe, Scottsdale,Silverado	US1121H

Years	Engine	Disp.	Application Description	USMW
1975-1986	V8-7.4L	454 CID	Cheyenne,Custom Deluxe,Scottsdale,Silverado, Custom,Deluxe	US1002
1975-1986	V8-7.4L	454 CID	High Performance; Cheyenne,Custom Deluxe, Scottsdale,Silverado,High Performance; Custom, Deluxe	US1002H
<b>C20 (MEX)</b>				
1985-1987	V8-5.7L	350 CID	2BL ; 3/4 Ton,4BL ; 3/4 Ton	US1121
1985-1987	V8-5.7L	350 CID	2BL High Performance ; 3/4 Ton,4BL High Performance ; 3/4 Ton	US1121H
<b>C20 PICKUP</b>				
1961-1962	L6-4.3L	261 CID		US898
1961-1962	L6-4.3L	261 CID	High Performance	US898H
1960-1967	V8-4.6L	283 CID		US898
1960-1967	V8-4.6L	283 CID	High Performance	US898H
1968-1972	V8-5.0L	307 CID		US898
1968-1972	V8-5.0L	307 CID	High Performance	US898H
1966-1969	V8-5.3L	327 CID		US898
1966-1969	V8-5.3L	327 CID	High Performance	US898H
1968	V8-5.4L	327 CID	High Performance;;	US898H
1960-1965	V8-5.7L	348 CID		US898
1960-1965	V8-5.7L	348 CID	High Performance	US898H
1969-1972	V8-5.7L	350 CID		US898
1969-1972	V8-5.7L	350 CID	High Performance	US898H
1968-1969	V8-6.5L	396 CID		US981
1970-1972	V8-6.6L	402 CID		US981
<b>C20 SUBURBAN</b>				
1961-1962	L6-4.3L	261 CID		US898
1961-1962	L6-4.3L	261 CID	High Performance	US898H
1965-1974	L6-4.8L	292 CID		US896
1975-1977	L6-4.8L	292 CID		US1137
1978-1982	L6-4.8L	292 CID	Custom Deluxe,Scottsdale,Silverado,Custom,Deluxe	US5030
1960-1967	V8-4.6L	283 CID		US898
1960-1967	V8-4.6L	283 CID	High Performance	US898H
1968-1972	V8-5.0L	307 CID		US898
1968-1972	V8-5.0L	307 CID	High Performance	US898H
1976	V8-5.0L	305 CID	High Performance;;	US1109H
1977-1986	V8-5.0L	305 CID	Custom Deluxe,Scottsdale,Silverado,Custom,Deluxe	US1121
1977-1986	V8-5.0L	305 CID	High Performance; Custom Deluxe, Scottsdale, Silverado,High Performance; Custom,Deluxe	US1121H
1966-1969	V8-5.3L	327 CID		US898
1966-1969	V8-5.3L	327 CID	High Performance	US898H
1968	V8-5.4L	327 CID	High Performance;;	US898H
1960-1965	V8-5.7L	348 CID		US898
1960-1965	V8-5.7L	348 CID	High Performance	US898H
1969-1972	V8-5.7L	350 CID		US898
1969-1972	V8-5.7L	350 CID	High Performance	US898H
1975-1976	V8-5.7L	350 CID		US1109
1975-1976	V8-5.7L	350 CID	High Performance	US1109H
1977-1986	V8-5.7L	350 CID	Custom Deluxe,Scottsdale,Silverado,Custom,Deluxe	US1121
1977-1986	V8-5.7L	350 CID	High Performance; Custom Deluxe,Scottsdale Silverado,High Performance; Custom,Deluxe	US1121H
1982-1986	V8-6.2L	379 CID	Custom,Scottsdale,Silverado	US5008
1968-1969	V8-6.5L	396 CID		US981
1970-1972	V8-6.6L	402 CID		US981
1976	V8-6.6L	400 CID	High Performance;;	US1109H
1977-1980	V8-6.6L	400 CID	Custom Deluxe,Scottsdale,Silverado	US1121
1977-1980	V8-6.6L	400 CID	High Performance; Custom Deluxe, Scottsdale,Silverado	US1121H
1975-1986	V8-7.4L	454 CID	Custom Deluxe,Scottsdale,Silverado,Custom,Deluxe	US1002
1975-1986	V8-7.4L	454 CID	High Performance; Custom Deluxe, Scottsdale,Silverado,High Performance; Custom, Deluxe	US1002H
<b>C20905 (MEX)</b>				
1965-1967	L6-4.8L	292 CID	1BL ; Panel 1/2 Ton	US896
1965-1967	V8-4.7L	283 CID	2BL ; Panel 1/2 Ton	US898
1965-1967	V8-4.7L	283 CID	2BL High Performance ; Panel 1/2 Ton	US898H
<b>C2500</b>				
1988-1995	V6-4.3L	262 CID	Cheyenne,Scottsdale,Silverado,Base,WT	US5049

Years	Engine	Disp.	Application Description	USMW
1988-1995	V6-4.3L	262 CID	High Performance; Cheyenne,Scottsdale,Silverado High Performance; Base,Cheyenne,WT	US5049H
1988-1995	V8-5.0L	305 CID	Cheyenne,Scottsdale,Silverado,Base,WT	US5049
1988-1995	V8-5.0L	305 CID	High Performance; Cheyenne,Scottsdale,Silverado, High Performance; Base,Cheyenne,WT	US5049H
1996-1998	V8-5.0L	305 CID	Base,Cheyenne,Silverado,WT	US5077
1988-1995	V8-5.7L	350 CID	Cheyenne,Scottsdale,Silverado,Base,WT	US5049
1988-1995	V8-5.7L	350 CID	High Performance; Cheyenne,Scottsdale,Silverado High Performance; Base,Cheyenne,WT	US5049H
1996-2000	V8-5.7L	350 CID	Base,Cheyenne,Silverado,WT,LS	US5077
1988-1993	V8-6.2L	379 CID	Cheyenne,Scottsdale,Silverado	US5062
1992-1995	V8-6.5L	395 CID	Cheyenne,Silverado,Base,WT	US5062
1996-1998	V8-6.5L	395 CID	Base,Cheyenne,Silverado,WT	US5074
1999-2000	V8-6.5L	395 CID	Base,LS	US5086
1991-2000	V8-7.4L	454 CID	Cheyenne,Silverado,Base,WT,LS	US5038
1991-2000	V8-7.4L	454 CID	High Performance; Cheyenne,Silverado,High Performance; Base,Cheyenne,WT,LS	US5038H
<b>C2500 (MEX)</b>				
1988-1991	V8-5.7L	350 CID	4BL ; 3/4 Ton	US5049
1988-1991	V8-5.7L	350 CID	4BL High Performance ; 3/4 Ton	US5049H
1998	V8-5.7L	350 CID	TBI ; 3/4 Ton	US5077
2000	V8-5.7L	350 CID	MFI ; 3/4 Ton	US5087
<b>C2500 SUBURBAN</b>				
1992	V8-5.7L	350 CID	5.8" Hub height; Base,Silverado	US5073
1992-1995	V8-5.7L	350 CID	Base,Silverado,LS,LT	US5049
1992-1995	V8-5.7L	350 CID	High Performance; Base,Silverado,LS,LT	US5049H
1996-1999	V8-5.7L	350 CID	Base,LS,LT	US5077
1994-1995	V8-6.5L	395 CID	Base,Silverado,LS,LT	US5062
1996-1998	V8-6.5L	395 CID	Base,LS,LT	US5074
1999	V8-6.5L	395 CID	Base,LS	US5086
1992-1999	V8-7.4L	454 CID	Base,Silverado,LS,LT	US5038
1992-1999	V8-7.4L	454 CID	High Performance; Base,Silverado,LS,LT	US5038H
<b>C30</b>				
1980	L6-4.1L	250 CID	Cheyenne,Custom Deluxe,Scottsdale,Silverado	US1107
1975-1977	L6-4.8L	292 CID		US1137
1978-1986	L6-4.8L	292 CID	Cheyenne,Custom Deluxe,Scottsdale,Silverado, Custom,Deluxe	US5030
1978-1986	V8-5.0L	305 CID	Custom,Scottsdale,Silverado	US1121
1978-1986	V8-5.0L	305 CID	High Performance; Custom,Scottsdale,Silverado	US1121H
1975-1976	V8-5.7L	350 CID		US1109
1975-1976	V8-5.7L	350 CID	High Performance	US1109H
1977-1986	V8-5.7L	350 CID	Cheyenne,Custom Deluxe,Scottsdale,Silverado, Custom,Deluxe	US1121
1977-1986	V8-5.7L	350 CID	High Performance; Cheyenne,Custom Deluxe, Scottsdale,Silverado,High Performance; Custom, Deluxe	US1121H
1982-1986	V8-6.2L	379 CID	Custom,Scottsdale,Silverado	US5008
1976	V8-6.6L	400 CID	High Performance;,,	US1109H
1977-1979	V8-6.6L	400 CID		US1121
1977-1979	V8-6.6L	400 CID	High Performance	US1121H
1975-1986	V8-7.4L	454 CID	Cheyenne,Custom Deluxe,Scottsdale,Silverado, Custom,Deluxe	US1002
1975-1986	V8-7.4L	454 CID	High Performance; Cheyenne,Custom Deluxe, Scottsdale,Silverado,High Performance; Custom, Deluxe	US1002H
<b>C30 (MEX)</b>				
1979-1987	V8-5.7L	350 CID	2BL ; 1 Ton,4BL ; 1 Ton	US1121
1979-1987	V8-5.7L	350 CID	2BL High Performance ; 1 Ton, 4BL High Performance ; 1 Ton	US1121H
<b>C30 PICKUP</b>				
1961-1962	L6-4.3L	261 CID		US898
1961-1962	L6-4.3L	261 CID	High Performance	US898H
1965-1974	L6-4.8L	292 CID		US896
1960-1967	V8-4.6L	283 CID		US898
1960-1967	V8-4.6L	283 CID	High Performance	US898H
1968-1972	V8-5.0L	307 CID		US898
1968-1972	V8-5.0L	307 CID	High Performance	US898H
1966-1969	V8-5.3L	327 CID		US898
1966-1969	V8-5.3L	327 CID	High Performance	US898H

Years	Engine	Disp.	Application Description	USMW
1968	V8-5.4L	327 CID	High Performance;,,	US898H
1960-1965	V8-5.7L	348 CID		US898
1960-1965	V8-5.7L	348 CID	High Performance	US898H
1969-1972	V8-5.7L	350 CID		US898
1969-1972	V8-5.7L	350 CID	High Performance	US898H
1968-1969	V8-6.5L	396 CID		US981
1970-1972	V8-6.6L	402 CID		US981
<b>C3500</b>				
1988-1995	V8-5.7L	350 CID	Cheyenne,Scottsdale,Silverado,Base	US5049
1988-1995	V8-5.7L	350 CID	High Performance; Cheyenne,Scottsdale,Silverado, High Performance; Base,Cheyenne	US5049H
1996-2000	V8-5.7L	350 CID	Base,Cheyenne,Silverado,LS	US5077
1988-1993	V8-6.2L	379 CID	Cheyenne,Scottsdale,Silverado	US5062
1992-1995	V8-6.5L	395 CID	Cheyenne,Silverado,Base	US5062
1996-1998	V8-6.5L	395 CID	Base,Cheyenne,Silverado	US5074
1999-2002	V8-6.5L	395 CID	Base,LS,HD	US5086
1988-2000	V8-7.4L	454 CID	Cheyenne,Scottsdale,Silverado,Base,LS	US5038
1988-2000	V8-7.4L	454 CID	High Performance; Cheyenne,Scottsdale,Silverado, High Performance; Base,Cheyenne,LS	US5038H
2001-2002	V8-8.1L	496 CID	HD	US5090
<b>C3500 (MEX)</b>				
1989-1991	V8-5.7L	350 CID	4BL ; 1 Ton	US5049
1989-1991	V8-5.7L	350 CID	4BL High Performance ; 1 Ton	US5049H
<b>C3605 (MEX)</b>				
1967	V8-4.7L	283 CID	2BL High Performance ; Panel 3/4 Ton,Panel 3/4 Ton	US898H
<b>C3605 (MEX)</b>				
1967	L6-4.8L	292 CID	1BL ; Panel 3/4 Ton	US896
<b>CAMARO</b>				
1982-1984	L4-2.5L	151 CID	Sport	US1107
1985-1986	L4-2.5L	151 CID	Sport	US5022
1975-1979	L6-4.1L	250 CID		US1107
1982-1984	V6-2.8L	173 CID	Berlinetta,Sport	US5006
1985-1986	V6-2.8L	173 CID	Berlinetta,Sport	US5001
1987-1989	V6-2.8L	173 CID	LT,Sport,Base,RS	US5037
1990-1992	V6-3.1L	189 CID	RS,RS Heritage Edition	US5037
1993-1995	V6-3.4L	207 CID	Base	US5070
2010-2011	V6-3.6L	217 CID	LS,LT	US8932
1980-1981	V6-3.8L	229 CID	Base,Berlinetta,Rally Sport,Sport	US1121
1980-1981	V6-3.8L	229 CID	High Performance; Base,Berlinetta,Rally Sport,High Performance; Berlinetta,Sport	US1121H
1980-1981	V6-3.8L	231 CID	Base,Berlinetta,Rally Sport,Sport	US1018
1980-1981	V6-3.8L	231 CID	High Performance; Base,Berlinetta,Rally Sport,High Performance; Berlinetta,Sport	US1018H
1995	V6-3.8L	231 CID	Base	US5050
1996-2002	V6-3.8L	231 CID	Base,RS	US5075
1980-1981	V8-4.4L	267 CID	Base,Berlinetta,Rally Sport,Sport	US1121
1980-1981	V8-4.4L	267 CID	High Performance; Base,Berlinetta,Rally Sport,High Performance; Berlinetta,Sport	US1121H
1967	V8-4.6L	283 CID	High Performance;,,	US898H
1968-1972	V8-5.0L	307 CID		US898
1968-1972	V8-5.0L	307 CID	High Performance	US898H
1976	V8-5.0L	305 CID	High Performance;,,	US1109H
1977-1987	V8-5.0L	305 CID	Base,Berlinetta,Rally Sport,Z28,Sport,Z28 Indianapolis 500 Pace Car,Z28 Iroc-Z,LT	US1121
1977-1987	V8-5.0L	305 CID	High Performance; Base,Berlinetta,Rally Sport,Z28, High Performance; Berlinetta,Sport,Z28 Indianapolis 500 Pace Car,Z28 Iroc-Z,High Performance; LT	US1121H
1988-1992	V8-5.0L	305 CID	Base,Iroc-Z,RS,Z28,RS Heritage Edition, Z28 Heritage Edition	US5049
1988-1992	V8-5.0L	305 CID	High Performance; Base,Iroc-Z,High Performance; Iroc-Z,RS,High Performance; RS,Z28,RS Heritage Edition,Z28 Heritage Edition	US5049H
1967-1969	V8-5.3L	327 CID		US898
1967-1969	V8-5.3L	327 CID	High Performance	US898H
1968-1969	V8-5.4L	327 CID		US898
1968-1969	V8-5.4L	327 CID	High Performance	US898H
1967-1972	V8-5.7L	350 CID		US898
1967-1972	V8-5.7L	350 CID	High Performance	US898H
1975-1976	V8-5.7L	350 CID		US1109

Years	Engine	Disp.	Application Description	USMW
1975-1976	V8-5.7L	350 CID	High Performance	US1109H
1977-1987	V8-5.7L	350 CID	Base,Berlinetta,Rally Sport,Z28,Sport,Z28 Iroc-Z	US1121
1977-1987	V8-5.7L	350 CID	High Performance; Base,Berlinetta,Rally Sport,Z28, High Performance; Berlinetta,Sport,High Performance; Z28 Iroc-Z	US1121H
1988-1992	V8-5.7L	350 CID	High Performance; Iroc-Z,High Performance; Z28 Z28 Heritage Edition	US5049H
1988-1992	V8-5.7L	350 CID	Iroc-Z,Z28,Z28 Heritage Edition	US5049
1993-1997	V8-5.7L	350 CID	VIN P; Indianapolis 500 Pace Car,Z28,VIN P; Z28 Z28 30th Anniversary Edition, Z28 SS 30th Anniversary Edition	US5068
1998-2002	V8-5.7L	350 CID	Z28,Z28 SS	US5081
1967-1970	V8-6.5L	396 CID		US981
1970-1972	V8-6.6L	402 CID		US981
1969	V8-7.0L	427 CID		US981
<b>CAPRICE</b>				
1980-1984	V6-3.8L	229 CID	Classic,Classic Landau,Classic Sport,Classic Estate	US1121
1980-1984	V6-3.8L	229 CID	High Performance; Classic,Classic Landau, Classic Sport,Classic Estate	US1121H
1980-1984	V6-3.8L	231 CID	Classic,Classic Landau,Classic Sport,Classic Estate	US1018
1980-1984	V6-3.8L	231 CID	High Performance; Classic,Classic Landau, Classic Sport,Classic Estate	US1018H
1985-1988	V6-4.3L	262 CID	Classic,Base,Classic Brougham,Classic LS Brougham	US1121
1985-1988	V6-4.3L	262 CID	High Performance; Classic,High Performance; Base, Classic,Classic Brougham,Classic LS Brougham	US1121H
1989-1993	V6-4.3L	262 CID	Base,Classic	US5049
1989-1993	V6-4.3L	262 CID	High Performance; Base,Classic,High Performance; Classic	US5049H
1994-1996	V8-4.3L	265 CID	Classic,Classic LS	US5069
1980-1982	V8-4.4L	267 CID	Classic,Classic Landau,Classic Sport,Classic Estate	US1121
1980-1982	V8-4.4L	267 CID	High Performance; Classic,Classic Landau, Classic Sport,Classic Estate	US1121H
1966-1967	V8-4.6L	283 CID		US898
1966-1967	V8-4.6L	283 CID	High Performance	US898H
1968-1972	V8-5.0L	307 CID		US898
1968-1972	V8-5.0L	307 CID	High Performance	US898H
1977-1988	V8-5.0L	305 CID	Classic,Classic Landau,Classic Sport,Classic Estate, Base,Classic Brougham,Classic LS Brougham	US1121
1977-1988	V8-5.0L	305 CID	High Performance; Classic,Classic Landau,Classic Sport,Classic Estate,High Performance; Base,Classic,Classic Brougham,Classic LS Brougham	US1121H
1986-1990	V8-5.0L	307 CID	Air Cond; Classic,Classic Brougham Air Cond; Base,Classic	US1120
1986-1990	V8-5.0L	307 CID	Air Cond; High Performance; Classic,Classic Brougham,Air Cond; High Performance; Base,Classic	US1120H
1989-1990	V8-5.0L	305 CID	Base,Classic	US5049
1989-1990	V8-5.0L	305 CID	High Performance; Base,Classic,Classic Brougham, Classic LS Brougham	US5049H
1991-1993	V8-5.0L	305 CID	Base,Classic,Classic LTZ	US5051
1966-1969	V8-5.3L	327 CID		US898
1966-1969	V8-5.3L	327 CID	High Performance	US898H
1968-1969	V8-5.4L	327 CID		US898
1968-1969	V8-5.4L	327 CID	High Performance	US898H
1969-1972	V8-5.7L	350 CID		US898
1969-1972	V8-5.7L	350 CID	High Performance	US898H
1975-1976	V8-5.7L	350 CID		US1109
1975-1976	V8-5.7L	350 CID	High Performance	US1109H
1977-1980	V8-5.7L	350 CID	Classic,Classic Landau,Classic Sport	US1121
1977-1980	V8-5.7L	350 CID	High Performance; Classic,Classic Landau, Classic Sport	US1121H
1980-1985	V8-5.7L	350 CID	Air Cond; Classic,Classic,Classic Landau,Classic Sport,Classic Estate	US1120
1980-1985	V8-5.7L	350 CID	Air Cond; High Performance; Classic,Classic Landau Classic Sport,Classic Estate	US1120H
1981-1983	V8-5.7L	350 CID	Exc.Air Cond; Classic,Classic Estate,Classic Landau	US1100
1989-1990	V8-5.7L	350 CID	Base,Classic Brougham,Classic LS Brougham	US5049
1989-1990	V8-5.7L	350 CID	High Performance; Base	US5049H
1991-1993	V8-5.7L	350 CID	Base,Classic,Classic LTZ,Classic LS	US5051
1994-1996	V8-5.7L	350 CID	Classic,Classic LS	US5069

Years	Engine	Disp.	Application Description	USMW
2011	V8-6.0L	364 CID	PPV	US79
1966-1969	V8-6.5L	396 CID		US981
1970-1972	V8-6.6L	400 CID		US981
1970-1972	V8-6.6L	402 CID		US981
1975-1976	V8-6.6L	400 CID		US1109
1975-1976	V8-6.6L	400 CID	High Performance	US1109H
1966-1969	V8-7.0L	427 CID		US981
1975-1976	V8-7.4L	454 CID		US1002
1975-1976	V8-7.4L	454 CID	High Performance	US1002H
<b>CAPRICE (MEX)</b>				
1981	V8-5.7L	350 CID	4BL High Performance	US1121H
<b>CAPTIVA SPORT</b>				
2012-2013	L4-2.4L	145 CID		US5092
2012-2013	L4-2.4L	147 CID		US5092
<b>CAPTIVA SPORT (MEX)</b>				
2008-2009	L4-2.4L	147 CID	SFI DOHC	US8925
<b>CAVALIER</b>				
1982-1986	L4-2.0L	122 CID	Base,Cadet,CL,CS,Olympic,Type-10,RS	US5007
1987-1990	L4-2.0L	122 CID	Base,CS,RS,VL	US5032
1991-2001	L4-2.2L	134 CID	RS,VL,Base,LS,Z24	US5032
2002-2005	L4-2.2L	134 CID	Base,LS,LS Sport,Z24	US5092
1995	L4-2.3L	138 CID	LS,Z24	US5043
1996-2002	L4-2.4L	146 CID	LS,Z24,Base,RS,LS Sport	US5076
1985-1986	V6-2.8L	173 CID	Base,CL,CS,Type-10,RS,Z24	US5020
1987-1989	V6-2.8L	173 CID	Base,CS,RS,Z24,VL	US5033
1990-1994	V6-3.1L	189 CID	Base,RS,Z24	US5033
<b>CAVALIER (MEX)</b>				
1990-1994	L4-2.8L	173 CID	MFI	US5033
<b>CELEBRITY</b>				
1982-1986	L4-2.5L	151 CID	3 Groove pulley; Base,CL,CS,Eurosport,Classic,Estate	US5000P
1982-1986	L4-2.5L	151 CID	W/O Pulley; Base,CL,CS,Eurosport,Classic,Estate	US5000
1987-1990	L4-2.5L	151 CID	Base,Estate,Eurosport,CL	US5041
1982-1986	V6-2.8L	173 CID	Base,CL,CS,Eurosport,Classic,Estate	US5001
1987-1989	V6-2.8L	173 CID	Base,Estate,Eurosport,CL	US5033
1990	V6-3.1L	189 CID	Base,Eurosport	US5033
1982-1985	V6-4.3L	260 CID	Base,CL,CS,Eurosport,Classic,Estate	US5014
<b>CELEBRITY (MEX)</b>				
1982-1990	L4-2.8L	173 CID	MFI	US5033
<b>CENTURY (MEX)</b>				
1995	L4-2.2L	134 CID	MFI	US5033
1983-1990	L4-2.8L	173 CID	2BL ;MFI	US5033
1989-1997	L4-3.1L	191 CID	MFI	US5033
<b>CHEVELLE</b>				
1964-1967	V8-4.6L	283 CID		US898
1964-1967	V8-4.6L	283 CID	High Performance	US898H
1968-1972	V8-5.0L	307 CID		US898
1968-1972	V8-5.0L	307 CID	High Performance	US898H
1964-1968	V8-5.3L	327 CID		US898
1964-1968	V8-5.3L	327 CID	High Performance	US898H
1965-1968	V8-5.4L	327 CID		US898
1965-1968	V8-5.4L	327 CID	High Performance	US898H
1968-1972	V8-5.7L	350 CID		US898
1968-1972	V8-5.7L	350 CID	High Performance	US898H
1966-1970	V8-6.5L	396 CID		US981
1970-1972	V8-6.6L	400 CID		US981
1970-1972	V8-6.6L	402 CID		US981
<b>CHEVELLE (MEX)</b>				
1970	L6-3.8L	230 CID	1BL	US895
1964-1966	L6-4.1L	250 CID	1BL	US895
1967-1973	L6-4.8L	292 CID	1BL	US896
<b>CHEVETTE</b>				
1976-1987	L4-1.6L	98 CID	Base,Scooter,S,CS	US5004
1985-1986	L4-1.8L	110 CID	Base,CS	US5027
<b>CHEVY (MEX)</b>				
2009-2010	L4-1.6L	98 CID	MPFI ;,SFI SOHC	US5057
<b>CHEVY C2 (MEX)</b>				
2004-2008	L4-1.6L	98 CID	MPFI	US5057





# WATER PUMP APPLICATION GUIDE



Years	Engine	Disp.	Application Description	USMW
<b>CHEVY II</b>				
1963-1967	V8-4.6L	283 CID		US898
1963-1967	V8-4.6L	283 CID	High Performance	US898H
1968	V8-5.0L	307 CID	High Performance;	US898H
1965-1968	V8-5.3L	327 CID		US898
1965-1968	V8-5.3L	327 CID	High Performance	US898H
1965-1968	V8-5.4L	327 CID		US898
1965-1968	V8-5.4L	327 CID	High Performance	US898H
1968	V8-5.7L	350 CID	High Performance;	US898H
1968	V8-6.5L	396 CID		US981
<b>CHEVY PICKUP (MEX)</b>				
1999-2003	L4-1.6L	98 CID	MFI	US5057
<b>CHEYENNE (MEX)</b>				
2010	V8-5.3L	323 CID	FI OHV ; LT,LT 4WD	US6009
<b>CITATION</b>				
1980-1983	L4-2.5L	151 CID	3 Groove pulley; Base,Club,Custom,X-11	US5000P
1980-1983	L4-2.5L	151 CID	W/O Pulley; Base,Club,Custom,X-11	US5000
1980-1983	V6-2.8L	173 CID	Base,Club,Custom,X-11	US5001
<b>CITATION (MEX)</b>				
1986-1988	V6-2.8L	173 CID	2BL ; X-11,,2BL	US5001
<b>CITATION II</b>				
1984-1985	L4-2.5L	151 CID	3 Groove pulley; Base,X-11	US5000P
1984-1985	L4-2.5L	151 CID	W/O Pulley; Base,X-11	US5000
1984-1985	V6-2.8L	173 CID	Base,X-11	US5001
<b>CLASSIC</b>				
2004-2005	L4-2.2L	134 CID	Base,LS	US5092
<b>COBALT</b>				
2005-2010	L4-2.0L	122 CID	SS	US5092
2005-2010	L4-2.2L	134 CID	Base,LS,LT,LTZ	US5092
2006-2008	L4-2.4L	145 CID	SS,Sport	US5092
<b>COLORADO</b>				
2004-2006	L4-2.8L	169 CID	Base,LS,Sport,Sport LS,Z71,Z71 LS,Z85,Z85 LS,LT,WT	US5097
2007-2011	L4-2.9L	178 CID	LS,LT,WT	US5097
2004-2006	L5-3.5L	211 CID	Base,LS,Sport,Sport LS,Z71,Z71 LS,Z85,Z85 LS,LT,WT	US5097
2007-2011	L5-3.7L	223 CID	LS,LT,WT	US5097
2009-2011	V8-5.3L	325 CID	LT	US6009
<b>COMMERCIAL CHASSIS</b>				
1992	V6-4.3L	262 CID	High Performance; Base	US5049H
<b>CORSA (MEX)</b>				
2002	L4-1.4L	85 CID	FI SOHC	US5057
2003-2008	L4-1.8L	108 CID	FI	US8938
<b>CORSICA</b>				
1987-1989	L4-2.0L	122 CID	Base,LT	US5032
1990-1996	L4-2.2L	134 CID	LT,LTZ,Base	US5032
1987-1989	V6-2.8L	173 CID	Base,LT,LTZ	US5033
1990-1996	V6-3.1L	189 CID	LT,LTZ,Base	US5033
<b>CORVETTE</b>				
1955-1956	V8-4.3L	265 CID		US898
1955-1956	V8-4.3L	265 CID	High Performance	US898H
1957-1961	V8-4.6L	283 CID		US898
1957-1961	V8-4.6L	283 CID	High Performance	US898H
1980	V8-5.0L	305 CID	High Performance; Base,Base	US984H
1962-1968	V8-5.3L	327 CID		US898
1962-1968	V8-5.3L	327 CID	High Performance	US898H
1968	V8-5.4L	327 CID	High Performance;	US898H
1969-1972	V8-5.7L	350 CID		US898
1969-1972	V8-5.7L	350 CID	High Performance	US898H
1975-1982	V8-5.7L	350 CID	Base,Collector's Edition	US984
1975-1982	V8-5.7L	350 CID	High Performance; Base,Collector's Edition	US984H
1984-1991	V8-5.7L	350 CID	Base,Indianapolis 500 Pace Car, 35th Anniversary Edition	US5016
1984-1991	V8-5.7L	350 CID	High Performance; Base,Indianapolis 500 Pace Car, High Performance; 35th Anniversary Edition,Base	US5016H
1990-1995	V8-5.7L	350 CID	VIN J; ZR-1	US5056
1992	V8-5.7L	350 CID	VIN P; Base	US5063
1993-1996	V8-5.7L	350 CID	40th Anniversary Edition,Base,Indianapolis 500 Pace Car,Collector's Edition,Grand Sport	US5066

Years	Engine	Disp.	Application Description	USMW
1997-2004	V8-5.7L	350 CID	Base,Indianapolis 500 Pace Car,Z06,50th Anniversary Edition,50th Anniversary Edition Pace Car	US5081
2005-2007	V8-6.0L	364 CID	Base	US65N
2005-2007	V8-6.0L	364 CID	Includes thermostat and thermostat housing; Base	US65N-T
2008	V8-6.2L	376 CID	Includes thermostat and thermostat housing; Base	US65N-T
2009-2011	V8-6.2L	376 CID	Base,Grand Sport	US79
1966-1969	V8-7.0L	427 CID		US981
2006-2008	V8-7.0L	427 CID	Includes thermostat and thermostat housing; Z06 427 Limited Edition Z06,Z06	US65N-T
2006-2008	V8-7.0L	427 CID	Z06,427 Limited Edition Z06	US65N
2009-2011	V8-7.0L	427 CID	Z06,Z06 Carbon	US79
1971-1974	V8-7.4L	454 CID		US985
<b>CRUZE</b>				
2011-2013	L4-1.4L	83 CID		US6662
2011	L4-1.8L	110 CID	LS	US6184
<b>CRUZE (MEX)</b>				
2012	L4-1.8L	110 CID	SFI DOHC	US6184
<b>CRUZE LT (MEX)</b>				
2011-2013	L4-1.8L	110 CID	SFI DOHC	US6184
<b>CS1073 (MEX)</b>				
1966-1974	L6-4.1L	250 CID	1BL ; 1/2 Ton	US895
1975-1977	L6-4.1L	250 CID	1BL ; 1/2 Ton	US1110
1978	L6-4.1L	250 CID	1BL ; 1/2 Ton	US1107
1964-1974	L6-4.8L	292 CID	1BL ; 1/2 Ton	US896
1975-1977	L6-4.8L	292 CID	1BL ; 1/2 Ton	US1137
1978	L6-4.8L	292 CID	1BL ; 1/2 Ton	US5030
1964-1967	V8-4.7L	283 CID	2BL ; 1/2 Ton	US898
1964-1967	V8-4.7L	283 CID	2BL High Performance ; 1/2 Ton	US898H
1964-1969	V8-5.4L	327 CID	2BL ; 1/2 Ton	US898
1964-1969	V8-5.4L	327 CID	2BL High Performance ; 1/2 Ton	US898H
<b>CS31003 (MEX)</b>				
1964	L6-4.8L	292 CID	1BL ; 1 Ton	US669
1965-1974	L6-4.8L	292 CID	1BL ; 1 Ton	US896
1975-1977	L6-4.8L	292 CID	1BL ; 1 Ton	US1137
1978	L6-4.8L	292 CID	1BL ; 1 Ton	US5030
1964-1967	V8-4.7L	283 CID	2BL ; 1 Ton	US898
1965-1967	V8-4.7L	283 CID	2BL High Performance ; 1 Ton	US898H
1964-1969	V8-5.4L	327 CID	2BL ; 1 Ton	US898
1965-1969	V8-5.4L	327 CID	2BL High Performance ; 1 Ton	US898H
1968-1974	V8-5.7L	350 CID	2BL ; 1 Ton	US898
1968-1974	V8-5.7L	350 CID	2BL High Performance ; 1 Ton	US898H
1975-1976	V8-5.7L	350 CID	2BL ; 1 Ton	US1109
1977-1978	V8-5.7L	350 CID	2BL ; 1 Ton	US1121
1977-1978	V8-5.7L	350 CID	2BL High Performance ; 1 Ton	US1121H
<b>CUTLASS (MEX)</b>				
1994-1996	L4-2.2L	134 CID	MFI	US5033
1986-1989	L4-2.8L	173 CID	MFI	US5033
1986-1997	L4-3.1L	191 CID	MFI	US5033
<b>DEL RAY</b>				
1957	V8-4.3L	265 CID	High Performance;	US898H
1957-1958	V8-4.6L	283 CID		US898
1957-1958	V8-4.6L	283 CID	High Performance	US898H
1958	V8-5.7L	348 CID	High Performance;	US898H
<b>EL CAMINO</b>				
1975-1977	L6-4.1L	250 CID		US1107
1978-1979	V6-3.3L	200 CID		US1121
1978-1979	V6-3.3L	200 CID	High Performance	US1121H
1978-1984	V6-3.8L	231 CID	Base,Royalnight,SS,Conquista	US1018
1978-1984	V6-3.8L	231 CID	High Performance; Base,Royalnight,SS,Conquista	US1018H
1980-1984	V6-3.8L	229 CID	Base,Royalnight,Conquista,SS	US1121
1980-1984	V6-3.8L	229 CID	High Performance; Base,Royalnight,Conquista, Conquista,SS	US1121H
1985-1987	V6-4.3L	262 CID	Base,Conquista,SS	US1121
1985-1987	V6-4.3L	262 CID	High Performance; Base,Conquista,SS	US1121H
1980-1982	V8-4.4L	267 CID	Base,Royalnight,SS,Conquista	US1121
1980-1982	V8-4.4L	267 CID	High Performance; Base,Royalnight,SS,Conquista	US1121H
1959-1967	V8-4.6L	283 CID		US898
1959-1967	V8-4.6L	283 CID	High Performance	US898H

Years	Engine	Disp.	Application Description	USMW
1968-1972	V8-5.0L	307 CID		<b>US898</b>
1968-1972	V8-5.0L	307 CID	High Performance	<b>US898H</b>
1976	V8-5.0L	305 CID	High Performance,;	<b>US1109H</b>
1977-1987	V8-5.0L	305 CID	Base,Royalnight,SS,Conquista	<b>US1121</b>
1977-1987	V8-5.0L	305 CID	High Performance; Base,Royalnight,SS,Conquista	<b>US1121H</b>
1966-1969	V8-5.3L	327 CID		<b>US898</b>
1966-1969	V8-5.3L	327 CID	High Performance	<b>US898H</b>
1968	V8-5.4L	327 CID	High Performance,;	<b>US898H</b>
1959-1960	V8-5.7L	348 CID		<b>US898</b>
1959-1960	V8-5.7L	348 CID	High Performance	<b>US898H</b>
1968-1972	V8-5.7L	350 CID		<b>US898</b>
1968-1972	V8-5.7L	350 CID	High Performance	<b>US898H</b>
1975-1976	V8-5.7L	350 CID		<b>US1109</b>
1975-1976	V8-5.7L	350 CID	High Performance	<b>US1109H</b>
1977-1979	V8-5.7L	350 CID		<b>US1121</b>
1977-1979	V8-5.7L	350 CID	High Performance	<b>US1121H</b>
1983-1984	V8-5.7L	350 CID	Air Cond; Base,Conquista,SS	<b>US1120</b>
1983-1984	V8-5.7L	350 CID	Air Cond; High Performance; Base,Conquista,SS	<b>US1120H</b>
1966-1970	V8-6.5L	396 CID		<b>US981</b>
1970-1972	V8-6.6L	400 CID		<b>US981</b>
1970-1972	V8-6.6L	402 CID		<b>US981</b>
1975-1976	V8-6.6L	400 CID		<b>US1109</b>
1975-1976	V8-6.6L	400 CID	High Performance	<b>US1109H</b>
<b>EQUINOX</b>				
2010-2013	L4-2.4L	145 CID	LS,LT,LTZ,	<b>US5092</b>
2010-2011	V6-3.0L	182 CID	LT,LTZ	<b>US8932</b>
2005-2009	V6-3.4L	207 CID	LS,LT,LTZ	<b>US6145</b>
2008-2009	V6-3.6L	217 CID	Sport	<b>US8932</b>
<b>EUROSPORT (MEX)</b>				
1991-1996	L4-3.1L	191 CID	FI	<b>US5033</b>
<b>EXPRESS 1500</b>				
1996-2011	V6-4.3L	262 CID	Base,LS,LT	<b>US5077</b>
1996-2002	V8-5.0L	305 CID	Base,LS	<b>US5077</b>
2003	V8-5.3L	323 CID	Base,LS	<b>US5087</b>
2004-2005	V8-5.3L	323 CID	Base,LS	<b>US64</b>
2004-2005	V8-5.3L	323 CID	Includes thermostat and thermostat housing; Base,LS	<b>US64-T</b>
2006	V8-5.3L	325 CID	Includes thermostat and thermostat housing; LS,LT,Base	<b>US64-T</b>
2007-2011	V8-5.3L	325 CID	LS,LT,Base	<b>US6009</b>
1996-2002	V8-5.7L	350 CID	Base,LS	<b>US5077</b>
<b>EXPRESS 1500 (MEX)</b>				
2008	V8-5.3L	323 CID	SFI OHV ; 2WD	<b>US6009</b>
<b>EXPRESS 2500</b>				
1996-2005	V6-4.3L	262 CID	Base,LS	<b>US5077</b>
2003	V8-4.8L	294 CID	Base,LS	<b>US5087</b>
2004-2006	V8-4.8L	294 CID	Base,LS	<b>US64</b>
2004-2006	V8-4.8L	294 CID	Includes thermostat and thermostat housing; Base,LS	<b>US64-T</b>
2007-2011	V8-4.8L	294 CID	Base	<b>US6009</b>
1996-2002	V8-5.0L	305 CID	Base,LS	<b>US5077</b>
2003	V8-5.3L	323 CID	Base,LS	<b>US5087</b>
2004-2005	V8-5.3L	323 CID	Base,LS	<b>US64</b>
2004-2005	V8-5.3L	323 CID	Includes thermostat and thermostat housing; Base,LS	<b>US64-T</b>
1996-2002	V8-5.7L	350 CID	Base,LS	<b>US5077</b>
2003	V8-6.0L	364 CID	Base,LS	<b>US5087</b>
2004-2006	V8-6.0L	364 CID	Includes thermostat and thermostat housing; Base,LS	<b>US64-T</b>
2004-2006	V8-6.0L	364 CID	LS,Base	<b>US64</b>
2007-2011	V8-6.0L	364 CID	Base,LS,LT	<b>US6009</b>
1996-1998	V8-6.5L	395 CID	LS,Base	<b>US5074</b>
1999-2002	V8-6.5L	395 CID	Base,LS	<b>US5086</b>
2006-2011	V8-6.6L	400 CID	Base	<b>US72</b>
<b>EXPRESS 3500</b>				
2005-2006	V8-4.8L	294 CID	Base,LS	<b>US64</b>
2005-2006	V8-4.8L	294 CID	Includes thermostat and thermostat housing; Base,LS	<b>US64-T</b>
2007-2011	V8-4.8L	294 CID	Base	<b>US6009</b>
1996-2002	V8-5.7L	350 CID	Base,LS	<b>US5077</b>
2003	V8-6.0L	364 CID	Base,LS	<b>US5087</b>
2004-2006	V8-6.0L	364 CID	Base,LS,LT	<b>US64</b>
2004-2006	V8-6.0L	364 CID	Includes thermostat and thermostat housing; Base LS,LT	<b>US64-T</b>

Years	Engine	Disp.	Application Description	USMW
2007-2011	V8-6.0L	364 CID	Base,LS,LT	<b>US6009</b>
1996-1998	V8-6.5L	395 CID	Base,LS	<b>US5074</b>
1999-2002	V8-6.5L	395 CID	Base,LS	<b>US5086</b>
2006-2011	V8-6.6L	400 CID	Base	<b>US72</b>
1996-2000	V8-7.4L	454 CID	Base,LS	<b>US5038</b>
1996-2000	V8-7.4L	454 CID	High Performance; Base,LS	<b>US5038H</b>
2001-2002	V8-8.1L	496 CID	Base,LS	<b>US5090</b>
<b>EXPRESS 4500</b>				
2009-2011	V8-6.0L	364 CID	Base	<b>US6009</b>
2009-2011	V8-6.6L	400 CID	Base	<b>US72</b>
<b>FIREBIRD (MEX)</b>				
1994-1997	V8-5.7L	350 CID	MFI ; Trans Am	<b>US5068</b>
<b>FIREBIRD TRANS AM (MEX)</b>				
1998-2001	V8-5.7L	350 CID	MFI	<b>US5081</b>
<b>G10</b>				
1975-1976	L6-4.1L	250 CID		<b>US1110</b>
1977-1984	L6-4.1L	250 CID	Beauville,Chevy Van,Sportvan,Base,Bonaventure	<b>US1107</b>
1985-1986	V6-4.3L	262 CID	Beauville,Chevy Van,Sportvan	<b>US1121</b>
1985-1986	V6-4.3L	262 CID	High Performance; Beauville,Chevy Van,Sportvan	<b>US1121H</b>
1987-1995	V6-4.3L	262 CID	Beauville,Chevy Van,Sportvan	<b>US5049</b>
1987-1995	V6-4.3L	262 CID	High Performance; Beauville,Chevy Van,Sportvan	<b>US5049H</b>
1977-1986	V8-5.0L	305 CID	Beauville,Chevy Van,Sportvan,Base,Bonaventure	<b>US1121</b>
1977-1986	V8-5.0L	305 CID	High Performance; Base,Beauville,Bonaventure	<b>US1121H</b>
1987-1995	V8-5.0L	305 CID	Beauville,Chevy Van,Sportvan	<b>US5049</b>
1987-1995	V8-5.0L	305 CID	High Performance; Beauville,Chevy Van,Sportvan	<b>US5049H</b>
1975-1976	V8-5.7L	350 CID		<b>US1109</b>
1975-1976	V8-5.7L	350 CID	High Performance	<b>US1109H</b>
1977-1986	V8-5.7L	350 CID	Beauville,Chevy Van,Sportvan	<b>US1121</b>
1977-1986	V8-5.7L	350 CID	High Performance; Beauville,Chevy Van,Sportvan	<b>US1121H</b>
1987-1993	V8-5.7L	350 CID	High Performance; Sportvan	<b>US5049H</b>
1987-1993	V8-5.7L	350 CID	Sportvan	<b>US5049</b>
1976	V8-6.6L	400 CID	High Performance,;	<b>US1109H</b>
<b>G10 VAN</b>				
1968-1972	V8-5.0L	307 CID		<b>US898</b>
1968-1972	V8-5.0L	307 CID	High Performance	<b>US898H</b>
1970-1972	V8-5.7L	350 CID		<b>US898</b>
1970-1972	V8-5.7L	350 CID	High Performance	<b>US898H</b>
<b>G20</b>				
1975-1984	L6-4.1L	250 CID	Beauville,Chevy Van,Sportvan,Bonaventure	<b>US1107</b>
1975-1977	L6-4.8L	292 CID		<b>US1137</b>
1978-1980	L6-4.8L	292 CID	Beauville,Chevy Van	<b>US5030</b>
1985-1986	V6-4.3L	262 CID	Beauville,Chevy Van,Sportvan	<b>US1121</b>
1985-1986	V6-4.3L	262 CID	High Performance; Beauville,Chevy Van,Sportvan	<b>US1121H</b>
1987-1995	V6-4.3L	262 CID	Beauville,Chevy Van,Sportvan	<b>US5049</b>
1987-1995	V6-4.3L	262 CID	High Performance; Beauville,Chevy Van,Sportvan	<b>US5049H</b>
1977-1986	V8-5.0L	305 CID	Beauville,Chevy Van,Sportvan,Bonaventure	<b>US1121</b>
1977-1986	V8-5.0L	305 CID	High Performance; Beauville,Chevy Van,Sportvan, Bonaventure	<b>US1121H</b>
1987-1995	V8-5.0L	305 CID	Beauville,Chevy Van,Sportvan	<b>US5049</b>
1987-1995	V8-5.0L	305 CID	High Performance; Beauville,Chevy Van,Sportvan	<b>US5049H</b>
1975-1976	V8-5.7L	350 CID		<b>US1109</b>
1975-1976	V8-5.7L	350 CID	High Performance	<b>US1109H</b>
1977-1986	V8-5.7L	350 CID	Beauville,Chevy Van,Sportvan,Bonaventure	<b>US1121</b>
1977-1986	V8-5.7L	350 CID	High Performance; Beauville,Chevy Van,Sportvan, Bonaventure	<b>US1121H</b>
1987-1995	V8-5.7L	350 CID	Beauville,Chevy Van,Sportvan	<b>US5049</b>
1987-1995	V8-5.7L	350 CID	High Performance; Beauville,Chevy Van,Sportvan	<b>US5049H</b>
1983-1993	V8-6.2L	379 CID	Beauville,Bonaventure,Chevy Van,Sportvan	<b>US5008</b>
1994-1995	V8-6.5L	395 CID	Beauville,Chevy Van,Sportvan	<b>US5062</b>
1975-1976	V8-6.6L	400 CID		<b>US1109</b>
1975-1976	V8-6.6L	400 CID	High Performance	<b>US1109H</b>
1977-1980	V8-6.6L	400 CID	Beauville,Chevy Van,Sportvan	<b>US1121</b>
1977-1980	V8-6.6L	400 CID	High Performance; Beauville,Chevy Van,Sportvan	<b>US1121H</b>
<b>G20 VAN</b>				
1971-1974	L6-4.8L	292 CID		<b>US896</b>
1967	V8-4.6L	283 CID	High Performance,;	<b>US898H</b>
1968-1972	V8-5.0L	307 CID		<b>US898</b>

Years	Engine	Disp.	Application Description	USMW
1968-1972	V8-5.0L	307 CID	High Performance	US898H
1970-1972	V8-5.7L	350 CID		US898
1970-1972	V8-5.7L	350 CID	High Performance	US898H
<b>G30</b>				
1981-1984	L6-4.1L	250 CID	Beauville,Chevy Van,Hi-Cube,Bonaventure	US1107
1975-1977	L6-4.8L	292 CID		US1137
1978	L6-4.8L	292 CID		US5030
1985-1986	V6-4.3L	262 CID	Beauville,Chevy Van,Hi-Cube	US1121
1985-1986	V6-4.3L	262 CID	High Performance; Beauville,Chevy Van,Hi-Cube	US1121H
1987-1996	V6-4.3L	262 CID	Beauville,Chevy Van,Hi-Cube	US5049
1987-1996	V6-4.3L	262 CID	High Performance; Beauville,Chevy Van,Hi-Cube	US5049H
1978-1985	V8-5.0L	305 CID	Beauville,Chevy Van,Hi-Cube	US1121
1978-1985	V8-5.0L	305 CID	High Performance; Beauville,Chevy Van,Hi-Cube	US1121H
1975-1976	V8-5.7L	350 CID		US1109
1975-1976	V8-5.7L	350 CID	High Performance	US1109H
1977-1988	V8-5.7L	350 CID	Beauville,Chevy Van,Hi-Cube,Sportvan,Bonaventure	US1121
1977-1988	V8-5.7L	350 CID	High Performance; Beauville,Chevy Van,Hi-Cube,Sportvan,Bonaventure	US1121H
1987-1996	V8-5.7L	350 CID	Beauville,Chevy Van,Hi-Cube,Sportvan	US5049
1987-1996	V8-5.7L	350 CID	High Performance; Beauville,Chevy Van,Hi-Cube,Sportvan	US5049H
1983-1993	V8-6.2L	379 CID	Beauville,Bonaventure,Chevy Van,Hi-Cube,Sportvan	US5008
1994-1996	V8-6.5L	395 CID	Beauville,Chevy Van,Hi-Cube,Sportvan	US5062
1975-1976	V8-6.6L	400 CID		US1109
1975-1976	V8-6.6L	400 CID	High Performance	US1109H
1977-1980	V8-6.6L	400 CID	Beauville,Chevy Van,Hi-Cube,Sportvan	US1121
1977-1980	V8-6.6L	400 CID	High Performance; Beauville,Chevy Van,Hi-Cube,Sportvan	US1121H
1988-1996	V8-7.4L	454 CID	Beauville,Chevy Van,Hi-Cube,Sportvan	US5038
1988-1996	V8-7.4L	454 CID	High Performance; Beauville,Chevy Van,Hi-Cube,Sportvan	US5038H
<b>G30 VAN</b>				
1971-1974	L6-4.8L	292 CID		US896
1970-1972	V8-5.7L	350 CID		US898
1970-1972	V8-5.7L	350 CID	High Performance	US898H
<b>GRAND AM (MEX)</b>				
1999-2001	L4-3.1L	191 CID	MFI	US5033
1999-2002	L4-3.4L	207 CID	MFI	US5033
1999-2002	V6-3.8L	231 CID	MFI	US5075
<b>HHR</b>				
2008-2010	L4-2.0L	122 CID	SS,SS Panel	US5092
2006-2011	L4-2.2L	134 CID	LS,LT,LS Panel,LT Panel	US5092
2006-2011	L4-2.4L	145 CID	LT,LT Panel	US5092
<b>IMPALA</b>				
1977-1979	L6-4.1L	250 CID		US1107
2000-2005	V6-3.4L	207 CID	Base	US5033
2006-2011	V6-3.5L	213 CID	LS,LT,50th Anniversary Edition	US6020
1980-1984	V6-3.8L	229 CID	Base,Sport,Estate	US1121
1980-1984	V6-3.8L	229 CID	High Performance; Base,Sport,Estate	US1121H
1980-1984	V6-3.8L	231 CID	Base,Sport,Estate	US1018
1980-1984	V6-3.8L	231 CID	High Performance; Base,Sport,Estate	US1018H
2000-2005	V6-3.8L	231 CID	Base,LS,LS Sport,SS	US5075
2006-2011	V6-3.9L	237 CID	LS,LT,LTZ	US6020
1985	V6-4.3L	262 CID	High Performance; Base,Base	US1121H
1980-1982	V8-4.4L	267 CID	Base,Sport,Estate	US1121
1980-1982	V8-4.4L	267 CID	High Performance; Base,Sport,Estate	US1121H
1958-1967	V8-4.6L	283 CID		US898
1958-1967	V8-4.6L	283 CID	High Performance	US898H
1968-1972	V8-5.0L	307 CID		US898
1968-1972	V8-5.0L	307 CID	High Performance	US898H
1977-1985	V8-5.0L	305 CID	Base,Sport,Estate	US1121
1977-1985	V8-5.0L	305 CID	High Performance; Base,Sport,Estate	US1121H
1962-1969	V8-5.3L	327 CID		US898
1962-1969	V8-5.3L	327 CID	High Performance	US898H
2006-2009	V8-5.3L	325 CID	SS	US6154
1964-1969	V8-5.4L	327 CID		US898
1964-1969	V8-5.4L	327 CID	High Performance	US898H
1958-1961	V8-5.7L	348 CID		US898
1958-1961	V8-5.7L	348 CID	High Performance	US898H

Years	Engine	Disp.	Application Description	USMW
1969-1972	V8-5.7L	350 CID		US898
1969-1972	V8-5.7L	350 CID	High Performance	US898H
1975-1976	V8-5.7L	350 CID		US1109
1975-1976	V8-5.7L	350 CID	High Performance	US1109H
1977-1985	V8-5.7L	350 CID	Base,Sport,Estate	US1121
1977-1985	V8-5.7L	350 CID	High Performance; Base,Sport,Estate	US1121H
1980-1985	V8-5.7L	350 CID	Air Cond; Base,Base,Sport,Estate	US1120
1980-1985	V8-5.7L	350 CID	Air Cond; High Performance; Base,Sport,Estate	US1120H
1985	V8-5.7L	350 CID	Exc.Air Cond; Base	US1100
1994-1996	V8-5.7L	350 CID	SS	US5069
1966-1969	V8-6.5L	396 CID		US981
1970-1972	V8-6.6L	400 CID		US981
1970-1972	V8-6.6L	402 CID		US981
1975-1976	V8-6.6L	400 CID		US1109
1975-1976	V8-6.6L	400 CID	High Performance	US1109H
1966-1969	V8-7.0L	427 CID		US981
1975-1976	V8-7.4L	454 CID		US1002
1975-1976	V8-7.4L	454 CID	High Performance	US1002H
<b>IMPALA (MEX)</b>				
1965	L6-4.1L	250 CID	1BL	US895
1975-1976	L6-4.1L	250 CID	1BL	US1110
1965-1972	L6-4.8L	292 CID	1BL	US895
<b>JOY (MEX)</b>				
1994-1995	L4-1.4L	85 CID	MFI	US5057
1996-2003	L4-1.6L	98 CID	MFI	US5057
<b>K10</b>				
1975-1977	L6-4.1L	250 CID		US1110
1978-1984	L6-4.1L	250 CID	Cheyenne,Custom Deluxe,Scottsdale,Silverado,Custom,Deluxe	US1107
1980	L6-4.8L	292 CID	Cheyenne,Custom Deluxe,Scottsdale,Silverado	US5030
1985-1986	V6-4.3L	262 CID	Custom,Scottsdale,Silverado	US1121
1985-1986	V6-4.3L	262 CID	High Performance; Custom,Scottsdale,Silverado	US1121H
1977-1986	V8-5.0L	305 CID	Custom,Deluxe,Scottsdale,Silverado	US1121
1977-1986	V8-5.0L	305 CID	High Performance; Custom,Deluxe,Scottsdale,Silverado	US1121H
1975-1976	V8-5.7L	350 CID		US1109
1975-1976	V8-5.7L	350 CID	High Performance	US1109H
1977-1986	V8-5.7L	350 CID	Cheyenne,Custom Deluxe,Scottsdale,Silverado,Custom,Deluxe	US1121
1977-1986	V8-5.7L	350 CID	High Performance; Cheyenne,Custom Deluxe,Scottsdale,Silverado,Custom,Deluxe	US1121H
1982-1986	V8-6.2L	379 CID	Custom,Scottsdale,Silverado	US5008
1975-1976	V8-6.6L	400 CID		US1109
1975-1976	V8-6.6L	400 CID	High Performance	US1109H
1977-1980	V8-6.6L	400 CID	Cheyenne,Custom Deluxe,Scottsdale,Silverado	US1121
1977-1980	V8-6.6L	400 CID	High Performance; Cheyenne,Custom Deluxe,Scottsdale,Silverado	US1121H
1980	V8-7.4L	454 CID	High Performance; Cheyenne,Custom Deluxe,Scottsdale,Silverado,Cheyenne	US1002H
<b>K10 PICKUP</b>				
1961-1962	L6-4.3L	261 CID		US898
1961-1962	L6-4.3L	261 CID	High Performance	US898H
1965-1974	L6-4.8L	292 CID		US896
1960-1967	V8-4.6L	283 CID		US898
1960-1967	V8-4.6L	283 CID	High Performance	US898H
1968-1972	V8-5.0L	307 CID		US898
1968-1972	V8-5.0L	307 CID	High Performance	US898H
1966-1969	V8-5.3L	327 CID		US898
1966-1969	V8-5.3L	327 CID	High Performance	US898H
1968	V8-5.4L	327 CID	High Performance;,,	US898H
1960-1965	V8-5.7L	348 CID		US898
1960-1965	V8-5.7L	348 CID	High Performance	US898H
1969-1972	V8-5.7L	350 CID		US898
1969-1972	V8-5.7L	350 CID	High Performance	US898H
1968-1969	V8-6.5L	396 CID		US981
1970-1972	V8-6.6L	402 CID		US981
<b>K10 SUBURBAN</b>				
1975-1977	L6-4.1L	250 CID		US1110
1978-1980	L6-4.1L	250 CID	Custom Deluxe,Scottsdale,Silverado	US1107



Years	Engine	Disp.	Application Description	USMW
1961-1962	L6-4.3L	261 CID		<b>US898</b>
1961-1962	L6-4.3L	261 CID	High Performance	<b>US898H</b>
1965-1970	L6-4.8L	292 CID		<b>US896</b>
1960-1967	V8-4.6L	283 CID		<b>US898</b>
1960-1967	V8-4.6L	283 CID	High Performance	<b>US898H</b>
1968-1972	V8-5.0L	307 CID		<b>US898</b>
1968-1972	V8-5.0L	307 CID	High Performance	<b>US898H</b>
1976	V8-5.0L	305 CID	High Performance;;	<b>US1109H</b>
1977-1986	V8-5.0L	305 CID	Custom Deluxe,Scottsdale,Silverado,Custom,Deluxe	<b>US1121</b>
1977-1986	V8-5.0L	305 CID	High Performance; Custom Deluxe,Scottsdale,Silverado,High Performance; Custom,Deluxe	<b>US1121H</b>
1966-1969	V8-5.3L	327 CID		<b>US898</b>
1966-1969	V8-5.3L	327 CID	High Performance	<b>US898H</b>
1968	V8-5.4L	327 CID	High Performance;;	<b>US898H</b>
1960-1965	V8-5.7L	348 CID		<b>US898</b>
1960-1965	V8-5.7L	348 CID	High Performance	<b>US898H</b>
1969-1972	V8-5.7L	350 CID		<b>US898</b>
1969-1972	V8-5.7L	350 CID	High Performance	<b>US898H</b>
1975-1976	V8-5.7L	350 CID		<b>US1109</b>
1975-1976	V8-5.7L	350 CID	High Performance	<b>US1109H</b>
1977-1986	V8-5.7L	350 CID	Custom Deluxe,Scottsdale,Silverado,Custom,Deluxe	<b>US1121</b>
1977-1986	V8-5.7L	350 CID	High Performance; Custom Deluxe,Scottsdale,Silverado,High Performance; Custom,Deluxe	<b>US1121H</b>
1982-1986	V8-6.2L	379 CID	Custom,Scottsdale,Silverado	<b>US5008</b>
1968-1969	V8-6.5L	396 CID		<b>US981</b>
1970-1972	V8-6.6L	402 CID		<b>US981</b>
1975-1976	V8-6.6L	400 CID		<b>US1109</b>
1975-1976	V8-6.6L	400 CID	High Performance	<b>US1109H</b>
1977-1979	V8-6.6L	400 CID		<b>US1121</b>
1977-1979	V8-6.6L	400 CID	High Performance	<b>US1121H</b>
<b>K1500</b>				
1988-1995	V6-4.3L	262 CID	Cheyenne,Scottsdale,Silverado,WT,Sport,Base	<b>US5049</b>
1988-1995	V6-4.3L	262 CID	High Performance; Cheyenne,Scottsdale,Silverado,WT,Sport,High Performance; Base	<b>US5049H</b>
1996-1998	V6-4.3L	262 CID	Base,Cheyenne,Silverado,WT	<b>US5077</b>
1988-1995	V8-5.0L	305 CID	Cheyenne,Scottsdale,Silverado,WT,Sport,Base	<b>US5049</b>
1988-1995	V8-5.0L	305 CID	High Performance; Cheyenne,Scottsdale,Silverado,WT,Sport,High Performance; Base	<b>US5049H</b>
1996-1999	V8-5.0L	305 CID	Base,Cheyenne,Silverado,WT,LS	<b>US5077</b>
1988-1995	V8-5.7L	350 CID	Cheyenne,Scottsdale,Silverado,WT,Sport,Base	<b>US5049</b>
1988-1995	V8-5.7L	350 CID	High Performance; Cheyenne,Scottsdale,Silverado,WT,Sport,High Performance; Base	<b>US5049H</b>
1996-1999	V8-5.7L	350 CID	Base,Cheyenne,Silverado,WT,LS	<b>US5077</b>
1988-1993	V8-6.2L	379 CID	Cheyenne,Scottsdale,Silverado,WT,Sport	<b>US5062</b>
1994-1995	V8-6.5L	395 CID	Base,Cheyenne,Silverado,WT	<b>US5062</b>
1996-1998	V8-6.5L	395 CID	Base,Cheyenne,Silverado,WT	<b>US5074</b>
<b>K1500 (MEX)</b>				
2000	V8-5.7L	350 CID	MFI ; 1/2 Ton 4WD	<b>US5077</b>
<b>K1500 SUBURBAN</b>				
1992-1994	V6-4.3L	262 CID	Base,Silverado	<b>US5049</b>
1992	V8-5.7L	350 CID	5.8" Hub height; Base,Silverado	<b>US5073</b>
1992-1995	V8-5.7L	350 CID	High Performance; Base,Silverado,LS,LT	<b>US5049H</b>
1995	V8-5.7L	350 CID	Base,LS,LT	<b>US5049</b>
1996-1999	V8-5.7L	350 CID	Base,LS,LT	<b>US5077</b>
1995	V8-6.5L	395 CID	Base,LS,LT	<b>US5062</b>
1996-1998	V8-6.5L	395 CID	Base,LS,LT	<b>US5074</b>
1999	V8-6.5L	395 CID	Base,LS	<b>US5086</b>
<b>K20</b>				
1980	L6-4.1L	250 CID	Cheyenne,Custom Deluxe,Scottsdale,Silverado	<b>US1107</b>
1975-1977	L6-4.8L	292 CID		<b>US1137</b>
1978-1986	L6-4.8L	292 CID	Cheyenne,Custom Deluxe,Scottsdale,Silverado,Custom,Deluxe	<b>US5030</b>
1985	V6-4.3L	262 CID	High Performance; Custom,Scottsdale,Silverado	<b>US1121H</b>
1977-1985	V8-5.0L	305 CID	Cheyenne,Custom Deluxe,Scottsdale,Silverado,Custom	<b>US1121</b>
1977-1985	V8-5.0L	305 CID	High Performance; Cheyenne,Custom Deluxe,Scottsdale,Silverado,High Performance; Custom	<b>US1121H</b>
1975-1976	V8-5.7L	350 CID		<b>US1109</b>
1975-1976	V8-5.7L	350 CID	High Performance	<b>US1109H</b>

Years	Engine	Disp.	Application Description	USMW
1977-1986	V8-5.7L	350 CID	Cheyenne,Custom Deluxe,Scottsdale,Silverado Custom,Deluxe	<b>US1121</b>
1977-1986	V8-5.7L	350 CID	High Performance; Cheyenne,Custom Deluxe,Scottsdale,Silverado,High Performance; Custom,Deluxe	<b>US1121H</b>
1982-1986	V8-6.2L	379 CID	Custom,Scottsdale,Silverado	<b>US5008</b>
1975-1976	V8-6.6L	400 CID		<b>US1109</b>
1975-1976	V8-6.6L	400 CID	High Performance	<b>US1109H</b>
1977-1980	V8-6.6L	400 CID	Cheyenne,Custom Deluxe,Scottsdale,Silverado	<b>US1121</b>
1977-1980	V8-6.6L	400 CID	High Performance; Cheyenne,Custom Deluxe,Scottsdale,Silverado	<b>US1121H</b>
1980	V8-7.4L	454 CID	High Performance; Cheyenne,Custom Deluxe,Scottsdale,Silverado,Cheyenne	<b>US1002H</b>
<b>K20 PANEL</b>				
1967	V8-4.6L	283 CID	High Performance;;	<b>US898H</b>
1967	V8-5.4L	327 CID	High Performance;;	<b>US898H</b>
<b>K20 PICKUP</b>				
1961-1962	L6-4.3L	261 CID		<b>US898</b>
1961-1962	L6-4.3L	261 CID	High Performance	<b>US898H</b>
1965-1974	L6-4.8L	292 CID		<b>US896</b>
1960-1967	V8-4.6L	283 CID		<b>US898</b>
1960-1967	V8-4.6L	283 CID	High Performance	<b>US898H</b>
1968-1972	V8-5.0L	307 CID		<b>US898</b>
1968-1972	V8-5.0L	307 CID	High Performance	<b>US898H</b>
1966-1969	V8-5.3L	327 CID		<b>US898</b>
1966-1969	V8-5.3L	327 CID	High Performance	<b>US898H</b>
1968	V8-5.4L	327 CID	High Performance;;	<b>US898H</b>
1960-1965	V8-5.7L	348 CID		<b>US898</b>
1960-1965	V8-5.7L	348 CID	High Performance	<b>US898H</b>
1969-1972	V8-5.7L	350 CID		<b>US898</b>
1969-1972	V8-5.7L	350 CID	High Performance	<b>US898H</b>
1968-1969	V8-6.5L	396 CID		<b>US981</b>
1970-1972	V8-6.6L	402 CID		<b>US981</b>
<b>K20 SUBURBAN</b>				
1961-1962	L6-4.3L	261 CID		<b>US898</b>
1961-1962	L6-4.3L	261 CID	High Performance	<b>US898H</b>
1965-1974	L6-4.8L	292 CID		<b>US896</b>
1975-1977	L6-4.8L	292 CID		<b>US1137</b>
1978-1982	L6-4.8L	292 CID	Custom Deluxe,Scottsdale,Silverado,Custom,Deluxe	<b>US5030</b>
1960-1967	V8-4.6L	283 CID		<b>US898</b>
1960-1967	V8-4.6L	283 CID	High Performance	<b>US898H</b>
1968-1972	V8-5.0L	307 CID		<b>US898</b>
1968-1972	V8-5.0L	307 CID	High Performance	<b>US898H</b>
1977-1986	V8-5.0L	305 CID	Custom,Scottsdale,Silverado	<b>US1121</b>
1977-1986	V8-5.0L	305 CID	High Performance; Custom,Scottsdale,Silverado	<b>US1121H</b>
1966-1969	V8-5.3L	327 CID		<b>US898</b>
1966-1969	V8-5.3L	327 CID	High Performance	<b>US898H</b>
1968	V8-5.4L	327 CID	High Performance;;	<b>US898H</b>
1960-1965	V8-5.7L	348 CID		<b>US898</b>
1960-1965	V8-5.7L	348 CID	High Performance	<b>US898H</b>
1969-1972	V8-5.7L	350 CID		<b>US898</b>
1969-1972	V8-5.7L	350 CID	High Performance	<b>US898H</b>
1975-1976	V8-5.7L	350 CID		<b>US1109</b>
1975-1976	V8-5.7L	350 CID	High Performance	<b>US1109H</b>
1977-1986	V8-5.7L	350 CID	Custom Deluxe,Scottsdale,Silverado,Custom,Deluxe	<b>US1121</b>
1977-1986	V8-5.7L	350 CID	High Performance; Custom Deluxe,Scottsdale,Silverado,High Performance; Custom,Deluxe	<b>US1121H</b>
1982-1986	V8-6.2L	379 CID	Custom,Scottsdale,Silverado	<b>US5008</b>
1968-1969	V8-6.5L	396 CID		<b>US981</b>
1970-1972	V8-6.6L	402 CID		<b>US981</b>
1975-1976	V8-6.6L	400 CID		<b>US1109</b>
1975-1976	V8-6.6L	400 CID	High Performance	<b>US1109H</b>
1977-1980	V8-6.6L	400 CID	Custom Deluxe,Scottsdale,Silverado	<b>US1121</b>
1977-1980	V8-6.6L	400 CID	High Performance; Custom Deluxe,Scottsdale,Silverado	<b>US1121H</b>
1985	V8-7.4L	454 CID	High Performance; Scottsdale,Silverado,Custom	<b>US1002H</b>
<b>K2500</b>				
1988-1995	V6-4.3L	262 CID	Cheyenne,Scottsdale,Silverado,Base,WT	<b>US5049</b>

Years	Engine	Disp.	Application Description	USMW
1988-1995	V6-4.3L	262 CID	High Performance; Cheyenne,Scottsdale,Silverado, High Performance; Base,Cheyenne,WT	<b>US5049H</b>
1988-1995	V8-5.0L	305 CID	Cheyenne,Scottsdale,Silverado,Base,WT	<b>US5049</b>
1988-1995	V8-5.0L	305 CID	High Performance; Cheyenne,Scottsdale,Silverado, High Performance; Base,Cheyenne,WT	<b>US5049H</b>
1998	V8-5.0L	305 CID	Cheyenne,Silverado,WT	<b>US5077</b>
1988-1995	V8-5.7L	350 CID	Cheyenne,Scottsdale,Silverado,Base,WT	<b>US5049</b>
1988-1995	V8-5.7L	350 CID	High Performance; Cheyenne,Scottsdale,Silverado High Performance; Base,Cheyenne,WT	<b>US5049H</b>
1996-2000	V8-5.7L	350 CID	Base,Cheyenne,Silverado,WT,LS	<b>US5077</b>
1988-1993	V8-6.2L	379 CID	Cheyenne,Scottsdale,Silverado	<b>US5062</b>
1992-1995	V8-6.5L	395 CID	Cheyenne,Silverado,Base,WT	<b>US5062</b>
1996-1998	V8-6.5L	395 CID	Base,Cheyenne,Silverado,WT	<b>US5074</b>
1999-2000	V8-6.5L	395 CID	Base,LS	<b>US5086</b>
1991-2000	V8-7.4L	454 CID	Cheyenne,Silverado,Base,WT,LS	<b>US5038</b>
1991-2000	V8-7.4L	454 CID	High Performance; Cheyenne,Silverado, High Performance; Base,Cheyenne,WT,LS	<b>US5038H</b>
<b>K2500 (MEX)</b>				
2000	V8-5.7L	350 CID	MFI ; 3/4 Ton 4WD	<b>US5077</b>
<b>K2500 SUBURBAN</b>				
1992	V8-5.7L	350 CID	5.8" Hub height; Base,Silverado	<b>US5073</b>
1992-1995	V8-5.7L	350 CID	Base,Silverado,LS,LT	<b>US5049</b>
1992-1995	V8-5.7L	350 CID	High Performance; Base,Silverado,LS,LT	<b>US5049H</b>
1996-1999	V8-5.7L	350 CID	Base,LS,LT	<b>US5077</b>
1994-1995	V8-6.5L	395 CID	Base,Silverado,LS,LT	<b>US5062</b>
1996-1998	V8-6.5L	395 CID	Base,LS,LT	<b>US5074</b>
1999	V8-6.5L	395 CID	Base,LS	<b>US5086</b>
1992-1999	V8-7.4L	454 CID	Base,Silverado,LS,LT	<b>US5038</b>
1992-1999	V8-7.4L	454 CID	High Performance; Base,Silverado,LS,LT	<b>US5038H</b>
<b>K30</b>				
1977-1986	L6-4.8L	292 CID	Cheyenne,Custom Deluxe,Scottsdale,Silverado, Custom,Deluxe	<b>US5030</b>
1977-1986	V8-5.7L	350 CID	Cheyenne,Custom Deluxe,Scottsdale,Silverado, Custom,Deluxe	<b>US1121</b>
1977-1986	V8-5.7L	350 CID	High Performance; Cheyenne,Custom Deluxe, Scottsdale,Silverado, Custom,Deluxe	<b>US1121H</b>
1982-1986	V8-6.2L	379 CID	Custom,Scottsdale,Silverado	<b>US5008</b>
1977-1980	V8-6.6L	400 CID	Cheyenne,Custom Deluxe,Scottsdale,Silverado	<b>US1121</b>
1977-1980	V8-6.6L	400 CID	High Performance; Cheyenne,Custom Deluxe, Scottsdale,Silverado	<b>US1121H</b>
1980-1986	V8-7.4L	454 CID	Cheyenne,Custom Deluxe,Scottsdale,Silverado, Custom,Deluxe	<b>US1002</b>
1980-1986	V8-7.4L	454 CID	High Performance; Cheyenne,Custom Deluxe, Scottsdale,Silverado,Custom,Deluxe	<b>US1002H</b>
<b>K30 PICKUP</b>				
1968-1974	L6-4.8L	292 CID		<b>US896</b>
1968-1972	V8-5.0L	307 CID		<b>US898</b>
1968-1972	V8-5.0L	307 CID	High Performance	<b>US898H</b>
1968-1969	V8-5.3L	327 CID		<b>US898</b>
1968-1969	V8-5.3L	327 CID	High Performance	<b>US898H</b>
1968	V8-5.4L	327 CID	High Performance,;	<b>US898H</b>
1969-1972	V8-5.7L	350 CID		<b>US898</b>
1969-1972	V8-5.7L	350 CID	High Performance	<b>US898H</b>
1968-1969	V8-6.5L	396 CID		<b>US981</b>
1970-1972	V8-6.6L	402 CID		<b>US981</b>
<b>K3500</b>				
1988-1995	V8-5.7L	350 CID	Cheyenne,Scottsdale,Silverado,Base	<b>US5049</b>
1988-1995	V8-5.7L	350 CID	High Performance; Cheyenne,Scottsdale,Silverado, Base	<b>US5049H</b>
1996-2000	V8-5.7L	350 CID	Base,Cheyenne,Silverado,LS	<b>US5077</b>
1988-1993	V8-6.2L	379 CID	Cheyenne,Scottsdale,Silverado	<b>US5062</b>
1992-1995	V8-6.5L	395 CID	Cheyenne,Silverado,Base	<b>US5062</b>
1996-1998	V8-6.5L	395 CID	Base,Cheyenne,Silverado	<b>US5074</b>
1999-2000	V8-6.5L	395 CID	Base,LS	<b>US5086</b>
1988-2000	V8-7.4L	454 CID	Cheyenne,Scottsdale,Silverado,Base,LS	<b>US5038</b>
1988-2000	V8-7.4L	454 CID	High Performance; Cheyenne,Scottsdale,Silverado, Base,Cheyenne,LS	<b>US5038H</b>
<b>K5 BLAZER</b>				
1975-1977	L6-4.1L	250 CID		<b>US1110</b>

Years	Engine	Disp.	Application Description	USMW
1978-1982	L6-4.1L	250 CID	Cheyenne,Custom Deluxe,Silverado,Custom,Deluxe	<b>US1107</b>
1977-1986	V8-5.0L	305 CID	Cheyenne,Custom Deluxe,Silverado,Custom, Deluxe,Scottsdale	<b>US1121</b>
1977-1986	V8-5.0L	305 CID	High Performance; Cheyenne,Custom Deluxe, Silverado, Custom,Deluxe,Scottsdale	<b>US1121H</b>
1975-1976	V8-5.7L	350 CID		<b>US1109</b>
1975-1976	V8-5.7L	350 CID	High Performance	<b>US1109H</b>
1977-1986	V8-5.7L	350 CID	Cheyenne,Custom Deluxe,Silverado,Custom,Deluxe Scottsdale	<b>US1121</b>
1977-1986	V8-5.7L	350 CID	High Performance; Cheyenne,Custom Deluxe, Silverado, Custom,Deluxe,Scottsdale	<b>US1121H</b>
1982-1986	V8-6.2L	379 CID	Custom,Silverado,Scottsdale	<b>US5008</b>
1975-1976	V8-6.6L	400 CID		<b>US1109</b>
1975-1976	V8-6.6L	400 CID	High Performance	<b>US1109H</b>
1977-1979	V8-6.6L	400 CID		<b>US1121</b>
1977-1979	V8-6.6L	400 CID	High Performance	<b>US1121H</b>
<b>KINGSWOOD</b>				
1959-1961	V8-4.6L	283 CID		<b>US898</b>
1959-1961	V8-4.6L	283 CID	High Performance	<b>US898H</b>
1969-1972	V8-5.0L	307 CID		<b>US898</b>
1969-1972	V8-5.0L	307 CID	High Performance	<b>US898H</b>
1969	V8-5.3L	327 CID	High Performance,;	<b>US898H</b>
1959-1961	V8-5.7L	348 CID		<b>US898</b>
1959-1961	V8-5.7L	348 CID	High Performance	<b>US898H</b>
1969-1972	V8-5.7L	350 CID		<b>US898</b>
1969-1972	V8-5.7L	350 CID	High Performance	<b>US898H</b>
<b>LLV</b>				
1994-1995	L4-2.2L	134 CID	Base	<b>US5032</b>
1987-1993	L4-2.5L	151 CID	Base	<b>US5040</b>
<b>LUMINA</b>				
1990-1992	L4-2.5L	151 CID	Base	<b>US5041</b>
1990-2001	V6-3.1L	189 CID	Base,Euro,Euro 3.4,LS,LTZ	<b>US5033</b>
1991-1997	V6-3.4L	207 CID	Euro,Z34,Euro 3.4,LS,LTZ	<b>US5033</b>
1998-1999	V6-3.8L	231 CID	LTZ,Base,LS	<b>US5075</b>
<b>LUMINA APV</b>				
1990-1996	V6-3.1L	189 CID	Base,CL,LS	<b>US5033</b>
1992-1995	V6-3.8L	231 CID	Base,CL,LS	<b>US5050</b>
<b>LUMINA VAN (MEX)</b>				
1997	L4-3.3L	204 CID	MFI	<b>US5033</b>
<b>LUV</b>				
1975-1982	L4-1.8L	111 CID	Base,Mikado,Sport	<b>US1127</b>
1981-1982	L4-2.2L	134 CID		<b>US9132</b>
<b>LUV (MEX)</b>				
1997-1999	L4-2.2L	133 CID	MFI	<b>US5032</b>
2000-2006	L4-2.2L	133 CID	MFI	<b>US8925</b>
<b>MALIBU</b>				
2004-2008	L4-2.2L	134 CID	Base,LS,LT,Classic LS	<b>US5092</b>
1997-1999	L4-2.4L	146 CID	Base	<b>US5076</b>
2008-2013	L4-2.4L	145 CID	Hybrid,LS,LT,LTZ,	<b>US5092</b>
1975-1977	L6-4.1L	250 CID		<b>US1107</b>
1997-2003	V6-3.1L	189 CID	Base,LS	<b>US5033</b>
1978-1979	V6-3.3L	200 CID		<b>US1121</b>
1978-1979	V6-3.3L	200 CID	High Performance	<b>US1121H</b>
2004-2006	V6-3.5L	213 CID	LS,LT,Maxx,Maxx LS,Maxx LT,LTZ,Maxx LTZ	<b>US5033</b>
2007-2010	V6-3.5L	213 CID	LS,LT,LTZ,Maxx LT,Maxx LTZ,Classic LS,Classic LT	<b>US6020</b>
2008-2011	V6-3.6L	217 CID	LT,LTZ	<b>US8932</b>
1978-1983	V6-3.8L	231 CID	Base,Classic,Classic Estate,Classic Landau,Classic Sport,Estate,Sport	<b>US1018</b>
1978-1983	V6-3.8L	231 CID	High Performance; Base,Classic Classic Estate,Classic Landau,Classic Sport,Estate, Sport	<b>US1018H</b>
1980-1983	V6-3.8L	229 CID	Base,Classic,Classic Estate,Classic Landau, Classic Sport,Estate,Sport	<b>US1121</b>
1980-1983	V6-3.8L	229 CID	High Performance; Base,Classic,Classic Estate, Classic Landau,Classic Sport,Estate,Sport	<b>US1121H</b>
2006-2007	V6-3.9L	237 CID	Maxx SS,SS,Maxx LS	<b>US6020</b>
1982-1983	V6-4.3L	260 CID	Classic	<b>US5012</b>

Years	Engine	Disp.	Application Description	USMW
1980-1982	V8-4.4L	267 CID	Base,Classic,Classic Estate,Classic Landau, Classic Sport,Estate,Sport	US1121
1980-1982	V8-4.4L	267 CID	High Performance; Base,Classic,Classic Estate, Classic Landau,Classic Sport,Estate,Sport	US1121H
1964-1967	V8-4.6L	283 CID		US898
1964-1967	V8-4.6L	283 CID	High Performance	US898H
1976	V8-5.0L	305 CID	High Performance;;	US1109H
1977-1983	V8-5.0L	305 CID	Base,Classic,Classic Estate,Classic Landau, Classic Sport,Estate,Sport	US1121
1977-1983	V8-5.0L	305 CID	High Performance; Base,Classic, Classic Estate,Classic Landau,Classic Sport,Estate, Sport	US1121H
1964-1967	V8-5.3L	327 CID		US898
1964-1967	V8-5.3L	327 CID	High Performance	US898H
1975-1976	V8-5.7L	350 CID		US1109
1975-1976	V8-5.7L	350 CID	High Performance	US1109H
1977-1981	V8-5.7L	350 CID	Base,Estate,Sport	US1121
1977-1981	V8-5.7L	350 CID	High Performance; Base,Estate,Sport	US1121H
1982-1983	V8-5.7L	350 CID	Air Cond; Classic	US1120
1982-1983	V8-5.7L	350 CID	Air Cond; High Performance; Classic	US1120H
1982-1983	V8-5.7L	350 CID	Exc.Air Cond; Classic	US1100
1966-1967	V8-6.5L	396 CID		US981
1975-1976	V8-6.6L	400 CID		US1109
1975-1976	V8-6.6L	400 CID	High Performance	US1109H
1975	V8-7.4L	454 CID	High Performance;;	US1002H
<b>MALIBU (MEX)</b>				
2000-2001	L4-2.4L	146 CID	MFI DOHC	US5076
1965	L6-4.1L	250 CID	1BL	US895
1967	L6-4.1L	250 CID	1BL	US927
1978-1981	L6-4.1L	250 CID	1BL	US1107
1979-1981	V8-5.7L	350 CID	2BL	US1121
1979-1981	V8-5.7L	350 CID	2BL High Performance	US1121H
<b>MERIVA (MEX)</b>				
2003-2008	L4-1.8L	108 CID	FI	US8938
<b>METRO</b>				
1998-2000	L3-1.0L	61 CID	Base	US5058
1998-2001	L4-1.3L	79 CID	LSi	US5058
<b>MICROBUS (MEX)</b>				
1986-1987	V8-5.7L	350 CID	4BL	US1121
1986-1987	V8-5.7L	350 CID	4BL High Performance	US1121H
1990-1996	V8-5.7L	350 CID	4BL	US5049
1990-1996	V8-5.7L	350 CID	4BL High Performance	US5049H
<b>MILENIO (MEX)</b>				
2000	L4-1.6L	98 CID	MFI	US5057
<b>MONTE CARLO</b>				
1995-1999	V6-3.1L	189 CID	LS	US5033
1978-1979	V6-3.3L	200 CID		US1121
1978-1979	V6-3.3L	200 CID	High Performance	US1121H
1995-2005	V6-3.4L	207 CID	Z34,LS,LS Competition,LS Sport	US5033
2006-2007	V6-3.5L	213 CID	LS,LT	US6020
1978-1984	V6-3.8L	231 CID	High Performance; Landau,Sport, Base,CL	US1018H
1978-1984	V6-3.8L	231 CID	Landau,Sport,Base,CL	US1018
1980-1984	V6-3.8L	229 CID	High Performance; Landau,Sport, Base,CL	US1121H
1980-1984	V6-3.8L	229 CID	Landau,Sport,Base,CL	US1121
1998-2005	V6-3.8L	231 CID	Z34,Indianapolis 500 Pace Car,LS,SS,SS 35th Anniversary Edition,SS Dale Earnhardt Signature Edition,SS High Sport,SS Pace Car,LT	US5075
2006	V6-3.9L	237 CID	LT,LTZ	US6020
1982-1983	V6-4.3L	260 CID	Base,CL	US5012
1985-1988	V6-4.3L	262 CID	Base,LS	US1121
1985-1988	V6-4.3L	262 CID	High Performance; Base,LS	US1121H
1980-1982	V8-4.4L	267 CID	High Performance; Landau,Sport, Base	US1121H
1980-1982	V8-4.4L	267 CID	Landau,Sport,Base	US1121
1976	V8-5.0L	305 CID	High Performance;;	US1109H
1977-1988	V8-5.0L	305 CID	High Performance; Landau,Sport, Base,Landau,CL, SS,LS	US1121H
1977-1988	V8-5.0L	305 CID	Landau,Sport,Base,CL,SS,LS	US1121
2006-2007	V8-5.3L	325 CID	SS	US6154
1975-1976	V8-5.7L	350 CID		US1109

Years	Engine	Disp.	Application Description	USMW
1975-1976	V8-5.7L	350 CID	High Performance	US1109H
1977	V8-5.7L	350 CID	High Performance;;	US1121H
1982-1984	V8-5.7L	350 CID	Air Cond; Base,CL,SS	US1120
1982-1984	V8-5.7L	350 CID	Air Cond; High Performance; Base,CL,SS	US1120H
1982-1984	V8-5.7L	350 CID	Exc.Air Cond; Base,CL,SS	US1100
1975-1976	V8-6.6L	400 CID		US1109
1975-1976	V8-6.6L	400 CID	High Performance	US1109H
1975	V8-7.4L	454 CID	High Performance;;	US1002H
<b>MONTE CARLO (MEX)</b>				
1982-1983	V8-5.7L	350 CID	4BL	US1121
1982-1983	V8-5.7L	350 CID	4BL High Performance	US1121H
<b>MONZA</b>				
1975	L4-2.3L	140 CID		US1088
1978-1980	L4-2.5L	151 CID	2+2,2+2 Sport,2+2 Spyder,Base,Spyder	US1107
1978-1979	V6-3.2L	196 CID		US1018
1978-1979	V6-3.2L	196 CID	High Performance	US1018H
1978-1980	V6-3.8L	231 CID	2+2,2+2 Sport,2+2 Spyder,Base,Spyder	US1018
1978-1980	V6-3.8L	231 CID	High Performance; 2+2,2+2 Sport,2+2 Spyder, Base,Spyder	US1018H
1975-1976	V8-4.3L	262 CID		US1069
1976-1979	V8-5.0L	305 CID		US1069
1975	V8-5.7L	350 CID		US1069
<b>MONZA (MEX)</b>				
1997-2003	L4-1.6L	98 CID	TBI SOHC ;,MFI	US5057
<b>MONZA POP (MEX)</b>				
2002	L4-1.4L	85 CID	MFI	US5057
<b>NOVA</b>				
1985-1987	L4-1.6L	98 CID	Base,CL	US9057
1988	L4-1.6L	98 CID	Base,CL,Twin Cam	US9076
1975-1979	L6-4.1L	250 CID		US1107
1976	V8-5.0L	305 CID	High Performance;;	US1109H
1977-1979	V8-5.0L	305 CID		US1121
1977-1979	V8-5.0L	305 CID	High Performance	US1121H
1975-1976	V8-5.7L	350 CID		US1109
1975-1976	V8-5.7L	350 CID	High Performance	US1109H
1977-1979	V8-5.7L	350 CID		US1121
1977-1979	V8-5.7L	350 CID	High Performance	US1121H
<b>ONE-FIFTY SERIES</b>				
1955-1957	V8-4.3L	265 CID		US898
1955-1957	V8-4.3L	265 CID	High Performance	US898H
1957	V8-4.6L	283 CID	High Performance;;	US898H
<b>OPTRA (MEX)</b>				
2006-2009	L4-2.0L	122 CID	FI	US8925
<b>P10</b>				
1975-1979	L6-4.8L	292 CID		US5030
<b>P10 SERIES</b>				
1961-1962	L6-4.3L	261 CID		US898
1961-1962	L6-4.3L	261 CID	High Performance	US898H
1967	L6-4.8L	292 CID		US896
1961-1962	V8-4.6L	283 CID		US898
1961-1962	V8-4.6L	283 CID	High Performance	US898H
<b>P20</b>				
1975-1977	L6-4.8L	292 CID		US1137
1978-1979	L6-4.8L	292 CID		US5030
1975-1976	V8-5.7L	350 CID		US1109
1975-1976	V8-5.7L	350 CID	High Performance	US1109H
1977-1979	V8-5.7L	350 CID		US1121
1977-1979	V8-5.7L	350 CID	High Performance	US1121H
<b>P20 SERIES</b>				
1965-1967	L6-4.8L	292 CID		US896
<b>P20 VAN</b>				
1968-1974	L6-4.8L	292 CID		US896
1968-1969	V8-5.0L	307 CID		US898
1968-1969	V8-5.0L	307 CID	High Performance	US898H
1970-1972	V8-5.7L	350 CID		US898
1970-1972	V8-5.7L	350 CID	High Performance	US898H
<b>P30</b>				
1975-1977	L6-4.8L	292 CID		US1137



Years	Engine	Disp.	Application Description	USMW
1978-1989	L6-4.8L	292 CID	Base,Step-Van	US5030
1990-1995	V6-4.3L	262 CID	Base,Step-Van	US1121
1990-1995	V6-4.3L	262 CID	High Performance; Base,Step-Van	US1121H
1996-1999	V6-4.3L	262 CID	Base	US5077
1975-1976	V8-5.7L	350 CID		US1109
1975-1976	V8-5.7L	350 CID	High Performance	US1109H
1977-1995	V8-5.7L	350 CID	High Performance; Base,Step-Van	US1121H
1977-1996	V8-5.7L	350 CID	Base,Step-Van	US1121
1996-1999	V8-5.7L	350 CID	Base	US5077
1985-1993	V8-6.2L	379 CID	Base,Step-Van	US5008
1994-1996	V8-6.5L	395 CID	Base	US5062
1997-1998	V8-6.5L	395 CID	Base	US5074
1999	V8-6.5L	395 CID	Base	US5086
1976	V8-6.6L	400 CID	High Performance,,	US1109H
1975-1999	V8-7.4L	454 CID	Base,Step-Van	US1002
1975-1999	V8-7.4L	454 CID	High Performance; Base,Step-Van	US1002H
<b>P30 SERIES</b>				
1961-1962	L6-4.3L	261 CID		US898
1961-1962	L6-4.3L	261 CID	High Performance	US898H
1965-1967	L6-4.8L	292 CID		US896
1961-1962	V8-4.6L	283 CID		US898
1961-1962	V8-4.6L	283 CID	High Performance	US898H
1960-1965	V8-5.7L	348 CID		US898
1960-1965	V8-5.7L	348 CID	High Performance	US898H
<b>P30 VAN</b>				
1968-1974	L6-4.8L	292 CID		US896
1968-1969	V8-5.0L	307 CID		US898
1968-1969	V8-5.0L	307 CID	High Performance	US898H
1970-1972	V8-5.7L	350 CID		US898
1970-1972	V8-5.7L	350 CID	High Performance	US898H
1972	V8-6.6L	402 CID		US981
<b>P30 VAN (MEX)</b>				
1998-2002	L6-4.1L	250 CID	MFI	US5030
2001	V6-4.3L	262 CID	MFI	US5077
1989-1991	V8-5.7L	350 CID	4BL	US5049
1989-1991	V8-5.7L	350 CID	4BL High Performance	US5049H
<b>P31 VAN (MEX)</b>				
1991	L6-4.8L	292 CID	1BL	US1137
1991-1995	V8-5.7L	350 CID	MFI	US1121
1991-1995	V8-5.7L	350 CID	MFI High Performance	US1121H
1996	V8-5.7L	350 CID	MFI High Performance,,	US5049H
1998-1999	V8-5.7L	350 CID	MFI	US5077
<b>POP (MEX)</b>				
1996-2001	L4-1.4L	85 CID	MFI	US5057
2002-2003	L4-1.6L	98 CID	TBI SOHC ;,MFI	US5057
<b>PRIZM</b>				
1998-2002	L4-1.8L	110 CID	Base,LSi	US9376
<b>R10</b>				
1987	V6-4.3L	262 CID	High Performance; Custom Deluxe,Scottsdale, Silverado	US1121H
1987	V8-5.0L	305 CID	High Performance; Custom Deluxe,Scottsdale, Silverado	US1121H
1987	V8-5.7L	350 CID	High Performance; Custom Deluxe,Scottsdale, Silverado	US1121H
1987	V8-6.2L	379 CID	Custom Deluxe,Scottsdale,Silverado	US5008
<b>R10 SUBURBAN</b>				
1987	V8-5.0L	305 CID	High Performance; Custom Deluxe,Scottsdale, Silverado	US1121H
1987-1988	V8-5.7L	350 CID	Custom Deluxe,Scottsdale,Silverado	US5049
1987-1988	V8-5.7L	350 CID	High Performance; Custom Deluxe,Scottsdale, Silverado	US5049H
1987-1988	V8-6.2L	379 CID	Custom Deluxe,Scottsdale,Silverado	US5008
<b>R1500 SUBURBAN</b>				
1989-1991	V8-5.7L	350 CID	High Performance; Scottsdale,Silverado	US5049H
1989-1991	V8-5.7L	350 CID	Scottsdale,Silverado	US5049
1989-1991	V8-6.2L	379 CID	Scottsdale,Silverado	US5062
<b>R20</b>				
1987-1988	L6-4.8L	292 CID	Custom Deluxe,Scottsdale,Silverado,Cheyenne	US5030

Years	Engine	Disp.	Application Description	USMW
1987	V6-4.3L	262 CID	High Performance; Custom Deluxe,Scottsdale, Silverado	US1121H
1987	V8-5.0L	305 CID	High Performance; Custom Deluxe,Scottsdale, Silverado,Custom Deluxe	US1121H
1987-1988	V8-5.7L	350 CID	Custom Deluxe,Scottsdale,Silverado,Cheyenne	US1121
1987-1988	V8-5.7L	350 CID	High Performance; Custom Deluxe,Scottsdale, Silverado,High Performance; Cheyenne	US1121H
1987-1988	V8-6.2L	379 CID	Custom Deluxe,Scottsdale,Silverado,Cheyenne	US5008
1987-1988	V8-7.4L	454 CID	Custom Deluxe,Scottsdale,Silverado,Cheyenne	US1002
1987-1988	V8-7.4L	454 CID	High Performance; Custom Deluxe,Scottsdale Silverado,High Performance; Cheyenne	US1002H
<b>R20 SUBURBAN</b>				
1987-1988	V8-5.7L	350 CID	Custom Deluxe,Scottsdale,Silverado	US5049
1987-1988	V8-5.7L	350 CID	High Performance; Custom Deluxe,Scottsdale, Silverado,High Performance; Scottsdale	US5049H
1987-1988	V8-6.2L	379 CID	Custom Deluxe,Scottsdale,Silverado	US5008
1987-1988	V8-7.4L	454 CID	Custom Deluxe,Scottsdale,Silverado	US1002
1987-1988	V8-7.4L	454 CID	High Performance; Custom Deluxe,Scottsdale, Silverado,High Performance; Scottsdale	US1002H
<b>R25</b>				
1995	V8-5.7L	350 CID	High Performance; 400 SS	US5049H
<b>R2500</b>				
1989	V8-6.2L	379 CID	Cheyenne,Scottsdale,Silverado	US5008
1989	V8-7.4L	454 CID	High Performance; Cheyenne,Scottsdale,Silverado, Cheyenne	US1002H
<b>R2500 SUBURBAN</b>				
1989-1991	V8-5.7L	350 CID	High Performance; Scottsdale,Silverado	US5049H
1989-1991	V8-5.7L	350 CID	Scottsdale,Silverado	US5049
1989-1991	V8-6.2L	379 CID	Scottsdale,Silverado	US5062
1989-1991	V8-7.4L	454 CID	High Performance; Scottsdale,Silverado	US5038H
1989-1991	V8-7.4L	454 CID	Scottsdale,Silverado	US5038
<b>R30</b>				
1987-1988	L6-4.8L	292 CID	Custom Deluxe,Scottsdale,Silverado,Cheyenne	US5030
1987-1988	V8-5.7L	350 CID	Custom Deluxe,Scottsdale,Silverado,Cheyenne	US1121
1987-1988	V8-5.7L	350 CID	High Performance; Custom Deluxe,Scottsdale, Silverado,High Performance; Cheyenne	US1121H
1987-1988	V8-6.2L	379 CID	Custom Deluxe,Scottsdale,Silverado,Cheyenne	US5008
1987-1988	V8-7.4L	454 CID	Custom Deluxe,Scottsdale,Silverado,Cheyenne	US1002
1987-1988	V8-7.4L	454 CID	High Performance; Custom Deluxe,Scottsdale, Silverado,High Performance; Cheyenne	US1002H
<b>R3500</b>				
1989-1991	V8-5.7L	350 CID	Cheyenne,Scottsdale,Silverado	US1121
1989-1991	V8-5.7L	350 CID	High Performance; Cheyenne,Scottsdale,Silverado	US1121H
1989-1991	V8-6.2L	379 CID	Cheyenne,Scottsdale,Silverado	US5008
1989-1991	V8-7.4L	454 CID	Cheyenne,Scottsdale,Silverado	US1002
1989-1991	V8-7.4L	454 CID	High Performance; Cheyenne,Scottsdale,Silverado	US1002H
<b>S10</b>				
1982-1985	L4-1.9L	119 CID	Base,Durango,Gypsy,High Sierra,Sport,Tahoe	US5013
1983-1984	L4-2.0L	122 CID	Base,Durango,Sport,Tahoe	US5015
1994-2003	L4-2.2L	134 CID	Base,LS,SS,ZR2,Xtreme,ZR5	US5032
1985-1986	L4-2.5L	151 CID	Base,Durango,Sport,Tahoe	US5022
1987-1993	L4-2.5L	151 CID	Base,Sport,Tahoe,Durango,Baja,EL	US5040
1982-1986	V6-2.8L	173 CID	Base,Durango,Gypsy,High Sierra,Sport,Tahoe	US5006
1987-1993	V6-2.8L	173 CID	Base,Sport,Tahoe,Durango,Baja,EL	US5035
1988-1995	V6-4.3L	262 CID	Base,Durango,Sport,Tahoe,Baja,EL,LS,SS,ZR2	US5049
1988-1995	V6-4.3L	262 CID	Base,Durango,Sport,Tahoe,High Performance; Baja,EL,LS,SS,ZR2	US5049H
1996-2004	V6-4.3L	262 CID	Base,LS,SS,ZR2,Xtreme,ZR5	US5077
<b>S10 (MEX)</b>				
2001-2002	L4-2.2L	134 CID	FI OHV ; 2WD	US5032
<b>S10 BLAZER</b>				
1983-1984	L4-1.9L	119 CID	Base,Durango,Sport,Tahoe	US5013
1983-1984	L4-2.0L	122 CID	Base,Durango,Sport,Tahoe	US5015
1985-1986	L4-2.5L	151 CID	Base,Durango,Sport,Tahoe	US5022
1987-1988	L4-2.5L	151 CID	Base,High Country,Sport,Tahoe	US5040
1983-1986	V6-2.8L	173 CID	Base,Durango,Sport,Tahoe	US5006
1987-1989	V6-2.8L	173 CID	Base,High Country,Sport,Tahoe	US5035
1988-1994	V6-4.3L	262 CID	Base,High Country,Sport,Tahoe,Tahoe LT,LT	US5049

Years	Engine	Disp.	Application Description	USMW
1988-1994	V6-4.3L	262 CID	High Performance; Base,High Country,Sport,Tahoe, Tahoe LT,LT	<b>US5049H</b>
<b>S10 BLAZER (MEX)</b>				
1990-1994	L4-3.1L	191 CID	TBI ; 2WD,4WD	<b>US5033</b>
<b>SILVERADO (MEX)</b>				
1994-1995	V8-5.7L	350 CID	TBI	<b>US5049</b>
1994-1995	V8-5.7L	350 CID	TBI High Performance	<b>US5049H</b>
1996-1997	V8-5.7L	350 CID	TBI	<b>US5077</b>
<b>SILVERADO 1500</b>				
1999-2011	V6-4.3L	262 CID	Base,LS,LT,WT,Z71,Classic LS,Classic WT	<b>US5077</b>
1999-2006	V8-4.8L	294 CID	Base,LS,LT,WT,Z71	<b>US64</b>
1999-2006	V8-4.8L	294 CID	Includes thermostat and thermostat housing; Base, LS,LT,WT,Z71	<b>US64-T</b>
2007-2011	V8-4.8L	294 CID	Classic LS,Classic LT,Classic WT,LS,LT,WT	<b>US6009</b>
1999-2003	V8-5.3L	323 CID	Base,LS,LT,WT	<b>US5087</b>
2004-2005	V8-5.3L	323 CID	Base,Hybrid,LS,LT,WT,Z71	<b>US64</b>
2004-2005	V8-5.3L	323 CID	Includes thermostat and thermostat housing; Base,Hybrid,LS,LT,WT,Z71	<b>US64-T</b>
2006	V8-5.3L	325 CID	Includes thermostat and thermostat housing; LS,LT,WT,Hybrid	<b>US64-T</b>
2007-2011	V8-5.3L	325 CID	Classic Hybrid,Classic LS,Classic LT,Classic WT, LT,LTZ,WT,LS,XFE	<b>US6009</b>
2003	V8-6.0L	364 CID	SS	<b>US5087</b>
2004-2006	V8-6.0L	364 CID	Includes thermostat and thermostat housing;SS,LS,LT	<b>US64-T</b>
2004-2006	V8-6.0L	364 CID	SS,LS,LT	<b>US64</b>
2007-2011	V8-6.0L	364 CID	Classic LT,Classic SS,LT,LTZ,Hybrid	<b>US6009</b>
2009-2011	V8-6.2L	376 CID	LTZ,LT	<b>US6009</b>
<b>SILVERADO 1500 (MEX)</b>				
1999-2001	V8-5.7L	350 CID	MFI ; 2WD,4WD,MFI ; 4WD	<b>US5077</b>
<b>SILVERADO 1500 HD</b>				
2001	V8-6.0L	364 CID	LS,LT	<b>US5087</b>
2002-2006	V8-6.0L	364 CID	Includes thermostat and thermostat housing; LS,LT, Base	<b>US64-T</b>
2002-2006	V8-6.0L	364 CID	LS,LT,Base	<b>US64</b>
2007	V8-6.0L	364 CID	Classic LT	<b>US6009</b>
<b>SILVERADO 2500</b>				
1999-2000	V8-5.3L	323 CID	Base,LS,LT	<b>US5087</b>
1999-2001	V8-6.0L	364 CID	Base,LS,LT	<b>US5087</b>
2002-2004	V8-6.0L	364 CID	Base,LS,LT,WT	<b>US64</b>
2002-2004	V8-6.0L	364 CID	Includes thermostat and thermostat housing; Base, LS,LT,WT	<b>US64-T</b>
<b>SILVERADO 2500 (MEX)</b>				
2006-2009	V8-4.8L	293 CID	MFI ; 2WD	<b>US64</b>
2006-2009	V8-4.8L	293 CID	MFI; Includes thermostat and thermostat housing; 2WD	<b>US64-T</b>
2010-2011	V8-4.8L	293 CID	FFV OHV ; LS	<b>US6009</b>
2003	V8-5.3L	323 CID	MFI ; 2WD	<b>US5087</b>
2004-2009	V8-5.3L	323 CID	MFI ; 2WD,4WD	<b>US64</b>
2004-2009	V8-5.3L	323 CID	MFI; Includes thermostat and thermostat housing; 2WD,4WD	<b>US64-T</b>
2010-2011	V8-5.3L	323 CID	FI OHV ; LS,LS 4WD	<b>US6009</b>
1999-2001	V8-5.7L	350 CID	MFI ; 2WD,4WD	<b>US5077</b>
<b>SILVERADO 2500 HD</b>				
2001	V8-6.0L	364 CID	Base,LS,LT	<b>US5087</b>
2002-2006	V8-6.0L	364 CID	Base,LS,LT,WT	<b>US64</b>
2002-2006	V8-6.0L	364 CID	Includes thermostat and thermostat housing; Base,LS,LT,WT	<b>US64-T</b>
2007-2011	V8-6.0L	364 CID	Classic LS,Classic LT,Classic WT,LT,LTZ,WT	<b>US6009</b>
2001-2005	V8-6.6L	400 CID	Base,LS,LT,WT	<b>US63</b>
2006-2011	V8-6.6L	400 CID	LS,LT,WT,Classic LS,Classic LT,Classic WT,LTZ	<b>US72</b>
2001-2007	V8-8.1L	496 CID	Base,LS,LT,WT,Classic LS,Classic LT,Classic WT	<b>US5089</b>
<b>SILVERADO 3500</b>				
2001	V8-6.0L	364 CID	Base,LS,LT	<b>US5087</b>
2002-2006	V8-6.0L	364 CID	Base,LS,LT,WT	<b>US64</b>
2002-2006	V8-6.0L	364 CID	Includes thermostat and thermostat housing; Base,LS,LT,WT	<b>US64-T</b>
2007	V8-6.0L	364 CID	Classic LS,Classic LT,Classic WT	<b>US6009</b>
2001-2005	V8-6.6L	400 CID	Base,LS,LT,WT	<b>US63</b>

Years	Engine	Disp.	Application Description	USMW
2004	V8-6.6L	403 CID	Base,LS,LT,WT	<b>US63</b>
2006-2007	V8-6.6L	400 CID	LS,LT,WT,Classic LS,Classic LT,Classic WT	<b>US72</b>
2001-2007	V8-8.1L	496 CID	Base,LS,LT,WT,Classic LS,Classic LT,Classic WT	<b>US5089</b>
<b>SILVERADO 3500 (MEX)</b>				
2001-2003	V8-5.7L	350 CID	MFI ; 2WD	<b>US5087</b>
2007	V8-5.7L	350 CID	MFI; Includes thermostat and thermostat housing; 2WD,2WD	<b>US64-T</b>
<b>SILVERADO 3500 HD</b>				
2007-2011	V8-6.0L	364 CID	LT,LTZ,WT	<b>US6009</b>
2007-2011	V8-6.6L	400 CID	LT,LTZ,WT	<b>US72</b>
<b>SONIC</b>				
2012-2013	L4-1.4L	83 CID		<b>US6662</b>
<b>SONORA</b>				
2000-2002	V8-5.7L	350 CID	High Performance	<b>US5049H</b>
<b>SONORA (MEX)</b>				
2003	V6-4.3L	262 CID	MFI	<b>US5087</b>
2003-2004	V8-5.3L	323 CID	MFI	<b>US5087</b>
2005-2006	V8-5.3L	323 CID	MFI	<b>US64</b>
2005-2006	V8-5.3L	323 CID	MFI; Includes thermostat and thermostat housing	<b>US64-T</b>
2000-2002	V8-5.7L	350 CID	MFI	<b>US5049</b>
2000-2002	V8-5.7L	350 CID	MFI High Performance	<b>US5049H</b>
2003	V8-6.0L	364 CID	SFI	<b>US5087</b>
<b>SPECTRUM</b>				
1985-1988	L4-1.5L	92 CID	Base,CL,CL Plus,Express,Turbo	<b>US5031</b>
<b>SPRINT</b>				
1985-1988	L3-1.0L	61 CID	Base,ER,Plus,Metro,Turbo	<b>US5029</b>
<b>SSR</b>				
2003-2004	V8-5.3L	325 CID	Base	<b>US64</b>
2003-2004	V8-5.3L	325 CID	Includes thermostat and thermostat housing; Base	<b>US64-T</b>
2005-2006	V8-6.0L	364 CID	Base	<b>US64</b>
2005-2006	V8-6.0L	364 CID	Includes thermostat and thermostat housing; Base	<b>US64-T</b>
<b>SUBURBAN</b>				
1961-1962	L6-4.3L	261 CID		<b>US898</b>
1961-1962	L6-4.3L	261 CID	High Performance	<b>US898H</b>
1965-1967	L6-4.8L	292 CID		<b>US896</b>
1960-1967	V8-4.6L	283 CID		<b>US898</b>
1960-1967	V8-4.6L	283 CID	High Performance	<b>US898H</b>
1966-1967	V8-5.3L	327 CID		<b>US898</b>
1966-1967	V8-5.3L	327 CID	High Performance	<b>US898H</b>
1960-1965	V8-5.7L	348 CID		<b>US898</b>
1960-1965	V8-5.7L	348 CID	High Performance	<b>US898H</b>
<b>SUBURBAN (MEX)</b>				
2010-2012	V8-5.3L	325 CID	SFI OHV ; 2WD,4WD	<b>US6009</b>
<b>SUBURBAN 1500</b>				
2000-2003	V8-5.3L	323 CID	Base,LS,LT	<b>US5087</b>
2004-2005	V8-5.3L	323 CID	Includes thermostat and thermostat housing; LS,LT,Z71	<b>US64-T</b>
2004-2005	V8-5.3L	323 CID	LS,LT,Z71	<b>US64</b>
2006	V8-5.3L	325 CID	Includes thermostat and thermostat housing; Base,LS,LT,LTZ,Z71	<b>US64-T</b>
2007-2011	V8-5.3L	325 CID	LS,LT,LTZ,Z71	<b>US6009</b>
2007-2009	V8-6.0L	364 CID	LT,LTZ	<b>US6009</b>
<b>SUBURBAN 1500 (MEX)</b>				
2006	V8-5.3L	323 CID	SFI OHV; Includes thermostat and thermostat housing; 2WD,2WD	<b>US64-T</b>
2001-2002	V8-5.7L	350 CID	MFI ; 2WD,FI OHV ; 2WD	<b>US5087</b>
<b>SUBURBAN 2500</b>				
2000	V8-5.3L	323 CID	Base,LS,LT	<b>US5087</b>
2001	V8-6.0L	364 CID	Base,LS,LT	<b>US5087</b>
2002-2006	V8-6.0L	364 CID	Includes thermostat and thermostat housing; LS,LT	<b>US64-T</b>
2002-2006	V8-6.0L	364 CID	LS,LT	<b>US64</b>
2007-2011	V8-6.0L	364 CID	LS,LT,LTZ	<b>US6009</b>
2001-2006	V8-8.1L	496 CID	Base,LS,LT	<b>US5089</b>
<b>SWING (MEX)</b>				
1994-1995	L4-1.4L	85 CID	MFI	<b>US5057</b>
1996-2003	L4-1.6L	98 CID	MFI	<b>US5057</b>
<b>TAHOE</b>				
2000-2006	V8-4.8L	294 CID	Base,LS,LT,Z71	<b>US64</b>

Years	Engine	Disp.	Application Description	USMW
2000-2006	V8-4.8L	294 CID	Includes thermostat and thermostat housing; Base,LS LT, Z71	US64-T
2007-2009	V8-4.8L	294 CID	LS	US6009
2000-2005	V8-5.3L	323 CID	Base,LS,LT,Z71	US64
2000-2005	V8-5.3L	323 CID	Includes thermostat and thermostat housing; Base,LS LT, Z71	US64-T
2002-2003	V8-5.3L	323 CID	LS,LT,Z71	US5087
2006	V8-5.3L	325 CID	Includes thermostat and thermostat housing; Base,LS LT,Z71	US64-T
2007-2011	V8-5.3L	325 CID	LS,LT,LTZ	US6009
1995	V8-5.7L	350 CID	High Performance; Base,LS,LT,Base	US5049H
1996-2000	V8-5.7L	350 CID	Base,LS,LT,Limited,Z71	US5077
2008-2011	V8-6.0L	364 CID	Hybrid	US6009
2008	V8-6.2L	378 CID	LTZ	US6009
2009	V8-6.2L	376 CID	LTZ	US6009
1995	V8-6.5L	395 CID	Base,LS,LT	US5062
1996-1999	V8-6.5L	395 CID	Base,LS,LT	US5074
<b>TAHOE (MEX)</b>				
2011-2012	V8-5.3L	325 CID	SFI OHV ; 2WD,4WD	US6009
<b>TIGRA (MEX)</b>				
1999	L4-1.6L	98 CID	MFI	US5057
<b>TORNADO (MEX)</b>				
2004	L4-1.8L	108 CID	FI	US8938
2005-2009	L4-1.8L	110 CID	FI	US8938
<b>TRACKER</b>				
1998	L4-1.6L	98 CID	Base,LSi	US5048
1999-2000	L4-1.6L	98 CID	Base,LSi	US9374
1999-2003	L4-2.0L	122 CID	Base,LSi,LT,ZR2	US9342
2001-2004	V6-2.5L	2500cc	LT,ZR2,Base	US9385
<b>TRACKER (MEX)</b>				
2005-2008	L4-2.0L	121 CID	MFI DOHC	US9342
1999-2005	L4-2.2L	134 CID	MFI DOHC ; 2WD,4WD	US5048
<b>TRAILBLAZER</b>				
2002-2009	L6-4.2L	256 CID	Invalid ID,LT,LTZ,North Face,LS,Base	US5097
2006	V8-5.3L	325 CID	Includes thermostat and thermostat housing; LS,LT,LS	US64-T
2007-2008	V8-5.3L	325 CID	LS,LT,Base	US6009
2006	V8-6.0L	364 CID	Includes thermostat and thermostat housing; SS,SS	US64-T
2007-2009	V8-6.0L	364 CID	SS	US6009
<b>TRAVERSE</b>				
2009-2011	V6-3.6L	217 CID	LS,LT,LTZ	US8932
<b>TRUCK</b>				
1955-1960	L6-4.3L	261 CID		US898
1955-1960	L6-4.3L	261 CID	High Performance	US898H
1955-1957	V8-4.3L	265 CID		US898
1955-1957	V8-4.3L	265 CID	High Performance	US898H
1957-1960	V8-4.6L	283 CID		US898
1957-1960	V8-4.6L	283 CID	High Performance	US898H
1955-1956	V8-5.3L	324 CID		US898
1955-1956	V8-5.3L	324 CID	High Performance	US898H
1956-1958	V8-5.3L	322 CID		US898
1956-1958	V8-5.3L	322 CID	High Performance	US898H
1958-1960	V8-5.7L	348 CID		US898
1958-1960	V8-5.7L	348 CID	High Performance	US898H
<b>TWO-TEN SERIES</b>				
1955-1957	V8-4.3L	265 CID		US898
1955-1957	V8-4.3L	265 CID	High Performance	US898H
1957	V8-4.6L	283 CID	High Performance;	US898H
<b>UPLANDER</b>				
2005-2006	V6-3.5L	213 CID	Base,LS,LT	US5033
2006-2008	V6-3.9L	237 CID	LT,Base,LS	US6020
<b>UPLANDER (MEX)</b>				
2009	V6-3.9L	237 CID	SFI OHV ; 2WD	US6020
<b>V10</b>				
1987	V6-4.3L	262 CID	High Performance; Custom Deluxe,Scottsdale, Silverado	US1121H
1987	V8-5.0L	305 CID	High Performance; Custom Deluxe,Scottsdale, Silverado	US1121H

Years	Engine	Disp.	Application Description	USMW
1987	V8-5.7L	350 CID	High Performance; Custom Deluxe,Scottsdale, Silverado	US1121H
1987	V8-6.2L	379 CID	Custom Deluxe,Scottsdale,Silverado	US5008
<b>V10 SUBURBAN</b>				
1987-1988	V8-5.7L	350 CID	Custom Deluxe,Scottsdale,Silverado	US5049
1987-1988	V8-5.7L	350 CID	High Performance; Custom Deluxe,Scottsdale ,Silverado	US5049H
1987-1988	V8-6.2L	379 CID	Custom Deluxe,Scottsdale,Silverado	US5008
<b>V1500 SUBURBAN</b>				
1989-1991	V8-5.7L	350 CID	High Performance; Scottsdale,Silverado	US5049H
1989-1991	V8-5.7L	350 CID	Scottsdale,Silverado	US5049
1989-1991	V8-6.2L	379 CID	Scottsdale,Silverado	US5062
<b>V20</b>				
1987	L6-4.8L	292 CID	Custom Deluxe,Scottsdale,Silverado	US5030
1987	V8-5.7L	350 CID	High Performance; Custom Deluxe,Scottsdale, Silverado	US1121H
1987	V8-6.2L	379 CID	Custom Deluxe,Scottsdale,Silverado	US5008
<b>V20 SUBURBAN</b>				
1987	V8-5.7L	350 CID	High Performance; Custom Deluxe,Scottsdale, Silverado	US1121H
1988	V8-5.7L	350 CID	High Performance; Scottsdale,Silverado,Scottsdale	US5049H
1987-1988	V8-6.2L	379 CID	Custom Deluxe,Scottsdale,Silverado	US5008
1987-1988	V8-7.4L	454 CID	Custom Deluxe,Scottsdale,Silverado	US1002
1987-1988	V8-7.4L	454 CID	High Performance; Custom Deluxe,Scottsdale, Silverado	US1002H
<b>V2500 SUBURBAN</b>				
1989-1991	V8-5.7L	350 CID	High Performance; Scottsdale,Silverado	US5049H
1989-1991	V8-5.7L	350 CID	Scottsdale,Silverado	US5049
1989-1991	V8-6.2L	379 CID	Scottsdale,Silverado	US5062
1990	V8-7.4L	454 CID	High Performance; Scottsdale,Silverado,Scottsdale	US1002H
<b>V30</b>				
1987-1988	L6-4.8L	292 CID	Custom Deluxe,Scottsdale,Silverado,Cheyenne	US5030
1987-1988	V8-5.7L	350 CID	Custom Deluxe,Scottsdale,Silverado,Cheyenne	US1121
1987-1988	V8-5.7L	350 CID	High Performance; Custom Deluxe,Scottsdale, Silverado, Cheyenne	US1121H
1987-1988	V8-6.2L	379 CID	Custom Deluxe,Scottsdale,Silverado,Cheyenne	US5008
1987-1988	V8-7.4L	454 CID	Custom Deluxe,Scottsdale,Silverado,Cheyenne	US1002
1987-1988	V8-7.4L	454 CID	High Performance; Custom Deluxe,Scottsdale, Silverado, Cheyenne	US1002H
<b>V3500</b>				
1989-1991	V8-5.7L	350 CID	Cheyenne,Scottsdale,Silverado	US1121
1989-1991	V8-5.7L	350 CID	High Performance; Cheyenne,Scottsdale,Silverado	US1121H
1989-1991	V8-6.2L	379 CID	Cheyenne,Scottsdale,Silverado	US5008
1989-1991	V8-7.4L	454 CID	Cheyenne,Scottsdale,Silverado	US1002
1989-1991	V8-7.4L	454 CID	High Performance; Cheyenne,Scottsdale,Silverado	US1002H
<b>VAGONETA (MEX)</b>				
2000-2002	L4-1.6L	98 CID	MFI	US5057
<b>VECTRA (MEX)</b>				
2003-2005	L4-2.2L	134 CID	MFI DOHC	US5092
2007-2008	V6-2.8L	173 CID	SFI Turbo	US8932
2004-2005	V6-3.2L	193 CID	MFI DOHC	US5079
2006	V8-2.8L	173 CID	SFI Turbo	US8932
<b>VEGA</b>				
1975	L4-2.3L	140 CID		US1088
<b>VENTURE</b>				
1997-2005	V6-3.4L	207 CID	Base,LS,LT,Plus,Value,Warners Bros.	US5033
<b>ZAFIRA (MEX)</b>				
2001-2006	L4-1.8L	109 CID	EFI DOHC	US8933
2001-2006	L4-2.2L	134 CID	MFI DOHC	US5092
<b>CHRYSLER</b>				
<b>200</b>				
2011-2012	L4-2.4L	144 CID	Limited,LX,Touring	US6038
2011-2014	V6-3.6L	220 CID		US8981
<b>300</b>				
2005-2007	V6-2.7L	167 CID	Base	US7161
2008-2010	V6-2.7L	167 CID	LX,Touring	US6217
2005-2010	V6-3.5L	215 CID	Limited,Touring,S	US8951



Years	Engine	Disp.	Application Description	USMW
2011-2014	V6-3.6L	220 CID		<b>US8981</b>
2005-2008	V8-5.7L	345 CID	C	<b>US8940</b>
2009-2010	V8-5.7L	345 CID	C,S	<b>US8979</b>
2011-2013	V8-5.7L	345 CID	C,S	<b>US8971</b>
2005-2010	V8-6.1L	370 CID	C SRT8	<b>US8940</b>
2012-2013	V8-6.4L	392 CID	SRT8,	<b>US8971</b>
<b>300M</b>				
1999-2004	V6-3.5L	215 CID	Base,Special,Pro-Am	<b>US7162</b>
<b>ASPEN</b>				
2007-2009	V8-4.7L	285 CID	Limited	<b>US7163</b>
2007-2008	V8-5.7L	345 CID	Limited	<b>US7168</b>
2009	V8-5.7L	345 CID	Limited	<b>US6341</b>
<b>CIRRUS</b>				
2000	L4-2.0L	122 CID	LX,LXi	<b>US7150</b>
1995	L4-2.4L	148 CID	LX	<b>US7153</b>
1996-2000	L4-2.4L	148 CID	Mechanical Tensioner; LX,LX,LXi	<b>US7156</b>
1995-2000	V6-2.5L	152 CID	LX,LXi	<b>US7152</b>
<b>CIRRUS (MEX)</b>				
1995	L4-2.0L	122 CID	MFI DOHC	<b>US7150</b>
1998	L4-2.4L	148 CID	Turbo	<b>US7152</b>
1999-2009	L4-2.4L	148 CID	Turbo ;,Turbo DOHC;,FI DOHC	<b>US7156</b>
2001-2003	V6-2.7L	165 CID	SFI DOHC	<b>US7161</b>
2004-2006	V6-2.7L	167 CID	MFI DOHC	<b>US7161</b>
2007-2009	V6-3.5L	213 CID	FI DOHC	<b>US8951</b>
<b>CIRRUS LIMITED (MEX)</b>				
2010	L4-2.4L	144 CID	SFI DOHC	<b>US6038</b>
<b>CIRRUS TOURING (MEX)</b>				
2010	L4-2.4L	144 CID	SFI DOHC	<b>US6038</b>
<b>CONCORDE</b>				
1998-2004	V6-2.7L	167 CID	LX,LXi	<b>US7161</b>
1998-2001	V6-3.2L	197 CID	LX,LXi	<b>US7162</b>
1993-1996	V6-3.3L	201 CID	Base,LX	<b>US7140</b>
1993-1994	V6-3.5L	215 CID	Base	<b>US7141</b>
1995-1996	V6-3.5L	215 CID	Base,LX,LXi	<b>US7151</b>
1997	V6-3.5L	215 CID	6 Bolt Pattern; LX,LXi,LX	<b>US7158</b>
2002-2004	V6-3.5L	215 CID	Limited,LXi	<b>US7162</b>
<b>CONCORDE (MEX)</b>				
1992	V6-3.3L	201 CID	MFI	<b>US7140</b>
1992	V6-3.5L	215 CID	MFI	<b>US7141</b>
<b>CONQUEST</b>				
1987-1989	L4-2.5L	153 CID	From 12/86; Base,TSi	<b>US7124</b>
1987	L4-2.6L	156 CID	To 11/86; Base	<b>US7120</b>
<b>CORDOBA</b>				
1980-1983	L6-3.7L	225 CID	300,Base,Crown,LS	<b>US7100</b>
1975-1983	V8-5.2L	318 CID	300,Base,Crown,LS	<b>US1053</b>
1975-1983	V8-5.2L	318 CID	High Performance; 300,Base,Crown,LS	<b>US1053H</b>
1975-1979	V8-5.9L	360 CID		<b>US1053</b>
1975-1979	V8-5.9L	360 CID	High Performance	<b>US1053H</b>
1975-1978	V8-6.6L	400 CID		<b>US1040</b>
<b>CORDOBA (MEX)</b>				
1980-1982	V8-5.9L	360 CID	4BL	<b>US1053</b>
1980-1982	V8-5.9L	360 CID	4BL High Performance	<b>US1053H</b>
<b>CROSSFIRE</b>				
2004-2008	V6-3.2L	195 CID	Base,Limited	<b>US9379</b>
2005-2006	V6-3.2L	3199cc	SRT-6	<b>US9379</b>
<b>DART (MEX)</b>				
1986-1988	L4-2.2L	135 CID	2BL	<b>US7110</b>
1989	L4-2.2L	135 CID	2BL	<b>US7122</b>
<b>E CLASS</b>				
1983-1984	L4-2.2L	135 CID	Base	<b>US7110</b>
1983-1984	L4-2.6L	156 CID	Base	<b>US7111</b>
<b>EXECUTIVE LIMOUSINE</b>				
1985	L4-2.6L	156 CID	Base	<b>US7111</b>
<b>EXECUTIVE SEDAN</b>				
1983-1984	L4-2.6L	156 CID	Base	<b>US7111</b>
<b>FIFTH AVENUE</b>				
1983	L6-3.7L	225 CID	Base	<b>US7100</b>

Years	Engine	Disp.	Application Description	USMW
1983-1989	V8-5.2L	318 CID	Base	<b>US1053</b>
1983-1989	V8-5.2L	318 CID	High Performance; Base	<b>US1053H</b>
<b>GRAND VOYAGER</b>				
2000	V6-3.0L	181 CID	Base,SE	<b>US7121</b>
2000	V6-3.3L	201 CID	Base,SE	<b>US7126</b>
<b>GRAND VOYAGER (MEX)</b>				
2001	V6-3.3L	201 CID	MFI	<b>US7165</b>
1991-1995	V6-3.8L	231 CID	MFI	<b>US7126</b>
1998-2001	V6-3.8L	232 CID	MFI	<b>US7126</b>
2002	V6-3.8L	232 CID	MFI	<b>US7165</b>
<b>IMPERIAL</b>				
1990-1991	V6-3.3L	201 CID	Base	<b>US7126</b>
1991-1993	V6-3.8L	230 CID	Base	<b>US7126</b>
1981-1982	V8-5.2L	318 CID	Base	<b>US1053</b>
1981-1982	V8-5.2L	318 CID	High Performance; Base	<b>US1053H</b>
1975	V8-7.2L	440 CID		<b>US1040</b>
<b>LASER</b>				
1984-1986	L4-2.2L	135 CID	Base,XE	<b>US7110</b>
1986	L4-2.5L	153 CID	Base,XE	<b>US7110</b>
<b>LEBARON</b>				
1982-1988	L4-2.2L	135 CID	Base,Medallion,Mark Cross,GTS,Premium	<b>US7110</b>
1989	L4-2.2L	135 CID	Base,GTS,Premium	<b>US7122</b>
1990	L4-2.2L	135 CID	GTC	<b>US7127</b>
1986-1988	L4-2.5L	153 CID	Base,GTS,Mark Cross,Premium	<b>US7110</b>
1989	L4-2.5L	153 CID	Base,GT,GTC,GTS,High Line,Premium	<b>US7122</b>
1990-1993	L4-2.5L	153 CID	Base,GT,GTC,High Line,Premium,Landau,LE	<b>US7127</b>
1982-1985	L4-2.6L	156 CID	Base,Medallion,Mark Cross	<b>US7111</b>
1978-1981	L6-3.7L	225 CID	Base,Medallion,Salon,Special	<b>US7100</b>
1990-1995	V6-3.0L	181 CID	Base,GT,High Line,Premium,GTC,LX,Landau,LE	<b>US7121</b>
1977-1981	V8-5.2L	318 CID	Base,Medallion,Salon,Special	<b>US1053</b>
1977-1981	V8-5.2L	318 CID	High Performance; Base,Medallion,Salon,Special	<b>US1053H</b>
1978-1979	V8-5.9L	360 CID		<b>US1053</b>
1978-1979	V8-5.9L	360 CID	High Performance	<b>US1053H</b>
<b>LEBARON (MEX)</b>				
1982-1987	L4-2.2L	135 CID	2BL ; K,K	<b>US7110</b>
1993-1995	L4-2.5L	153 CID	MFI Turbo ;,MFI	<b>US7127</b>
1977-1982	V8-5.9L	360 CID	4BL	<b>US1053</b>
1977-1982	V8-5.9L	360 CID	4BL High Performance	<b>US1053H</b>
<b>LHS</b>				
1994	V6-3.5L	215 CID	Base	<b>US7141</b>
1995-1996	V6-3.5L	215 CID	Base	<b>US7151</b>
1997	V6-3.5L	215 CID	6 Bolt Pattern; Base,Base	<b>US7158</b>
1999-2001	V6-3.5L	215 CID	Base	<b>US7162</b>
<b>MAGNUM (MEX)</b>				
1987-1988	L4-2.5L	153 CID	TBI	<b>US7110</b>
<b>NEW YORKER</b>				
1983-1988	L4-2.2L	135 CID	Base,Turbo	<b>US7110</b>
1986-1987	L4-2.5L	153 CID	Base	<b>US7110</b>
1983-1985	L4-2.6L	156 CID	Base	<b>US7111</b>
1982	L6-3.7L	225 CID	Base	<b>US7100</b>
1988-1989	V6-3.0L	181 CID	Base,Landau	<b>US7121</b>
1990-1993	V6-3.3L	201 CID	Fifth Avenue,Landau,Salon	<b>US7126</b>
1994	V6-3.5L	215 CID	Base	<b>US7141</b>
1995-1996	V6-3.5L	215 CID	Base	<b>US7151</b>
1991-1993	V6-3.8L	230 CID	Fifth Avenue	<b>US7126</b>
1979-1982	V8-5.2L	318 CID	Base	<b>US1053</b>
1979-1982	V8-5.2L	318 CID	High Performance; Base	<b>US1053H</b>
1977-1980	V8-5.9L	360 CID	Base	<b>US1053</b>
1977-1980	V8-5.9L	360 CID	High Performance; Base	<b>US1053H</b>
1975-1978	V8-6.6L	400 CID		<b>US1040</b>
1975-1978	V8-7.2L	440 CID		<b>US1040</b>
<b>NEW YORKER (MEX)</b>				
1985-1991	L4-2.2L	135 CID	MFI ;,FI Turbo	<b>US7110</b>
1992-1994	V6-3.0L	183 CID	MFI	<b>US7121</b>
<b>NEWPORT</b>				
1980-1981	L6-3.7L	225 CID	Base	<b>US7100</b>
1979-1981	V8-5.2L	318 CID	Base	<b>US1053</b>
1979-1981	V8-5.2L	318 CID	High Performance; Base	<b>US1053H</b>

Years	Engine	Disp.	Application Description	USMW
1975-1980	V8-5.9L	360 CID	Base	US1053
1975-1980	V8-5.9L	360 CID	High Performance; Base	US1053H
1975-1978	V8-6.6L	400 CID		US1040
1975-1978	V8-7.2L	440 CID		US1040
<b>PACIFICA</b>				
2004	V6-3.5L	215 CID	Base	US7162
2005-2006	V6-3.5L	215 CID	Base,Limited,Touring	US8951
2005-2008	V6-3.8L	230 CID	Base,LX	US8968
2007-2008	V6-4.0L	241 CID	Base,Limited,Touring,LX	US8951
<b>PHANTOM (MEX)</b>				
1987-1994	L4-2.2L	135 CID	FI Turbo	US7110
1989	L4-2.2L	135 CID	MFI	US7122
1990	L4-2.2L	135 CID	MFI	US7127
1986-1988	L4-2.5L	153 CID	TBI ,;MFI	US7110
1989	L4-2.5L	153 CID	MFI	US7122
1990-1994	L4-2.5L	153 CID	MFI	US7127
<b>PROWLER</b>				
2001-2002	V6-3.5L	215 CID	Base	US7162
<b>PT CRUISER</b>				
2001-2010	L4-2.4L	148 CID	Base,Classic,Limited,Touring,Dream,Street Cruiser,LX, Couture Edition	US7156
2003-2009	L4-2.4L	148 CID	GT,Limited,Touring,Dream Cruiser,Street Cruiser,Base	US7167
<b>SEBRING</b>				
1995-1999	L4-2.0L	122 CID	LX	US7150
1996-2006	L4-2.4L	148 CID	Mechanical Tensioner; JX,JX,JXi,LX,LX Plus,Base	US7156
2001-2005	L4-2.4L	2351cc	LX,Base	US9399
2007-2010	L4-2.4L	144 CID	Base,Limited,Touring,LX	US6038
1995-2000	V6-2.5L	152 CID	LX,LXi,JX,JXi	US7152
2001-2007	V6-2.7L	167 CID	LX,LXi,LXi Limited,GTC,Limited,LX Plus,Base, Touring,TSi	US7161
2008-2010	V6-2.7L	167 CID	Base,Touring,LX	US6217
2001-2005	V6-3.0L	181 CID	LX,LXi,GTC,Limited,LX Plus	US7152
2007-2010	V6-3.5L	215 CID	Limited	US8951
<b>SHADOW (MEX)</b>				
1989	L4-2.2L	135 CID	TBI	US7122
1990-1991	L4-2.2L	135 CID	TBI	US7127
1988	L4-2.5L	153 CID	TBI	US7110
1989	L4-2.5L	153 CID	TBI	US7122
1990-1994	L4-2.5L	153 CID	TBI	US7127
1992	V6-3.0L	181 CID	MFI	US7121
<b>SPIRIT (MEX)</b>				
1989	L4-2.5L	153 CID	TBI	US7122
1990-1995	L4-2.5L	153 CID	TBI	US7127
1989-1992	V6-3.0L	181 CID	MFI	US7121
<b>STRATUS (MEX)</b>				
1996-1997	L4-2.4L	148 CID	Turbo DOHC	US7156
<b>TC MASERATI</b>				
1989	L4-2.2L	135 CID	Base	US7122
1990	L4-2.2L	135 CID	Base	US7110
1990-1991	V6-3.0L	181 CID	Base	US7121
<b>TOWN &amp; COUNTRY</b>				
1982-1988	L4-2.2L	135 CID	Base,Mark Cross	US7110
1986-1988	L4-2.5L	153 CID	Base,Mark Cross	US7110
1982-1985	L4-2.6L	156 CID	Base,Mark Cross	US7111
1978-1981	L6-3.7L	225 CID	Base	US7100
1990-2000	V6-3.3L	201 CID	Base,LX,SX,LXi,Limited	US7126
2001-2007	V6-3.3L	201 CID	LX,LXi,EL,EX,Limited,Base,Touring	US7165
2008-2010	V6-3.3L	201 CID		US6231
2011-2014	V6-3.6L	220 CID		US8981
1995-2000	V6-3.8L	230 CID	Base,LX,LXi,SX,Limited	US7126
2001-2007	V6-3.8L	230 CID	EX,Limited,EL,LX,LXi,Touring	US7165
2008	V6-3.8L	230 CID		US6231
2009-2010	V6-3.8L	231 CID		US6231
2008-2010	V6-4.0L	241 CID	Limited,Touring	US8951
1978-1981	V8-5.2L	318 CID	Base	US1053
1978-1981	V8-5.2L	318 CID	High Performance; Base	US1053H
1978-1979	V8-5.9L	360 CID		US1053
1978-1979	V8-5.9L	360 CID	High Performance	US1053H

Years	Engine	Disp.	Application Description	USMW
<b>VOLARE (MEX)</b>				
1986-1989	L6-3.7L	225 CID	2BL	US7100
<b>VOYAGER</b>				
2000-2003	L4-2.4L	148 CID	Base,LX	US7156
2000	V6-3.0L	181 CID	Base	US7121
2000	V6-3.3L	201 CID	Base,SE	US7126
2001-2003	V6-3.3L	201 CID	Base,LX	US7165
<b>VOYAGER (MEX)</b>				
1996-1997	L4-2.4L	148 CID	MFI	US7156
1990-1995	L4-2.5L	153 CID	TBI	US7127
1992-1997	V6-3.0L	181 CID	MFI	US7121
1993-1999	V6-3.3L	201 CID	MFI	US7126
2001-2008	V6-3.3L	201 CID	MFI	US7165
<b>CITROEN</b>				
<b>AX</b>				
1986-1996	L4-1.0L	954cc		US8936
1986-1989	L4-1.1L	1124cc		US8936
1987-1996	L4-1.3L	1294cc	Sport	US8936
1987-1996	L4-1.4L	1360cc	GT,D,TGD,TZS,TRZ	US8936
<b>BX</b>				
1986-1989	L4-1.1L	1124cc		US8936
1989-1993	L4-1.4L	1360cc		US8936
<b>SAXO</b>				
1996-2003	L4-1.0L	954cc	X	US8936
1996-2003	L4-1.1L	1124cc		US8936
1996-2003	L4-1.4L	1360cc		US8936
<b>XSARA</b>				
1997-2004	L4-1.4L	1360cc	M	US8936
<b>ZX</b>				
1991-1997	L4-1.1L	1124cc	Reflex	US8936
1991-1997	L4-1.4L	1360cc	Diesel; Reflex,Reflex	US8936
<b>DAEWOO</b>				
<b>LANOS</b>				
1999-2002	L4-1.6L	1588cc	S,SE,SX,Sport	US8917
<b>LEGANZA</b>				
1999-2002	L4-2.2L	2200cc	CDX,SE,SX	US8925
<b>NUBIRA</b>				
1999-2002	L4-2.0L	1998cc	CDX,SX,SE	US8925
<b>DAIHATSU</b>				
<b>CHARADE</b>				
1988-1992	L3-1.0L	993cc	CLS,CLX,CSX,CES,SE,SX	US9238
1989-1992	L4-1.3L	1295cc	CLS,CLX,SE,SX	US9237
<b>ROCKY</b>				
1990-1992	L4-1.6L	1589cc	SE,SX	US8908
<b>DODGE</b>				
<b>330</b>				
1964	V8-4.5L	273 CID		US919
1963-1964	V8-5.2L	318 CID		US919
<b>400</b>				
1982-1983	L4-2.2L	135 CID	Base,LS	US7110
1982-1983	L4-2.6L	156 CID	Base,LS	US7111
<b>440</b>				
1964	V8-4.5L	273 CID		US919
1963-1964	V8-5.2L	318 CID		US919
<b>600</b>				
1983-1988	L4-2.2L	135 CID	Base,ES,SE	US7110
1986-1988	L4-2.5L	153 CID	Base,ES,SE	US7110
1983-1985	L4-2.6L	156 CID	Base,ES,SE	US7111
<b>880</b>				
1964	V8-4.5L	273 CID		US919
1963-1964	V8-5.2L	318 CID		US919
<b>A100</b>				
1964-1966	V8-4.5L	273 CID		US919
<b>A100 TRUCK</b>				
1964-1967	V8-4.5L	273 CID		US919

Years	Engine	Disp.	Application Description	USMW
1967-1969	V8-5.2L	318 CID		US919
<b>ARIES</b>				
1981-1988	L4-2.2L	135 CID	Base,Custom,SE,LE	US7110
1989	L4-2.2L	135 CID	LE	US7122
1986-1988	L4-2.5L	153 CID	LE,SE	US7110
1989	L4-2.5L	153 CID	LE	US7122
1981-1985	L4-2.6L	156 CID	Base,Custom,SE,LE	US7111
<b>ASPEN</b>				
1976-1980	L6-3.7L	225 CID	Base	US7100
1976-1980	V8-5.2L	318 CID	Base	US1053
1976-1980	V8-5.2L	318 CID	High Performance; Base	US1053H
1976-1980	V8-5.9L	360 CID	Base	US1053
1976-1980	V8-5.9L	360 CID	High Performance; Base	US1053H
<b>ATOS</b>				
2005-2009	L4-1.1L	66 CID		US8935
<b>ATOS (MEX)</b>				
2001-2004	L4-1.0L	61 CID	MFI SOHC	US8935
2005-2012	L4-1.1L	67 CID	FI SOHC	US8935
<b>ATTITUDE (MEX)</b>				
2006-2009	L4-1.4L	85 CID	FI DOHC	US7115
2006-2009	L4-1.6L	97 CID	MFI DOHC	US9364
<b>ATTITUDE GL (MEX)</b>				
2010	L4-1.4L	85 CID	FI DOHC	US7115
2010	L4-1.6L	97 CID	MFI DOHC	US9364
<b>AVENGER</b>				
1995-1999	L4-2.0L	122 CID	Base,ES	US7150
2008-2012	L4-2.4L	144 CID	SE,SXT,Express,R/T,Lux,Mainstreet	US6038
1995-2000	V6-2.5L	152 CID	ES,Base	US7152
2008-2010	V6-2.7L	167 CID	SE,SXT,R/T	US6217
2008-2010	V6-3.5L	215 CID	R/T	US8951
2011-2013	V6-3.6L	220 CID		US8981
<b>AVENGER (MEX)</b>				
2008-2009	L4-2.0L	122 CID	FI	US6038
<b>AVENGER GTS (MEX)</b>				
2013	L4-2.4L	144 CID	SFI DOHC	US6038
<b>AVENGER SE (MEX)</b>				
2010	L4-2.0L	122 CID	SFI DOHC	US6038
2010-2011	L4-2.4L	144 CID	SFI DOHC	US6038
<b>B100</b>				
1975-1980	L6-3.7L	225 CID	Base	US7100
1975-1980	V8-5.2L	318 CID	Base	US1053
1975-1980	V8-5.2L	318 CID	High Performance; Base	US1053H
1976-1978	V8-5.9L	360 CID		US1053
1976-1978	V8-5.9L	360 CID	High Performance	US1053H
<b>B150</b>				
1981-1987	L6-3.7L	225 CID	Base	US7100
1988-1991	V6-3.9L	239 CID	Base	US1053
1988-1991	V6-3.9L	239 CID	High Performance; Base	US1053H
1992	V6-3.9L	239 CID	Base	US7159
1993-1994	V6-3.9L	239 CID	Base	US7160
1981-1991	V8-5.2L	318 CID	Base	US1053
1981-1991	V8-5.2L	318 CID	High Performance; Base	US1053H
1992	V8-5.2L	318 CID	Base	US7159
1993-1994	V8-5.2L	318 CID	Base	US7160
<b>B1500</b>				
1995-1998	V6-3.9L	239 CID	Base	US7160
1995-1998	V8-5.2L	318 CID	Base	US7160
1998	V8-5.9L	360 CID	Base	US7160
<b>B200</b>				
1975-1980	L6-3.7L	225 CID	Base	US7100
1975-1980	V8-5.2L	318 CID	Base	US1053
1975-1980	V8-5.2L	318 CID	High Performance; Base	US1053H
1975-1980	V8-5.9L	360 CID	Base	US1053
1975-1980	V8-5.9L	360 CID	High Performance; Base	US1053H
1976-1978	V8-6.6L	400 CID		US1040
1975-1978	V8-7.2L	440 CID		US1040

Years	Engine	Disp.	Application Description	USMW
<b>B250</b>				
1981-1987	L6-3.7L	225 CID	Base	US7100
1988-1991	V6-3.9L	239 CID	Base	US1053
1988-1991	V6-3.9L	239 CID	High Performance; Base	US1053H
1992	V6-3.9L	239 CID	Base	US7159
1993-1994	V6-3.9L	239 CID	Base	US7160
1981-1991	V8-5.2L	318 CID	Base	US1053
1981-1991	V8-5.2L	318 CID	High Performance; Base	US1053H
1992	V8-5.2L	318 CID	Base	US7159
1993-1994	V8-5.2L	318 CID	Base	US7160
1981-1992	V8-5.9L	360 CID	Base	US1053
1981-1992	V8-5.9L	360 CID	High Performance; Base	US1053H
1993-1994	V8-5.9L	360 CID	Base	US7160
<b>B2500</b>				
1995-1997	V6-3.9L	239 CID	Base	US7160
1995-1998	V8-5.2L	318 CID	Base	US7160
1995-1998	V8-5.9L	360 CID	Base	US7160
<b>B300</b>				
1975-1980	L6-3.7L	225 CID	Base	US7100
1975-1980	V8-5.2L	318 CID	Base	US1053
1975-1980	V8-5.2L	318 CID	High Performance; Base	US1053H
1975-1980	V8-5.9L	360 CID	Base	US1053
1975-1980	V8-5.9L	360 CID	High Performance; Base	US1053H
1976-1978	V8-6.6L	400 CID		US1040
1975-1978	V8-7.2L	440 CID		US1040
<b>B350</b>				
1981-1991	V8-5.2L	318 CID	Base	US1053
1981-1991	V8-5.2L	318 CID	High Performance; Base	US1053H
1992	V8-5.2L	318 CID	Base	US7159
1993-1994	V8-5.2L	318 CID	Base	US7160
1981-1992	V8-5.9L	360 CID	Base	US1053
1981-1992	V8-5.9L	360 CID	High Performance; Base	US1053H
1993-1994	V8-5.9L	360 CID	Base	US7160
<b>B3500</b>				
1995-1998	V8-5.2L	318 CID	Base	US7160
1995-1998	V8-5.9L	360 CID	Base	US7160
<b>CALIBER</b>				
2007-2009	L4-1.8L	110 CID	SE,SXT	US6038
2007-2012	L4-2.0L	122 CID	SE,SXT,Express,Heat,Mainstreet,Uptown,Rush,SXT Plus	US6038
2007-2011	L4-2.4L	144 CID	R/T,Rush,Uptown	US6038
<b>CALIBER SE (MEX)</b>				
2010-2011	L4-2.4L	144 CID	SFI DOHC	US6038
<b>CALIBER SXT (MEX)</b>				
2010-2011	L4-2.4L	144 CID	SFI DOHC	US6038
<b>CARAVAN</b>				
1984-1987	L4-2.2L	135 CID	Base,LE,SE	US7110
1996-2007	L4-2.4L	148 CID	Mechanical Tensioner; Base,SE,Base,ES,Ec	US7156
1988	L4-2.5L	153 CID	Base,LE,SE	US7110
1989	L4-2.5L	153 CID	Base,C/V,LE,SE	US7122
1990-1995	L4-2.5L	153 CID	Base,C/V,ES,LE,SE	US7127
1984-1987	L4-2.6L	156 CID	Base,LE,SE	US7111
1987-2000	V6-3.0L	181 CID	LE,SE,C/V,Base,ES,Sport	US7121
1990-2000	V6-3.3L	201 CID	Base,ES,C/V,LE,SE,Sport	US7126
2001-2007	V6-3.3L	201 CID	SE,Sport,C/V,SXT,Base	US7165
1996-1999	V6-3.8L	230 CID	ES,LE,Base,SE,Sport	US7126
<b>CB300</b>				
1980	V8-5.2L	318 CID	High Performance; Base,Base	US1053H
1980	V8-5.9L	360 CID	High Performance; Base,Base	US1053H
<b>CHALLENGER</b>				
1978-1979	L4-1.6L	98 CID		US7105
1978-1983	L4-2.6L	156 CID	Base,Premium	US7116
2009-2010	V6-3.5L	215 CID	SE	US8951
2011-2014	V6-3.6L	220 CID		US8981
2009-2010	V8-5.7L	345 CID	R/T	US8979
2011-2013	V8-5.7L	345 CID	R/T,	US8971
2008-2010	V8-6.1L	370 CID	SRT8	US8940
2011-2013	V8-6.4L	392 CID	SRT8,	US8971





# WATER PUMP APPLICATION GUIDE



Years	Engine	Disp.	Application Description	USMW
<b>CHARGER</b>				
1984	L4-1.6L	97 CID	Base	US7113
1984-1987	L4-2.2L	135 CID	Shelby,2,2,Base	US7110
1976	L6-3.7L	225 CID		US7100
2006-2007	V6-2.7L	167 CID	Base,SE	US7161
2008-2010	V6-2.7L	167 CID	SE	US6217
2006-2010	V6-3.5L	215 CID	SE,SXT	US8951
2011-2014	V6-3.6L	220 CID	SE,	US8981
1966-1967	V8-4.5L	273 CID		US919
1966-1969	V8-5.2L	318 CID		US919
1975-1978	V8-5.2L	318 CID		US1053
1975-1978	V8-5.2L	318 CID	High Performance	US1053H
2006-2008	V8-5.7L	345 CID	Daytona R/T,R/T,SE	US8940
2009-2010	V8-5.7L	345 CID	R/T,SE	US8979
2011-2013	V8-5.7L	345 CID	R/T,SE,	US8971
1975-1978	V8-5.9L	360 CID		US1053
1975-1978	V8-5.9L	360 CID	High Performance	US1053H
2006-2010	V8-6.1L	370 CID	SRT8	US8940
2012-2013	V8-6.4L	392 CID	SRT8,	US8971
1975-1978	V8-6.6L	400 CID		US1040
<b>CHARGER (MEX)</b>				
1970-1971	V8-5.2L	318 CID	4BL	US1053
1970-1971	V8-5.2L	318 CID	4BL High Performance	US1053H
1972	V8-5.9L	360 CID	4BL High Performance	US1053H
<b>COLT</b>				
1979-1980	L4-1.4L	1410cc	Base	US7106
1981-1984	L4-1.4L	1410cc	Base,Deluxe,DL,E	US7115
1985-1994	L4-1.5L	90 CID	DL,E,Premier,Base,GT,GL,ES	US7115
1975-1977	L4-1.6L	98 CID		US1012
1978	L4-1.6L	98 CID		US7105
1979-1980	L4-1.6L	98 CID	Base,Custom	US7104
1981-1988	L4-1.6L	98 CID	Custom,Deluxe,Base,DL,E,Premier	US7108
1989-1990	L4-1.6L	98 CID	GT	US7131
1989-1990	L4-1.8L	107 CID	DL	US7108
1993-1994	L4-1.8L	112 CID	GL,Base,ES	US7135
1975	L4-2.0L	122 CID		US1124
1976-1977	L4-2.0L	122 CID		US7116
1984-1991	L4-2.0L	122 CID	Vista,Vista Custom	US7118
1978-1980	L4-2.6L	156 CID	Base	US7116
<b>CONQUEST</b>				
1984	L4-2.6L	156 CID	Base	US7115
1985-1986	L4-2.6L	156 CID	From 02/85; Base,Base	US7120
1985-1986	L4-2.6L	156 CID	To 01/85; Base,Base	US7116
<b>CORONET</b>				
1975-1976	L6-3.7L	225 CID		US7100
1965-1968	V8-4.5L	273 CID		US919
1965-1969	V8-5.2L	318 CID		US919
1975-1976	V8-5.2L	318 CID		US1053
1975-1976	V8-5.2L	318 CID	High Performance	US1053H
1975-1976	V8-5.9L	360 CID		US1053
1975-1976	V8-5.9L	360 CID	High Performance	US1053H
1975-1976	V8-6.6L	400 CID		US1040
1975-1976	V8-7.2L	440 CID		US1040
<b>CORONET (MEX)</b>				
1965-1970	L6-3.7L	225 CID	2BL	US7100
1967-1969	V8-5.2L	318 CID	4BL	US919
1970-1971	V8-5.2L	318 CID	4BL	US1053
1970-1971	V8-5.2L	318 CID	4BL High Performance	US1053H
<b>CUSTOM</b>				
1964-1965	V8-4.5L	273 CID		US919
1962-1965	V8-5.2L	318 CID		US919
<b>D100</b>				
1975-1987	L6-3.7L	225 CID	Custom	US7100
1988-1989	V6-3.9L	239 CID	Custom	US1053
1988-1989	V6-3.9L	239 CID	High Performance; Custom	US1053H
1975-1989	V8-5.2L	318 CID	Custom	US1053
1975-1989	V8-5.2L	318 CID	High Performance; Custom	US1053H
1975-1988	V8-5.9L	360 CID	Custom	US1053

Years	Engine	Disp.	Application Description	USMW
1975-1988	V8-5.9L	360 CID	High Performance; Custom	US1053H
1976-1978	V8-6.6L	400 CID		US1040
1975-1978	V8-7.2L	440 CID		US1040
<b>D100 (MEX)</b>				
1970	L6-3.7L	225 CID	2BL ; 1/2 Ton	US7100
<b>D100 1/2 TON P/U (MEX)</b>				
1971-1974	L6-3.7L	225 CID	2BL ; 1/2 Ton	US7100
<b>D100 PICKUP</b>				
1968-1969	V8-5.2L	318 CID		US919
<b>D100 SERIES</b>				
1960-1967	V8-5.2L	318 CID		US919
<b>D150</b>				
1977-1987	L6-3.7L	225 CID	Base,Miser	US7100
1988-1991	V6-3.9L	239 CID	Base,S	US1053
1988-1991	V6-3.9L	239 CID	High Performance; Base,S	US1053H
1992	V6-3.9L	239 CID	Base	US7159
1993	V6-3.9L	239 CID	Base	US7160
1977-1991	V8-5.2L	318 CID	Base,Miser,S	US1053
1977-1991	V8-5.2L	318 CID	High Performance; Base,Miser,S	US1053H
1992	V8-5.2L	318 CID	Base	US7159
1993	V8-5.2L	318 CID	Base	US7160
1977-1991	V8-5.9L	360 CID	Base,Miser	US1053
1977-1991	V8-5.9L	360 CID	High Performance; Base,Miser	US1053H
1993	V8-5.9L	360 CID	Base	US7160
1977-1978	V8-6.6L	400 CID		US1040
1978	V8-7.2L	440 CID		US1040
<b>D150 (MEX)</b>				
1980-1990	L6-3.7L	225 CID	2BL ; 1/2 Ton,1BL ; 1/2 Ton	US7100
1980-1990	V8-5.2L	360 CID	2BL ; 1/2 Ton,4BL ; 1/2 Ton	US1053
1980-1990	V8-5.9L	360 CID	2BL High Performance ; 1/2 Ton, 4BL High Performance ; 1/2 Ton	US1053H
<b>D200</b>				
1975-1980	L6-3.7L	225 CID	Base	US7100
1975-1980	V8-5.2L	318 CID	Base	US1053
1975-1980	V8-5.2L	318 CID	High Performance; Base	US1053H
1975-1980	V8-5.9L	360 CID	Base	US1053
1975-1980	V8-5.9L	360 CID	High Performance; Base	US1053H
1975-1978	V8-6.6L	400 CID		US1040
1975-1978	V8-7.2L	440 CID		US1040
<b>D200 PICKUP</b>				
1968-1969	V8-5.2L	318 CID		US919
<b>D200 SERIES</b>				
1960-1967	V8-5.2L	318 CID		US919
<b>D250</b>				
1981-1987	L6-3.7L	225 CID	Base	US7100
1989-1993	L6-5.9L	359 CID	Hardened pulley; Base	US7145HN
1989-1993	L6-5.9L	359 CID	Standard pulley; Base	US7145
1988-1991	V6-3.9L	239 CID	Base	US1053
1988-1991	V6-3.9L	239 CID	High Performance; Base	US1053H
1992-1993	V6-3.9L	239 CID	Base	US7160
1981-1991	V8-5.2L	318 CID	Base	US1053
1981-1991	V8-5.2L	318 CID	High Performance; Base	US1053H
1992-1993	V8-5.2L	318 CID	Base	US7160
1981-1992	V8-5.9L	360 CID	Base	US1053
1981-1992	V8-5.9L	360 CID	High Performance; Base	US1053H
1993	V8-5.9L	360 CID	Base	US7160
<b>D250 (MEX)</b>				
1989-1990	V8-5.9L	360 CID	4BL ; 3/4 Ton	US1053
1989-1990	V8-5.9L	360 CID	4BL High Performance ; 3/4 Ton	US1053H
<b>D300</b>				
1975-1978	L6-3.7L	225 CID		US7100
1975-1980	V8-5.2L	318 CID	Base	US1053
1975-1980	V8-5.2L	318 CID	High Performance; Base	US1053H
1975-1980	V8-5.9L	360 CID	Base	US1053
1975-1980	V8-5.9L	360 CID	High Performance; Base	US1053H
1976-1978	V8-6.6L	400 CID		US1040
1975-1978	V8-7.2L	440 CID		US1040

Years	Engine	Disp.	Application Description	USMW
<b>D300 (MEX)</b>				
1967-1979	L6-3.7L	225 CID	1BL ; 1 Ton, 1 Ton	US7100
<b>D300 PICKUP</b>				
1968-1969	V8-5.2L	318 CID		US919
<b>D300 SERIES</b>				
1960-1967	V8-5.2L	318 CID		US919
<b>D350</b>				
1989-1993	L6-5.9L	359 CID	Hardened pulley; Base	US7145HN
1989-1993	L6-5.9L	359 CID	Standard pulley; Base	US7145
1981-1983	V8-5.2L	318 CID	Base	US1053
1981-1983	V8-5.2L	318 CID	High Performance; Base	US1053H
1981-1992	V8-5.9L	360 CID	Base	US1053
1981-1992	V8-5.9L	360 CID	High Performance; Base	US1053H
1993	V8-5.9L	360 CID	Base	US7160
<b>D350 (MEX)</b>				
1980-1990	L6-3.7L	225 CID	1BL ; 1 Ton, 1 Ton	US7100
1980-1982	V8-5.2L	318 CID	2BL ; 1 Ton, 2BL	US1053
1980-1982	V8-5.2L	318 CID	2BL High Performance ; 1 Ton, 2BL High Performance	US1053H
1980-1990	V8-5.9L	360 CID	2BL ; 4BL	US1053
1980-1990	V8-5.9L	360 CID	2BL High Performance ; 4BL High Performance	US1053H
<b>D400</b>				
1980-1981	V8-5.9L	360 CID	Base	US1053
1980-1981	V8-5.9L	360 CID	High Performance; Base	US1053H
<b>D450</b>				
1980-1981	V8-5.9L	360 CID	Base	US1053
1980-1981	V8-5.9L	360 CID	High Performance; Base	US1053H
<b>D50</b>				
1979-1982	L4-2.0L	122 CID	Base, Custom	US7116
1979-1982	L4-2.6L	156 CID	Sport, Royal, Custom	US7116
<b>DAKOTA</b>				
1987-1988	L4-2.2L	135 CID	Base, LE, SE, Sport	US7110
1989	L4-2.5L	153 CID	Base, LE, SE, Sport	US7122
1990-1995	L4-2.5L	153 CID	Base, LE, S, SE, Sport, SLT, WS	US7127
1996-2002	L4-2.5L	153 CID	Base, SLT, Sport, WS, SXT	US7136
2004-2010	V6-3.7L	226 CID	Base, SLT, SLT Plus, Sport, Sport Plus, Stampede, SXT, Laramie, ST, TRX, TRX4, Big Horn, Lone Star	US7163
1987-1991	V6-3.9L	239 CID	Base, LE, SE, Sport, S	US1053
1987-1991	V6-3.9L	239 CID	High Performance; Base, LE, SE, Sport, S	US1053H
1992	V6-3.9L	239 CID	Base, LE, S, Sport	US7159
1993-2003	V6-3.9L	239 CID	Base, LE, S, Sport, SLT, WS, SXT	US7160
2000-2010	V8-4.7L	287 CID	Base, SLT, Sport, TRX4	US7163
2002-2010	V8-4.7L	285 CID	Base, SLT, Sport, SXT, SLT Plus, Sport Plus, Laramie, ST, TRX, TRX4, Big Horn, Lone Star	US7163
1989	V8-5.2L	318 CID	High Performance; Shelby, Shelby	US1053H
1990-1991	V8-5.2L	318 CID	Base, LE, S, SE, Sport	US7128
1993-1999	V8-5.2L	318 CID	Base, LE, S, Sport, SLT, WS	US7160
1998-2003	V8-5.9L	360 CID	R/T, SLT, Sport, SXT	US7160
<b>DAKOTA (MEX)</b>				
2010-2011	V6-3.7L	226 CID	MFI SOHC ; SLT	US7163
<b>DART</b>				
1975-1976	L6-3.7L	225 CID		US7100
1964-1969	V8-4.5L	273 CID		US919
1960-1969	V8-5.2L	318 CID		US919
1975-1976	V8-5.2L	318 CID		US1053
1975-1976	V8-5.2L	318 CID	High Performance	US1053H
1968-1969	V8-5.6L	340 CID		US919
1975-1976	V8-5.9L	360 CID		US1053
1975-1976	V8-5.9L	360 CID	High Performance	US1053H
<b>DART (MEX)</b>				
1982-1988	L4-2.2L	135 CID	2BL ; K	US7110
1989	L4-2.2L	135 CID	2BL ; K	US7122
1965-1982	L6-3.7L	225 CID	2BL ; 1BL	US7100
1977-1982	V8-5.9L	360 CID	4BL	US1053
1977-1982	V8-5.9L	360 CID	4BL High Performance	US1053H
<b>DAYTONA</b>				
1984-1988	L4-2.2L	135 CID	Base, Turbo, Turbo Z, Pacifica, Shelby Z	US7110
1989	L4-2.2L	135 CID	Base, Shelby	US7122

Years	Engine	Disp.	Application Description	USMW
1990	L4-2.2L	135 CID	Base, Shelby	US7127
1986-1988	L4-2.5L	153 CID	Base, Pacifica	US7110
1989	L4-2.5L	153 CID	Base, ES, ES Turbo, Shelby	US7122
1990-1993	L4-2.5L	153 CID	Base, ES, ES Turbo, Shelby, Iroc	US7127
1990-1993	V6-3.0L	181 CID	Base, ES, Iroc	US7121
1992-1993	V6-3.0L	182 CID	Iroc R/T	US7139
<b>DIPLOMAT</b>				
1978-1983	L6-3.7L	225 CID	Base, Medallion, Salon, Sport	US7100
1977-1989	V8-5.2L	318 CID	Base, Medallion, Salon, SE	US1053
1977-1989	V8-5.2L	318 CID	High Performance; Base, Medallion, Salon, SE	US1053H
1978-1979	V8-5.9L	360 CID		US1053
1978-1979	V8-5.9L	360 CID	High Performance	US1053H
<b>DURANGO</b>				
2011-2014	V6-3.6L	220 CID		US8981
2004-2009	V6-3.7L	226 CID	SLT, ST, SXT	US7163
1998-1999	V6-3.9L	239 CID	Base, SLT, SLT Plus	US7160
2000-2001	V8-4.7L	287 CID	Base, R/T, SLT, SLT Plus, Sport	US7163
2002-2009	V8-4.7L	285 CID	R/T, SLT, SLT Plus, Sport, Limited, ST, SXT, Adventurer	US7163
1998-2000	V8-5.2L	318 CID	Base, SLT, SLT Plus, R/T, Sport	US7160
2004-2008	V8-5.7L	345 CID	Limited, SLT, ST, Adventurer, SXT	US7168
2009	V8-5.7L	345 CID	Adventurer, Limited, SLT	US6341
2011-2012	V8-5.7L	345 CID	Citadel, R/T, Crew	US8971
1998-2003	V8-5.9L	360 CID	Base, SLT, SLT Plus, R/T, Sport	US7160
<b>DYNASTY</b>				
1988	L4-2.5L	153 CID	Base, LE	US7110
1989	L4-2.5L	153 CID	Base	US7122
1990-1993	L4-2.5L	153 CID	Base	US7127
1988-1993	V6-3.0L	181 CID	Base, LE, LS	US7121
1990-1993	V6-3.3L	201 CID	Base, LE, LS	US7126
<b>GRAND CARAVAN</b>				
1996-1997	L4-2.4L	148 CID	Mechanical Tensioner; Base, SE, Base	US7156
1988	L4-2.5L	153 CID	SE	US7110
1988-2000	V6-3.0L	181 CID	LE, SE, Base, ES, Sport	US7121
1990-2000	V6-3.3L	201 CID	LE, SE, Base, ES, Sport	US7126
2001-2007	V6-3.3L	201 CID	ES, SE, Sport, EL, EX, Base, C/V, SE Plus, SXT	US7165
2008-2010	V6-3.3L	201 CID		US6231
2011-2014	V6-3.6L	220 CID		US8981
1994-2000	V6-3.8L	230 CID	ES, LE, SE, Base, Sport	US7126
2001-2007	V6-3.8L	230 CID	ES, EX, Sport, EL, SE, Anniversary Edition, C/V, SXT, SE Plus	US7165
2008	V6-3.8L	230 CID		US6231
2009-2010	V6-3.8L	231 CID		US6231
2008-2010	V6-4.0L	241 CID	SXT	US8951
<b>H100 (MEX)</b>				
2006-2010	L4-2.5L	151 CID	Turbo Dsl	US8922
<b>H-100 (MEX)</b>				
2003-2005	L4-2.4L	144 CID	FI	US7114
<b>INTREPID</b>				
1998-2004	V6-2.7L	167 CID	Base, ES, R/T, SE	US7161
1998-2001	V6-3.2L	197 CID	Base, ES, SE	US7162
1993-1997	V6-3.3L	201 CID	Base, ES	US7140
1993-1994	V6-3.5L	215 CID	Base, ES	US7141
1995-1996	V6-3.5L	215 CID	Base, ES	US7151
1997	V6-3.5L	215 CID	6 Bolt Pattern; Base, ES, Base	US7158
2000-2004	V6-3.5L	215 CID	R/T, SE, ES, SXT, Police	US7162
<b>JOURNEY</b>				
2009-2012	L4-2.4L	144 CID	SE, Base, Express, AVP	US6038
2009-2010	V6-3.5L	215 CID	R/T, SXT, Crew	US8951
2011-2014	V6-3.6L	220 CID		US8981
<b>JOURNEY SE (MEX)</b>				
2011	L4-2.4L	144 CID	SFI DOHC	US6038
<b>JOURNEY SXT (MEX)</b>				
2011	L4-2.4L	144 CID	SFI DOHC	US6038
<b>LANCER</b>				
1985-1988	L4-2.2L	135 CID	Base, ES, Shelby	US7110
1989	L4-2.2L	135 CID	Base, Shelby	US7122
1986-1988	L4-2.5L	153 CID	Base, ES, Shelby	US7110
1989	L4-2.5L	153 CID	Base, ES, Shelby	US7122



# WATER PUMP APPLICATION GUIDE



Years	Engine	Disp.	Application Description	USMW
<b>MAGNUM</b>				
2005-2007	V6-2.7L	167 CID	SE	US7161
2008	V6-2.7L	167 CID	SE	US6217
2005-2008	V6-3.5L	215 CID	SXT,SXT Special Edition,SE	US8951
1978-1979	V8-5.2L	318 CID		US1053
1978-1979	V8-5.2L	318 CID	High Performance	US1053H
2005-2008	V8-5.7L	345 CID	RT	US8940
1978-1979	V8-5.9L	360 CID		US1053
1978-1979	V8-5.9L	360 CID	High Performance	US1053H
2006-2008	V8-6.1L	370 CID	SRT8	US8940
1978	V8-6.6L	400 CID		US1040
<b>MAGNUM (MEX)</b>				
1983-1988	L4-2.2L	135 CID	2BL ; K,K	US7110
1980-1982	V8-5.9L	360 CID	4BL	US1053
1980-1982	V8-5.9L	360 CID	4BL High Performance	US1053H
<b>MATADOR</b>				
1960	V8-5.2L	318 CID		US919
<b>MICROBUS (MEX)</b>				
1988-1991	V8-5.9L	360 CID	4BL	US1053
1988-1991	V8-5.9L	360 CID	4BL High Performance	US1053H
1992	V8-5.9L	360 CID	MFI	US7159
1993-1997	V8-5.9L	360 CID	MFI	US7160
<b>MINI RAM</b>				
1984-1987	L4-2.2L	135 CID	Base,Royal	US7110
1987-1988	L4-2.5L	153 CID	Base,Royal	US7110
1984-1987	L4-2.6L	156 CID	Base,Royal	US7111
1987-1988	V6-3.0L	181 CID	Base,Royal	US7121
<b>MIRADA</b>				
1980-1983	L6-3.7L	225 CID	Special Coupe	US7100
1980-1983	V8-5.2L	318 CID	High Performance; Special Coupe	US1053H
1980-1983	V8-5.2L	318 CID	Special Coupe	US1053
1980	V8-5.9L	360 CID	High Performance; Special Coupe,Special Coupe	US1053H
<b>MONACO</b>				
1977-1978	L6-3.7L	225 CID		US7100
1990-1991	V6-3.0L	182 CID	ES,LE	US3411
1968-1969	V8-5.2L	318 CID		US919
1975-1978	V8-5.2L	318 CID		US1053
1975-1978	V8-5.2L	318 CID	High Performance	US1053H
1975-1978	V8-5.9L	360 CID		US1053
1975-1978	V8-5.9L	360 CID	High Performance	US1053H
1975-1978	V8-6.6L	400 CID		US1040
1975-1978	V8-7.2L	440 CID		US1040
<b>MONACO (MEX)</b>				
1969	V8-5.2L	318 CID	4BL	US919
1970-1973	V8-5.2L	318 CID	4BL High Performance	US1053H
1970-1974	V8-5.2L	318 CID	4BL	US1053
1972-1973	V8-5.9L	360 CID	4BL	US1053
1972-1973	V8-5.9L	360 CID	4BL High Performance	US1053H
<b>NEON</b>				
1995-2005	L4-2.0L	122 CID	Base,High Line,Sport,ACR,R/T,ES,SE,SXT	US7150
2003-2005	L4-2.4L	148 CID	SRT-4	US7167
<b>NITRO</b>				
2007-2011	V6-3.7L	226 CID	SLT,SXT,SE,Heat	US7163
2007-2011	V6-4.0L	241 CID	RT,Detonator,Heat,Shock,SXT	US8951
<b>OMNI</b>				
1983-1986	L4-1.6L	97 CID	Base,Custom,GLH,SE	US7113
1978-1983	L4-1.7L	105 CID	24,Base,024 Miser,Miser,024 Charger 2.2, Custom,E-Type	US7101
1981-1988	L4-2.2L	135 CID	24,024 Miser,Base,Miser,024 Charger 2.2, Custom,E-Type,GLH,SE,America	US7110
1989	L4-2.2L	135 CID	America	US7122
1990	L4-2.2L	135 CID	Base	US7127
<b>POLARA</b>				
1964-1967	V8-4.5L	273 CID		US919
1960-1969	V8-5.2L	318 CID		US919
<b>POWER RAM 50</b>				
1983-1984	L4-2.0L	122 CID	Custom	US7114

Years	Engine	Disp.	Application Description	USMW
1983-1985	L4-2.3L	143 CID	Sport,Royal	US7117
1983	L4-2.6L	2555cc	Sport	US7114
1984-1986	L4-2.6L	156 CID	Custom,Royal,Sport,To 01/85; Custom	US7116
1985-1986	L4-2.6L	156 CID	From 02/85; Custom,Royal,Sport	US7120
<b>RAIDER</b>				
1987-1988	L4-2.6L	156 CID	Base	US7116
1987-1989	L4-2.6L	156 CID	Base	US7120
1989	V6-3.0L	181 CID	Base	US7121
<b>RAM (MEX)</b>				
2010	V8-4.7L	287 CID	MFI ; ST,ST 4WD	US7163
<b>RAM 1500</b>				
2004-2006	V10-8.3L	505 CID	SRT-10	US7166
2002-2010	V6-3.7L	226 CID	SLT,ST,Laramie,WS,SXT	US7163
1994-2001	V6-3.9L	239 CID	Base,Laramie,Sport,ST,WS	US7160
2002-2004	V8-4.7L	287 CID	SLT,ST,Laramie,WS	US7163
2005-2010	V8-4.7L	285 CID	SLT,ST,Laramie,TRX4,SXT,TRX	US7163
1994-2001	V8-5.2L	318 CID	Base,Laramie,Sport,ST,WS	US7160
2003-2008	V8-5.7L	345 CID	Laramie,SLT,ST,WS,Hemi Sport,Rumble Bee,Sport, TRX4,SXT	US7168
2009-2010	V8-5.7L	345 CID	Laramie,SLT,Sport,ST,TRX,TRX4	US6341
1994-2003	V8-5.9L	360 CID	Base,Laramie,Sport,ST,WS,SLT	US7160
<b>RAM 1500 VAN</b>				
1999-2003	V6-3.9L	239 CID	Base	US7160
1999-2003	V8-5.2L	318 CID	Base	US7160
1999-2003	V8-5.9L	360 CID	Base	US7160
<b>RAM 2500</b>				
1994-2009	L6-5.9L	359 CID	Hardened pulley; Base, SLT,ST, Laramie,Sport,TRX4	US7145HN
1994-2009	L6-5.9L	359 CID	Standard pulley; Base, SLT,ST,Laramie,Sport,TRX4	US7145
2009	L6-5.9L	359 CID	Power Wagon,ST	US6341
2007-2010	L6-6.7L	408 CID	Laramie,SLT,ST,SXT	US6222
1994-2003	V10-8.0L	488 CID	Base	US7169
1994-1996	V8-5.2L	318 CID	Base	US7160
2003-2008	V8-5.7L	345 CID	Base,SLT,ST,Laramie,Power Wagon,Sport,TRX4,SXT	US7168
2009-2010	V8-5.7L	345 CID	Laramie,SLT,ST,SXT,Power Wagon	US6341
1994-2002	V8-5.9L	360 CID	Base	US7160
<b>RAM 2500 (MEX)</b>				
2003-2009	V8-4.7L	287 CID	SFI ; 3/4 Ton,3/4 Ton 4WD	US7163
1998-2001	V8-5.2L	318 CID	MFI ; 3/4 Ton,3/4 Ton 4WD	US7160
<b>RAM 2500 VAN</b>				
2001	V6-3.9L	239 CID	Base	US7160
1999-2003	V8-5.2L	318 CID	Base	US7160
1999-2003	V8-5.9L	360 CID	Base	US7160
<b>RAM 3500</b>				
1994-2009	L6-5.9L	359 CID	Hardened pulley; Base, SLT,ST, Laramie,Sport,TRX4	US7145HN
1994-2009	L6-5.9L	359 CID	Standard pulley; Base,SLT,ST,Laramie,Sport,TRX4	US7145
2009	L6-5.9L	359 CID	ST	US6341
2007-2010	L6-6.7L	408 CID	Laramie,SLT,Sport,ST,SXT	US6222
1994-2003	V10-8.0L	488 CID	Base	US7169
2003-2008	V8-5.7L	345 CID	Base,SLT,ST,Laramie,Sport,SXT	US7168
2009	V8-5.7L	345 CID	Laramie,SLT,ST,SXT	US6341
1994-2002	V8-5.9L	360 CID	Base	US7160
<b>RAM 3500 (MEX)</b>				
1994	V8-5.2L	318 CID	MFI ; 1 Ton,1 Ton 4WD	US7160
<b>RAM 3500 VAN</b>				
1999-2003	V8-5.2L	318 CID	Base	US7160
1999-2003	V8-5.9L	360 CID	Base	US7160
<b>RAM 4500</b>				
2008-2010	L6-6.7L	408 CID	Laramie,SLT,ST	US6222
<b>RAM 50</b>				
1983-1989	L4-2.0L	122 CID	Custom,Royal,Base	US7114
1983-1985	L4-2.3L	143 CID	Royal,Sport	US7117
1990-1993	L4-2.4L	2351cc	Base,LE,SE	US7114
1983-1985	L4-2.6L	2555cc	Royal,Sport,To 01/85; Custom	US7114
1984	L4-2.6L	156 CID	Custom,Royal,Sport	US7116
1985-1989	L4-2.6L	156 CID	From 02/85; Custom,Royal,Sport,Custom,Base	US7120
1990-1991	V6-3.0L	181 CID	Base,LE,SE	US7121
<b>RAM 5500</b>				
2008-2010	L6-6.7L	408 CID	Laramie,SLT,ST	US6222



Years	Engine	Disp.	Application Description	USMW
<b>RAMCHARGER</b>				
1975-1980	L6-3.7L	225 CID	Base,SE	US7100
1975-1991	V8-5.2L	318 CID	Base,SE,Royal SE,Canyon Sport	US1053
1975-1991	V8-5.2L	318 CID	High Performance; Base,SE,Royal SE,Canyon Sport	US1053H
1992-1993	V8-5.2L	318 CID	Royal SE,Base,Canyon Sport	US7160
1975-1992	V8-5.9L	360 CID	Base,SE,Royal SE,Canyon Sport	US1053
1975-1992	V8-5.9L	360 CID	High Performance; Base,SE,Royal SE,Canyon Sport	US1053H
1993	V8-5.9L	360 CID	Base,Canyon Sport,Royal SE	US7160
1976-1978	V8-6.6L	400 CID		US1040
1975-1978	V8-7.2L	440 CID		US1040
<b>RAMCHARGER (MEX)</b>				
1999-2001	V8-5.2L	318 CID	MFI	US7160
1980-1990	V8-5.9L	360 CID	2BL ; 2WD,4WD,2WD,4BL ; 2WD	US1053
1980-1990	V8-5.9L	360 CID	2BL High Performance ; 2WD,4WD,2WD,4BL High Performance ; 2WD	US1053H
1994-2000	V8-5.9L	360 CID	MFI ; 4WD,,MFI	US7160
<b>RAMPAGE</b>				
1982-1984	L4-2.2L	135 CID	High Line,Sport,2.2,Base	US7110
<b>RD200</b>				
1980	V8-5.2L	318 CID	High Performance; Base	US1053H
1980	V8-5.9L	360 CID	High Performance; Base	US1053H
<b>ROYAL MINI RAM</b>				
1984-1987	L4-2.2L	135 CID	Base	US7110
1984-1987	L4-2.6L	156 CID	Base	US7111
1987	V6-3.0L	181 CID	Base	US7121
<b>ROYAL MONACO</b>				
1975-1977	V8-5.2L	318 CID		US1053
1975-1977	V8-5.2L	318 CID	High Performance	US1053H
1975-1977	V8-5.9L	360 CID		US1053
1975-1977	V8-5.9L	360 CID	High Performance	US1053H
1975-1977	V8-6.6L	400 CID		US1040
1975-1977	V8-7.2L	440 CID		US1040
<b>SENECA</b>				
1960-1961	V8-5.2L	318 CID		US919
<b>SHADOW</b>				
1987-1988	L4-2.2L	135 CID	Base,Shelby,ES	US7110
1989	L4-2.2L	135 CID	Base,Shelby	US7122
1990-1994	L4-2.2L	135 CID	Base,America,High Line	US7127
1988	L4-2.5L	153 CID	Base	US7110
1989	L4-2.5L	153 CID	Base,ES	US7122
1990-1994	L4-2.5L	153 CID	Base,ES,High Line,America	US7127
1992-1994	V6-3.0L	181 CID	ES,High Line	US7121
<b>SHADOW (MEX)</b>				
1988	L4-2.2L	135 CID	2BL	US7110
1989	L4-2.2L	135 CID	2BL	US7122
1990	L4-2.2L	135 CID	2BL	US7127
1990-1994	L4-2.5L	153 CID	2BL ;,MFI Turbo	US7127
<b>SPIRIT</b>				
1991-1992	L4-2.2L	135 CID	R/T	US7139
1989	L4-2.5L	153 CID	Base,ES,LE	US7122
1990-1995	L4-2.5L	153 CID	Base,ES,LE,High Line	US7127
1989-1995	V6-3.0L	181 CID	ES,Base,LE,High Line	US7121
<b>SPIRIT (MEX)</b>				
1993	L4-2.2L	135 CID	FI Turbo	US7127
1989	L4-2.5L	153 CID	2BL	US7122
1990-1995	L4-2.5L	153 CID	2BL ;,MFI Turbo	US7127
<b>SPRINTER 2500</b>				
2003	L5-2.7L	165 CID	Base	US6008
2004-2006	L5-2.7L	165 CID	Base	US6007
2007-2009	V6-3.0L	2987cc	Base	US6155
<b>SPRINTER 3500</b>				
2003	L5-2.7L	165 CID	Base	US6008
2004-2006	L5-2.7L	165 CID	Base	US6007
2007-2009	V6-3.0L	2987cc	Base	US6155
<b>ST. REGIS</b>				
1979-1981	L6-3.7L	225 CID	Base	US7100
1979-1981	V8-5.2L	318 CID	Base	US1053

Years	Engine	Disp.	Application Description	USMW
1979-1981	V8-5.2L	318 CID	High Performance; Base	US1053H
1979-1980	V8-5.9L	360 CID	Base	US1053
1979-1980	V8-5.9L	360 CID	High Performance; Base	US1053H
<b>STEALTH</b>				
1991-1996	V6-3.0L	181 CID	Base,R/T Turbo,ES,R/T	US7129
1991-1996	V6-3.0L	181 CID	ES,R/T,Base	US7121
<b>STRATUS</b>				
1995-2000	L4-2.0L	122 CID	Base,ES,SE	US7150
1995	L4-2.4L	148 CID	Base,ES	US7153
1996-2006	L4-2.4L	148 CID	Mechanical Tensioner; Base,ES,Base,SE,SE Plus,SXT	US7156
2001-2005	L4-2.4L	2351cc	SE,SXT	US9399
1995-2000	V6-2.5L	152 CID	ES,Base,SE	US7152
2001-2006	V6-2.7L	167 CID	ES,SE,R/T,SE Plus,SXT	US7161
2001-2005	V6-3.0L	181 CID	R/T,SE	US7152
<b>STRATUS (MEX)</b>				
2001-2006	L4-2.0L	122 CID	MFI DOHC	US7156
1998-2006	L4-2.4L	148 CID	Turbo ;,Turbo DOHC	US7156
<b>TRUCK</b>				
1960	V8-5.2L	318 CID		US919
<b>VERNA (MEX)</b>				
2004-2006	L4-1.5L	92 CID	FI SOHC	US7115
2004-2006	L4-1.6L	97 CID	MFI DOHC	US9364
<b>VIPER</b>				
1992-1996	V10-8.0L	488 CID	Base	US7146
2003-2006	V10-8.3L	505 CID	SRT-10	US7166
<b>W100</b>				
1975-1987	L6-3.7L	225 CID	Custom	US7100
1989	V6-3.9L	239 CID	High Performance; Custom	US1053H
1975-1989	V8-5.2L	318 CID	Custom	US1053
1975-1989	V8-5.2L	318 CID	High Performance; Custom	US1053H
1975-1988	V8-5.9L	360 CID	Custom	US1053
1975-1988	V8-5.9L	360 CID	High Performance; Custom	US1053H
1975-1977	V8-6.6L	400 CID		US1040
1975-1977	V8-7.2L	440 CID		US1040
<b>W100 PICKUP</b>				
1968-1969	V8-5.2L	318 CID		US919
<b>W100 SERIES</b>				
1960-1967	V8-5.2L	318 CID		US919
<b>W150</b>				
1978-1987	L6-3.7L	225 CID	Base	US7100
1989-1991	V6-3.9L	239 CID	Base,S	US1053
1989-1991	V6-3.9L	239 CID	High Performance; Base,S	US1053H
1992-1993	V6-3.9L	239 CID	Base	US7160
1977-1991	V8-5.2L	318 CID	Base,S	US1053
1977-1991	V8-5.2L	318 CID	High Performance; Base,S	US1053H
1992-1993	V8-5.2L	318 CID	Base	US7160
1977-1991	V8-5.9L	360 CID	Base,S	US1053
1977-1991	V8-5.9L	360 CID	High Performance; Base,S	US1053H
1993	V8-5.9L	360 CID	Base	US7160
<b>W200</b>				
1975-1980	L6-3.7L	225 CID	Base	US7100
1975-1980	V8-5.2L	318 CID	Base	US1053
1975-1980	V8-5.2L	318 CID	High Performance; Base	US1053H
1975-1980	V8-5.9L	360 CID	Base	US1053
1975-1980	V8-5.9L	360 CID	High Performance; Base	US1053H
1976-1978	V8-6.6L	400 CID		US1040
1975-1978	V8-7.2L	440 CID		US1040
<b>W200 PICKUP</b>				
1968-1969	V8-5.2L	318 CID		US919
<b>W200 SERIES</b>				
1960-1967	V8-5.2L	318 CID		US919
<b>W250</b>				
1989-1993	L6-5.9L	359 CID	Hardened pulley; Base	US7145HN
1989-1993	L6-5.9L	359 CID	Standard pulley; Base	US7145
1981-1991	V8-5.2L	318 CID	Base	US1053
1981-1991	V8-5.2L	318 CID	High Performance; Base	US1053H
1992-1993	V8-5.2L	318 CID	Base	US7160
1981-1992	V8-5.9L	360 CID	Base	US1053

Years	Engine	Disp.	Application Description	USMW
1981-1992	V8-5.9L	360 CID	High Performance; Base	US1053H
1993	V8-5.9L	360 CID	Base	US7160
<b>W250 (MEX)</b>				
1985-1987	L6-3.7L	225 CID	1BL ; 3/4 Ton 4WD	US7100
1989-1990	V8-5.9L	360 CID	4BL ; 3/4 Ton 4WD	US1053
1989-1990	V8-5.9L	360 CID	4BL High Performance ; 3/4 Ton 4WD	US1053H
<b>W300</b>				
1975-1978	L6-3.7L	225 CID		US7100
1975-1980	V8-5.2L	318 CID	Base	US1053
1975-1980	V8-5.2L	318 CID	High Performance; Base	US1053H
1975-1980	V8-5.9L	360 CID	Base	US1053
1975-1980	V8-5.9L	360 CID	High Performance; Base	US1053H
1976-1978	V8-6.6L	400 CID		US1040
1975-1978	V8-7.2L	440 CID		US1040
<b>W300 PICKUP</b>				
1968-1969	V8-5.2L	318 CID		US919
<b>W300 SERIES</b>				
1960-1967	V8-5.2L	318 CID		US919
<b>W350</b>				
1989-1993	L6-5.9L	359 CID	Hardened pulley; Base	US7145HN
1989-1993	L6-5.9L	359 CID	Standard pulley; Base	US7145
1982-1983	V8-5.2L	318 CID	Base	US1053
1982-1983	V8-5.2L	318 CID	High Performance; Base	US1053H
1981-1992	V8-5.9L	360 CID	Base	US1053
1981-1992	V8-5.9L	360 CID	High Performance; Base	US1053H
1993	V8-5.9L	360 CID	Base	US7160
<b>WM300 POWER WAGON</b>				
1960-1962	V8-5.2L	318 CID		US919
<b>EAGLE</b>				
<b>MEDALLION</b>				
1988-1989	L4-2.2L	132 CID	DL,LX	US3410
<b>PREMIER</b>				
1988-1989	L4-2.5L	150 CID	LX	US3412
1988-1991	V6-3.0L	182 CID	ES,LX,ES Limited	US3411
<b>SUMMIT</b>				
1989-1996	L4-1.5L	90 CID	DL,LX,Base,ES,ESi	US7115
1989-1990	L4-1.6L	98 CID	LX	US7131
1992-1996	L4-1.8L	112 CID	Base,DL,LX,ES,ESi	US7135
1992	L4-2.4L	2351cc	Base,DL,LX	US9168
1993-1996	L4-2.4L	2351cc	Base,DL,LX	US7148
<b>TALON</b>				
1993-1994	L4-1.8L	107 CID	DL	US7108
1990-1994	L4-2.0L	1997cc	Base,TSi,ES	US9212
1995-1998	L4-2.0L	122 CID	ESi,Base	US7150
1995-1998	L4-2.0L	122 CID	TSi	US7148
<b>VISION</b>				
1993-1994	V6-3.3L	201 CID	TSi	US7141
1993-1997	V6-3.3L	201 CID	ESi	US7140
1995-1996	V6-3.5L	215 CID	ESi,TSi	US7151
1997	V6-3.5L	215 CID	6 Bolt Pattern; ESi,TSi,ESi	US7158
<b>EDSEL</b>				
<b>RANGER</b>				
1959-1960	V8-4.5I	292 CID		US488
<b>FIAT</b>				
<b>124</b>				
1966-1969	L4-1.2L	1197cc		US9203
1974-1978	L4-1.6L	1595cc		US9003
1974-1978	L4-1.8L	1756cc		US9003
1979-1982	L4-2.0L	1995cc	Spider 2000	US9003
<b>127</b>				
1977-1987	L4-1.0L	1049cc	C,CL,L,Sport	US8944
1980-1987	L4-1.3L	1301cc	Sport	US8944
<b>128</b>				
1971-1973	L4-1.1L	1116cc		US9084
1974-1976	L4-1.3L	1290cc		US9084

Years	Engine	Disp.	Application Description	USMW
<b>131</b>				
1975-1978	L4-1.8L	1756cc		US9003
<b>147</b>				
1980-1983	L4-1.0L	1049cc	L	US8944
<b>BRAVA</b>				
1979-1981	L4-2.0L	1995cc		US9003
<b>BRAVO</b>				
1995-2001	L4-1.6L	1581cc		US8948
<b>DUNA</b>				
1987-1990	L4-1.1L	1116cc	60,Weekend	US8944
1987-1990	L4-1.3L	1301cc	70,Weekend	US8944
<b>FIORINO</b>				
1985-1989	L4-1.0L	1049cc	Furgoneta	US8944
1983-1989	L4-1.3L	1301cc	DS	US8944
<b>FIORINO'90</b>				
1990-1992	L4-1.1L	1116cc	Furgoneta	US8944
1989-1992	L4-1.3L	1301cc	DS,Furgoneta	US8944
<b>FIORINO'93</b>				
1993-2000	L4-1.3L	1301cc	Furgoneta	US8944
<b>GRANDE PUNTO</b>				
2007-2008	L4-1.4L	1368cc	SFI	US8946
<b>GRANDE PUNTO (MEX)</b>				
2007-2009	L4-1.4L	1368cc	SFI DOHC	US8946
<b>IDEA ADVENTURE (MEX)</b>				
2008-2009	L4-1.8L	1796cc	SFI SOHC	US8938
<b>PALIO</b>				
1998-2001	L4-1.6L	1581cc		US8948
<b>PALIO (MEX)</b>				
2004-2005	L4-1.6L	1593cc	MFI	US8948
2005-2009	L4-1.8L	1796cc	MFI DOHC ;,SFI SOHC	US8938
<b>PANDA</b>				
2007-2008	L4-1.2L	1242cc		US8945
1986-1994	L4-1.3L	1301cc	Diesel; Van,	US8944
<b>PANDA (MEX)</b>				
2007-2012	L4-1.2L	1242cc	4WD,,FI SOHC ; Dynamic, Dynamic 4WD,FI SOHC	US8945
<b>STILO</b>				
2001-2007	L4-1.6L	1596cc		US8948
<b>STRADA</b>				
1979	L4-1.0L	1498cc	60	US8944
1980-1983	L4-1.0L	1048cc	60	US8944
1979	L4-1.5L	1048cc		US8944
1979-1982	L4-1.5L	1498cc	W/ Air Cond.	US9085
1979-1982	L4-1.5L	1498cc	W/O Air Cond.	US9084
<b>STRADA (MEX)</b>				
2007-2009	L4-1.8L	1796cc	SFI SOHC ; Adventure	US8938
<b>UNO</b>				
1989-1994	L4-1.0L	994cc	Trend	US8944
1989-1994	L4-1.1L	1116cc	Trend	US8944
1983-1994	L4-1.3L	1301cc	Diesel	US8944
<b>X 1/9</b>				
1975-1978	L4-1.3L	1290cc		US9084
1979-1982	L4-1.5L	1498cc	W/O Air Cond.	US9084
1979-1982	L4-1.5L	1498cc	W/ Air Cond.	US9085
<b>FORD</b>				
<b>AEROSTAR</b>				
1986-1987	L4-2.3L	140 CID	Base,XL,XLT	US4054
1986	V6-2.8L	171 CID	Base,XL,XLT	US4023
1986-1994	V6-3.0L	182 CID	Base,XL,XLT,Eddie Bauer,XL Plus,XLT Plus,XL Sport, XLT Sport	US4039
1995-1997	V6-3.0L	182 CID	Base,XLT,XLT Plus,XLT Sport	US4095
1990-1997	V6-4.0L	245 CID	Base,Base 4WD,Eddie Bauer,Eddie Bauer 4WD, Eddie Bauer E4WD,XL 4WD,XL E4WD,XL Plus, XL Plus 4WD,XL Plus E4WD,XLT 4WD,XLT E4WD, XLT Plus,XLT Plus 4WD,XLT Plus E4WD,XL Sport,	US4060

Years	Engine	Disp.	Application Description	USMW
<b>ASPIRE</b>				
1994-1997	L4-1.3L	1295cc	Base,SE	US4049
<b>B100 (MEX)</b>				
1973-1974	V8-4.7L	289 CID	2BL ; 1/2 Ton	US1028
1973-1974	V8-4.7L	289 CID	2BL High Performance ; 1/2 Ton	US1028H
1973-1979	V8-4.7L	289 CID	4BL High Performance ; 1/2 Ton, 2BL High Performance ; 1/2 Ton	US953H
1973-1979	V8-4.7L	289 CID	4BL; Double tube outlet; 1/2 Ton, 2BL; Double tube outlet; 1/2 Ton	US953
1973-1974	V8-5.0L	302 CID	2BL ; 1/2 Ton	US1028
1973-1974	V8-5.0L	302 CID	2BL High Performance ; 1/2 Ton	US1028H
1973-1981	V8-5.0L	302 CID	4BL High Performance ; 1/2 Ton, 2BL High Performance ; 1/2 Ton	US953H
1973-1981	V8-5.0L	302 CID	4BL; Double tube outlet; 1/2 Ton, 2BL; Double tube outlet; 1/2 Ton	US953
<b>B150 (MEX)</b>				
1982-1985	V6-3.8L	232 CID	2BL High Performance ; 1/2 Ton	US953H
1982-1985	V6-3.8L	232 CID	2BL; Double tube outlet; 1/2 Ton	US953
1975-1978	V8-4.7L	289 CID	2BL High Performance ; 1/2 Ton	US953H
1975-1978	V8-4.7L	289 CID	2BL; Double tube outlet; 1/2 Ton	US953
1975-1985	V8-5.0L	302 CID	2BL High Performance ; 1/2 Ton	US953H
1975-1985	V8-5.0L	302 CID	2BL; Double tube outlet; 1/2 Ton	US953
<b>B200 (MEX)</b>				
1985-1986	V8-5.0L	302 CID	2BL High Performance ; 3/4 Ton	US953H
1985-1986	V8-5.0L	302 CID	2BL; Double tube outlet; 3/4 Ton	US953
1987-1992	V8-5.0L	302 CID	2BL ; 3/4 Ton	US4044
1987-1992	V8-5.0L	302 CID	2BL High Performance ; 3/4 Ton	US4044H
<b>BRONCO</b>				
1966-1972	L6-2.8L	170 CID		US1044
1973-1974	L6-3.3L	200 CID		US1044
1980-1982	L6-4.9L	300 CID	Custom,Ranger XLT,XLS,XLT Lariat	US4030N
1983-1986	L6-4.9L	300 CID	Custom,XLS,XLT Lariat,XLT,Eddie Bauer	US4020
1987-1992	L6-4.9L	300 CID	Custom,Eddie Bauer,XLT,XL,XLT Nite	US4048
1975-1977	V8-5.0L	302 CID		US1028
1975-1977	V8-5.0L	302 CID	High Performance	US1028H
1980-1986	V8-5.0L	302 CID	Double tube outlet; Custom,Ranger XLT,XLS XLT Lariat,XLT,Eddie Bauer	US953
1980-1986	V8-5.0L	302 CID	High Performance; Custom,Ranger XLT,XLS, XLT Lariat,XLT,Eddie Bauer	US953H
1987-1996	V8-5.0L	302 CID	Custom,Eddie Bauer,XLT,XL,XLT Nite,XLT Lariat, XLT Sport	US4044
1987-1996	V8-5.0L	302 CID	High Performance; Custom,Eddie Bauer,XLT,XL, XLT Nite,XLT Lariat,High Performance; Eddie Bauer, XLT Sport	US4044H
1978-1982	V8-5.8L	351 CID	Single tube outlet; Single tube outlet; Custom, Ranger XLT,XLS,XLT Lariat	US932
1978-1987	V8-5.8L	351 CID	Double tube outlet; Custom, Ranger XLT,XLS,XLT Lariat,XLT,Eddie Bauer	US953
1978-1987	V8-5.8L	351 CID	High Performance; Custom,Ranger XLT,XLS,XLT Lariat, XLT,Eddie Bauer	US953H
1988-1996	V8-5.8L	351 CID	Custom,Eddie Bauer,XLT,XL,XLT Nite,XLT Lariat, XLT Sport	US4044
1988-1996	V8-5.8L	351 CID	High Performance; Custom,Eddie Bauer,XLT,XL, XLT Nite,XLT Lariat,High Performance; Eddie Bauer, XLT Sport	US4044H
1978-1979	V8-6.6L	400 CID	Single tube outlet	US932
<b>BRONCO (MEX)</b>				
1997	V6-2.9L	177 CID	FI	US4042
<b>BRONCO II</b>				
1984-1985	V6-2.8L	171 CID	Base,Eddie Bauer,XLS,XLT	US4023
1986-1990	V6-2.9L	177 CID	Base,Eddie Bauer,XLT,XL,XL Sport,XLT Plus	US4042
<b>CAPRI</b>				
1971-1974	L4-2.0L	122 CID		US964
<b>CLUB WAGON</b>				
1962-1966	L6-2.4L	144 CID		US1044
1962-1967	L6-2.8L	170 CID		US1044
1963-1967	L6-3.3L	200 CID		US1044
1962	L6-3.6L	223 CID		US819

Years	Engine	Disp.	Application Description	USMW
1963	V8-3.6L	221 CID		US819
1962-1965	V8-4.3L	260 CID		US819
1963-1965	V8-4.7L	289 CID		US819
1962-1964	V8-5.8L	352 CID		US723
1962-1964	V8-6.4L	390 CID		US723
1962-1963	V8-6.6L	406 CID		US723
1963-1964	V8-7.0L	427 CID		US723
<b>CONTOUR</b>				
1995-1997	L4-2.0L	121 CID	GL,GL Sport,LX,LX Sport,Sport,Base	US4088
1998-2000	L4-2.0L	121 CID		US4115
1995-2000	V6-2.5L	155 CID		US4091
<b>COUGAR (MEX)</b>				
1985-1987	L6-3.8L	232 CID	2BL	US4016
1988-1993	V6-3.8L	232 CID	2BL ;,FI	US4050
1994-1995	V6-3.8L	232 CID	FI	US4090
1996	V6-3.8L	232 CID	FI	US4103
1991-1994	V8-4.9L	299 CID	FI	US4057
<b>COUNTRY SEDAN</b>				
1960-1964	L6-2.4L	144 CID		US1044
1960-1969	L6-2.8L	170 CID		US1044
1963-1970	L6-3.3L	200 CID		US1044
1962-1963	V8-3.6L	221 CID		US819
1962-1965	V8-4.3L	260 CID		US819
1963-1967	V8-4.7L	289 CID		US819
1961-1964	V8-5.8L	352 CID		US723
1961-1964	V8-6.4L	390 CID		US723
1962-1963	V8-6.6L	406 CID		US723
1963-1964	V8-7.0L	427 CID		US723
<b>COUNTRY SQUIRE</b>				
1960-1964	L6-2.4L	144 CID		US1044
1960-1969	L6-2.8L	170 CID		US1044
1963-1970	L6-3.3L	200 CID		US1044
1962-1963	V8-3.6L	221 CID		US819
1962-1965	V8-4.3L	260 CID		US819
1963-1965	V8-4.7L	289 CID		US819
1987	V8-5.0L	302 CID	Base,LX	US4014
1988-1991	V8-5.0L	302 CID	From 06/88; Base,LX,Base	US4052
1988-1991	V8-5.0L	302 CID	From 06/88; High Performance; Base,LX	US4052H
1961-1964	V8-5.8L	352 CID		US723
1961-1964	V8-6.4L	390 CID		US723
1962-1963	V8-6.6L	406 CID		US723
1963-1964	V8-7.0L	427 CID		US723
<b>COURIER</b>				
1975-1979	L4-1.8L	110 CID		US1042
1979-1982	L4-2.0L	122 CID	Base,XLT	US1042
1977-1982	L4-2.3L	140 CID	Base,XLT	US4005
<b>COURIER (MEX)</b>				
2001-2009	L4-1.6L	97 CID	MFI	US8931
<b>CROWN VICTORIA</b>				
1992-1997	V8-4.6L	281 CID	Base,LX,S,Touring Sedan,Police Interceptor	US4066
1998-2002	V8-4.6L	281 CID	Base,LX,Police Interceptor,S,Exc. Police; Base,LWB	US4113
1999-2002	V8-4.6L	281 CID	Police; Base,LX,Police Interceptor,S,LWB	US4119
2001-2011	V8-4.6L	281 CID	Base,LX,Police Interceptor,S,LWB,LX Sport, Special Edition	US4128
<b>CUSTOM</b>				
1965	V8-4.7L	289 CID		US819
<b>CUSTOM 500</b>				
1964	V8-4.3L	260 CID		US819
1964-1968	V8-4.7L	289 CID		US819
1964	V8-5.8L	352 CID		US723
1975-1977	V8-5.8L	351 CID	Single tube outlet	US932
1976-1977	V8-5.8L	351 CID	Double tube outlet	US953
1976-1977	V8-5.8L	351 CID	High Performance	US953H
1964	V8-6.4L	390 CID		US723
1975-1977	V8-6.6L	400 CID	Single tube outlet	US932
1975-1976	V8-7.5L	460 CID		US1114
<b>E-100 ECONOLINE</b>				
1968-1971	L6-2.8L	170 CID		US1044





# WATER PUMP APPLICATION GUIDE



Years	Engine	Disp.	Application Description	USMW
1975-1982	L6-4.9L	300 CID	Base,Chateau,Custom	US4030N
1983	L6-4.9L	300 CID	Custom,XL	US4020
1975-1983	V8-5.0L	302 CID	Double tube outlet; Base,Chateau,Custom,XL	US953
1975-1983	V8-5.0L	302 CID	High Performance; Base,Chateau,Custom,XL	US953H
1975-1983	V8-5.8L	351 CID	Double tube outlet; Base,Chateau,Custom,XL	US953
1975-1983	V8-5.8L	351 CID	High Performance; Base,Chateau,Custom,XL	US953H
1980-1982	V8-5.8L	351 CID	Single tube outlet; Base,Chateau,Custom	US932
<b>E-100 ECONOLINE CLUB WAGON</b>				
1975-1982	L6-4.9L	300 CID	Base,Chateau,Custom	US4030N
1983	L6-4.9L	300 CID	Custom,XL	US4020
1979-1983	V8-5.0L	302 CID	Double tube outlet; Base,Chateau,Custom,XL	US953
1979-1983	V8-5.0L	302 CID	High Performance; Base,Chateau,Custom,XL	US953H
1975-1983	V8-5.8L	351 CID	Double tube outlet; Base,Chateau,Custom,XL	US953
1975-1983	V8-5.8L	351 CID	High Performance; Base,Chateau,Custom,XL	US953H
1980-1982	V8-5.8L	351 CID	Single tube outlet; Base,Chateau,Custom	US932
<b>E-150</b>				
2003	V6-4.2L	256 CID	Base	US4105
2003-2013	V8-4.6L	281 CID	Base,Chateau,XL,XLT	US4110
2007-2009	V8-4.6L	281 CID	From 10/16/06; Base,Chateau,XL,XLT,Base	US6144
2003-2013	V8-5.4L	330 CID	Base,Chateau,XL,XLT	US4110
<b>E-150 CLUB WAGON</b>				
2003	V6-4.2L	256 CID	Chateau,XL,XLT	US4105
2003-2005	V8-4.6L	281 CID	Chateau,XL,XLT	US4110
2003-2005	V8-5.4L	330 CID	Chateau,XL,XLT	US4110
<b>E-150 ECONOLINE</b>				
1975-1977	L6-4.9L	300 CID	Before S/N 080001	US4033
1975-1982	L6-4.9L	300 CID	From Engine #080001;,,Base,Chateau,Custom	US4030N
1983-1986	L6-4.9L	300 CID	Custom,XL,Base	US4020
1987-1991	L6-4.9L	300 CID	Custom,XL	US4048
1992	L6-4.9L	300 CID	Base,XL	US4079
1993-1994	L6-4.9L	300 CID	Base,XL	US4099
1995-1996	L6-4.9L	300 CID	Base,XL	US4096
1997-2002	V6-4.2L	256 CID	Base,XL	US4105
1997-2002	V8-4.6L	281 CID	Base,XL	US4122
1999-2002	V8-4.6L	281 CID	Base,XL	US4130
1975-1986	V8-5.0L	302 CID	Double tube outlet; Base,Chateau,Custom,XL	US953
1975-1986	V8-5.0L	302 CID	High Performance; Base,Chateau,Custom,XL	US953H
1987-1996	V8-5.0L	302 CID	Custom,XL,Base	US4044
1987-1996	V8-5.0L	302 CID	High Performance; Custom,XL,Base	US4044H
1997-2002	V8-5.4L	330 CID	Base,XL	US4122
2000-2002	V8-5.4L	330 CID	Base,XL	US4130
1975-1987	V8-5.8L	351 CID	Double tube outlet; Base,Chateau,Custom,XL	US953
1975-1987	V8-5.8L	351 CID	High Performance; Base,Chateau,Custom,XL	US953H
1980-1982	V8-5.8L	351 CID	Single tube outlet; Base,Chateau,Custom	US932
1988-1996	V8-5.8L	351 CID	Custom,XL,Base	US4044
1988-1996	V8-5.8L	351 CID	High Performance; Custom,XL,Base	US4044H
<b>E-150 ECONOLINE CLUB WAGON</b>				
1975-1977	L6-4.9L	300 CID	Before S/N 080001	US4033
1975-1982	L6-4.9L	300 CID	From Engine #080001;Base,Chateau,Custom	US4030N
1983-1986	L6-4.9L	300 CID	Custom,XL,Base,XLT	US4020
1987-1991	L6-4.9L	300 CID	Custom,XL,XLT	US4048
1992	L6-4.9L	300 CID	Chateau,Custom,XLT	US4079
1993-1994	L6-4.9L	300 CID	Chateau,Custom,XLT	US4099
1995-1996	L6-4.9L	300 CID	Chateau,Custom,XLT	US4096
1997-2002	V6-4.2L	256 CID	Chateau,Custom,XLT,XL	US4105
1997-2002	V8-4.6L	281 CID	Chateau,Custom,XLT,XL	US4122
1979-1986	V8-5.0L	302 CID	Double tube outlet; Base,Chateau,Custom,XL,XLT	US953
1979-1986	V8-5.0L	302 CID	High Performance; Base,Chateau,Custom,XL,XLT	US953H
1987-1996	V8-5.0L	302 CID	Custom,XL,XLT,Chateau	US4044
1987-1996	V8-5.0L	302 CID	High Performance; Custom,XL,XLT, Chateau	US4044H
1997-2002	V8-5.4L	330 CID	Chateau,Custom,XLT,XL	US4122
2000-2002	V8-5.4L	330 CID	Chateau,Custom,XLT,XL	US4130
1975-1987	V8-5.8L	351 CID	Double tube outlet; Base,Chateau,Custom,XL,XLT	US953
1975-1987	V8-5.8L	351 CID	High Performance; Base,Chateau,Custom,XL,XLT	US953H
1980-1982	V8-5.8L	351 CID	Single tube outlet; Base,Chateau,Custom	US932
1988-1996	V8-5.8L	351 CID	Custom,XL,XLT,Chateau	US4044
1988-1996	V8-5.8L	351 CID	High Performance; Custom,XL,XLT, Chateau	US4044H
<b>E-200 ECONOLINE</b>				
1968-1971	L6-2.8L	170 CID		US1044

Years	Engine	Disp.	Application Description	USMW
<b>E-250</b>				
2003	V6-4.2L	256 CID	Base	US4105
2003-2013	V8-4.6L	281 CID	Base	US4110
2007-2009	V8-4.6L	281 CID	From 10/16/06; Base,Base	US6144
2003-2013	V8-5.4L	330 CID	Base	US4110
<b>E-250 ECONOLINE</b>				
1975-1977	L6-4.9L	300 CID	Before S/N 080001	US4033
1975-1982	L6-4.9L	300 CID	From Engine #080001;Base,Chateau,Custom	US4030N
1983-1986	L6-4.9L	300 CID	Custom,XL,Base	US4020
1984	L6-4.9L	300 CID	Base,XL	US4083
1987-1991	L6-4.9L	300 CID	Custom,XL	US4048
1992	L6-4.9L	300 CID	Base,XL	US4079
1993-1996	L6-4.9L	300 CID	Base,XL	US4099
1997-2002	V6-4.2L	256 CID	Base,XL	US4105
1997	V8-4.6L	281 CID	Base,XL	US4122
1975-1986	V8-5.0L	302 CID	Double tube outlet; Base,Chateau,Custom,XL	US953
1975-1986	V8-5.0L	302 CID	High Performance; Base,Chateau,Custom,XL	US953H
1987-1991	V8-5.0L	302 CID	Custom,XL	US4044
1987-1991	V8-5.0L	302 CID	High Performance; Custom,XL	US4044H
1997-2002	V8-5.4L	330 CID	Base,XL	US4122
1997-2002	V8-5.4L	330 CID	Base,XL	US4130
1975-1987	V8-5.8L	351 CID	Double tube outlet; Base,Chateau,Custom,XL	US953
1975-1987	V8-5.0L	302 CID	High Performance; Base,Chateau,Custom,XL	US953H
1980-1982	V8-5.8L	351 CID	Single tube outlet; Base,Chateau,Custom	US932
1988-1996	V8-5.8L	351 CID	Custom,XL,Base	US4044
1988-1996	V8-5.8L	351 CID	High Performance; Custom,XL,Base	US4044H
1980	V8-6.6L	400 CID	Single tube outlet; Base,Chateau,Custom	US932
1975-1980	V8-7.5L	460 CID	Base,Chateau,Custom	US1114
<b>E-250 ECONOLINE CLUB WAGON</b>				
1977	L6-4.9L	300 CID	Before S/N 080001	US4033
1977-1980	L6-4.9L	300 CID	From Engine #080001;,,Base,Chateau,Custom	US4030N
1983-1986	L6-4.9L	300 CID	Custom,XL,Base,XLT	US4020
1984	L6-4.9L	300 CID	Base,XL,XLT	US4083
1987-1991	L6-4.9L	300 CID	Custom,XL,XLT	US4048
1979-1980	V8-5.0L	302 CID	Double tube outlet; Base,Chateau,Custom	US953
1979-1980	V8-5.0L	302 CID	High Performance; Base,Chateau,Custom	US953H
1975-1987	V8-5.8L	351 CID	Double tube outlet; Base,Chateau,Custom,XL,XLT	US953
1975-1987	V8-5.8L	351 CID	High Performance; Base,Chateau,Custom,XL,XLT	US953H
1980-1982	V8-5.8L	351 CID	Single tube outlet; Base,Chateau,Custom	US932
1988-1991	V8-5.8L	351 CID	Custom,XL,XLT	US4044
1988-1991	V8-5.8L	351 CID	High Performance; Custom,XL,XLT	US4044H
1980-1982	V8-6.6L	400 CID	Single tube outlet; Base,Chateau,Custom	US932
1983-1987	V8-6.9L	420 CID	Custom,XL,Base,XLT	US4018
1988-1991	V8-7.3L	445 CID	Custom,XL,XLT	US4018
1975-1991	V8-7.5L	460 CID	Carb; Base,Chateau,Custom,XL,XLT	US1114
1988-1989	V8-7.5L	460 CID	FI ; Custom,XL,XLT	US4081
<b>E-250 SUPER DUTY</b>				
2004-2005	V8-5.4L	330 CID	Base	US4110
<b>E-300 ECONOLINE</b>				
1969-1970	L6-2.8L	170 CID		US1044
<b>E-350</b>				
2003	V10-6.8L	415 CID	Base	US4109
2003	V8-5.4L	330 CID	Base	US4110
2003	V8-7.3L	445 CID	Base	US4114
<b>E-350 CLUB WAGON</b>				
2003-2005	V10-6.8L	415 CID	Chateau,XL,XLT	US4109
2003-2005	V8-5.4L	330 CID	Chateau,XL,XLT	US4110
2004-2005	V8-6.0L	363 CID	Chateau,XL,XLT	US67
2003	V8-7.3L	445 CID	Chateau,XL,XLT	US4114
<b>E-350 ECONOLINE</b>				
1975-1977	L6-4.9L	300 CID	Before S/N 080001	US4033
1975-1982	L6-4.9L	300 CID	From Engine #080001;Base,Chateau,Custom	US4030N
1983-1986	L6-4.9L	300 CID	Custom,XL,Base	US4020
1984	L6-4.9L	300 CID	Base,XL	US4083
1987-1991	L6-4.9L	300 CID	Custom,XL	US4048
1992	L6-4.9L	300 CID	Base,XL	US4079
1993-1994	L6-4.9L	300 CID	Base,XL	US4099
1995-1996	L6-4.9L	300 CID	Base,XL	US4096

Years	Engine	Disp.	Application Description	USMW
1997-2002	V10-6.8L	415 CID	Base,XL	US4109
1975-1979	V8-5.0L	302 CID	Double tube outlet	US953
1975-1979	V8-5.0L	302 CID	High Performance	US953H
1997-2002	V8-5.4L	330 CID	Base,XL	US4122
1997-2002	V8-5.4L	330 CID	Base,XL	US4130
1975-1987	V8-5.8L	351 CID	Double tube outlet; Base,Chateau, Custom,XL	US953
1975-1987	V8-5.8L	351 CID	High Performance; Base,Chateau,Custom,XL	US953H
1980-1982	V8-5.8L	351 CID	Single tube outlet; Base,Chateau,Custom	US932
1988-1996	V8-5.8L	351 CID	Custom,XL,Base	US4044
1988-1996	V8-5.8L	351 CID	High Performance; Custom,XL, Base	US4044H
1980-1982	V8-6.6L	400 CID	Single tube outlet; Base,Chateau,Custom	US932
1983-1987	V8-6.9L	420 CID	Custom,XL,Base	US4018
1988-1994	V8-7.3L	445 CID	Custom,XL,Base	US4018
1995	V8-7.3L	445 CID	Base,XL	US4096
1996-2002	V8-7.3L	445 CID	Base,XL	US4114
1975-1991	V8-7.5L	460 CID	Base,Chateau,Custom,XL	US1114
1987-1989	V8-7.5L	460 CID	Custom,XL	US4081
1992-1994	V8-7.5L	460 CID	From 02/03/92; Base,XL,Base	US4077
1995-1996	V8-7.5L	460 CID	Base,XL	US4086
<b>E-350 ECONOLINE CLUB WAGON</b>				
1977	L6-4.9L	300 CID	Before S/N 080001	US4033
1977-1982	L6-4.9L	300 CID	From Engine #080001,,;Base,Chateau,Custom	US4030N
1983-1986	L6-4.9L	300 CID	Custom,XL,Base,XLT	US4020
1984	L6-4.9L	300 CID	Base,XL,XLT	US4083
1987-1991	L6-4.9L	300 CID	Custom,XL,XLT	US4048
1992	L6-4.9L	300 CID	Chateau,Chateau HD,Custom,Custom HD,XLT, XLT HD	US4079
1993-1994	L6-4.9L	300 CID	Chateau,Chateau HD,Custom,Custom HD,XLT, XLT HD,XL HD	US4099
1995-1996	L6-4.9L	300 CID	Chateau,Chateau HD,Custom,XL HD,XLT,XLT HD	US4096
1997-2002	V10-6.8L	415 CID	Chateau,Custom,XL HD,XLT,XLT HD,XL	US4109
1979	V8-5.0L	302 CID	High Performance;;	US953H
1997-2002	V8-5.4L	330 CID	Chateau,Custom,XL HD,XLT,XLT HD,XL	US4122
1997-2002	V8-5.4L	330 CID	Chateau,Custom,XLT,XL	US4130
1977-1987	V8-5.8L	351 CID	Double tube outlet; Base,Chateau,Custom,XL,XLT	US953
1977-1987	V8-5.8L	351 CID	High Performance; Base,Chateau, Custom,XL,XLT	US953H
1980-1982	V8-5.8L	351 CID	Single tube outlet; Base,Chateau,Custom	US932
1988-1996	V8-5.8L	351 CID	Custom,XL,XLT,Chateau,Chateau HD,Custom HD, XLT HD,XL HD	US4044
1988-1996	V8-5.8L	351 CID	High Performance; Custom,XL,XLT,High Performance; Chateau,Chateau HD,Custom,Custom HD, XLT HD,XL HD	US4044H
1980-1982	V8-6.6L	400 CID	Single tube outlet; Base,Chateau,Custom	US932
1983-1987	V8-6.9L	420 CID	Custom,XL,Base,XLT	US4018
1988-1994	V8-7.3L	445 CID	Custom,XL,XLT,Chateau,Chateau HD,Custom HD, XLT HD,XL HD	US4018
1995	V8-7.3L	445 CID	Chateau,Chateau HD,Custom,XL HD,XLT,XLT HD	US4096
1996-2002	V8-7.3L	445 CID	Chateau,Chateau HD,Custom,XL HD,XLT,XLT HD,XL	US4114
1977-1991	V8-7.5L	460 CID	Base,Chateau,Custom,XL,XLT	US1114
1988-1989	V8-7.5L	460 CID	Custom,XL,XLT	US4081
1992-1994	V8-7.5L	460 CID	From 02/03/92; Chateau,Chateau HD,Custom, Custom HD,XLT,XLT HD,Chateau,XL HD	US4077
1995-1996	V8-7.5L	460 CID	Chateau,Chateau HD,Custom,XL HD,XLT,XLT HD	US4086
<b>E-350 SUPER DUTY</b>				
2004-2009	V10-6.8L	415 CID	Base,XL,XLT	US4109
2010-2012	V10-6.8L	415 CID	Base,XL,XLT	US6144
2004-2013	V8-5.4L	330 CID	Base,XL,XLT	US4110
2004-2010	V8-6.0L	363 CID	Base,XL,XLT	US67
<b>E-450 ECONOLINE SUPER DUTY</b>				
2000-2002	V10-6.8L	415 CID	Custom	US4109
2000-2002	V8-5.4L	330 CID	Custom	US4130
2000-2002	V8-7.3L	445 CID	Custom	US4114
<b>E-450 ECONOLINE SUPER DUTY STRIPPED</b>				
2000-2002	V10-6.8L	415 CID	Custom	US4109
2000-2002	V8-5.4L	330 CID	Custom	US4110
2000-2002	V8-5.4L	330 CID	Custom	US4130
2000-2002	V8-7.3L	445 CID	Custom	US4114
<b>E-450 SUPER DUTY</b>				
2003-2009	V10-6.8L	415 CID	Custom,Base	US4109

Years	Engine	Disp.	Application Description	USMW
2010-2012	V10-6.8L	415 CID	Base	US6144
2003-2013	V8-5.4L	330 CID	Custom,Base	US4110
2004-2008	V8-6.0L	363 CID	Base	US67
2003	V8-7.3L	445 CID	Custom	US4114
<b>E-450 SUPER DUTY STRIPPED CHASSIS</b>				
2003	V10-6.8L	415 CID	Custom	US4109
2003	V8-5.4L	330 CID	Custom	US4110
2003	V8-7.3L	445 CID	Custom	US4114
<b>E-550 ECONOLINE SUPER DUTY</b>				
2002	V10-6.8L	415 CID	Custom	US4109
2002	V8-7.3L	445 CID	Custom	US4114
<b>E-550 SUPER DUTY</b>				
2003	V10-6.8L	415 CID	Custom	US4109
2003	V8-7.3L	445 CID	Custom	US4114
<b>ECONOLINE</b>				
1961-1965	L6-2.4L	144 CID		US1044
1962-1966	L6-2.8L	170 CID		US1044
<b>ECONOLINE SUPER DUTY</b>				
1997-1999	V10-6.8L	415 CID	Custom	US4109
1997-1999	V8-5.4L	330 CID	Custom	US4122
1996	V8-5.8L	351 CID	High Performance; Custom,Custom	US4044H
1996-1999	V8-7.3L	445 CID	Custom	US4114
1996	V8-7.5L	460 CID	Custom	US4086
<b>ECONOLINE WAGON (MEX)</b>				
1999-2002	V6-4.2L	256 CID	FI	US4105
1999-2002	V8-5.0L	305 CID	FI	US4044
1999-2002	V8-5.0L	305 CID	FI High Performance	US4044H
<b>ECOSPORT (MEX)</b>				
2004	L4-2.0L	121 CID	SFI	US4115
2005-2009	L4-2.0L	121 CID	SFI	US4126
<b>EDGE</b>				
2007-2010	V6-3.5L	213 CID	SE,SEL,Limited,Sport	US6023
2011-2012	V6-3.5L	213 CID	Limited,SE,SEL,To 01/02/12; Limited	US8980
2011-2012	V6-3.7L	227 CID	Sport,To 01/02/12; Sport	US8980
<b>ELITE</b>				
1975	V8-5.8L	351 CID	High Performance;;	US953H
1975-1976	V8-5.8L	351 CID	Single tube outlet	US932
1975-1976	V8-6.6L	400 CID	Single tube outlet	US932
1975-1976	V8-7.5L	460 CID		US1114
<b>ESCAPE</b>				
2001-2004	L4-2.0L	121 CID		US4115
2005-2008	L4-2.3L	140 CID	Hybrid,XLS,XLT,XLT No Boundaries	US4126
2009-2012	L4-2.5L	152 CID	Hybrid,Limited Hybrid,XLS,XLT,Limited	US4126
2001-2002	V6-3.0L	182 CID		US4091
2003-2005	V6-3.0L	182 CID	From 04/01/03,,;Limited,XLS,XLT,XLT No Boundaries, XLT Sport	US4132
2006	V6-3.0L	183 CID	Limited,XLT	US4132
2006-2008	V6-3.0L	183 CID	From 01/30/06; Limited,XLT,Limited	US9489
2009-2012	V6-3.0L	183 CID	Limited,XLT	US6250
<b>ESCORT</b>				
1991-1993	L4-1.4L	1391cc		US8905
1981-1985	L4-1.6L	98 CID	Base,GL,GLXL,SS,GT,LX,GT Turbo	US4040
1991-1993	L4-1.6L	1598cc		US8905
1991-1996	L4-1.8L	112 CID	From 04/91; Base,LX,LX Sport,Base,Sport	US4069
1991-1996	L4-1.8L	112 CID	GT,LX-E	US4068
1985-1990	L4-1.9L	116 CID	Base,GL,GT,GT Turbo,LX,Pony,LX Sport	US4040
1991	L4-1.9L	116 CID	To 04/91; Base,LX,LX Sport	US4065
1984-1987	L4-2.0L	122 CID	Base,GL,LX,L	US9067
1997-2002	L4-2.0L	121 CID	Base,LX,Sport,VIN P; LX,SE	US4107
1998-2003	L4-2.0L	121 CID		US4115
<b>EXCURSION</b>				
2000-2005	V10-6.8L	415 CID	Limited,XLT,Eddie Bauer,XLS	US4109
2000-2002	V8-5.4L	330 CID	Limited,XLT,Eddie Bauer	US4122
2003-2005	V8-5.4L	330 CID	Eddie Bauer,Limited,XLT,XLS	US4110
2003-2005	V8-6.0L	363 CID	Eddie Bauer,Limited,XLT,XLS	US61
2000-2003	V8-7.3L	445 CID	Limited,XLT,Eddie Bauer	US4114
<b>EXP</b>				
1982-1985	L4-1.6L	98 CID	Base,GT,HO,Luxury,Turbo	US4040

Years	Engine	Disp.	Application Description	USMW
1986-1988	L4-1.9L	116 CID	Luxury,Sport,Base	<b>US4040</b>
<b>EXPEDITION</b>				
1997-2002	V8-4.6L	281 CID	Eddie Bauer,XLT	<b>US4122</b>
2003-2004	V8-4.6L	281 CID	Eddie Bauer,XLT,NBX,XLS,XLT Sport	<b>US4110</b>
1997-2002	V8-5.4L	330 CID	Eddie Bauer,XLT	<b>US4122</b>
2001-2002	V8-5.4L	330 CID	Eddie Bauer,XLT	<b>US4130</b>
2003-2009	V8-5.4L	330 CID	Eddie Bauer,XLT,NBX,XLS,XLT Sport,King Ranch, Limited,EL Eddie Bauer,EL Limited,EL XLT,ELing Ranch, Max Eddie Bauer,Max Limited,Maxing Ranch	<b>US4110</b>
2007-2008	V8-5.4L	330 CID	Eddie Bauer,EL Eddie Bauer,EL Limited,EL XLT,Limited, XLT,ELing Ranch,Funkmaster Flex Edition,King Ranch	<b>US6144</b>
<b>EXPEDITION (MEX)</b>				
1996	V8-4.6L	281 CID	MFI SOHC	<b>US4122</b>
<b>EXPLORER</b>				
2011-2012	V6-3.5L	213 CID	Base,Limited,XLT,To 01/02/12; Base	<b>US8980</b>
1991-2000	V6-4.0L	245 CID	Eddie Bauer,Sport,XL,XLT,Limited,Expedition,XLS, Postal,XL Fleet	<b>US4060</b>
1997-2010	V6-4.0L	245 CID	Eddie Bauer,Limited,Sport,XL,XLT,XLS,Postal,XL Fleet, Sport XLS,Sport XLT,NBX,XLS Sport,XLT Sport	<b>US4108</b>
2002-2010	V8-4.6L	281 CID	Eddie Bauer,Limited,XLT,NBX,XLT Sport	<b>US4127</b>
1996-2001	V8-5.0L	302 CID	Eddie Bauer,Limited,XLT,XLS	<b>US4101</b>
<b>EXPLORER (MEX)</b>				
1998	L6-4.8L	294 CID	FI SOHC ; 2WD	<b>US4101</b>
1990	V6-4.0L	245 CID	MFI ; 2WD	<b>US4060</b>
<b>EXPLORER SPORT TRAC</b>				
2001-2010	V6-4.0L	245 CID	Base,XL,XLS,XLT,Adrenalin,Limited	<b>US4108</b>
2007-2010	V8-4.6L	281 CID	Limited,XLT	<b>US4127</b>
<b>EXPLORER SPORT TRAC (MEX)</b>				
2010	V8-4.6L	281 CID	SFI SOHC ; 2WD	<b>US4127</b>
<b>F SUPER DUTY</b>				
1990-1994	V8-7.3L	445 CID	Custom,XL	<b>US4018</b>
1995	V8-7.3L	445 CID	XL	<b>US4096</b>
1996-1997	V8-7.3L	445 CID	XL,Base	<b>US4114</b>
1990-1991	V8-7.5L	460 CID	Custom	<b>US1114</b>
1992-1994	V8-7.5L	460 CID	From 02/03/92; Custom,Custom,XL	<b>US4077</b>
1995-1997	V8-7.5L	460 CID	XL,Base	<b>US4086</b>
<b>F-100</b>				
1975-1982	L6-4.9L	300 CID	Custom,Ranger,Ranger Lariat,Ranger XLT,XL,XLS,XLT Lariat	<b>US4030N</b>
1983	L6-4.9L	300 CID	Base,XL,XLS,XLT Lariat	<b>US4020</b>
1982-1983	V6-3.8L	232 CID	Custom,XL,XLS,XLT Lariat,Base	<b>US4016</b>
1981-1982	V8-4.2L	255 CID	Double tube outlet; Custom,Ranger,Ranger Lariat, Ranger XLT,XL,XLS,XLT Lariat	<b>US953</b>
1981-1982	V8-4.2L	255 CID	High Performance; Custom,Ranger,Ranger Lariat, Ranger XLT,XL,XLS,XLT Lariat	<b>US953H</b>
1965	V8-4.7L	289 CID	4BL ; 1/2 Ton	<b>US819</b>
1975-1983	V8-5.0L	302 CID	Double tube outlet; Custom,Ranger,Ranger Lariat, Ranger XLT,XL,XLS,XLT Lariat, Double tube outlet; Base	<b>US953</b>
1975-1983	V8-5.0L	302 CID	High Performance; Custom,Ranger,Ranger Lariat, Ranger XLT,XL,XLS,XLT Lariat,High Performance; Base	<b>US953H</b>
1977-1981	V8-5.8L	351 CID	Double tube outlet; Custom,Ranger,Ranger Lariat, Ranger XLT	<b>US953</b>
1977-1981	V8-5.8L	351 CID	High Performance; Custom,Ranger,Ranger Lariat, Ranger XLT	<b>US953H</b>
1977-1981	V8-5.8L	351 CID	Single tube outlet;Single tube outlet; Custom, Ranger,Ranger Lariat,Ranger XLT	<b>US932</b>
1975-1976	V8-5.9L	360 CID		<b>US1075</b>
1975-1976	V8-5.9L	360 CID	High Performance	<b>US1075H</b>
1975-1976	V8-6.4L	390 CID		<b>US1075</b>
1975-1976	V8-6.4L	390 CID	High Performance	<b>US1075H</b>
1977-1979	V8-6.6L	400 CID	Single tube outlet	<b>US932</b>
1975-1979	V8-7.5L	460 CID		<b>US1114</b>
<b>F-100 (MEX)</b>				
1965-1978	V8-4.7L	289 CID	2BL ; 1/2 Ton,1/2 Ton 4WD,1/2 Ton	<b>US1028</b>
1965-1978	V8-4.7L	289 CID	2BL High Performance ; 1/2 Ton,1/2 Ton 4WD,1/2 Ton	<b>US1028H</b>
1969-1978	V8-4.7L	289 CID	4BL High Performance ; 1/2 Ton, 2BL High Performance ; 1/2 Ton	<b>US953H</b>

Years	Engine	Disp.	Application Description	USMW
1969-1978	V8-4.7L	289 CID	4BL; Double tube outlet; 1/2 Ton, 2BL; Double tube outlet; 1/2 Ton	<b>US953</b>
<b>F-101</b>				
1966	V8-4.7L	289 CID	4BL ; 1/2 Ton	<b>US819</b>
<b>F-102</b>				
1965	V8-4.7L	289 CID	4BL ; 1/2 Ton 4WD	<b>US819</b>
<b>F-103</b>				
1966	V8-4.7L	289 CID	4BL ; 1/2 Ton 4WD	<b>US819</b>
<b>F-150</b>				
1975-1977	L6-4.9L	300 CID	Before S/N 080001	<b>US4033</b>
1975-1982	L6-4.9L	300 CID	From Engine #080001;,,Custom,Ranger ,Ranger Lariat,Ranger XLT,XL,XLS,XLT Lariat	<b>US4030N</b>
1983-1986	L6-4.9L	300 CID	Base,XL,XLS,XLT,XLT Lariat	<b>US4020</b>
1987-1992	L6-4.9L	300 CID	Custom,XL,XLT Lariat	<b>US4048</b>
1993-1996	L6-4.9L	300 CID	XL,XLT,Eddie Bauer,Special	<b>US4099</b>
1997-2008	V6-4.2L	256 CID	Base,XL,XLT,STX	<b>US4105</b>
1997-2002	V8-4.6L	281 CID	Base,Lariat,XL,XLT,King Ranch	<b>US4122</b>
1999-2000	V8-4.6L	281 CID	Lightning	<b>US4121</b>
2003-2010	V8-4.6L	281 CID	King Ranch,Lariat,XL,XLT,STX,FX2	<b>US4110</b>
2007-2008	V8-4.6L	281 CID	STX,XL,XLT,FX2	<b>US6144</b>
2009	V8-4.6L	281 CID	STX,XL,XLT	<b>US4127</b>
1975-1986	V8-5.0L	302 CID	Double tube outlet; Custom,Ranger,Ranger Lariat, Ranger XLT,XL,XLS,XLT Lariat, Double tube outlet; Base,XLT	<b>US953</b>
1975-1986	V8-5.0L	302 CID	High Performance; Custom,Ranger,Ranger Lariat, Ranger XLT,XL,XLS,XLT Lariat, High Performance; Base,XLT	<b>US953H</b>
1987-1996	V8-5.0L	302 CID	Custom,XL,XLT Lariat,XLT,Eddie Bauer,Special	<b>US4044</b>
1987-1996	V8-5.0L	302 CID	High Performance; Custom,XL,XLT Lariat High Performance; XL,XLT, High Performance; Eddie Bauer,Special, High Performance; Stamped #E9TE8505-A4A,A5A,F5TE8505-C4A;	<b>US4044H</b>
2011-2013	V8-5.0L	302 CID		<b>US8963</b>
1997-2002	V8-5.4L	330 CID	Base,Lariat,XL,XLT,Lightning,Harley-Davidson Edition, King Ranch	<b>US4122</b>
2001-2004	V8-5.4L	330 CID	Harley-Davidson Edition,Lightning,	<b>US4125</b>
2003-2006	V8-5.4L	330 CID	Harley-Davidson Edition,King Ranch,Lariat,Lightning, XL,XLT,FX4	<b>US4110</b>
2006-2009	V8-5.4L	330 CID	FX4,Harley-Davidson Edition,King Ranch,Lariat, XL,XLT,FX2,Limited,Platinum	<b>US6144</b>
1977-1979	V8-5.8L	351 CID	Single tube outlet	<b>US932</b>
1977-1987	V8-5.8L	351 CID	Double tube outlet; Custom,Ranger,Ranger Lariat, Ranger XLT,XL,XLS,XLT Lariat, Double tube outlet; Base,XLT	<b>US953</b>
1977-1987	V8-5.8L	351 CID	High Performance; Custom,Ranger,Ranger Lariat, Ranger XLT,XL,XLS,XLT Lariat, High Performance; Base,XLT	<b>US953H</b>
1988-1996	V8-5.8L	351 CID	Custom,XL,XLT Lariat,Lightning,XLT,Eddie Bauer Special	<b>US4044</b>
1988-1996	V8-5.8L	351 CID	High Performance; Custom,XL,XLT Lariat, High Performance; Lightning,XLT, High Performance; Eddie Bauer,Lightning,Special	<b>US4044H</b>
1975-1976	V8-5.9L	360 CID		<b>US1075</b>
1975-1976	V8-5.9L	360 CID	High Performance	<b>US1075H</b>
2010-2013	V8-6.2L	379 CID		<b>US6006</b>
1975-1976	V8-6.4L	390 CID		<b>US1075</b>
1975-1976	V8-6.4L	390 CID	High Performance	<b>US1075H</b>
1977-1979	V8-6.6L	400 CID	Single tube outlet	<b>US932</b>
1975-1979	V8-7.5L	460 CID		<b>US1114</b>
<b>F-150 (MEX)</b>				
1984-1990	L6-3.8L	232 CID	2BL ; 1/2 Ton	<b>US4016</b>
1997	L6-4.9L	300 CID	FI ; 1/2 Ton,1/2 Ton 4WD	<b>US4099</b>
1991-1993	V6-3.8L	232 CID	FI ; 1/2 Ton,1/2 Ton 4WD	<b>US4051</b>
1994-1995	V6-3.8L	232 CID	FI ; 1/2 Ton,1/2 Ton 4WD	<b>US4089</b>
2009	V6-4.2L	256 CID	SFI OHV ; 1/2 Ton	<b>US4102</b>
1979	V8-4.7L	289 CID	2BL High Performance ; 1/2 Ton,1/2 Ton 4WD,1/2 Ton	<b>US953H</b>
1986	V8-5.0L	302 CID	2BL High Performance ; 1/2 Ton,1/2 Ton	<b>US953H</b>
1986-1990	V8-5.0L	302 CID	2BL ; 1/2 Ton 4WD,2BL ; 1/2 Ton,1/2 Ton 4WD	<b>US4044</b>



Years	Engine	Disp.	Application Description	USMW
1986-1990	V8-5.0L	302 CID	2BL High Performance ; 1/2 Ton 4WD 2BL High Performance ; 1/2 Ton, 1/2 Ton 4WD	<b>US4044H</b>
1986-1987	V8-5.8L	351 CID	2BL High Performance ; 3/4 Ton	<b>US953H</b>
1986-1987	V8-5.8L	351 CID	2BL; Double tube outlet; 3/4 Ton	<b>US953</b>
<b>F-150 HERITAGE</b>				
2004	V6-4.2L	256 CID	XL,XLT	<b>US4105</b>
2004	V8-4.6L	281 CID	XL,XLT	<b>US4110</b>
2004	V8-5.4L	330 CID	XL,XLT,SVT Lightning	<b>US4125</b>
<b>F-200 (MEX)</b>				
1986-1990	V8-5.0L	302 CID	2BL ; 3/4 Ton,3/4 Ton 4WD	<b>US4044</b>
1986-1990	V8-5.0L	302 CID	2BL High Performance ; 3/4 Ton,3/4 Ton 4WD	<b>US4044H</b>
1986-1990	V8-5.8L	351 CID	2BL ; 3/4 Ton 4WD,2BL ; 3/4 Ton,3/4 Ton 4WD	<b>US4044</b>
1986-1990	V8-5.8L	351 CID	2BL High Performance ; 3/4 Ton 4WD, 2BL High Performance ; 3/4 Ton,3/4 Ton 4WD	<b>US4044H</b>
<b>F-250</b>				
1975-1977	L6-4.9L	300 CID	Before S/N 080001	<b>US4033</b>
1975-1982	L6-4.9L	300 CID	From Engine #080001;,, Custom,Ranger,Ranger Lariat, Ranger XLT,XL,XLS,XLT Lariat	<b>US4030N</b>
1983-1986	L6-4.9L	300 CID	Base,XL,XLS,XLT,XLT Lariat	<b>US4020</b>
1987-1992	L6-4.9L	300 CID	Custom,XL,XLT Lariat	<b>US4048</b>
1993-1996	L6-4.9L	300 CID	XL,XLT,Eddie Bauer,Special	<b>US4099</b>
1995	L6-4.9L	300 CID	Eddie Bauer,Special,XL,XLT	<b>US4096</b>
1997-1999	V8-4.6L	281 CID	Base,Lariat,Lobo,XL,XLT	<b>US4122</b>
1975-1986	V8-5.0L	302 CID	Double tube outlet; Custom,Ranger,Ranger Lariat, Ranger XLT,XL,XLS,XLT Lariat, Double tube outlet; Base,XLT	<b>US953</b>
1975-1986	V8-5.0L	302 CID	High Performance; Custom,Ranger,Ranger Lariat, Ranger XLT,XL,XLS,XLT Lariat, High Performance; Base,XLT	<b>US953H</b>
1987-1996	V8-5.0L	302 CID	Custom,XL,XLT Lariat,XLT,Eddie Bauer,Special	<b>US4044</b>
1987-1996	V8-5.0L	302 CID	High Performance; Custom,XL,XLT Lariat, High Performance; XL,XLT, High Performance; Eddie Bauer,Special	<b>US4044H</b>
1997-1999	V8-5.4L	330 CID	Base,Lariat,XL,XLT	<b>US4122</b>
1977-1979	V8-5.8L	351 CID	Single tube outlet	<b>US932</b>
1977-1987	V8-5.8L	351 CID	Double tube outlet; Custom,Ranger,Ranger Lariat, Ranger XLT,XL,XLS,XLT Lariat Double tube outlet; Base,XLT	<b>US953</b>
1977-1987	V8-5.8L	351 CID	High Performance; Custom,Ranger,Ranger Lariat, Ranger XLT,XL,XLS,XLT Lariat, High Performance; Base,XLT	<b>US953H</b>
1988-1997	V8-5.8L	351 CID	Custom,XL,XLT Lariat,XLT,Eddie Bauer,Special,Base, Lariat	<b>US4044</b>
1988-1997	V8-5.8L	351 CID	High Performance; Custom,XL,XLT Lariat, High Performance; XL,XLT, High Performance; Eddie Bauer,Special, High Performance; Base,Lariat	<b>US4044H</b>
1975-1976	V8-5.9L	360 CID		<b>US1075</b>
1975-1976	V8-5.9L	360 CID	High Performance	<b>US1075H</b>
1975-1976	V8-6.4L	390 CID		<b>US1075</b>
1975-1976	V8-6.4L	390 CID	High Performance	<b>US1075H</b>
1977-1982	V8-6.6L	400 CID	Single tube outlet;Single tube outlet; Custom, Ranger,Ranger Lariat,Ranger XLT,XL,XLS,XLT Lariat	<b>US932</b>
1983-1987	V8-6.9L	420 CID	Base,XL,XLS,XLT,XLT Lariat,Custom	<b>US4018</b>
1988-1993	V8-7.3L	445 CID	Custom,XL,XLT Lariat,XLT	<b>US4018</b>
1994-1995	V8-7.3L	445 CID	XL,XLT,Eddie Bauer,Special	<b>US4096</b>
1996-1997	V8-7.3L	445 CID	Eddie Bauer,Special,XL,XLT,Base,Lariat	<b>US4114</b>
1975-1991	V8-7.5L	460 CID	Base,XL,XLS,XLT,XLT Lariat,Custom	<b>US1114</b>
1988-1989	V8-7.5L	460 CID	Custom,XL,XLT Lariat	<b>US4081</b>
1992-1994	V8-7.5L	460 CID	From 02/03/92; Custom,XL,XLT Lariat,Custom,XLT	<b>US4077</b>
1995-1997	V8-7.5L	460 CID	Eddie Bauer,Special,XL,XLT,Base,Lariat	<b>US4086</b>
<b>F-250 (MEX)</b>				
2000-2009	V8-4.6L	281 CID	MFI SOHC ; 3/4 Ton,3/4 Ton 4WD	<b>US4122</b>
1997	V8-5.0L	302 CID	FI High Performance ; 3/4 Ton,3/4 Ton 4WD,3/4 Ton	<b>US4044H</b>
<b>F-250 SUPER DUTY</b>				
1999-2009	V10-6.8L	415 CID	Lariat,XL,XLT,Harley-Davidson Edition,King Ranch,FX4	<b>US4109</b>
2010	V10-6.8L	415 CID	Cabela's,King Ranch,Lariat,XL,XLT	<b>US6144</b>
1999-2002	V8-5.4L	330 CID	Lariat,XL,XLT	<b>US4122</b>
2000-2002	V8-5.4L	330 CID	Lariat,XL,XLT	<b>US4130</b>

Years	Engine	Disp.	Application Description	USMW
2003-2010	V8-5.4L	330 CID		<b>US4110</b>
2003	V8-6.0L	363 CID	Lariat,XL,XLT	<b>US61</b>
2004-2007	V8-6.0L	363 CID	Harley-Davidson Edition,King Ranch,Lariat,XL,XLT,FX4	<b>US67</b>
2011-2013	V8-6.2L	379 CID		<b>US6006</b>
2008-2010	V8-6.4L	391 CID	FX4,Harley-Davidson Edition,King Ranch,Lariat,XL,XLT, Cabela's	<b>US76</b>
2011-2012	V8-6.7L	406 CID	King Ranch,Lariat,XL,XLT	<b>US77</b>
1999-2003	V8-7.3L	445 CID	Lariat,XL,XLT	<b>US4114</b>
<b>F-350</b>				
1975-1977	L6-4.9L	300 CID	Before S/N 080001	<b>US4033</b>
1975-1982	L6-4.9L	300 CID	From Engine #080001;,, Custom,Ranger,Ranger Lariat, Ranger XLT,XL,XLS,XLT Lariat	<b>US4030N</b>
1983-1986	L6-4.9L	300 CID	Base,XL,XLS,XLT,XLT Lariat	<b>US4020</b>
1987-1991	L6-4.9L	300 CID	Custom,XL,XLT Lariat	<b>US4048</b>
1993-1994	L6-4.9L	300 CID	XL,XLT	<b>US4099</b>
1965	V8-4.7L	289 CID	4BL ; 1 Ton	<b>US819</b>
1980	V8-5.0L	302 CID	High Performance; Custom,Ranger,Ranger Lariat Ranger XLT,Custom	<b>US953H</b>
1977-1979	V8-5.8L	351 CID	Single tube outlet	<b>US932</b>
1980-1987	V8-5.8L	351 CID	Double tube outlet; Custom,Ranger,Ranger Lariat, Ranger XLT,XL,XLS,XLT Lariat, Double tube outlet; Base,XLT	<b>US953</b>
1980-1987	V8-5.8L	351 CID	High Performance; Custom,Ranger,Ranger Lariat, Ranger XLT,XL,XLS,XLT Lariat, High Performance; Base,XLT	<b>US953H</b>
1988-1997	V8-5.8L	351 CID	Custom,XL,XLT Lariat,XLT,Eddie Bauer,Special, Base,Lariat	<b>US4044</b>
1988-1997	V8-5.8L	351 CID	High Performance; Custom,XL,XLT Lariat, High Performance; XL,XLT, High Performance; Eddie Bauer,Special, High Performance; Base,Lariat	<b>US4044H</b>
1975-1976	V8-5.9L	360 CID		<b>US1075</b>
1975-1976	V8-5.9L	360 CID	High Performance	<b>US1075H</b>
1975-1976	V8-6.4L	390 CID		<b>US1075</b>
1975-1976	V8-6.4L	390 CID	High Performance	<b>US1075H</b>
1977-1982	V8-6.6L	400 CID	Single tube outlet;Single tube outlet; Custom, Ranger,Ranger Lariat,Ranger XLT,XL,XLS,XLT Lariat	<b>US932</b>
1983-1987	V8-6.9L	420 CID	Base,XL,XLS,XLT,XLT Lariat,Custom	<b>US4018</b>
1988-1993	V8-7.3L	445 CID	Custom,XL,XLT Lariat,XLT	<b>US4018</b>
1994-1995	V8-7.3L	445 CID	XL,XLT,Eddie Bauer,Special	<b>US4096</b>
1996-1997	V8-7.3L	445 CID	Eddie Bauer,Special,XL,XLT,Base,Lariat	<b>US4114</b>
1975-1991	V8-7.5L	460 CID	Base,XL,XLS,XLT,XLT Lariat,Custom	<b>US1114</b>
1988-1989	V8-7.5L	460 CID	Custom,XL,XLT Lariat	<b>US4081</b>
1992-1994	V8-7.5L	460 CID	From 02/03/92; Custom,XL,XLT Lariat,Custom,XLT	<b>US4077</b>
1995-1997	V8-7.5L	460 CID	Eddie Bauer,Special,XL,XLT,Base,Lariat	<b>US4086</b>
<b>F-350 (MEX)</b>				
1965-1974	V8-4.7L	289 CID	2BL ; 1 Ton,1 Ton	<b>US1028</b>
1965-1974	V8-4.7L	289 CID	2BL High Performance ; 1 Ton,1 Ton	<b>US1028H</b>
1967-1968	V8-5.0L	302 CID	4BL ; 1 Ton	<b>US1028</b>
1967-1968	V8-5.0L	302 CID	4BL High Performance ; 1 Ton	<b>US1028H</b>
<b>F-350 (MEX)</b>				
1969-1977	V8-4.7L	289 CID	4BL High Performance ; 1 Ton, 2BL High Performance ; 1 Ton	<b>US953H</b>
1969-1977	V8-4.7L	289 CID	4BL; Double tube outlet; 1 Ton, 2BL; Double tube outlet; 1 Ton	<b>US953</b>
1965-1967	V8-5.0L	302 CID	2BL ; 1 Ton	<b>US1075</b>
1968-1987	V8-5.0L	302 CID	2BL High Performance ; 1 Ton, 4BL High Performance ; 1 Ton,1 Ton	<b>US953H</b>
1968-1987	V8-5.0L	302 CID	2BL; Double tube outlet; 1 Ton, 4BL; Double tube outlet; 1 Ton,1 Ton	<b>US953</b>
1987-1997	V8-5.0L	302 CID	2BL ; 1 Ton,1 Ton 4WD,FI ; 1 Ton	<b>US4044</b>
1987-1997	V8-5.0L	302 CID	2BL High Performance ; 1 Ton,1 Ton 4WD,FI High Performance ; 1 Ton	<b>US4044H</b>
1999	V8-5.4L	330 CID	FI SOHC ; 1 Ton	<b>US4122</b>
2000	V8-5.4L	330 CID	FI SOHC ; 1 Ton	<b>US4121</b>
1965-1967	V8-5.8L	352 CID	4BL ; 1 Ton	<b>US1075</b>
1986-1987	V8-5.8L	351 CID	2BL High Performance ; 1 Ton	<b>US953H</b>
1986-1987	V8-5.8L	351 CID	2BL; Double tube outlet; 1 Ton	<b>US953</b>
1987-1990	V8-5.8L	351 CID	2BL ; 1 Ton,1 Ton 4WD	<b>US4044</b>

Years	Engine	Disp.	Application Description	USMW
1987-1990	V8-5.8L	351 CID	2BL High Performance ; 1 Ton, 1 Ton 4WD	US4044H
<b>F-350 SUPER DUTY</b>				
1999-2009	V10-6.8L	415 CID	Lariat,XL,XLT,Harley-Davidson Edition,King Ranch,FX4	US4109
2010	V10-6.8L	415 CID	Cabela's,King Ranch,Lariat,XL,XLT	US6144
1999-2002	V8-5.4L	330 CID	Lariat,XL,XLT	US4122
2003-2010	V8-5.4L	330 CID		US4110
2003	V8-6.0L	363 CID	Lariat,XL,XLT	US61
2004-2007	V8-6.0L	363 CID	Harley-Davidson Edition,King Ranch,Lariat,XL,XLT	US67
2011-2013	V8-6.2L	379 CID		US6006
2008-2010	V8-6.4L	391 CID	FX4,Harley-Davidson Edition,King Ranch,Lariat,XL,XLT,Cabela's	US76
2011-2012	V8-6.7L	406 CID	King Ranch,Lariat,XL,XLT	US77
1999-2003	V8-7.3L	445 CID	Lariat,XL,XLT	US4114
<b>F-351</b>				
1965	V8-5.0L	302 CID	4BL ; 1 Ton	US819
<b>F-352</b>				
1966	V8-4.7L	289 CID	4BL ; 1 Ton	US819
<b>F-353</b>				
1966	V8-5.0L	302 CID	4BL ; 1 Ton	US819
<b>F-450 SUPER DUTY</b>				
1999-2008	V10-6.8L	415 CID	Lariat,XL,XLT,King Ranch	US4109
2011	V10-6.8L	415 CID	XL,XLT	US6144
2003	V8-6.0L	363 CID	Lariat,XL,XLT	US61
2004-2007	V8-6.0L	363 CID	Lariat,XL,XLT	US67
2008-2010	V8-6.4L	391 CID	King Ranch,Lariat,XL,XLT,Harley-Davidson Edition	US76
2011	V8-6.7L	406 CID	King Ranch,Lariat,XL,XLT	US77
1999-2003	V8-7.3L	445 CID	Lariat,XL,XLT	US4114
<b>F53</b>				
1995-1997	V8-7.5L	460 CID	XL,Base	US4086
<b>F-550 SUPER DUTY</b>				
1999-2008	V10-6.8L	415 CID	Lariat,XL,XLT	US4109
2009-2011	V10-6.8L	415 CID	Lariat,XL,XLT	US6144
2003	V8-6.0L	363 CID	Lariat,XL,XLT	US61
2004-2007	V8-6.0L	363 CID	Lariat,XL,XLT	US67
2008-2010	V8-6.4L	391 CID	Lariat,XL,XLT	US76
2011	V8-6.7L	406 CID	Lariat,XL,XLT	US77
1999-2003	V8-7.3L	445 CID	Lariat,XL,XLT	US4114
<b>FAIRLANE</b>				
1962-1966	L6-2.8L	170 CID		US1044
1963-1969	L6-3.3L	200 CID		US1044
1962	L6-3.6L	223 CID		US819
1962-1963	V8-3.6L	221 CID		US819
1962-1964	V8-4.3L	260 CID		US819
1963-1967	V8-4.7L	289 CID		US819
1961-1964	V8-5.8L	352 CID		US723
1961-1964	V8-6.4L	390 CID		US723
1964	V8-7.0L	427 CID		US723
<b>FAIRMONT</b>				
1978-1982	L4-2.3L	140 CID	Base,Futura,S	US4005
1983	L4-2.3L	140 CID	Futura,S	US4054
1978-1983	L6-3.3L	200 CID	Base,Futura,S	US4002
1980-1982	V8-4.2L	255 CID	Double tube outlet; Base,Futura,S	US953
1980-1982	V8-4.2L	255 CID	High Performance; Base,Futura,S	US953H
1978-1979	V8-5.0L	302 CID	Double tube outlet	US953
1978-1979	V8-5.0L	302 CID	High Performance	US953H
<b>FAIRMONT (MEX)</b>				
1978-1979	V8-4.2L	256 CID	2BL High Performance	US953H
1978-1979	V8-4.2L	256 CID	2BL; Double tube outlet	US953
1981-1983	V8-5.0L	302 CID	2BL High Performance	US953H
1981-1983	V8-5.0L	302 CID	2BL; Double tube outlet	US953
<b>FALCON</b>				
1960-1964	L6-2.4L	144 CID		US1044
1960-1969	L6-2.8L	170 CID		US1044
1963-1970	L6-3.3L	200 CID		US1044
1962-1963	V8-3.6L	221 CID		US819
1962-1965	V8-4.3L	260 CID		US819
1964-1966	V8-4.7L	289 CID		US819

Years	Engine	Disp.	Application Description	USMW
<b>FALCON (MEX)</b>				
1969	V8-5.0L	302 CID	4BL High Performance	US1028H
<b>FALCON SEDAN DELIVERY</b>				
1961-1964	L6-2.4L	144 CID		US1044
1961-1965	L6-2.8L	170 CID		US1044
1963-1965	L6-3.3L	200 CID		US1044
1962	V8-4.3L	260 CID		US819
1965	V8-4.7L	289 CID		US819
<b>FESTIVA</b>				
1988-1993	L4-1.3L	1295cc	L,LX,GL,L Plus	US4049
<b>FIESTA</b>				
1998-2000	L4-1.3L	79 CID		US8934
1989-1994	L4-1.4L	1391cc		US8905
1978-1980	L4-1.6L	98 CID	Base	US4003
1989-1994	L4-1.6L	1598cc		US8905
<b>FIESTA (MEX)</b>				
1998-2001	L4-1.3L	79 CID	FI	US8934
1998-2000	L4-1.4L	85 CID	FI DOHC	US4104
2001-2009	L4-1.6L	97 CID	MFI ;,FI	US8931
<b>FIESTA IKON (MEX)</b>				
2002-2007	L4-1.6L	97 CID	MFI ;,FI	US8931
<b>FIVE HUNDRED</b>				
2005-2007	V6-3.0L	183 CID		US6186
<b>FLEX</b>				
2009-2010	V6-3.5L	213 CID	Limited,SE,SEL	US6023
2011-2012	V6-3.5L	213 CID	Limited,SE,SEL,Titanium,To 01/02/12; Limited	US8980
<b>FOCUS</b>				
2000-2004	L4-2.0L	121 CID	DOHC	US4115
2000-2004	L4-2.0L	121 CID	SOHC	US4123
2012	L4-2.0L	121 CID	S,SE,SEL,Titanium	US4126
2003-2011	L4-2.3L	140 CID	LX,SE,ZTS,ZTW,ZX3,ZX5,ZX4,ZX4 ST,ZXW,S,SES,ST,SEL	US4126
<b>FOCUS (MEX)</b>				
2010-2011	L4-2.0L	122 CID	SFI DOHC ; Ambiente,Sport	US4126
2007-2011	L5-2.5L	154 CID	Turbo DOHC; ST	US9339
<b>FORD 300</b>				
1963	L6-3.3L	200 CID		US1044
1963	V8-4.3L	260 CID		US819
1963	V8-4.7L	289 CID		US819
1963	V8-5.8L	352 CID		US723
1963	V8-6.4L	390 CID		US723
1963	V8-6.6L	406 CID		US723
1963	V8-7.0L	427 CID		US723
<b>FREESTAR</b>				
2004-2007	V6-3.9L	238 CID	SE	US4102
2004-2007	V6-4.2L	256 CID	Base,Limited,S,SEL,SES	US4102
<b>FREESTYLE</b>				
2005-2007	V6-3.0L	183 CID		US6186
<b>FUSION</b>				
2006-2009	L4-2.3L	140 CID	S,SE,SEL	US4126
2010-2012	L4-2.5L	152 CID	Hybrid,S,SE,SEL	US4126
2006-2009	V6-3.0L	183 CID	SE,SEL	US9489
2010-2012	V6-3.0L	183 CID	SE,SEL	US6250
2010-2011	V6-3.5L	213 CID	Sport	US6023
2012	V6-3.5L	213 CID	To 01/02/12; Sport	US8980
<b>GALAXIE</b>				
1963	L6-3.3L	200 CID		US1044
1963-1964	V8-4.3L	260 CID		US819
1963-1965	V8-4.7L	289 CID		US819
1961-1964	V8-5.8L	352 CID		US723
1961-1964	V8-6.4L	390 CID		US723
1962-1963	V8-6.6L	406 CID		US723
1963-1964	V8-7.0L	427 CID		US723
<b>GALAXIE (MEX)</b>				
1975-1976	V8-5.8L	351 CID	4BL High Performance ;,2BL High Performance	US953H
1975-1976	V8-5.8L	351 CID	4BL; Double tube outlet;,2BL; Double tube outlet,;	US953

Years	Engine	Disp.	Application Description	USMW
<b>GALAXIE 500</b>				
1963	L6-3.3L	200 CID		US1044
1963-1964	V8-4.3L	260 CID		US819
1963-1967	V8-4.7L	289 CID		US819
1962-1964	V8-5.8L	352 CID		US723
1962-1964	V8-6.4L	390 CID		US723
<b>GALAXIE 500 (MEX)</b>				
1969	V8-5.8L	351 CID	4BL High Performance	US1028H
1970-1974	V8-5.8L	351 CID	4BL High Performance	US953H
1970-1974	V8-5.8L	351 CID	4BL; Double tube outlet	US953
<b>GHIA (MEX)</b>				
1990	L4-2.3L	2300cc	FI	US4022
1991-1992	L4-2.3L	2300cc	FI	US4041
1992-1994	V6-3.0L	2985cc	FI	US4070
<b>GRANADA</b>				
1981-1982	L4-2.3L	140 CID	GL, GLX, L	US4005
1975-1982	L6-3.3L	200 CID	GL, GLX, L	US4002
1975-1980	L6-4.1L	250 CID	Base, ESS, Ghia	US960
1982	V6-3.8L	232 CID	GL, GLX, L	US4016
1980-1981	V8-4.2L	255 CID	Double tube outlet; Base, ESS, Ghia, Double tube outlet; GL, GLX, L	US953
1980-1981	V8-4.2L	255 CID	High Performance; Base, ESS, Ghia, High Performance; GL, GLX, L	US953H
1975-1980	V8-5.0L	302 CID	Double tube outlet; Base, ESS, Ghia	US953
1975-1980	V8-5.0L	302 CID	High Performance; Base, ESS, Ghia	US953H
1975-1977	V8-5.8L	351 CID	Double tube outlet	US953
1975-1977	V8-5.8L	351 CID	High Performance	US953H
<b>GRAND MARQUIS (MEX)</b>				
1993-1997	V8-4.6L	281 CID	MFI SOHC	US4066
1998-2001	V8-4.6L	281 CID	MFI SOHC	US4113
2002-2004	V8-4.6L	281 CID	MFI SOHC	US4128
1991-1992	V8-5.0L	302 CID	FI	US4052
1991-1992	V8-5.0L	302 CID	FI High Performance	US4052H
<b>GT40</b>				
1966-1968	V8-4.7L	289 CID		US819
1964	V8-7.0L	427 CID		US723
<b>KA (MEX)</b>				
2001	L4-1.6L	1596cc	MFI	US8931
2002-2008	L4-1.6L	1587cc	FI	US8931
<b>LOBO</b>				
2001-2008	V8-5.4L	330 CID		US4125
<b>LOBO (MEX)</b>				
1997-2010	V8-4.6L	4608cc	MFI SOHC ; 2WD, 4WD, MFI SOHC ; XLT	US4122
2007	V8-4.6L	4608cc	MFI SOHC ; 4WD	US4125
1999-2010	V8-5.4L	5409cc	FI SOHC ; 2WD, 4WD, SOHC ; 2WD, Harley-Davidson, FI SOHC ; 4WD, FI SOHC ; Lariat, Lariat 4WD, Sport 4WD, XLT 4WD	US4125
2002-2003	V8-5.4L	5409cc	FI SC ; 2WD	US4122
<b>LTD</b>				
1983-1986	L4-2.3L	140 CID	Base, Brougham	US4054
1983	L6-3.3L	200 CID	Base, Brougham	US4002
1983-1986	V6-3.8L	232 CID	Base, Brougham	US4016
1981-1982	V8-4.2L	255 CID	Base, Crown Victoria, S	US4014
1965-1967	V8-4.7L	289 CID		US819
1977-1979	V8-5.0L	302 CID	Double tube outlet	US953
1977-1979	V8-5.0L	302 CID	High Performance	US953H
1980-1986	V8-5.0L	302 CID	Base, Country Squire, Crown Victoria, S, Brougham, Country Squire LX, Crown Victoria LX	US4014
1985	V8-5.0L	302 CID	High Performance; Base, Brougham, LX Brougham, Base	US4024H
1975-1979	V8-5.8L	351 CID	Double tube outlet	US953
1975-1979	V8-5.8L	351 CID	High Performance	US953H
1975-1979	V8-5.8L	351 CID	Single tube outlet	US932
1980-1986	V8-5.8L	351 CID	Base, Country Squire, Crown Victoria, S, Country Squire LX, Crown Victoria LX	US4014
1975-1978	V8-6.6L	400 CID	Single tube outlet	US932
1975-1978	V8-7.5L	460 CID		US1114
<b>LTD (MEX)</b>				
1975-1976	V8-5.0L	302 CID	2BL High Performance	US953H

Years	Engine	Disp.	Application Description	USMW
1975-1976	V8-5.0L	302 CID	2BL; Double tube outlet	US953
1977-1978	V8-5.8L	351 CID	4BL High Performance	US953H
1977-1978	V8-5.8L	351 CID	4BL; Double tube outlet	US953
1979-1980	V8-5.8L	351 CID	4BL	US4052
1979-1980	V8-5.8L	351 CID	4BL High Performance	US4052H
<b>LTD CROWN VICTORIA</b>				
1987	V8-5.0L	302 CID	Base	US4014
1988-1991	V8-5.0L	302 CID	From 06/88; Base, Base, LX, S	US4052
1988-1991	V8-5.0L	302 CID	From 06/88; High Performance; Base, LX, S,	US4052H
1987-1991	V8-5.8L	351 CID	Base, LX, S, To 06/88; Base	US4014
<b>LTD II</b>				
1977-1979	V8-5.0L	302 CID	Double tube outlet	US953
1977-1979	V8-5.0L	302 CID	High Performance	US953H
1977-1979	V8-5.8L	351 CID	Double tube outlet	US953
1977-1979	V8-5.8L	351 CID	High Performance	US953H
1977-1979	V8-5.8L	351 CID	Single tube outlet	US932
1977-1978	V8-6.6L	400 CID	Single tube outlet	US932
<b>MAVERICK</b>				
1993-1998	L4-2.7L	2663cc	Diesel	US8930
1969-1972	L6-2.8L	170 CID		US1044
1969-1974	L6-3.3L	200 CID		US1044
1975-1977	L6-3.3L	200 CID		US4002
1975-1977	L6-4.1L	250 CID		US960
1975-1977	V8-5.0L	302 CID	Double tube outlet	US953
1975-1977	V8-5.0L	302 CID	High Performance	US953H
<b>MAVERICK (MEX)</b>				
1971-1977	V8-4.7L	289 CID	2BL High Performance	US953H
1971-1977	V8-4.7L	289 CID	2BL; Double tube outlet	US953
1970	V8-5.0L	302 CID	2BL High Performance	US953H
<b>MONDEO (MEX)</b>				
2002-2007	L4-2.0L	1988cc	FI DOHC	US4126
2002-2007	V6-2.5L	2544cc	FI DOHC	US4091
<b>MONDEO ST (MEX)</b>				
2005	V6-3.0L	2966cc	FI DOHC	US4091
<b>MONDEO TREND (MEX)</b>				
2001	V6-2.5L	2544cc	FI	US4091
<b>MUSTANG</b>				
1979-1982	L4-2.3L	140 CID	Base, Ghia, GL, GLX, L	US4005
1983-1993	L4-2.3L	140 CID	GL, GLX, L, Turbo GT, GT, GT-350 20th Anniversary, LX, SVO, From 12/87; LX	US4054
1964-1965	L6-2.8L	170 CID		US1044
1964-1970	L6-3.3L	200 CID		US1044
1979-1982	L6-3.3L	200 CID	Base, Ghia, GL, GLX, L	US4002
1979	V6-2.8L	171 CID		US1047
1983-1986	V6-3.8L	232 CID	GL, GLX, L, LX	US4016
1994-1995	V6-3.8L	232 CID	Base	US4090
1996-2004	V6-3.8L	232 CID	Base	US4103
2004	V6-3.9L	238 CID	Base	US4103
2005-2010	V6-4.0L	245 CID	Base	US4108
1980-1982	V8-4.2L	255 CID	Base, Ghia, Cobra, GL, GLX, L	US4024
1980-1982	V8-4.2L	255 CID	High Performance; Base, Ghia, Cobra, High Performance; GL, GLX, L	US4024H
1964-1965	V8-4.3L	260 CID		US819
1996-2009	V8-6.6L	281 CID	GT, SVT Cobra, GT Bullitt, Mach I, Shelby GT, Bullitt	US4113
1999-2006	V8-4.6L	281 CID	GT, SVT Cobra	US4119
2001-2004	V8-4.6L	281 CID	GT, GT Bullitt, SVT Cobra, SVT Cobra 10th Anniversary	US4128
1964-1968	V8-4.7L	289 CID		US819
1979-1985	V8-5.0L	302 CID	GL, GLX, GT, L, Exc. CF; GT, GT-350 20th Anniversary, LX	US4024
1979-1985	V8-5.0L	302 CID	High Performance; GL, GLX, GT, L, High Performance; GT, Exc. CF; High Performance; GT, GT-350 20th Anniversary, LX	US4024H
1984-1985	V8-5.0L	302 CID	GT, GT-350 20th Anniversary, LX	US4035
1986-1993	V8-5.0L	302 CID	GT, LX, SVT Cobra, SVT Cobra R	US4038
1986-1993	V8-5.0L	302 CID	High Performance; GT, LX, SVT Cobra, SVT Cobra R	US4038H
1994-1995	V8-5.0L	302 CID	GT, SVT Cobra, GTS	US4087
2011-2013	V8-5.0L	302 CID		US8963
<b>MUSTANG (MEX)</b>				
1969	V8-5.0L	302 CID	4BL High Performance	US1028H



Years	Engine	Disp.	Application Description	USMW
1973-1978	V8-5.0L	302 CID	4BL High Performance	US953H
1973-1978	V8-5.0L	302 CID	4BL; Double tube outlet	US953
1974-1984	V8-5.0L	302 CID	2BL ; 4BL	US4024
1975	V8-5.0L	302 CID	4BL	US1070
1974-1977	V8-5.8L	351 CID	4BL High Performance ; 2BL High Performance	US953H
1974-1977	V8-5.8L	351 CID	4BL; Double tube outlet; 2BL; Double tube outlet;	US953
<b>MUSTANG II</b>				
1975-1978	L4-2.3L	140 CID		US4005
1975-1978	V6-2.8L	171 CID		US1047
1975	V8-5.0L	302 CID		US1070
1976-1978	V8-5.0L	302 CID	From 03/15/76; Double tube outlet	US953
1976-1978	V8-5.0L	302 CID	High Performance	US953H
<b>MYSTIQUE (MEX)</b>				
1994-1996	L4-2.0L	121 CID	SFI	US4088
1997	L4-2.0L	122 CID	SFI	US4088
1995-2000	V6-2.5L	155 CID	FI DOHC	US4091
<b>ORION</b>				
1991-1993	L4-1.4L	1391cc		US8905
1991-1993	L4-1.6L	1598cc		US8905
<b>P-100</b>				
1960-1964	L6-2.4L	144 CID		US1044
1961-1970	L6-2.8L	170 CID		US1044
<b>P-350</b>				
1961-1970	L6-2.8L	170 CID		US1044
<b>P350 (MEX)</b>				
1989-1991	V8-5.0L	5000cc	2BL ; Microbus,FI ; Microbus	US4044
1989-1991	V8-5.0L	5000cc	2BL High Performance ; Microbus, FI High Performance ; Microbus	US4044H
1988-1997	V8-5.8L	5800cc	2BL ; Microbus,FI ; Microbus	US4044
1988-1997	V8-5.8L	5800cc	2BL High Performance ; Microbus, FI High Performance ; Microbus	US4044H
<b>P350 MICROBUS (MEX)</b>				
1986-1987	V8-5.8L	5800cc	2BL High Performance	US953H
1986-1987	V8-5.8L	5800cc	2BL; Double tube outlet	US953
<b>PINTO</b>				
1971-1974	L4-2.0L	122 CID		US964
1975-1980	L4-2.3L	140 CID	Base,Pony,Squire	US4005
1975-1979	V6-2.8L	171 CID		US1047
<b>PROBE</b>				
1993-1997	L4-2.0L	122 CID	Base,SE,GTS	US4078
1989-1992	L4-2.2L	133 CID	GL,GT,LX,Base	US4053
1993-1994	V6-2.5L	152 CID	GT	US9259
1995-1997	V6-2.5L	152 CID	GT	US9318
1990-1992	V6-3.0L	182 CID	LX,SE	US4059
<b>RANCH WAGON</b>				
1960-1964	L6-2.4L	144 CID		US1044
1960-1969	L6-2.8L	170 CID		US1044
1963-1970	L6-3.3L	200 CID		US1044
1961-1964	V8-5.8L	352 CID		US723
1961-1964	V8-6.4L	390 CID		US723
1962-1963	V8-6.6L	406 CID		US723
1963-1964	V8-7.0L	427 CID		US723
<b>RANCHERO</b>				
1960-1964	L6-2.4L	144 CID		US1044
1961-1965	L6-2.8L	170 CID		US1044
1964-1968	L6-3.3L	200 CID		US1044
1977-1979	V8-5.0L	302 CID	Double tube outlet	US953
1977-1979	V8-5.0L	302 CID	High Performance	US953H
1975-1978	V8-5.8L	351 CID	Double tube outlet	US953
1975-1978	V8-5.8L	351 CID	High Performance	US953H
1975-1979	V8-5.8L	351 CID	Single tube outlet	US932
1975-1978	V8-6.6L	400 CID	Single tube outlet	US932
1975-1977	V8-7.5L	460 CID		US1114
<b>RANGER</b>				
1983-1988	L4-2.0L	122 CID	Base,XL,XLS,XLT,S,STX,Custom	US4054
1983-1994	L4-2.3L	140 CID	Base,XL,XLS,XLT,S,STX,Custom,GT,S Plus,Sport, Splash	US4054
1995-1997	L4-2.3L	140 CID	Splash,STX,XL,XL Sport,XLT,Sport	US4093

Years	Engine	Disp.	Application Description	USMW
2001-2011	L4-2.3L	140 CID	XL,XLT,STX	US4126
1998-2001	L4-2.5L	153 CID	Splash,XL,XLT	US4093
1983-1985	V6-2.8L	171 CID	Base,XL,XLS,XLT,S	US4023
1986-1992	V6-2.9L	177 CID	Base,S,STX,XL,XLT,Custom,GT,S Plus,Sport	US4042
1991-1997	V6-3.0L	182 CID	Custom,S,Sport,STX,XLT,Splash,XL	US4039
1995-2008	V6-3.0L	182 CID	Splash,STX,XL,XL Sport,XLT,Sport,Edge,Tremor	US4095
1990-2000	V6-4.0L	245 CID	Custom,S,S Plus,STX,XLT,Sport,Splash,XL,XL Sport	US4060
2001-2011	V6-4.0L	245 CID	Edge,XL,XLT,Tremor,Fx4,Sport,STX	US4108
<b>SABLE (MEX)</b>				
1996-1997	V6-3.0L	183 CID	MFI	US4094
1998-2002	V6-3.0L	181 CID	FI ; FI DOHC	US4094
1994-1995	V6-3.8L	232 CID	FI	US4089
<b>SPRINT</b>				
1963-1964	L6-2.8L	170 CID		US1044
1963-1964	L6-3.3L	200 CID		US1044
<b>STATION BUS</b>				
1962-1964	L6-2.4L	144 CID		US1044
1965	L6-2.8L	170 CID		US1044
<b>SUNLINER</b>				
1963	L6-3.3L	200 CID		US1044
1962-1964	V8-5.8L	352 CID		US723
1962-1964	V8-6.4L	390 CID		US723
1962-1963	V8-6.6L	406 CID		US723
1963-1964	V8-7.0L	427 CID		US723
<b>TAURUS</b>				
1986-1991	L4-2.5L	153 CID	GL,L,LX,MT5	US4056
1986-1994	V6-3.0L	182 CID	GL,L,LX,MT5	US4034
1989-1995	V6-3.0L	182 CID	SHO	US4061
1995-2007	V6-3.0L	182 CID	GL,LX,SE,G,SE Comfort,SVG,SEL,SES	US4094
1996-2000	V6-3.0L	182 CID	LX,SE Comfort,SE,SVG	US4098
2001-2003	V6-3.0L	182 CID	To 04/01/03	US4091
2003-2005	V6-3.0L	182 CID	From 04/01/03; LX,SE,SE Comfort,LX,SEL,SES	US4132
1993-1995	V6-3.2L	195 CID	SHO	US4082
2008-2010	V6-3.5L	213 CID	Limited,SEL,SE,SHO	US6023
2011-2012	V6-3.5L	213 CID	Limited,SE,SEL	US8980
1988-1993	V6-3.8L	232 CID	GL,L,LX	US4051
1994-1995	V6-3.8L	232 CID	GL,LX,SE	US4089
1996-1999	V8-3.4L	207 CID	SHO	US4106
<b>TAURUS X</b>				
2008-2009	V6-3.5L	213 CID	Eddie Bauer,Limited,SEL	US6023
<b>TEMPO</b>				
1984-1986	L4-2.0L	122 CID	Base,GL,GLX,LX	US9067
1984-1991	L4-2.3L	140 CID	Base,GL,GLX,LX,AWD,GLS,Sport,L,L AWD,LX AWD	US4022
1992-1994	L4-2.3L	140 CID	GL,LX	US4041
1992-1994	V6-3.0L	182 CID	GL,GLS,LX,Sport	US4070
<b>THUNDERBIRD</b>				
1983-1988	L4-2.3L	140 CID	Turbo	US4054
1980-1982	L6-3.3L	200 CID	Base,Silver Anniversary,Town Landau,Heritage	US4002
1982-1987	V6-3.8L	232 CID	Base,Heritage,Town Landau,LX,Sport,Elan,File	US4016
1988-1993	V6-3.8L	232 CID	Base,LX,Super Coupe	US4050
1990-1995	V6-3.8L	232 CID	Super Coupe	US4055
1994-1995	V6-3.8L	232 CID	LX	US4090
1996-1997	V6-3.8L	232 CID	LX	US4103
2002-2005	V8-3.9L	242 CID	Base,Pacific Coast Roadster,50th Anniversary Edition	US4124
1980-1982	V8-4.2L	255 CID	Base,Town Landau,Heritage	US4014
1994-1997	V8-4.6L	281 CID	LX	US4113
1977-1979	V8-5.0L	302 CID	Double tube outlet	US953
1977-1979	V8-5.0L	302 CID	High Performance	US953H
1980-1985	V8-5.0L	302 CID	Base,Silver Anniversary,Town Landau,Heritage,LX, Sport,Elan,File	US4014
1986-1988	V8-5.0L	302 CID	Base,Elan,LX,Sport	US4038
1986-1988	V8-5.0L	302 CID	High Performance; Base,Elan,LX,Sport	US4038H
1991-1993	V8-5.0L	302 CID	Base,LX	US4057
1977-1979	V8-5.8L	351 CID	Double tube outlet	US953
1977-1979	V8-5.8L	351 CID	High Performance	US953H
1977-1979	V8-5.8L	351 CID	Single tube outlet	US932
1961-1964	V8-6.4L	390 CID		US723
1962-1963	V8-6.6L	406 CID		US723

Years	Engine	Disp.	Application Description	USMW
1977-1978	V8-6.6L	400 CID	Single tube outlet	US932
1963-1964	V8-7.0L	427 CID		US723
1975-1976	V8-7.5L	460 CID		US1114
<b>THUNDERBIRD (MEX)</b>				
1984	L6-3.8L	232 CID	2BL	US4016
<b>TOPAZ (MEX)</b>				
1986-1991	L4-2.3L	140 CID	1BL ;,,FI	US4022
1992-1994	L4-2.3L	140 CID	TBI	US4041
1992-1993	V6-3.0L	182 CID	FI	US4070
<b>TORINO</b>				
1968	L6-3.3L	200 CID		US1044
1975	V8-5.8L	351 CID	Single tube outlet	US932
1976	V8-5.8L	351 CID	High Performance,;	US953H
1975-1976	V8-6.6L	400 CID	Single tube outlet	US932
1975-1976	V8-7.5L	460 CID		US1114
<b>TRANSIT CONNECT</b>				
2010-2012	L4-2.0L	121 CID	XL,XLT,XLT Premium	US4126
<b>VAGONETA (MEX)</b>				
1996-1997	L4-1.9L	1900cc	MFI	US4069
<b>VICTORIA</b>				
1963	L6-3.3L	200 CID		US1044
1962-1964	V8-5.8L	352 CID		US723
1962-1964	V8-6.4L	390 CID		US723
1962-1963	V8-6.6L	406 CID		US723
1963-1964	V8-7.0L	427 CID		US723
<b>WINDSTAR</b>				
1995-2000	V6-3.0L	182 CID	Base,GL,LX,3.0L,Limited,SE,SEL	US4094
1995	V6-3.8L	232 CID	Base,GL,LX	US4089
1996-2003	V6-3.8L	232 CID	Base,GL,LX,Limited,SE,SEL,SE Sport	US4102
<b>WINDSTAR (MEX)</b>				
1994	V6-3.8L	232 CID	FI	US4089
<b>GENERAL MOTORS</b>				
<b>ASTRA</b>				
1994-2004	L4-1.4L	1389cc		US8962
1994-2004	L4-1.6L	1598cc		US8962
<b>CORSA</b>				
1995-2006	L4-1.4L	1389cc		US8962
1993-2000	L4-1.6L	1598cc		US8962
<b>GEO</b>				
<b>METRO</b>				
1989-1997	L3-1.0L	61 CID	Base,LSi,XFi	US5058
1995-1997	L4-1.3L	79 CID	Base,LSi	US5058
<b>PRIZM</b>				
1989-1992	L4-1.6L	1587cc	Base,LSi	US9057
1990-1992	L4-1.6L	1587cc	GSi	US9076
1993-1997	L4-1.6L	98 CID	Base,LSi	US9271
1993-1997	L4-1.8L	110 CID	LSi	US9272
<b>SPECTRUM</b>				
1989	L4-1.5L	92 CID	Base	US5031
<b>STORM</b>				
1990-1991	L4-1.6L	98 CID	2+2 GSi	US9220
1990-1993	L4-1.6L	98 CID	2+2,Base	US9221
1992-1993	L4-1.8L	110 CID	2+2 GSi	US9221
<b>TRACKER</b>				
1989-1997	L4-1.6L	98 CID	Base,LSi	US5048
<b>GMC</b>				
<b>ACADIA</b>				
2007-2011	V6-3.6L	217 CID	SLE,SLT,SL,Denali	US8932
<b>ACADIA (MEX)</b>				
2010	V6-3.6L	217 CID	SFI DOHC	US8932
<b>ACADIA AWD (MEX)</b>				
2010	V6-3.6L	217 CID	SFI DOHC	US8932
<b>C15</b>				
1975-1977	L6-4.1L	250 CID		US1110
1978	L6-4.1L	250 CID		US1107

Years	Engine	Disp.	Application Description	USMW
1977-1978	V8-5.0L	305 CID		US1121
1977-1978	V8-5.0L	305 CID	High Performance	US1121H
1975-1976	V8-5.7L	350 CID		US1109
1975-1976	V8-5.7L	350 CID	High Performance	US1109H
1977-1978	V8-5.7L	350 CID		US1121
1977-1978	V8-5.7L	350 CID	High Performance	US1121H
1976	V8-6.6L	400 CID	High Performance,;	US1109H
1978	V8-6.6L	400 CID	High Performance,;	US1121H
<b>C15 SUBURBAN</b>				
1975-1977	L6-4.1L	250 CID		US1110
1978	L6-4.1L	250 CID		US1107
1977-1978	V8-5.0L	305 CID		US1121
1977-1978	V8-5.0L	305 CID	High Performance	US1121H
1975-1976	V8-5.7L	350 CID		US1109
1975-1976	V8-5.7L	350 CID	High Performance	US1109H
1977-1978	V8-5.7L	350 CID		US1121
1977-1978	V8-5.7L	350 CID	High Performance	US1121H
<b>C15/C1500 PICKUP</b>				
1968-1969	V8-6.5L	396 CID		US981
1970-1972	V8-6.6L	402 CID		US981
<b>C15/C1500 SUBURBAN</b>				
1968-1969	V8-6.5L	396 CID		US981
1970-1972	V8-6.6L	402 CID		US981
<b>C1500</b>				
1979-1984	L6-4.1L	250 CID	Base,Heavy Half,High Sierra,Sierra Classic, Sierra Grande,Street Coupe	US1107
1980	L6-4.8L	292 CID	Base,Heavy Half,High Sierra,Sierra Classic, Sierra Grande,Street Coupe	US5030
1985-1986	V6-4.3L	262 CID	Base,High Sierra,Sierra Classic	US1121
1985-1986	V6-4.3L	262 CID	High Performance; Base,High Sierra,Sierra Classic	US1121H
1988-1995	V6-4.3L	262 CID	High Performance; Sierra,Sierra SLE,Sierra SLX, Sierra SL,Sierra SLT,Sierra Special	US5049H
1988-1995	V6-4.3L	262 CID	Sierra,Sierra SLE,Sierra SLX,Sierra SL,Sierra SLT, Sierra Special	US5049
1996-1998	V6-4.3L	262 CID	Sierra SL,Sierra SLE,Sierra SLT,Sierra Special,Sierra GT	US5077
1979-1986	V8-5.0L	305 CID	Base,Heavy Half,High Sierra,Sierra Classic, Sierra Grande,Street Coupe	US1121
1979-1986	V8-5.0L	305 CID	High Performance; Base,Heavy Half,High Sierra, Sierra Classic,Sierra Grande,Street Coupe	US1121H
1988-1995	V8-5.0L	305 CID	High Performance; Sierra,Sierra SLE,Sierra SLX, Sierra SL,Sierra SLT,Sierra Special	US5049H
1988-1995	V8-5.0L	305 CID	Sierra,Sierra SLE,Sierra SLX,Sierra SL,Sierra SLT Sierra Special	US5049
1996-1999	V8-5.0L	305 CID	Sierra SL,Sierra SLE,Sierra SLT,Sierra Special, Sierra GT	US5077
1979-1986	V8-5.7L	350 CID	Base,Heavy Half,High Sierra,Sierra Classic, Sierra Grande,Street Coupe	US1121
1979-1986	V8-5.7L	350 CID	High Performance; Base,Heavy Half,High Sierra, Sierra Classic,Sierra Grande,Street Coupe	US1121H
1988-1995	V8-5.7L	350 CID	High Performance; Sierra,Sierra SLE,Sierra SLX, High Performance; Sierra SL,Sierra SLT,Sierra Special	US5049H
1988-1995	V8-5.7L	350 CID	Sierra,Sierra SLE,Sierra SLX,Sierra SL,Sierra SLT, Sierra Special	US5049
1992	V8-5.7L	350 CID	5.8" Hub height; Sierra,Sierra SLE,Sierra SLX	US5073
1996-1999	V8-5.7L	350 CID	Sierra SL,Sierra SLE,Sierra SLT,Sierra Special,Sierra GT	US5077
1982-1986	V8-6.2L	379 CID	Base,High Sierra,Sierra Classic,Sierra Grande, Street Coupe	US5008
1988-1993	V8-6.2L	379 CID	Sierra,Sierra SLE,Sierra SLX	US5062
1994-1995	V8-6.5L	395 CID	Sierra SL,Sierra SLE,Sierra SLT,Sierra Special	US5062
1996-1997	V8-6.5L	395 CID	Sierra SL,Sierra SLE,Sierra SLT,Sierra Special,Sierra GT	US5074
1979-1980	V8-6.6L	400 CID	Base,Heavy Half,High Sierra,Sierra Classic, Sierra Grande,Street Coupe	US1121
1979-1980	V8-6.6L	400 CID	High Performance; Base,Heavy Half,High Sierra, Sierra Classic,Sierra Grande,Street Coupe	US1121H
1980	V8-7.4L	454 CID	High Performance; Base,Heavy Half,High Sierra, Sierra Classic,Sierra Grande,Street Coupe,Base	US1002H
<b>C1500 (MEX)</b>				
1980-1984	L6-4.1L	250 CID	1BL ; 1/2 Ton	US1107
1994-1997	L6-4.1L	250 CID	TBI ; 1/2 Ton	US895

Years	Engine	Disp.	Application Description	USMW
1981-1986	L6-4.8L	292 CID	1BL ; 1/2 Ton	US5030
1981-1988	V8-5.7L	350 CID	2BL ; 1/2 Ton,4BL ; 1/2 Ton	US1121
1981-1988	V8-5.7L	350 CID	2BL High Performance ; 1/2 Ton, 4BL High Performance ; 1/2 Ton	US1121H
1989-1990	V8-5.7L	350 CID	4BL ; 1/2 Ton	US5049
1989-1990	V8-5.7L	350 CID	4BL High Performance ; 1/2 Ton	US5049H
<b>C1500 SUBURBAN</b>				
1979-1980	L6-4.1L	250 CID	Base,High Sierra,Sierra Classic,Sierra Grande	US1107
1979-1986	V8-5.0L	305 CID	Base,High Sierra,Sierra Classic,Sierra Grande	US1121
1979-1986	V8-5.0L	305 CID	High Performance; Base,High Sierra,Sierra Classic, Sierra Grande	US1121H
1979-1986	V8-5.7L	350 CID	Base,High Sierra,Sierra Classic,Sierra Grande	US1121
1979-1986	V8-5.7L	350 CID	High Performance; Base,High Sierra,Sierra Classic, Sierra Grande	US1121H
1992	V8-5.7L	350 CID	5.8" Hub height; Base,SLE	US5073
1992-1995	V8-5.7L	350 CID	Base,SLE,SLT	US5049
1992-1995	V8-5.7L	350 CID	High Performance; Base,SLE,SLT	US5049H
1996-1999	V8-5.7L	350 CID	Base,SLE,SLT	US5077
1982-1986	V8-6.2L	379 CID	Base,High Sierra,Sierra Classic,Sierra Grande	US5008
1995	V8-6.5L	395 CID	Base,SLE,SLT	US5062
1996-1998	V8-6.5L	395 CID	Base,SLE,SLT	US5074
1999	V8-6.5L	395 CID	Base,SLE,SLT	US5086
1980	V8-7.4L	454 CID	High Performance; Base,High Sierra,Sierra Classic, Sierra Grande,Base	US1002H
<b>C25</b>				
1977-1978	L6-4.1L	250 CID		US1107
1975-1977	L6-4.8L	292 CID		US1137
1978	L6-4.8L	292 CID		US5030
1977-1978	V8-5.0L	305 CID		US1121
1977-1978	V8-5.0L	305 CID	High Performance	US1121H
1975-1976	V8-5.7L	350 CID		US1109
1975-1976	V8-5.7L	350 CID	High Performance	US1109H
1977-1978	V8-5.7L	350 CID		US1121
1977-1978	V8-5.7L	350 CID	High Performance	US1121H
1976	V8-6.6L	400 CID	High Performance;	US1109H
1977-1978	V8-6.6L	400 CID		US1121
1977-1978	V8-6.6L	400 CID	High Performance	US1121H
<b>C25 SUBURBAN</b>				
1975-1977	L6-4.8L	292 CID		US1137
1978	L6-4.8L	292 CID		US5030
1977-1978	V8-5.0L	305 CID		US1121
1977-1978	V8-5.0L	305 CID	High Performance	US1121H
1975-1976	V8-5.7L	350 CID		US1109
1975-1976	V8-5.7L	350 CID	High Performance	US1109H
1977-1978	V8-5.7L	350 CID		US1121
1977-1978	V8-5.7L	350 CID	High Performance	US1121H
1978	V8-6.6L	400 CID	High Performance;	US1121H
<b>C25/C2500 PICKUP</b>				
1968-1969	V8-6.5L	396 CID		US981
1970-1972	V8-6.6L	402 CID		US981
<b>C25/C2500 SUBURBAN</b>				
1968-1969	V8-6.5L	396 CID		US981
1970-1972	V8-6.6L	402 CID		US981
<b>C2500</b>				
1979-1984	L6-4.1L	250 CID	Base,High Sierra,Sierra Classic,Sierra Grande	US1107
1979-1986	L6-4.8L	292 CID	Base,High Sierra,Sierra Classic,Sierra Grande	US5030
1985-1986	V6-4.3L	262 CID	Base,High Sierra,Sierra Classic	US1121
1985-1986	V6-4.3L	262 CID	High Performance; Base,High Sierra,Sierra Classic	US1121H
1988-1995	V6-4.3L	262 CID	High Performance; Sierra,Sierra SLE,Sierra SLX Sierra SL	US5049H
1988-1995	V6-4.3L	262 CID	Sierra,Sierra SLE,Sierra SLX,Sierra SL	US5049
1979-1986	V8-5.0L	305 CID	Base,High Sierra,Sierra Classic,Sierra Grande	US1121
1979-1986	V8-5.0L	305 CID	High Performance; Base,High Sierra,Sierra Classic, Sierra Grande	US1121H
1988-1995	V8-5.0L	305 CID	High Performance; Sierra,Sierra SLE,Sierra SLX, Sierra SL,Sierra SLT	US5049H
1988-1995	V8-5.0L	305 CID	Sierra,Sierra SLE,Sierra SLX,Sierra SL,Sierra SLT	US5049
1996-1998	V8-5.0L	305 CID	Sierra SL,Sierra SLE,Sierra SLT	US5077
1979-1986	V8-5.7L	350 CID	Base,High Sierra,Sierra Classic,Sierra Grande	US1107
1979-1986	V8-5.7L	350 CID	High Performance; Base,High Sierra,Sierra Classic, Sierra Grande	US1121H
1982-1986	V8-6.2L	379 CID	Base,High Sierra,Sierra Classic,Sierra Grande	US5008
1988-1993	V8-6.2L	379 CID	Sierra,Sierra SLE,Sierra SLX	US5062
1992-1995	V8-6.5L	395 CID	Sierra,Sierra SLE,Sierra SLX,Sierra SL,Sierra SLT	US5062
1996-1998	V8-6.5L	395 CID	Sierra SL,Sierra SLE,Sierra SLT	US5074
1999-2002	V8-6.5L	395 CID	Sierra SL,Sierra SLE,Sierra SLT,HD	US5086
1980-1986	V8-7.4L	454 CID	Base,High Sierra,Sierra Classic,Sierra Grande	US1002

Years	Engine	Disp.	Application Description	USMW
1979-1986	V8-5.7L	350 CID	High Performance; Base,High Sierra,Sierra Classic, Sierra Grande	US1121H
1988-1995	V8-5.7L	350 CID	High Performance; Sierra,Sierra SLE,Sierra SLX, Sierra SL,Sierra SLT	US5049H
1988-1995	V8-5.7L	350 CID	Sierra,Sierra SLE,Sierra SLX,Sierra SL,Sierra SLT	US5049
1996-2000	V8-5.7L	350 CID	Sierra SL,Sierra SLE,Sierra SLT	US5077
1982-1986	V8-6.2L	379 CID	Base,High Sierra,Sierra Classic,Sierra Grande	US5008
1988-1993	V8-6.2L	379 CID	Sierra,Sierra SLE,Sierra SLX	US5062
1992-1995	V8-6.5L	395 CID	Sierra,Sierra SLE,Sierra SLX,Sierra SL,Sierra SLT	US5062
1996-1998	V8-6.5L	395 CID	Sierra SL,Sierra SLE,Sierra SLT	US5074
1999-2000	V8-6.5L	395 CID	Sierra SL,Sierra SLE,Sierra SLT	US5086
1979	V8-6.6L	400 CID	High Performance;	US1121H
1980-1986	V8-7.4L	454 CID	Base,High Sierra,Sierra Classic,Sierra Grande	US1002
1980-1986	V8-7.4L	454 CID	High Performance; Base,High Sierra,Sierra Classic, Sierra Grande	US1002H
1991-2000	V8-7.4L	454 CID	High Performance; Sierra,Sierra SLE,Sierra SLX, High Performance; Sierra SL,Sierra SLT	US5038H
1991-2000	V8-7.4L	454 CID	Sierra,Sierra SLE,Sierra SLX,Sierra SL,Sierra SLT	US5038
<b>C2500 (MEX)</b>				
1985-1988	V8-5.7L	350 CID	2BL ; 3/4 Ton,4BL ; 3/4 Ton	US1121
1985-1988	V8-5.7L	350 CID	2BL High Performance ; 3/4 Ton, 4BL High Performance ; 3/4 Ton	US1121H
1989-1991	V8-5.7L	350 CID	4BL ; 3/4 Ton	US5049
1989-1991	V8-5.7L	350 CID	4BL High Performance ; 3/4 Ton	US5049H
<b>C2500 SUBURBAN</b>				
1979-1984	L6-4.8L	292 CID	Base,High Sierra,Sierra Classic,Sierra Grande	US5030
1982-1986	V8-5.0L	305 CID	Base,High Sierra,Sierra Classic,Sierra Grande	US1121
1982-1986	V8-5.0L	305 CID	High Performance; Base,High Sierra,Sierra Classic, Sierra Grande	US1121H
1979-1986	V8-5.7L	350 CID	Base,High Sierra,Sierra Classic,Sierra Grande	US1121
1979-1986	V8-5.7L	350 CID	High Performance; Base,High Sierra,Sierra Classic, Sierra Grande	US1121H
1992	V8-5.7L	350 CID	5.8" Hub height; Base,SLE	US5073
1992-1995	V8-5.7L	350 CID	Base,SLE,SLT	US5049
1992-1995	V8-5.7L	350 CID	High Performance; Base,SLE,SLT	US5049H
1996-1999	V8-5.7L	350 CID	Base,SLE,SLT	US5077
1982-1986	V8-6.2L	379 CID	Base,High Sierra,Sierra Classic,Sierra Grande	US5008
1994-1995	V8-6.5L	395 CID	Base,SLE,SLT	US5062
1996-1998	V8-6.5L	395 CID	Base,SLE,SLT	US5074
1999	V8-6.5L	395 CID	Base,SLE,SLT	US5086
1980	V8-6.6L	400 CID	High Performance; Base,High Sierra,Sierra Classic Sierra Grande,Base	US1121H
1980-1986	V8-7.4L	454 CID	Base,High Sierra,Sierra Classic,Sierra Grande	US1002
1980-1986	V8-7.4L	454 CID	High Performance; Base,High Sierra,Sierra Classic, Sierra Grande	US1002H
1992-1999	V8-7.4L	454 CID	Base,SLE,SLT	US5038
1992-1999	V8-7.4L	454 CID	High Performance; Base,SLE,SLT	US5038H
<b>C35/C3500 PICKUP</b>				
1968-1969	V8-6.5L	396 CID		US981
1970-1972	V8-6.6L	402 CID		US981
<b>C3500</b>				
1980	L6-4.1L	250 CID	Base,High Sierra,Sierra Classic,Sierra Grande	US1107
1980-1986	L6-4.8L	292 CID	Base,High Sierra,Sierra Classic,Sierra Grande	US5030
1986	V8-5.0L	305 CID	High Performance; Base,High Sierra,Sierra Classic, Base	US1121H
1980-1986	V8-5.7L	350 CID	Base,High Sierra,Sierra Classic,Sierra Grande	US1121
1980-1986	V8-5.7L	350 CID	High Performance; Base,High Sierra,Sierra Classic, Sierra Grande	US1121H
1988-1995	V8-5.7L	350 CID	High Performance; Sierra,Sierra SLE,Sierra SLX, Sierra SL,Sierra SLT	US5049H
1988-1995	V8-5.7L	350 CID	Sierra,Sierra SLE,Sierra SLX,Sierra SL,Sierra SLT	US5049
1996-2000	V8-5.7L	350 CID	Sierra SL,Sierra SLE,Sierra SLT	US5077
1982-1986	V8-6.2L	379 CID	Base,High Sierra,Sierra Classic,Sierra Grande	US5008
1988-1993	V8-6.2L	379 CID	Sierra,Sierra SLE,Sierra SLX	US5062
1992-1995	V8-6.5L	395 CID	Sierra,Sierra SLE,Sierra SLX,Sierra SL,Sierra SLT	US5062
1996-1998	V8-6.5L	395 CID	Sierra SL,Sierra SLE,Sierra SLT	US5074
1999-2002	V8-6.5L	395 CID	Sierra SL,Sierra SLE,Sierra SLT,HD	US5086
1980-1986	V8-7.4L	454 CID	Base,High Sierra,Sierra Classic,Sierra Grande	US1002



Years	Engine	Disp.	Application Description	USMW
1980-1986	V8-7.4L	454 CID	High Performance; Base,High Sierra,Sierra Classic, Sierra Grande	US1002H
1988-2000	V8-7.4L	454 CID	High Performance; Sierra,Sierra SLE,Sierra SLX, Sierra SL,Sierra SLT	US5038H
1988-2000	V8-7.4L	454 CID	Sierra,Sierra SLE,Sierra SLX,Sierra SL,Sierra SLT	US5038
2001-2002	V8-8.1L	496 CID	HD	US5090
<b>C3500 (MEX)</b>				
1980-1988	V8-5.7L	350 CID	2BL ; 1 Ton,4BL ; 1 Ton	US1121
1980-1988	V8-5.7L	350 CID	2BL High Performance ; 1 Ton, 4BL High Performance ; 1 Ton	US1121H
1989-1991	V8-5.7L	350 CID	4BL ; 1 Ton	US5049
1989-1991	V8-5.7L	350 CID	4BL High Performance ; 1 Ton	US5049H
<b>CABALLERO</b>				
1978-1979	V6-3.3L	200 CID		US1121
1978-1979	V6-3.3L	200 CID	High Performance	US1121H
1980-1984	V6-3.8L	229 CID	Base,Diablo,Laredo,Amarillo,Conquista,Royalnight	US1121
1980-1984	V6-3.8L	229 CID	High Performance; Base,Diablo,Laredo, Amarillo,Base,Conquista,Royalnight	US1121H
1980-1984	V6-3.8L	231 CID	Base,Diablo,Laredo,Amarillo,Conquista,Royalnight	US1018
1980-1984	V6-3.8L	231 CID	High Performance; Base,Diablo,Laredo, Amarillo,Base,Conquista,Royalnight	US1018H
1985-1987	V6-4.3L	262 CID	Amarillo,Base,Diablo	US1121
1985-1987	V6-4.3L	262 CID	High Performance; Amarillo,Base,Diablo	US1121H
1980-1982	V8-4.4L	267 CID	Base,Diablo,Laredo,Amarillo,Conquista,Royalnight	US1121
1980-1982	V8-4.4L	267 CID	High Performance; Base,Diablo,Laredo, Amarillo,Base,Conquista,Royalnight	US1121H
1978-1987	V8-5.0L	305 CID	Base,Diablo,Laredo,Amarillo,Conquista,Royalnight	US1121
1978-1987	V8-5.0L	305 CID	High Performance; Base,Diablo,Laredo, Amarillo,Base,Conquista,Royalnight	US1121H
1978-1979	V8-5.7L	350 CID		US1121
1978-1979	V8-5.7L	350 CID	High Performance	US1121H
1983-1984	V8-5.7L	350 CID	Air Cond; Amarillo,Base,Diablo	US1120
1983-1984	V8-5.7L	350 CID	Air Cond; High Performance; Amarillo,Base,Diablo	US1120H
<b>CANYON</b>				
2004-2006	L4-2.8L	169 CID	SL,SLE,Z71 Fleet,Z71 SL,Z71 SLE,Z85 SL,Z85 SLE,WT	US5097
2007-2011	L4-2.9L	178 CID	SL,SLE,WT,SLT	US5097
2004-2006	L5-3.5L	211 CID	SL,SLE,Z71 Fleet,Z71 SL,Z71 SLE,Z85 SL,Z85 SLE,WT	US5097
2006-2011	L5-3.7L	223 CID	SLT,SLE,WT	US5097
2009-2011	V8-5.3L	325 CID	SLT,SLE	US6009
<b>CANYON (MEX)</b>				
2010-2012	L5-3.7L	223 CID	MFI DOHC ; 4WD	US5097
<b>ENVOY</b>				
2002-2009	L6-4.2L	256 CID	SLE,SLT	US5097
2005-2006	V8-5.3L	325 CID	Denali	US64
2005-2006	V8-5.3L	325 CID	Includes thermostat and thermostat housing; Denali	US64-T
2007-2009	V8-5.3L	325 CID	Denali	US6009
<b>G15</b>				
1975-1977	L6-4.1L	250 CID		US1110
1978	L6-4.1L	250 CID		US1107
1977-1978	V8-5.0L	305 CID		US1121
1977-1978	V8-5.0L	305 CID	High Performance	US1121H
1975-1976	V8-5.7L	350 CID		US1109
1975-1976	V8-5.7L	350 CID	High Performance	US1109H
1977-1978	V8-5.7L	350 CID		US1121
1977-1978	V8-5.7L	350 CID	High Performance	US1121H
1976	V8-6.6L	400 CID	High Performance;;	US1109H
<b>G1500</b>				
1979-1984	L6-4.1L	250 CID	Rally,Rally STX,Vandura,Rally Custom	US1107
1985-1986	V6-4.3L	262 CID	High Performance; Rally,Rally STX,Vandura	US1121H
1985-1986	V6-4.3L	262 CID	Rally,Rally STX,Vandura	US1121
1987-1995	V6-4.3L	262 CID	High Performance; Rally,Rally STX, Vandura	US5049H
1987-1995	V6-4.3L	262 CID	Rally,Rally STX,Vandura	US5049
1979-1986	V8-5.0L	305 CID	High Performance; Rally,Rally STX,Vandura, Rally Custom	US1121H
1979-1986	V8-5.0L	305 CID	Rally,Rally STX,Vandura,Rally Custom	US1121
1987-1995	V8-5.0L	305 CID	High Performance; Rally,Rally STX,Vandura	US5049H
1987-1995	V8-5.0L	305 CID	Rally,Rally STX,Vandura	US5049

Years	Engine	Disp.	Application Description	USMW
1979-1986	V8-5.7L	350 CID	High Performance; Rally,Rally STX,Vandura, Rally Custom	US1121H
1979-1986	V8-5.7L	350 CID	Rally,Rally STX,Vandura,Rally Custom	US1121
1987-1993	V8-5.7L	350 CID	High Performance; Rally,Rally STX	US5049H
1987-1993	V8-5.7L	350 CID	Rally,Rally STX	US5049
1979	V8-6.6L	400 CID	High Performance;;	US1121H
<b>G25</b>				
1978	L6-4.1L	250 CID		US1107
1975-1977	L6-4.8L	292 CID		US1137
1978	L6-4.8L	292 CID		US5030
1977-1978	V8-5.0L	305 CID		US1121
1977-1978	V8-5.0L	305 CID	High Performance	US1121H
1975-1976	V8-5.7L	350 CID		US1109
1975-1976	V8-5.7L	350 CID	High Performance	US1109H
1977-1978	V8-5.7L	350 CID		US1121
1977-1978	V8-5.7L	350 CID	High Performance	US1121H
1975-1976	V8-6.6L	400 CID		US1109
1975-1976	V8-6.6L	400 CID	High Performance	US1109H
1977-1978	V8-6.6L	400 CID		US1121
1977-1978	V8-6.6L	400 CID	High Performance	US1121H
<b>G2500</b>				
1979-1984	L6-4.1L	250 CID	Rally,Rally STX,Vandura,Rally Custom	US1107
1985-1986	V6-4.3L	262 CID	High Performance; Rally,Rally STX,Vandura	US1121H
1985-1986	V6-4.3L	262 CID	Rally,Rally STX,Vandura	US1121
1987-1995	V6-4.3L	262 CID	High Performance; Rally,Rally STX,Vandura	US5049H
1987-1995	V6-4.3L	262 CID	Rally,Rally STX,Vandura	US5049
1979-1986	V8-5.0L	305 CID	High Performance; Rally,Rally STX,Vandura, Rally Custom	US1121H
1979-1986	V8-5.0L	305 CID	Rally,Rally STX,Vandura,Rally Custom	US1121
1987-1995	V8-5.0L	305 CID	High Performance; Rally,Rally STX,Vandura	US5049H
1987-1995	V8-5.0L	305 CID	Rally,Rally STX,Vandura	US5049
1979-1986	V8-5.7L	350 CID	High Performance; Rally,Rally STX,Vandura, Rally Custom	US1121H
1979-1986	V8-5.7L	350 CID	Rally,Rally STX,Vandura,Rally Custom	US1121
1987-1995	V8-5.7L	350 CID	High Performance; Rally,Rally STX,Vandura	US5049H
1987-1995	V8-5.7L	350 CID	Rally,Rally STX,Vandura	US5049
1979-1986	V8-5.7L	350 CID	High Performance; Rally,Rally STX,Vandura, Rally Custom	US1121H
1979-1986	V8-5.7L	350 CID	Rally,Rally STX,Vandura,Rally Custom	US1121
1987-1995	V8-5.7L	350 CID	High Performance; Rally,Rally STX,Vandura	US5049H
1987-1995	V8-5.7L	350 CID	Rally,Rally STX,Vandura	US5049
1979-1986	V8-5.7L	350 CID	High Performance; Rally,Rally STX,Vandura, Rally Custom	US1121H
1979-1986	V8-5.7L	350 CID	Rally,Rally STX,Vandura,Rally Custom	US1121
1987-1995	V8-5.7L	350 CID	High Performance; Rally,Rally STX,Vandura	US5049H
1987-1995	V8-5.7L	350 CID	Rally,Rally STX,Vandura	US5049

WATER PUMPS

Years	Engine	Disp.	Application Description	USMW
1983-1993	V8-6.2L	379 CID	Magnavan,Rally,Rally Camper Special,Rally Custom, Rally STX,Vandura,Vandura Special	US5008
1994-1996	V8-6.5L	395 CID	Rally,Rally Camper Special,Rally STX,Vandura, Vandura Special,Magnavan	US5062
1979-1980	V8-6.6L	400 CID	High Performance; Magnavan,Rally,Rally Camper Special,Rally STX,Vandura,Vandura Special	US1121H
1979-1980	V8-6.6L	400 CID	Magnavan,Rally,Rally Camper Special,Rally STX, Vandura,Vandura Special	US1121
1988-1996	V8-7.4L	454 CID	High Performance; Magnavan,Rally,Rally Camper Special,Rally STX,Vandura,Vandura Special	US5038H
1988-1996	V8-7.4L	454 CID	Magnavan,Rally,Rally Camper Special,Rally STX, Vandura,Vandura Special	US5038
<b>JIMMY</b>				
1975-1977	L6-4.1L	250 CID		US1110
1978-1982	L6-4.1L	250 CID	Base,High Sierra,Sierra Classic,Sierra Grande, Street Coupe	US1107
1970-1974	L6-4.8L	292 CID		US896
1992-1995	V6-4.3L	262 CID	Base,SLE,SLT,SLS,SL	US5049
1992-1995	V6-4.3L	262 CID	High Performance; Base,SLE,SLT,SLS,SL	US5049H
1996-2001	V6-4.3L	262 CID	Base,SL,SLE,SLS,SLT,Envoy,Diamond Edition	US5077
1977-1987	V8-5.0L	305 CID	Base,High Sierra,Sierra Classic,Sierra Grande Street Coupe,Silverado	US1121
1977-1987	V8-5.0L	305 CID	High Performance; Base,High Sierra,Sierra Classic, Sierra Grande,Street Coupe,Silverado	US1121H
1975-1976	V8-5.7L	350 CID		US1109
1975-1976	V8-5.7L	350 CID	High Performance	US1109H
1977-1988	V8-5.7L	350 CID	Base,High Sierra,Sierra Classic,Sierra Grande,Street Coupe,Silverado	US1121
1977-1988	V8-5.7L	350 CID	High Performance; Base,High Sierra,Sierra Classic, Sierra Grande,Street Coupe,Silverado	US1121H
1989-1991	V8-5.7L	350 CID	Base,Sierra Classic	US5049
1989-1991	V8-5.7L	350 CID	High Performance; Base,Sierra Classic	US5049H
1982-1991	V8-6.2L	379 CID	Base,High Sierra,Sierra Classic,Sierra Grande,Street Coupe,Silverado	US5008
1975-1976	V8-6.6L	400 CID		US1109
1975-1976	V8-6.6L	400 CID	High Performance	US1109H
1977-1979	V8-6.6L	400 CID		US1121
1977-1979	V8-6.6L	400 CID	High Performance	US1121H
<b>K15</b>				
1975-1977	L6-4.1L	250 CID		US1110
1978	L6-4.1L	250 CID		US1107
1977-1978	V8-5.0L	305 CID		US1121
1977-1978	V8-5.0L	305 CID	High Performance	US1121H
1975-1976	V8-5.7L	350 CID		US1109
1975-1976	V8-5.7L	350 CID	High Performance	US1109H
1977-1978	V8-5.7L	350 CID		US1121
1977-1978	V8-5.7L	350 CID	High Performance	US1121H
1975-1976	V8-6.6L	400 CID		US1109
1975-1976	V8-6.6L	400 CID	High Performance	US1109H
1977-1978	V8-6.6L	400 CID		US1121
1977-1978	V8-6.6L	400 CID	High Performance	US1121H
<b>K15 SUBURBAN</b>				
1975-1977	L6-4.1L	250 CID		US1110
1978	L6-4.1L	250 CID		US1107
1977-1978	V8-5.0L	305 CID		US1121
1977-1978	V8-5.0L	305 CID	High Performance	US1121H
1975-1976	V8-5.7L	350 CID		US1109
1975-1976	V8-5.7L	350 CID	High Performance	US1109H
1977-1978	V8-5.7L	350 CID		US1121
1977-1978	V8-5.7L	350 CID	High Performance	US1121H
1975-1976	V8-6.6L	400 CID		US1109
1975-1976	V8-6.6L	400 CID	High Performance	US1109H
1977-1978	V8-6.6L	400 CID		US1121
1977-1978	V8-6.6L	400 CID	High Performance	US1121H
<b>K15/K1500 PICKUP</b>				
1967-1974	L6-4.8L	292 CID		US896
1968-1969	V8-6.5L	396 CID		US981
1970-1972	V8-6.6L	402 CID		US981

Years	Engine	Disp.	Application Description	USMW
<b>K15/K1500 SUBURBAN</b>				
1967-1971	L6-4.8L	292 CID		US896
1968-1969	V8-6.5L	396 CID		US981
1970-1972	V8-6.6L	402 CID		US981
<b>K1500</b>				
1979-1984	L6-4.1L	250 CID	Base,High Sierra,Sierra Classic,Sierra Grande	US1107
1980	L6-4.8L	292 CID	Base,High Sierra,Sierra Classic,Sierra Grande	US5030
1985-1986	V6-4.3L	262 CID	Base,High Sierra,Sierra Classic	US1121
1985-1986	V6-4.3L	262 CID	High Performance; Base,High Sierra,Sierra Classic	US1121H
1988-1995	V6-4.3L	262 CID	High Performance; Sierra,Sierra SLE,Sierra SLX, Sierra Sport, Sierra SL,Sierra SLT, Sierra Special Sierra SLS	US5049H
1988-1995	V6-4.3L	262 CID	Sierra,Sierra SLE,Sierra SLX,Sierra Sport,Sierra SL, Sierra SLT,Sierra Special,Sierra SLS	US5049
1996-1998	V6-4.3L	262 CID	Sierra SL,Sierra SLE,Sierra SLT,Sierra Special	US5077
1979-1986	V8-5.0L	305 CID	Base,High Sierra,Sierra Classic,Sierra Grande	US1121
1979-1986	V8-5.0L	305 CID	High Performance; Base,High Sierra,Sierra Classic, Sierra Grande	US1121H
1988-1995	V8-5.0L	305 CID	High Performance; Sierra,Sierra SLE,Sierra SLX, Sierra Sport,High Performance; Sierra SL,Sierra SLT, Sierra Special,Sierra SLS	US5049H
1988-1995	V8-5.0L	305 CID	Sierra,Sierra SLE,Sierra SLX,Sierra Sport,Sierra SL, Sierra SLT,Sierra Special,Sierra SLS	US5049
1996-1999	V8-5.0L	305 CID	Sierra SL,Sierra SLE,Sierra SLT,Sierra Special	US5077
1979-1986	V8-5.7L	350 CID	Base,High Sierra,Sierra Classic,Sierra Grande	US1121
1979-1986	V8-5.7L	350 CID	High Performance; Base,High Sierra,Sierra Classic, Sierra Grande	US1121H
1988-1995	V8-5.7L	350 CID	High Performance; Sierra,Sierra SLE,Sierra SLX, Sierra Sport,High Performance; Sierra SL,Sierra SLT, Sierra Special,Sierra SLS	US5049H
1988-1995	V8-5.7L	350 CID	Sierra,Sierra SLE,Sierra SLX,Sierra Sport,Sierra SL ,Sierra SLT,Sierra Special,Sierra SLS	US5049
1996-1999	V8-5.7L	350 CID	Sierra SL,Sierra SLE,Sierra SLT,Sierra Special	US5077
1982-1986	V8-6.2L	379 CID	Base,High Sierra,Sierra Classic,Sierra Grande	US5008
1988-1993	V8-6.2L	379 CID	Sierra,Sierra SLE,Sierra SLX,Sierra Sport	US5062
1994-1995	V8-6.5L	395 CID	Sierra SL,Sierra SLE,Sierra SLT,Sierra Special, Sierra SLS	US5062
1996-1998	V8-6.5L	395 CID	Sierra SL,Sierra SLE,Sierra SLT,Sierra Special	US5074
1979-1980	V8-6.6L	400 CID	Base,High Sierra,Sierra Classic,Sierra Grande	US1121
1979-1980	V8-6.6L	400 CID	High Performance; Base,High Sierra,Sierra Classic, Sierra Grande	US1121H
1980	V8-7.4L	454 CID	High Performance; Base,High Sierra,Sierra Classic, Sierra Grande,Base	US1002H
<b>K1500 SUBURBAN</b>				
1979-1980	L6-4.1L	250 CID	Base,High Sierra,Sierra Classic,Sierra Grande	US1107
1979-1985	V8-5.0L	305 CID	Base,High Sierra,Sierra Classic,Sierra Grande	US1121
1979-1985	V8-5.0L	305 CID	High Performance; Base,High Sierra,Sierra Classic, Sierra Grande	US1121H
1979-1986	V8-5.7L	350 CID	Base,High Sierra,Sierra Classic,Sierra Grande	US1121
1979-1986	V8-5.7L	350 CID	High Performance; Base,High Sierra,Sierra Classic, Sierra Grande	US1121H
1992	V8-5.7L	350 CID	5.8" Hub height; Base,SLE	US5073
1992-1995	V8-5.7L	350 CID	Base,SLE,SLT	US5049
1992-1995	V8-5.7L	350 CID	High Performance; Base,SLE,SLT	US5049H
1996-1999	V8-5.7L	350 CID	Base,SLE,SLT	US5077
1982-1986	V8-6.2L	379 CID	Base,High Sierra,Sierra Classic,Sierra Grande	US5008
1995	V8-6.5L	395 CID	Base,SLE,SLT	US5062
1996-1998	V8-6.5L	395 CID	Base,SLE,SLT	US5074
1999	V8-6.5L	395 CID	Base,SLE,SLT	US5086
1979	V8-6.6L	400 CID	High Performance;;	US1121H
<b>K25</b>				
1975-1977	L6-4.8L	292 CID		US1137
1978	L6-4.8L	292 CID		US5030
1977-1978	V8-5.0L	305 CID		US1121
1977-1978	V8-5.0L	305 CID	High Performance	US1121H
1975-1976	V8-5.7L	350 CID		US1109
1975-1976	V8-5.7L	350 CID	High Performance	US1109H
1977-1978	V8-5.7L	350 CID		US1121
1977-1978	V8-5.7L	350 CID	High Performance	US1121H

Years	Engine	Disp.	Application Description	USMW
1975-1976	V8-6.6L	400 CID		US1109
1975-1976	V8-6.6L	400 CID	High Performance	US1109H
1977-1978	V8-6.6L	400 CID		US1121
1977-1978	V8-6.6L	400 CID	High Performance	US1121H
<b>K25 SUBURBAN</b>				
1975-1977	L6-4.8L	292 CID		US1137
1978	L6-4.8L	292 CID		US5030
1977-1978	V8-5.0L	305 CID		US1121
1977-1978	V8-5.0L	305 CID	High Performance	US1121H
1975-1976	V8-5.7L	350 CID		US1109
1975-1976	V8-5.7L	350 CID	High Performance	US1109H
1977-1978	V8-5.7L	350 CID		US1121
1977-1978	V8-5.7L	350 CID	High Performance	US1121H
1975-1976	V8-6.6L	400 CID		US1109
1975-1976	V8-6.6L	400 CID	High Performance	US1109H
1977-1978	V8-6.6L	400 CID		US1121
1977-1978	V8-6.6L	400 CID	High Performance	US1121H
<b>K25/K2500 PICKUP</b>				
1967-1974	L6-4.8L	292 CID		US896
1968-1969	V8-6.5L	396 CID		US981
1970-1972	V8-6.6L	402 CID		US981
<b>K25/K2500 SUBURBAN</b>				
1968-1974	L6-4.8L	292 CID		US896
1968-1969	V8-6.5L	396 CID		US981
1970-1972	V8-6.6L	402 CID		US981
<b>K2500</b>				
1980	L6-4.1L	250 CID	Base,High Sierra,Sierra Classic,Sierra Grande	US1107
1979-1986	L6-4.8L	292 CID	Base,High Sierra,Sierra Classic,Sierra Grande	US5030
1985	V6-4.3L	262 CID	High Performance; Base,High Sierra,Sierra Classic, Base	US1121H
1988-1995	V6-4.3L	262 CID	High Performance; Sierra,Sierra SLE,Sierra SLX,High Performance; Sierra SL	US5049H
1988-1995	V6-4.3L	262 CID	Sierra,Sierra SLE,Sierra SLX,Sierra SL	US5049
1988-1995	V8-5.0L	305 CID	High Performance; Sierra,Sierra SLE,Sierra SLX,High Performance; Sierra SL,Sierra SLT	US5049H
1988-1995	V8-5.0L	305 CID	Sierra,Sierra SLE,Sierra SLX,Sierra SL,Sierra SLT	US5049
1998	V8-5.0L	305 CID	Sierra SL,Sierra SLE,Sierra SLT	US5077
1979-1986	V8-5.7L	350 CID	Base,High Sierra,Sierra Classic,Sierra Grande	US1121
1979-1986	V8-5.7L	350 CID	High Performance; Base,High Sierra,Sierra Classic, Sierra Grande	US1121H
1988-1995	V8-5.7L	350 CID	High Performance; Sierra,Sierra SLE,Sierra SLX,High Performance; Sierra SL,Sierra SLT	US5049H
1988-1995	V8-5.7L	350 CID	Sierra,Sierra SLE,Sierra SLX,Sierra SL,Sierra SLT	US5049
1996-2000	V8-5.7L	350 CID	Sierra SL,Sierra SLE,Sierra SLT	US5077
1982-1986	V8-6.2L	379 CID	Base,High Sierra,Sierra Classic,Sierra Grande	US5008
1988-1993	V8-6.2L	379 CID	Sierra,Sierra SLE,Sierra SLX	US5062
1992-1995	V8-6.5L	395 CID	Sierra,Sierra SLE,Sierra SLX,Sierra SL,Sierra SLT	US5062
1996-1998	V8-6.5L	395 CID	Sierra SL,Sierra SLE,Sierra SLT	US5074
1999-2000	V8-6.5L	395 CID	Sierra SL,Sierra SLE,Sierra SLT	US5086
1979-1980	V8-6.6L	400 CID	Base,High Sierra,Sierra Classic,Sierra Grande	US1121
1979-1980	V8-6.6L	400 CID	High Performance; Base,High Sierra,Sierra Classic, Sierra Grande	US1121H
1991-2000	V8-7.4L	454 CID	High Performance; Sierra,Sierra SLE,Sierra SLX,High Performance; Sierra SL,Sierra SLT	US5038H
1991-2000	V8-7.4L	454 CID	Sierra,Sierra SLE,Sierra SLX,Sierra SL,Sierra SLT	US5038
<b>K2500 SUBURBAN</b>				
1979-1984	L6-4.8L	292 CID	Base,High Sierra,Sierra Classic,Sierra Grande	US5030
1979-1986	V8-5.7L	350 CID	Base,High Sierra,Sierra Classic,Sierra Grande	US1121
1979-1986	V8-5.7L	350 CID	High Performance; Base,High Sierra,Sierra Classic, Sierra Grande	US1121H
1992	V8-5.7L	350 CID	5.8" Hub height; Base,SLE	US5073
1992-1995	V8-5.7L	350 CID	Base,SLE,SLT	US5049
1992-1995	V8-5.7L	350 CID	High Performance; Base,SLE,SLT	US5049H
1996-1999	V8-5.7L	350 CID	Base,SLE,SLT	US5077
1982-1986	V8-6.2L	379 CID	Base,High Sierra,Sierra Classic,Sierra Grande	US5008
1994-1995	V8-6.5L	395 CID	Base,SLE,SLT	US5062
1996-1998	V8-6.5L	395 CID	Base,SLE,SLT	US5074
1999	V8-6.5L	395 CID	Base,SLE,SLT	US5086
1979-1980	V8-6.6L	400 CID	Base,High Sierra,Sierra Classic,Sierra Grande	US1121

Years	Engine	Disp.	Application Description	USMW
1979-1980	V8-6.6L	400 CID	High Performance; Base,High Sierra,Sierra Classic, Sierra Grande	US1121H
1992-1999	V8-7.4L	454 CID	Base,SLE,SLT	US5038
1992-1999	V8-7.4L	454 CID	High Performance; Base,SLE,SLT	US5038H
<b>K35</b>				
1977-1978	L6-4.8L	292 CID		US5030
1977-1978	V8-5.7L	350 CID		US1121
1977-1978	V8-5.7L	350 CID	High Performance	US1121H
1977-1978	V8-6.6L	400 CID		US1121
1977-1978	V8-6.6L	400 CID	High Performance	US1121H
<b>K35/K3500 PICKUP</b>				
1967-1974	L6-4.8L	292 CID		US896
1968-1969	V8-6.5L	396 CID		US981
1970-1972	V8-6.6L	402 CID		US981
<b>K3500</b>				
1979-1986	L6-4.8L	292 CID	Base,High Sierra,Sierra Classic,Sierra Grande	US5030
1979-1986	V8-5.7L	350 CID	Base,High Sierra,Sierra Classic,Sierra Grande	US1121
1979-1986	V8-5.7L	350 CID	High Performance; Base,High Sierra,Sierra Classic, Sierra Grande	US1121H
1988-1995	V8-5.7L	350 CID	High Performance; Sierra,Sierra SLE,Sierra SLX,High Performance; Sierra SL,Sierra SLT	US5049H
1988-1995	V8-5.7L	350 CID	Sierra,Sierra SLE,Sierra SLX,Sierra SL,Sierra SLT	US5049
1996-2000	V8-5.7L	350 CID	Sierra SL,Sierra SLE,Sierra SLT	US5077
1982-1986	V8-6.2L	379 CID	Base,High Sierra,Sierra Classic,Sierra Grande	US5008
1988-1993	V8-6.2L	379 CID	Sierra,Sierra SLE,Sierra SLX	US5062
1992-1995	V8-6.5L	395 CID	Sierra,Sierra SLE,Sierra SLX,Sierra SL,Sierra SLT	US5062
1996-1998	V8-6.5L	395 CID	Sierra SL,Sierra SLE,Sierra SLT	US5074
1999-2000	V8-6.5L	395 CID	Sierra SL,Sierra SLE,Sierra SLT	US5086
1979-1980	V8-6.6L	400 CID	Base,High Sierra,Sierra Classic,Sierra Grande	US1121
1979-1980	V8-6.6L	400 CID	High Performance; Base,High Sierra,Sierra Classic, Sierra Grande	US1121H
1980-1986	V8-7.4L	454 CID	Base,High Sierra,Sierra Classic,Sierra Grande	US1002
1980-1986	V8-7.4L	454 CID	High Performance; Base,High Sierra,Sierra Classic, Sierra Grande	US1002H
1988-2000	V8-7.4L	454 CID	High Performance; Sierra,Sierra SLE,Sierra SLX,High Performance; Sierra SL,Sierra SLT	US5038H
1988-2000	V8-7.4L	454 CID	Sierra,Sierra SLE,Sierra SLX,Sierra SL,Sierra SLT	US5038
<b>MICROBUS (MEX)</b>				
1990-1991	V8-5.7L	350 CID	4BL	US5049
1990-1991	V8-5.7L	350 CID	4BL High Performance	US5049H
<b>P15</b>				
1975-1978	L6-4.8L	292 CID		US5030
<b>P15/P1500 VAN</b>				
1967	L6-4.8L	292 CID		US896
1971-1972	V8-6.6L	400 CID		US981
<b>P1500</b>				
1979	L6-4.8L	292 CID		US5030
<b>P25</b>				
1975-1977	L6-4.8L	292 CID		US1137
1978	L6-4.8L	292 CID		US5030
1975-1976	V8-5.7L	350 CID		US1109
1975-1976	V8-5.7L	350 CID	High Performance	US1109H
1977-1978	V8-5.7L	350 CID		US1121
1977-1978	V8-5.7L	350 CID	High Performance	US1121H
<b>P25/P2500 VAN</b>				
1967-1974	L6-4.8L	292 CID		US896
1971-1972	V8-6.6L	400 CID		US981
<b>P2500</b>				
1979	L6-4.8L	292 CID		US5030
1979	V8-5.7L	350 CID	High Performance;,,	US1121H
<b>P35</b>				
1975-1977	L6-4.8L	292 CID		US1137
1978	L6-4.8L	292 CID		US5030
1975-1976	V8-5.7L	350 CID		US1109
1975-1976	V8-5.7L	350 CID	High Performance	US1109H
1977-1978	V8-5.7L	350 CID		US1121
1977-1978	V8-5.7L	350 CID	High Performance	US1121H



Years	Engine	Disp.	Application Description	USMW
<b>P35/P3500 VAN</b>				
1967-1974	L6-4.8L	292 CID		US896
1971-1972	V8-6.6L	400 CID		US981
<b>P3500</b>				
1979-1989	L6-4.8L	292 CID	Base, Value Van	US5030
1990-1995	V6-4.3L	262 CID	Base, Value Van	US1121
1990-1995	V6-4.3L	262 CID	High Performance; Base, Value Van	US1121H
1996-1999	V6-4.3L	262 CID	Base	US5077
1979-1995	V8-5.7L	350 CID	High Performance; Base, Value Van	US1121H
1979-1996	V8-5.7L	350 CID	Base, Value Van	US1121
1996-1999	V8-5.7L	350 CID	Base	US5077
1985-1993	V8-6.2L	379 CID	Base, Value Van	US5008
1994-1995	V8-6.5L	395 CID	Base	US5062
1996-1998	V8-6.5L	395 CID	Base	US5074
1999	V8-6.5L	395 CID	Base	US5086
1985-1999	V8-7.4L	454 CID	Base, Value Van	US1002
1985-1999	V8-7.4L	454 CID	High Performance; Base, Value Van	US1002H
<b>P3500 VAN (MEX)</b>				
1989-1991	V8-5.7L	350 CID	4BL	US5049
1989-1991	V8-5.7L	350 CID	4BL High Performance	US5049H
<b>PB15 SERIES</b>				
1966	L6-4.8L	292 CID		US896
<b>PB1500 SERIES</b>				
1965	L6-4.8L	292 CID		US896
<b>PB25 SERIES</b>				
1966	L6-4.8L	292 CID		US896
<b>PB2500 SERIES</b>				
1965	L6-4.8L	292 CID		US896
<b>R1500</b>				
1987	V6-4.3L	262 CID	High Performance; Base, High Sierra, Sierra Classic	US1121H
1987	V8-5.0L	305 CID	High Performance; Base, High Sierra, Sierra Classic	US1121H
1987	V8-5.7L	350 CID	High Performance; Base, High Sierra, Sierra Classic	US1121H
1987	V8-6.2L	379 CID	Base, High Sierra, Sierra Classic	US5008
<b>R1500 SUBURBAN</b>				
1987	V8-5.0L	305 CID	High Performance; Base, High Sierra, Sierra Classic	US1121H
1987-1988	V8-5.7L	350 CID	Base, High Sierra, Sierra Classic	US1121
1987-1988	V8-5.7L	350 CID	High Performance; Base, High Sierra, Sierra Classic	US1121H
1989-1991	V8-5.7L	350 CID	Base, Sierra Classic, SLE	US5049
1989-1991	V8-5.7L	350 CID	High Performance; Base, Sierra Classic, SLE	US5049H
1987	V8-6.2L	379 CID	Base, High Sierra, Sierra Classic	US5008
1988-1991	V8-6.2L	379 CID	Base, Sierra Classic, SLE	US5062
<b>R2500</b>				
1987-1988	L6-4.8L	292 CID	Base, High Sierra, Sierra Classic	US5030
1987	V6-4.3L	262 CID	High Performance; Base, High Sierra, Sierra Classic	US1121H
1987	V8-5.0L	305 CID	High Performance; Base, High Sierra, Sierra Classic	US1121H
1987-1989	V8-5.7L	350 CID	Base, High Sierra, Sierra Classic	US1121
1987-1989	V8-5.7L	350 CID	High Performance; Base, High Sierra, Sierra Classic	US1121H
1987-1989	V8-6.2L	379 CID	Base, High Sierra, Sierra Classic	US5008
1987-1989	V8-7.4L	454 CID	Base, High Sierra, Sierra Classic	US1002
1987-1989	V8-7.4L	454 CID	High Performance; Base, High Sierra, Sierra Classic	US1002H
<b>R2500 SUBURBAN</b>				
1987-1988	V8-5.7L	350 CID	Base, High Sierra, Sierra Classic	US1121
1987-1988	V8-5.7L	350 CID	High Performance; Base, High Sierra, Sierra Classic	US1121H
1989-1991	V8-5.7L	350 CID	Base, Sierra Classic, SLE	US5049
1989-1991	V8-5.7L	350 CID	High Performance; Base, Sierra Classic, SLE	US5049H
1987	V8-6.2L	379 CID	Base, High Sierra, Sierra Classic	US5008
1988-1991	V8-6.2L	379 CID	Base, Sierra Classic, SLE	US5062
1987-1988	V8-7.4L	454 CID	Base, High Sierra, Sierra Classic	US1002
1987-1988	V8-7.4L	454 CID	High Performance; Base, High Sierra, Sierra Classic	US1002H
1989-1991	V8-7.4L	454 CID	Base, Sierra Classic, SLE	US5038
1989-1991	V8-7.4L	454 CID	High Performance; Base, Sierra Classic, SLE	US5038H
<b>R3500</b>				
1987-1988	L6-4.8L	292 CID	Base, High Sierra, Sierra Classic	US5030
1987-1991	V8-5.7L	350 CID	Base, High Sierra, Sierra Classic, SLE	US1121
1987-1991	V8-5.7L	350 CID	High Performance; Base, High Sierra, Sierra Classic, SLE	US1121H
1987-1991	V8-6.2L	379 CID	Base, High Sierra, Sierra Classic, SLE	US5008
1987-1991	V8-7.4L	454 CID	Base, High Sierra, Sierra Classic, SLE	US1002

Years	Engine	Disp.	Application Description	USMW
1987-1991	V8-7.4L	454 CID	High Performance; Base, High Sierra, Sierra Classic, SLE	US1002H
<b>S15</b>				
1982-1985	L4-1.9L	119 CID	Base, High Sierra, Sierra Classic, Sierra Grande	US5013
1983-1984	L4-2.0L	122 CID	Base, High Sierra, Sierra Classic	US5015
1985-1986	L4-2.5L	151 CID	Base, High Sierra, Sierra Classic, Gypsy	US5022
1987-1990	L4-2.5L	151 CID	Base, EL, Gypsy, High Sierra, Sierra Classic	US5040
1982-1986	V6-2.8L	173 CID	Base, High Sierra, Sierra Classic, Sierra Grande, Gypsy	US5006
1987-1990	V6-2.8L	173 CID	Base, EL, Gypsy, High Sierra, Sierra Classic	US5035
1988-1990	V6-4.3L	262 CID	Base, Gypsy, High Sierra, Sierra Classic	US5049
1988-1990	V6-4.3L	262 CID	High Performance; Base, Gypsy, High Sierra, Sierra Classic	US5049H
<b>S15 JIMMY</b>				
1983-1984	L4-1.9L	119 CID	Base, Gypsy, Sierra Classic	US5013
1983-1984	L4-2.0L	122 CID	Base, Gypsy, Sierra Classic	US5015
1985-1986	L4-2.5L	151 CID	Base, Gypsy, High Sierra, Sierra Classic	US5022
1987-1988	L4-2.5L	151 CID	Base, Gypsy, High Country, Sierra Classic, Timberline	US5040
1983-1986	V6-2.8L	173 CID	Base, Gypsy, Sierra Classic, High Sierra	US5006
1987-1989	V6-2.8L	173 CID	Base, Gypsy, High Country, Sierra Classic, Timberline	US5035
1988-1991	V6-4.3L	262 CID	Base, Gypsy, Sierra Classic, Timberline, SLE, SLS, SLT	US5049
1988-1991	V6-4.3L	262 CID	High Performance; Base, Gypsy, Sierra Classic, Timberline, SLE, SLS, SLT	US5049H
<b>SAFARI</b>				
1985-1986	L4-2.5L	151 CID	Base, SL, SLE, SLX	US5022
1987-1990	L4-2.5L	151 CID	Base, SL, SLE, SLT, SLX	US5040
1985-1986	V6-4.3L	262 CID	Base, SL, SLE, SLX	US1121
1985-1986	V6-4.3L	262 CID	High Performance; Base, SL, SLE, SLX	US1121H
1987-1995	V6-4.3L	262 CID	Base, SL, SLE, SLT, SLX, GT	US5049
1987-1995	V6-4.3L	262 CID	High Performance; Base, SL, SLE, SLT, SLX, GT	US5049H
1996-2005	V6-4.3L	262 CID	Base, SL, SLE, SLT, SLX	US5077
<b>SAVANA 1500</b>				
1996-2011	V6-4.3L	262 CID	Base, SLE, SLT, LLS, LT	US5077
1996-2002	V8-5.0L	305 CID	Base, SLE, SLT	US5077
2003	V8-5.3L	323 CID	Base, SLE	US5087
2004-2005	V8-5.3L	323 CID	Base, SLE	US64
2004-2005	V8-5.3L	323 CID	Includes thermostat and thermostat housing; Base, SLE	US64-T
2006	V8-5.3L	325 CID	Includes thermostat and thermostat housing; Base, LS, LT	US64-T
2007-2011	V8-5.3L	325 CID	Base, LS, LT	US6009
1996-2002	V8-5.7L	350 CID	Base, SLE, SLT	US5077
<b>SAVANA 2500</b>				
1996-2005	V6-4.3L	262 CID	Base, SLE, SLT	US5077
2003	V8-4.8L	294 CID	Base, SLE	US5087
2004-2006	V8-4.8L	294 CID	Base, SLE	US64
2004-2006	V8-4.8L	294 CID	Includes thermostat and thermostat housing; Base, SLE	US64-T
2007-2011	V8-4.8L	294 CID	Base	US6009
1996-2002	V8-5.0L	305 CID	Base, SLE, SLT	US5077
2003	V8-5.3L	323 CID	Base, SLE	US5087
2004-2005	V8-5.3L	323 CID	Base, SLE	US64
2004-2005	V8-5.3L	323 CID	Includes thermostat and thermostat housing; Base, SLE	US64-T
1996-2002	V8-5.7L	350 CID	Base, SLE, SLT	US5077
2003	V8-6.0L	364 CID	Base, SLE	US5087
2004-2006	V8-6.0L	364 CID	Base, SLE	US64
2004-2006	V8-6.0L	364 CID	Includes thermostat and thermostat housing; Base, SLE	US64-T
2007-2011	V8-6.0L	364 CID	Base, LS, LT	US6009
1996-1998	V8-6.5L	395 CID	Base, SLE	US5074
1999-2002	V8-6.5L	395 CID	Base, SLE, SLT	US5086
2006-2011	V8-6.6L	400 CID	Base	US72
<b>SAVANA 3500</b>				
2004-2006	V8-4.8L	294 CID	Base, SLE	US64
2004-2006	V8-4.8L	294 CID	Includes thermostat and thermostat housing; Base, SLE	US64-T
2007-2011	V8-4.8L	294 CID	Base	US6009
1996-2002	V8-5.7L	350 CID	Base, SLE, SLT	US5077
2003	V8-6.0L	364 CID	Base, SLE	US5087

Years	Engine	Disp.	Application Description	USMW
2004-2006	V8-6.0L	364 CID	Base,SLE,LS,LT	US64
2004-2006	V8-6.0L	364 CID	Includes thermostat and thermostat housing; Base,SLE,LS,LT	US64-T
2007-2011	V8-6.0L	364 CID	Base,LS,LT	US6009
1996-1998	V8-6.5L	395 CID	Base,SLE	US5074
1999-2002	V8-6.5L	395 CID	Base,SLE,SLT	US5086
2006-2011	V8-6.6L	400 CID	Base	US72
1996-2000	V8-7.4L	454 CID	Base,SLE	US5038
1996-2000	V8-7.4L	454 CID	High Performance; Base,SLE	US5038H
2001-2002	V8-8.1L	496 CID	Base,SLT	US5090
<b>SIERRA (MEX)</b>				
2010-2012	V8-5.3L	323 CID	SFI OHV ; 4WD	US6009
2009	V8-6.2L	378 CID	SFI OHV ; 4WD	US6009
<b>SIERRA 1500</b>				
1999-2011	V6-4.3L	262 CID	SL,SLE,SLT,Base,HT,WT,Classic SL,Classic WT	US5077
1999-2006	V8-4.8L	294 CID	Includes thermostat and thermostat housing; SL,SLE,SLT,Base,HT,WT	US64-T
1999-2006	V8-4.8L	294 CID	SL,SLE,SLT,Base,HT,WT	US64
2007-2011	V8-4.8L	294 CID	Classic SL,Classic SLE,Classic WT,SLE,WT,SL	US6009
1999-2003	V8-5.3L	323 CID	SL,SLE,SLT,Base,HT,WT	US5087
2004-2005	V8-5.3L	323 CID	Base,SLE,SLT,WT	US64
2004-2005	V8-5.3L	323 CID	Includes thermostat and thermostat housing; Base,SLE,SLT,WT	US64-T
2006	V8-5.3L	325 CID	Includes thermostat and thermostat housing; SL,SLE,SLT,WT,SL	US64-T
2007-2011	V8-5.3L	325 CID	Classic SL,Classic SLE,Classic SLT,Classic WT,SLE,SLT,WT,SL,XFE	US6009
2005-2006	V8-6.0L	364 CID	Hybrid,SLE,SLT	US64
2005-2006	V8-6.0L	364 CID	Includes thermostat and thermostat housing; Hybrid,SLE,SLT	US64-T
2007-2011	V8-6.0L	364 CID	Classic Hybrid,Classic SLE,Classic SLT,SLE,SLT,SL,Hybrid	US6009
2009-2011	V8-6.2L	376 CID	SLT,SLE	US6009
<b>SIERRA 1500 HD</b>				
2001	V8-6.0L	364 CID	SLE,SLT	US5087
2002-2006	V8-6.0L	364 CID	Includes thermostat and thermostat housing; SLE,SLT	US64-T
2002-2006	V8-6.0L	364 CID	SLE,SLT	US64
2007	V8-6.0L	364 CID	Classic SLE,Classic SLT	US6009
<b>SIERRA 2500</b>				
1999-2000	V8-5.3L	323 CID	SL,SLE,SLT	US5087
1999-2001	V8-6.0L	364 CID	SL,SLE,SLT	US5087
2002-2004	V8-6.0L	364 CID	Base,SL,SLE,SLT,WT	US64
2002-2004	V8-6.0L	364 CID	Includes thermostat and thermostat housing; Base,SL,SLE,SLT,WT	US64-T
<b>SIERRA 2500 HD</b>				
2001	V8-6.0L	364 CID	SL,SLE,SLT	US5087
2002-2006	V8-6.0L	364 CID	Base,SL,SLE,SLT,WT	US64
2002-2006	V8-6.0L	364 CID	Includes thermostat and thermostat housing; Base,SL,SLE,SLT,WT	US64-T
2007-2011	V8-6.0L	364 CID	Classic SL,Classic SLE,Classic SLT,Classic WT,SLE,SLT,WT,Denali	US6009
2001-2005	V8-6.6L	400 CID	SL,SLE,SLT,Base,WT	US63
2004	V8-6.6L	403 CID	Base,SLE,SLT,WT	US63
2006-2011	V8-6.6L	400 CID	SL,SLE,SLT,WT,Classic SL,Classic SLE,Classic SLT,Classic WT,Denali	US72
2001-2007	V8-8.1L	496 CID	SL,SLE,SLT,Base,WT,Classic SL,Classic SLE,Classic SLT,Classic WT	US5089
<b>SIERRA 3500</b>				
2001	V8-6.0L	364 CID	SL,SLE,SLT	US5087
2002-2006	V8-6.0L	364 CID	Base,SL,SLE,SLT,WT	US64
2002-2006	V8-6.0L	364 CID	Includes thermostat and thermostat housing; Base,SL,SLE,SLT,WT	US64-T
2007	V8-6.0L	364 CID	Classic SL,Classic SLE,Classic SLT,Classic WT	US6009
2001-2005	V8-6.6L	400 CID	SL,SLE,SLT,Base,WT	US63
2004	V8-6.6L	403 CID	Base,SLE,SLT,WT	US63
2006-2007	V8-6.6L	400 CID	SL,SLE,SLT,WT,Classic SL,Classic SLE,Classic SLT,Classic WT	US72
2001-2007	V8-8.1L	496 CID	SL,SLE,SLT,Base,WT,Classic SL,Classic SLE,Classic SLT,Classic WT	US5089

Years	Engine	Disp.	Application Description	USMW
<b>SIERRA 3500 HD</b>				
2007-2011	V8-6.0L	364 CID	SLE,SLT,WT	US6009
2007-2011	V8-6.6L	400 CID	SLE,SLT,WT	US72
<b>SIERRA C3</b>				
2001	V8-6.0L	364 CID	Base	US5087
<b>SONOMA</b>				
1994-2003	L4-2.2L	134 CID	SL,SLE,SLS	US5032
1991-1993	L4-2.5L	151 CID	Base,SLE,SLS	US5040
1991-1993	V6-2.8L	173 CID	Base,SLE,GT,SLS	US5035
1991-1995	V6-4.3L	262 CID	Base,SLE,GT,SLS,SL	US5049
1991-1995	V6-4.3L	262 CID	High Performance; Base,SLE,GT,SLS,SL	US5049H
1996-2004	V6-4.3L	262 CID	SL,SLE,SLS	US5077
<b>SPRINT</b>				
1975	L6-4.1L	250 CID		US895
1977	L6-4.1L	250 CID		US1107
1977	V8-5.0L	305 CID	High Performance	US1121H
1977	V8-5.7L	350 CID	High Performance	US1121H
<b>SUBURBAN</b>				
1965-1967	L6-4.8L	292 CID		US896
<b>SYCLONE</b>				
1991	V6-4.3L	262 CID	High Performance; Base	US5049H
<b>TERRAIN</b>				
2010-2013	L4-2.4L	145 CID	SLE,SLT,	US5092
2010-2011	V6-3.0L	182 CID	SLE,SLT	US8932
<b>TYPHOON</b>				
1992-1993	V6-4.3L	262 CID	Base	US5049
1992-1993	V6-4.3L	262 CID	High Performance; Base	US5049H
<b>V1500</b>				
1987	V6-4.3L	262 CID	High Performance; Base,High Sierra,Sierra Classic	US1121H
1987	V8-5.0L	305 CID	High Performance; Base,High Sierra,Sierra Classic	US1121H
1987	V8-5.7L	350 CID	High Performance; Base,High Sierra,Sierra Classic	US1121H
1987	V8-6.2L	379 CID	Base,High Sierra,Sierra Classic	US5008
<b>V1500 SUBURBAN</b>				
1987-1988	V8-5.7L	350 CID	Base,High Sierra,Sierra Classic	US1121
1987-1988	V8-5.7L	350 CID	High Performance; Base,High Sierra,Sierra Classic	US1121H
1989-1991	V8-5.7L	350 CID	Base,Sierra Classic,SLE	US5049
1989-1991	V8-5.7L	350 CID	High Performance; Base,Sierra Classic,SLE	US5049H
1987	V8-6.2L	379 CID	Base,High Sierra,Sierra Classic	US5008
1988-1991	V8-6.2L	379 CID	Base,Sierra Classic,SLE	US5062
<b>V2500</b>				
1987	L6-4.8L	292 CID	Base,High Sierra,Sierra Classic	US5030
1987	V8-5.7L	350 CID	High Performance; Base,High Sierra,Sierra Classic	US1121H
1987	V8-6.2L	379 CID	Base,High Sierra,Sierra Classic	US5008
<b>V2500 SUBURBAN</b>				
1987-1988	V8-5.7L	350 CID	Base,High Sierra,Sierra Classic	US1121
1987-1988	V8-5.7L	350 CID	High Performance; Base,High Sierra,Sierra Classic	US1121H
1989-1991	V8-5.7L	350 CID	Base,Sierra Classic,SLE	US5049
1989-1991	V8-5.7L	350 CID	High Performance; Base,Sierra Classic,SLE	US5049H
1987	V8-6.2L	379 CID	Base,High Sierra,Sierra Classic	US5008
1988-1991	V8-6.2L	379 CID	Base,Sierra Classic,SLE	US5062
<b>V3500</b>				
1987-1988	L6-4.8L	292 CID	Base,High Sierra,Sierra Classic	US5030
1987-1991	V8-5.7L	350 CID	Base,High Sierra,Sierra Classic,SLE	US1121
1987-1991	V8-5.7L	350 CID	High Performance; Base,High Sierra,Sierra Classic,SLE	US1121H
1987-1991	V8-6.2L	379 CID	Base,High Sierra,Sierra Classic,SLE	US5008
1987-1991	V8-7.4L	454 CID	Base,High Sierra,Sierra Classic,SLE	US1002
1987-1991	V8-7.4L	454 CID	High Performance; Base,High Sierra,Sierra Classic,SLE	US1002H
<b>YUKON</b>				
2000-2006	V8-4.8L	294 CID	Includes thermostat and thermostat housing; SLE,SLT,SL	US64-T
2000-2006	V8-4.8L	294 CID	SLE,SLT,SL	US64
2007-2009	V8-4.8L	294 CID	SLE	US6009
2000-2003	V8-5.3L	323 CID	SLE,SLT,Denali	US5087
2004-2005	V8-5.3L	323 CID	Includes thermostat and thermostat housing; SLE,SLT	US64-T
2004-2005	V8-5.3L	323 CID	SLE,SLT	US64
2005-2006	V8-5.3L	325 CID	Includes thermostat and thermostat housing; SLE,SLT,SL	US64-T

Years	Engine	Disp.	Application Description	USMW
2005-2006	V8-5.3L	325 CID	SLE,SLT,SL	US64
2007-2011	V8-5.3L	325 CID	SLE,SLT	US6009
1992-1995	V8-5.7L	350 CID	Base,SLE,Sport,GT,SLT	US5049
1992-1995	V8-5.7L	350 CID	High Performance; Base,SLE,Sport,GT,SLT	US5049H
1996-1999	V8-5.7L	350 CID	SL,SLE,SLT	US5077
2002-2006	V8-6.0L	364 CID	Denali	US64
2002-2006	V8-6.0L	364 CID	Includes thermostat and thermostat housing; Denali	US64-T
2008-2011	V8-6.0L	364 CID	Hybrid,Denali Hybrid	US6009
2007-2008	V8-6.2L	378 CID	Denali	US6009
2009-2011	V8-6.2L	376 CID	Denali	US6009
1994-1995	V8-6.5L	395 CID	Base,SLE,Sport,SLT	US5062
1996-1997	V8-6.5L	395 CID	SL,SLE,SLT	US5074
<b>YUKON DENALI AWD (MEX)</b>				
2009	V8-6.2L	378 CID	SFI OHV	US6009
<b>YUKON XL 1500</b>				
2000-2003	V8-5.3L	323 CID	SLE,SLT,Denali	US5087
2004-2006	V8-5.3L	323 CID	Includes thermostat and thermostat housing; SLE,SLT,SL	US64-T US64
2004-2006	V8-5.3L	323 CID	SLE,SLT,SL	US64
2007-2011	V8-5.3L	325 CID	SLE,SLT	US6009
2002-2006	V8-6.0L	364 CID	Denali	US64
2002-2006	V8-6.0L	364 CID	Includes thermostat and thermostat housing; Denali	US64-T
2007-2009	V8-6.0L	364 CID	SLE,SLT	US6009
2007-2011	V8-6.2L	376 CID	Denali,SLT	US6009
<b>YUKON XL 2500</b>				
2000-2001	V8-6.0L	364 CID	SLE,SLT	US5087
2002-2006	V8-6.0L	364 CID	Includes thermostat and thermostat housing; SLE,SLT	US64-T
2002-2006	V8-6.0L	364 CID	SLE,SLT	US64
2007-2011	V8-6.0L	364 CID	SLE,SLT	US6009
2001-2006	V8-8.1L	496 CID	SLE,SLT	US5089
<b>HONDA</b>				
<b>ACCORD</b>				
1976-1978	L4-1.6L	1599cc		US9034
1979	L4-1.8L	1751cc		US9034
1980-1981	L4-1.8L	1751cc	Base,LX,SE	US9029
1982-1983	L4-1.8L	1751cc	Base,LX,SE	US9035
1984-1985	L4-1.8L	1829cc	Late; Base,LX,Base,S,SEi	US9056
1986-1989	L4-2.0L	1955cc	DX,LX,LXi,SEi	US9083
1990-1997	L4-2.2L	2156cc	DX,EX,LX,SE,10th Anniversary,25th Anniversary Edition,Value Package	US9209
1998-2002	L4-2.3L	2254cc	DX,EX,LX,SE,Value Package	US9209
2003-2007	L4-2.4L	2354cc		US9461
2007	L4-2.4L	2354cc	Exc.Japan Built; Value Package	US9434
2008-2012	L4-2.4L	2354cc	EX,EX-L,LX,LX-P,LX-S,SE	US6233
1995-1997	V6-2.7L	2675cc	EX,LX	US9097
1998-2002	V6-3.0L	2997cc	EX,LX	US9383
2003-2006	V6-3.0L	2977cc	EX,LX,Hybrid	US9470
2007	V6-3.0L	2997cc	EX,Hybrid,LX,Special Edition	US9470
2008-2011	V6-3.5L	3471cc	EX,EX-L	US9470
2008-2012	V6-3.5L	3471cc	EX,EX-L	US9434
<b>ACCORD CROSSTOUR</b>				
2010-2011	V6-3.5L	3471cc	EX,EX-L	US9434
<b>ACCORD EX (MEX)</b>				
2013	V6-3.5L	212 CID	VTEC SOHC	US9470
<b>CIVIC</b>				
1975-1977	L4-1.2L	1237cc		US9033N
1980-1983	L4-1.3L	1335cc	1300,1300 DX,1300 FE	US9043N
1985-1987	L4-1.3L	1342cc	Base	US9069
2003-2011	L4-1.3L	1339cc	Hybrid,Hybrid-L	US6216
1975-1979	L4-1.5L	1487cc		US9034
1980-1983	L4-1.5L	1487cc	1500,1500 DX,1500 GL,Base,Wagovan,1500 S	US9035
1984-1987	L4-1.5L	1487cc	1500 S,Base,CRX,CRX 1.5,DX,CRX HF,CRX Si,Si	US9069
1986	L4-1.5L	1493cc	Base,CRX,CRX HF,CRX Si,Si	US9069
1988-1995	L4-1.5L	1493cc	Base,DX,LX,Wagovan,RT 4WD,CX	US9130
1992-1995	L4-1.5L	1493cc	VX	US9250
1988-1991	L4-1.6L	1590cc	RT 4WD,Si,EX	US9130
1992-1995	L4-1.6L	1590cc	EX,Si	US9250
1996-2000	L4-1.6L	1590cc	CX,DX,EX,HX,LX,GX,Value Package	US9352

Years	Engine	Disp.	Application Description	USMW
1999-2000	L4-1.6L	1595cc	Si	US9468
2001-2005	L4-1.7L	1668cc	DX,EX,GX,HX,LX,Value Package	US9419
2002-2004	L4-1.7L	1700cc	DX,EX,GX,HX,LX,Value Package	US9419
2006-2011	L4-1.8L	1799cc	DX,EX,GX,LX,EX-L	US6056
2002-2005	L4-2.0L	1998cc	Si	US9434
2006-2011	L4-2.0L	1998cc	Si,MUGEN Si	US9495
<b>CIVIC DEL SOL</b>				
1993-1995	L4-1.5L	1493cc	S	US9130
1993-1995	L4-1.6L	1590cc	Si	US9130
1994-1995	L4-1.6L	1590cc	VTEC	US9321
1996-1997	L4-1.6L	1590cc	S,Si	US9352
1996-1997	L4-1.6L	1595cc	VTEC	US9468
<b>CROSSTOUR</b>				
2012	V6-3.5L	3471cc	EX,EX-L	US9434
<b>CR-V</b>				
1997-2001	L4-2.0L	1972cc	LX,EX,SE	US9349
2002-2006	L4-2.4L	2354cc	EX,LX,SE	US9434
2007-2009	L4-2.4L	2354cc		US9461
2010-2011	L4-2.4L	2354cc	EX,EX-L,LX,SE	US6233
<b>CRX</b>				
1988-1991	L4-1.5L	1493cc	DX,HF,Base	US9130
1988-1991	L4-1.6L	1590cc	Si	US9130
<b>CR-Z</b>				
2011-2013	L4-1.5L	1497cc	Base,EX,	US8983
<b>ELEMENT</b>				
2003-2011	L4-2.4L	2354cc		US9461
<b>FIT</b>				
2007-2008	L4-1.5L	1497cc	Base,Sport	US6018
2009-2013	L4-1.5L	1497cc	Base,Sport,	US6350
<b>FIT (MEX)</b>				
2006	L4-1.5L	91 CID	VTEC SOHC	US6018
<b>INSIGHT</b>				
2000-2006	L3-1.0L	995cc	Base	US9494
2010-2013	L4-1.3L	1339cc	EX,LX,Base,	US8983
<b>ODYSSEY</b>				
1995-1997	L4-2.2L	2156cc	EX,LX	US9209
1998	L4-2.3L	2234cc	EX,LX	US9209
1999-2004	V6-3.5L	3474cc	Cargo,EX,LX,EX-L	US9383
2005-2012	V6-3.5L	3471cc	EX,EX-L,LX,Touring,Touring Elite	US9470
<b>PASSPORT</b>				
1994-1996	L4-2.6L	2559cc	DX	US9133
1994-1997	V6-3.2L	3165cc	EX,LX	US9278
1998-2002	V6-3.2L	3165cc	EX,LX	US9365
<b>PILOT</b>				
2003-2004	V6-3.5L	3475cc	EX,LX	US9383
2005-2012	V6-3.5L	3471cc	EX,LX,EX-L,Special Edition,Value Package,Touring	US9470
<b>PRELUDE</b>				
1979	L4-1.8L	1751cc		US9034
1980-1981	L4-1.8L	1751cc	Base	US9029
1982	L4-1.8L	1751cc	Base	US9035
1983-1987	L4-1.8L	1829cc	Base	US9056
1985-1987	L4-2.0L	1955cc	2.0 Si	US9083
1988-1990	L4-2.0L	1958cc	2.0 S	US9131
1988-1991	L4-2.0L	1958cc	2.0 Si,2.0 Si 4WS	US9129
1990-1991	L4-2.1L	2056cc	Si,Si 4WS,Si ALB	US9129
1992-1996	L4-2.2L	2156cc	S	US9209
1993-2001	L4-2.2L	2156cc	VTEC,Base,Type SH	US9273
1992-1996	L4-2.3L	2259cc	Si,Si 4WS,SE	US9251
<b>RIDGELINE</b>				
2006-2012	V6-3.5L	3471cc	RT,RTL,RTS,RTX,Sport	US9470
<b>S2000</b>				
2000-2003	L4-2.0L	1997cc	Base	US9403
2004-2009	L4-2.2L	2157cc	Base,CR	US9403
<b>WAGOVAN</b>				
1984-1987	L4-1.5L	1487cc	DX	US9069



Years	Engine	Disp.	Application Description	USMW
<b>HUMMER</b>				
<b>H1</b>				
2002-2004	V8-6.5L	395 CID		US5086
<b>H2</b>				
2008-2009	V8-5.3L	325 CID	Base	US6009
2003	V8-6.0L	364 CID	Base	US5087
2004-2006	V8-6.0L	364 CID	Base	US64
2004-2006	V8-6.0L	364 CID	Includes thermostat and thermostat housing; Base	US64-T
2007	V8-6.0L	364 CID	Base	US6009
<b>H3</b>				
2006	L5-3.5L	211 CID	Base	US5097
2007-2010	L5-3.7L	223 CID	Base,X	US5097
2008-2010	V8-5.3L	325 CID	Alpha,Championship Series	US6009
<b>H3T</b>				
2009-2010	L5-3.7L	223 CID	Base	US5097
2009-2010	V8-5.3L	325 CID	Alpha	US6009
<b>HYUNDAI</b>				
<b>ACCENT</b>				
1995-1999	L4-1.5L	1495cc	Base,L,GL,GS,GSi	US7115
1996-1997	L4-1.5L	1495cc	GT	US9364
2002-2005	L4-1.6L	1600cc	From 04/12/02; GL,GL,GS,Base,GT,GLS	US9364
2006-2011	L4-1.6L	1599cc	GLS,GS,SE,Blue,GL	US9364
<b>ATOS</b>				
1998-2007	L4-1.0L	999cc		US8935
<b>AZERA</b>				
2007-2013	V6-3.3L	3342cc	GLS,From 11/03/09; GLS,	US6048
2006-2010	V6-3.8L	3778cc	From 05/22/06; Limited,Limited,SE,From 11/03/09; Limited	US6048
<b>ELANTRA</b>				
1992-1995	L4-1.6L	1596cc	Base,GL,GLS	US7131
1993-1995	L4-1.8L	1836cc	Base,GLS	US9212
1996-1998	L4-1.8L	1795cc	Base,GL,GLS	US9353
1999-2012	L4-2.0L	1975cc	GL,GLS,GT,Limited,SE,Touring,Blue,Touring GLS, Touring SE	US9353
<b>ENTOURAGE</b>				
2007-2008	V6-3.8L	3778cc	From 05/22/06; GLS,GLS,Limited,SE	US6048
<b>EXCEL</b>				
1986-1994	L4-1.5L	1468cc	Base,GL,GLS,GS	US7115
<b>GENESIS</b>				
2009-2013	V6-3.8L	3778cc	3.8	US6048
<b>GENESIS COUPE</b>				
2010-2013	V6-3.8L	3778cc	3.8,3.8 Grand Touring,3.8 Track,3.8 R-Spec	US6048
<b>H100</b>				
1997-2007	L4-2.5L	2477cc		US8922
<b>H200</b>				
1997-2007	L4-2.5L	2477cc		US8922
<b>SANTA FE</b>				
2001-2004	L4-2.4L	2351cc	GL,Base	US9399
2010-2012	L4-2.4L	2359cc	GLS,Limited,To 08/04/2010; GLS,	US6220
2001-2006	V6-2.7L	2656cc	GL,GLS,LX,Base	US9462
2007-2009	V6-2.7L	2656cc	GLS	US6215
2007-2009	V6-3.3L	3342cc	From 01/29/07; Limited,Limited,SE	US6048
2003-2005	V6-3.5L	3500cc	GLS,LX	US9463
2006	V6-3.5L	3467cc	GLS,Limited	US9463
2010-2012	V6-3.5L	3470cc	Limited,SE,GLS	US6048
<b>SCOUPÉ</b>				
1991-1995	L4-1.5L	1468cc	Base,LS,Turbo	US7115
<b>SONATA</b>				
1992-1998	L4-2.0L	1997cc	Base,GLS,GL	US9212
2011-2013	L4-2.0L	1998cc	Limited,SE,	US8982
1989-1991	L4-2.4L	2351cc	Base,GLS	US7118
1999-2005	L4-2.4L	2351cc	Base,GL	US9399
2006-2010	L4-2.4L	2359cc	GL,GLS,Limited,SE	US6220
2011-2013	L4-2.4L	2359cc	GLS,Limited,SE,	US8982
1999-2001	V6-2.5L	2493cc	GLS	US9462
2002-2005	V6-2.7L	2656cc	GLS,LX,GL	US9462

Years	Engine	Disp.	Application Description	USMW
1990-1998	V6-3.0L	2972cc	Base,GLS,GL	US7121
2006-2010	V6-3.3L	3342cc	GLS,LX,From 05/22/06; Limited,Limited,SE	US6048
<b>TIBURON</b>				
1997	L4-1.8L	1795cc	Base	US9353
1997-2008	L4-2.0L	1975cc	FX,Base,GS	US9353
2003-2008	V6-2.7L	2656cc	GT,SE,GT Limited	US9462
<b>TUCSON</b>				
2005-2009	L4-2.0L	1975cc	GL,GLS,Limited	US9353
2011	L4-2.0L	1975cc	GL	US6220
2010-2011	L4-2.4L	2359cc	GLS,Limited	US6220
2005-2009	V6-2.7L	2656cc	GLS,LX,Limited,SE	US9462
<b>VERACRUZ</b>				
2007-2012	V6-3.8L	3778cc	GLS,Limited,SE,From 11/03/09; GLS	US6048
<b>XG300</b>				
2001	V6-3.0L	2972cc	Base,L	US9463
<b>XG350</b>				
2002-2005	V6-3.5L	3500cc	Base,L	US9463
<b>INFINITI</b>				
<b>EX35</b>				
2008-2012	V6-3.5L	3498cc	Base,Journey	US9426
<b>FX35</b>				
2003-2012	V6-3.5L	3498cc	Base,To 03/07; Base	US9426
<b>FX50</b>				
2009-2012	V8-5.0L	5026cc	Base	US9488
<b>G20</b>				
1991-1996	L4-2.0L	1998cc	Base,T	US9213
1999-2002	L4-2.0L	2000cc	Base,T	US9213
<b>G25</b>				
2011-2012	V6-2.5L	2496cc	Base,Journey,X	US6198
<b>G35</b>				
2003-2008	V6-3.5L	3498cc	Base,X,Journey,Sport	US9426
2007	V6-3.5L	3498cc	From 03/07; Base	US6198
<b>G37</b>				
2008-2012	V6-3.7L	3696cc	Base,Journey,Sport,X,IPL	US9426
<b>I30</b>				
1996-2001	V6-3.0L	2988cc	Base,T	US9309
<b>I35</b>				
2002-2004	V6-3.5L	3498cc	Base	US9426
<b>J30</b>				
1993-1997	V6-3.0L	2960cc	Base,T	US9268
<b>M30</b>				
1990-1992	V6-3.0L	2960cc	Base	US9058
<b>M35</b>				
2006-2010	V6-3.5L	3498cc	Base,Sport,X,To 03/07; Base	US9426
2007-2008	V6-3.5L	3498cc	From 03/07; Base,Sport,X,Base	US6198
<b>M35H</b>				
2012	V6-3.5L	3498cc	Base	US9426
<b>M37</b>				
2011-2012	V6-3.7L	3696cc	Base,X	US9426
<b>M56</b>				
2011-2012	V8-5.6L	5552cc	Base,X	US9488
<b>Q45</b>				
1997-2001	V8-4.1L	4130cc	Base,T,Anniversary Edition	US9388
1990-1992	V8-4.5L	4494cc	Base,A	US9239
1993-1996	V8-4.5L	4494cc	From 02/93; A,Base,A,T	US9304
<b>QX4</b>				
1997-2000	V6-3.3L	3275cc	Base	US9338
2001-2003	V6-3.5L	3498cc	Base	US9309
<b>QX56</b>				
2004-2012	V8-5.6L	5552cc	Base	US9488
<b>INTERNATIONAL</b>				
<b>100</b>				
1974	V8-5.0L	304 CID		US1099
1974	V8-5.6L	345 CID		US1099
1974	V8-6.4L	392 CID		US1099



# WATER PUMP APPLICATION GUIDE



Years	Engine	Disp.	Application Description	USMW
<b>150</b>				
1975	V8-5.0L	304 CID		US1099
1975	V8-5.6L	345 CID		US1099
1975	V8-6.4L	392 CID		US1099
<b>200</b>				
1974-1975	V8-5.0L	304 CID		US1099
1974-1975	V8-5.6L	345 CID		US1099
1974-1975	V8-6.4L	392 CID		US1099
<b>1010</b>				
1971-1973	V8-5.0L	304 CID		US1099
1971-1973	V8-5.6L	345 CID		US1099
1971-1973	V8-5.7L	345 CID		US1099
1971-1973	V8-6.4L	392 CID		US1099
<b>1110</b>				
1971-1972	V8-4.3L	266 CID		US1099
1971-1973	V8-5.0L	304 CID		US1099
1971-1973	V8-5.6L	345 CID		US1099
1971-1973	V8-5.7L	345 CID		US1099
1971-1973	V8-6.4L	392 CID		US1099
<b>1210</b>				
1971-1973	V8-5.0L	304 CID		US1099
1971-1973	V8-5.6L	345 CID		US1099
1971-1973	V8-5.7L	345 CID		US1099
1971-1973	V8-6.4L	392 CID		US1099
<b>1310</b>				
1971-1972	V8-4.3L	266 CID		US1099
1971-1973	V8-5.0L	304 CID		US1099
1971-1973	V8-5.6L	345 CID		US1099
1971-1973	V8-5.7L	345 CID		US1099
1971-1973	V8-6.4L	392 CID		US1099
<b>1000A</b>				
1966	L6-4.3L	264 CID		US1099
1966	V8-4.3L	266 CID		US1099
1966	V8-5.0L	304 CID		US1099
<b>1000B</b>				
1967-1969	L6-4.3L	264 CID		US1099
1967-1969	V8-4.3L	266 CID		US1099
1967-1969	V8-5.0L	304 CID		US1099
1967-1969	V8-5.6L	345 CID		US1099
1968-1969	V8-6.4L	392 CID		US1099
<b>1000C</b>				
1968-1969	L6-4.3L	264 CID		US1099
1968-1969	V8-4.3L	266 CID		US1099
1968-1969	V8-5.0L	304 CID		US1099
1968-1969	V8-5.6L	345 CID		US1099
1968-1969	V8-6.4L	392 CID		US1099
<b>1000D</b>				
1969-1970	L6-4.3L	264 CID		US1099
1969-1970	V8-4.3L	266 CID		US1099
1969-1970	V8-5.0L	304 CID		US1099
1969-1970	V8-5.6L	345 CID		US1099
1969-1970	V8-6.4L	392 CID		US1099
<b>1100A</b>				
1966	L6-4.3L	264 CID		US1099
1966	V8-4.3L	266 CID		US1099
1966	V8-5.0L	304 CID		US1099
<b>1100B</b>				
1967-1969	L6-4.3L	264 CID		US1099
1967-1969	V8-4.3L	266 CID		US1099
1967-1969	V8-5.0L	304 CID		US1099
1967-1969	V8-5.6L	345 CID		US1099
1968-1969	V8-6.4L	392 CID		US1099
<b>1100C</b>				
1968-1969	L6-4.3L	264 CID		US1099
1968-1969	V8-4.3L	266 CID		US1099
1968-1969	V8-5.0L	304 CID		US1099
1968-1969	V8-5.6L	345 CID		US1099

Years	Engine	Disp.	Application Description	USMW
1968-1969	V8-6.4L	392 CID		US1099
<b>1100D</b>				
1969-1970	L6-4.3L	264 CID		US1099
1969-1970	V8-4.3L	266 CID		US1099
1969-1970	V8-5.0L	304 CID		US1099
1969-1970	V8-5.6L	345 CID		US1099
1969-1970	V8-6.4L	392 CID		US1099
<b>1200A</b>				
1966	L6-4.3L	264 CID		US1099
1966	V8-4.3L	266 CID		US1099
1966	V8-5.0L	304 CID		US1099
<b>1200B</b>				
1967-1969	L6-4.3L	264 CID		US1099
1967-1969	V8-4.3L	266 CID		US1099
1967-1969	V8-5.0L	304 CID		US1099
1967-1969	V8-5.6L	345 CID		US1099
1968-1969	V8-6.4L	392 CID		US1099
<b>1200C</b>				
1968-1969	L6-4.3L	264 CID		US1099
1968-1969	V8-4.3L	266 CID		US1099
1968-1969	V8-5.0L	304 CID		US1099
1968-1969	V8-5.6L	345 CID		US1099
1968-1969	V8-6.4L	392 CID		US1099
<b>1200D</b>				
1969-1970	L6-4.3L	264 CID		US1099
1969-1970	V8-4.3L	266 CID		US1099
1969-1970	V8-5.0L	304 CID		US1099
1969-1970	V8-5.6L	345 CID		US1099
1969-1970	V8-6.4L	392 CID		US1099
<b>1300A</b>				
1966	L6-4.3L	264 CID		US1099
1966	V8-4.3L	266 CID		US1099
1966	V8-5.0L	304 CID		US1099
<b>1300B</b>				
1967-1969	L6-4.3L	264 CID		US1099
1967-1969	V8-4.3L	266 CID		US1099
1967-1969	V8-5.0L	304 CID		US1099
1967-1969	V8-5.6L	345 CID		US1099
1968-1969	V8-6.4L	392 CID		US1099
<b>1300C</b>				
1968-1969	L6-4.3L	264 CID		US1099
1968-1969	V8-4.3L	266 CID		US1099
1968-1969	V8-5.0L	304 CID		US1099
1968-1969	V8-5.6L	345 CID		US1099
1968-1969	V8-6.4L	392 CID		US1099
<b>1300D</b>				
1970	L6-4.3L	264 CID		US1099
1970	V8-4.3L	266 CID		US1099
1969-1970	V8-5.0L	304 CID		US1099
1969-1970	V8-5.6L	345 CID		US1099
1969-1970	V8-6.4L	392 CID		US1099
<b>900A</b>				
1966-1967	L4-2.5L	152 CID		US1099
<b>908B</b>				
1967-1969	V8-4.3L	266 CID		US1099
1967-1969	V8-5.0L	304 CID		US1099
<b>908C</b>				
1968-1969	V8-4.3L	266 CID		US1099
1968-1969	V8-5.0L	304 CID		US1099
<b>DM10</b>				
1972	V8-4.3L	266 CID		US1099
1972	V8-5.0L	304 CID		US1099
1972	V8-5.6L	345 CID		US1099
1972	V8-6.4L	392 CID		US1099
<b>M SERIES VAN</b>				
1966-1967	L4-2.5L	152 CID		US1099

Years	Engine	Disp.	Application Description	USMW
<b>M1100</b>				
1966-1971	L4-2.5L	152 CID		US1099
1966-1970	L6-4.3L	264 CID		US1099
1966-1970	V8-4.3L	266 CID		US1099
1966-1972	V8-5.0L	304 CID		US1099
<b>M1200</b>				
1966-1971	L4-2.5L	152 CID		US1099
1966-1970	L6-4.3L	264 CID		US1099
1966-1970	V8-4.3L	266 CID		US1099
1969-1972	V8-5.0L	304 CID		US1099
<b>M1400</b>				
1966-1967	L6-4.3L	264 CID		US1099
1966-1967	V8-4.3L	266 CID		US1099
1966-1969	V8-5.0L	304 CID		US1099
<b>M800</b>				
1966-1971	L4-2.5L	152 CID		US1099
1969-1971	V8-5.0L	304 CID		US1099
<b>MA1200</b>				
1967-1970	V8-4.3L	266 CID		US1099
1967-1971	V8-5.0L	304 CID		US1099
<b>MHC1310</b>				
1974	V8-5.0L	304 CID		US1099
<b>MS</b>				
1975	V8-5.6L	345 CID		US1099
1975	V8-6.4L	392 CID		US1099
<b>MS1210</b>				
1972-1974	V8-5.0L	304 CID		US1099
1972-1974	V8-5.6L	345 CID		US1099
1972-1974	V8-6.4L	392 CID		US1099
<b>SCOUT</b>				
1966-1971	L4-2.5L	152 CID		US1099
1969-1970	L6-4.3L	264 CID		US1099
1969-1970	L6-4.3L	265 CID		US1099
1966-1968	V8-4.3L	266 CID		US1099
1969-1970	V8-5.0L	304 CID		US1099
<b>SCOUT II</b>				
1971	L4-2.5L	152 CID		US1099
1971-1975	V8-5.0L	304 CID		US1099
1971-1975	V8-5.6L	345 CID		US1099
1972-1974	V8-5.7L	345 CID		US1099
1974-1975	V8-6.4L	392 CID		US1099
<b>TRAVELALL</b>				
1975	V8-5.0L	304 CID		US1099
1975	V8-5.6L	345 CID		US1099
1975	V8-6.4L	392 CID		US1099
<b>ISUZU</b>				
<b>AMIGO</b>				
1998-2000	L4-2.2L	2180cc	S	US9375
1989-1993	L4-2.3L	2254cc	S,XS	US9105
1989-1994	L4-2.6L	2559cc	S,XS	US9133
1998-2000	V6-3.2L	3165cc	S	US9365
<b>ASCENDER</b>				
2003-2008	L6-4.2L	256 CID	Base,Limited,LS,S	US5097
2003-2004	V8-5.3L	323 CID	Base,Limited,LS	US5087
2005-2006	V8-5.3L	323 CID	Includes thermostat and thermostat housing; Limited,LS,S	US64-T
2005-2006	V8-5.3L	323 CID	Limited,LS,S	US64
<b>AXIOM</b>				
2002	V6-3.5L	3475cc	Base,XS	US9365
2003-2004	V6-3.5L	3491cc	Base,XS,S	US9365
<b>CAMPO</b>				
1983-1990	L4-2.5L	2499cc	Diesel	US8901
<b>FRONTERA</b>				
1995-1998	L4-2.8L	2772cc	Diesel	US8901
<b>HOMBRE</b>				
1996-2000	L4-2.2L	2180cc	S,XS	US5032

Years	Engine	Disp.	Application Description	USMW
1997-1999	V6-4.3L	4294cc	S,XS	US5077
2000	V6-4.3L	262 CID	S,XS	US5077
<b>I-280</b>				
2006	L4-2.8L	169 CID	Base	US5097
<b>I-290</b>				
2007-2008	L4-2.9L	178 CID	LS,S	US5097
<b>I-350</b>				
2006	L4-2.9L	178 CID	Base	US5097
<b>I-370</b>				
2007-2008	L4-2.9L	178 CID	LS	US5097
<b>I-MARK</b>				
1985-1989	L4-1.5L	1471cc	Base,DLX,S,XS,LS	US5031
1989	L4-1.6L	1588cc	RS	US9160
1981-1985	L4-1.8L	1817cc	Base,DLX,LS	US1127
1983-1984	L4-1.8L	1817cc	From 02/83; Base,DLX,LS,Base	US5027
<b>IMPULSE</b>				
1990-1992	L4-1.6L	1588cc	XS,RS	US9220
1992	L4-1.8L	1817cc	XS	US9221
1983-1987	L4-1.9L	1949cc	Base,SE	US1127
1985-1989	L4-2.0L	1994cc		US9106
1988-1989	L4-2.3L	2254cc	Base	US9105
<b>MONTEREY II</b>				
1991-1994	L4-2.5L	2499cc	Diesel	US8901
1992-1999	L4-3.1L	3059cc	Diesel	US8901
<b>OASIS</b>				
1996-1997	L4-2.2L	2156cc	LS,S	US9209
1998-1999	L4-2.3L	2254cc	LS,S	US9209
<b>PICKUP</b>				
1981-1982	L4-1.8L	1817cc	Base,DLX	US1127
1983-1987	L4-1.9L	1949cc	Base,DLX,LS,LX	US1127
1981-1987	L4-2.2L	2238cc		US9132
1986-1995	L4-2.3L	2254cc	Base,DLX,LS,S,XS	US9105
1988-1995	L4-2.6L	2559cc	1 Ton,LS,S,XS	US9133
1991-1994	V6-3.1L	3137cc	LS,S	US5035
1987	V6-3.9L	3900cc		US9302
<b>RODEO</b>				
1998-2003	L4-2.2L	2180cc	LS,S,LSE	US9375
1991-1997	L4-2.6L	2559cc	LS,S,XS	US9133
1991-1992	V6-3.1L	3137cc	LS,S,XS	US5035
1993-1997	V6-3.2L	3165cc	LS,S,From 01/95; LS	US9278
1998-2004	V6-3.2L	3165cc	LS,S,LSE,S V6	US9365
2004	V6-3.5L	3494cc	S	US9365
<b>RODEO SPORT</b>				
2001-2003	L4-2.2L	2180cc	S	US9375
2001-2003	V6-3.2L	3165cc	S V6	US9365
<b>STYLUS</b>				
1991-1993	L4-1.6L	1588cc	XS,S	US9221
1992	L4-1.8L	1817cc	RS	US9221
<b>TROOPER</b>				
1984-1985	L4-1.9L	1949cc	Base	US1127
1984	L4-2.2L	2238cc	Base	US1127
1986-1987	L4-2.2L	2238cc		US9132
1986-1987	L4-2.3L	2254cc	DLX,LS,LX	US9105
1988-1991	L4-2.6L	2559cc	LS,S,XS,RS,SE	US9133
1987-1991	L4-2.8L	2772cc	Diesel	US8901
1989-1991	V6-2.8L	2827cc	LS,RS,S,XS,SE	US5035
1992-1997	V6-3.2L	3165cc	LS,S,RS,From 01/95; RS,SE,Ltd	US9278
1998-2002	V6-3.5L	3475cc	S,Limited,LS	US9365
<b>VEHICROSS</b>				
1999-2001	V6-3.5L	3475cc	Base	US9365
<b>JAGUAR</b>				
<b>S-TYPE</b>				
2000-2002	V6-3.0L	183 CID	From Chassis/VIN L52823; Base,Base	US4118
2003-2008	V6-3.0L	183 CID	Base,Sport	US4129
2000-2002	V8-4.0L	3996cc	Base	US4124
2003-2008	V8-4.2L	4196cc	Base,R,Sport,VDP Edition	US4124



Years	Engine	Disp.	Application Description	USMW
<b>SUPER V8</b>				
2005-2009	V8-4.2L	4196cc	Base,Portfolio	US4124
<b>VANDEN PLAS</b>				
1988-1989	L6-3.6L	3590cc	80 Amp; Lucas Alternator; Base,Base,Majestic	US9163
1990-1992	L6-4.0L	3980cc	Base,Majestic	US9163
1993-1994	L6-4.0L	3980cc	Base	US9280
1995-1997	L6-4.0L	3980cc	Base	US9356
1998-2005	V8-4.0L	3996cc	Base,SC	US4124
2006-2009	V8-4.2L	4196cc	Base	US4124
<b>XF</b>				
2009-2010	V8-4.2L	4196cc	Luxury,Premium Luxury,Supercharged,Base	US4124
<b>XJ12</b>				
1975-1979	V12-5.3L	5343cc		US9165
1994-1996	V12-6.0L	5994cc	Base	US9165
<b>XJ6</b>				
1988-1989	L6-3.6L	3590cc	80 Amp; Lucas Alternator; Base,Base	US9163
1990-1992	L6-4.0L	3980cc	Base,Sovereign	US9163
1993-1994	L6-4.0L	3980cc	Base,Sovereign	US9280
1995-1997	L6-4.0L	3980cc	Base,L	US9356
1975-1982	L6-4.2L	4235cc	L,Base,To Chassis/VIN 330665; Base	US9211
<b>XJ8</b>				
1998-2003	V8-4.0L	3996cc	Base,L,Sport	US4124
2004-2009	V8-4.2L	4196cc	Base,L	US4124
<b>XJR</b>				
1995-1997	L6-4.0L	3980cc	Base	US9356
1998-2003	V8-4.0L	3996cc	Base,100	US4124
2004-2009	V8-4.2L	4196cc	Base	US4124
<b>XJRS</b>				
1993	V12-6.0L	5994cc	Base	US9165
<b>XJS</b>				
1993-1994	L6-4.0L	3980cc	From Engine 163523; To Engine 196089; Base, From Engine 163523; To Engine 196089; 2+2,Base	US9280
1993-1994	L6-4.0L	3980cc	To Engine 163522; Base,To Engine 163522; 2+2,Base	US9163
1993-1996	L6-4.0L	3980cc	From Engine B100136; Base, From Engine B100136; 2+2,Base	US9356
1976-1992	V12-5.3L	5343cc	Base,C,Collection Rouge,Classic Collection	US9165
1994-1995	V12-6.0L	5994cc	2+2,Base	US9165
<b>XK</b>				
2007-2009	V8-4.2L	4196cc	Base	US4124
<b>XX8</b>				
1997-2002	V8-4.0L	3996cc	Base	US4124
2003-2006	V8-4.2L	4196cc	Base,Victory Edition	US4124
<b>XKR</b>				
2000-2002	V8-4.0L	3996cc	Base,100	US4124
2003-2009	V8-4.2L	4196cc	Base,Victory Edition,Portfolio	US4124
<b>X-TYPE</b>				
2002-2005	V6-2.5L	152 CID	Base	US6657
2002-2008	V6-3.0L	183 CID	Base,Premium,Vanden Plas,Sport,VDP Edition	US6657
<b>JEEP</b>				
<b>CHEROKEE</b>				
1985-1987	L4-2.1L	126 CID	Base,Chief,Laredo,Pioneer	US3409
1984-1990	L4-2.5L	150 CID	Serpentine Belt Drive; Base,Chief,Laredo,Pioneer,Sport	US3413
1984-1990	L4-2.5L	150 CID	V-Belt Drive; Base,Chief,Laredo,Pioneer,Sport	US3403
1991-2000	L4-2.5L	150 CID	Base,SE,Classic,Limited,Sport	US7136
1987-2001	L6-4.0L	242 CID	Base,Chief,Laredo,Limited,Pioneer,Sport, Briarwood,Country,SE,Classic	US3412
1975-1979	L6-4.2L	258 CID		US1077
1980-1983	L6-4.2L	258 CID	V-Belt Drive; Base,Wide Track,Chief,Pioneer	US3403
1981-1983	L6-4.2L	258 CID	Serpentine Belt Drive; Base,Chief,Pioneer	US3413
1984-1986	V6-2.8L	173 CID	Base,Chief,Laredo,Pioneer	US5006
1975-1983	V8-5.9L	360 CID	Base,Wide Track,Chief,Pioneer	US3401
1975-1983	V8-5.9L	360 CID	High Performance; Base,Wide Track,Chief,Pioneer	US3401H
1975-1978	V8-6.6L	401 CID		US3401
1975-1978	V8-6.6L	401 CID	High Performance	US3401H
<b>CJ10 (MEX)</b>				
1984-1985	L6-4.6L	282 CID	2BL	US3403

Years	Engine	Disp.	Application Description	USMW
<b>CJ3</b>				
1966	V6-3.7L	225 CID		US855
<b>CJ5</b>				
1980	L4-2.5L	151 CID	Base,Golden Eagle,Laredo,Renegade	US1107
1981-1983	L4-2.5L	151 CID	Serpentine Belt Drive; Base,Laredo,Renegade,Limited	US3413
1981-1983	L4-2.5L	151 CID	V-Belt Drive; Base,Laredo,Renegade,Limited	US3403
1980-1983	L6-4.2L	258 CID	Serpentine Belt Drive; Base,Golden Eagle,Laredo, Renegade,Limited	US3413
1980-1983	L6-4.2L	258 CID	V-Belt Drive; Base,Golden Eagle,Laredo,Renegade, Limited	US3403
1966-1971	V6-3.7L	225 CID		US855
1980-1981	V8-5.0L	304 CID	Base,Golden Eagle,Laredo,Renegade	US3401
1980-1981	V8-5.0L	304 CID	High Performance; Base,Golden Eagle,Laredo, Renegade	US3401H
<b>CJ5A</b>				
1966-1968	V6-3.7L	225 CID		US855
<b>CJ5D (MEX)</b>				
1965-1971	L6-3.8L	232 CID	1BL	US1021
1965-1971	L6-4.2L	258 CID	1BL	US1021
1975-1986	L6-4.2L	258 CID	2BL	US3403
1973-1983	L6-4.6L	282 CID	1BL	US1077
1975-1986	L6-4.6L	282 CID	2BL	US3403
<b>CJ5S (MEX)</b>				
1965-1971	L6-3.8L	232 CID	1BL	US1021
1965-1971	L6-4.2L	258 CID	1BL	US1021
<b>CJ6</b>				
1966-1971	V6-3.7L	225 CID		US855
<b>CJ6A</b>				
1966-1968	V6-3.7L	225 CID		US855
<b>CJ7</b>				
1980-1983	L4-2.5L	151 CID	Base,Golden Hawk,Laredo,Renegade,Limited	US1107
1981-1982	L4-2.5L	151 CID	Serpentine Belt Drive; Base,Laredo,Renegade,Limited	US3413
1981-1982	L4-2.5L	151 CID	V-Belt Drive; Base,Laredo,Renegade,Limited	US3403
1983-1986	L4-2.5L	150 CID	Serpentine Belt Drive; Base,Laredo,Limited,Renegade	US3413
1983-1986	L4-2.5L	150 CID	V-Belt Drive; Base,Laredo,Limited,Renegade	US3403
1976-1978	L6-3.8L	232 CID		US1077
1976-1979	L6-4.2L	258 CID		US1077
1980-1986	L6-4.2L	258 CID	V-Belt Drive; Base,Golden Hawk,Laredo,Renegade, Limited	US3403
1981-1986	L6-4.2L	258 CID	Serpentine Belt Drive; Base,Laredo,Renegade,Limited	US3413
1976-1981	V8-5.0L	304 CID	Base,Golden Hawk,Laredo,Renegade	US3401
1976-1981	V8-5.0L	304 CID	High Performance; Base,Golden Hawk,Laredo, Renegade	US3401H
<b>CJ7 (MEX)</b>				
1965-1974	L6-3.8L	232 CID	1BL	US1021
1975	L6-3.8L	232 CID	1BL	US1077
1965-1974	L6-4.2L	258 CID	1BL	US1021
1975-1978	L6-4.2L	258 CID	2BL	US1077
1973	L6-4.6L	282 CID	1BL	US1021
1974-1983	L6-4.6L	282 CID	1BL ; 2BL	US1077
1980-1986	L6-4.6L	282 CID	2BL; V-Belt Drive	US3403
<b>COMANCHE</b>				
1986-1987	L4-2.1L	126 CID	Custom,X,XLS,Base,Laredo,Pioneer	US3409
1986-1990	L4-2.5L	150 CID	Serpentine Belt Drive; Custom,X,XLS, Base,Chief, Laredo,Pioneer	US3413
1986-1990	L4-2.5L	150 CID	V-Belt Drive; Custom,X,XLS,V-Belt Drive; Base,Chief,Laredo,Pioneer	US3403
1991-1992	L4-2.5L	150 CID	Base,Pioneer	US7136
1987-1992	L6-4.0L	242 CID	Base,Chief,Laredo,Pioneer,Eliminator	US3412
1986	V6-2.8L	173 CID	Custom,X,XLS	US5006
<b>COMMANDER</b>				
2006-2010	V6-3.7L	226 CID	65th Anniversary Edition,Base,Sport	US7163
2006-2009	V8-4.7L	285 CID	65th Anniversary Edition,Base,Limited,Sport	US7163
2006-2008	V8-5.7L	345 CID	Limited,Overland	US8940
2009-2010	V8-5.7L	345 CID	Limited,Overland,Sport	US8979
<b>COMMANDO</b>				
1966-1971	V6-3.7L	225 CID		US855

Years	Engine	Disp.	Application Description	USMW
<b>COMPASS</b>				
2007-2012	L4-2.0L	122 CID	Base,Sport,Latitude	US6038
2007-2012	L4-2.4L	144 CID	Base,Limited,Sport,Latitude	US6038
<b>DISPATCHER</b>				
1966-1969	V6-3.7L	225 CID		US855
<b>DJ5</b>				
1966-1971	V6-3.7L	225 CID		US855
<b>DJ6</b>				
1966-1968	V6-3.7L	225 CID		US855
<b>FC150</b>				
1966	L6-3.7L	226 CID		US855
1966	V6-3.7L	225 CID		US855
<b>FC170HD</b>				
1966	V6-3.7L	225 CID		US855
<b>GRAND CHEROKEE</b>				
1993-1998	L6-4.0L	242 CID	Base,Laredo,Limited,SE,Orvis,TSi	US7136
1999-2004	L6-4.0L	242 CID	Laredo,Limited,Sport,Special Edition	US7164
2007-2009	V6-3.0L	182 CID	Laredo,Limited,Overland	US6155
2011-2014	V6-3.6L	220 CID		US8981
2005-2010	V6-3.7L	226 CID	Laredo,65th Anniversary Edition,Limited	US7163
1999-2001	V8-4.7L	287 CID	Laredo,Limited	US7163
2002-2009	V8-4.7L	285 CID	Laredo,Limited,Overland,Sport,Special Edition,65th Anniversary Edition	US7163
1993-1998	V8-5.2L	318 CID	Base,Laredo,Limited,SE,Orvis,TSi	US7160
2005-2008	V8-5.7L	345 CID	Limited,Overland	US8940
2009-2010	V8-5.7L	345 CID	Laredo,Limited,Overland,Laredo	US8979
2011-2012	V8-5.7L	345 CID	Laredo,Limited,Overland,Overland Summit	US8971
1998	V8-5.9L	360 CID	5.9 Limited	US7160
2006-2010	V8-6.1L	370 CID	SRT8	US8940
2012-2013	V8-6.4L	392 CID	SRT8	US8971
<b>GRAND CHEROKEE (MEX)</b>				
1992	L6-4.0L	242 CID	MFI ; 4WD	US3412
2008	V8-4.7L	287 CID	SFI	US7163
<b>GRAND CHEROKEE 4WD (MEX)</b>				
1992	V8-5.2L	318 CID	MFI	US7160
<b>GRAND WAGONER</b>				
1984-1986	L6-4.2L	258 CID	Serpentine Belt Drive; Base,Limited	US3413
1984-1986	L6-4.2L	258 CID	V-Belt Drive; Base,Limited	US3403
1993	V8-5.2L	318 CID	Base	US7160
1984-1991	V8-5.9L	360 CID	Base,Limited	US3401
1984-1991	V8-5.9L	360 CID	High Performance; Base,Limited	US3401H
<b>J10</b>				
1975-1979	L6-4.2L	258 CID		US1077
1980-1987	L6-4.2L	258 CID	V-Belt Drive; Base	US3403
1981-1987	L6-4.2L	258 CID	Serpentine Belt Drive; Base	US3413
1975-1988	V8-5.9L	360 CID	Base	US3401
1975-1988	V8-5.9L	360 CID	High Performance; Base	US3401H
1975-1978	V8-6.6L	401 CID		US3401
1975-1978	V8-6.6L	401 CID	High Performance	US3401H
<b>J-100</b>				
1968-1971	V8-5.7L	350 CID		US855
<b>J100 (MEX)</b>				
1980-1983	L6-4.6L	282 CID	1BL	US1077
1980-1986	L6-4.6L	282 CID	2BL; V-Belt Drive	US3403
<b>J162 (MEX)</b>				
1968-1969	L6-3.8L	232 CID	1BL	US1021
1965-1969	L6-4.2L	258 CID	1BL	US1021
<b>J164 (MEX)</b>				
1967-1972	L6-3.8L	232 CID	1BL	US1021
1965-1972	L6-4.2L	258 CID	1BL	US1021
1973-1983	L6-4.6L	282 CID	1BL ; 2BL	US1077
1980-1986	L6-4.6L	282 CID	2BL; V-Belt Drive	US3403
<b>J164V (MEX)</b>				
1967-1972	L6-3.8L	232 CID	1BL	US1021
1965-1972	L6-4.2L	258 CID	1BL	US1021
1973-1983	L6-4.6L	282 CID	1BL ; 2BL	US1077
1980-1986	L6-4.6L	282 CID	2BL; V-Belt Drive	US3403

Years	Engine	Disp.	Application Description	USMW
<b>J20</b>				
1976	L6-4.2L	258 CID		US1077
1975-1988	V8-5.9L	360 CID	Base	US3401
1975-1988	V8-5.9L	360 CID	High Performance; Base	US3401H
1975-1978	V8-6.6L	401 CID		US3401
1975-1978	V8-6.6L	401 CID	High Performance	US3401H
<b>J-2500</b>				
1969-1971	V8-5.7L	350 CID		US855
<b>J-2600</b>				
1969-1971	V8-5.7L	350 CID		US855
<b>J262S (MEX)</b>				
1968-1971	L6-3.8L	232 CID	1BL	US1021
1968-1971	L6-4.2L	258 CID	1BL	US1021
<b>J264D (MEX)</b>				
1967	L6-3.8L	232 CID	1BL	US1021
1965-1967	L6-4.2L	258 CID	1BL	US1021
<b>J-2700</b>				
1969-1970	V8-5.7L	350 CID		US855
<b>J364R (MEX)</b>				
1967-1972	L6-3.8L	232 CID	1BL	US1021
1965-1972	L6-4.2L	258 CID	1BL	US1021
1973-1979	L6-4.6L	282 CID	1BL ; 2BL	US1077
1980-1984	L6-4.6L	282 CID	1BL; V-Belt Drive;; 2BL; V-Belt Drive	US3403
<b>LIBERTY</b>				
2002-2005	L4-2.4L	148 CID	Renegade,Sport	US7156
2002-2012	V6-3.7L	226 CID	Limited,Sport,Renegade,Rocky Mountain Edition,65th Anniversary Edition,Jet	US7163
<b>PATRIOT</b>				
2007-2012	L4-2.0L	122 CID	Base,Sport,Latitude	US6038
2007-2012	L4-2.4L	144 CID	Base,Limited,Sport,Latitude,Latitude X	US6038
<b>PATRIOT (MEX)</b>				
2010-2013	L4-2.4L	144 CID	SFI DOHC	US6038
<b>SCRAMBLER</b>				
1981-1982	L4-2.5L	151 CID	Serpentine Belt Drive; Base,SL,SR	US3413
1981-1982	L4-2.5L	151 CID	V-Belt Drive; Base,SL,SR	US3403
1981-1983	L4-2.5L	151 CID	Base,SL,SR	US1107
1983-1985	L4-2.5L	150 CID	Serpentine Belt Drive; Base,SL,SR,Laredo,Renegade	US3413
1983-1985	L4-2.5L	150 CID	V-Belt Drive; Base,SL,SR,Laredo,Renegade	US3403
1981-1985	L6-4.2L	258 CID	Serpentine Belt Drive; Base,SL,SR,Laredo,Renegade	US3413
1981-1985	L6-4.2L	258 CID	V-Belt Drive; Base,SL,SR,Laredo,Renegade	US3403
<b>TJ</b>				
2000-2006	L6-4.0L	242 CID		US7164
<b>WAGONER</b>				
1985	L4-2.1L	126 CID	Base,Limited	US3409
1984-1987	L4-2.5L	150 CID	Serpentine Belt Drive; Base,Limited	US3413
1984-1987	L4-2.5L	150 CID	V-Belt Drive; Base,Limited	US3403
1987-1990	L6-4.0L	242 CID	Base,Limited	US3412
1980-1983	L6-4.2L	258 CID	V-Belt Drive; Base,Limited,Brougham,V-Belt Drive;	US3403
1981-1983	L6-4.2L	258 CID	Serpentine Belt Drive; Base,Limited,Brougham,	US3413
1984-1986	V6-2.8L	173 CID	Base,Limited	US5006
1975-1983	V8-5.9L	360 CID	Base,Limited,Brougham	US3401
1975-1983	V8-5.9L	360 CID	High Performance; Base,Limited,Brougham	US3401H
1975-1978	V8-6.6L	401 CID		US3401
1975-1978	V8-6.6L	401 CID	High Performance	US3401H
<b>WAGONER (MEX)</b>				
1976-1979	L6-4.6L	282 CID	2BL ; 1BL	US1077
1980-1986	L6-4.6L	282 CID	1BL ; 2BL	US3403
<b>WRANGLER</b>				
2003-2006	L4-2.4L	148 CID	SE	US7156
1987-1990	L4-2.5L	150 CID	Serpentine Belt Drive; Base,Laredo,Sport,S,Sahara,Islander	US3413
1987-1990	L4-2.5L	150 CID	V-Belt Drive; Base,Laredo,Sport,S,Sahara,Islander	US3403
1991-2002	L4-2.5L	150 CID	Base,Islander,Laredo,Limited,S,Sahara,Rio Grande,SE,Sport	US7136
1991-1999	L6-4.0L	242 CID	Base,Islander,Laredo,Limited,Renegade,Sahara,SE,Sport	US7136

Years	Engine	Disp.	Application Description	USMW
2000-2006	L6-4.0L	242 CID	Sahara,Sport,SE,X,Rubicon,Unlimited, Unlimited Rubicon,65th Anniversary Edition	US7164
1987-1990	L6-4.2L	258 CID	Serpentine Belt Drive; Base,Laredo,Sport,Islander,S, Sahara	US3413
1987-1990	L6-4.2L	258 CID	V-Belt Drive; Base,Laredo,Sport,Islander,S,Sahara	US3403
2012-2013	V6-3.6L	220 CID		US6699
2007-2011	V6-3.8L	231 CID	Rubicon,Sahara,Unlimited Rubicon,Unlimited Sahara, Unlimited X,X,Islander,Mountain,Sport, Unlimited Islander,Unlimited Mountain,Unlimited Sport	US8960
<b>WRANGLER (MEX)</b>				
2010	V6-3.8L	231 CID	SFI OHV ; Unlimited,X 4WD	US8960
<b>KIA</b>				
<b>AMANTI</b>				
2004-2006	V6-3.5L	3497cc	Base	US9463
2007-2009	V6-3.8L	3778cc	Base	US6048
<b>BORREGO</b>				
2009	V6-3.8L	3778cc	EX,LX	US6048
<b>FORTE</b>				
2011-2013	L4-2.0L	1998cc	EX,LX,	US6220
2010-2012	L4-2.4L	2359cc	SX	US6220
<b>FORTEOUP</b>				
2010-2013	L4-2.0L	1998cc		US6220
2010-2013	L4-2.4L	2359cc		US6220
<b>OPTIMA</b>				
2011-2013	L4-2.0L	1998cc	EX,SX,	US8982
2001-2002	L4-2.4L	2351cc	LX,SE	US9477
2003-2006	L4-2.4L	2351cc	LX,SE,EX	US9399
2006-2010	L4-2.4L	2359cc	EX,LX	US6220
2011-2014	L4-2.4L	2359cc	EX,LX,	US8982
2001-2006	V6-2.7L	2656cc	LX,SE,EX	US9462
2007-2010	V6-2.7L	2656cc	EX,LX,SX	US6215
<b>RIO</b>				
2001-2002	L4-1.5L	1493cc		US9305
2001-2002	L4-1.5L	1493cc	Base,Cinco	US9473
2003-2005	L4-1.6L	1594cc		US9305
2003-2005	L4-1.6L	1594cc	Base,Cinco	US9473
2006-2011	L4-1.6L	1599cc	Base,LX,SX	US9364
<b>RIOS</b>				
2006-2012	L4-1.6L	1599cc	SX,LX	US9364
<b>RONDO</b>				
2007-2010	L4-2.4L	2359cc	EX,LX,To 10/14/08; EX	US6220
2007-2010	V6-2.7L	2656cc	EX,LX	US6215
<b>SEDONA</b>				
2002-2005	V6-3.5L	3497cc	EX,LX	US9463
2011-2012	V6-3.5L	3470cc	EX,LX	US6048
2006-2010	V6-3.8L	3778cc	EX,LX,Base,From 11/03/09; Base	US6048
<b>SEPHIA</b>				
1994	L4-1.6L	1597cc	GS,LS,RS	US4049
1995-1997	L4-1.6L	1597cc	GS,LS,RS	US9305
1995-1997	L4-1.8L	1839cc	GS,LS,RS	US9305
1998-2001	L4-1.8L	1793cc	Base,LS	US9393
<b>SORENTO</b>				
2011-2013	L4-2.4L	2359cc	Base,EX,LX,	US6220
2012-2013	L4-2.4L	2359cc	EX,LX,	US8982
2003-2006	V6-3.5L	3497cc	EX,LX	US9448
2011-2013	V6-3.5L	3470cc		US6048
2007-2009	V6-3.8L	3778cc	EX,LX	US6048
<b>SOUL</b>				
2010-2011	L4-2.0L	1975cc	!+,Sport	US9353
<b>SPECTRA</b>				
2000-2004	L4-1.8L	1793cc	GS,GSX,Base,LS	US9393
2004-2009	L4-2.0L	1975cc	EX,LX,SX	US9353
<b>SPECTRA5</b>				
2005-2009	L4-2.0L	1975cc	Base,SX	US9353
<b>SPORTAGE</b>				
1995	L4-2.0L	1998cc	Base,EX	US4053
1995-2002	L4-2.0L	1998cc	Base,EX,Limited	US9450

Years	Engine	Disp.	Application Description	USMW
2005-2010	L4-2.0L	1975cc	LX	US9353
2011-2012	L4-2.0L	1998cc	SX	US8982
2011-2013	L4-2.4L	2359cc	Base,EX,LX	US8982
2005-2010	V6-2.7L	2656cc	EX,LX	US9462
<b>LAND ROVER</b>				
<b>DEFENDER 110</b>				
1993	V8-3.9L	3950cc	Base	US9368
<b>DEFENDER 90</b>				
1994-1995	V8-3.9L	3950cc	Base	US9368
1997	V8-4.0L	3950cc	Base,LE	US9369
<b>DISCOVERY</b>				
1994-1995	V8-3.9L	3950cc	Base	US9369
1996-2002	V8-4.0L	3950cc	SD,SE,SE7,LSE,XD,50th Anniversary Edition,LE, Series II,Series II LE,Series II SD,Series II SE	US9369
2003-2004	V8-4.6L	4554cc	HSE,S,SE	US9369
<b>FREELANDER</b>				
2002-2005	V6-2.5L	2500cc	HSE,S,SE,SE3	US9496
<b>LR3</b>				
2005-2009	V8-4.4L	4394cc	HSE,SE,HSE Lux	US4124
<b>RANGE ROVER</b>				
1987-1988	V8-3.5L	3532cc	Base,40th Anniversary Edition	US9368
1989-1992	V8-3.9L	3947cc	Base,County,Hunter,County SE,Great Divide,LSE	US9368
1993-1995	V8-3.9L	3950cc	From Engine 36D25155B; County,County LWB,Sport From Engine 40D09582B; County, From Engine 36D25155B; County Classic	US9369
1993-1995	V8-3.9L	3950cc	To Engine 36D25155B; County,Sport, To Engine 36D25155B; County Classic	US9368
1995-2000	V8-4.0L	3950cc	SE,50th Anniversary Edition,Base,S,County	US9369
1993-1994	V8-4.2L	4200cc	To Engine 40D09582B; County LWB	US9368
1995	V8-4.2L	4200cc	From Engine 40D09582B; 25th Anniversary Edition, County LWB,25th Anniversary Edition	US9369
2006-2009	V8-4.4L	4394cc	HSE,Supercharged	US4124
1996-2000	V8-4.6L	4554cc	HSE,Kensington,Vitesse,Callaway,HSK	US9369
<b>RANGE ROVER SPORT</b>				
2006-2009	V8-4.4L	4394cc	HSE,Supercharged,LE	US4124
<b>LEXUS</b>				
<b>ES250</b>				
1990-1991	V6-2.5L	2508cc	Base	US9258
<b>ES300</b>				
1992-1993	V6-3.0L	2959cc	Base	US9258
1994-2003	V6-3.0L	2995cc	Base	US9306
1996-1998	V6-3.0L	2959cc	Base	US9306
<b>ES330</b>				
2004-2006	V6-3.3L	3300cc	Base	US9306
<b>ES350</b>				
2007-2012	V6-3.5L	3456cc	Base	US6047
<b>GS300</b>				
1993-1997	L6-3.0L	2997cc	Base	US9256
1998-2004	L6-3.0L	2997cc	Base	US9395
2006	V6-3.0L	2994cc		US6143
<b>GS350</b>				
2007-2013	V6-3.5L	3456cc		US6143
<b>GS400</b>				
1998-2000	V8-4.0L	3969cc	Base	US9257
<b>GS430</b>				
2001-2007	V8-4.3L	4293cc	Base	US9257
<b>GS450H</b>				
2007-2013	V6-3.5L	3456cc		US6143
<b>GS460</b>				
2008-2011	V8-4.6L	4608cc	Base	US6338
<b>GX470</b>				
2003-2009	V8-4.7L	4663cc	Base	US9257
<b>HS250H</b>				
2010-2012	L4-2.4L	2362cc	Base,Premium	US9414
<b>IS F</b>				
2008-2013	V8-5.0L	4969cc	Base	US6338



Years	Engine	Disp.	Application Description	USMW
<b>IS250</b>				
2006-2013	V6-2.5L	2499cc	From 03/09	US6143
<b>IS300</b>				
2001-2005	L6-3.0L	2997cc	Base,Sportcross	US9395
<b>IS350</b>				
2006-2013	V6-3.5L	3456cc	From 03/09	US6143
<b>LS400</b>				
1990-1995	V8-4.0L	3967cc	Base	US9476
1996-1997	V8-4.0L	3969cc	Base,To 07/97; Base	US9476
1997-2000	V8-4.0L	3969cc	From 07/97; Base,Base	US9257
<b>LS430</b>				
2001-2006	V8-4.3L	4293cc	Base	US9257
<b>LS460</b>				
2007-2013	V8-4.6L	4608cc	Base,L	US6338
<b>LS600H</b>				
2008-2013	V8-5.0L	4969cc	L	US6338
<b>LX450</b>				
1996-1997	L6-4.5L	4477cc	Base	US9269
<b>LX470</b>				
1998-2007	V8-4.7L	4663cc	Base	US9257
<b>LX570</b>				
2008-2013	V8-5.7L	5663cc	Base	US6197
<b>RX300</b>				
1999-2003	V6-3.0L	2995cc	Base	US9306
<b>RX330</b>				
2004-2006	V6-3.3L	3300cc	Base	US9306
<b>RX350</b>				
2007-2012	V6-3.5L	3456cc	Base,Exc.Japan Built; Base	US6047
<b>RX400H</b>				
2006-2008	V6-3.3L	3300cc	Base	US9306
<b>RX450H</b>				
2010-2012	V6-3.5L	3456cc	Base	US6047
<b>SC300</b>				
1992-1999	L6-3.0L	2997cc	Base	US9256
2000	L6-3.0L	2997cc	Base	US9292
<b>SC400</b>				
1992-1995	V8-4.0L	3967cc	Base	US9476
1996-1997	V8-4.0L	3969cc	Base	US9476
1998-2000	V8-4.0L	3969cc	Base	US9257
<b>SC430</b>				
2002-2010	V8-4.3L	4293cc	Base	US9257
<b>LINCOLN</b>				
<b>AVIATOR</b>				
2003-2005	V8-4.6L	281 CID		US4110
<b>BLACKWOOD</b>				
2002	V8-5.4L	330 CID	Base	US4122
<b>BLACKWOOD (MEX)</b>				
2003	V8-5.4L	330 CID	SFI DOHC ; 2WD	US4128
<b>CONTINENTAL</b>				
1984-1985	L6-2.4L	146 CID	Base,Givenchy,Valentino	US9154
1982	V6-3.8L	232 CID	Base,Givenchy,Signature	US4016
1988-1993	V6-3.8L	232 CID	Base,Signature,Executive	US4051
1994	V6-3.8L	232 CID	Base,Executive,Signature	US4089
1995-2002	V8-4.6L	281 CID	Diamond Anniversary,Signature,Spinnaker Edition, Anniversary,Base	US4097
1983-1984	V8-5.0L	302 CID	Base,Givenchy,Valentino	US4014
1985	V8-5.0L	302 CID	High Performance; Base,Givenchy,Valentino,Base	US4024H
1986-1987	V8-5.0L	302 CID	Base,Givenchy	US4038
1986-1987	V8-5.0L	302 CID	High Performance; Base,Givenchy	US4038H
1980	V8-5.8L	351 CID	Base	US4014
1977-1979	V8-6.6L	400 CID	Single tube outlet	US932
1975-1978	V8-7.5L	460 CID		US1114
<b>LS</b>				
2000-2002	V6-3.0L	182 CID	Base,LSE	US4118
2003-2005	V6-3.0L	182 CID	Base,LSE,Appearance,Luxury,Premium	US4129
2000-2006	V8-3.9L	242 CID	Base,LSE,Sport,Ultimate	US4124

Years	Engine	Disp.	Application Description	USMW
<b>MARK IV</b>				
1975-1976	V8-7.5L	460 CID		US1114
<b>MARK LT</b>				
2006	V8-5.4L	330 CID		US4110
2007-2008	V8-5.4L	330 CID	Base	US6144
<b>MARK LT (MEX)</b>				
2010	V8-5.4L	330 CID	SOHC ; 2WD,4WD	US4122
<b>MARK V</b>				
1977-1979	V8-6.6L	400 CID	Single tube outlet	US932
<b>MARK VI</b>				
1980	V8-5.0L	302 CID	Base	US4014
1980-1983	V8-5.8L	351 CID	Base,Bill Blass,Givenchy,Pucci,Signature	US4014
<b>MARK VII</b>				
1984-1985	L6-2.4L	146 CID	Base,Bill Blass,LSC,Versace	US9154
1984	V8-5.0L	302 CID	Base,Bill Blass,LSC,Versace	US4014
1985-1992	V8-5.0L	302 CID	Base,Bill Blass,Versace,LSC	US4038
1985-1992	V8-5.0L	302 CID	High Performance; LSC,High Performance; Base, Bill Blass,LSC,High Performance; Bill Blass	US4038H
<b>MARK VIII</b>				
1993-1998	V8-4.6L	281 CID	Base,LSC,Anniversary	US4113
<b>MKS</b>				
2010	V6-3.5L	213 CID	EcoBoost	US6023
2009-2010	V6-3.7L	227 CID	Base	US6023
2011-2012	V6-3.7L	227 CID	Base,To 01/02/12; Base	US8980
<b>MKT</b>				
2010	V6-3.5L	213 CID	EcoBoost	US6023
2010	V6-3.7L	227 CID	Base	US6023
2011-2012	V6-3.7L	227 CID	Base,To 01/02/12; Base	US8980
<b>MKX</b>				
2007-2010	V6-3.5L	213 CID	Base	US6023
2012	V6-3.5L	213 CID	To 01/02/12; Base	US8980
2011	V6-3.7L	227 CID	Base	US8980
<b>MKZ</b>				
2011-2012	L4-2.5L	152 CID	Hybrid	US4126
2007-2011	V6-3.5L	213 CID	Base	US6023
2012	V6-3.5L	213 CID	To 01/02/12; Base	US8980
<b>NAVIGATOR</b>				
1998-2001	V8-5.4L	330 CID	Base	US4122
2002-2009	V8-5.4L	330 CID		US4110
2007-2008	V8-5.4L	330 CID	L Luxury,L Ultimate,Luxury,Ultimate,Base,L	US6144
<b>TOWN CAR</b>				
1991-1997	V8-4.6L	281 CID	Base,Cartier,Cypress,Executive,Signature, Touring Edition,Jack Nicklaus,Tournament Edition, Anniversary	US4066
1998-2002	V8-4.6L	281 CID	Base,Cartier,Executive,Signature,Cartier L,Executive L	US4113
2001-2011	V8-4.6L	281 CID	Base,Cartier,Cartier L,Executive,Executive L, Signature,Executive Protection Series,Ultimate, Ultimate L,Signature L,Signature Limited, Designer Series	US4128
1982-1987	V8-5.0L	302 CID	Base,Cartier,Signature	US4014
1988-1990	V8-5.0L	302 CID	From 06/88; Base,Cartier,Signature,Base, Signature SE,Cypress,Executive,Touring Edition	US4052
1988-1990	V8-5.0L	302 CID	From 06/88; High Performance; Base,Cartier, Signature,High Performance; Base, Signature SE,Cypress,Executive,Touring Edition	US4052H
<b>VERSAILLES</b>				
1977-1980	V8-5.0L	302 CID	Double tube outlet; Base	US953
1977-1980	V8-5.0L	302 CID	High Performance; Base	US953H
1977	V8-5.8L	351 CID	High Performance,;	US953H
<b>ZEPHYR</b>				
2006	V6-3.0L	183 CID	Base	US9489
<b>MAZDA</b>				
<b>3</b>				
2004-2005	L4-2.0L	2000cc	i,S,SP23	US4126
2006-2012	L4-2.0L	1997cc	i	US6219
2004-2005	L4-2.3L	2254cc	i,S,SP23	US4126
2006-2009	L4-2.3L	2260cc	S	US6219

Years	Engine	Disp.	Application Description	USMW
2006-2012	L4-2.3L	2260cc	Mazdaspeed	US4126
2010-2012	L4-2.5L	2488cc	S	US6219
<b>5</b>				
2006-2007	L4-2.3L	2260cc	Sport,Touring,Grand Touring	US4126
2008-2010	L4-2.3L	2260cc	Grand Touring,Sport,Touring	US6219
2012	L4-2.5L	2488cc	Grand Touring,Sport,Touring	US6219
<b>6</b>				
2003-2008	L4-2.3L	2260cc	i,From 02/01/06; i,Mazdaspeed	US4126
2009-2010	L4-2.5L	152 CID	i	US4126
2011-2012	L4-2.5L	2488cc	i	US6219
2003-2008	V6-3.0L	2968cc	S	US9489
2009-2011	V6-3.7L	227 CID	S,To 07/06/09; S	US6023
<b>323</b>				
1986-1994	L4-1.6L	1597cc	Base,DX,LX,SE	US4049
1988-1989	L4-1.6L	1597cc	Turbo; GT,GTX,Turbo; GTX	US4068
<b>626</b>				
1979-1982	L4-2.0L	1970cc	Base,LX	US1042
1983	L4-2.0L	1970cc	Base,LX	US9060
1984-1985	L4-2.0L	122 CID	LX	US9067
1984-1985	L4-2.0L	1998cc	DX,LX	US9060
1986-1987	L4-2.0L	1998cc	DX,GT,LX	US9111
1993-2002	L4-2.0L	1991cc	DX,LX,ES	US4078
1988-1992	L4-2.2L	2184cc	DX,LX,Turbo,Turbo 4WS,GT,LE	US4053
1993-2002	V6-2.5L	2497cc	ES,LX	US9318
<b>808</b>				
1975-1976	L4-1.6L	1587cc		US9295
1977	L4-1.6L	1587cc		US9300
<b>929</b>				
1988-1991	V6-3.0L	2954cc	SOHC	US9166
1989-1991	V6-3.0L	2954cc	DOHC	US9225
1992-1995	V6-3.0L	2954cc	Base	US9260
<b>B1600</b>				
1975-1976	L4-1.6L	1586cc		US9295
<b>B1800</b>				
1977-1978	L4-1.8L	1796cc		US1042
<b>B2000</b>				
1979-1984	L4-2.0L	1970cc	Base,Sundowner,Sundowner Sport,Sundowner Base, Sundowner DLX,Sundowner SE-5	US1042
1986	L4-2.0L	1998cc	Base,LX,SE-5	US9060
1987	L4-2.0L	1998cc	Base,LX,SE-5	US9111
<b>B2200</b>				
1987-1993	L4-2.2L	2184cc	Base,LX,SE-5,LE-5	US4053
<b>B2300</b>				
1994	L4-2.3L	140 CID	Base,SE	US4054
1995-1997	L4-2.3L	2295cc	Base,SE	US4093
2001-2009	L4-2.3L	2300cc	SE,SX,Base	US4126
<b>B2500</b>				
1998-2001	L4-2.5L	2492cc	SE,SX,Troy Lee	US4093
<b>B2600</b>				
1987-1988	L4-2.6L	2555cc	Base,LX,SE-5	US7120
1989-1993	L4-2.6L	2606cc	Base,LX,SE-5,LE-5	US9167
<b>B3000</b>				
1994	V6-3.0L	182 CID	Base,SE	US4039
1995-2007	V6-3.0L	2954cc	Base,SE,SX,Troy Lee,DS	US4095
<b>B4000</b>				
1994-2000	V6-4.0L	4016cc	LE,SE,Base,Troy Lee	US4060
2001-2009	V6-4.0L	4016cc	DS,SE,Base	US4108
<b>COSMO</b>				
1976-1978	R2-1.3L	1308cc		US9053
<b>CX-7</b>				
2007-2012	L4-2.3L	2260cc	Grand Touring,Sport,Touring	US4126
2010-2012	L4-2.5L	2488cc	Sport,SV,Touring	US6219
<b>CX-9</b>				
2007	V6-3.5L	213 CID	Grand Touring,Sport,Touring	US6023
2008-2011	V6-3.7L	227 CID	Grand Touring,Sport,Touring	US6023
<b>FAMILIA (MEX)</b>				
1986	L4-1.5L	1490cc	2BL	US4049

Years	Engine	Disp.	Application Description	USMW
1986	L4-1.6L	1597cc	FI	US4049
<b>GLC</b>				
1977-1978	L4-1.3L	1272cc		US9020
1979-1980	L4-1.4L	1415cc	Base,Custom,Sport	US9020
1981-1983	L4-1.5L	1490cc	Custom	US9020
1981-1985	L4-1.5L	1490cc	Early; Base,Base,Custom,Custom L,Sport,DX,LX	US9050
<b>MIATA</b>				
1990-1993	L4-1.6L	1597cc	Base,SE,LE	US4068
1994-2005	L4-1.8L	1839cc	Base,M Edition,STO,10th Anniversary,LS,SE,Shinsen, Mazdaspeed	US9305
<b>MILLENNIA</b>				
1995-2002	V6-2.3L	2254cc	S,Base,Millennium Edition	US9328
1995-2002	V6-2.5L	2497cc	Base,L,S	US9318
<b>MPV</b>				
1989-1994	L4-2.6L	2606cc	Cargo,Passenger	US9167
2000-2001	V6-2.5L	2497cc		US4091
1989-1995	V6-3.0L	2954cc	Cargo,Passenger,	US9166
1996-1998	V6-3.0L	2954cc	DX,ES,LX	US9394
2002	V6-3.0L	183 CID		US4091
2003-2006	V6-3.0L	183 CID	ES,LX,LX-SV	US4132
<b>MX-3</b>				
1992-1993	L4-1.6L	1597cc	Base	US4049
1994-1995	L4-1.6L	1597cc	Base	US9305
1992-1994	V6-1.8L	1845cc	GS,SE	US9318
<b>MX-5 MIATA</b>				
2006-2012	L4-2.0L	1997cc	Base,Club Spec,Grand Touring,Sport,Touring,SV	US6219
<b>MX-6</b>				
1993-1997	L4-2.0L	1991cc	Base	US4078
1988-1992	L4-2.2L	2184cc	DX,GT,LX,GT 4WS,LE	US4053
1993-1997	V6-2.5L	2497cc	LS,M Edition	US9318
<b>NAVAJO</b>				
1991-1994	V6-4.0L	4016cc	LX,DX	US4060
<b>PROTEGE</b>				
1995	L4-1.5L	1489cc	DX,LX	US9305
1996-1998	L4-1.5L	1489cc	DX,LX	US9371
1999-2001	L4-1.6L	1589cc	DX,LX	US9305
1990-1992	L4-1.8L	1839cc	DOHC; LX	US4068
1990-1994	L4-1.8L	1839cc	4WD,SE,DX,LX,Base	US4049
1995-1998	L4-1.8L	1839cc	ES	US9305
1999-2000	L4-1.8L	1839cc	ES	US4078
2001-2003	L4-2.0L	2000cc	ES,LX,MP3,DX,Mazdaspeed	US4078
<b>PROTEGES</b>				
2002-2003	L4-2.0L	2000cc	Base	US4078
<b>ROTARY PICKUP</b>				
1975-1977	R2-1.3L	1308cc		US9053
<b>RX-3</b>				
1975-1978	R2-1.1L	1146cc		US9053
<b>RX-4</b>				
1975-1978	R2-1.3L	1308cc		US9053
<b>RX-7</b>				
1979-1985	R2-1.1L	1146cc	GS,GSL,GSL-SE,S	US9053
1986-1988	R2-1.3L	1308cc	Base,GXL,Turbo,Base 2+2,GXL 2+2,LX,LX 2+2,Sport, 10th Anniversary,Convertible,GTU,SE,SE 2+2	US9102
1989-1991	R2-1.3L	1308cc	Convertible,GTU,GTUs,GXL,GXL 2+2,Turbo,Base	US9208
<b>RX-8</b>				
2004-2008	R2-1.3L	1308cc	Base,Shinka,40th Anniversary Edition,Grand Touring, Sport,Touring	US6156
<b>SERIE B</b>				
1996-2006	L4-2.5L	2500cc		US8923
<b>TRIBUTE</b>				
2001-2004	L4-2.0L	1991cc		US4115
2005-2006	L4-2.3L	2260cc	i	US4126
2008-2011	L4-2.3L	140 CID	Hybrid,i	US4126
2001-2003	V6-3.0L	2954cc		US4091
2004	V6-3.0L	183 CID		US4091
2005-2008	V6-3.0L	182 CID	S	US4132

Years	Engine	Disp.	Application Description	USMW
<b>MERCEDES-BENZ</b>				
<b>230</b>				
1975-1978	L4-2.3L	2307cc		US9172
<b>190D</b>				
1986-1989	L5-2.5L	2497cc	2.5,2.5 Turbo	US9228
<b>190DT (MEX)</b>				
1990	L5-2.5L	2497cc	Turbo DSL	US9228
<b>190E</b>				
1984	L4-2.3L	2299cc	2.3	US9173
1985-1993	L4-2.3L	2299cc	2.3,2.3-16	US9175
1987-1993	L6-2.6L	2599cc	2.6	US9202
<b>220E (MEX)</b>				
1994	L4-2.2L	2199cc	MFI DOHC	US9314
<b>230E (MEX)</b>				
1986-1991	L4-2.3L	2300cc	FI	US9175
<b>240D</b>				
1975-1983	L4-2.4L	2404cc	Base	US9172
<b>250D (MEX)</b>				
1986	L5-2.5L	2497cc	Diesel	US9228
<b>260E</b>				
1987-1989	L6-2.6L	2599cc	Base	US9202
<b>260E (MEX)</b>				
1992	L6-2.6L	2599cc	FI	US9202
<b>260SE (MEX)</b>				
1987-1989	L6-2.6L	2599cc	FI	US9202
<b>280E (MEX)</b>				
1993	L6-2.8L	2799cc	MFI DOHC	US9313
<b>300CD</b>				
1978-1985	L5-3.0L	3005cc	Base	US9172
<b>300CE</b>				
1988-1989	L6-3.0L	2962cc	Base	US9202
1990-1992	L6-3.0L	2962cc	Base	US9222
1993	L6-3.2L	3199cc	From Engine 072237; Base	US9345
<b>300CE (MEX)</b>				
1993	L6-3.0L	2962cc	FI	US9202
<b>300D</b>				
1990-1993	L5-2.5L	2497cc	2.5	US9228
1975-1982	L5-3.0L	3005cc	Base	US9172
1983-1985	L5-3.0L	2998cc	Base	US9172
1987	L6-3.0L	2998cc	Base	US9228
<b>300D (MEX)</b>				
1986	L5-3.0L	2998cc	Diesel	US9228
1989	L6-3.0L	2985cc	Diesel	US9172
<b>300E</b>				
1990-1992	L6-2.6L	2599cc	2.6	US9202
1993	L6-2.8L	2799cc	2.8	US9313
1986-1993	L6-3.0L	2962cc	Base,4Matic	US9202
1993	L6-3.2L	3199cc	From Engine 072237; Base	US9345
<b>300SD</b>				
1978-1982	L5-3.0L	3005cc	Base	US9172
1983-1985	L5-3.0L	2998cc	Base	US9172
1992-1993	L6-3.4L	3449cc	Base	US9228
<b>300SDL</b>				
1986-1987	L6-3.0L	2998cc	Base	US9228
<b>300SE</b>				
1988-1991	L6-3.0L	2962cc	Base	US9202
1992-1993	L6-3.2L	3199cc	Base	US9343
<b>300SEL</b>				
1988-1991	L6-3.0L	2962cc	Base	US9202
<b>300SL</b>				
1990-1993	L6-3.0L	2962cc	Base	US9222
<b>300SL (MEX)</b>				
1986	L6-3.0L	2962cc	FI	US9202
<b>300TD</b>				
1981-1982	L5-3.0L	3005cc	Base	US9172
1983-1985	L5-3.0L	2998cc	Base	US9172

Years	Engine	Disp.	Application Description	USMW
1987	L6-3.0L	2998cc	Base	US9228
<b>300TE</b>				
1988-1993	L6-3.0L	2962cc	Base,4Matic	US9202
1993	L6-3.2L	3199cc	From Engine 072237; Base	US9345
<b>300TE (MEX)</b>				
1986-1987	L6-3.0L	2962cc	FI	US9202
<b>350SD</b>				
1991	L6-3.4L	3449cc	Base	US9228
<b>350SDL</b>				
1990-1991	L6-3.4L	3449cc	Base	US9228
<b>380SE</b>				
1984-1985	V8-3.8L	3839cc	Base	US9230
<b>380SEC</b>				
1982-1983	V8-3.8L	3839cc	Base	US9230
<b>380SEL</b>				
1981-1983	V8-3.8L	3839cc	Base	US9230
<b>380SL</b>				
1981-1985	V8-3.8L	3839cc	Base	US9230
<b>380SLC</b>				
1981	V8-3.8L	3839cc	Base	US9230
<b>400E</b>				
1992-1993	V8-4.2L	4196cc	From Engine 020772; Base	US9346
1992-1993	V8-4.2L	4196cc	To Engine 020771; Base	US9315
<b>400SE</b>				
1992	V8-4.2L	4196cc	From Engine 026751; Base	US9346
<b>400SEL</b>				
1993	V8-4.2L	4196cc	From Engine 026751; Base	US9346
<b>420SE (MEX)</b>				
1986	V8-4.2L	4196cc	FI	US9231
<b>420SEL</b>				
1986-1991	V8-4.2L	4196cc	Base	US9231
<b>420SL (MEX)</b>				
1986	V8-4.2L	4196cc	FI	US9231
<b>450SE</b>				
1975-1976	V8-4.5L	4520cc		US9176
<b>450SEL</b>				
1975-1980	V8-4.5L	4520cc	Base	US9176
<b>450SL</b>				
1975-1980	V8-4.5L	4520cc	Base	US9176
<b>450SLC</b>				
1975-1980	V8-4.5L	4520cc	Base	US9176
<b>500E</b>				
1992-1993	V8-5.0L	4973cc	From Engine 010205; Base	US9346
1992-1993	V8-5.0L	4973cc	To Engine 010204; Base	US9315
<b>500SE (MEX)</b>				
1986	V8-5.0L	4973cc	FI	US9230
<b>500SEC</b>				
1984-1985	V8-5.0L	4973cc	Base	US9230
1993	V8-5.0L	4973cc	From Engine 056886; Base	US9346
<b>500SEC (MEX)</b>				
1987	V8-5.0L	4973cc	FI	US9230
<b>500SEL</b>				
1984-1985	V8-5.0L	4973cc	Base	US9230
1992-1993	V8-5.0L	4973cc	From Engine 056886; Base	US9346
1992-1993	V8-5.0L	4973cc	To Engine 056885; Base	US9315
<b>500SL</b>				
1990-1992	V8-5.0L	4973cc	Base	US9315
1993	V8-5.0L	4973cc	From Engine 013778; Base	US9346
<b>500SL (MEX)</b>				
1986	V8-5.0L	4973cc	FI	US9230
<b>560SE (MEX)</b>				
1986	V8-5.6L	5547cc	FI	US9231
<b>560SEC</b>				
1986-1991	V8-5.6L	5547cc	Base	US9231
<b>560SEL</b>				
1986-1991	V8-5.6L	5547cc	Base	US9231

WATER PUMPS



Years	Engine	Disp.	Application Description	USMW
<b>560SEL (MEX)</b>				
1994-1996	V8-5.6L	5547cc	FI	US9231
<b>560SL</b>				
1986-1989	V8-5.6L	5547cc	Base	US9231
<b>600CL (MEX)</b>				
1996-1997	V12-6.0L	5987cc	MFI DOHC	US9277
<b>600SEC</b>				
1993	V12-6.0L	5987cc	Base	US9277
<b>600SEC (MEX)</b>				
1994-1997	V12-6.0L	5987cc	MFI DOHC	US9277
<b>600SEL</b>				
1992-1993	V12-6.0L	5987cc	Base	US9277
<b>600SEL (MEX)</b>				
1991-1997	V12-6.0L	5987cc	MFI DOHC	US9277
<b>600SL</b>				
1993	V12-6.0L	5987cc	Base	US9277
<b>C220</b>				
1994-1996	L4-2.2L	2199cc	Base	US9440
<b>C230</b>				
2003-2005	L4-1.8L	1796cc	Kompressor	US6030
1997-2002	L4-2.3L	2295cc	Base,Kompressor	US9440
1999-2000	L4-2.3L	2295cc	Kompressor	US9314
2006-2007	V6-2.5L	2496cc	From 03/02/05; Sport,Sport	US6142
<b>C240</b>				
2001-2005	V6-2.6L	2597cc	Base,4Matic	US9379
<b>C280</b>				
1994-1995	L6-2.8L	2799cc	Base,To Engine 034966; Base	US9313
1995	L6-2.8L	2799cc	From Engine 034967; Base	US9345
1996-1997	L6-2.8L	2799cc	Base	US9344
1998-2000	V6-2.8L	2799cc	Base	US9379
2006-2007	V6-3.0L	2996cc	From 03/02/05; 4Matic,Luxury,4Matic	US6142
<b>C300</b>				
2008-2012	V6-3.0L	2996cc	4Matic Luxury,4Matic Sport,Luxury,Sport	US6142
<b>C320</b>				
2001-2005	V6-3.2L	3199cc	Base,4Matic	US9379
<b>C350</b>				
2006-2011	V6-3.5L	3498cc	From 03/02/05; 4Matic,Luxury,Sport	US6142
<b>C36 AMG</b>				
1995	L6-3.6L	3606cc	Base	US9345
1996-1997	L6-3.6L	3606cc	Base	US9311
<b>C43 AMG</b>				
1998-2000	V8-4.3L	4266cc	Base	US9379
<b>C55 AMG</b>				
2005-2006	V8-5.5L	5439cc	Base	US9380
<b>C55 AMG (MEX)</b>				
2007	V8-5.5L	5439cc	MFI	US9380
<b>CL500</b>				
1998-1999	V8-5.0L	4973cc	Base	US9346
2000-2005	V8-5.0L	4973cc	Base	US9379
2006	V8-5.0L	4966cc	Base	US9379
<b>CL500 (MEX)</b>				
2008-2010	V8-5.5L	5461cc	SFI DOHC	US9380
<b>CL55 AMG</b>				
2001-2002	V8-5.5L	5439cc	Base	US9380
<b>CL550</b>				
2007-2010	V8-5.5L	5461cc	Base,4Matic	US6235
<b>CL600</b>				
1998-1999	V12-6.0L	5987cc	Base	US9277
<b>CL600 (MEX)</b>				
2003	V12-5.8L	5786cc	SFI	US9277
<b>CLK320</b>				
1998-2002	V6-3.2L	3199cc	To Engine 30 033140; Base	US9380
1998-2005	V6-3.2L	3199cc	From Engine 30 033141; Base	US9379
<b>CLK350</b>				
2006-2009	V6-3.5L	3498cc	From 03/02/05; Base	US6142

Years	Engine	Disp.	Application Description	USMW
<b>CLK430</b>				
1999-2003	V8-4.3L	4266cc	Base	US9379
<b>CLK500</b>				
2003-2006	V8-5.0L	4973cc	Base	US9379
<b>CLK500 (MEX)</b>				
2007-2009	V8-5.0L	4966cc	SFI DOHC	US9379
<b>CLK55 AMG</b>				
2001-2006	V8-5.5L	5439cc	Base	US9380
<b>CLK550</b>				
2007-2009	V8-5.5L	5461cc	Base	US6235
<b>CLS500</b>				
2006	V8-5.0L	4966cc	Base	US9379
<b>CLS500 (MEX)</b>				
2007	V8-5.0L	4966cc	SFI DOHC	US9379
2008-2011	V8-5.5L	5461cc	SFI DOHC	US9380
<b>CLS550</b>				
2007-2011	V8-5.5L	5461cc	Base	US6235
<b>E280 (MEX)</b>				
1999	L6-2.8L	2800cc	FI	US9344
2007	V6-3.0L	2996cc	MFI DOHC	US6142
<b>E300</b>				
1995-1999	L6-3.0L	2996cc	Base	US9228
<b>E320</b>				
1994-1995	L6-3.2L	3199cc	From Engine 072237; Base	US9345
1994-1995	L6-3.2L	3199cc	To Engine 072236; Base	US9313
1996-1997	L6-3.2L	3199cc	Base	US9344
2005-2006	L6-3.2L	3222cc	CDI	US6152
2007-2009	V6-3.0L	2987cc	Bluetec	US6155
1998-2005	V6-3.2L	3199cc	Exc.Oil Cooler Fitting; 4Matic,Base	US9379
1998-2005	V6-3.2L	3199cc	Oil Cooler Fitting; 4Matic,Base	US9380
<b>E350</b>				
2006-2011	V6-3.5L	3498cc	From 03/02/05; 4Matic,Base	US6142
<b>E420</b>				
1994-1995	V8-4.2L	4196cc	To Engine 020771; Base	US9315
1994-1997	V8-4.2L	4196cc	From Engine 020772; Base	US9346
<b>E430</b>				
1998-2002	V8-4.3L	4266cc	Base,4Matic	US9379
<b>E500</b>				
1994	V8-5.0L	4973cc	From Engine 010205; Base	US9346
2003-2005	V8-5.0L	4973cc	Base	US9379
2004-2006	V8-5.0L	4966cc	4Matic,Base	US9379
<b>E500 (MEX)</b>				
2008-2011	V8-5.5L	5461cc	SFI DOHC	US9380
<b>E55 AMG</b>				
1999-2002	V8-5.5L	5439cc	Base	US9380
<b>E550</b>				
2007-2011	V8-5.5L	5461cc	4Matic,Base	US6235
<b>G500</b>				
2002-2008	V8-5.0L	4966cc	Exc.Oil Cooler Fitting; Base	US9379
2002-2008	V8-5.0L	4966cc	Oil Cooler Fitting; Base	US9380
2005	V8-5.0L	4973cc	Oil Cooler Fitting; Base	US9380
<b>G500L (MEX)</b>				
2000	V8-5.0L	4973cc	FI	US9379
2001	V8-5.0L	4973cc	FI	US9380
<b>G55 AMG</b>				
2003-2004	V8-5.5L	5439cc	Base	US9380
<b>G550</b>				
2009-2012	V8-5.5L	5461cc	Base	US6235
<b>GL320</b>				
2007-2009	V6-3.0L	2987cc	CDI,Bluetec 4Matic	US6155
<b>GL350</b>				
2010-2011	V6-3.0L	2987cc	Bluetec 4Matic	US6155
<b>GL450</b>				
2007-2012	V8-4.6L	4663cc	Base	US6235
<b>GL500 (MEX)</b>				
2008-2011	V8-5.5L	5461cc	SFI DOHC ; 4WD	US9380

Years	Engine	Disp.	Application Description	USMW
<b>GL550</b>				
2008-2012	V8-5.5L	5461cc	Base	US6235
<b>GLK350</b>				
2010-2012	V6-3.5L	3498cc	4Matic,Base	US6142
<b>ML320</b>				
2007-2009	V6-3.0L	2987cc	CDI,Bluetec 4Matic	US6155
1998-2003	V6-3.2L	3199cc	Base	US9379
<b>ML350</b>				
2010-2011	V6-3.0L	2987cc	Bluetec 4Matic	US6155
2006-2011	V6-3.5L	3498cc	From 03/02/05; Base	US6142
2003-2005	V6-3.7L	3699cc	Base	US9379
<b>ML430</b>				
1999-2001	V8-4.3L	4266cc	Base	US9380
<b>ML500</b>				
2002-2007	V8-5.0L	4973cc	Base	US9380
2006	V8-5.0L	4966cc	Base	US9380
<b>ML500 4WD (MEX)</b>				
2008	V8-5.0L	4966cc	SFI SOHC	US9379
<b>ML55 AMG</b>				
2000-2003	V8-5.5L	5439cc	Base	US9380
<b>ML550</b>				
2008-2011	V8-5.5L	5461cc	Base	US6235
<b>R320</b>				
2007-2008	V6-3.0L	2987cc	CDI	US6155
2009	V6-3.0L	2987cc	Bluetec	US6349
<b>R350</b>				
2010-2011	V6-3.0L	2987cc	Bluetec 4Matic	US6155
2006-2011	V6-3.5L	3498cc	From 03/02/05; 4Matic,4Matic,Base	US6142
<b>R500</b>				
2006	V8-5.0L	4966cc	Base	US9379
2007	V8-5.0L	4973cc	Base	US9379
<b>S320</b>				
1994-1996	L6-3.2L	3199cc	LWB,SWB	US9343
1997-1999	L6-3.2L	3199cc	LWB,SWB	US9351
<b>S350</b>				
1994-1995	L6-3.4L	3449cc	Base	US9228
2006	V6-3.7L	3724cc	Base	US9379
<b>S420</b>				
1994-1995	V8-4.2L	4196cc	To Engine 026750; Base	US9315
1994-1999	V8-4.2L	4196cc	From Engine 026751; Base	US9346
<b>S430</b>				
2000-2006	V8-4.3L	4266cc	Base,4Matic	US9379
<b>S430 (MEX)</b>				
1998-1999	V8-4.3L	4266cc	FI	US9379
<b>S500</b>				
1994-1995	V8-5.0L	4973cc	To Engine 056885; Base	US9315
1994-1999	V8-5.0L	4973cc	From Engine 056886; Base	US9346
2000-2006	V8-5.0L	4966cc	Base,Guard,4Matic	US9379
<b>S500L (MEX)</b>				
2007-2011	V8-5.5L	5461cc	SFI DOHC	US9380
<b>S55 AMG</b>				
2001-2002	V8-5.5L	5439cc	Base	US9380
<b>S550</b>				
2007-2011	V8-5.5L	5461cc	4Matic,Base	US6235
<b>S600</b>				
1994-1999	V12-6.0L	5987cc	Base	US9277
<b>S600L (MEX)</b>				
2008-2009	V12-5.5L	5513cc	Twin Turbo	US9380
<b>SL320</b>				
1994-1996	L6-3.2L	3199cc	From Engine 009986; Base	US9345
1994-1996	L6-3.2L	3199cc	To Engine 009985; Base	US9313
1997	L6-3.2L	3199cc	Base	US9344
<b>SL500</b>				
1994-1996	V8-5.0L	4973cc	To Engine 013777; Base	US9315
1994-1999	V8-5.0L	4973cc	From Engine 013778; Base	US9346
2000-2005	V8-5.0L	4973cc	Base	US9379

Years	Engine	Disp.	Application Description	USMW
2006	V8-5.0L	4966cc	Base	US9379
<b>SL500 (MEX)</b>				
2008-2011	V8-5.5L	5461cc	SFI DOHC	US9380
<b>SL550</b>				
2007-2012	V8-5.5L	5461cc	Base	US6235
<b>SL600</b>				
1994-2002	V12-6.0L	5987cc	Base	US9277
<b>SLK (MEX)</b>				
1996-1997	L4-2.3L	2295cc	MFI DOHC	US9314
<b>SLK230</b>				
1998-2004	L4-2.3L	2295cc	Kompressor	US9440
<b>SLK280</b>				
2006-2008	V6-3.0L	2996cc	From 03/02/05; Base	US6142
2006	V6-3.5L	3498cc	To 03/02/05; Base	US6075
<b>SLK300</b>				
2009-2011	V6-3.0L	2996cc	Base	US6142
<b>SLK320</b>				
2001-2003	V6-3.2L	3199cc	To Chassis/VIN 30 033140; Base	US9380
2001-2004	V6-3.2L	3199cc	From Chassis/VIN 30 033141; Base	US9379
<b>SLK350</b>				
2005-2006	V6-3.5L	3498cc	To 03/02/05; Base	US6075
2005-2011	V6-3.5L	3498cc	From 03/02/05; Base,Base	US6142
<b>SPRINTER (MEX)</b>				
2004-2006	L5-2.7L	2685cc	Turbo Dsl	US6007
<b>SPRINTER 2500</b>				
2010-2011	V6-3.0L	2987cc	Base	US6155
<b>SPRINTER 3500</b>				
2010-2011	V6-3.0L	2987cc	Base	US6155
<b>MERCURY</b>				
<b>BOBCAT</b>				
1975-1980	L4-2.3L	140 CID	Base,Runabout,Villager	US4005
1975-1979	V6-2.8L	171 CID		US1047
<b>CALIENTE</b>				
1964-1967	L6-3.3L	200 CID		US1044
<b>CAPRI</b>				
1991-1994	L4-1.6L	98c CID	Base,XR2	US4068
1975-1982	L4-2.3L	140 CID	Base,Ghia,GS,Black Magic,L	US4005
1983-1986	L4-2.3L	140 CID	Black Magic,Crimson Cat,GS,L,RS Turbo	US4054
1979-1982	L6-3.3L	200 CID	Base,Ghia,GS,Black Magic,L	US4002
1972	V6-2.6L	159 CID		US4067
1979	V6-2.8L	171 CID		US1047
1983-1986	V6-3.8L	232 CID	Black Magic,Crimson Cat,GS,L	US4016
1980-1982	V8-4.2L	255 CID	Base,Ghia,GS,Black Magic,L,RS	US4024
1980-1982	V8-4.2L	255 CID	High Performance; Base,Ghia,GS,Black Magic,L,RS	US4024H
1979-1984	V8-5.0L	302 CID	High Performance; RS,Exc.CFI; RS	US4024H
1979-1985	V8-5.0L	302 CID	RS,Exc.CFI; RS	US4024
1985	V8-5.0L	302 CID	RS	US4035
1986	V8-5.0L	302 CID	High Performance; 5,5	US4038H
<b>COLONY PARK</b>				
1987	V8-5.0L	302 CID	GS,LS	US4014
1988-1991	V8-5.0L	302 CID	From 06/88; GS,LS,GS	US4052
1988-1991	V8-5.0L	302 CID	From 06/88; High Performance; GS,LS	US4052H
1961-1962	V8-5.8L	352 CID		US723
1961-1964	V8-6.4L	390 CID		US723
1962-1963	V8-6.6L	406 CID		US723
1963-1964	V8-7.0L	427 CID		US723
<b>COMET</b>				
1960-1963	L6-2.4L	144 CID		US1044
1961-1972	L6-2.8L	170 CID		US1044
1963-1974	L6-3.3L	200 CID		US1044
1975-1977	L6-3.3L	200 CID		US4002
1975-1977	L6-4.1L	250 CID		US960
1975-1977	V8-5.0L	302 CID	Double tube outlet	US953
1975-1977	V8-5.0L	302 CID	High Performance	US953H
<b>COMMUTER</b>				
1961-1962	V8-5.8L	352 CID		US723
1961-1964	V8-6.4L	390 CID		US723

Years	Engine	Disp.	Application Description	USMW
1962-1963	V8-6.6L	406 CID		US723
1963-1964	V8-7.0L	427 CID		US723
<b>COUGAR</b>				
1999-2002	L4-2.0L	121 CID		US4115
1984-1986	L4-2.3L	140 CID	XR-7	US4054
1980-1982	L6-3.3L	200 CID	XR-7,Base,GS,LS	US4002
1999-2002	V6-2.5L	155 CID		US4091
1982-1987	V6-3.8L	232 CID	Base,GS,LS,XR-7	US4016
1988-1993	V6-3.8L	232 CID	LS,XR-7	US4050
1990	V6-3.8L	232 CID	XR-7	US4055
1994-1995	V6-3.8L	232 CID	XR-7	US4090
1996-1997	V6-3.8L	232 CID	XR-7	US4103
1980-1982	V8-4.2L	255 CID	XR-7,Base	US4014
1994-1997	V8-4.6L	281 CID	XR-7	US4113
1977-1979	V8-5.0L	302 CID	Double tube outlet	US953
1977-1979	V8-5.0L	302 CID	High Performance	US953H
1980-1985	V8-5.0L	302 CID	XR-7,Base,LS	US4014
1986-1988	V8-5.0L	302 CID	Base,LS,XR-7	US4038
1986-1988	V8-5.0L	302 CID	High Performance; Base, LS,XR-7	US4038H
1991-1993	V8-5.0L	302 CID	LS,XR-7	US4057
1975-1979	V8-5.8L	351 CID	Double tube outlet	US953
1975-1979	V8-5.8L	351 CID	High Performance	US953H
1975-1979	V8-5.8L	351 CID	Single tube outlet	US932
1975-1978	V8-6.6L	400 CID	Single tube outlet	US932
1975-1976	V8-7.5L	460 CID		US1114
<b>COUNTRY CRUISER</b>				
1963	L6-3.3L	200 CID		US1044
1963	V8-6.4L	390 CID		US723
<b>CYCLONE</b>				
1964	L6-3.3L	200 CID		US1044
<b>GRAND MARQUIS</b>				
1981-1982	V8-4.2L	255 CID	Base	US4014
1992-1997	V8-4.6L	281 CID	GS,LS	US4066
1998-2002	V8-4.6L	281 CID	GS,LS	US4113
2001-2011	V8-4.6L	281 CID	GS,LS,GSL,Limited Edition,Ultimate Edition	US4128
1979-1987	V8-5.0L	302 CID	Base,Colony Park,LS,GS	US4014
1988-1991	V8-5.0L	302 CID	From 06/88; GS,LS,GS	US4052
1988-1991	V8-5.0L	302 CID	From 06/88; High Performance; GS,LS,	US4052H
1979-1988	V8-5.8L	351 CID	Base,Colony Park,LS,GS,To 06/88; GS	US4014
<b>GRAND MARQUIS (MEX)</b>				
1977-1978	V8-5.8L	351 CID	4BL; Single tube outlet	US932
1979-1981	V8-5.8L	351 CID	4BL	US4052
1979-1981	V8-5.8L	351 CID	4BL High Performance	US4052H
<b>LN7</b>				
1982-1983	L4-1.6L	98 CID	Base,Grand Sport,RS,Sport	US4040
<b>LYNX</b>				
1981-1985	L4-1.6L	98 CID	Base,GL,GS,LS,RS,L,LTS,XR3	US4040
1985-1987	L4-1.9L	116 CID	Base,GL,GS,L,XR3	US4040
1984-1987	L4-2.0L	122 CID	Base,GL,GS,RS,L,XR3	US9067
<b>MARAUDER</b>				
2003-2004	V8-4.6L	281 CID	Base	US4128
1963-1964	V8-6.4L	390 CID		US723
1963	V8-6.6L	406 CID		US723
1963-1964	V8-7.0L	427 CID		US723
<b>MARINER</b>				
2005-2008	L4-2.3L	140 CID	Base,Convenience,Hybrid	US4126
2009-2011	L4-2.5L	152 CID	Base,Hybrid,Premier	US4126
2005	V6-3.0L	182 CID	Premier	US4132
2006	V6-3.0L	183 CID	To 01/30/06; Luxury,Premier	US4132
2006-2008	V6-3.0L	183 CID	From 01/30/06; Luxury,Luxury,Premier,Base	US9489
2009-2011	V6-3.0L	183 CID	Base,Premier	US6250
<b>MARQUIS</b>				
1983-1986	L4-2.3L	140 CID	Base,Brougham	US4054
1983	L6-3.3L	200 CID	Base,Brougham	US4002
1983-1986	V6-3.8L	232 CID	Base,Brougham	US4016
1981-1982	V8-4.2L	255 CID	Base,Brougham	US4014
1979	V8-5.0L	302 CID	High Performance	US953H
1980-1985	V8-5.0L	302 CID	Base,Brougham	US4014

Years	Engine	Disp.	Application Description	USMW
1978-1979	V8-5.8L	351 CID	Double tube outlet	US953
1978-1979	V8-5.8L	351 CID	High Performance	US953H
1978-1979	V8-5.8L	351 CID	Single tube outlet	US932
1980-1981	V8-5.8L	351 CID	Base,Brougham	US4014
1975-1978	V8-6.6L	400 CID	Single tube outlet	US932
1975-1978	V8-7.5L	460 CID		US1114
<b>METEOR</b>				
1961-1963	L6-2.8L	170 CID		US1044
1963	L6-3.3L	200 CID		US1044
1961-1962	V8-5.8L	352 CID		US723
1961-1963	V8-6.4L	390 CID		US723
<b>MILAN</b>				
2006-2009	L4-2.3L	140 CID	Base,Premier	US4126
2010-2011	L4-2.5L	152 CID	Base,Hybrid,Premier	US4126
2006-2009	V6-3.0L	183 CID	Base,Premier	US9489
2010-2011	V6-3.0L	183 CID	Premier	US6250
<b>MONARCH</b>				
1975-1977	L6-3.3L	200 CID		US4002
1975-1980	L6-4.1L	250 CID	Base	US960
1980	V8-4.2L	255 CID	High Performance; Base	US953H
1975-1980	V8-5.0L	302 CID	Double tube outlet; Base	US953
1975-1980	V8-5.0L	302 CID	High Performance; Base	US953H
1975-1977	V8-5.8L	351 CID	Double tube outlet	US953
1975-1977	V8-5.8L	351 CID	High Performance	US953H
<b>MONTCLAIR</b>				
1964	V8-6.4L	390 CID		US723
1964	V8-7.0L	427 CID		US723
<b>MONTEGO</b>				
1968	L6-3.3L	200 CID		US1044
2005-2007	V6-3.0L	183 CID		US6186
1975-1976	V8-5.8L	351 CID	Double tube outlet	US953
1975-1976	V8-5.8L	351 CID	High Performance	US953H
1975-1976	V8-5.8L	351 CID	Single tube outlet	US932
1975-1976	V8-6.6L	400 CID	Single tube outlet	US932
1975-1976	V8-7.5L	460 CID		US1114
<b>MONTEREY</b>				
2004-2007	V6-4.2L	256 CID	Base,Premier,Luxury	US4102
1961-1962	V8-5.8L	352 CID		US723
1961-1964	V8-6.4L	390 CID		US723
1962-1963	V8-6.6L	406 CID		US723
1963-1964	V8-7.0L	427 CID		US723
<b>MOUNTAINEER</b>				
1998-2010	V6-4.0L	245 CID	Base,Premier,Convenience,Luxury	US4108
2002-2010	V8-4.6L	281 CID	Base,Premier,Luxury	US4127
1997-2001	V8-5.0L	302 CID	Base	US4101
<b>MYSTIQUE</b>				
1995-1997	L4-2.0L	121 CID	Base,GS,GS Spree,LS	US4088
1998-2000	L4-2.0L	121 CID	From 12/97; GS,LS	US4115
1995-2000	V6-2.5L	155 CID		US4091
<b>PARK LANE</b>				
1964	V8-6.4L	390 CID		US723
1964	V8-7.0L	427 CID		US723
<b>SABLE</b>				
1986	L4-2.5L	153 CID	GS,LS	US4056
1986-1994	V6-3.0L	182 CID	GS,LS	US4034
1995-2005	V6-3.0L	182 CID	OHV; GS,LS,OHV; G,GS,LTS,LS Premium	US4094
1996-2000	V6-3.0L	182 CID	DOHC; G,GS,LS,LTS,DOHC; GS,LS Premium	US4098
2001-2004	V6-3.0L	182 CID	To 04/01/03	US4091
2003-2005	V6-3.0L	183 CID	From 04/01/03; GS,LS,LS Premium,Platinum Edition	US4132
2008-2009	V6-3.5L	213 CID	Base,Premier	US6023
1988-1993	V6-3.8L	232 CID	GS,LS	US4051
1994-1995	V6-3.8L	232 CID	GS,LS	US4089
<b>TOPAZ</b>				
1984-1986	L4-2.0L	122 CID	Base,GS,LS	US9067
1984-1991	L4-2.3L	140 CID	Base,GS,LS,GS AWD,LS AWD,Sport,Sport AWD, XR5,LTS,LTS AWD,XR5 AWD	US4022
1992-1994	L4-2.3L	140 CID	GS,LTS,Sport,XR5	US4041
1992-1994	V6-3.0L	182 CID	GS,LTS,Sport,XR5	US4070



Years	Engine	Disp.	Application Description	USMW
<b>TOPAZ (MEX)</b>				
1984-1989	L4-2.3L	140 CID	2BL	US4022
<b>TRACER</b>				
1988-1989	L4-1.6L	98c CID	Base	US4049
1991-1996	L4-1.8L	112 CID	From 04/91; Base,Trio,Base, To 05/94; Base	US4069
1991-1996	L4-1.8L	112 CID	LTS	US4068
1991	L4-1.9L	116 CID	To 04/91; Base,Trio	US4065
1997-1999	L4-2.0L	121 CID	GS,LS,Trio	US4107
<b>VILLAGER</b>				
1962-1963	L6-2.4L	144 CID		US1044
1962-1967	L6-2.8L	170 CID		US1044
1963-1967	L6-3.3L	200 CID		US1044
1993-1998	V6-3.0L	182 CID	GS,LS,Nautica	US9074
1999-2002	V6-3.3L	3275cc	Base,Estate,Sport	US9402
<b>VOYAGER</b>				
1966-1967	L6-2.8L	170 CID		US1044
1966-1967	L6-3.3L	200 CID		US1044
<b>ZEPHYR</b>				
1978-1982	L4-2.3L	140 CID	Base,Z7,GS	US4005
1983	L4-2.3L	140 CID	Base,GS,Z7,Z7 GS	US4054
1978-1983	L6-3.3L	200 CID	Base,Z7,GS,Z7 GS	US4002
1980-1982	V8-4.2L	255 CID	Double tube outlet; Base,Z7,GS	US953
1980-1982	V8-4.2L	255 CID	High Performance; Base,Z7,GS	US953H
1978-1979	V8-5.0L	302 CID	Double tube outlet	US953
1978-1979	V8-5.0L	302 CID	High Performance	US953H
<b>MERKUR</b>				
<b>SCORPIO</b>				
1988-1989	V6-2.9L	177 CID	Base	US4045
<b>XR4TI</b>				
1985-1989	L4-2.3L	140 CID	Base	US4054
<b>MG</b>				
<b>GT</b>				
1972-1980	L4-1.8L	1798cc		US9082
<b>MGB</b>				
1972-1980	L4-1.8L	1798cc		US9082
<b>MINI</b>				
<b>COOPER</b>				
2002-2006	L4-1.6L	1600cc	Base	US9474
2007-2013	L4-1.6L	1598cc	Base,S,Clubman,S Clubman,John Cooper Works, John Cooper Works Clubman,Coupe, Coupe John Cooper Works,Coupe S,Roadster, Roadster John Cooper Works,Roadster S, John Cooper Works GP	US6244
<b>COOPER COUNTRYMAN</b>				
2011-2013	L4-1.6L	1598cc	Base,S,S ALL4,John Cooper Works ALL4	US6244
<b>MITSUBISHI</b>				
<b>3000GT</b>				
1991-1999	V6-3.0L	2972cc	Base,SL,VR-4,Spyder SL,Spyder VR-4	US7129
1997-1999	V6-3.0L	2972cc	Base	US7121
<b>CANTOR</b>				
1996-2001	L4-3.9L	3907cc	Diesel	US8965
<b>CORDIA</b>				
1983-1988	L4-1.8L	1795cc	Base,L,LS,Turbo	US7118
1984-1988	L4-2.0L	1997cc	Base,L,LS	US7118
<b>DIAMANTE</b>				
1992-1994	V6-3.0L	2972cc	LS	US7129
1992-1996	V6-3.0L	2972cc	ES,LS	US7121
1997-2004	V6-3.5L	3497cc	ES,LS,Base,VR-X	US7152
<b>ECLIPSE</b>				
1990-1994	L4-1.8L	1755cc	Base,GS	US7108
1990-1994	L4-2.0L	1997cc	GS,GST,GSX	US9212
1995-1999	L4-2.0L	1997cc	GS,RS,Base	US7150
1995-1999	L4-2.0L	1997cc	GST,GSX,Spyder GST	US7148
1996-1999	L4-2.4L	2351cc	Spyder GS	US7148

Years	Engine	Disp.	Application Description	USMW
2000-2005	L4-2.4L	2351cc	GS,RS,Spyder GS	US9399
2006-2012	L4-2.4L	2378cc	GS,Spyder GS,SE,GS Sport,Spyder GS Sport, Spyder SE	US6149
2000-2005	V6-3.0L	2972cc	GT,Spyder GT,GTS,Spyder GTS, To 09/03; GT	US7152
2006-2012	V6-3.8L	3828cc	GT,Spyder GT,SE	US7152
<b>ENDEAVOR</b>				
2004-2011	V6-3.8L	3797cc	To 09/03; Limited,LS,XLS,Limited,SE	US7152
<b>ENDEAVOR (MEX)</b>				
2010-2011	V6-3.8L	3828cc	MFI SOHC ; Limited,XLS	US7152
<b>EXPO</b>				
1992	L4-2.4L	2351cc	Base,SP	US9168
1993-1995	L4-2.4L	2351cc	Base,SP	US7148
<b>EXPO LRV</b>				
1992-1994	L4-1.8L	1834cc	Base,Sport,To 03/93; Base	US7135
1993-1994	L4-2.4L	2351cc	Base,Sport	US7148
<b>GALANT</b>				
1989-1992	L4-2.0L	1997cc	Base,LS	US9168
1989-1992	L4-2.0L	1997cc	GS,GSX,GSR,VR-4	US9212
1993	L4-2.0L	1997cc	ES,LS,S	US7148
1985-1987	L4-2.4L	2351cc	Base	US7118
1994-1998	L4-2.4L	2351cc	ES,GS,LS,S,DE	US7148
1999-2003	L4-2.4L	2351cc	DE,ES,LS	US9399
2004-2011	L4-2.4L	2351cc	DE,ES,Sport Edition,SE	US6149
1988	V6-3.0L	2972cc	Sigma	US7121
1999-2003	V6-3.0L	2972cc	ES,GTZ,LS	US7152
2004-2009	V6-3.8L	3828cc	TO 10/03; GTS,LS,GTS,Ralliart,Sport V6	US7152
<b>GRANDIS (MEX)</b>				
2007-2009	L4-2.4L	2378cc	MFI SOHC	US9399
<b>L200</b>				
1992-1996	L4-2.5L	2477cc		US8922
<b>L200 (MEX)</b>				
2008-2012	L4-2.4L	2378cc	MFI SOHC	US9399
<b>LANCER</b>				
2002-2004	L4-2.0L	2000cc	ES,LS,OZ Rally	US9360
2003-2005	L4-2.0L	2000cc	Turbo; Evolution,To 07/05; Turbo; Evolution, Evolution MR,Evolution RS	US6159
2005-2007	L4-2.0L	1997cc	ES,Evolution,Evolution MR,Evolution RS,OZ Rally Evolution SE,SE	US9360
2008-2011	L4-2.0L	1998cc	DE,ES,Evolution GSR,Evolution MR,GTS,Ralliart, Ralliart Sportback,ES Sportback,Evolution MR Touring	US6038
2004	L4-2.4L	2400cc	Ralliart,Sportback	US6149
2005-2006	L4-2.4L	2378cc	Ralliart	US6149
2009-2011	L4-2.4L	2360cc	GTS,Evolution MR Touring,GTS Sportback	US6038
<b>MIGHTY MAX</b>				
1983	L4-2.0L	122 CID	Base	US7114
1983-1989	L4-2.0L	1997cc	S,Base	US7114
1983-1985	L4-2.3L	143 CID	SP,SPX	US7117
1990-1996	L4-2.4L	2351cc	1 Ton,Base	US7114
1983-1989	L4-2.6L	2555cc	SP,SPX,Base,Sport,1 Ton	US7116
1990-1994	V6-3.0L	2972cc	1 Ton,Base	US7121
<b>MIRAGE</b>				
1985-1996	L4-1.5L	90 CID	Base,L,LS,RS,VL,SE,ES,S	US7115
1997-2002	L4-1.5L	1468cc	DE,	US9359
1985-1988	L4-1.6L	1597cc	Turbo	US7108
1989-1992	L4-1.6L	1597cc	Turbo,GS	US7131
1993-1996	L4-1.8L	1834cc	To 03/93; ES,LS,ES	US7135
1997-2002	L4-1.8L	1834cc	LS,DE,ES	US9360
<b>MONTERO</b>				
2001-2006	L4-2.5L	2477cc		US8922
1983-1984	L4-2.6L	2555cc	Base,Sport	US7120
1983-1989	L4-2.6L	2555cc	Base,Sport,SP	US7116
1989-1994	V6-3.0L	2972cc	Base,LS,SP,Sport,RS,SR	US7121
1995-1996	V6-3.0L	2972cc	LS	US9460
1994-1996	V6-3.5L	3497cc	SR,To 04/96; SR	US9310
1996-2000	V6-3.5L	3497cc	From 05/96; SR,LS,SR,Base	US9460
2001-2003	V6-3.5L	3497cc	Limited,XLS	US9415
2004-2005	V6-3.8L	3797cc	Limited,XLS	US9415

Years	Engine	Disp.	Application Description	USMW
2006	V6-3.8L	3828cc	Limited	US9415
<b>MONTERO (MEX)</b>				
2005-2009	V6-3.5L	3497cc	FI SOHC	US7152
2008-2009	V6-3.8L	3800cc	FI ; 4WD	US7152
2010-2011	V6-3.8L	3828cc	MFI SOHC ; Limited 4WD	US7152
<b>MONTERO SPORT</b>				
1997-1999	L4-2.4L	2351cc	ES	US9389
1997-2004	V6-3.0L	2972cc	LS,XLS,ES	US9460
1999-2004	V6-3.5L	3497cc	Limited,XLS	US9460
<b>OUTLANDER</b>				
2008-2011	L4-2.0L	1998cc	ES,SE	US6038
2003	L4-2.4L	2351cc	LS,XLS	US6228
2004	L4-2.4L	2351cc	LS,XLS	US6149
2005-2006	L4-2.4L	2378cc	Limited,LS,XLS,SE	US6149
2007-2011	V6-3.0L	2998cc	ES,LS,XLS,GT	US6240
<b>OUTLANDER SPORT</b>				
2011	L4-2.0L	1998cc	ES,SE	US6038
<b>PAJERO</b>				
1993-1999	L4-2.8L	2835cc		US8902
<b>PRECIS</b>				
1987-1994	L4-1.5L	1468cc	Base,LS,RS	US7115
<b>RAIDER</b>				
2006-2009	V6-3.7L	226 CID	DuroCross,LS	US7163
2006-2007	V8-4.7L	285 CID	DuroCross,XLS,LS,SE	US7163
<b>SIGMA</b>				
1989-1990	V6-3.0L	2972cc	Base	US7121
<b>SPACE STAR (MEX)</b>				
2003-2004	L4-1.8L	1755cc	FI SOHC	US9360
<b>STARION</b>				
1983-1987	L4-2.6L	2555cc	Base,LS,ES,LE,ESI,ESI-R,To 11/86; ESI-R	US7116
1985-1986	L4-2.6L	2555cc	From 02/85; ESI,LE,ESI-R	US7120
1987-1989	L4-2.6L	2555cc	From 12/86; ESI-R,ESI-R,LE,ESI	US7124
<b>VAN</b>				
1987-1990	L4-2.4L	2351cc	Base,LS	US7114
<b>NISSAN</b>				
<b>210</b>				
1980-1982	L4-1.2L	1237cc	Base	US9026
1979-1982	L4-1.4L	1393cc	Air Cond.;Deluxe,Base,MPG	US9026
1980-1982	L4-1.5L	1488cc	Deluxe	US9026
<b>310</b>				
1980	L4-1.4L	1393cc	Deluxe,GX	US9010
1981	L4-1.5L	1488cc	Deluxe,GX	US9010
1982	L4-1.5L	1488cc	Deluxe,GX	US9041
<b>510</b>				
1978-1981	L4-2.0L	1952cc	Exc.Air Cond.;Exc.Air Cond; Base	US9008
1978-1981	L4-2.0L	1952cc	To 01/79; Base	US9031
<b>610</b>				
1975-1976	L4-2.0L	1952cc	Air Cond.;	US9031
1975-1976	L4-2.0L	1952cc	Exc.Air Cond	US9008
<b>620</b>				
1975-1979	L4-2.0L	1952cc	Air Cond	US9031
1975-1979	L4-2.0L	1952cc	Exc.Air Cond	US9008
<b>710</b>				
1975-1977	L4-2.0L	1952cc	Air Cond.;	US9031
1975-1977	L4-2.0L	1952cc	Exc.Air Cond	US9008
<b>720</b>				
1980-1986	L4-2.0L	1952cc	Deluxe,Base	US9031
1981-1983	L4-2.2L	2164cc	Deluxe	US9198
1981-1983	L4-2.2L	2187cc	w/Fan Clutch; Base,Deluxe	US9031
1981-1983	L4-2.2L	2187cc	wo/Fan Clutch; Base,Deluxe	US9009
1983-1986	L4-2.4L	2389cc	Base,Deluxe,Sport Truck	US9031
1983-1986	L4-2.5L	2488cc	Deluxe	US9198
<b>810</b>				
1977-1981	L6-2.4L	2393cc	Base,DX	US9011
1981	L6-2.8L	2793cc	DX	US9011

Years	Engine	Disp.	Application Description	USMW
<b>200SX</b>				
1995-1998	L4-1.6L	1597cc	Base,SE	US9214
1984-1986	L4-1.8L	1809cc	Turbo	US9063
1977-1981	L4-2.0L	1952cc	From 02/79; Base	US9031
1984-1988	L4-2.0L	1974cc	Base,XE,SE	US9063
1995-1998	L4-2.0L	1998cc	Base,SE-R	US9213
1982-1983	L4-2.2L	2187cc	Base	US9031
1987-1988	V6-3.0L	2960cc	From 04/87; SE,SE	US9058
<b>240SX</b>				
1989-1998	L4-2.4L	2389cc	SE,XE,Base,LE	US9206
<b>280Z</b>				
1975-1978	L6-2.8L	2753cc		US9011
<b>280ZX</b>				
1979-1983	L6-2.8L	2753cc	2+2 GL,Base,GL,GL Turbo,2+2,2+2 Turbo,Turbo	US9011
<b>300ZX</b>				
1984-1989	V6-3.0L	2960cc	2+2,Base,Turbo,From 05/87; 2+2	US9058
1990-1996	V6-3.0L	2960cc	2+2,Base,Turbo	US9201
<b>350Z</b>				
2003-2009	V6-3.5L	3498cc	Base,Enthusiast,Performance,Touring,Track,35th Anniversary Edition,Grand Touring,Nismo	US9426
<b>370Z</b>				
2009-2012	V6-3.7L	3696cc	Base,Nismo,Touring,40th Anniversary Edition	US9426
<b>ALMERA (MEX)</b>				
2000-2005	L4-1.8L	1769cc	MFI DOHC	US9416
2002-2004	L4-1.8L	1781cc	FI DOHC	US9416
<b>ALTIMA</b>				
1993-2001	L4-2.4L	2389cc		US9270
2002-2012	L4-2.5L	2500cc	Base,S,SL,Hybrid	US9427
2002-2006	V6-3.5L	3498cc	Base,S,SE,SL,SE-R	US9426
2007-2012	V6-3.5L	3498cc	SE,SL,SR	US6198
<b>ALTIMA SL (MEX)</b>				
2010-2011	L4-2.5L	2488cc	FI DOHC	US9427
<b>APRIO (MEX)</b>				
2008-2009	L4-1.6L	1597cc	MFI DOHC	US8927
2010	L4-1.6L	1598cc	MFI DOHC ; Convenience,	US8927
<b>ARMADA</b>				
2005-2012	V8-5.6L	5552cc	LE,SE,SE Off-Road,Platinum,Titanium,SL,SV	US9488
<b>AXXESS</b>				
1990	L4-2.4L	2389cc	SE,XE	US9162
<b>B210</b>				
1975-1978	L4-1.4L	1393cc	Air Cond	US9026
1975-1978	L4-1.4L	1393cc	Exc.Air Cond	US9010
<b>CABSTAR (MEX)</b>				
2008-2011	L4-2.5L	2488cc	Turbo Dsl	US9206
<b>CEFIRO (MEX)</b>				
1997	L6-3.0L	2988cc	MFI DOHC	US9309
<b>CUBE</b>				
2009-2013	L4-1.8L	1798cc	Base,Krom,S,SL,	US6218
<b>D21</b>				
1986-1989	L4-2.4L	2389cc	Base,E,XE,From 04/88; Base	US9031
1990-1994	L4-2.4L	2389cc	Base,XE	US9206
1986-1994	V6-3.0L	2960cc	4WD; E,SE,4WD; Base,4WD; SE,XE	US9104
1986-1994	V6-3.0L	2960cc	RWD; E,SE,RWD; Base,XE	US9058
<b>FAMILIA</b>				
1994-1997	L4-1.7L	1700cc		US8958
<b>FRONTIER</b>				
1998-2004	L4-2.4L	2389cc	Base,SE,XE	US9206
2005-2011	L4-2.5L	2500cc	XE,SE,S,SV	US6242
1999-2004	V6-3.3L	3275cc	SE,XE,SC,SVE	US9338
2005-2012	V6-4.0L	3954cc	LE,Nismo Off-Road,SE,PRO-4X,S,SL,SV	US9426
<b>FRONTIER (MEX)</b>				
2006	V6-2.4L	2389cc	MFI DOHC	US6242
<b>FRONTIER PICKUP (MEX)</b>				
2006-2007	L4-2.4L	2389cc	MFI DOHC	US9426
2008	L4-2.4L	2389cc	MFI DOHC	US9206

Years	Engine	Disp.	Application Description	USMW
<b>GT-R</b>				
2009-2012	V6-3.8L	3799cc	Base,Premium	US9426
<b>HIKARI (MEX)</b>				
1987-1992	L4-1.6L	1597cc	2BL ,,,,FI Turbo	US9284
<b>ICHI VAN (MEX)</b>				
1987-1989	L4-1.8L	1800cc	2BL	US9116
1990-1992	L4-1.8L	1800cc	2BL	US9179
1991-1994	L4-2.4L	2389cc	FI	US9206
<b>LUCINO (MEX)</b>				
1995-2000	L4-1.6L	1597cc	MFI DOHC	US9214
1996-2000	L4-2.0L	1998cc	MFI DOHC	US9213
<b>MAXIMA</b>				
1982-1984	L6-2.4L	2393cc	GL	US9011
1982-1983	L6-2.8L	2793cc	GL	US9011
1985-1994	V6-3.0L	2960cc	GL,SE,GXE	US9074
1992-1994	V6-3.0L	2960cc	SE	US9252
1995-2001	V6-3.0L	2988cc	GLE,GXE,SE,SE 20th Anniversary Edition	US9309
2002-2008	V6-3.5L	3498cc	GLE,GXE,SE,SL	US9426
2009-2012	V6-3.5L	3498cc	S,SV	US6198
<b>MAXIMA SPORT (MEX)</b>				
2010	L4-3.5L	3500cc	SFI DOHC	US8925
<b>MAXIMA TRACKING (MEX)</b>				
2010	L4-3.5L	3500cc	SFI DOHC	US8925
<b>MICRA</b>				
2006-2007	L4-1.4L	85 CID		US8967
<b>MURANO</b>				
2003-2007	V6-3.5L	3498cc	SE,SL,S,To 03/07; S	US9426
2007-2012	V6-3.5L	3498cc	From 03/07; S,SE,SL,LE,S,CrossCabriolet,SV	US6198
<b>MURANO (MEX)</b>				
2008	V6-3.5L	3500cc	FI DOHC	US9426
<b>MURANO AWD (MEX)</b>				
2008	V6-3.5L	3500cc	FI DOHC	US9426
<b>NISSAN SEDAN (MEX)</b>				
1985-1984	L4-1.6L	1597cc	2BL	US9009
1982-1984	L4-1.8L	1750cc	2BL	US9063
<b>NV1500</b>				
2012	V6-4.0L	3954cc	S,SV	US9426
<b>NV2500</b>				
2012	V6-4.0L	3954cc	S,SV	US9426
2012	V8-5.6L	5552cc	S,SV	US9488
<b>NV3500</b>				
2012	V6-4.0L	3954cc	S,SV	US9426
2012	V8-5.6L	5552cc	S,SL,SV	US9488
<b>NX</b>				
1991-1993	L4-1.6L	1597cc	SE,XE	US9214
1991-1993	L4-2.0L	1998cc	SE,XE	US9213
<b>PATHFINDER</b>				
1987	L4-2.4L	2389cc	E	US9031
1987-1995	V6-3.0L	2960cc	SE,XE,LE	US9104
1996-2000	V6-3.3L	3275cc	LE,SE,XE	US9338
2001-2004	V6-3.5L	3498cc	LE,SE,XE	US9309
2005-2012	V6-4.0L	3954cc	LE,SE,SE Off-Road,XE,S,Silver Edition,SV	US9426
2004-2012	V8-5.6L	5552cc	Armada LE,Armada SE,LE,SE	US9488
<b>PATROL</b>				
1988-1997	L6-4.2L	4169cc		US8941
<b>PICKUP</b>				
1995-1997	L4-2.4L	2389cc	Base,XE,SE	US9206
1995	V6-3.0L	2960cc	XE,SE	US9104
<b>PICKUP (MEX)</b>				
1965-1969	L4-1.3L	1300cc	2BL	US9179
1970-1983	L4-1.6L	1600cc	2BL	US9009
1981-1986	L4-1.8L	1800cc	2BL	US9063
1985-1990	L4-1.8L	1800cc	1BL	US9116
1991-1994	L4-1.8L	1800cc	FI	US9179
1991-2012	L4-2.4L	2389cc	FI ,MFI DOHC	US9206
2009-2012	L4-2.5L	2488cc	Turbo Dsl	US9206

Years	Engine	Disp.	Application Description	USMW
<b>PICKUP 4WD (MEX)</b>				
2009-2012	L4-2.5L	2488cc	Turbo Dsl	US9206
<b>PLATINA (MEX)</b>				
2002-2010	L4-1.6L	1598cc	MFI DOHC	US8927
2010	L4-1.6L	1597cc	MFI DOHC ; Emotion,Premium	US8927
<b>PRIMERA (MEX)</b>				
1992	L4-2.0L	1998cc	MFI DOHC	US9213
<b>PULSAR</b>				
1983	L4-1.6L	1597cc	Base	US9041
<b>PULSAR NX</b>				
1983	L4-1.5L	1488cc	Turbo	US9041
1983-1988	L4-1.6L	1597cc	Base,XE	US9041
1987	L4-1.6L	1597cc	To 10/86; SE	US9063
1989-1990	L4-1.6L	1597cc	XE	US9207
1987-1989	L4-1.8L	1809cc	From 10/86; SE,SE	US9116
<b>PULSER</b>				
1993-1997	L4-1.7L	1700cc		US8958
<b>QUEST</b>				
1993-1998	V6-3.0L	2960cc	GXE,XE	US9074
1999-2002	V6-3.3L	3275cc	GLE,GXE,SE	US9402
2004-2009	V6-3.5L	3498cc	S,SE,SL,Base	US9426
2011-2012	V6-3.5L	3498cc	LE,S,SL,SV	US6198
<b>ROGUE</b>				
2008-2012	L4-2.5L	2500cc	S,SL,Krom,Srom,SV	US9427
<b>ROGUE SL (MEX)</b>				
2011	L4-2.5L	2488cc	FI DOHC	US9427
<b>ROGUE SL AWD (MEX)</b>				
2011	L4-2.5L	2488cc	FI DOHC	US9427
<b>SAKURA (MEX)</b>				
1982-1987	L4-1.8L	1750cc	2BL	US9063
<b>SAMURAI (MEX)</b>				
1980-1984	L4-1.8L	1750cc	2BL	US9063
<b>SENTRA</b>				
1983	L4-1.5L	1488cc	Base,DX	US9041
1982-1988	L4-1.6L	1597cc	Base,DX,XE,SE,E,GXE	US9041
1989-1990	L4-1.6L	1597cc	Base,E,SE,XE	US9207
1991-1999	L4-1.6L	1597cc	E,GXE,SE,XE,Limited Edition,Base,GLE	US9214
1983-1986	L4-1.7L	1688cc	Base,DX,SE,XE	US9044
2000-2006	L4-1.8L	1809cc	GXE,XE,CA,Base,S	US9416
1991-2001	L4-2.0L	1998cc	SE-R,SE,CA	US9213
2007-2012	L4-2.0L	1997cc	Base,S,SL,SR	US6218
2002-2012	L4-2.5L	2500cc	SE-R,SE-R Spec V,Limited Edition,S	US9427
<b>SENTRA (MEX)</b>				
2000	L4-1.6L	1597cc	MFI DOHC	US9213
1996-1997	L4-2.0L	1998cc	MFI DOHC	US9213
2010-2012	L4-2.0L	1997cc	MFI DOHC ; Custom,Emotion,Luxury,Premium, Sport Road,Elite	US6218
<b>STANZA</b>				
1982-1986	L4-2.0L	1974cc	Base,GL,XE	US9114
1987-1989	L4-2.0L	1974cc	E,GXE,XE	US9116
1990-1992	L4-2.4L	2389cc	GXE,XE,SE	US9162
<b>STATION WAGON (MEX)</b>				
1965-1984	L4-1.6L	1597cc	2BL	US9009
1982-1984	L4-1.8L	1750cc	2BL	US9063
<b>SUNNY</b>				
1993-1997	L4-1.7L	1700cc		US8958
<b>TERRANO</b>				
1993-2002	L4-2.7L	2663cc	Diesel	US8930
<b>TIIDA (MEX)</b>				
2007	L4-1.8L	1800cc	SFI	US9426
2008	L4-1.8L	1798cc	SFI DOHC	US9426
2009	L4-1.8L	1798cc	SFI DOHC	US8925
<b>TITAN</b>				
2004-2012	V8-5.6L	5552cc	LE,SE,XE,PRO-4X,S,SL,SV	US9488
<b>TSUBAME (MEX)</b>				
1993-2004	L4-1.6L	1597cc	MFI DOHC	US9214



Years	Engine	Disp.	Application Description	USMW
<b>TSURU (MEX)</b>				
1984-1987	L4-1.5L	1487cc	1BL	US9041
1985	L4-1.5L	1487cc	1BL ; Samurai	US9284
1986-1987	L4-1.6L	1597cc	1BL ; Samurai	US9284
1988-2012	L4-1.6L	1597cc	2BL ;,MFI DOHC ;,MFI DOHC ; GS,MFI DOHC ; GSI,GSII	US9214
1995-1997	L4-1.6L	1598cc	MFI SOHC	US9214
1993-1996	L4-2.0L	1998cc	MFI DOHC	US9213
<b>URVAN (MEX)</b>				
2000-2005	L4-2.4L	2389cc	FI	US9206
2006-2007	L4-2.4L	2392cc	MFI DOHC	US9206
2008-2009	L4-2.5L	2500cc	SFI DOHC	US9427
<b>VAN</b>				
1987-1988	L4-2.4L	2389cc	E,GXE,XE	US9110
<b>VERSA</b>				
2009-2011	L4-1.6L	1598cc	1.6,1.6 Base	US6687
2007-2012	L4-1.8L	1798cc	S,SL,1.8 S,1.8 SL	US6218
<b>XTRERRA</b>				
2000-2004	L4-2.4L	2389cc	SE,XE	US9206
2000-2004	V6-3.3L	3275cc	SE,XE	US9338
2005-2012	V6-4.0L	3954cc	Off-Road,S,SE,X,PRO-4X	US9426
<b>X-TRAIL (MEX)</b>				
2002-2009	L4-2.5L	2500cc	SFI DOHC	US9427
<b>X-TRAIL 4WD (MEX)</b>				
2010	L4-2.5L	2500cc	SFI DOHC	US9427
<b>X-TRAIL LE (MEX)</b>				
2010	L4-2.5L	2500cc	SFI DOHC	US9427
<b>X-TRAIL SLX (MEX)</b>				
2010	L4-2.5L	2500cc	SFI DOHC	US9427
<b>OLDSMOBILE</b>				
<b>88</b>				
1992-1995	V6-3.8L	231 CID	Royale,Royale LS,Royale LSS	US5050
1996-1999	V6-3.8L	231 CID	Royale,Royale LS	US5075
<b>98</b>				
1985	V6-3.0L	181 CID	Regency	US5028
1985	V6-3.8L	231 CID	Regency,Regency Brougham	US5028
1986-1995	V6-3.8L	231 CID	Regency,Regency Brougham,Regency Grande, Regency Touring,Regency Elite,Touring	US5050
1996	V6-3.8L	231 CID	Regency Elite	US5075
1981-1983	V6-4.1L	252 CID	High Performance; Luxury,Regency, High Performance; Regency,Regency Brougham	US1018H
1981-1983	V6-4.1L	252 CID	Luxury,Regency,Regency Brougham	US1018
1985	V6-4.3L	260 CID	Regency,Regency Brougham	US5014
1980-1981	V8-5.0L	307 CID	Exc.Air Cond; Luxury,Regency	US1100
1980-1984	V8-5.0L	307 CID	Air Cond; High Performance; Luxury,Regency, Regency Brougham	US1120H
1980-1984	V8-5.0L	307 CID	Air Cond; Luxury,Regency,Air Cond; Regency, Regency Brougham	US1120
1977-1981	V8-5.7L	350 CID	Exc.Air Cond; Exc.Air Cond; Luxury,Regency	US1100
1977-1984	V8-5.7L	350 CID	Air Cond; High Performance;Luxury,Regency, Regency Brougham	US1120H
1977-1984	V8-5.7L	350 CID	Air Cond; Luxury,Regency,Regency Brougham	US1120
1975	V8-6.6L	400 CID	Air Cond; High Performance;,,	US1120H
1977-1979	V8-6.6L	403 CID	Air Cond	US1120
1977-1979	V8-6.6L	403 CID	Air Cond; High Performance	US1120H
1977-1979	V8-6.6L	403 CID	Exc.Air Cond	US1100
1975-1976	V8-7.5L	455 CID	Air Cond	US1120
1975-1976	V8-7.5L	455 CID	Air Cond; High Performance	US1120H
1975-1976	V8-7.5L	455 CID	Exc.Air Cond	US1100
<b>ACHIEVA</b>				
1992-1994	L4-2.3L	140 CID	S,SC,SCX,SL	US5043
1992-1995	L4-2.3L	138 CID	S,SC,SL	US5043
1996-1998	L4-2.4L	146 CID	S,SC,SL	US5076
1994-1998	V6-3.1L	189 CID	S,SC,SL	US5033
1992-1993	V6-3.3L	204 CID	S,SC,SL	US5050
<b>ALERO</b>				
2002-2004	L4-2.2L	134 CID	GL,GLS,GX	US5092

Years	Engine	Disp.	Application Description	USMW
1999-2001	L4-2.4L	146 CID	GL,GLS,GX	US5076
2004	V6-3.1L	189 CID	GLS	US5033
1999-2004	V6-3.4L	207 CID	GL,GLS,GX	US5033
<b>AURORA</b>				
2001-2002	V6-3.5L	214 CID	Base	US5085
1995-2003	V8-4.0L	244 CID	Base	US5072
<b>BRAVADA</b>				
2002-2004	L6-4.2L	256 CID	Base	US5097
1991-1994	V6-4.3L	262 CID	Base	US5049
1991-1994	V6-4.3L	262 CID	High Performance; Base	US5049H
1996-2001	V6-4.3L	262 CID	Base	US5077
<b>CALAIS</b>				
1987	L4-2.3L	138 CID	Base,GT	US5043
1985-1987	L4-2.5L	151 CID	W/O Pulley; 500,Base,Supreme, W/O Pulley; Base,ES,GT	US5000
1985-1987	L4-2.5L	151 CID	With Multi-Groove pulley	US5067
1985-1987	V6-3.0L	181 CID	500,Base,Supreme,ES,GT	US5050
<b>CUSTOM CRUISER</b>				
1980-1985	V8-5.0L	307 CID	Air Cond; Base	US1120
1980-1985	V8-5.0L	307 CID	Exc.Air Cond; Base	US1100
1980-1990	V8-5.0L	307 CID	Air Cond; High Performance; Base	US1120H
1991-1992	V8-5.0L	305 CID	Base	US5051
1977-1985	V8-5.7L	350 CID	Air Cond; High Performance; Base	US1120H
1977-1985	V8-5.7L	350 CID	Exc.Air Cond; Base	US1100
1977-1990	V8-5.7L	350 CID	Air Cond; Base	US1120
1992	V8-5.7L	350 CID	Base	US5051
1975	V8-6.6L	400 CID		US975
1977-1979	V8-6.6L	403 CID	Air Cond	US1120
1977-1979	V8-6.6L	403 CID	Air Cond; High Performance	US1120H
1977-1979	V8-6.6L	403 CID	Exc.Air Cond	US1100
1975-1976	V8-7.5L	455 CID	Air Cond	US1120
1975-1976	V8-7.5L	455 CID	Air Cond; High Performance	US1120H
1975-1976	V8-7.5L	455 CID	Exc.Air Cond	US1100
<b>CUTLASS</b>				
1975-1976	L6-4.1L	250 CID		US1107
1997-1999	V6-3.1L	189 CID	Base,GLS,GL	US5033
1977-1981	V6-3.8L	231 CID	Base,Brougham,LS	US1018
1977-1981	V6-3.8L	231 CID	High Performance; Base,Brougham,LS	US1018H
1975-1981	V8-4.3L	260 CID	Air Cond; High Performance; Base,Brougham,LS	US1120H
1975-1981	V8-4.3L	260 CID	Air Cond; Base,Brougham,LS,	US1120
1975-1981	V8-4.3L	260 CID	Exc.Air Cond; Base,Brougham,LS	US1100
1980	V8-5.0L	305 CID	High Performance; Base,Brougham,LS,Base	US1121H
1975-1981	V8-5.7L	350 CID	Air Cond; High Performance; Base,Brougham,LS	US1120H
1975-1981	V8-5.7L	350 CID	Air Cond; Base,Brougham,LS	US1120
1975-1981	V8-5.7L	350 CID	Exc.Air Cond; Base,Brougham,LS	US1100
1977	V8-6.6L	403 CID	Air Cond; High Performance;	US1120H
1975-1976	V8-7.5L	455 CID	Air Cond	US1120
1975-1976	V8-7.5L	455 CID	Air Cond; High Performance	US1120H
1975-1976	V8-7.5L	455 CID	Exc.Air Cond	US1100
<b>CUTLASS CALAIS</b>				
1988-1991	L4-2.5L	138 CID	Base,GT,International,SL,S	US5043
1989-1991	L4-2.3L	140 CID	International,S	US5043
1988-1991	L4-2.5L	151 CID	W/O Pulley; Base,GT,SL,S	US5000
1988	V6-3.0L	181 CID	Base,GT,SL	US5050
1989-1991	V6-3.3L	204 CID	S,SL	US5050
1978-1984	V6-3.8L	231 CID	Base,Hurst	US1018
1978-1984	V6-3.8L	231 CID	High Performance; Base,Hurst	US1018H
1982-1984	V6-4.3L	260 CID	Base,Hurst	US5012
1978-1982	V8-4.3L	260 CID	Air Cond; High Performance; Base	US1120H
1978-1982	V8-4.3L	260 CID	Air Cond; Air Cond; Base	US1120
1978-1982	V8-4.3L	260 CID	Exc.Air Cond; Base	US1100
1980	V8-5.0L	305 CID	High Performance; Base,Base	US1121H
1982-1984	V8-5.0L	307 CID	Air Cond; Base,Hurst	US1120
1982-1984	V8-5.0L	307 CID	Air Cond; High Performance; Base,Hurst	US1120H
1982-1984	V8-5.0L	307 CID	Exc.Air Cond; Base,Hurst	US1100
1979-1982	V8-5.7L	350 CID	Exc.Air Cond; Base	US1100
1979-1984	V8-5.7L	350 CID	Air Cond; High Performance; Base,Hurst	US1120H
1979-1984	V8-5.7L	350 CID	Air Cond; Base,Hurst	US1120

Years	Engine	Disp.	Application Description	USMW
<b>CUTLASS CIERA</b>				
1993-1996	L4-2.2L	134 CID	Base,S	US5032
1982-1986	L4-2.5L	151 CID	3 Groove pulley; Base,Brougham,LS,ES, 3 Groove pulley; Brougham,Cruiser LS,Holiday,GT,S SL	US5000P
1982-1986	L4-2.5L	151 CID	W/O Pulley; Base,Brougham,LS,ES,Cruiser LS, Holiday,GT,S,SL	US5000
1985-1987	L4-2.5L	151 CID	With Multi-Groove pulley	US5067
1987-1992	L4-2.5L	151 CID	Brougham,GT,LS,S,SL,Base	US5041
1986	V6-2.8L	173 CID	Brougham,ES,GT,Holiday,LS,S,SL	US5001
1987-1989	V6-2.8L	173 CID	Brougham,GT,LS,S,SL,Base	US5033
1982-1985	V6-3.0L	181 CID	Base,Brougham,LS,ES,Cruiser LS,Holiday	US5028
1994-1996	V6-3.1L	189 CID	Base,S,SL	US5033
1989-1993	V6-3.3L	204 CID	Base,GT,SL,S	US5050
1984-1985	V6-3.8L	231 CID	Brougham,LS,Cruiser LS,ES,GT,Holiday	US5028
1986-1988	V6-3.8L	231 CID	ES,GT,Holiday,LS,Brougham,S,SL,Base,International	US5050
1982-1985	V6-4.3L	260 CID	Base,Brougham,LS,Cruiser LS	US5014
<b>CUTLASS CRUISER</b>				
1987	L4-2.5L	151 CID	With Multi-Groove pulley	US5067
1987-1990	L4-2.5L	151 CID	Brougham,LS,Brougham LS,SL,Base	US5041
1987-1989	V6-2.8L	173 CID	Brougham,LS,Brougham LS,SL,Base	US5033
1994	V6-3.1L	189 CID	Base,S,Special Edition	US5033
1989-1993	V6-3.3L	204 CID	Base,SL,S	US5050
1980-1982	V6-3.8L	231 CID	Base,Brougham	US1018
1980-1982	V6-3.8L	231 CID	High Performance; Base,Brougham	US1018H
1987-1988	V6-3.8L	231 CID	Brougham,LS,Brougham LS,SL	US5050
1980-1982	V8-4.3L	260 CID	Exc.Air Cond; Base,Brougham	US1100
1980-1982	V8-5.0L	305 CID	Base,Brougham	US1121
1980-1982	V8-5.0L	305 CID	High Performance; Base,Brougham	US1121H
1981-1983	V8-5.0L	307 CID	Exc.Air Cond; Base,Brougham	US1100
1982-1983	V8-5.0L	307 CID	Air Cond; Base	US1120
1982-1983	V8-5.0L	307 CID	Air Cond; High Performance; Base	US1120H
1980-1983	V8-5.7L	350 CID	Air Cond; Base,Brougham,Air Cond; Brougham	US1120
1980-1983	V8-5.7L	350 CID	Air Cond; High Performance; Base,Brougham	US1120H
1980-1983	V8-5.7L	350 CID	Exc.Air Cond; Base,Brougham	US1100
<b>CUTLASS SALON</b>				
1978-1987	V6-3.8L	231 CID	Base,Brougham,LS	US1018
1978-1987	V6-3.8L	231 CID	High Performance; Base,Brougham, LS	US1018H
1975-1981	V8-4.3L	260 CID	Air Cond; High Performance; Base,Brougham, LS	US1120H
1975-1981	V8-4.3L	260 CID	Air Cond; Air Cond; Base,Brougham,Air Cond; LS	US1120
1975-1981	V8-4.3L	260 CID	Exc.Air Cond; Base,Brougham, LS	US1100
1980	V8-5.0L	305 CID	High Performance; Base,Brougham,Base	US1121H
1985-1986	V8-5.0L	307 CID	Exc.Air Cond; 442,Base	US1100
1985-1987	V8-5.0L	307 CID	Air Cond; 442,Base,Air Cond; Base	US1120
1985-1987	V8-5.0L	307 CID	Air Cond; High Performance; 442,Base,Air Cond	US1120H
1975-1981	V8-5.7L	350 CID	Exc.Air Cond; Base,Brougham,LS	US1100
1975-1985	V8-5.7L	350 CID	Air Cond; High Performance; Base,Brougham, LS	US1120H
1975-1985	V8-5.7L	350 CID	Air Cond; Air Cond; Base,Brougham,Air Cond; LS	US1120
1977	V8-6.6L	403 CID	Air Cond; High Performance; ,	US1120H
1975-1976	V8-7.5L	455 CID	Air Cond	US1120
1975-1976	V8-7.5L	455 CID	Air Cond; High Performance	US1120H
1975-1976	V8-7.5L	455 CID	Exc.Air Cond	US1100
<b>CUTLASS SUPREME</b>				
1990	L4-2.3L	140 CID	Base,International	US5043
1990-1991	L4-2.3L	138 CID	Base	US5043
1988-1989	V6-2.8L	173 CID	Base,Indy 500 Pace Car,International,SL	US5033
1989-1997	V6-3.1L	189 CID	Base,International,SL,S	US5033
1991-1996	V6-3.4L	207 CID	Base,International,SL,S	US5033
1980-1987	V6-3.8L	231 CID	Base,Brougham,LS,442	US1018
1980-1987	V6-3.8L	231 CID	High Performance; Base,Brougham,LS,442	US1018H
1982-1983	V6-4.3L	260 CID	Air Cond; Base,Brougham	US1120
1982-1983	V6-4.3L	260 CID	Air Cond; High Performance; Base,Brougham	US1120H
1984	V6-4.3L	260 CID	Base,Brougham	US5012
1980-1982	V8-4.3L	260 CID	Exc.Air Cond; Base,Brougham,LS	US1100
1980	V8-5.0L	305 CID	High Performance; Base,Brougham,Base	US1121H
1982-1984	V8-5.0L	307 CID	Exc.Air Cond; Base,Brougham	US1100
1982-1988	V8-5.0L	307 CID	Air Cond; Base,Brougham,LS, 442, Classic Classic Brougham	US1120

Years	Engine	Disp.	Application Description	USMW
1982-1988	V8-5.0L	307 CID	Air Cond; High Performance; Base,Brougham,LS, 442, Classic,Classic Brougham	US1120H
1980-1984	V8-5.7L	350 CID	Exc.Air Cond; Base,Brougham,LS	US1100
1980-1985	V8-5.7L	350 CID	Air Cond; Base,Brougham,LS	US1120
1980-1985	V8-5.7L	350 CID	Air Cond; High Performance; Base,Brougham,LS	US1120H
<b>CUTLASS TIARA</b>				
1976	V8-4.3L	260 CID	Air Cond; High Performance; ,	US1120H
1976	V8-5.7L	350 CID	Air Cond; High Performance; ,	US1120H
1976	V8-7.5L	455 CID	Air Cond; High Performance; ,	US1120H
<b>DELTA 88</b>				
1986	V6-3.0L	181 CID	Royale,Royale Brougham	US5050
1977-1985	V6-3.8L	231 CID	Base,Holiday,Royale,Royale Brougham Royale Brougham LS	US1018
1977-1985	V6-3.8L	231 CID	High Performance; Base,Holiday,Royale Royale Brougham, Royale Brougham LS	US1018H
1986-1991	V6-3.8L	231 CID	Royale,Royale Brougham	US5050
1977-1982	V8-4.3L	260 CID	Air Cond; High Performance; Base,Holiday,Royale, Royale Brougham	US1120H
1977-1982	V8-4.3L	260 CID	Air Cond; Base,Holiday,Royale,Royale Brougham	US1120
1977-1982	V8-4.3L	260 CID	Exc.Air Cond; Base,Holiday,Royale,Royale Brougham	US1100
1979	V8-4.9L	301 CID		US975
1980-1985	V8-5.0L	307 CID	Air Cond; Base,Holiday,Royale,Royale Brougham, Royale Brougham LS	US1120
1980-1985	V8-5.0L	307 CID	Air Cond; High Performance; Base,Holiday,Royale, Royale Brougham,Royale Brougham LS	US1120H
1980-1985	V8-5.0L	307 CID	Exc.Air Cond; Base,Holiday,Royale,Royale Brougham, Royale Brougham LS	US1100
1975-1985	V8-5.7L	350 CID	Air Cond; High Performance; Base,Holiday,Royale, Royale Brougham,Royale Brougham LS	US1120H
1975-1985	V8-5.7L	350 CID	Air Con; Base,Holiday,Royale, Royale Brougham, Royale Brougham LS	US1120
1975-1985	V8-5.7L	350 CID	Exc.Air Cond; Base,Holiday,Royale,Royale Brougham Royale Brougham LS	US1100
1975	V8-6.6L	400 CID	Air Cond; High Performance; ,	US1120H
1977-1979	V8-6.6L	403 CID	Air Cond	US1120
1977-1979	V8-6.6L	403 CID	Air Cond; High Performance	US1120H
1977-1979	V8-6.6L	403 CID	Exc.Air Cond	US1100
1975-1976	V8-7.5L	455 CID	Air Cond	US1120
1975-1976	V8-7.5L	455 CID	Air Cond; High Performance	US1120H
1975-1976	V8-7.5L	455 CID	Exc.Air Cond	US1100
<b>FIRENZA</b>				
1982-1986	L4-1.8L	112 CID	LX,S,SX,Cruiser LX,Cruiser S,Cruiser SX,Base, Brougham LX,Brougham SX,Cruiser,ES,GT,LC	US5036
1983-1986	L4-2.0L	122 CID	Cruiser LX,Cruiser S,Cruiser SX,LX,S,SX,Base, Brougham LX,Brougham SX,Cruiser,ES,GT,LC	US5007
1987-1988	L4-2.0L	121 CID	Base,Cruiser,LC,LX,S	US5032
1987-1988	L4-2.0L	122 CID	Base,Cruiser,LC,LX,S	US5036
1985-1986	V6-2.8L	173 CID	Base,Brougham LX,Brougham SX,Cruiser LX, Cruiser SX,ES,GT	US5020
1987	V6-3.1L	189 CID	GT	US5033
<b>INTRIGUE</b>				
1999-2002	V6-3.5L	214 CID	GL,GLS,GX	US5085
1998-1999	V6-3.8L	231 CID	Base,GL,GLS,GX	US5075
<b>LSS</b>				
1996-1999	V6-3.8L	231 CID	Base	US5075
<b>OMEGA</b>				
1980-1984	L4-2.5L	151 CID	3 Groove pulley; Base,Brougham,SX,ES,Sport,ESC	US5000P
1980-1984	L4-2.5L	151 CID	W/O Pulley; Base,Brougham,SX,ES,Sport,ESC	US5000
1975-1976	L6-4.1L	250 CID		US1107
1980-1984	V6-2.8L	173 CID	Base,Brougham,SX,ES,Sport,ESC	US5001
1977-1979	V6-3.8L	231 CID		US1018
1977-1979	V6-3.8L	231 CID	High Performance	US1018H
1975-1977	V8-4.3L	260 CID	Air Cond	US1120
1975-1977	V8-4.3L	260 CID	Air Cond; High Performance	US1120H
1975-1977	V8-4.3L	260 CID	Exc.Air Cond	US1100
1975-1979	V8-5.7L	350 CID	Air Cond	US1120
1975-1979	V8-5.7L	350 CID	Air Cond; High Performance	US1120H
1975-1979	V8-5.7L	350 CID	Exc.Air Cond	US1100

Years	Engine	Disp.	Application Description	USMW
<b>REGENCY</b>				
1997-1998	V6-3.8L	231 CID	Base	US5075
<b>SILHOUETTE</b>				
1990-1994	V6-3.1L	189 CID	Base	US5033
1996-2004	V6-3.4L	207 CID	Base, GL, GLS, GS, Premiere	US5033
1992-1995	V6-3.8L	231 CID	Base	US5050
<b>STARFIRE</b>				
1978-1980	L4-2.5L	151 CID	Base, Firenza, GT, SX	US1107
1975-1980	V6-3.8L	231 CID	Base, Firenza, GT, SX	US1018
1975-1980	V6-3.8L	231 CID	High Performance; Base, Firenza, GT, SX	US1018H
1977-1979	V8-5.0L	305 CID		US1069
<b>TORONADO</b>				
1986-1992	V6-3.8L	231 CID	Brougham, Trofeo, Base	US5050
1981-1984	V6-4.1L	252 CID	Brougham	US1018
1981-1984	V6-4.1L	252 CID	High Performance; Brougham	US1018H
1980-1981	V8-5.0L	307 CID	Exc. Air Cond; Brougham, XSC	US1100
1980-1985	V8-5.0L	307 CID	Air Cond; Brougham, XSC, Caliente	US1120
1980-1985	V8-5.0L	307 CID	Air Cond; High Performance; Brougham, XSC, Caliente	US1120H
1977-1981	V8-5.7L	350 CID	Exc. Air Cond; Exc. Air Cond; Brougham, XSC	US1100
1977-1985	V8-5.7L	350 CID	Air Cond; High Performance; Brougham, XSC, Caliente	US1120H
1977-1985	V8-5.7L	350 CID	Air Cond; Air Cond; Brougham, XSC, Caliente	US1120
1977-1978	V8-6.6L	403 CID	Air Cond	US1120
1977-1978	V8-6.6L	403 CID	Air Cond; High Performance	US1120H
1977-1978	V8-6.6L	403 CID	Exc. Air Cond	US1100
1975-1976	V8-7.5L	455 CID	Air Cond	US1120
1975-1976	V8-7.5L	455 CID	Air Cond; High Performance	US1120H
1975-1976	V8-7.5L	455 CID	Exc. Air Cond	US1100
<b>OPEL</b>				
<b>ASTRA</b>				
1993-1998	L4-1.8L	1796cc		US8942
1993-1998	L4-2.0L	1998cc		US8942
<b>CALIBRA</b>				
1993-1997	L4-2.0L	1998cc		US8942
<b>FRONTERA</b>				
1993-1997	L4-2.0L	1998cc		US8942
<b>OMEGA</b>				
1990-1995	L4-2.0L	1998cc		US8942
<b>VECTRA</b>				
1992-1995	L4-1.8L	1796cc		US8942
1992-1995	L4-2.0L	1998cc		US8942
<b>VECTRA '96</b>				
1996-2002	L4-1.6L	1598cc		US8942
1996-2002	L4-2.0L	1998cc		US8942
<b>PEUGEOT</b>				
<b>106</b>				
1996-2004	L4-1.0L	954cc		US8936
1992-2004	L4-1.1L	1124cc		US8936
1993-1995	L4-1.3L	1294cc	Ralley	US8936
1992-2004	L4-1.4L	1360cc		US8936
<b>205</b>				
1987-1999	L4-1.1L	1124cc		US8936
1987-1999	L4-1.4L	1360cc		US8936
<b>206</b>				
2000-2008	L4-1.4L	83 CID		US8936
2002-2008	L4-1.6L	97 CID		US8937
<b>505</b>				
1980-1987	L4-2.0L	1971cc		US9193
<b>206 (MEX)</b>				
2000-2009	L4-1.4L	1360cc	FI SOHC	US8936
2001-2009	L4-1.6L	1587cc	FI SOHC ; FI	US8937
<b>207 (MEX)</b>				
2008-2009	L4-1.6L	1587cc	Turbo DOHC	US8937
<b>GRAND RAID (MEX)</b>				
2007-2009	L4-1.6L	1587cc	FI	US8937
<b>PARTNER</b>				
2005-2008	L4-1.6L	97 CID		US8937

Years	Engine	Disp.	Application Description	USMW
<b>PARTNER (MEX)</b>				
2004	L4-1.6L	1584cc	FI	US8937
2005-2009	L4-1.6L	1587cc	FI	US8937
<b>PLYMOUTH</b>				
<b>ACCLAIM</b>				
1989	L4-2.5L	153 CID	Base, LE	US7122
1990-1995	L4-2.5L	153 CID	Base, LE	US7127
1989-1995	V6-3.0L	181 CID	LX, Base, LE	US7121
<b>ARROW</b>				
1976-1977	L4-1.6L	98 CID		US1012
1978-1980	L4-1.6L	98 CID	Base, GS, GT	US7105
1976-1978	L4-2.0L	122 CID		US7116
1979-1980	L4-2.6L	2555cc	Base, GS, GT	US7116
<b>ARROW PICKUP</b>				
1979-1982	L4-2.0L	122 CID	Base, Sport	US7116
1979-1982	L4-2.6L	2555cc	Base, Sport	US7116
<b>BARRACUDA</b>				
1964-1968	V8-4.5L	273 CID		US919
1966-1969	V8-5.2L	318 CID		US919
1968-1969	V8-5.6L	340 CID		US919
<b>BARRACUDA (MEX)</b>				
1967	V8-5.2L	318 CID	2BL	US919
1967-1969	V8-5.2L	318 CID	4BL	US907
<b>BELVEDERE</b>				
1964-1968	V8-4.5L	273 CID		US919
1958-1959	V8-5.2L	317 CID		US919
1958-1969	V8-5.2L	318 CID		US919
<b>BELVEDERE II</b>				
1965-1967	V8-4.5L	273 CID		US919
1965-1967	V8-5.2L	318 CID		US919
<b>BREEZE</b>				
1996-2000	L4-2.0L	122 CID	Base, Espresso	US7150
1997-2000	L4-2.4L	148 CID	Base, Espresso	US7156
<b>BREEZE (MEX)</b>				
1995	L4-2.0L	122 CID	MFI SOHC	US7150
<b>CARAVELLE</b>				
1985-1988	L4-2.2L	135 CID	SE, Base	US7110
1986-1988	L4-2.5L	153 CID	Base, SE	US7110
1985	L4-2.6L	156 CID	SE	US7111
<b>CHAMP</b>				
1979-1980	L4-1.4L	1410cc	Base	US7106
1981-1982	L4-1.4L	1410cc	Base, Custom, Deluxe	US7115
1979-1980	L4-1.6L	98 CID	Base, Custom	US7104
1981-1982	L4-1.6L	98 CID	Base, Custom	US7108
<b>COLT</b>				
1979	L4-1.4L	1410cc		US7106
1983-1984	L4-1.4L	1410cc	Base, Deluxe, DL, E	US7115
1985-1994	L4-1.5L	90 CID	DL, E, Premier, Base, GT, GL	US7115
1976-1977	L4-1.6L	98 CID		US1012
1978	L4-1.6L	98 CID		US7105
1979	L4-1.6L	98 CID		US7104
1983-1988	L4-1.6L	98 CID	Base, Custom, Deluxe, DL, E, Premier	US7108
1989-1990	L4-1.6L	98 CID	GT	US7131
1989-1990	L4-1.8L	107 CID	DL	US7108
1992-1994	L4-1.8L	112 CID	Base, Vista, Vista SE, GL	US7135
1976-1978	L4-2.0L	122 CID		US7116
1984-1991	L4-2.0L	122 CID	Vista	US7118
1992	L4-2.4L	2351cc	Vista, Vista SE	US9168
1993-1994	L4-2.4L	2351cc	To 11/03/92; Vista, Vista SE, Vista	US7148
1978-1979	L4-2.6L	2555cc		US7116
<b>CONQUEST</b>				
1984	L4-2.6L	156 CID	Exc. Intercooler; Base	US7115
1985-1986	L4-2.6L	156 CID	From 02/85; Base,	US7120
1985-1986	L4-2.6L	2555cc	Base	US7116
<b>CRICKET</b>				
1971-1973	L4-1.5L	1500cc		US1010



Years	Engine	Disp.	Application Description	USMW
<b>CUSTOM</b>				
1958-1961	V8-5.2L	318 CID		US919
<b>DUSTER</b>				
1975-1976	L6-3.7L	225 CID		US7100
1975-1976	V8-5.2L	318 CID		US1053
1975-1976	V8-5.2L	318 CID	High Performance	US1053H
1975-1976	V8-5.9L	360 CID		US1053
1975-1976	V8-5.9L	360 CID	High Performance	US1053H
<b>FLEET SPECIAL</b>				
1960-1963	V8-5.2L	318 CID		US919
<b>FURY</b>				
1975-1978	L6-3.7L	225 CID		US7100
1964-1965	V8-4.5L	273 CID		US919
1958-1959	V8-5.2L	317 CID		US919
1958-1969	V8-5.2L	318 CID		US919
1975-1978	V8-5.2L	318 CID		US1053
1975-1978	V8-5.2L	318 CID	High Performance	US1053H
1975-1978	V8-5.9L	360 CID		US1053
1975-1978	V8-5.9L	360 CID	High Performance	US1053H
1975-1978	V8-6.6L	400 CID		US1040
1975-1978	V8-7.2L	440 CID		US1040
<b>FURY I</b>				
1968-1969	V8-5.2L	318 CID		US919
<b>FURY II</b>				
1965	V8-4.5L	273 CID		US919
1965-1969	V8-5.2L	318 CID		US919
<b>FURY III</b>				
1965	V8-4.5L	273 CID		US919
1965-1969	V8-5.2L	318 CID		US919
<b>GRAN FURY</b>				
1980-1983	L6-3.7L	225 CID	Base,Salon	US7100
1975-1989	V8-5.2L	318 CID	Base,Salon	US1053
1975-1989	V8-5.2L	318 CID	High Performance; Base, Salon	US1053H
1975-1980	V8-5.9L	360 CID	Base,Salon	US1053
1975-1980	V8-5.9L	360 CID	High Performance; Base,Salon	US1053H
1975-1977	V8-6.6L	400 CID		US1040
1975-1977	V8-7.2L	440 CID		US1040
<b>GRAND VOYAGER</b>				
1996-1997	L4-2.4L	148 CID	Mechanical Tensioner; Base,SE,Base	US7156
1988	L4-2.5L	153 CID	SE	US7110
1988-2000	V6-3.0L	181 CID	LE,SE,Base,Expresso	US7121
1990-2000	V6-3.3L	201 CID	LE,SE,Base,Expresso	US7126
1994-1999	V6-3.8L	230 CID	LE,Base,Expresso,SE	US7126
<b>GRAND VOYAGER (MEX)</b>				
1997	V6-3.8L	232 CID	MFI ; 2WD	US7126
<b>GTX</b>				
1967	V8-4.5L	273 CID		US919
1967-1969	V8-5.2L	318 CID		US919
<b>HORIZON</b>				
1983-1986	L4-1.6L	97 CID	Base,Custom,Turismo,SE	US7113
1978-1983	L4-1.7L	105 CID	Base,TC3,Miser,TC3 Miser,E-Type,TC3 Custom, Custom,Turismo	US7101
1981-1988	L4-2.2L	135 CID	Base,Miser,TC3,TC3 Miser,E-Type,TC3 Custom, TC3 Turismo,Custom,Turismo,Turismo 2.2,SE,America	US7110
1989	L4-2.2L	135 CID	America,Turismo	US7122
1990	L4-2.2L	135 CID	Base	US7127
<b>LASER</b>				
1990-1994	L4-1.8L	107 CID	Base,RS	US7108
1990-1994	L4-2.0L	1997cc	RS	US9212
<b>NEON</b>				
1995-2001	L4-2.0L	122 CID	Base,High Line,Sport,ACR,Expresso,Style	US7150
<b>PB100</b>				
1975-1980	L6-3.7L	225 CID	Voyager	US7100
1975-1980	V8-5.2L	318 CID	High Performance; Voyager	US1053H
1975-1980	V8-5.2L	318 CID	Voyager	US1053
1976-1978	V8-5.9L	360 CID		US1053
1976-1978	V8-5.9L	360 CID	High Performance	US1053H

Years	Engine	Disp.	Application Description	USMW
<b>PB150</b>				
1981-1983	L6-3.7L	225 CID	Voyager	US7100
1981-1983	V8-5.2L	318 CID	High Performance; Voyager	US1053H
1981-1983	V8-5.2L	318 CID	Voyager	US1053
<b>PB200</b>				
1975-1980	L6-3.7L	225 CID	Voyager	US7100
1975-1980	V8-5.2L	318 CID	High Performance; Voyager	US1053H
1975-1980	V8-5.2L	318 CID	Voyager	US1053
1975-1980	V8-5.9L	360 CID	High Performance; Voyager	US1053H
1975-1980	V8-5.9L	360 CID	Voyager	US1053
1976-1978	V8-6.6L	400 CID		US1040
1976-1978	V8-7.2L	440 CID		US1040
<b>PB250</b>				
1981-1983	L6-3.7L	225 CID	Voyager	US7100
1981-1983	V8-5.2L	318 CID	High Performance; Voyager	US1053H
1981-1983	V8-5.2L	318 CID	Voyager	US1053
1981	V8-5.9L	360 CID	High Performance; Voyager	US1053H
<b>PB300</b>				
1975-1980	V8-5.2L	318 CID	High Performance; Voyager	US1053H
1975-1980	V8-5.2L	318 CID	Voyager	US1053
1975-1980	V8-5.9L	360 CID	High Performance; Voyager	US1053H
1975-1980	V8-5.9L	360 CID	Voyager	US1053
1976-1978	V8-6.6L	400 CID		US1040
1976-1978	V8-7.2L	440 CID		US1040
<b>PB350</b>				
1981-1983	V8-5.2L	318 CID	High Performance; Voyager	US1053H
1981-1983	V8-5.2L	318 CID	Voyager	US1053
1981-1983	V8-5.9L	360 CID	High Performance; Voyager	US1053H
1981-1983	V8-5.9L	360 CID	Voyager	US1053
<b>PLAZA</b>				
1958	V8-5.2L	317 CID		US919
1958	V8-5.2L	318 CID		US919
<b>PROWLER</b>				
1997	V6-3.5L	215 CID	6 Bolt Pattern; Base,Base	US7158
1999-2001	V6-3.5L	215 CID	Base	US7162
<b>RELIANT</b>				
1981-1988	L4-2.2L	135 CID	Base,Custom,SE,LE,America	US7110
1989	L4-2.2L	135 CID	America	US7122
1986-1988	L4-2.5L	153 CID	LE,SE,America	US7110
1989	L4-2.5L	153 CID	America	US7122
1981-1985	L4-2.6L	156 CID	Base,Custom,SE,LE	US7111
<b>ROADRUNNER</b>				
1968	V8-4.5L	273 CID		US919
1968-1969	V8-5.2L	318 CID		US919
1968-1969	V8-5.6L	340 CID		US919
<b>SAPPORO</b>				
1978-1979	L4-1.6L	98 CID		US7105
1978-1983	L4-2.6L	2555cc	Base	US7116
<b>SATELLITE</b>				
1965-1968	V8-4.5L	273 CID		US919
1965-1969	V8-5.2L	318 CID		US919
1968-1969	V8-5.6L	340 CID		US919
<b>SAVOY</b>				
1964	V8-4.5L	273 CID		US919
1958-1959	V8-5.2L	317 CID		US919
1958-1964	V8-5.2L	318 CID		US919
<b>SCAMP</b>				
1983	L4-2.2L	135 CID	Base	US7110
1975-1976	L6-3.7L	225 CID		US7100
1975-1976	V8-5.2L	318 CID		US1053
1975-1976	V8-5.2L	318 CID	High Performance	US1053H
<b>SPORT WAGON</b>				
1960-1961	V8-5.2L	318 CID		US919
<b>SUBURBAN</b>				
1958-1959	V8-5.2L	317 CID		US919
1958-1961	V8-5.2L	318 CID		US919

Years	Engine	Disp.	Application Description	USMW
<b>SUNDANCE</b>				
1987-1988	L4-2.2L	135 CID	Base,RS	US7110
1989	L4-2.2L	135 CID	Base	US7122
1990-1994	L4-2.2L	135 CID	Base,High Line,America	US7127
1988	L4-2.5L	153 CID	Base	US7110
1989	L4-2.5L	153 CID	Base,RS	US7122
1990-1994	L4-2.5L	153 CID	Base,RS,America,High Line,Duster	US7127
1992-1994	V6-3.0L	181 CID	Duster	US7121
<b>TRAILDUSTER</b>				
1975-1980	L6-3.7L	225 CID	Base	US7100
1975-1981	V8-5.2L	318 CID	Base	US1053
1975-1981	V8-5.2L	318 CID	High Performance; Base	US1053H
1975-1981	V8-5.9L	360 CID	Base	US1053
1975-1981	V8-5.9L	360 CID	High Performance; Base	US1053H
1976-1978	V8-6.6L	400 CID		US1040
1975-1978	V8-7.2L	440 CID		US1040
<b>VALIANT</b>				
1975-1976	L6-3.7L	225 CID		US7100
1964-1969	V8-4.5L	273 CID		US919
1968-1969	V8-5.2L	318 CID		US919
1975-1976	V8-5.2L	318 CID		US1053
1975-1976	V8-5.2L	318 CID	High Performance	US1053H
1968-1969	V8-5.6L	340 CID		US919
1976	V8-5.9L	360 CID	High Performance,;	US1053H
<b>VALIANT (MEX)</b>				
1974-1981	L6-3.7L	225 CID	2BL ; Duster,2BL	US7100
1970-1975	V8-5.2L	318 CID	2BL ; Super Bee	US1053
1970-1975	V8-5.2L	318 CID	2BL High Performance ; Super Bee	US1053H
1974-1979	V8-5.9L	360 CID	4BL ; Super Bee	US1053
1974-1979	V8-5.9L	360 CID	4BL High Performance ; Super Bee	US1053H
<b>VALIANT SUPER BEE (MEX)</b>				
1969	V8-5.2L	318 CID	2BL	US934B
<b>VIP</b>				
1967	V8-5.2L	318 CID		US919
<b>VOLARE</b>				
1976-1980	L6-3.7L	225 CID	Base	US7100
1976-1980	V8-5.2L	318 CID	Base	US1053
1976-1980	V8-5.2L	318 CID	High Performance; Base	US1053H
1976-1980	V8-5.9L	360 CID	Base	US1053
1976-1980	V8-5.9L	360 CID	High Performance; Base	US1053H
<b>VOLARE (MEX)</b>				
1982-1988	L4-2.2L	135 CID	2BL ; K	US7110
1976-1982	L6-3.7L	225 CID	2BL ; 1BL	US7100
<b>VOYAGER</b>				
1984-1987	L4-2.2L	135 CID	Base,LE,SE	US7110
1996-2000	L4-2.4L	148 CID	Mechanical Tensioner; Base,SE,Base,Expresso	US7156
1987-1988	L4-2.5L	153 CID	LE,SE,Base	US7110
1989	L4-2.5L	153 CID	Base,LE,SE	US7122
1990-1995	L4-2.5L	153 CID	Base,LE,LX,SE	US7127
1984-1987	L4-2.6L	156 CID	Base,LE,SE	US7111
1987-2000	V6-3.0L	181 CID	LE,SE,LX,Base,Expresso	US7121
1991-2000	V6-3.3L	201 CID	LE,SE,Base,LX,Expresso	US7126
1999	V6-3.8L	230 CID	Base,Expresso,SE	US7126
<b>PONTIAC</b>				
<b>6000</b>				
1982-1986	L4-2.5L	151 CID	3 Groove pulley; Base,LE	US5000P
1982-1986	L4-2.5L	151 CID	W/O Pulley; Base,LE	US5000
1987-1991	L4-2.5L	151 CID	Base,LE	US5041
1982-1986	V6-2.8L	173 CID	Base,LE,SE,STE	US5001
1987-1989	V6-2.8L	173 CID	Base,LE,SE,STE	US5033
1988-1991	V6-3.1L	189 CID	SE,STE,Special Edition,LE	US5033
1982-1985	V6-4.3L	260 CID	Base,LE	US5014
<b>ACADIAN</b>				
1968	V8-5.7L	350 CID		US850
<b>ASTRE</b>				
1975	L4-2.3L	140 CID		US1088
1977	L4-2.5L	151 CID		US1107

Years	Engine	Disp.	Application Description	USMW
<b>AZTEK</b>				
2001-2005	V6-3.4L	207 CID	Base,GT,Rally	US5033
<b>BONNEVILLE</b>				
1980-1986	V6-3.8L	231 CID	Base,Brougham,LE	US1018
1980-1986	V6-3.8L	231 CID	High Performance; Base,Brougham,LE	US1018H
1987-1995	V6-3.8L	231 CID	Base,LE,SE,SSE,SSEi	US5050
1996-2005	V6-3.8L	231 CID	SE,SSE,SLE,SSEi	US5075
1982	V6-4.1L	252 CID	High Performance; Base,Brougham,Base	US1018H
1986	V6-4.3L	262 CID	High Performance; Base,Brougham,LE,Base	US1121H
2004-2005	V8-4.0L	244 CID	GXP	US5072
1980-1981	V8-4.3L	265 CID	Base,Brougham	US975
1977-1980	V8-4.9L	301 CID	Base,Brougham,Safari	US975
1981	V8-5.0L	307 CID	Air Cond; High Performance; Base,Brougham, Safari,Base	US1120H
1983-1986	V8-5.0L	305 CID	Base,Brougham,LE	US1121
1983-1986	V8-5.0L	305 CID	High Performance; Base,Brougham,LE	US1121H
1977-1978	V8-5.7L	350 CID		US975
1977-1984	V8-5.7L	350 CID	Air Cond; High Performance; Base,Brougham,Safari,LE	US1120H
1977-1984	V8-5.7L	350 CID	Air Cond; Base,Brougham,Safari,LE	US1120
1977-1984	V8-5.7L	350 CID	Exc.Air Cond; Base,Brougham,Safari,LE	US1100
1979-1980	V8-5.7L	350 CID	Brougham,Safari	US1018
1979-1980	V8-5.7L	350 CID	High Performance; Brougham,Safari	US1018H
1959-1966	V8-6.4L	389 CID		US850
1967-1968	V8-6.6L	400 CID		US850
1975-1978	V8-6.6L	400 CID		US975
1975-1978	V8-6.6L	400 CID	Air Cond	US1120
1975-1978	V8-6.6L	400 CID	Air Cond; High Performance	US1120H
1975-1978	V8-6.6L	400 CID	Exc.Air Cond	US1100
1977-1979	V8-6.6L	403 CID		US975
1977-1979	V8-6.6L	403 CID	Air Cond	US1120
1977-1979	V8-6.6L	403 CID	Air Cond; High Performance	US1120H
1977-1979	V8-6.6L	403 CID	Exc.Air Cond	US1100
1963-1966	V8-6.9L	421 CID		US850
1967-1968	V8-7.0L	428 CID		US850
1975-1976	V8-7.5L	455 CID		US975
<b>CATALINA</b>				
1977-1979	L6-4.1L	250 CID		US975
1978-1981	V6-3.8L	231 CID	Base	US1018
1978-1981	V6-3.8L	231 CID	High Performance; Base	US1018H
1980-1981	V8-4.3L	265 CID	Base	US975
1977-1980	V8-4.9L	301 CID	Base,Safari	US975
1981	V8-5.0L	307 CID	Air Cond; High Performance; Base,Safari	US1120H
1976-1977	V8-5.7L	350 CID		US975
1976-1981	V8-5.7L	350 CID	Air Cond; High Performance; Base,Safari	US1120H
1976-1981	V8-5.7L	350 CID	Air Cond; Air Cond; Base,Safari	US1120
1976-1981	V8-5.7L	350 CID	Exc.Air Cond; Base,Safari	US1100
1978-1980	V8-5.7L	350 CID	High Performance; Safari	US1018H
1978-1980	V8-5.7L	350 CID	Safari	US1018
1959-1966	V8-6.4L	389 CID		US850
1967-1968	V8-6.6L	400 CID		US850
1975-1978	V8-6.6L	400 CID		US975
1975-1978	V8-6.6L	400 CID	Air Cond	US1120
1975-1978	V8-6.6L	400 CID	Air Cond; High Performance	US1120H
1975-1978	V8-6.6L	400 CID	Exc.Air Cond	US1100
1977-1979	V8-6.6L	403 CID		US975
1977-1979	V8-6.6L	403 CID	Air Cond	US1120
1977-1979	V8-6.6L	403 CID	Air Cond; High Performance	US1120H
1977-1979	V8-6.6L	403 CID	Exc.Air Cond	US1100
1961-1966	V8-6.9L	421 CID		US850
1967-1968	V8-7.0L	428 CID		US850
1975-1976	V8-7.5L	455 CID		US975
<b>EXECUTIVE</b>				
1968	V8-5.7L	350 CID		US850
1967-1968	V8-6.6L	400 CID		US850
1967-1968	V8-7.0L	428 CID		US850
<b>FIERO</b>				
1984-1988	L4-2.5L	151 CID	W/O Pulley; Base,SE,Sport,W/O Pulley; SE, Value Leader,W/O Pulley; Sport	US5000

Years	Engine	Disp.	Application Description	USMW
1985-1988	V6-2.8L	173 CID	GT,SE,Sport,Value Leader	US5001
<b>FIREBIRD</b>				
1982-1984	L4-2.5L	151 CID	Base,S/E	US1107
1985-1986	L4-2.5L	151 CID	Base	US5022
1975-1976	L6-4.1L	250 CID		US1107
1982-1984	V6-2.8L	173 CID	Base,S/E	US5006
1985-1986	V6-2.8L	173 CID	Base,S/E	US5001
1987-1989	V6-2.8L	173 CID	Base	US5037
1990-1992	V6-3.1L	189 CID	Base	US5037
1993-1995	V6-3.4L	207 CID	Base	US5070
1977-1989	V6-3.8L	231 CID	Base,Esprit,Formula,Trans Am,Trans Am GTA SE	US1018
1977-1989	V6-3.8L	231 CID	High Performance; Base,Esprit,Formula, High Performance; Trans Am,Trans Am GTA SE	US1018H
1995	V6-3.8L	231 CID	Base	US5050
1996-2002	V6-3.8L	231 CID	Base	US5075
1981	V8-4.3L	265 CID	Base,Esprit,Formula	US975
1977-1981	V8-4.9L	301 CID	Base,Esprit,Formula,Trans Am	US975
1977-1987	V8-5.0L	305 CID	Base,Esprit,Formula,Trans Am,S/E	US1121
1977-1987	V8-5.0L	305 CID	High Performance; Base,Esprit,Formula,Trans Am, High Performance; Formula,S/E	US1121H
1988-1992	V8-5.0L	305 CID	Base,Trans Am,Formula,Trans Am GTA	US5049
1988-1992	V8-5.0L	305 CID	High Performance; Base,Trans Am,Formula, Trans Am GTA	US5049H
1968	V8-5.7L	350 CID		US850
1975-1976	V8-5.7L	350 CID		US975
1975-1978	V8-5.7L	350 CID	Air Cond	US1120
1975-1978	V8-5.7L	350 CID	Air Cond; High Performance	US1120H
1975-1978	V8-5.7L	350 CID	Exc.Air Cond	US1100
1979-1987	V8-5.7L	350 CID	Base,Trans Am	US1121
1979-1987	V8-5.7L	350 CID	High Performance; Base,Trans Am	US1121H
1988-1992	V8-5.7L	350 CID	Base,Trans Am,Formula,Trans Am GTA	US5049
1988-1992	V8-5.7L	350 CID	High Performance; Base,Trans Am, High Performance; Formula,Trans Am GTA	US5049H
1993-1997	V8-5.7L	350 CID	VIN P; Formula,Trans Am,Trans Am GT	US5068
1998-2002	V8-5.7L	350 CID	Formula,Trans Am	US5081
1967-1968	V8-6.6L	400 CID		US850
1975-1979	V8-6.6L	400 CID		US975
1975-1979	V8-6.6L	400 CID	Air Cond	US1120
1975-1979	V8-6.6L	400 CID	Air Cond; High Performance	US1120H
1975-1979	V8-6.6L	400 CID	Exc.Air Cond	US1100
1977-1979	V8-6.6L	403 CID		US975
1977-1979	V8-6.6L	403 CID	Air Cond	US1120
1977-1979	V8-6.6L	403 CID	Air Cond; High Performance	US1120H
1977-1979	V8-6.6L	403 CID	Exc.Air Cond	US1100
1975-1976	V8-7.5L	455 CID		US975
<b>G3</b>				
2009-2010	L4-1.6L	98 CID	Base	US6184
<b>G4 (MEX)</b>				
2005-2006	L4-2.2L	134 CID	MFI DOHC	US5092
2006	L4-2.4L	146 CID	MFI DOHC	US5092
<b>G5</b>				
2007-2010	L4-2.2L	134 CID	Base,GT,	US5092
2007-2008	L4-2.4L	145 CID	GT	US5092
<b>G6</b>				
2006-2010	L4-2.4L	145 CID	Base	US5092
2005	V6-3.5L	211 CID	Base,GT	US5033
2006	V6-3.5L	214 CID	Base,GT	US5033
2007-2010	V6-3.5L	213 CID	Base,GT	US6020
2007-2009	V6-3.6L	217 CID	GTP,GXP	US8932
2006-2009	V6-3.9L	237 CID	GTP,GT	US6020
<b>G8</b>				
2008-2009	V6-3.6L	217 CID	Base	US8932
2008-2009	V8-6.0L	364 CID	GT	US65N
2008-2009	V8-6.0L	364 CID	Includes thermostat and thermostat housing; GT	US65N-T
2009	V8-6.2L	376 CID	GXP	US79
<b>GRAND AM</b>				
1987-1989	L4-2.0L	122 CID	LE,SE	US5036
2002-2005	L4-2.2L	134 CID	GT,GT1,SE,SE1,SE2	US5092

Years	Engine	Disp.	Application Description	USMW
1988-1995	L4-2.3L	138 CID	Base,LE,SE,GT	US5043
1989-1994	L4-2.3L	140 CID	SE,LE,GT	US5043
1996-2001	L4-2.4L	146 CID	GT,SE,GT1,SE1,SE2	US5076
1985-1991	L4-2.5L	151 CID	W/O Pulley; Base,LE,SE,W/O Pulley; LE,Value Leader	US5000
1985-1991	L4-2.5L	151 CID	With Multi-Groove pulley	US5067
1985-1987	V6-3.0L	181 CID	Base,LE,SE	US5050
1994-1998	V6-3.1L	189 CID	GT,SE	US5033
1992-1993	V6-3.3L	204 CID	GT,SE	US5050
1999-2005	V6-3.4L	207 CID	GT,SE,GT1,SE1,SE2	US5033
1979	V6-3.8L	231 CID	High Performance;	US1018H
1978-1980	V8-4.9L	301 CID	Base	US975
1978-1980	V8-5.0L	305 CID	Base	US1121
1978-1980	V8-5.0L	305 CID	High Performance; Base	US1121H
1975	V8-5.7L	350 CID		US975
1975	V8-6.6L	400 CID		US975
1975	V8-7.5L	455 CID		US975
<b>GRAND LEMANS</b>				
1980	V6-3.8L	229 CID	High Performance; Base,Safari,Base	US1121H
1980-1981	V6-3.8L	231 CID	Base,Safari	US1018
1980-1981	V6-3.8L	231 CID	High Performance; Base,Safari	US1018H
1980-1981	V8-4.3L	265 CID	Base,Safari	US975
1980-1981	V8-4.9L	301 CID	Base,Safari	US975
1980	V8-5.0L	305 CID	High Performance; Base,Safari,Base	US1121H
<b>GRAND PRIX</b>				
1990-1991	L4-2.3L	138 CID	LE,SE	US5043
1988-1989	V6-2.8L	173 CID	Base,LE,SE	US5033
1989-2003	V6-3.1L	189 CID	Base,LE,SE,Mclaren,STE,GT	US5033
1991-1996	V6-3.4L	207 CID	GT,SE,STE,GTP,LE,Base	US5033
1978-1987	V6-3.8L	231 CID	Base,LJ,Brougham,LE	US1018
1978-1987	V6-3.8L	231 CID	High Performance; Base,LJ,Brougham,LE	US1018H
1997-2008	V6-3.8L	231 CID	GT,GTP,SE,GT1,GT2,Base	US5075
1982	V6-4.1L	252 CID	High Performance; Base,Brougham,LJ,Base	US1018H
1986-1987	V6-4.3L	262 CID	Base,Brougham,LE	US1121
1986-1987	V6-4.3L	262 CID	High Performance; Base,Brougham,LE	US1121H
1980-1981	V8-4.3L	265 CID	Base,LJ,Brougham	US975
1977-1980	V8-4.9L	301 CID	Base,LJ,SJ	US975
1978-1987	V8-5.0L	305 CID	Base,LJ,SJ,Brougham,LE	US1121
1978-1987	V8-5.0L	305 CID	High Performance; Base,LJ,SJ,Brougham,LE	US1121H
2005-2008	V8-5.3L	325 CID	GXP	US6154
1976	V8-5.7L	350 CID		US975
1976-1984	V8-5.7L	350 CID	Air Cond; High Performance; Base,Brougham,LJ,LE	US1120H
1976-1984	V8-5.7L	350 CID	Air Cond; Base,Brougham,LJ,LE	US1120
1976-1984	V8-7.7L	350 CID	Exc.Air Cond; Base,Brougham,LJ,LE	US1100
1962-1966	V8-6.4L	389 CID		US850
1967-1968	V8-6.6L	400 CID		US850
1975-1977	V8-6.6L	400 CID		US975
1975-1977	V8-6.6L	400 CID	Air Cond	US1120
1975-1977	V8-6.6L	400 CID	Air Cond; High Performance	US1120H
1975-1977	V8-6.6L	400 CID	Exc.Air Cond	US1100
1977	V8-6.6L	403 CID		US975
1963-1966	V8-6.9L	421 CID		US850
1967-1968	V8-7.0L	428 CID		US850
1975-1976	V8-7.5L	455 CID		US975
<b>GRAND SAFARI</b>				
1977	V8-4.9L	301 CID		US975
1977	V8-5.7L	350 CID		US975
1975-1978	V8-6.6L	400 CID		US975
1975-1978	V8-6.6L	400 CID	Air Cond	US1120
1975-1978	V8-6.6L	400 CID	Air Cond; High Performance	US1120H
1975-1978	V8-6.6L	400 CID	Exc.Air Cond	US1100
1977-1978	V8-6.6L	403 CID		US975
1977-1978	V8-6.6L	403 CID	Air Cond	US1120
1977-1978	V8-6.6L	403 CID	Air Cond; High Performance	US1120H
1977-1978	V8-6.6L	403 CID	Exc.Air Cond	US1100
1975-1976	V8-7.5L	455 CID		US975
<b>GTO</b>				
2004	V8-5.7L	350 CID	Base	US5081
2005-2006	V8-6.0L	364 CID	Base	US65
2005-2006	V8-6.0L	364 CID	Includes thermostat and thermostat housing; Base	US65-T





# WATER PUMP APPLICATION GUIDE



Years	Engine	Disp.	Application Description	USMW
1964-1966	V8-6.4L	389 CID		US850
1967-1968	V8-6.6L	400 CID		US850
1964-1965	V8-6.9L	421 CID		US850
<b>J2000</b>				
1982-1983	L4-1.8L	112 CID	Base,LE,SE	US5036
<b>J2000 SUNBIRD</b>				
1984	L4-1.8L	112 CID	Base,LE,SE	US5036
1985	L4-1.8L	112 CID	Base,LE,SE	US5017
1984-1985	L4-2.0L	122 CID	Base,LE	US5007
<b>LEMANS</b>				
1988-1993	L4-1.6L	98 CID	Aerocoupe,Aerocoupe YL,Base,SE,Value Leader,LE	US5045
1989-1990	L4-2.0L	122 CID	GSE,LE,SE	US5036
1975-1977	L6-4.1L	250 CID		US1107
1977-1981	V6-3.8L	231 CID	Base,Safari	US1018
1977-1981	V6-3.8L	231 CID	High Performance; Base,Safari	US1018H
1980	V6-3.8L	229 CID	High Performance; Base,Safari,Base	US1121H
1976	V8-4.3L	260 CID	Air Cond; High Performance,;	US1120H
1980-1981	V8-4.3L	265 CID	Base,Safari,	US975
1977-1981	V8-4.9L	301 CID	Base	US975
1977-1980	V8-5.0L	305 CID	Base,Safari	US1121
1977-1980	V8-5.0L	305 CID	High Performance; Base,Safari	US1121H
1968	V8-5.7L	350 CID		US850
1975-1976	V8-5.7L	350 CID		US975
1975-1979	V8-5.7L	350 CID	Air Cond	US1120
1975-1979	V8-5.7L	350 CID	Air Cond; High Performance	US1120H
1975-1979	V8-5.7L	350 CID	Exc.Air Cond	US1100
1963-1966	V8-6.4L	389 CID		US850
1967-1968	V8-6.6L	400 CID		US850
1975-1977	V8-6.6L	400 CID		US975
1975-1977	V8-6.6L	400 CID	Air Cond	US1120
1975-1977	V8-6.6L	400 CID	Air Cond; High Performance	US1120H
1975-1977	V8-6.6L	400 CID	Exc.Air Cond	US1100
1977	V8-6.6L	403 CID		US975
1967-1968	V8-7.0L	428 CID		US850
1976	V8-7.5L	455 CID		US975
<b>MATIZ</b>				
2004-2008	L4-1.0L	61 CID		US8928
<b>MATIZ (MEX)</b>				
2004-2009	L4-1.0L	60 CID	FI SOHC	US8928
<b>MONTANA</b>				
1999-2005	V6-3.4L	207 CID	Base	US5033
2005-2006	V6-3.5L	213 CID	SV6	US5033
2006	V6-3.9L	237 CID	SV6	US6020
<b>MONTANA (MEX)</b>				
2007-2009	V6-3.9L	237 CID	SFI OHV ; 2WD	US6020
<b>PARISIENNE</b>				
1984	V6-3.8L	231 CID	High Performance; Base,Brougham,Base	US1018H
1985-1986	V6-4.3L	262 CID	Base,Brougham	US1121
1985-1986	V6-4.3L	262 CID	High Performance; Base,Brougham	US1121H
1983-1986	V8-5.0L	305 CID	Base,Brougham	US1121
1983-1986	V8-5.0L	305 CID	High Performance; Base,Brougham	US1121H
1986	V8-5.0L	307 CID	Air Cond; High Performance; Base,Brougham,Base	US1120H
1983-1985	V8-5.7L	350 CID	Air Cond; Base,Brougham	US1120
1983-1985	V8-5.7L	350 CID	Air Cond; High Performance; Base,Brougham	US1120H
<b>PHOENIX</b>				
1977-1978	L4-2.5L	151 CID		US1107
1980-1984	L4-2.5L	151 CID	3 Groove pulley; Base,LJ,LE	US5000P
1980-1984	L4-2.5L	151 CID	W/O Pulley; Base,LJ,LE	US5000
1980-1984	V6-2.8L	173 CID	Base,LJ,SJ,LE,SE	US5001
1977-1979	V6-3.8L	231 CID		US1018
1977-1979	V6-3.8L	231 CID	High Performance	US1018H
1977-1978	V8-5.0L	305 CID		US1121
1977-1978	V8-5.0L	305 CID	High Performance	US1121H
1979	V8-5.0L	305 CID		US1069
1977-1978	V8-5.7L	350 CID		US1121
1977-1978	V8-5.7L	350 CID	High Performance	US1121H
1977-1979	V8-5.7L	350 CID	Air Cond	US1120
1977-1979	V8-5.7L	350 CID	Air Cond; High Performance	US1120H

Years	Engine	Disp.	Application Description	USMW
1977-1979	V8-5.7L	350 CID	Exc.Air Cond	US1100
<b>PURSUIT</b>				
2005-2006	L4-2.2L	134 CID		US5092
2006	L4-2.4L	145 CID		US5092
<b>SAFARI</b>				
1987-1989	V8-5.0L	307 CID	Air Cond; Base	US1120
1987-1989	V8-5.0L	307 CID	Air Cond; High Performance; Base	US1120H
1968	V8-5.7L	350 CID		US850
1959-1966	V8-6.4L	389 CID		US850
1967-1968	V8-6.6L	400 CID		US850
1976	V8-6.6L	400 CID		US975
1963-1966	V8-6.9L	421 CID		US850
1967-1968	V8-7.0L	428 CID		US850
1976	V8-7.5L	455 CID		US975
<b>SOLSTICE</b>				
2007-2009	L4-2.0L	122 CID	GXP	US5092
2006-2009	L4-2.4L	145 CID	Base	US5092
<b>STAR CHIEF</b>				
1959-1966	V8-6.4L	389 CID		US850
1963-1966	V8-6.9L	421 CID		US850
<b>SUNBIRD</b>				
1986	L4-1.8L	112 CID	GT,SE	US5017
1986	L4-2.0L	122 CID	SE	US5007
1987-1994	L4-2.0L	122 CID	Base,GT,SE,LE,Value Leader,LE Value Leader	US5036
1977-1980	L4-2.5L	151 CID	Base	US1107
1991-1994	V6-3.1L	189 CID	GT,LE,SE,LE Value Leader	US5033
1976-1980	V6-3.8L	231 CID	Base	US1018
1976-1980	V6-3.8L	231 CID	High Performance; Base	US1018H
1978	V8-5.0L	305 CID	High Performance,;	US1121H
1979	V8-5.0L	305 CID		US1069
<b>SUNFIRE</b>				
1995-2001	L4-2.2L	134 CID	SE,GT	US5032
2002-2005	L4-2.2L	134 CID	GT,SE,Base	US5092
1995	L4-2.3L	138 CID	GT,SE	US5043
1996-2002	L4-2.4L	146 CID	GT,SE	US5076
<b>T1000</b>				
1981-1987	L4-1.6L	98 CID	Base	US5004
<b>TEMPEST</b>				
1968	V8-5.7L	350 CID		US850
1961-1966	V8-6.4L	389 CID		US850
1967-1968	V8-6.6L	400 CID		US850
1967-1968	V8-7.0L	428 CID		US850
<b>TORRENT</b>				
2006-2009	V6-3.4L	207 CID	Base	US6145
2008-2009	V6-3.6L	217 CID	GXP	US8932
<b>TRANS SPORT</b>				
1990-1995	V6-3.1L	189 CID	Base	US5033
1996-1998	V6-3.4L	207 CID	Base,Montana	US5033
1992-1995	V6-3.8L	231 CID	Base	US5050
<b>VENTURA</b>				
1977	L4-2.5L	151 CID		US1107
1975-1976	L6-4.1L	250 CID		US1107
1977	V6-3.8L	231 CID	High Performance,;	US1018H
1975-1976	V8-4.3L	260 CID	Air Cond	US1120
1975-1976	V8-4.3L	260 CID	Air Cond; High Performance	US1120H
1975-1976	V8-4.3L	260 CID	Exc.Air Cond	US1100
1977	V8-4.9L	301 CID		US975
1977	V8-5.0L	305 CID	High Performance,;	US1121H
1975-1976	V8-5.7L	350 CID		US1018
1975-1976	V8-5.7L	350 CID	High Performance	US1018H
1977	V8-5.7L	350 CID	Air Cond; High Performance,;	US1120H
1960-1961	V8-6.4L	389 CID		US850
1961	V8-6.9L	421 CID		US850
<b>VIBE</b>				
2003-2006	L4-1.8L	1795cc	GT	US9405
2003-2007	L4-1.8L	1794cc	Base	US9376
2008	L4-1.8L	110 CID	Base	US9376
2009-2010	L4-2.4L	2362cc	AWD,Base,GT	US9414

Years	Engine	Disp.	Application Description	USMW
<b>PORSCHE</b>				
<b>911</b>				
1999-2001	H6-3.4L	3400cc	Carrera,Carrera 4	US9475
2002-2008	H6-3.6L	3596cc	Carrera,Carrera 4,Carrera 4S,40th Anniversary Edition,Targa 4	US9475
2005-2008	H6-3.8L	3824cc	Carrera S,Carrera 4S,Targa 4S	US9475
<b>924</b>				
1977-1982	L4-2.0L	1983cc	Base,Turbo	US9177
1987-1988	L4-2.5L	2475cc	S	US9245
<b>928</b>				
1978-1986	V8-4.5L	4474cc	Base,S	US9242
1987-1991	V8-5.0L	4950cc	S4,Base,GT	US9241
1993-1995	V8-5.4L	5392cc	GTS	US9241
<b>944</b>				
1983-1989	L4-2.5L	2475cc	Base,Turbo,S	US9245
<b>BOXSTER</b>				
1997-1999	H6-2.5L	2480cc	Base	US9475
2000-2008	H6-2.7L	2687cc	Roadster,Base,Limited Edition	US9475
2000-2006	H6-3.2L	3179cc	Roadster,Roadster S,S,S Special Edition	US9475
2007-2008	H6-3.4L	3387cc	S,RS 60 Spyder,S Limited Edition	US9475
<b>BOXSTER (MEX)</b>				
2000	H6-2.5L	2480cc	FI DOHC	US9475
<b>CAYMAN</b>				
2007-2008	H6-2.7L	2687cc	Base	US9475
2006-2008	H6-3.4L	3387cc	S	US9475
<b>RAM</b>				
<b>1500</b>				
2011-2012	V6-3.7L	226 CID	ST	US7163
2011-2012	V8-4.7L	285 CID	SLT,ST	US7163
2011-2012	V8-5.7L	345 CID	Laramie,Laramie Longhorn,SLT,Sport,ST,Tradesman	US6341
<b>2500</b>				
2011-2012	L6-6.7L	408 CID	Laramie,Laramie Longhorn,SLT,ST	US6222
2011-2012	V8-5.7L	345 CID	Laramie,Laramie Longhorn,Power Wagon,SLT,ST	US6341
<b>3500</b>				
2011-2012	L6-6.7L	408 CID	Laramie,Laramie Longhorn,SLT,ST	US6222
2011-2012	V8-5.7L	345 CID	Laramie,Laramie Longhorn,SLT,ST	US6341
<b>4500</b>				
2011-2012	L6-6.7L	408 CID	Laramie,SLT,ST	US6222
<b>5500</b>				
2011-2012	L6-6.7L	408 CID	Laramie,SLT,ST	US6222
<b>C/V</b>				
2012	V6-3.6L	220 CID		US8981
<b>DAKOTA</b>				
2011	V6-3.7L	226 CID	Big Horn,Laramie,ST	US7163
2011	V8-4.7L	285 CID	Big Horn,Laramie,TRX4	US7163
<b>RENAULT</b>				
<b>ALLIANCE</b>				
1985-1987	L4-1.7L	105 CID	DL,L,Limited,Base,GS	US8914
<b>CLIO (MEX)</b>				
2001-2002	L4-2.0L	2000cc	MFI ; Sport	US8914
2003-2006	L4-2.0L	1998cc	MFI DOHC ; Sport	US8914
<b>CLIO (MEX)</b>				
2001-2002	L4-1.6L	1600cc	MFI	US8927
2003-2009	L4-1.6L	1598cc	MFI DOHC	US8927
<b>CLIO SPORT (MEX)</b>				
2001-2002	L4-2.0L	2000cc	MFI	US8914
2003-2006	L4-2.0L	1998cc	MFI DOHC	US8914
<b>ENCORE</b>				
1985-1986	L4-1.7L	105 CID	GS,LS,S,Electronic	US8914
<b>ENCORE (MEX)</b>				
1986	L4-1.4L	1397cc	TBI	US8914
<b>FUEGO</b>				
1982-1984	L4-1.6L	1565cc	Turbo	US3406
1982-1985	L4-2.2L	2152cc	Base	US3410

Years	Engine	Disp.	Application Description	USMW
<b>KANGOO (MEX)</b>				
2004-2009	L4-1.6L	1598cc	MFI DOHC	US8927
<b>MEGANE (MEX)</b>				
2001-2002	L4-2.0L	2000cc	MFI	US8914
2003-2004	L4-2.0L	1998cc	MFI DOHC	US8914
<b>MEGANE II (MEX)</b>				
2004-2009	L4-2.0L	1998cc	MFI DOHC	US8914
<b>R10 (MEX)</b>				
1966-1972	L4-1.1L	1100cc	1BL	US9281
1967-1972	L4-1.3L	1300cc	1BL	US9282
<b>R12 (MEX)</b>				
1971-1983	L4-1.3L	1300cc	1BL	US9282
1975-1980	L4-1.6L	1600cc	2BL ; TS	US3406
<b>R12 TL (MEX)</b>				
1979-1984	L4-1.3L	1300cc	1BL	US9282
<b>R18 (MEX)</b>				
1980-1985	L4-1.6L	1600cc	2BL	US3406
1984-1986	L4-2.0L	1995cc	2BL	US8914
<b>R18i</b>				
1981-1983	L4-1.6L	1647cc	Base,Deluxe	US3406
1984-1986	L4-2.2L	2165cc	Sportwagon	US3410
<b>R5 (MEX)</b>				
1977	L4-1.3L	1300cc	1BL ; TL	US1110
1979-1984	L4-1.3L	1300cc	1BL	US9282
<b>R5 L (MEX)</b>				
1978	L4-1.3L	1300cc	1BL	US9282
<b>R5 LS (MEX)</b>				
1977-1983	L4-1.3L	1300cc	1BL ; Mirage,,TL,1BL ; LS,Mirage	US9282
<b>R8S (MEX)</b>				
1965-1975	L4-1.1L	1100cc	1BL	US9281
1968-1975	L4-1.3L	1300cc	1BL	US9282
<b>SCENIC (MEX)</b>				
2002	L4-2.0L	2000cc	MFI	US8914
2003-2004	L4-2.0L	1998cc	FI DOHC	US8914
<b>SCENIC II (MEX)</b>				
2005-2008	L4-2.0L	1998cc	MFI DOHC	US8914
<b>SAAB</b>				
<b>99</b>				
1980	L4-2.0L	1985cc	GL	US9158
<b>900</b>				
1981-1993	L4-2.0L	1985cc	Base,S,Turbo,SPG,S Turbo,SE Turbo,Turbo Commemorative Edition	US9108
1994-1998	L4-2.0L	1985cc	SE Turbo,Turbo,Turbo Commemorative Edition,S Turbo	US9307
1991-1994	L4-2.1L	2119cc	Base,S	US9108
1994-1998	L4-2.3L	2290cc	S	US9307
1994-1997	V6-2.5L	2498cc	SE	US5079
<b>9000</b>				
1986-1990	L4-2.0L	1985cc	Turbo,S,Base,CD	US9107
1990-1998	L4-2.3L	2290cc	CD,S,Base,CD Turbo,Turbo,CD Griffin Edition,Aero,CDE,CDE Turbo,CS,CS Turbo,CSE,CSE Turbo	US9264
1995-1997	V6-3.0L	2961cc	CDE,CSE	US5079
<b>9-3</b>				
1999-2003	L4-2.0L	1985cc	Base,SE	US9307
2003-2011	L4-2.0L	1985cc	Arc,Linear,Vector,Aero,2.0T,Turbo4	US5092
1999-2002	L4-2.3L	2290cc	Viggen	US9307
2006-2009	V6-2.8L	170 CID	Aero,Aero XWD,Turbo X	US8932
<b>9-5</b>				
1999-2009	L4-2.3L	2290cc	Base,SE,2.3t,Aero,Gary Fisher,Linear,Arc	US9307
2010-2011	V6-2.8L	170 CID	Aero,Turbo6	US8932
1999-2003	V6-3.0L	2961cc	Base,SE,Arc	US5079
<b>9-2X</b>				
2005	H4-2.0L	1994cc	Aero	US9215
2005-2006	H4-2.5L	2458cc	Linear,2.5i	US9223
2006	H4-2.5L	2458cc	Aero	US9215
<b>9-3X</b>				
2010-2011	L4-2.0L	1985cc	Base	US5092

Years	Engine	Disp.	Application Description	USMW
<b>9-7X</b>				
2005-2009	L6-4.2L	256 CID	Linear,4.2i	US5097
2005-2006	V8-5.3L	323 CID	Arc,5.3i	US64
2005-2006	V8-5.3L	323 CID	Includes thermostat and thermostat housing; Arc, 5.3i	US64-T
2007-2009	V8-5.3L	325 CID	5.3i	US6009
2008-2009	V8-6.0L	364 CID	Aero	US6009
<b>SATURN</b>				
<b>ASTRA</b>				
2008	L4-1.8L	110 CID	XE,XR	US6184
<b>AURA</b>				
2007-2009	L4-2.4L	145 CID	Green Line,XE,Hybrid,XR	US5092
2007-2008	V6-3.5L	213 CID	XE	US6020
2007-2009	V6-3.6L	217 CID	XR	US8932
<b>ION</b>				
2004-2007	L4-2.0L	122 CID	Red Line	US5092
2003-2006	L4-2.4L	145 CID	3	US5092
<b>L100</b>				
2001-2002	L4-2.2L	134 CID	Base	US5092
<b>L200</b>				
2001-2003	L4-2.2L	134 CID	Base	US5092
<b>L300</b>				
2001-2004	L4-2.2L	134 CID		US5092
2001-2005	V6-3.0L	181 CID	Base	US5079
<b>LS</b>				
2000	L4-2.2L	134 CID	Base	US5092
<b>LS1</b>				
2000	L4-2.2L	134 CID	Base	US5092
<b>LS2</b>				
2000	V6-3.0L	181 CID	Base	US5079
<b>LW1</b>				
2000	L4-2.2L	134 CID	Base	US5092
<b>LW2</b>				
2000	V6-3.0L	181 CID	Base	US5079
<b>LW200</b>				
2001-2003	L4-2.2L	134 CID	Base	US5092
<b>LW300</b>				
2001-2003	V6-3.0L	181 CID	Base	US5079
<b>OUTLOOK</b>				
2007-2010	V6-3.6L	217 CID	XE,XR	US8932
<b>RELAY</b>				
2006-2007	V6-3.9L	237 CID	3,1,2	US6020
<b>SC</b>				
1991-1992	L4-1.9L	116 CID	Base	US5054
<b>SC1</b>				
1993-2002	L4-1.9L	116 CID	Base	US5054
<b>SC2</b>				
1993-2002	L4-1.9L	116 CID	Base	US5054
<b>SKY</b>				
2007-2010	L4-2.0L	122 CID	Base,Red Line	US5092
<b>SL</b>				
1991-2002	L4-1.9L	116 CID	Base	US5054
<b>SL1</b>				
1991-2002	L4-1.9L	116 CID	Base	US5054
<b>SL2</b>				
1991-2002	L4-1.9L	116 CID	Base	US5054
<b>SW1</b>				
1993-1999	L4-1.9L	116 CID	Base	US5054
<b>SW2</b>				
1993-2001	L4-1.9L	116 CID	Base	US5054
<b>VUE</b>				
2002-2007	L4-2.2L	134 CID	Base	US5092
2007-2010	L4-2.4L	145 CID	Green Line,XE,Hybrid,XR	US5092
2002-2003	V6-3.0L	181 CID	Base	US5079
2004-2007	V6-3.5L	3471cc	Base,Red Line	US9470
2008-2010	V6-3.5L	213 CID	XE	US6020

Years	Engine	Disp.	Application Description	USMW
2008-2010	V6-3.6L	217 CID	Red Line,XR	US8932
<b>SCION</b>				
<b>TC</b>				
2005-2009	L4-2.4L	2398cc	Base,Spec	US9414
2010	L4-2.4L	2362cc	Base	US9414
2011-2013	L4-2.5L	2494cc	Base	US6252
<b>XA</b>				
2004-2006	L4-1.5L	1497cc	Base	US9406
<b>XB</b>				
2004-2006	L4-1.5L	1497cc	Base	US9406
2008-2012	L4-2.4L	2362cc	Base,Engine Serial # Starts With C-G	US8970
2011-2012	L4-2.4L	2362cc	Base	US9414
<b>XD</b>				
2008-2013	L4-1.8L	1798cc	Base	US6232
<b>SEAT</b>				
<b>ALHAMBRA (MEX)</b>				
2002-2007	L4-1.8L	1781cc	FI DOHC ;,MFI Turbo	US9377
2003	L4-1.8L	1798cc	Turbo DOHC	US9377
2002-2008	V6-2.8L	2792cc	FI DOHC ;,MFI DOHC	US9262
<b>ALTEA (MEX)</b>				
2005-2009	L4-2.0L	1984cc	SFI	US9377
<b>CORDOBA (MEX)</b>				
2001-2009	L4-1.6L	1600cc	FI ;,MFI	US9378
2003-2009	L4-2.0L	1984cc	SFI	US9377
<b>IBIZA (MEX)</b>				
2001-2009	L4-1.6L	1596cc		US8949
2001-2009	L4-1.6L	1600cc	FI ;,MFI	US9378
2005	L4-1.8L	1798cc	Turbo DOHC	US9377
2005-2008	L4-1.8L	1798cc		US8949
2006-2008	L4-1.8L	1781cc	FI DOHC ;,,Turbo DOHC	US9377
2003-2009	L4-2.0L	1984cc		US8949
2003-2009	L4-2.0L	1984cc	SFI	US9377
2010	L4-2.0L	1984cc	Blitz,Sport	US8949
<b>LEON (MEX)</b>				
2008-2009	L4-1.4L	1368cc	Turbo DOHC	US8949
2001-2009	L4-1.8L	1781cc	FI DOHC ;,,MFI	US9377
2006-2007	L4-2.0L	2000cc	MFI DOHC ;,DOHC Turbo	US9377
2007	L4-2.0L	1984cc	SFI	US9377
2008-2009	L4-2.0L	1998cc	Turbo DOHC	US9377
<b>TOLEDO (MEX)</b>				
2001-2005	L4-1.8L	1781cc	FI DOHC ;,,MFI	US9377
2004	L4-1.8L	1798cc	Turbo DOHC	US9377
2006	L4-2.0L	1984cc	SFI	US9377
<b>STERLING</b>				
<b>825</b>				
1987-1988	V6-2.5L	2494cc	S,SL	US9097
<b>827</b>				
1989-1990	V6-2.7L	2675cc	S,SL,SLi	US9097
<b>SUBARU</b>				
<b>B9 TRIBECA</b>				
2006-2007	H6-3.0L	3000cc	Base,Limited	US9421
<b>BAJA</b>				
2003-2006	H4-2.5L	2458cc	Base,Sport	US9223
2004-2006	H4-2.5L	2458cc	Turbo	US9215
<b>BRAT</b>				
1980	H4-1.6L	1595cc	DL,GL	US9025
1980-1987	H4-1.8L	1781cc	DL,GL	US9025
1984	H4-1.8L	1781cc	GL Turbo	US9093
<b>DL</b>				
1980-1984	H4-1.6L	1595cc	Base	US9025
1980-1984	H4-1.8L	1781cc	Base	US9025
1985-1989	H4-1.8L	1781cc	Base	US9080
1985-1989	H4-1.8L	1781cc	Exc.Air Cond; Base	US9161
<b>FORESTER</b>				
1998-2005	H4-2.5L	2458cc	Base,L,S,X,XS	US9223



Years	Engine	Disp.	Application Description	USMW
2002-2005	H4-2.5L	2458cc	Base,L,S,X,XS,XS L.L. Bean Edition	US9472
2004-2012	H4-2.5L	2458cc	XT,XT Premium,XT Limited,Sports 2.5 XT,XT Touring	US9215
2006	H4-2.5L	2458cc	DOHC; X,X L.L. Bean Edition	US6160
2006-2010	H4-2.5L	2458cc	X,X L.L. Bean Edition,Sports 2.5 X,X Limited,X Premium	US6049
<b>FORESTER (MEX)</b>				
2010	L4-2.5L	2457cc	FI SOHC ; XS AWD,XSL AWD	US9215
<b>GL</b>				
1980-1987	H4-1.6L	1595cc	Base	US9025
1980-1984	H4-1.8L	1781cc	Base,Turbo	US9025
1985-1989	H4-1.8L	1781cc	Base,Turbo	US9080
1985-1989	H4-1.8L	1781cc	Exc.Air Cond; Base,Turbo	US9161
<b>GL-10</b>				
1985-1989	H4-1.8L	1781cc	Base,Turbo	US9080
1985-1989	H4-1.8L	1781cc	Exc.Air Cond; Base,Turbo	US9161
<b>GLF</b>				
1980	H4-1.6L	1595cc	Base	US9025
1980-1982	H4-1.8L	1781cc	Base	US9025
<b>IMPREZA</b>				
1993-1997	H4-1.8L	1781cc	Base,L,LS,Outback,Brighton	US9223
2002-2005	H4-2.0L	1994cc	WRX	US9215
1995-2004	H4-2.2L	2212cc	L,LX,Outback,Brighton	US9223
1998-2005	H4-2.5L	2458cc	RS,TS,Outback Sport	US9223
2004-2012	H4-2.5L	2458cc	WRX STI,WRX,WRX Limited,WRX TR,WRX STI Limited 2.5 GT,WRX Premium,WRX STI Special Edition	US9215
2006-2011	H4-2.5L	2458cc	2.5i,Outback Sport,2.5i Premium	US6049
2010-2012	H4-2.5L	2457cc	WRX,WRX STI	US9215
<b>IMPREZA (MEX)</b>				
2008-2009	L4-2.0L	1983cc	MFI DOHC ; AWD	US9223
2010	L4-2.5L	2457cc	Turbo DOHC; WRX GT,WRX SE	US9215
<b>JUSTY</b>				
1987-1994	L3-1.2L	1189cc	Impeller Set; DL,GL,RS,Impeller Set; GL	US9486
<b>LEGACY</b>				
1990-1999	H4-2.2L	2212cc	Base,L,LS,LSi;Sport,Alpine Sport,GT,Outdoor,Sun Sport,Touring,Brighton,Outback,Postal, Limited 30th Anniversary	US9223
1993-1994	H4-2.2L	2212cc	Sport	US9255
1996-2005	H4-2.5L	2458cc	Outback,GT,LSi;Outback Limited,GT Limited,L, SUS 30th Anniversary,Brighton,L SE, Limited 35th Anniversary,i	US9223
2005-2009	H4-2.5L	2458cc	GT,GT Limited,GT spec.B	US9215
2006-2012	H4-2.5L	2458cc	2.5i,2.5i Limited,2.5i Special Edition,2.5i Premium	US6049
2010-2012	H4-2.5L	2458cc	2.5GT	US9472
2008-2009	H6-3.0L	3000cc	3.0 R Limited,3.0 R	US9421
2010-2012	H6-3.6L	3630cc	3.6R,3.6R Limited,3.6R Premium	US9421
<b>LEGACY (MEX)</b>				
2008-2009	L4-2.0L	1987cc	MFI SOHC ; AWD	US9223
<b>LEONE</b>				
1984-1989	L4-1.6L	1595cc		US8903
<b>LOYALE</b>				
1990-1994	H4-1.8L	1781cc	Base,RS,RS Turbo,Turbo	US9161
<b>OUTBACK</b>				
2000-2005	H4-2.5L	2458cc	Base,Limited,i	US9223
2005-2009	H4-2.5L	2458cc	XT,XT Limited	US9215
2006-2012	H4-2.5L	2458cc	2.5i,2.5i Limited,2.5i Basic,2.5i L.L. Bean Edition, 2.5i Limited L.L. Bean Edition,Base,2.5i Premium	US6049
2001-2010	H6-3.0L	3000cc	L.L. Bean,VDC,H6,H6 35th Anniversary Edition, H6 VDC,R,R L.L. Bean Edition,VDC Limited, R VDC Limited,3.0 R Limited,3.6R	US9421
2010-2012	H6-3.6L	3630cc	3.6R Limited,3.6R Premium,3.6R	US9421
<b>RX</b>				
1986-1989	H4-1.8L	1781cc	Exc.Air Cond; Turbo	US9161
1986-1989	H4-1.8L	1781cc	Turbo	US9080
<b>STANDARD</b>				
1980-1987	H4-1.6L	1595cc	Base	US9025
1981-1982	H4-1.8L	1781cc	Base	US9025
1987	H4-1.8L	1781cc	Exc.Air Cond; Base,Base	US9161

Years	Engine	Disp.	Application Description	USMW
<b>SVX</b>				
1992-1997	H6-3.3L	3318cc	LS,LSL,L,LSi	US9254
<b>TRIBECA</b>				
2008-2012	H6-3.6L	3630cc	Base,Limited,Premium,Touring	US9421
<b>XT</b>				
1985-1991	H4-1.8L	1781cc	DL,GL,GL-10 Turbo,GL-10	US9080
1988-1991	H6-2.7L	2672cc	XT6	US9109
<b>SUZUKI</b>				
<b>AERIO</b>				
2002-2003	L4-2.0L	2000cc	GS,S,SX	US9342
2004-2007	L4-2.3L	2290cc	LX,S,SX,Base,Premium,SX Premium	US9342
<b>CARRY</b>				
1990-1991	L4-1.0L	997cc		US8929
<b>EQUATOR</b>				
2009-2011	V6-4.0L	3954cc	Base,RMZ-4,Sport	US9426
<b>ESTEEM</b>				
1995-1996	L4-1.6L	98 CID	GL,GLX,GLX Plus	US5048
1997-2000	L4-1.6L	1590cc	GL,GLX,GLX Plus	US9374
1999-2002	L4-1.8L	1790cc	GL,GLX,GLX Plus	US9342
<b>FORENZA</b>				
2004-2008	L4-2.0L	2000cc	EX,LX,S,Base,Premium	US8925
<b>GRAND VITARA</b>				
1999-2005	V6-2.5L	2500cc	JLX,JLX Plus,JS,JS Plus,JLS,JLS Plus,Limited, JLS Plus SE,JLX Plus SE,Base,EX,LX	US9385
2001-2008	V6-2.7L	2737cc	XL-7,XL-7 Limited,XL-7 Plus,XL-7 Touring,Base, Luxury,Premium,XSport	US9385
2009-2010	V6-3.2L	3195cc	Luxury,XSport,Limited	US8932
<b>RENO</b>				
2005-2008	L4-2.0L	1998cc	EX,LX,S,Base,Convenience,Premium	US8925
<b>SAMURAI</b>				
1986-1995	L4-1.3L	81c CID	JA,JX,JX SE,Base,JL,JS	US5029
<b>SIDEKICK</b>				
1989	L4-1.3L	81c CID	JA	US5029
1989-1998	L4-1.6L	1590cc	JLX,JX,JS,JL	US5048
1996-1998	L4-1.8L	1840cc	JLX Sport,JX Sport,JS Sport	US9342
<b>SJ410</b>				
1982-1984	L4-1.0L	993cc	VIN F10A548473	US9227
1982-1984	L4-1.0L	993cc	VIN F10A548474	US9232
<b>SWIFT</b>				
1992-1994	L3-1.0L	61 CID	GA	US5058
1989-2001	L4-1.3L	1295cc	GLX,GTI,GA,GL,GS,GT,S,Base	US5058
<b>SWIFT (MEX)</b>				
2007-2009	L4-1.5L	1500cc	EFI DOHC	US9374
<b>SX4</b>				
2007-2009	L4-2.0L	1995cc	Base,Sport	US9342
<b>VERONA</b>				
2004-2006	L6-2.5L	2492cc	EX,LX,S,Base,Luxury	US6241
<b>VITARA</b>				
1999-2001	L4-1.6L	1590cc	JS,JS Plus,JX,JX Plus,JLS,JLX	US9374
1999-2003	L4-2.0L	2000cc	JS,JS Plus,JX,JX Plus,JLS,JLX,Base	US9342
2004	V6-2.5L	2500cc	LX	US9385
<b>X-90</b>				
1996-1998	L4-1.6L	1590cc	Base,SE	US5048
<b>XL-7</b>				
2002-2004	V6-2.7L	2700cc	Base,Limited,Plus,Touring,EX,LX	US9385
2005-2006	V6-2.7L	2737cc	EX,LX,Base,Premium	US9385
2007-2009	V6-3.6L	3564cc	Base,Limited,Luxury,Premium	US8932
<b>TOYOTA</b>				
<b>4RUNNER</b>				
1984	L4-2.4L	2366cc	DLX,SR5	US9017
1985-1995	L4-2.4L	2366cc	DLX,SR5	US9141
1987-1996	L4-2.4L	2366cc		US8904
1996-2010	L4-2.7L	2694cc	Base,Limited,SR5	US9293
1988-1990	V6-3.0L	2959cc	SR5,DLX	US9142
1989-1992	V6-3.0L	2959cc	DLX,SR5	US9145

Years	Engine	Disp.	Application Description	USMW
1993-1995	V6-3.0L	2959cc		<b>US9320</b>
1996-2002	V6-3.4L	3378cc	Limited,SR5,Base	<b>US9324</b>
2003-2009	V6-4.0L	3956cc	Limited,SR5,Sport	<b>US6037</b>
2010-2014	V6-4.0L	3956cc	Limited,SR5,Trail	<b>US6599</b>
2003-2009	V8-4.7L	4663cc	Limited,SR5,Sport	<b>US9257</b>
<b>AVALON</b>				
1995-2004	V6-3.0L	2995cc	XL,XLS	<b>US9306</b>
2005-2014	V6-3.5L	3456cc	Limited,Touring,XL,XLS,Base,	<b>US6047</b>
<b>AVANZA (MEX)</b>				
2007-2011	L4-1.5L	1497cc	EFI DOHC	<b>US9406</b>
<b>CAMRY</b>				
1984-1986	L4-1.8L	1839cc	DLX	<b>US9059</b>
1983-1986	L4-2.0L	1995cc	DLX,LE	<b>US9048</b>
1986	L4-2.0L	1974cc	DLX	<b>US9059</b>
1987-1991	L4-2.0L	1998cc	DLX,LE,Base,DLX All Trac,LE All Trac	<b>US9099</b>
1992-2001	L4-2.2L	2164cc	DLX,LE,XLE,DX,CE	<b>US9099</b>
2002-2011	L4-2.4L	2362cc	LE,SE,XLE,Base,CE,Hybrid	<b>US9414</b>
2010-2013	L4-2.5L	2494cc	LE,SE,XLE,L,	<b>US6252</b>
1988-1991	V6-2.5L	2508cc	DLX,LE	<b>US9258</b>
1992-1993	V6-3.0L	2959cc	DLX,LE,SE,XLE,DX	<b>US9258</b>
1994-2006	V6-3.0L	2995cc	LE,SE,XLE,CE	<b>US9306</b>
2004-2006	V6-3.3L	3300cc	SE	<b>US9306</b>
2007-2014	V6-3.5L	3456cc	LE,SE,XLE,	<b>US6047</b>
<b>CELICA</b>				
1990-1993	L4-1.6L	1587cc	ST	<b>US9057</b>
1994-1997	L4-1.8L	1762cc	ST	<b>US9272</b>
2000-2005	L4-1.8L	1794cc	GT	<b>US9376</b>
2000-2005	L4-1.8L	1795cc	GTS	<b>US9405</b>
1986	L4-2.0L	1995cc	ST	<b>US9048</b>
1986	L4-2.0L	1998cc	GT,	<b>US9087</b>
1986-1993	L4-2.0L	1998cc	GTS,All Trac,GTS All Trac	<b>US9140</b>
1987-1989	L4-2.0L	1998cc	GT,ST	<b>US9099</b>
1975-1977	L4-2.2L	2189cc		<b>US9027</b>
1978-1980	L4-2.2L	2189cc	GT,ST	<b>US9017</b>
1990-1999	L4-2.2L	2164cc	GT,GTS	<b>US9099</b>
1981-1984	L4-2.4L	2366cc	GT,ST,GTS	<b>US9017</b>
1985	L4-2.4L	2366cc	GT,GTS,ST	<b>US9141</b>
1979	L6-2.6L	2563cc		<b>US9170</b>
1980	L6-2.6L	2563cc	Supra	<b>US9039N</b>
1981	L6-2.8L	2759cc	Supra	<b>US9039N</b>
1982-1986	L6-2.8L	2754cc	Supra	<b>US9040N</b>
<b>COROLLA</b>				
1970-1974	L4-1.2L	1166cc	From 5/70,,	<b>US1006</b>
1977	L4-1.2L	1166cc		<b>US9021</b>
1978-1979	L4-1.2L	1166cc		<b>US9015</b>
1975	L4-1.6L	1588cc		<b>US9012</b>
1976	L4-1.6L	1588cc	From 12/75,,	<b>US9016</b>
1977-1979	L4-1.6L	1588cc		<b>US9018</b>
1983-1992	L4-1.6L	1587cc	Base,DLX,SR5,LE,LE Limited,FX,DLX All Trac, SR5 All Trac	<b>US9057</b>
1984-1987	L4-1.6L	1587cc	Sport DLX,Sport SR5	<b>US9046</b>
1985-1986	L4-1.6L	1587cc	Sport GTS	<b>US9075</b>
1987-1991	L4-1.6L	1587cc	Sport GTS,FX16,FX16 GTS,GTS	<b>US9076</b>
1993-1997	L4-1.6L	1587cc	Base,DX,CE	<b>US9271</b>
1980-1982	L4-1.8L	1770cc	Base,DLX,SR5	<b>US9018</b>
1984-1985	L4-1.8L	1839cc	DLX	<b>US9059</b>
1993-1997	L4-1.8L	1762cc	DX,LE,CE	<b>US9272</b>
1998-2008	L4-1.8L	1794cc	CE,LE,VE,S	<b>US9376</b>
2005-2006	L4-1.8L	1795cc	XRS	<b>US9405</b>
2009-2014	L4-1.8L	1798cc	Base,LE,S,XLE,Japan Built Part; Base,	<b>US6232</b>
2009-2010	L4-2.4L	2362cc	XRS	<b>US9414</b>
<b>CORONA</b>				
1975	L4-2.2L	2189cc		<b>US9005</b>
1976-1977	L4-2.2L	2189cc	From 09/75,,	<b>US9027</b>
1978-1982	L4-2.2L	2189cc	DLX,LE	<b>US9017</b>
<b>CRESSIDA</b>				
1978-1979	L6-2.6L	2563cc		<b>US9170</b>
1980	L6-2.6L	2563cc	Base	<b>US9039N</b>

Years	Engine	Disp.	Application Description	USMW
1981-1982	L6-2.8L	2759cc	Luxury	<b>US9039N</b>
1983-1988	L6-2.8L	2754cc	Luxury	<b>US9040N</b>
1989-1992	L6-3.0L	2954cc	Luxury	<b>US9100</b>
<b>CROWN</b>				
1975-1976	L4-2.3L	2253cc		<b>US9180</b>
<b>ECHO</b>				
2000-2005	L4-1.5L	1497cc	Base	<b>US9406</b>
<b>FJ CRUISER</b>				
2007-2009	V6-4.0L	3956cc	Base,TRD Special Edition,Trail Teams Special Edition	<b>US6037</b>
2010-2014	V6-4.0L	3956cc	Base	<b>US6599</b>
<b>HIACE</b>				
1995-2004	L4-2.4L	2446cc		<b>US8904</b>
<b>HIACE (MEX)</b>				
2006-2011	L4-2.7L	2694cc	FI DOHC	<b>US9293</b>
<b>HIGHLANDER</b>				
2001-2007	L4-2.4L	2362cc	Base	<b>US9414</b>
2009-2013	L4-2.7L	2672cc	Base,	<b>US6252</b>
2001-2003	V6-3.0L	2995cc	Base,Limited	<b>US9306</b>
2004-2010	V6-3.3L	3300cc	Base,Limited,Hybrid,Hybrid Limited,Sport	<b>US9306</b>
2008-2014	V6-3.5L	3456cc	Base,Limited,Sport,Hybrid,Hybrid Limited,	<b>US6047</b>
<b>HILUX</b>				
1988-2001	L4-2.4L	2446cc		<b>US8904</b>
<b>HILUX (MEX)</b>				
2004-2010	L4-2.7L	2694cc	FI DOHC	<b>US9293</b>
<b>LAND CRUISER</b>				
1990-1993	L4-2.4L	2446cc		<b>US8904</b>
1969-1974	L6-3.9L	3878cc		<b>US9078</b>
1988-1992	L6-4.0L	3956cc	Base	<b>US9155</b>
1977-1979	L6-4.2L	4227cc	(Exc.Oil Cooler)	<b>US9327</b>
1977-1979	L6-4.2L	4227cc	(Exc.Oil Cooler) (To 01/79)	<b>US9493</b>
1979-1980	L6-4.2L	4227cc	(From 01/79),;Base	<b>US9189</b>
1981-1987	L6-4.2L	4227cc	Base	<b>US9337</b>
1990-2002	L6-4.2L	4164cc	Diesel	<b>US8950</b>
1993-1997	L6-4.5L	4477cc	Base	<b>US9269</b>
1998-2007	V8-4.7L	4663cc	Base	<b>US9257</b>
2008-2013	V8-5.7L	5663cc	Base,	<b>US6197</b>
<b>MATRIX</b>				
2003-2006	L4-1.8L	1795cc	XRS	<b>US9405</b>
2003-2008	L4-1.8L	1794cc	Base,XR	<b>US9376</b>
2009-2013	L4-1.8L	1798cc	Base,	<b>US6232</b>
2009-2013	L4-2.4L	2362cc	Japan Built Part; S,XRS,S,	<b>US9414</b>
<b>MR2</b>				
1985-1989	L4-1.6L	1587cc	GT,Super Charged	<b>US9076</b>
1991-1995	L4-2.0L	1998cc	Turbo	<b>US9140</b>
1991-1995	L4-2.2L	2164cc	Base	<b>US9099</b>
<b>MR2 (MEX)</b>				
2006	L4-1.8L	1796cc	MFI DOHC ; Spyder	<b>US9376</b>
<b>MR2 SPYDER</b>				
2000-2005	L4-1.8L	1794cc	Base	<b>US9376</b>
<b>PASEO</b>				
1992-1994	L4-1.5L	1497cc	Base	<b>US9098</b>
1995-1998	L4-1.5L	1497cc	Base,To 11/96; Base,Convertible	<b>US9367</b>
<b>PICKUP</b>				
1975-1985	L4-2.0L	1994cc		<b>US9296</b>
1975	L4-2.2L	2189cc		<b>US9005</b>
1976-1977	L4-2.2L	2189cc		<b>US9027</b>
1978-1980	L4-2.2L	2189cc	Base,DLX,SR5	<b>US9017</b>
1981-1983	L4-2.2L	2188cc	DLX,SR5	<b>US9094</b>
1981-1984	L4-2.4L	2366cc	Base,DLX,SR5	<b>US9017</b>
1984-1985	L4-2.4L	2446cc	DLX,DLX Turbo	<b>US9200</b>
1985-1995	L4-2.4L	2366cc	Base,DLX,SR5,SR5 Turbo,Base Turbo	<b>US9141</b>
1988-1990	V6-3.0L	2959cc	Base,DLX,SR5,1/2 Ton Chassis; To 02/90; DLX	<b>US9142</b>
1989-1992	V6-3.0L	2959cc	DLX,SR5,1 Ton Chassis; DLX,Base	<b>US9145</b>
1993-1995	V6-3.0L	2959cc		<b>US9320</b>
1993-1995	V6-3.0L	2959cc	Base,DLX,SR5	<b>US9291</b>
<b>PREVIA</b>				
1991-1997	L4-2.4L	2438cc	DX,LE	<b>US9216</b>

Years	Engine	Disp.	Application Description	USMW
<b>PRIUS</b>				
2001-2009	L4-1.5L	1497cc	Base,Touring	US9406
<b>RAV4</b>				
1996-2000	L4-2.0L	1998cc	Base	US9099
2001-2003	L4-2.0L	1998cc	Base	US9414
2004-2008	L4-2.4L	2362cc	Base,L,Sport,Limited	US9414
2009-2013	L4-2.5L	2494cc	Base,Limited,Sport	US6252
2006-2012	V6-3.5L	3456cc	Base,Limited,Sport	US6047
<b>SEQUOIA</b>				
2001-2009	V8-4.7L	4663cc	Limited,SR5	US9257
2008-2014	V8-5.7L	5663cc	Limited,Platinum,SR5,Japan Built Part; Limited,	US6197
<b>SIENNA</b>				
2011-2012	L4-2.7L	2672cc	Base,LE	US6252
1998-2003	V6-3.0L	2995cc	CE,LE,XLE	US9306
2004-2006	V6-3.3L	3300cc	CE,LE,XLE,XLE Limited,Limited	US9306
2007-2014	V6-3.5L	3456cc	CE,LE,Limited,XLE,From 01/09; CE,Base,SE,	US6047
<b>SIENNA (MEX)</b>				
2007	V6-3.3L	3311cc	SFI	US9306
<b>SIENNA CE (MEX)</b>				
2011	V6-3.5L	3499cc	FI DOHC	US6047
<b>SOLARA</b>				
1999-2001	L4-2.2L	2164cc	SE	US9099
2002-2008	L4-2.4L	2362cc	SE,SLE,SE Sport,Sport	US9414
1999-2003	V6-3.0L	2995cc	SE,SLE	US9306
2004-2008	V6-3.3L	3300cc	SE,SLE,SE Sport,Sport	US9306
<b>STARLET</b>				
1981-1982	L4-1.3L	1290cc	Base	US9015
1983-1984	L4-1.3L	1290cc	Base	US9064
<b>SUPRA</b>				
1986-1992	L6-3.0L	2954cc	Base,Turbo	US9100
1993-1998	L6-3.0L	2997cc	Base	US9256
1993-1998	L6-3.0L	2997cc	Twin Turbo	US9292
<b>T100</b>				
1994-1998	L4-2.7L	2694cc	Base	US9293
1993-1994	V6-3.0L	2959cc		US9320
1993-1994	V6-3.0L	2959cc	Base,One-Ton,SR5	US9291
1995-1998	V6-3.4L	3378cc	Auto Trans.; Base,DLX,One-Ton DLX,SR5	US9325
1995-1998	V6-3.4L	3378cc	Standard Trans.; Base,DLX,One-Ton DLX,SR5,	US9324
<b>TACOMA</b>				
1995-2004	L4-2.4L	2438cc	DLX,Pre Runner,Limited,SR5,Base	US9293
1995-2012	L4-2.7L	2694cc	DLX,Pre Runner,Limited,SR5,Base	US9293
1995-2000	V6-3.4L	3378cc	DLX,Pre Runner	US9325
1995-2004	V6-3.4L	3378cc	DLX,SR5,Limited,Pre Runner,S-Runner,Base	US9324
2005-2012	V6-4.0L	3956cc	Base	US6037
<b>TERCEL</b>				
1980	L4-1.5L	1542cc	1AC	US9028
1980-1988	L4-1.5L	1452cc	DLX,SR5,STD,Exc.Calif; DLX,DX	US9045
1981-1982	L4-1.5L	1452cc	Calif; DLX,SR5,STD	US9086
1987-1993	L4-1.5L	1456cc	DLX,STD,EZ,Base,DX,LE	US9098
1994	L4-1.5L	1456cc	From 08/94; DLX,LE,STD,DLX	US9367
1995-1998	L4-1.5L	1497cc	DX,STD,To 11/96; CE,CE	US9367
1997-1998	L4-1.5L	1497cc	From 11/96; CE,CE	US9334
<b>TUNDRA</b>				
2000-2004	V6-3.4L	3378cc	Base,SR5	US9324
2000-2004	V6-3.4L	3378cc	Base,SR5	US9325
2005-2010	V6-4.0L	3956cc	Base,SR5	US6037
2011-2014	V6-4.0L	3956cc	From 10/2010; Base,Base,SR5,SR	US6599
2000-2009	V8-4.7L	4663cc	Limited,SR5,Base	US9257
2007-2014	V8-5.7L	5663cc	Base,Limited,SR5,	US6197
<b>VAN</b>				
1984-1985	L4-2.0L	1998cc	Wagon Crg,Wagon DX,Wagon LE	US9092
1986-1989	L4-2.2L	2237cc	Wagon Crg,Wagon DX,Wagon LE	US9092
<b>VENZA</b>				
2009-2013	L4-2.7L	2672cc	Base,LE,XLE	US6252
2009-2014	V6-3.5L	3456cc	Base,Limited,	US6047
<b>YARIS</b>				
2007-2013	L4-1.5L	1497cc	Base,S,To 11/11; L,LE,SE,	US9406

Years	Engine	Disp.	Application Description	USMW
<b>YARIS (MEX)</b>				
2004-2005	L4-1.3L	1295cc	FI DOHC	US9406
2006	L4-1.5L	1497cc	EFI DOHC	US9406
<b>YARIS CORE (MEX)</b>				
2011	L4-1.5L	1497cc	EFI DOHC	US9406
<b>YARIS PREMIUM (MEX)</b>				
2011	L4-1.5L	1497cc	EFI DOHC	US9406
<b>VOLKSWAGEN</b>				
<b>ATLANTIC (MEX)</b>				
1978-1981	L4-1.6L	1600cc	1BL; 40mm Hub	US9066
1982-1984	L4-1.6L	1600cc	1BL; 30mm Hub	US9065
1978-1981	L4-1.7L	1700cc	1BL; 40mm Hub	US9066
1982-1986	L4-1.7L	1700cc	1BL; 30mm Hub	US9065
1984-1987	L4-1.8L	1800cc	1BL; 30mm Hub	US9065
<b>BEETLE</b>				
1999-2005	L4-1.8L	1781cc	GL,GLS,GLX,Sport,Turbo S	US9377
1999-2004	L4-1.9L	1896cc	GL,GLS,Sport	US9378
2004-2006	L4-1.9L	1896cc	GL,GLS,GLS TDI,TDI	US6034
1998-2005	L4-2.0L	1984cc	Base,GL,GLS,Sport	US9377
2012	L4-2.0L	1984cc	Turbo	US9047
2013	L4-2.0L	1984cc	TDI	US6034
2006-2012	L5-2.5L	2480cc	2.5,S,SE,Base	US6050
<b>BEETLE (MEX)</b>				
2006-2010	L4-2.0L	1984cc	SFI	US9377
<b>BORA</b>				
1999-2005	L4-1.6L	1595cc		US8959
<b>BORA (MEX)</b>				
2007-2009	L4-1.9L	1896cc	Turbo Dsl	US9378
2006	L4-2.0L	1984cc	SFI Turbo	US9377
2005-2009	L5-2.5L	2480cc	FI DOHC	US6050
<b>CABRIO</b>				
1995-2002	L4-2.0L	1984cc	30mm Hub; Base,High Line,GLS,30mm Hub; GL,GLX	US9065
<b>CABRIO (MEX)</b>				
2003	L4-1.8L	1781cc	MFI; 30mm Hub	US9065
<b>CABRIOLET</b>				
1985-1993	L4-1.8L	1780cc	30mm Hub; Base,Wolfsburg Edition,Bestseller, Boutique,Carat,Etienne Aigner,Classic	US9065
<b>CARIBE (MEX)</b>				
1977-1984	L4-1.6L	1600cc	1BL; 40mm Hub,,	US9066
1978-1986	L4-1.7L	1700cc	1BL; 30mm Hub	US9065
1984	L4-1.8L	1800cc	1BL; 40mm Hub	US9066
1985-1987	L4-1.8L	1800cc	1BL; 30mm Hub	US9065
<b>CC</b>				
2009-2012	L4-2.0L	1984cc	Luxury,Sport,R-Line,Lux,Lux Limited,Lux Plus	US9047
2009-2013	V6-3.6L	3597cc	VR6,VR6 4Motion,VR6 Sport,Executive,	US6221
<b>COMBI (MEX)</b>				
1988-1997	L4-1.8L	1800cc	2BL; 30mm Hub;,FI; 30mm Hub	US9065
1998-2001	L4-1.8L	1780cc	FI; 30mm Hub	US9065
1997	V6-2.8L	2788cc	FI	US9262
<b>CORRADO</b>				
1990-1992	L4-1.8L	1780cc	30mm Hub; G60	US9065
1992-1994	V6-2.8L	2792cc	SLC	US9262
<b>CORSAR (MEX)</b>				
1984-1987	L4-1.8L	1800cc	1BL; 30mm Hub	US9065
<b>CRAFTER (MEX)</b>				
2008-2011	L5-2.5L	2459cc	Turbo Dsl	US6050
<b>CROSSFOX (MEX)</b>				
2007-2009	L4-1.6L	1600cc	MFI	US8949
<b>DASHER</b>				
1975-1980	L4-1.5L	1471cc	40mm Hub;,40mm Hub; Base	US9066
1976-1981	L4-1.6L	1588cc	40mm Hub;,40mm Hub; Base	US9066
<b>DERBY (MEX)</b>				
1994-1997	L4-1.8L	1800cc	FI; 30mm Hub	US9065
1998-2001	L4-1.8L	1780cc	FI; 30mm Hub	US9065
2002-2009	L4-1.8L	1781cc	MFI; 30mm Hub	US9065
2001-2004	L4-2.0L	1984cc	SFI	US9377

WATER PUMPS



Years	Engine	Disp.	Application Description	USMW
<b>EOS</b>				
2007-2008	L4-2.0L	1984cc	2.0T,Base,Komfort,Lux,Turbo	US6022
2009-2012	L4-2.0L	1984cc	Komfort,Lux,Executive	US9047
2007-2008	V6-3.2L	3189cc	3.2,VR6	US9471
<b>EUROVAN</b>				
1993-1995	L5-2.5L	2459cc	CL,GL,MV,Camper	US9274
1997-2001	V6-2.8L	2792cc	Camper,GLS,MV	US9262
2002-2003	V6-2.8L	2792cc	From Chassis/VIN 70-2-097 001; GLS,MV,GLS	US9471
<b>EUROVAN (MEX)</b>				
2006-2009	L4-1.9L	1896cc	Turbo Dsl	US9378
2001-2003	L5-2.5L	2461cc	FI	US9262
2004	L5-2.5L	2461cc	FI	US9274
<b>FOX</b>				
1987-1993	L4-1.8L	1780cc	30mm Hub; Base,GL,GL Sport	US9065
<b>GLI (MEX)</b>				
2007	L4-2.0L	1984cc	SFI Turbo	US9377
<b>GOL (MEX)</b>				
2009-2010	L4-1.6L	1600cc	MFI	US8949
2011	L4-1.6L	1599cc	MFI SOHC ; Comfortline,GT	US8949
<b>GOLF</b>				
1985-1988	L4-1.6L	1588cc	30mm Hub; Base,30mm Hub; GL	US9065
1997-2003	L4-1.6L	1595cc		US8959
2004-2008	L4-1.6L	1598cc		US8959
1985-1992	L4-1.8L	1780cc	30mm Hub; Base,GTI,30mm Hub; GL,GT,GTI 16-Valve,GL,GTI 8-Valve	US9065
1999-2006	L4-1.8L	1781cc	GLS,GTI GLS,GTI 1.8T,GTI 337,GTI 20th Anniversary	US9377
1999-2006	L4-1.9L	1896cc	GL,GLS,GL TDI,GLS TDI	US9378
2004-2005	L4-1.9L	1896cc	GLS TDI,TDI	US6034
1990-1998	L4-2.0L	1984cc	30mm Hub; GTI 16-Valve,30mm Hub; GL,GTI Limited Edition,30mm Hub; Celebration Edition,City,GL,Sport,Jazz,K2,Trek	US9065
1999-2006	L4-2.0L	1984cc	GL,GTI,Wolfsburg Edition,GLS,GTI GLS	US9377
2010-2013	L4-2.0L	1968cc	TDI	US6034
2012	L4-2.0L	1984cc	R	US6022
2010-2012	L5-2.5L	2480cc	Base	US6050
1995-2001	V6-2.8L	2792cc	GTI VR6,GTI,GTI GLX	US9262
2002-2005	V6-2.8L	2792cc	GTI VR6	US9471
2004	V6-3.2L	3189cc	R32	US9471
<b>GOLF (MEX)</b>				
1987	L4-1.7L	1700cc	1BL; 30mm Hub	US9065
1987-1997	L4-1.8L	1800cc	1BL; 30mm Hub,,2BL; 30mm Hub;,FI; 30mm Hub	US9065
2007	L4-2.0L	1984cc	SFI	US9377
<b>GOLF GTI (MEX)</b>				
2001-2003	L4-2.0L	1984cc	SFI ;,FI SOHC	US9377
<b>GTI</b>				
2006-2007	L4-2.0L	1984cc	Base	US6022
2008-2009	L4-2.0L	1984cc	Base	US6034
2010-2012	L4-2.0L	1984cc	Base	US9047
<b>JETTA</b>				
1980-1982	L4-1.6L	1588cc	40mm Hub; Base,Special Edition,40mm Hub; To Chassis/VIN 630000; Base	US9066
1982-1992	L4-1.6L	1588cc	30mm Hub; From Chassis/VIN 630001; Base,30mm Hub; Base,GL,Wolfsburg Edition,30mm Hub; GL	US9065
1999-2005	L4-1.6L	1595cc		US8959
1981-1984	L4-1.7L	1715cc	30mm Hub; Base,Special Edition,Wolfsburg Edition,GL	US9065
1984-1992	L4-1.8L	1780cc	30mm Hub; Base,GL,GLI,GLI 16-Valve,Wolfsburg Edition,Carat,30mm Hub; Carat	US9065
2000-2005	L4-1.8L	1781cc	GLS,Wolfsburg Edition,GL,GLI	US9377
1997-1998	L4-1.9L	1896cc	30mm Hub; TDI	US9065
1999-2005	L4-1.9L	1896cc	TDI,GL TDI,GLS TDI	US9378
2004	L4-1.9L	1896cc	TDI	US6034
2005-2006	L4-1.9L	1896cc	TDI	US6212
1990-1998	L4-2.0L	1984cc	30mm Hub; GLI 16-Valve,30mm Hub; GL,GLS,Limited Edition,30mm Hub; Celebration Edition,City,GL,Trek,Wolfsburg Edition,GT,Jazz,K2	US9065
1999-2013	L4-2.0L	1984cc	GL,GLS,Wolfsburg Edition,Base,S,	US9377

Years	Engine	Disp.	Application Description	USMW
2006-2007	L4-2.0L	1984cc	2.0T,GLI	US6022
2008-2009	L4-2.0L	1984cc	GLI,Wolfsburg Edition,SEL	US6034
2008-2012	L4-2.0L	1984cc	GLI,Wolfsburg Edition,SEL	US9047
2009-2013	L4-2.0L	1968cc	TDI	US6034
2005-2012	L5-2.5L	2480cc	2.5,Value Edition,Wolfsburg Edition,S,SE,SEL	US6050
1994-2001	V6-2.8L	2792cc	GLX,GLS	US9262
2002-2004	V6-2.8L	2792cc	BDF Engine; GLS,GLX,GLI,GLS	US9471
<b>JETTA (MEX)</b>				
1987-1997	L4-1.8L	1800cc	1BL; 30mm Hub,,2BL; 30mm Hub;,FI; 30mm Hub	US9065
2009	L4-1.8L	1781cc	Turbo	US9377
2007-2010	L4-1.9L	1896cc	Turbo Dsl	US9378
2009	L4-1.9L	1896cc	Turbo Dsl	US6034
2006-2013	L4-2.0L	1984cc	FI SOHC ;,SFI	US9377
<b>JETTA BICENTENARIO (MEX)</b>				
2011	L5-2.5L	2480cc	FI DOHC	US6050
<b>JETTA SPORT (MEX)</b>				
2011-2013	L5-2.5L	2480cc	FI DOHC	US6050
<b>JETTA STYLE (MEX)</b>				
2011-2013	L5-2.5L	2480cc	FI DOHC	US6050
<b>JETTA STYLE ACTIVE (MEX)</b>				
2012-2013	L5-2.5L	2480cc	FI DOHC	US6050
<b>LUPO (MEX)</b>				
2005-2009	L4-1.6L	1600cc	MFI	US8949
<b>PANEL (MEX)</b>				
1988-1997	L4-1.8L	1800cc	2BL; 30mm Hub;,FI; 30mm Hub	US9065
1998-2001	L4-1.8L	1780cc	FI; 30mm Hub	US9065
<b>PASSAT</b>				
2004-2010	L4-1.6L	1598cc		US8959
1998-2001	L4-1.8L	1781cc	GLS,GLX	US9401
2000-2005	L4-1.8L	1781cc	GLS,GLX,GL,GLS 4 Motion	US9377
1996-1997	L4-1.9L	1896cc	30mm Hub; TDI	US9065
1998	L4-1.9L	1896cc		US9335
2005	L4-1.9L	1896cc	GL TDI,GLS	US9378
1990-1996	L4-2.0L	1984cc	30mm Hub; GL,30mm Hub; CL,GL,30mm Hub; GLS	US9065
2004	L4-2.0L	1967cc	GL,GLS	US6034
2006-2007	L4-2.0L	1984cc	2.0T,Value Edition,Wolfsburg Edition	US6022
2008	L4-2.0L	1984cc	Komfort,Lux,Turbo	US6034
2009-2010	L4-2.0L	1984cc	Komfort	US9047
2012	L5-2.5L	2480cc	S,SE,SEL,SEL Premium	US6050
1993-1997	V6-2.8L	2792cc	GLX	US9262
1998-2005	V6-2.8L	2771cc	GLS,GLX,4 Motion,GLS 4 Motion,GLX 4 Motion,GL	US9333
2006-2012	V6-3.6L	3597cc	3.6,SE,SEL Premium	US6221
<b>PASSAT (MEX)</b>				
1986	L4-1.8L	1800cc	FI; 30mm Hub	US9065
1993	L4-1.8L	1780cc	FI; 30mm Hub	US9065
1991	L4-1.9L	1902cc	Turbo Dsl; 30mm Hub	US9065
1997	L4-2.0L	1984cc	SFI; 30mm Hub	US9065
1997	V6-2.8L	2788cc	FI ; Santana	US9262
2009	V6-3.6L	3597cc	MFI DOHC	US6221
<b>PASSAT SANTANA (MEX)</b>				
1986	L4-1.8L	1800cc	FI; 30mm Hub	US9065
<b>PHAETON</b>				
2004-2006	V8-4.2L	4172cc	V8	US9410
<b>POINTER (MEX)</b>				
1998-2002	L4-1.8L	1780cc	FI; 30mm Hub	US9065
2003-2009	L4-1.8L	1781cc	MFI; 30mm Hub	US9065
<b>POINTER GTI (MEX)</b>				
2000-2004	L4-2.0L	1984cc	SFI	US9377
<b>POINTER P/U (MEX)</b>				
2003-2009	L4-1.8L	1781cc	MFI	US9377
<b>POLO (MEX)</b>				
2003-2007	L4-1.6L	1596cc	MFI	US8949
2003-2007	L4-2.0L	1984cc	SFI	US9377
<b>QUANTUM</b>				
1982-1985	L4-1.6L	1588cc	30mm Hub; Base,GL,30mm Hub; GL	US9065
1982-1983	L4-1.7L	1715cc	30mm Hub; Base,GL	US9065
1984-1985	L4-1.8L	1780cc	30mm Hub; GL,30mm Hub; Base,GL	US9065

Years	Engine	Disp.	Application Description	USMW
1983-1984	L5-2.2L	2144cc	Base, GL	US9052
1985-1988	L5-2.2L	2226cc	Base, GL, Syncro	US9052
<b>R32</b>				
2008	V6-3.2L	3189cc	Base	US9471
<b>RABBIT</b>				
1975-1980	L4-1.5L	1471cc	40mm Hub; 40mm Hub; Base, Custom, Deluxe	US9066
1978-1980	L4-1.5L	1457cc	40mm Hub; 40mm Hub; Base, Custom, Deluxe	US9066
1976-1983	L4-1.6L	1588cc	40mm Hub; 40mm Hub; Base, Custom, Deluxe, 40mm Hub; L Custom, LS, LS Deluxe, 40mm Hub; L, Wolfsburg Edition	US9066
1983-1984	L4-1.6L	1588cc	30mm Hub; L, LS, Wolfsburg Edition	US9065
1981-1984	L4-1.7L	1715cc	30mm Hub; Base, L, LS, S, Limited Edition, 30mm Hub; GL, Wolfsburg Edition, 30mm Hub; L	US9065
1981-1984	L4-1.7L	1715cc	40mm Hub; Base, L, S, Limited Edition, LS, 40mm Hub; GL, Wolfsburg Edition, 40mm Hub; L	US9066
1983-1984	L4-1.8L	1780cc	30mm Hub; GTI, 30mm Hub; GL, GTI, Wolfsburg Edition	US9065
2006-2009	L5-2.5L	2480cc	2.5, S	US6050
<b>RABBIT CONVERTIBLE</b>				
1980	L4-1.7L	1715cc	40mm Hub; Base	US9066
1981-1982	L4-1.7L	1715cc	30mm Hub; Base	US9065
1983-1984	L4-1.8L	1780cc	30mm Hub; Base, Wolfsburg Edition	US9065
<b>RABBIT PICKUP</b>				
1980	L4-1.5L	1457cc	40mm Hub; Base, LX, Sport	US9066
1980-1982	L4-1.6L	1588cc	40mm Hub; Base, LX, Sport	US9066
1981-1983	L4-1.6L	1588cc	30mm Hub; Base, LX, Sport	US9065
1981-1982	L4-1.7L	1715cc	30mm Hub; Base, LX, Sport	US9065
1981-1983	L4-1.7L	1715cc	40mm Hub; Base, LX, Sport	US9066
<b>ROUTAN</b>				
2011-2012	V6-3.6L	3604cc		US8981
<b>ROUTAN (MEX)</b>				
2010	V6-3.8L	3778cc	SFI ; Exclusive, Prestige	US6231
<b>SCIROCCO</b>				
1975	L4-1.5L	1471cc		US9066
1978	L4-1.5L	1457cc		US9066
1976-1980	L4-1.6L	1588cc	40mm Hub; Base	US9066
1981	L4-1.7L	1715cc	40mm Hub; Exc. Air Cond; Base	US9066
1981-1983	L4-1.7L	1715cc	30mm Hub; Base, S, GL	US9065
1984-1988	L4-1.8L	1780cc	30mm Hub; Base, 30mm Hub; 16-Valve	US9065
<b>SHARAN (MEX)</b>				
2005-2008	L4-1.8L	1781cc	Turbo	US9377
<b>SPORTVAN (MEX)</b>				
2007-2009	L4-1.6L	1600cc	MFI	US8949
<b>TARO</b>				
1989-1997	L4-2.4L	2446cc	4WD	US8904
<b>TIGUAN</b>				
2011-2012	L4-2.0L	1984cc	S, SE, SEL	US9047
<b>TOUAREG</b>				
2010-2012	V6-3.0L	2967cc	TDI, TDI Executive, TDI Lux, TDI Sport	US6146
2004-2005	V6-3.2L	3200cc	V6, Base	US9471
2005-2006	V6-3.2L	3189cc	Base	US9471
2007-2013	V6-3.6L	3597cc	Base, VR6,	US6221
2004-2007	V8-4.2L	4172cc	V8, Base	US9410
2007-2009	V8-4.2L	4163cc	Base	US9410
<b>TOUAREG AWD (MEX)</b>				
2007	V6-3.2L	3189cc	SFI DOHC	US9471
<b>TOUAREG TDI (MEX)</b>				
2012	V6-3.0L	2967cc	Turbo Dsl	US6146
<b>VANAGON</b>				
1983-1985	H4-1.9L	1915cc	Campmobile, GL, L	US9061
1986-1991	H4-2.1L	2109cc	Campmobile, GL, L, Syncro, Carat, Base	US9150
<b>VARIANT (MEX)</b>				
1986	L4-1.3L	1285cc	1BL; 30mm Hub	US9065
1986	L4-1.6L	1600cc	1BL; 40mm Hub,	US9066
1986	L4-1.8L	1800cc	2BL; 30mm Hub	US9065

Years	Engine	Disp.	Application Description	USMW
<b>VW VAN (MEX)</b>				
2004	L4-1.6L	1596cc	MFI; 30mm Hub	US9065
2002-2009	L4-1.8L	1781cc	MFI; 30mm Hub	US9065
<b>VOLVO</b>				
<b>164</b>				
1975	L6-3.0L	2980cc		US9077
<b>240</b>				
1990-1993	L4-2.3L	2316cc	Base, DL, SE	US9068
<b>242</b>				
1976-1984	L4-2.1L	2127cc	DL, GL, GLT, Turbo	US9049
<b>244</b>				
1976-1985	L4-2.1L	2127cc	DL, GL, GLT, Base, Turbo	US9049
1983-1984	L4-2.3L	2316cc	DL, GL	US9049
1985-1989	L4-2.3L	2316cc	DL, GL	US9068
1982-1984	L6-2.4L	2383cc	DL, GL	US9071
<b>245</b>				
1976-1985	L4-2.1L	2127cc	DL, GLT, GL, Base	US9049
1983-1984	L4-2.3L	2316cc	DL, GL, Base	US9049
1985-1989	L4-2.3L	2316cc	Base, DL, GL	US9068
1982-1984	L6-2.4L	2383cc	DL, GL, Base	US9071
<b>262</b>				
1976-1978	V6-2.7L	2673cc		US9147
1979	V6-2.7L	2673cc		US9146
1980-1981	V6-2.8L	2849cc	Base, GL	US9146
<b>264</b>				
1980-1981	L6-2.4L	2383cc	GL, GLE	US9071
1976-1978	V6-2.7L	2673cc		US9147
1979	V6-2.7L	2673cc		US9146
1980-1982	V6-2.8L	2849cc	GL, GLE	US9146
<b>265</b>				
1980	L6-2.4L	2383cc	GLE	US9071
1976-1978	V6-2.7L	2673cc		US9147
1979	V6-2.7L	2673cc		US9146
1980-1981	V6-2.8L	2849cc	GLE	US9146
<b>740</b>				
1985-1992	L4-2.3L	2316cc	GLE, Base, GL, T	US9068
1986	L6-2.4L	2377cc	GLE	US9071
<b>745</b>				
1985	L4-2.3L	2316cc	GLE	US9068
1985	L6-2.4L	2383cc	GLE	US9071
<b>760</b>				
1984	L4-2.3L	2316cc	GLE	US9049
1985-1990	L4-2.3L	2316cc	Base, GLE	US9068
1983-1984	L6-2.4L	2383cc	GLE	US9071
1985	L6-2.4L	2377cc	GLE	US9071
<b>780</b>				
1989-1991	L4-2.3L	2316cc	Base	US9068
<b>850</b>				
1994-1997	L5-2.3L	2319cc	GLT, Turbo, T-5R, R, T-5	US9339
1993-1997	L5-2.4L	2435cc	GLT, Base	US9339
<b>940</b>				
1991-1995	L4-2.3L	2316cc	GLE, SE, T, GL, Base	US9068
<b>960</b>				
1992-1994	L6-2.9L	2922cc	Base	US9339
1995-1997	L6-2.9L	2922cc	Base	US9340
<b>C30</b>				
2008-2012	L5-2.5L	2521cc	T5	US9339
<b>C30 (MEX)</b>				
2008-2009	L5-2.4L	2400cc	FI DOHC	US9339
<b>C70</b>				
1998-2004	L5-2.3L	2319cc	Base	US9339
1998-2002	L5-2.4L	2435cc	Base	US9339
2006-2012	L5-2.5L	2521cc	T5	US9339
<b>S40</b>				
2000-2004	L4-1.9L	1948cc	Base	US9339
2004-2010	L5-2.4L	2435cc	i, LSE, T5, 2.4i	US9339





USMW	Years	Cyl.	Specifications
<b>US61</b>	2003-2005	V8-6.0L	FORD EXCURSION
	2003-2004	V8-6.0L	FORD F-250 SUPER DUTY
	2003-2004	V8-6.0L	FORD F-350 SUPER DUTY
	2003-2004	V8-6.0L	FORD F-450 SUPER DUTY
	2003-2004	V8-6.0L	FORD F-550 SUPER DUTY
<b>US63</b>	2001-2005	V8-6.6L	CHEVROLET SILVERADO 2500 HD
	2001-2005	V8-6.6L	CHEVROLET SILVERADO 3500
	2001-2005	V8-6.6L	GMC SIERRA 2500 HD
	2001-2005	V8-6.6L	GMC SIERRA 3500
	<b>US64</b>	2004-2006	V8-4.8L
2005-2006		V8-4.8L	CHEVROLET EXPRESS 3500
1999-2006		V8-4.8L	CHEVROLET SILVERADO 1500
2006-2009		V8-4.8L	CHEVROLET SILVERADO 2500 (MEX)
2000-2006		V8-4.8L	CHEVROLET TAHOE
2004-2006		V8-4.8L	GMC SAVANA 2500
2004-2006		V8-4.8L	GMC SAVANA 3500
1999-2006		V8-4.8L	GMC SIERRA 1500
2000-2006		V8-4.8L	GMC YUKON
2004-2006		V8-5.3L	BUICK RAINIER
2004-2005		V8-5.3L	CADILLAC ESCALADE
2004-2006		V8-5.3L	CHEVROLET AVALANCHE 1500
2004-2006		V8-5.3L	CHEVROLET EXPRESS 1500
2004-2005		V8-5.3L	CHEVROLET EXPRESS 2500
2004-2006		V8-5.3L	CHEVROLET SILVERADO 1500
2004-2009		V8-5.3L	CHEVROLET SILVERADO 2500 (MEX)
2005-2006		V8-5.3L	CHEVROLET SONORA (MEX)
2003-2004		V8-5.3L	CHEVROLET SSR
2004-2006		V8-5.3L	CHEVROLET SUBURBAN 1500
2006		V8-5.3L	CHEVROLET SUBURBAN 1500 (MEX)
2000-2006		V8-5.3L	CHEVROLET TAHOE
2006		V8-5.3L	CHEVROLET TRAILBLAZER
2005-2006		V8-5.3L	GMC ENVOY
2004-2006		V8-5.3L	GMC SAVANA 1500
2004-2005		V8-5.3L	GMC SAVANA 2500
2004-2006		V8-5.3L	GMC SIERRA 1500
2004-2006		V8-5.3L	GMC YUKON
2004-2006		V8-5.3L	GMC YUKON XL 1500
2005-2006		V8-5.3L	ISUZU ASCENDER
2005-2006		V8-5.3L	SAAB 9-7X
2007		V8-5.7L	CHEVROLET SILVERADO 3500 (MEX)
2004-2006		V8-6.0L	CADILLAC ESCALADE
2004-2006		V8-6.0L	CHEVROLET EXPRESS 2500
2004-2006		V8-6.0L	CHEVROLET EXPRESS 3500
2004-2006		V8-6.0L	CHEVROLET SILVERADO 1500
2002-2006		V8-6.0L	CHEVROLET SILVERADO 1500 HD
2002-2004		V8-6.0L	CHEVROLET SILVERADO 2500
2002-2006		V8-6.0L	CHEVROLET SILVERADO 2500 HD
2002-2006		V8-6.0L	CHEVROLET SILVERADO 3500
2005-2006		V8-6.0L	CHEVROLET SSR
2002-2006		V8-6.0L	CHEVROLET SUBURBAN 2500
2006		V8-6.0L	CHEVROLET TRAILBLAZER
2004-2006		V8-6.0L	GMC SAVANA 2500
2004-2006		V8-6.0L	GMC SAVANA 3500
2005-2006		V8-6.0L	GMC SIERRA 1500
2002-2006		V8-6.0L	GMC SIERRA 1500 HD
2002-2004		V8-6.0L	GMC SIERRA 2500
2002-2006		V8-6.0L	GMC SIERRA 2500 HD
2002-2006		V8-6.0L	GMC SIERRA 3500
2002-2006		V8-6.0L	GMC YUKON
2002-2006	V8-6.0L	GMC YUKON XL 1500	
2002-2006	V8-6.0L	GMC YUKON XL 2500	
2004-2006	V8-6.0L	HUMMER H2	
<b>US64-T</b>	2004-2006	V8-4.8L	CHEVROLET EXPRESS 2500
	2005-2006	V8-4.8L	CHEVROLET EXPRESS 3500
	1999-2006	V8-4.8L	CHEVROLET SILVERADO 1500
	2006-2009	V8-4.8L	CHEVROLET SILVERADO 2500 (MEX)
	2000-2006	V8-4.8L	CHEVROLET TAHOE
	2004-2006	V8-4.8L	GMC SAVANA 2500
	2004-2006	V8-4.8L	GMC SAVANA 3500

USMW	Years	Cyl.	Specifications
	1999-2006	V8-4.8L	GMC SIERRA 1500
	2000-2006	V8-4.8L	GMC YUKON
	2004-2006	V8-5.3L	BUICK RAINIER
	2004-2005	V8-5.3L	CADILLAC ESCALADE
	2004-2006	V8-5.3L	CHEVROLET AVALANCHE 1500
	2004-2006	V8-5.3L	CHEVROLET EXPRESS 1500
	2004-2005	V8-5.3L	CHEVROLET EXPRESS 2500
	2004-2006	V8-5.3L	CHEVROLET SILVERADO 1500
	2004-2009	V8-5.3L	CHEVROLET SILVERADO 2500 (MEX)
	2005-2006	V8-5.3L	CHEVROLET SONORA (MEX)
	2003-2004	V8-5.3L	CHEVROLET SSR
	2004-2006	V8-5.3L	CHEVROLET SUBURBAN 1500
	2006	V8-5.3L	CHEVROLET SUBURBAN 1500 (MEX)
	2000-2006	V8-5.3L	CHEVROLET TAHOE
	2006	V8-5.3L	CHEVROLET TRAILBLAZER
	2005-2006	V8-5.3L	GMC ENVOY
	2004-2006	V8-5.3L	GMC SAVANA 1500
	2004-2005	V8-5.3L	GMC SAVANA 2500
	2004-2006	V8-5.3L	GMC SIERRA 1500
	2004-2006	V8-5.3L	GMC YUKON
	2004-2006	V8-5.3L	GMC YUKON XL 1500
	2005-2006	V8-5.3L	ISUZU ASCENDER
	2005-2006	V8-5.3L	SAAB 9-7X
	2007	V8-5.7L	CHEVROLET SILVERADO 3500 (MEX)
	2004-2006	V8-6.0L	CADILLAC ESCALADE
	2004-2006	V8-6.0L	CHEVROLET EXPRESS 2500
	2004-2006	V8-6.0L	CHEVROLET EXPRESS 3500
	2004-2006	V8-6.0L	CHEVROLET SILVERADO 1500
	2002-2006	V8-6.0L	CHEVROLET SILVERADO 1500 HD
	2002-2004	V8-6.0L	CHEVROLET SILVERADO 2500
	2002-2006	V8-6.0L	CHEVROLET SILVERADO 2500 HD
	2002-2006	V8-6.0L	CHEVROLET SILVERADO 3500
	2005-2006	V8-6.0L	CHEVROLET SSR
	2002-2006	V8-6.0L	CHEVROLET SUBURBAN 2500
	2006	V8-6.0L	CHEVROLET TRAILBLAZER
	2004-2006	V8-6.0L	GMC SAVANA 2500
	2004-2006	V8-6.0L	GMC SAVANA 3500
	2005-2006	V8-6.0L	GMC SIERRA 1500
	2002-2006	V8-6.0L	GMC SIERRA 1500 HD
	2002-2004	V8-6.0L	GMC SIERRA 2500
	2002-2006	V8-6.0L	GMC SIERRA 2500 HD
	2002-2006	V8-6.0L	GMC SIERRA 3500
	2002-2006	V8-6.0L	GMC YUKON
	2002-2006	V8-6.0L	GMC YUKON XL 1500
	2002-2006	V8-6.0L	GMC YUKON XL 2500
	2004-2006	V8-6.0L	HUMMER H2
<b>US65</b>	2004-2005	V8-5.7L	CADILLAC CTS
	2005-2006	V8-6.0L	PONTIAC GTO
<b>US65-T</b>	2004-2005	V8-5.7L	CADILLAC CTS
<b>US65N</b>	2005-2007	V8-6.0L	CHEVROLET CORVETTE
	2008-2009	V8-6.0L	PONTIAC G8
<b>US65-T</b>	2005-2006	V8-6.0L	PONTIAC GTO
<b>US65N</b>	2008	V8-6.2L	CHEVROLET CORVETTE
	2006-2008	V8-7.0L	CHEVROLET CORVETTE
<b>US65N-T</b>	2005-2007	V8-6.0L	CHEVROLET CORVETTE
	2008-2009	V8-6.0L	PONTIAC G8
	2008	V8-6.2L	CHEVROLET CORVETTE
	2006-2008	V8-7.0L	CHEVROLET CORVETTE
<b>US67</b>	2004-2005	V8-6.0L	FORD E-350 CLUB WAGON
	2004-2010	V8-6.0L	FORD E-350 SUPER DUTY
	2004-2008	V8-6.0L	FORD E-450 SUPER DUTY
	2004-2007	V8-6.0L	FORD F-250 SUPER DUTY
	2004-2007	V8-6.0L	FORD F-350 SUPER DUTY
	2004-2007	V8-6.0L	FORD F-450 SUPER DUTY
	2004-2007	V8-6.0L	FORD F-550 SUPER DUTY
<b>US72</b>	2006-2011	V8-6.6L	CHEVROLET EXPRESS 2500
	2006-2011	V8-6.6L	CHEVROLET EXPRESS 3500
	2009-2011	V8-6.6L	CHEVROLET EXPRESS 4500
	2006-2011	V8-6.6L	CHEVROLET SILVERADO 2500 HD

WATER PUMPS

USMW	Years	Cyl.	Specifications
	2006-2007	V8-6.6L	CHEVROLET SILVERADO 3500
	2007-2011	V8-6.6L	CHEVROLET SILVERADO 3500 HD
	2006-2011	V8-6.6L	GMC SAVANA 2500
	2006-2011	V8-6.6L	GMC SAVANA 3500
	2006-2011	V8-6.6L	GMC SIERRA 2500 HD
	2006-2007	V8-6.6L	GMC SIERRA 3500
	2007-2011	V8-6.6L	GMC SIERRA 3500 HD
<b>US76</b>	2008-2010	V8-6.4L	FORD F-250 SUPER DUTY
	2008-2010	V8-6.4L	FORD F-350 SUPER DUTY
	2008-2010	V8-6.4L	FORD F-450 SUPER DUTY
	2008-2010	V8-6.4L	FORD F-550 SUPER DUTY
<b>US77</b>	2011-2012	V8-6.7L	FORD F-250 SUPER DUTY
	2011-2012	V8-6.7L	FORD F-350 SUPER DUTY
	2011	V8-6.7L	FORD F-450 SUPER DUTY
	2011	V8-6.7L	FORD F-550 SUPER DUTY
<b>US79</b>	2011	V8-6.0L	CHEVROLET CAPRICE
	2009-2011	V8-6.2L	CADILLAC CTS
	2009-2011	V8-6.2L	CHEVROLET CORVETTE
	2009	V8-6.2L	PONTIAC G8
	2009-2011	V8-7.0L	CHEVROLET CORVETTE
<b>US488</b>	1959-1960	V8-4.5l	EDSEL RANGER
<b>US669</b>	1964	L6-4.8L	CHEVROLET CS31003 (MEX)
<b>US723</b>	1962-1964	V8-5.8L	FORD CLUB WAGON
	1961-1964	V8-5.8L	FORD COUNTRY SEDAN
	1961-1964	V8-5.8L	FORD COUNTRY SQUIRE
	1964	V8-5.8L	FORD CUSTOM 500
	1961-1964	V8-5.8L	FORD FAIRLANE
	1963	V8-5.8L	FORD FORD 300
	1961-1964	V8-5.8L	FORD GALAXIE
	1962-1964	V8-5.8L	FORD GALAXIE 500
	1961-1964	V8-5.8L	FORD RANCH WAGON
	1962-1964	V8-5.8L	FORD SUNLINER
	1962-1964	V8-5.8L	FORD VICTORIA
	1961-1962	V8-5.8L	MERCURY COLONY PARK
	1961-1962	V8-5.8L	MERCURY COMMUTER
	1961-1962	V8-5.8L	MERCURY METEOR
	1961-1962	V8-5.8L	MERCURY MONTEREY
	1962-1964	V8-6.4L	FORD CLUB WAGON
	1961-1964	V8-6.4L	FORD COUNTRY SEDAN
	1961-1964	V8-6.4L	FORD COUNTRY SQUIRE
	1964	V8-6.4L	FORD CUSTOM 500
	1961-1964	V8-6.4L	FORD FAIRLANE
	1963	V8-6.4L	FORD FORD 300
	1961-1964	V8-6.4L	FORD GALAXIE
	1962-1964	V8-6.4L	FORD GALAXIE 500
	1961-1964	V8-6.4L	FORD RANCH WAGON
	1962-1964	V8-6.4L	FORD SUNLINER
	1961-1964	V8-6.4L	FORD THUNDERBIRD
	1962-1964	V8-6.4L	FORD VICTORIA
	1961-1964	V8-6.4L	MERCURY COLONY PARK
	1961-1964	V8-6.4L	MERCURY COMMUTER
	1963	V8-6.4L	MERCURY COUNTRY CRUISER
	1963-1964	V8-6.4L	MERCURY MARAUDER
	1961-1963	V8-6.4L	MERCURY METEOR
	1964	V8-6.4L	MERCURY MONTCLAIR
	1961-1964	V8-6.4L	MERCURY MONTEREY
	1964	V8-6.4L	MERCURY PARK LANE
	1962-1963	V8-6.6L	FORD CLUB WAGON
	1962-1963	V8-6.6L	FORD COUNTRY SEDAN
	1962-1963	V8-6.6L	FORD COUNTRY SQUIRE
	1963	V8-6.6L	FORD FORD 300
	1962-1963	V8-6.6L	FORD GALAXIE
	1962-1963	V8-6.6L	FORD RANCH WAGON
	1962-1963	V8-6.6L	FORD SUNLINER
	1962-1963	V8-6.6L	FORD THUNDERBIRD
	1962-1963	V8-6.6L	FORD VICTORIA
	1962-1963	V8-6.6L	MERCURY COLONY PARK
	1962-1963	V8-6.6L	MERCURY COMMUTER
	1963	V8-6.6L	MERCURY MARAUDER

USMW	Years	Cyl.	Specifications
	1962-1963	V8-6.6L	MERCURY MONTEREY
	1963-1964	V8-7.0L	FORD CLUB WAGON
	1963-1964	V8-7.0L	FORD COUNTRY SEDAN
	1963-1964	V8-7.0L	FORD COUNTRY SQUIRE
	1964	V8-7.0L	FORD FAIRLANE
	1963	V8-7.0L	FORD FORD 300
	1963-1964	V8-7.0L	FORD GALAXIE
	1964	V8-7.0L	FORD GT40
	1963-1964	V8-7.0L	FORD RANCH WAGON
	1963-1964	V8-7.0L	FORD SUNLINER
	1963-1964	V8-7.0L	FORD THUNDERBIRD
	1963-1964	V8-7.0L	FORD VICTORIA
	1963-1964	V8-7.0L	MERCURY COLONY PARK
	1963-1964	V8-7.0L	MERCURY COMMUTER
	1963-1964	V8-7.0L	MERCURY MARAUDER
	1964	V8-7.0L	MERCURY MONTCLAIR
	1963-1964	V8-7.0L	MERCURY MONTEREY
	1964	V8-7.0L	MERCURY PARK LANE
<b>US819</b>	1962	L6-3.6L	FORD CLUB WAGON
	1962	L6-3.6L	FORD FAIRLANE
	1963	V8-3.6L	FORD CLUB WAGON
	1962-1963	V8-3.6L	FORD COUNTRY SEDAN
	1962-1963	V8-3.6L	FORD COUNTRY SQUIRE
	1962-1963	V8-3.6L	FORD FAIRLANE
	1962-1963	V8-3.6L	FORD FALCON
	1962-1965	V8-4.3L	FORD CLUB WAGON
	1962-1965	V8-4.3L	FORD COUNTRY SEDAN
	1962-1965	V8-4.3L	FORD COUNTRY SQUIRE
	1964	V8-4.3L	FORD CUSTOM 500
	1962-1964	V8-4.3L	FORD FAIRLANE
	1962-1965	V8-4.3L	FORD FALCON
	1962	V8-4.3L	FORD FALCON SEDAN DELIVERY
	1963	V8-4.3L	FORD FORD 300
	1963-1964	V8-4.3L	FORD GALAXIE
	1963-1964	V8-4.3L	FORD GALAXIE 500
	1964-1965	V8-4.3L	FORD MUSTANG
	1963-1965	V8-4.7L	FORD CLUB WAGON
	1963-1967	V8-4.7L	FORD COUNTRY SEDAN
	1963-1965	V8-4.7L	FORD COUNTRY SQUIRE
	1965	V8-4.7L	FORD CUSTOM
	1964-1968	V8-4.7L	FORD CUSTOM 500
	1965	V8-4.7L	FORD F-100
	1966	V8-4.7L	FORD F-101
	1965	V8-4.7L	FORD F-102
	1966	V8-4.7L	FORD F-103
	1965	V8-4.7L	FORD F-350
	1966	V8-4.7L	FORD F-352
	1963-1967	V8-4.7L	FORD FAIRLANE
	1964-1966	V8-4.7L	FORD FALCON
	1965	V8-4.7L	FORD FALCON SEDAN DELIVERY
	1963	V8-4.7L	FORD FORD 300
	1963-1965	V8-4.7L	FORD GALAXIE
	1963-1967	V8-4.7L	FORD GALAXIE 500
	1966-1968	V8-4.7L	FORD GT40
	1965-1967	V8-4.7L	FORD LTD
	1964-1968	V8-4.7L	FORD MUSTANG
	1965	V8-5.0L	FORD F-351
	1966	V8-5.0L	FORD F-353
<b>US843</b>	1969-1970	L6-3.3L	AMERICAN MOTORS AMERICAN (MEX)
	1966-1970	L6-3.3L	AMERICAN MOTORS CLASSIC (MEX)
	1969-1973	L6-3.8L	AMERICAN MOTORS AMERICAN (MEX)
	1967-1973	L6-3.8L	AMERICAN MOTORS CLASSIC (MEX)
	1972	L6-4.2L	AMERICAN MOTORS CLASSIC (MEX)
	1972	L6-4.6L	AMERICAN MOTORS CLASSIC (MEX)
<b>US850</b>	1968	V8-5.7L	PONTIAC ACADIAN
	1968	V8-5.7L	PONTIAC EXECUTIVE
	1968	V8-5.7L	PONTIAC FIREBIRD
	1968	V8-5.7L	PONTIAC LEMANS
	1968	V8-5.7L	PONTIAC SAFARI

USMW	Years	Cyl.	Specifications
	1968	V8-5.7L	PONTIAC TEMPEST
	1959-1966	V8-6.4L	PONTIAC BONNEVILLE
	1959-1966	V8-6.4L	PONTIAC CATALINA
	1962-1966	V8-6.4L	PONTIAC GRAND PRIX
	1964-1966	V8-6.4L	PONTIAC GTO
	1963-1966	V8-6.4L	PONTIAC LEMANS
	1959-1966	V8-6.4L	PONTIAC SAFARI
	1959-1966	V8-6.4L	PONTIAC STAR CHIEF
	1961-1966	V8-6.4L	PONTIAC TEMPEST
	1960-1961	V8-6.4L	PONTIAC VENTURA
	1967-1968	V8-6.6L	PONTIAC BONNEVILLE
	1967-1968	V8-6.6L	PONTIAC CATALINA
	1967-1968	V8-6.6L	PONTIAC EXECUTIVE
	1967-1968	V8-6.6L	PONTIAC FIREBIRD
	1967-1968	V8-6.6L	PONTIAC GRAND PRIX
	1967-1968	V8-6.6L	PONTIAC GTO
	1967-1968	V8-6.6L	PONTIAC LEMANS
	1967-1968	V8-6.6L	PONTIAC SAFARI
	1967-1968	V8-6.6L	PONTIAC TEMPEST
	1963-1966	V8-6.9L	PONTIAC BONNEVILLE
	1961-1966	V8-6.9L	PONTIAC CATALINA
	1963-1966	V8-6.9L	PONTIAC GRAND PRIX
	1964-1965	V8-6.9L	PONTIAC GTO
	1963-1966	V8-6.9L	PONTIAC SAFARI
	1963-1966	V8-6.9L	PONTIAC STAR CHIEF
	1961	V8-6.9L	PONTIAC VENTURA
	1967-1968	V8-7.0L	PONTIAC BONNEVILLE
	1967-1968	V8-7.0L	PONTIAC CATALINA
	1967-1968	V8-7.0L	PONTIAC EXECUTIVE
	1967-1968	V8-7.0L	PONTIAC GRAND PRIX
	1967-1968	V8-7.0L	PONTIAC LEMANS
	1967-1968	V8-7.0L	PONTIAC SAFARI
	1967-1968	V8-7.0L	PONTIAC TEMPEST
<b>US851</b>	1968-1973	V8-7.7L	CADILLAC CALAIS
	1968-1973	V8-7.7L	CADILLAC COMMERCIAL CHASSIS
	1968-1973	V8-7.7L	CADILLAC DEVILLE
	1968-1969	V8-7.7L	CADILLAC ELDORADO
	1968-1973	V8-7.7L	CADILLAC FLEETWOOD
	1970-1973	V8-8.2L	CADILLAC CALAIS
	1970-1973	V8-8.2L	CADILLAC COMMERCIAL CHASSIS
	1970-1973	V8-8.2L	CADILLAC DEVILLE
	1970-1973	V8-8.2L	CADILLAC ELDORADO
	1970-1973	V8-8.2L	CADILLAC FLEETWOOD
<b>US855</b>	1966	L6-3.7L	JEEP FC150
	1964-1967	V6-3.7L	BUICK SKYLARK
	1964-1967	V6-3.7L	BUICK SPECIAL
	1964-1967	V6-3.7L	BUICK SPORTWAGON
	1966	V6-3.7L	JEEP CJ3
	1966-1971	V6-3.7L	JEEP CJ5
	1966-1968	V6-3.7L	JEEP CJ5A
	1966-1971	V6-3.7L	JEEP CJ6
	1966-1968	V6-3.7L	JEEP CJ6A
	1966-1971	V6-3.7L	JEEP COMMANDO
	1966-1969	V6-3.7L	JEEP DISPATCHER
	1966-1971	V6-3.7L	JEEP DJ5
	1966-1968	V6-3.7L	JEEP DJ6
	1966	V6-3.7L	JEEP FC150
	1966	V6-3.7L	JEEP FC170HD
	1964	V8-4.9L	BUICK ESTATE WAGON
	1965	V8-4.9L	BUICK GRAN SPORT
	1964-1965	V8-4.9L	BUICK LESABRE
	1964-1967	V8-4.9L	BUICK SKYLARK
	1964-1967	V8-4.9L	BUICK SPECIAL
	1964-1965	V8-4.9L	BUICK SPORTWAGON
	1970	V8-5.7L	BUICK ESTATE WAGON
	1970	V8-5.7L	BUICK GS
	1968-1969	V8-5.7L	BUICK GS 350
	1968-1970	V8-5.7L	BUICK LESABRE
	1968-1970	V8-5.7L	BUICK SKYLARK

USMW	Years	Cyl.	Specifications
	1968-1969	V8-5.7L	BUICK SPECIAL
	1968-1970	V8-5.7L	BUICK SPORTWAGON
	1968-1971	V8-5.7L	JEEP J-100
	1969-1971	V8-5.7L	JEEP J-2500
	1969-1971	V8-5.7L	JEEP J-2600
	1969-1970	V8-5.7L	JEEP J-2700
<b>US895</b>	1970	L6-3.8L	CHEVROLET CHEVELLE (MEX)
	1994-1997	L6-4.1L	CHEVROLET C1500 (MEX)
	1964-1966	L6-4.1L	CHEVROLET CHEVELLE (MEX)
	1966-1974	L6-4.1L	CHEVROLET CS1073 (MEX)
	1965	L6-4.1L	CHEVROLET IMPALA (MEX)
	1965	L6-4.1L	CHEVROLET MALIBU (MEX)
	1994-1997	L6-4.1L	GMC C1500 (MEX)
	1975	L6-4.1L	GMC SPRINT
	1965-1972	L6-4.8L	CHEVROLET IMPALA (MEX)
<b>US896</b>	1969-1974	L6-4.8L	CHEVROLET BLAZER
	1982-1986	L6-4.8L	CHEVROLET C10 (MEX)
	1965-1974	L6-4.8L	CHEVROLET C10 PICKUP
	1965-1974	L6-4.8L	CHEVROLET C10 SUBURBAN
	1966	L6-4.8L	CHEVROLET C1405 (MEX)
	1965-1974	L6-4.8L	CHEVROLET C20 SUBURBAN
	1965-1967	L6-4.8L	CHEVROLET C20905 (MEX)
	1965-1974	L6-4.8L	CHEVROLET C30 PICKUP
	1967	L6-4.8L	CHEVROLET C3605 (MEX)
	1967-1973	L6-4.8L	CHEVROLET CHEVELLE (MEX)
	1964-1974	L6-4.8L	CHEVROLET CS1073 (MEX)
	1965-1974	L6-4.8L	CHEVROLET CS31003 (MEX)
	1971-1974	L6-4.8L	CHEVROLET G20 VAN
	1971-1974	L6-4.8L	CHEVROLET G30 VAN
	1965-1974	L6-4.8L	CHEVROLET K10 PICKUP
	1965-1970	L6-4.8L	CHEVROLET K10 SUBURBAN
	1965-1974	L6-4.8L	CHEVROLET K20 PICKUP
	1965-1974	L6-4.8L	CHEVROLET K20 SUBURBAN
	1968-1974	L6-4.8L	CHEVROLET K30 PICKUP
	1967	L6-4.8L	CHEVROLET P10 SERIES
	1965-1967	L6-4.8L	CHEVROLET P20 SERIES
	1968-1974	L6-4.8L	CHEVROLET P20 VAN
	1965-1967	L6-4.8L	CHEVROLET P30 SERIES
	1968-1974	L6-4.8L	CHEVROLET P30 VAN
	1965-1967	L6-4.8L	CHEVROLET SUBURBAN
	1970-1974	L6-4.8L	GMC JIMMY
	1967-1974	L6-4.8L	GMC K15/K1500 PICKUP
	1967-1971	L6-4.8L	GMC K15/K1500 SUBURBAN
	1967-1974	L6-4.8L	GMC K25/K2500 PICKUP
	1968-1974	L6-4.8L	GMC K25/K2500 SUBURBAN
	1967-1974	L6-4.8L	GMC K35/K3500 PICKUP
	1967	L6-4.8L	GMC P15/P1500 VAN
	1967-1974	L6-4.8L	GMC P25/P2500 VAN
	1967-1974	L6-4.8L	GMC P35/P3500 VAN
	1966	L6-4.8L	GMC PB15 SERIES
	1965	L6-4.8L	GMC PB1500 SERIES
	1966	L6-4.8L	GMC PB25 SERIES
	1965	L6-4.8L	GMC PB2500 SERIES
	1965-1967	L6-4.8L	GMC SUBURBAN
	1965	V6-4.8L	CHEVROLET C1405 (MEX)
<b>US898</b>	1959-1960	L6-4.3L	CHEVROLET BEL AIR
	1961-1962	L6-4.3L	CHEVROLET C10 PICKUP
	1961-1962	L6-4.3L	CHEVROLET C10 SUBURBAN
	1961-1962	L6-4.3L	CHEVROLET C20 PICKUP
	1961-1962	L6-4.3L	CHEVROLET C20 SUBURBAN
	1961-1962	L6-4.3L	CHEVROLET C30 PICKUP
	1961-1962	L6-4.3L	CHEVROLET K10 PICKUP
	1961-1962	L6-4.3L	CHEVROLET K10 SUBURBAN
	1961-1962	L6-4.3L	CHEVROLET K20 PICKUP
	1961-1962	L6-4.3L	CHEVROLET K20 SUBURBAN
	1961-1962	L6-4.3L	CHEVROLET P10 SERIES
	1961-1962	L6-4.3L	CHEVROLET P30 SERIES
	1961-1962	L6-4.3L	CHEVROLET SUBURBAN
	1955-1960	L6-4.3L	CHEVROLET TRUCK

**WATER PUMPS**



USMW	Years	Cyl.	Specifications
1955-1957	V8-4.3L	CHEVROLET BEL AIR	
1955-1956	V8-4.3L	CHEVROLET CORVETTE	
1957	V8-4.3L	CHEVROLET DEL RAY	
1955-1957	V8-4.3L	CHEVROLET ONE-FIFTY SERIES	
1955-1957	V8-4.3L	CHEVROLET TRUCK	
1955-1957	V8-4.3L	CHEVROLET TWO-TEN SERIES	
1965-1967	V8-4.6L	CHECKER MARATHON	
1957-1967	V8-4.6L	CHEVROLET BEL AIR	
1958-1967	V8-4.6L	CHEVROLET BISCAYNE	
1958-1961	V8-4.6L	CHEVROLET BROOKWOOD	
1960-1967	V8-4.6L	CHEVROLET C10 PICKUP	
1960-1967	V8-4.6L	CHEVROLET C10 SUBURBAN	
1960-1967	V8-4.6L	CHEVROLET C20 PICKUP	
1960-1967	V8-4.6L	CHEVROLET C20 SUBURBAN	
1960-1967	V8-4.6L	CHEVROLET C30 PICKUP	
1967	V8-4.6L	CHEVROLET CAMARO	
1966-1967	V8-4.6L	CHEVROLET CAPRICE	
1964-1967	V8-4.6L	CHEVROLET CHEVELLE	
1963-1967	V8-4.6L	CHEVROLET CHEVY II	
1957-1961	V8-4.6L	CHEVROLET CORVETTE	
1957-1958	V8-4.6L	CHEVROLET DEL RAY	
1959-1967	V8-4.6L	CHEVROLET EL CAMINO	
1967	V8-4.6L	CHEVROLET G20 VAN	
1958-1967	V8-4.6L	CHEVROLET IMPALA	
1960-1967	V8-4.6L	CHEVROLET K10 PICKUP	
1960-1967	V8-4.6L	CHEVROLET K10 SUBURBAN	
1967	V8-4.6L	CHEVROLET K20 PANEL	
1960-1967	V8-4.6L	CHEVROLET K20 PICKUP	
1960-1967	V8-4.6L	CHEVROLET K20 SUBURBAN	
1959-1961	V8-4.6L	CHEVROLET KINGSWOOD	
1964-1967	V8-4.6L	CHEVROLET MALIBU	
1957	V8-4.6L	CHEVROLET ONE-FIFTY SERIES	
1961-1962	V8-4.6L	CHEVROLET P10 SERIES	
1961-1962	V8-4.6L	CHEVROLET P30 SERIES	
1960-1967	V8-4.6L	CHEVROLET SUBURBAN	
1957-1960	V8-4.6L	CHEVROLET TRUCK	
1957	V8-4.6L	CHEVROLET TWO-TEN SERIES	
1965-1966	V8-4.7L	CHEVROLET C1405 (MEX)	
1965-1967	V8-4.7L	CHEVROLET C20905 (MEX)	
1967	V8-4.7L	CHEVROLET C3605 (MEX)	
1964-1967	V8-4.7L	CHEVROLET CS1073 (MEX)	
1964-1967	V8-4.7L	CHEVROLET CS31003 (MEX)	
1969	V8-5.0L	CHECKER DELUXE	
1968-1969	V8-5.0L	CHECKER MARATHON	
1968	V8-5.0L	CHEVROLET BEL AIR	
1968	V8-5.0L	CHEVROLET BISCAYNE	
1969-1972	V8-5.0L	CHEVROLET BLAZER	
1969-1972	V8-5.0L	CHEVROLET BROOKWOOD	
1968-1972	V8-5.0L	CHEVROLET C10 PICKUP	
1968-1972	V8-5.0L	CHEVROLET C10 SUBURBAN	
1968-1972	V8-5.0L	CHEVROLET C20 PICKUP	
1968-1972	V8-5.0L	CHEVROLET C20 SUBURBAN	
1968-1972	V8-5.0L	CHEVROLET C30 PICKUP	
1968-1972	V8-5.0L	CHEVROLET CAMARO	
1968-1972	V8-5.0L	CHEVROLET CAPRICE	
1968-1972	V8-5.0L	CHEVROLET CHEVELLE	
1968	V8-5.0L	CHEVROLET CHEVY II	
1968-1972	V8-5.0L	CHEVROLET EL CAMINO	
1968-1972	V8-5.0L	CHEVROLET G10 VAN	
1968-1972	V8-5.0L	CHEVROLET G20 VAN	
1968-1972	V8-5.0L	CHEVROLET IMPALA	
1968-1972	V8-5.0L	CHEVROLET K10 PICKUP	
1968-1972	V8-5.0L	CHEVROLET K10 SUBURBAN	
1968-1972	V8-5.0L	CHEVROLET K20 PICKUP	
1968-1972	V8-5.0L	CHEVROLET K20 SUBURBAN	
1968-1972	V8-5.0L	CHEVROLET K30 PICKUP	
1969-1972	V8-5.0L	CHEVROLET KINGSWOOD	
1968-1969	V8-5.0L	CHEVROLET P20 VAN	
1968-1969	V8-5.0L	CHEVROLET P30 VAN	

USMW	Years	Cyl.	Specifications
1965-1969	V8-5.3L	AVANTI II	
1969	V8-5.3L	CHECKER DELUXE	
1965-1969	V8-5.3L	CHECKER MARATHON	
1959-1969	V8-5.3L	CHEVROLET BEL AIR	
1962-1969	V8-5.3L	CHEVROLET BISCAYNE	
1969	V8-5.3L	CHEVROLET BROOKWOOD	
1966-1969	V8-5.3L	CHEVROLET C10 PICKUP	
1966-1969	V8-5.3L	CHEVROLET C10 SUBURBAN	
1966-1969	V8-5.3L	CHEVROLET C20 PICKUP	
1966-1969	V8-5.3L	CHEVROLET C20 SUBURBAN	
1966-1969	V8-5.3L	CHEVROLET C30 PICKUP	
1967-1969	V8-5.3L	CHEVROLET CAMARO	
1966-1969	V8-5.3L	CHEVROLET CAPRICE	
1964-1968	V8-5.3L	CHEVROLET CHEVELLE	
1965-1968	V8-5.3L	CHEVROLET CHEVY II	
1962-1968	V8-5.3L	CHEVROLET CORVETTE	
1966-1969	V8-5.3L	CHEVROLET EL CAMINO	
1962-1969	V8-5.3L	CHEVROLET IMPALA	
1966-1969	V8-5.3L	CHEVROLET K10 PICKUP	
1966-1969	V8-5.3L	CHEVROLET K10 SUBURBAN	
1966-1969	V8-5.3L	CHEVROLET K20 PICKUP	
1966-1969	V8-5.3L	CHEVROLET K20 SUBURBAN	
1968-1969	V8-5.3L	CHEVROLET K30 PICKUP	
1969	V8-5.3L	CHEVROLET KINGSWOOD	
1964-1967	V8-5.3L	CHEVROLET MALIBU	
1966-1967	V8-5.3L	CHEVROLET SUBURBAN	
1955-1958	V8-5.3L	CHEVROLET TRUCK	
1968-1969	V8-5.4L	AVANTI II	
1968-1969	V8-5.4L	CHEVROLET BEL AIR	
1968-1969	V8-5.4L	CHEVROLET BISCAYNE	
1968	V8-5.4L	CHEVROLET C10 PICKUP	
1968	V8-5.4L	CHEVROLET C10 SUBURBAN	
1968	V8-5.4L	CHEVROLET C20 PICKUP	
1968	V8-5.4L	CHEVROLET C20 SUBURBAN	
1968	V8-5.4L	CHEVROLET C30 PICKUP	
1968-1969	V8-5.4L	CHEVROLET CAMARO	
1968-1969	V8-5.4L	CHEVROLET CAPRICE	
1965-1968	V8-5.4L	CHEVROLET CHEVELLE	
1965-1968	V8-5.4L	CHEVROLET CHEVY II	
1968	V8-5.4L	CHEVROLET CORVETTE	
1964-1969	V8-5.4L	CHEVROLET CS1073 (MEX)	
1964-1969	V8-5.4L	CHEVROLET CS31003 (MEX)	
1968	V8-5.4L	CHEVROLET EL CAMINO	
1964-1969	V8-5.4L	CHEVROLET IMPALA	
1968	V8-5.4L	CHEVROLET K10 PICKUP	
1968	V8-5.4L	CHEVROLET K10 SUBURBAN	
1967	V8-5.4L	CHEVROLET K20 PANEL	
1968	V8-5.4L	CHEVROLET K20 PICKUP	
1968	V8-5.4L	CHEVROLET K20 SUBURBAN	
1968	V8-5.4L	CHEVROLET K30 PICKUP	
1969	V8-5.7L	AVANTI II	
1958-1972	V8-5.7L	CHEVROLET BEL AIR	
1958-1972	V8-5.7L	CHEVROLET BISCAYNE	
1969-1972	V8-5.7L	CHEVROLET BLAZER	
1958-1972	V8-5.7L	CHEVROLET BROOKWOOD	
1960-1972	V8-5.7L	CHEVROLET C10 PICKUP	
1960-1972	V8-5.7L	CHEVROLET C10 SUBURBAN	
1960-1972	V8-5.7L	CHEVROLET C20 PICKUP	
1960-1972	V8-5.7L	CHEVROLET C20 SUBURBAN	
1960-1972	V8-5.7L	CHEVROLET C30 PICKUP	
1967-1972	V8-5.7L	CHEVROLET CAMARO	
1969-1972	V8-5.7L	CHEVROLET CAPRICE	
1968-1972	V8-5.7L	CHEVROLET CHEVELLE	
1968	V8-5.7L	CHEVROLET CHEVY II	
1969-1972	V8-5.7L	CHEVROLET CORVETTE	
1968-1974	V8-5.7L	CHEVROLET CS31003 (MEX)	
1958	V8-5.7L	CHEVROLET DEL RAY	
1959-1972	V8-5.7L	CHEVROLET EL CAMINO	
1970-1972	V8-5.7L	CHEVROLET G10 VAN	

USMW	Years	Cyl.	Specifications
	1970-1972	V8-5.7L	CHEVROLET G20 VAN
	1970-1972	V8-5.7L	CHEVROLET G30 VAN
	1958-1972	V8-5.7L	CHEVROLET IMPALA
	1960-1972	V8-5.7L	CHEVROLET K10 PICKUP
	1960-1972	V8-5.7L	CHEVROLET K10 SUBURBAN
	1960-1972	V8-5.7L	CHEVROLET K20 PICKUP
	1960-1972	V8-5.7L	CHEVROLET K20 SUBURBAN
	1969-1972	V8-5.7L	CHEVROLET K30 PICKUP
	1959-1972	V8-5.7L	CHEVROLET KINGSWOOD
	1970-1972	V8-5.7L	CHEVROLET P20 VAN
	1960-1965	V8-5.7L	CHEVROLET P30 SERIES
	1970-1972	V8-5.7L	CHEVROLET P30 VAN
	1960-1965	V8-5.7L	CHEVROLET SUBURBAN
	1958-1960	V8-5.7L	CHEVROLET TRUCK
<b>US898H</b>	1959-1960	L6-4.3L	CHEVROLET BEL AIR
	1961-1962	L6-4.3L	CHEVROLET C10 PICKUP
	1961-1962	L6-4.3L	CHEVROLET C10 SUBURBAN
	1961-1962	L6-4.3L	CHEVROLET C20 PICKUP
	1961-1962	L6-4.3L	CHEVROLET C20 SUBURBAN
	1961-1962	L6-4.3L	CHEVROLET C30 PICKUP
	1961-1962	L6-4.3L	CHEVROLET K10 PICKUP
	1961-1962	L6-4.3L	CHEVROLET K10 SUBURBAN
	1961-1962	L6-4.3L	CHEVROLET K20 PICKUP
	1961-1962	L6-4.3L	CHEVROLET K20 SUBURBAN
	1961-1962	L6-4.3L	CHEVROLET P10 SERIES
	1961-1962	L6-4.3L	CHEVROLET P30 SERIES
	1961-1962	L6-4.3L	CHEVROLET SUBURBAN
	1955-1960	L6-4.3L	CHEVROLET TRUCK
	1955-1957	V8-4.3L	CHEVROLET BEL AIR
	1955-1956	V8-4.3L	CHEVROLET CORVETTE
	1957	V8-4.3L	CHEVROLET DEL RAY
	1955-1957	V8-4.3L	CHEVROLET ONE-FIFTY SERIES
	1955-1957	V8-4.3L	CHEVROLET TRUCK
	1955-1957	V8-4.3L	CHEVROLET TWO-TEN SERIES
	1965-1967	V8-4.6L	CHEVROLET MARATHON
	1957-1967	V8-4.6L	CHEVROLET BEL AIR
	1958-1967	V8-4.6L	CHEVROLET BISCAYNE
	1958-1961	V8-4.6L	CHEVROLET BROOKWOOD
	1960-1967	V8-4.6L	CHEVROLET C10 PICKUP
	1960-1967	V8-4.6L	CHEVROLET C10 SUBURBAN
	1960-1967	V8-4.6L	CHEVROLET C20 PICKUP
	1960-1967	V8-4.6L	CHEVROLET C20 SUBURBAN
	1960-1967	V8-4.6L	CHEVROLET C30 PICKUP
	1967	V8-4.6L	CHEVROLET CAMARO
	1966-1967	V8-4.6L	CHEVROLET CAPRICE
	1964-1967	V8-4.6L	CHEVROLET CHEVELLE
	1963-1967	V8-4.6L	CHEVROLET CHEVY II
	1957-1961	V8-4.6L	CHEVROLET CORVETTE
	1957-1958	V8-4.6L	CHEVROLET DEL RAY
	1959-1967	V8-4.6L	CHEVROLET EL CAMINO
	1967	V8-4.6L	CHEVROLET G20 VAN
	1958-1967	V8-4.6L	CHEVROLET IMPALA
	1960-1967	V8-4.6L	CHEVROLET K10 PICKUP
	1960-1967	V8-4.6L	CHEVROLET K10 SUBURBAN
	1967	V8-4.6L	CHEVROLET K20 PANEL
	1960-1967	V8-4.6L	CHEVROLET K20 PICKUP
	1960-1967	V8-4.6L	CHEVROLET K20 SUBURBAN
	1959-1961	V8-4.6L	CHEVROLET KINGSWOOD
	1964-1967	V8-4.6L	CHEVROLET MALIBU
	1957	V8-4.6L	CHEVROLET ONE-FIFTY SERIES
	1961-1962	V8-4.6L	CHEVROLET P10 SERIES
	1961-1962	V8-4.6L	CHEVROLET P30 SERIES
	1960-1967	V8-4.6L	CHEVROLET SUBURBAN
	1957-1960	V8-4.6L	CHEVROLET TRUCK
	1957	V8-4.6L	CHEVROLET TWO-TEN SERIES
	1965-1966	V8-4.7L	CHEVROLET C1405 (MEX)
	1965-1967	V8-4.7L	CHEVROLET C20905 (MEX)
	1967	V8-4.7L	CHEVROLET C3605 (MEX)
	1964-1967	V8-4.7L	CHEVROLET CS1073 (MEX)

USMW	Years	Cyl.	Specifications
	1965-1967	V8-4.7L	CHEVROLET CS31003 (MEX)
	1969	V8-5.0L	CHEVROLET DELUXE
	1968-1969	V8-5.0L	CHEVROLET MARATHON
	1968	V8-5.0L	CHEVROLET BEL AIR
	1968	V8-5.0L	CHEVROLET BISCAYNE
	1969-1972	V8-5.0L	CHEVROLET BLAZER
	1969-1972	V8-5.0L	CHEVROLET BROOKWOOD
	1968-1972	V8-5.0L	CHEVROLET C10 PICKUP
	1968-1972	V8-5.0L	CHEVROLET C10 SUBURBAN
	1968-1972	V8-5.0L	CHEVROLET C20 PICKUP
	1968-1972	V8-5.0L	CHEVROLET C20 SUBURBAN
	1968-1972	V8-5.0L	CHEVROLET C30 PICKUP
	1968-1972	V8-5.0L	CHEVROLET CAMARO
	1968-1972	V8-5.0L	CHEVROLET CAPRICE
	1968-1972	V8-5.0L	CHEVROLET CHEVELLE
	1968	V8-5.0L	CHEVROLET CHEVY II
	1968-1972	V8-5.0L	CHEVROLET EL CAMINO
	1968-1972	V8-5.0L	CHEVROLET G10 VAN
	1968-1972	V8-5.0L	CHEVROLET G20 VAN
	1968-1972	V8-5.0L	CHEVROLET IMPALA
	1968-1972	V8-5.0L	CHEVROLET K10 PICKUP
	1968-1972	V8-5.0L	CHEVROLET K10 SUBURBAN
	1968-1972	V8-5.0L	CHEVROLET K20 PICKUP
	1968-1972	V8-5.0L	CHEVROLET K20 SUBURBAN
	1968-1972	V8-5.0L	CHEVROLET K30 PICKUP
	1969-1972	V8-5.0L	CHEVROLET KINGSWOOD
	1968-1969	V8-5.0L	CHEVROLET P20 VAN
	1968-1969	V8-5.0L	CHEVROLET P30 VAN
	1965-1969	V8-5.3L	AVANTI II
	1969	V8-5.3L	CHEVROLET DELUXE
	1965-1969	V8-5.3L	CHEVROLET MARATHON
	1959-1969	V8-5.3L	CHEVROLET BEL AIR
	1962-1969	V8-5.3L	CHEVROLET BISCAYNE
	1969	V8-5.3L	CHEVROLET BROOKWOOD
	1966-1969	V8-5.3L	CHEVROLET C10 PICKUP
	1966-1969	V8-5.3L	CHEVROLET C10 SUBURBAN
	1966-1969	V8-5.3L	CHEVROLET C20 PICKUP
	1966-1969	V8-5.3L	CHEVROLET C20 SUBURBAN
	1966-1969	V8-5.3L	CHEVROLET C30 PICKUP
	1967-1969	V8-5.3L	CHEVROLET CAMARO
	1966-1969	V8-5.3L	CHEVROLET CAPRICE
	1964-1968	V8-5.3L	CHEVROLET CHEVELLE
	1965-1968	V8-5.3L	CHEVROLET CHEVY II
	1962-1968	V8-5.3L	CHEVROLET CORVETTE
	1966-1969	V8-5.3L	CHEVROLET EL CAMINO
	1962-1969	V8-5.3L	CHEVROLET IMPALA
	1966-1969	V8-5.3L	CHEVROLET K10 PICKUP
	1966-1969	V8-5.3L	CHEVROLET K10 SUBURBAN
	1966-1969	V8-5.3L	CHEVROLET K20 PICKUP
	1966-1969	V8-5.3L	CHEVROLET K20 SUBURBAN
	1968-1969	V8-5.3L	CHEVROLET K30 PICKUP
	1969	V8-5.3L	CHEVROLET KINGSWOOD
	1964-1967	V8-5.3L	CHEVROLET MALIBU
	1966-1967	V8-5.3L	CHEVROLET SUBURBAN
	1955-1958	V8-5.3L	CHEVROLET TRUCK
	1968-1969	V8-5.4L	AVANTI II
	1968-1969	V8-5.4L	CHEVROLET BEL AIR
	1968-1969	V8-5.4L	CHEVROLET BISCAYNE
	1968	V8-5.4L	CHEVROLET C10 PICKUP
	1968	V8-5.4L	CHEVROLET C10 SUBURBAN
	1968	V8-5.4L	CHEVROLET C20 PICKUP
	1968	V8-5.4L	CHEVROLET C20 SUBURBAN
	1968	V8-5.4L	CHEVROLET C30 PICKUP
	1968-1969	V8-5.4L	CHEVROLET CAMARO
	1968-1969	V8-5.4L	CHEVROLET CAPRICE
	1965-1968	V8-5.4L	CHEVROLET CHEVELLE
	1965-1968	V8-5.4L	CHEVROLET CHEVY II
	1968	V8-5.4L	CHEVROLET CORVETTE
	1964-1969	V8-5.4L	CHEVROLET CS1073 (MEX)

**WATER PUMPS**

USMW	Years	Cyl.	Specifications
	1965-1969	V8-5.4L	CHEVROLET CS31003 (MEX)
	1968	V8-5.4L	CHEVROLET EL CAMINO
	1964-1969	V8-5.4L	CHEVROLET IMPALA
	1968	V8-5.4L	CHEVROLET K10 PICKUP
	1968	V8-5.4L	CHEVROLET K10 SUBURBAN
	1967	V8-5.4L	CHEVROLET K20 PANEL
	1968	V8-5.4L	CHEVROLET K20 PICKUP
	1968	V8-5.4L	CHEVROLET K20 SUBURBAN
	1968	V8-5.4L	CHEVROLET K30 PICKUP
	1969	V8-5.7L	AVANTI II
	1958-1972	V8-5.7L	CHEVROLET BEL AIR
	1958-1972	V8-5.7L	CHEVROLET BISCAYNE
	1969-1972	V8-5.7L	CHEVROLET BLAZER
	1958-1972	V8-5.7L	CHEVROLET BROOKWOOD
	1960-1972	V8-5.7L	CHEVROLET C10 PICKUP
	1960-1972	V8-5.7L	CHEVROLET C10 SUBURBAN
	1960-1972	V8-5.7L	CHEVROLET C20 PICKUP
	1960-1972	V8-5.7L	CHEVROLET C20 SUBURBAN
	1960-1972	V8-5.7L	CHEVROLET C30 PICKUP
	1967-1972	V8-5.7L	CHEVROLET CAMARO
	1969-1972	V8-5.7L	CHEVROLET CAPRICE
	1968-1972	V8-5.7L	CHEVROLET CHEVELLE
	1968	V8-5.7L	CHEVROLET CHEVY II
	1969-1972	V8-5.7L	CHEVROLET CORVETTE
	1968-1974	V8-5.7L	CHEVROLET CS31003 (MEX)
	1958	V8-5.7L	CHEVROLET DEL RAY
	1959-1972	V8-5.7L	CHEVROLET EL CAMINO
	1970-1972	V8-5.7L	CHEVROLET G10 VAN
	1970-1972	V8-5.7L	CHEVROLET G20 VAN
	1970-1972	V8-5.7L	CHEVROLET G30 VAN
	1958-1972	V8-5.7L	CHEVROLET IMPALA
	1960-1972	V8-5.7L	CHEVROLET K10 PICKUP
	1960-1972	V8-5.7L	CHEVROLET K10 SUBURBAN
	1960-1972	V8-5.7L	CHEVROLET K20 PICKUP
	1960-1972	V8-5.7L	CHEVROLET K20 SUBURBAN
	1969-1972	V8-5.7L	CHEVROLET K30 PICKUP
	1959-1972	V8-5.7L	CHEVROLET KINGSWOOD
	1970-1972	V8-5.7L	CHEVROLET P20 VAN
	1960-1965	V8-5.7L	CHEVROLET P30 SERIES
	1970-1972	V8-5.7L	CHEVROLET P30 VAN
	1960-1965	V8-5.7L	CHEVROLET SUBURBAN
	1958-1960	V8-5.7L	CHEVROLET TRUCK
<b>US907</b>	1967-1969	V8-5.2L	PLYMOUTH BARRACUDA (MEX)
<b>US919</b>	1964	V8-4.5L	DODGE 330
	1964	V8-4.5L	DODGE 440
	1964	V8-4.5L	DODGE 880
	1964-1966	V8-4.5L	DODGE A100
	1964-1967	V8-4.5L	DODGE A100 TRUCK
	1966-1967	V8-4.5L	DODGE CHARGER
	1965-1968	V8-4.5L	DODGE CORONET
	1964-1965	V8-4.5L	DODGE CUSTOM
	1964-1969	V8-4.5L	DODGE DART
	1964-1967	V8-4.5L	DODGE POLARA
	1964-1968	V8-4.5L	PLYMOUTH BARRACUDA
	1964-1968	V8-4.5L	PLYMOUTH BELVEDERE
	1965-1967	V8-4.5L	PLYMOUTH BELVEDERE II
	1964-1965	V8-4.5L	PLYMOUTH FURY
	1965	V8-4.5L	PLYMOUTH FURY II
	1965	V8-4.5L	PLYMOUTH FURY III
	1967	V8-4.5L	PLYMOUTH GTX
	1968	V8-4.5L	PLYMOUTH ROADRUNNER
	1965-1968	V8-4.5L	PLYMOUTH SATELLITE
	1964	V8-4.5L	PLYMOUTH SAVOY
	1964-1969	V8-4.5L	PLYMOUTH VALIANT
	1963-1964	V8-5.2L	DODGE 330
	1963-1964	V8-5.2L	DODGE 440
	1963-1964	V8-5.2L	DODGE 880
	1967-1969	V8-5.2L	DODGE A100 TRUCK
	1966-1969	V8-5.2L	DODGE CHARGER

USMW	Years	Cyl.	Specifications
	1965-1969	V8-5.2L	DODGE CORONET
	1967-1969	V8-5.2L	DODGE CORONET (MEX)
	1962-1965	V8-5.2L	DODGE CUSTOM
	1968-1969	V8-5.2L	DODGE D100 PICKUP
	1960-1967	V8-5.2L	DODGE D100 SERIES
	1968-1969	V8-5.2L	DODGE D200 PICKUP
	1960-1967	V8-5.2L	DODGE D200 SERIES
	1968-1969	V8-5.2L	DODGE D300 PICKUP
	1960-1967	V8-5.2L	DODGE D300 SERIES
	1960-1969	V8-5.2L	DODGE DART
	1960	V8-5.2L	DODGE MATADOR
	1968-1969	V8-5.2L	DODGE MONACO
	1969	V8-5.2L	DODGE MONACO (MEX)
	1960-1969	V8-5.2L	DODGE POLARA
	1960-1961	V8-5.2L	DODGE SENECA
	1960	V8-5.2L	DODGE TRUCK
	1968-1969	V8-5.2L	DODGE W100 PICKUP
	1960-1967	V8-5.2L	DODGE W100 SERIES
	1968-1969	V8-5.2L	DODGE W200 PICKUP
	1960-1967	V8-5.2L	DODGE W200 SERIES
	1968-1969	V8-5.2L	DODGE W300 PICKUP
	1960-1967	V8-5.2L	DODGE W300 SERIES
	1960-1962	V8-5.2L	DODGE WM300 POWER WAGON
	1966-1969	V8-5.2L	PLYMOUTH BARRACUDA
	1967	V8-5.2L	PLYMOUTH BARRACUDA (MEX)
	1958-1969	V8-5.2L	PLYMOUTH BELVEDERE
	1965-1967	V8-5.2L	PLYMOUTH BELVEDERE II
	1958-1961	V8-5.2L	PLYMOUTH CUSTOM
	1960-1963	V8-5.2L	PLYMOUTH FLEET SPECIAL
	1958-1969	V8-5.2L	PLYMOUTH FURY
	1968-1969	V8-5.2L	PLYMOUTH FURY I
	1965-1969	V8-5.2L	PLYMOUTH FURY II
	1965-1969	V8-5.2L	PLYMOUTH FURY III
	1967-1969	V8-5.2L	PLYMOUTH GTX
	1958	V8-5.2L	PLYMOUTH PLAZA
	1968-1969	V8-5.2L	PLYMOUTH ROADRUNNER
	1965-1969	V8-5.2L	PLYMOUTH SATELLITE
	1958-1964	V8-5.2L	PLYMOUTH SAVOY
	1960-1961	V8-5.2L	PLYMOUTH SPORT WAGON
	1958-1961	V8-5.2L	PLYMOUTH SUBURBAN
	1968-1969	V8-5.2L	PLYMOUTH VALIANT
	1967	V8-5.2L	PLYMOUTH VIP
	1968-1969	V8-5.6L	DODGE DART
	1968-1969	V8-5.6L	PLYMOUTH BARRACUDA
	1968-1969	V8-5.6L	PLYMOUTH ROADRUNNER
	1968-1969	V8-5.6L	PLYMOUTH SATELLITE
	1968-1969	V8-5.6L	PLYMOUTH VALIANT
<b>US927</b>	1967	L6-4.1L	CHEVROLET MALIBU (MEX)
<b>US932</b>	1978-1982	V8-5.8L	FORD BRONCO
	1975-1977	V8-5.8L	FORD CUSTOM 500
	1980-1982	V8-5.8L	FORD E-100 ECONOLINE
	1980-1982	V8-5.8L	FORD E-100 ECONOLINE CLUB WAGON
	1980-1982	V8-5.8L	FORD E-150 ECONOLINE
	1980-1982	V8-5.8L	FORD E-150 ECONOLINE CLUB WAGON
	1980-1982	V8-5.8L	FORD E-250 ECONOLINE
	1980-1982	V8-5.8L	FORD E-250 ECONOLINE CLUB WAGON
	1980-1982	V8-5.8L	FORD E-350 ECONOLINE
	1980-1982	V8-5.8L	FORD E-350 ECONOLINE CLUB WAGON
	1975-1976	V8-5.8L	FORD ELITE
	1977-1981	V8-5.8L	FORD F-100
	1977-1979	V8-5.8L	FORD F-150
	1977-1979	V8-5.8L	FORD F-250
	1977-1979	V8-5.8L	FORD F-350
	1975-1979	V8-5.8L	FORD LTD
	1977-1979	V8-5.8L	FORD LTD II
	1975-1979	V8-5.8L	FORD RANCHERO
	1977-1979	V8-5.8L	FORD THUNDERBIRD
	1975-1976	V8-5.8L	FORD TORINO
	1975-1979	V8-5.8L	MERCURY COUGAR



USMW	Years	Cyl.	Specifications	USMW	Years	Cyl.	Specifications
	1977-1978	V8-5.8L	MERCURY GRAND MARQUIS (MEX)		1975-1977	V8-5.0L	MERCURY COMET
	1978-1979	V8-5.8L	MERCURY MARQUIS		1977-1979	V8-5.0L	MERCURY COUGAR
	1975-1976	V8-5.8L	MERCURY MONTEGO		1979	V8-5.0L	MERCURY MARQUIS
	1978-1979	V8-6.6L	FORD BRONCO		1975-1980	V8-5.0L	MERCURY MONARCH
	1975-1977	V8-6.6L	FORD CUSTOM 500		1978-1979	V8-5.0L	MERCURY ZEPHYR
	1980	V8-6.6L	FORD E-250 ECONOLINE		1978-1987	V8-5.8L	FORD BRONCO
	1980-1982	V8-6.6L	FORD E-250 ECONOLINE CLUB WAGON		1976-1977	V8-5.8L	FORD CUSTOM 500
	1980-1982	V8-6.6L	FORD E-350 ECONOLINE		1975-1983	V8-5.8L	FORD E-100 ECONOLINE
	1980-1982	V8-6.6L	FORD E-350 ECONOLINE CLUB WAGON		1975-1983	V8-5.8L	FORD E-100 ECONOLINE CLUB WAGON
	1975-1976	V8-6.6L	FORD ELITE		1975-1987	V8-5.8L	FORD E-150 ECONOLINE
	1977-1979	V8-6.6L	FORD F-100		1975-1987	V8-5.8L	FORD E-150 ECONOLINE CLUB WAGON
	1977-1979	V8-6.6L	FORD F-150		1975-1987	V8-5.8L	FORD E-250 ECONOLINE
	1977-1982	V8-6.6L	FORD F-250		1975-1987	V8-5.8L	FORD E-250 ECONOLINE CLUB WAGON
	1977-1982	V8-6.6L	FORD F-350		1975-1987	V8-5.8L	FORD E-350 ECONOLINE
	1975-1978	V8-6.6L	FORD LTD		1977-1987	V8-5.8L	FORD E-350 ECONOLINE CLUB WAGON
	1977-1978	V8-6.6L	FORD LTD II		1975	V8-5.8L	FORD ELITE
	1975-1978	V8-6.6L	FORD RANCHERO		1977-1981	V8-5.8L	FORD F-100
	1977-1978	V8-6.6L	FORD THUNDERBIRD		1977-1987	V8-5.8L	FORD F-150
	1975-1976	V8-6.6L	FORD TORINO		1986-1987	V8-5.8L	FORD F-150 (MEX)
	1977-1979	V8-6.6L	LINCOLN CONTINENTAL		1977-1987	V8-5.8L	FORD F-250
	1977-1979	V8-6.6L	LINCOLN MARK V		1980-1987	V8-5.8L	FORD F-350
	1975-1978	V8-6.6L	MERCURY COUGAR		1986-1987	V8-5.8L	FORD F-350 (MEX)
	1975-1978	V8-6.6L	MERCURY MARQUIS		1975-1976	V8-5.8L	FORD GALAXIE (MEX)
	1975-1976	V8-6.6L	MERCURY MONTEGO		1970-1974	V8-5.8L	FORD GALAXIE 500 (MEX)
<b>US934B</b>	1969	V8-5.2L	PLYMOUTH VALIANT SUPER BEE (MEX)		1975-1977	V8-5.8L	FORD GRANADA
<b>US953</b>	1982-1985	V6-3.8L	FORD B150 (MEX)		1975-1979	V8-5.8L	FORD LTD
	1981-1982	V8-4.2L	FORD F-100		1977-1978	V8-5.8L	FORD LTD (MEX)
	1980-1982	V8-4.2L	FORD FAIRMONT		1977-1979	V8-5.8L	FORD LTD II
	1978-1979	V8-4.2L	FORD FAIRMONT (MEX)		1974-1977	V8-5.8L	FORD MUSTANG (MEX)
	1980-1981	V8-4.2L	FORD GRANADA		1986-1987	V8-5.8L	FORD P350 MICROBUS (MEX)
	1980	V8-4.2L	MERCURY MONARCH		1975-1978	V8-5.8L	FORD RANCHERO
	1980-1982	V8-4.2L	MERCURY ZEPHYR		1977-1979	V8-5.8L	FORD THUNDERBIRD
	1973-1979	V8-4.7L	FORD B100 (MEX)		1976	V8-5.8L	FORD TORINO
	1975-1978	V8-4.7L	FORD B150 (MEX)		1977	V8-5.8L	LINCOLN VERSAILLES
	1969-1978	V8-4.7L	FORD F-100 (MEX)		1975-1979	V8-5.8L	MERCURY COUGAR
	1979	V8-4.7L	FORD F-150 (MEX)		1978-1979	V8-5.8L	MERCURY MARQUIS
	1969-1977	V8-4.7L	FORD F-350 (MEX)		1975-1977	V8-5.8L	MERCURY MONARCH
	1971-1977	V8-4.7L	FORD MAVERICK (MEX)		1975-1976	V8-5.8L	MERCURY MONTEGO
	1973-1981	V8-5.0L	FORD B100 (MEX)	<b>US953H</b>	1982-1985	V6-3.8L	FORD B150 (MEX)
	1975-1985	V8-5.0L	FORD B150 (MEX)		1981-1982	V8-4.2L	FORD F-100
	1985-1986	V8-5.0L	FORD B200 (MEX)		1980-1982	V8-4.2L	FORD FAIRMONT
	1980-1986	V8-5.0L	FORD BRONCO		1978-1979	V8-4.2L	FORD FAIRMONT (MEX)
	1975-1983	V8-5.0L	FORD E-100 ECONOLINE		1980-1981	V8-4.2L	FORD GRANADA
	1979-1983	V8-5.0L	FORD E-100 ECONOLINE CLUB WAGON		1980	V8-4.2L	MERCURY MONARCH
	1975-1986	V8-5.0L	FORD E-150 ECONOLINE		1980-1982	V8-4.2L	MERCURY ZEPHYR
	1979-1986	V8-5.0L	FORD E-150 ECONOLINE CLUB WAGON		1973-1979	V8-4.7L	FORD B100 (MEX)
	1975-1986	V8-5.0L	FORD E-250 ECONOLINE		1975-1978	V8-4.7L	FORD B150 (MEX)
	1979-1980	V8-5.0L	FORD E-250 ECONOLINE CLUB WAGON		1969-1978	V8-4.7L	FORD F-100 (MEX)
	1975-1979	V8-5.0L	FORD E-350 ECONOLINE		1979	V8-4.7L	FORD F-150 (MEX)
	1979	V8-5.0L	FORD E-350 ECONOLINE CLUB WAGON		1969-1977	V8-4.7L	FORD F-350 (MEX)
	1975-1983	V8-5.0L	FORD F-100		1971-1977	V8-4.7L	FORD MAVERICK (MEX)
	1975-1986	V8-5.0L	FORD F-150		1973-1981	V8-5.0L	FORD B100 (MEX)
	1986	V8-5.0L	FORD F-150 (MEX)		1975-1985	V8-5.0L	FORD B150 (MEX)
	1975-1986	V8-5.0L	FORD F-250		1985-1986	V8-5.0L	FORD B200 (MEX)
	1980	V8-5.0L	FORD F-350		1980-1986	V8-5.0L	FORD BRONCO
	1968-1987	V8-5.0L	FORD F-350 (MEX)		1975-1983	V8-5.0L	FORD E-100 ECONOLINE
					1979-1983	V8-5.0L	FORD E-100 ECONOLINE CLUB WAGON
					1975-1986	V8-5.0L	FORD E-150 ECONOLINE
					1979-1986	V8-5.0L	FORD E-150 ECONOLINE CLUB WAGON
					1975-1986	V8-5.0L	FORD E-250 ECONOLINE
					1979-1980	V8-5.0L	FORD E-250 ECONOLINE CLUB WAGON
					1975-1979	V8-5.0L	FORD E-350 ECONOLINE
					1979	V8-5.0L	FORD E-350 ECONOLINE CLUB WAGON
					1975-1983	V8-5.0L	FORD F-100
					1975-1986	V8-5.0L	FORD F-150
					1986	V8-5.0L	FORD F-150 (MEX)
					1975-1986	V8-5.0L	FORD F-250
					1980	V8-5.0L	FORD F-350
					1968-1987	V8-5.0L	FORD F-350 (MEX)

USMW	Years	Cyl.	Specifications
	1978-1979	V8-5.0L	FORD FAIRMONT
	1981-1983	V8-5.0L	FORD FAIRMONT (MEX)
	1975-1980	V8-5.0L	FORD GRANADA
	1977-1979	V8-5.0L	FORD LTD
	1975-1976	V8-5.0L	FORD LTD (MEX)
	1977-1979	V8-5.0L	FORD LTD II
	1975-1977	V8-5.0L	FORD MAVERICK
	1970	V8-5.0L	FORD MAVERICK (MEX)
	1973-1978	V8-5.0L	FORD MUSTANG (MEX)
	1976-1978	V8-5.0L	FORD MUSTANG II
	1977-1979	V8-5.0L	FORD RANCHERO
	1977-1979	V8-5.0L	FORD THUNDERBIRD
	1977-1980	V8-5.0L	LINCOLN VERSAILLES
	1975-1977	V8-5.0L	MERCURY COMET
	1977-1979	V8-5.0L	MERCURY COUGAR
	1979	V8-5.0L	MERCURY MARQUIS
	1975-1980	V8-5.0L	MERCURY MONARCH
	1978-1979	V8-5.0L	MERCURY ZEPHYR
	1978-1987	V8-5.8L	FORD BRONCO
	1976-1977	V8-5.8L	FORD CUSTOM 500
	1975-1983	V8-5.8L	FORD E-100 ECONOLINE
	1975-1983	V8-5.8L	FORD E-100 ECONOLINE CLUB WAGON
	1975-1987	V8-5.8L	FORD E-150 ECONOLINE
	1975-1987	V8-5.8L	FORD E-150 ECONOLINE CLUB WAGON
	1975-1987	V8-5.8L	FORD E-250 ECONOLINE
	1975-1987	V8-5.8L	FORD E-250 ECONOLINE CLUB WAGON
	1975-1987	V8-5.8L	FORD E-350 ECONOLINE
	1977-1987	V8-5.8L	FORD E-350 ECONOLINE CLUB WAGON
	1975	V8-5.8L	FORD ELITE
	1977-1981	V8-5.8L	FORD F-100
	1977-1987	V8-5.8L	FORD F-150
	1986-1987	V8-5.8L	FORD F-150 (MEX)
	1977-1987	V8-5.8L	FORD F-250
	1980-1987	V8-5.8L	FORD F-350
	1986-1987	V8-5.8L	FORD F-350 (MEX)
	1975-1976	V8-5.8L	FORD GALAXIE (MEX)
	1970-1974	V8-5.8L	FORD GALAXIE 500 (MEX)
	1975-1977	V8-5.8L	FORD GRANADA
	1975-1979	V8-5.8L	FORD LTD
	1977-1978	V8-5.8L	FORD LTD (MEX)
	1977-1979	V8-5.8L	FORD LTD II
	1974-1977	V8-5.8L	FORD MUSTANG (MEX)
	1986-1987	V8-5.8L	FORD P350 MICROBUS (MEX)
	1975-1978	V8-5.8L	FORD RANCHERO
	1977-1979	V8-5.8L	FORD THUNDERBIRD
	1976	V8-5.8L	FORD TORINO
	1977	V8-5.8L	LINCOLN VERSAILLES
	1975-1979	V8-5.8L	MERCURY COUGAR
	1978-1979	V8-5.8L	MERCURY MARQUIS
	1975-1977	V8-5.8L	MERCURY MONARCH
	1975-1976	V8-5.8L	MERCURY MONTEGO
<b>US960</b>	1975-1980	L6-4.1L	FORD GRANADA
	1975-1977	L6-4.1L	FORD MAVERICK
	1975-1977	L6-4.1L	MERCURY COMET
	1975-1980	L6-4.1L	MERCURY MONARCH
<b>US964</b>	1971-1974	L4-2.0L	FORD CAPRI
	1971-1974	L4-2.0L	FORD PINTO
<b>US975</b>	1977-1979	L6-4.1L	PONTIAC CATALINA
	1980-1981	V8-4.3L	BUICK CENTURY
	1980-1981	V8-4.3L	BUICK REGAL
	1980-1981	V8-4.3L	PONTIAC BONNEVILLE
	1980-1981	V8-4.3L	PONTIAC CATALINA
	1981	V8-4.3L	PONTIAC FIREBIRD
	1980-1981	V8-4.3L	PONTIAC GRAND LEMANS
	1980-1981	V8-4.3L	PONTIAC GRAND PRIX
	1980-1981	V8-4.3L	PONTIAC LEMANS
	1979-1980	V8-4.9L	BUICK CENTURY
	1980	V8-4.9L	BUICK ELECTRA
	1980	V8-4.9L	BUICK ESTATE WAGON

USMW	Years	Cyl.	Specifications
	1977-1980	V8-4.9L	BUICK LESABRE
	1979-1980	V8-4.9L	BUICK REGAL
	1977	V8-4.9L	BUICK SKYLARK
	1979	V8-4.9L	OLDSMOBILE DELTA 88
	1977-1980	V8-4.9L	PONTIAC BONNEVILLE
	1977-1980	V8-4.9L	PONTIAC CATALINA
	1977-1981	V8-4.9L	PONTIAC FIREBIRD
	1978-1980	V8-4.9L	PONTIAC GRAND AM
	1980-1981	V8-4.9L	PONTIAC GRAND LEMANS
	1977-1980	V8-4.9L	PONTIAC GRAND PRIX
	1977	V8-4.9L	PONTIAC GRAND SAFARI
	1977-1981	V8-4.9L	PONTIAC LEMANS
	1977	V8-4.9L	PONTIAC VENTURA
	1977-1978	V8-5.7L	PONTIAC BONNEVILLE
	1976-1977	V8-5.7L	PONTIAC CATALINA
	1975-1976	V8-5.7L	PONTIAC FIREBIRD
	1975	V8-5.7L	PONTIAC GRAND AM
	1976	V8-5.7L	PONTIAC GRAND PRIX
	1977	V8-5.7L	PONTIAC GRAND SAFARI
	1975-1976	V8-5.7L	PONTIAC LEMANS
	1975	V8-6.6L	OLDSMOBILE CUSTOM CRUISER
	1975-1979	V8-6.6L	PONTIAC BONNEVILLE
	1975-1979	V8-6.6L	PONTIAC CATALINA
	1975-1979	V8-6.6L	PONTIAC FIREBIRD
	1975	V8-6.6L	PONTIAC GRAND AM
	1975-1977	V8-6.6L	PONTIAC GRAND PRIX
	1975-1978	V8-6.6L	PONTIAC GRAND SAFARI
	1975-1977	V8-6.6L	PONTIAC LEMANS
	1976	V8-6.6L	PONTIAC SAFARI
	1975-1976	V8-7.5L	PONTIAC BONNEVILLE
	1975-1976	V8-7.5L	PONTIAC CATALINA
	1975-1976	V8-7.5L	PONTIAC FIREBIRD
	1975	V8-7.5L	PONTIAC GRAND AM
	1975-1976	V8-7.5L	PONTIAC GRAND PRIX
	1975-1976	V8-7.5L	PONTIAC GRAND SAFARI
	1976	V8-7.5L	PONTIAC LEMANS
	1976	V8-7.5L	PONTIAC SAFARI
<b>US981</b>	1966-1969	V8-6.5L	CHEVROLET BEL AIR
	1966-1969	V8-6.5L	CHEVROLET BISCAYNE
	1968-1969	V8-6.5L	CHEVROLET C10 PICKUP
	1968-1969	V8-6.5L	CHEVROLET C10 SUBURBAN
	1968-1969	V8-6.5L	CHEVROLET C20 PICKUP
	1968-1969	V8-6.5L	CHEVROLET C20 SUBURBAN
	1968-1969	V8-6.5L	CHEVROLET C30 PICKUP
	1967-1970	V8-6.5L	CHEVROLET CAMARO
	1966-1969	V8-6.5L	CHEVROLET CAPRICE
	1966-1970	V8-6.5L	CHEVROLET CHEVELLE
	1968	V8-6.5L	CHEVROLET CHEVY II
	1966-1970	V8-6.5L	CHEVROLET EL CAMINO
	1966-1969	V8-6.5L	CHEVROLET IMPALA
	1968-1969	V8-6.5L	CHEVROLET K10 PICKUP
	1968-1969	V8-6.5L	CHEVROLET K10 SUBURBAN
	1968-1969	V8-6.5L	CHEVROLET K20 PICKUP
	1968-1969	V8-6.5L	CHEVROLET K20 SUBURBAN
	1968-1969	V8-6.5L	CHEVROLET K30 PICKUP
	1966-1967	V8-6.5L	CHEVROLET MALIBU
	1968-1969	V8-6.5L	GMC C15/C1500 PICKUP
	1968-1969	V8-6.5L	GMC C15/C1500 SUBURBAN
	1968-1969	V8-6.5L	GMC C25/C2500 PICKUP
	1968-1969	V8-6.5L	GMC C25/C2500 SUBURBAN
	1968-1969	V8-6.5L	GMC C35/C3500 PICKUP
	1968-1969	V8-6.5L	GMC K15/K1500 PICKUP
	1968-1969	V8-6.5L	GMC K15/K1500 SUBURBAN
	1968-1969	V8-6.5L	GMC K25/K2500 PICKUP
	1968-1969	V8-6.5L	GMC K25/K2500 SUBURBAN
	1968-1969	V8-6.5L	GMC K35/K3500 PICKUP
	1970-1972	V8-6.6L	CHEVROLET BEL AIR
	1970-1972	V8-6.6L	CHEVROLET BISCAYNE
	1970-1972	V8-6.6L	CHEVROLET C10 PICKUP

USMW	Years	Cyl.	Specifications
	1970-1972	V8-6.6L	CHEVROLET C10 SUBURBAN
	1970-1972	V8-6.6L	CHEVROLET C20 PICKUP
	1970-1972	V8-6.6L	CHEVROLET C20 SUBURBAN
	1970-1972	V8-6.6L	CHEVROLET C30 PICKUP
	1970-1972	V8-6.6L	CHEVROLET CAMARO
	1970-1972	V8-6.6L	CHEVROLET CAPRICE
	1970-1972	V8-6.6L	CHEVROLET CHEVELLE
	1970-1972	V8-6.6L	CHEVROLET EL CAMINO
	1970-1972	V8-6.6L	CHEVROLET IMPALA
	1970-1972	V8-6.6L	CHEVROLET K10 PICKUP
	1970-1972	V8-6.6L	CHEVROLET K10 SUBURBAN
	1970-1972	V8-6.6L	CHEVROLET K20 PICKUP
	1970-1972	V8-6.6L	CHEVROLET K20 SUBURBAN
	1970-1972	V8-6.6L	CHEVROLET K30 PICKUP
	1972	V8-6.6L	CHEVROLET P30 VAN
	1970-1972	V8-6.6L	GMC C15/C1500 PICKUP
	1970-1972	V8-6.6L	GMC C15/C1500 SUBURBAN
	1970-1972	V8-6.6L	GMC C25/C2500 PICKUP
	1970-1972	V8-6.6L	GMC C25/C2500 SUBURBAN
	1970-1972	V8-6.6L	GMC C35/C3500 PICKUP
	1970-1972	V8-6.6L	GMC K15/K1500 PICKUP
	1970-1972	V8-6.6L	GMC K15/K1500 SUBURBAN
	1970-1972	V8-6.6L	GMC K25/K2500 PICKUP
	1970-1972	V8-6.6L	GMC K25/K2500 SUBURBAN
	1970-1972	V8-6.6L	GMC K35/K3500 PICKUP
	1971-1972	V8-6.6L	GMC P15/P1500 VAN
	1971-1972	V8-6.6L	GMC P25/P2500 VAN
	1971-1972	V8-6.6L	GMC P35/P3500 VAN
	1966-1969	V8-7.0L	CHEVROLET BEL AIR
	1966-1969	V8-7.0L	CHEVROLET BISCAYNE
	1969	V8-7.0L	CHEVROLET CAMARO
	1966-1969	V8-7.0L	CHEVROLET CAPRICE
	1966-1969	V8-7.0L	CHEVROLET CORVETTE
	1966-1969	V8-7.0L	CHEVROLET IMPALA
<b>US984</b>	1980	V8-5.0L	CHEVROLET CORVETTE
	1975-1982	V8-5.7L	CHEVROLET CORVETTE
<b>US984H</b>	1980	V8-5.0L	CHEVROLET CORVETTE
	1975-1982	V8-5.7L	CHEVROLET CORVETTE
<b>US985</b>	1971-1974	V8-7.4L	CHEVROLET CORVETTE
<b>US986</b>	1974	L6-3.8L	AMERICAN MOTORS CLASSIC (MEX)
	1973-1974	L6-4.2L	AMERICAN MOTORS AMERICAN (MEX)
	1973-1974	L6-4.2L	AMERICAN MOTORS CLASSIC (MEX)
	1973-1974	L6-4.2L	AMERICAN MOTORS GREMLIN (MEX)
	1971-1973	L6-4.2L	AMERICAN MOTORS JAVELIN (MEX)
	1973-1974	L6-4.6L	AMERICAN MOTORS CLASSIC (MEX)
	1968-1973	L6-4.6L	AMERICAN MOTORS JAVELIN (MEX)
<b>US1002</b>	1975	V8-7.4L	CHEVROLET BEL AIR
	1975-1980	V8-7.4L	CHEVROLET C10
	1975-1980	V8-7.4L	CHEVROLET C10 SUBURBAN
	1975-1986	V8-7.4L	CHEVROLET C20
	1975-1986	V8-7.4L	CHEVROLET C20 SUBURBAN
	1975-1986	V8-7.4L	CHEVROLET C30
	1975-1976	V8-7.4L	CHEVROLET CAPRICE
	1975-1976	V8-7.4L	CHEVROLET IMPALA
	1980	V8-7.4L	CHEVROLET K10
	1980	V8-7.4L	CHEVROLET K20
	1985	V8-7.4L	CHEVROLET K20 SUBURBAN
	1980-1986	V8-7.4L	CHEVROLET K30
	1975	V8-7.4L	CHEVROLET MALIBU
	1975	V8-7.4L	CHEVROLET MONTE CARLO
	1975-1999	V8-7.4L	CHEVROLET P30
	1987-1988	V8-7.4L	CHEVROLET R20
	1987-1988	V8-7.4L	CHEVROLET R20 SUBURBAN
	1989	V8-7.4L	CHEVROLET R2500
	1987-1988	V8-7.4L	CHEVROLET R30
	1989-1991	V8-7.4L	CHEVROLET R3500
	1987-1988	V8-7.4L	CHEVROLET V20 SUBURBAN
	1990	V8-7.4L	CHEVROLET V2500 SUBURBAN
	1987-1988	V8-7.4L	CHEVROLET V30

USMW	Years	Cyl.	Specifications
	1989-1991	V8-7.4L	CHEVROLET V3500
	1980	V8-7.4L	GMC C1500
	1980	V8-7.4L	GMC C1500 SUBURBAN
	1980-1986	V8-7.4L	GMC C2500
	1980-1986	V8-7.4L	GMC C2500 SUBURBAN
	1980-1986	V8-7.4L	GMC C3500
	1980	V8-7.4L	GMC K1500
	1980-1986	V8-7.4L	GMC K3500
	1985-1999	V8-7.4L	GMC P3500
	1987-1989	V8-7.4L	GMC R2500
	1987-1988	V8-7.4L	GMC R2500 SUBURBAN
	1987-1991	V8-7.4L	GMC R3500
	1987-1991	V8-7.4L	GMC V3500
<b>US1002H</b>	1975	V8-7.4L	CHEVROLET BEL AIR
	1975-1980	V8-7.4L	CHEVROLET C10
	1975-1980	V8-7.4L	CHEVROLET C10 SUBURBAN
	1975-1986	V8-7.4L	CHEVROLET C20
	1975-1986	V8-7.4L	CHEVROLET C20 SUBURBAN
	1975-1986	V8-7.4L	CHEVROLET C30
	1975-1976	V8-7.4L	CHEVROLET CAPRICE
	1975-1976	V8-7.4L	CHEVROLET IMPALA
	1980	V8-7.4L	CHEVROLET K10
	1980	V8-7.4L	CHEVROLET K20
	1985	V8-7.4L	CHEVROLET K20 SUBURBAN
	1980-1986	V8-7.4L	CHEVROLET K30
	1975	V8-7.4L	CHEVROLET MALIBU
	1975	V8-7.4L	CHEVROLET MONTE CARLO
	1975-1999	V8-7.4L	CHEVROLET P30
	1987-1988	V8-7.4L	CHEVROLET R20
	1987-1988	V8-7.4L	CHEVROLET R20 SUBURBAN
	1989	V8-7.4L	CHEVROLET R2500
	1987-1988	V8-7.4L	CHEVROLET R30
	1989-1991	V8-7.4L	CHEVROLET R3500
	1987-1988	V8-7.4L	CHEVROLET V20 SUBURBAN
	1990	V8-7.4L	CHEVROLET V2500 SUBURBAN
	1987-1988	V8-7.4L	CHEVROLET V30
	1989-1991	V8-7.4L	CHEVROLET V3500
	1980	V8-7.4L	GMC C1500 SUBURBAN
	1980-1986	V8-7.4L	GMC C2500
	1980-1986	V8-7.4L	GMC C2500 SUBURBAN
	1980-1986	V8-7.4L	GMC C3500
	1980	V8-7.4L	GMC K1500
	1980-1986	V8-7.4L	GMC K3500
	1985-1999	V8-7.4L	GMC P3500
	1987-1989	V8-7.4L	GMC R2500
	1987-1988	V8-7.4L	GMC R2500 SUBURBAN
	1987-1991	V8-7.4L	GMC R3500
	1987-1991	V8-7.4L	GMC V3500
<b>US1006</b>	1970-1974	L4-1.2L	TOYOTA COROLLA
<b>US1010</b>	1971-1973	L4-1.5L	PLYMOUTH CRICKET
<b>US1012</b>	1975-1977	L4-1.6L	DODGE COLT
	1976-1977	L4-1.6L	PLYMOUTH ARROW
	1976-1977	L4-1.6L	PLYMOUTH COLT
<b>US1018</b>	1978-1979	V6-3.2L	BUICK CENTURY
	1978-1979	V6-3.2L	BUICK REGAL
	1978-1979	V6-3.2L	CHEVROLET MONZA
	1975-1981	V6-3.8L	BUICK CENTURY
	1976-1985	V6-3.8L	BUICK LESABRE
	1975-1987	V6-3.8L	BUICK REGAL
	1979-1985	V6-3.8L	BUICK RIVIERA
	1975-1980	V6-3.8L	BUICK SKYHAWK
	1975-1978	V6-3.8L	BUICK SKYLARK
	1980-1981	V6-3.8L	CHEVROLET CAMARO
	1980-1984	V6-3.8L	CHEVROLET CAPRICE
	1978-1984	V6-3.8L	CHEVROLET EL CAMINO
	1980-1984	V6-3.8L	CHEVROLET IMPALA
	1978-1983	V6-3.8L	CHEVROLET MALIBU
	1978-1984	V6-3.8L	CHEVROLET MONTE CARLO

**WATER PUMPS**



USMW	Years	Cyl.	Specifications
	1978-1980	V6-3.8L	CHEVROLET MONZA
	1980-1984	V6-3.8L	GMC CABALLERO
	1977-1981	V6-3.8L	OLDSMOBILE CUTLASS
	1978-1984	V6-3.8L	OLDSMOBILE CUTLASS CALAIS
	1980-1982	V6-3.8L	OLDSMOBILE CUTLASS CRUISER
	1978-1987	V6-3.8L	OLDSMOBILE CUTLASS SALON
	1980-1987	V6-3.8L	OLDSMOBILE CUTLASS SUPREME
	1977-1985	V6-3.8L	OLDSMOBILE DELTA 88
	1977-1979	V6-3.8L	OLDSMOBILE OMEGA
	1975-1980	V6-3.8L	OLDSMOBILE STARFIRE
	1980-1986	V6-3.8L	PONTIAC BONNEVILLE
	1978-1981	V6-3.8L	PONTIAC CATALINA
	1977-1989	V6-3.8L	PONTIAC FIREBIRD
	1979	V6-3.8L	PONTIAC GRAND AM
	1980-1981	V6-3.8L	PONTIAC GRAND LEMANS
	1978-1987	V6-3.8L	PONTIAC GRAND PRIX
	1977-1981	V6-3.8L	PONTIAC LEMANS
	1984	V6-3.8L	PONTIAC PARISIENNE
	1977-1979	V6-3.8L	PONTIAC PHOENIX
	1976-1980	V6-3.8L	PONTIAC SUNBIRD
	1977	V6-3.8L	PONTIAC VENTURA
	1980-1984	V6-4.1L	BUICK ELECTRA
	1980-1984	V6-4.1L	BUICK LESABRE
	1982-1984	V6-4.1L	BUICK REGAL
	1981-1984	V6-4.1L	BUICK RIVIERA
	1980-1982	V6-4.1L	CADILLAC DEVILLE
	1981-1982	V6-4.1L	CADILLAC ELDORADO
	1980-1982	V6-4.1L	CADILLAC FLEETWOOD
	1981-1982	V6-4.1L	CADILLAC SEVILLE
	1981-1983	V6-4.1L	OLDSMOBILE 98
	1981-1984	V6-4.1L	OLDSMOBILE TORONADO
	1982	V6-4.1L	PONTIAC BONNEVILLE
	1982	V6-4.1L	PONTIAC GRAND PRIX
	1975	V8-5.7L	BUICK APOLLO
	1975-1977	V8-5.7L	BUICK CENTURY
	1977-1980	V8-5.7L	BUICK ELECTRA
	1980	V8-5.7L	BUICK ESTATE WAGON
	1975-1980	V8-5.7L	BUICK LESABRE
	1975-1977	V8-5.7L	BUICK REGAL
	1977-1979	V8-5.7L	BUICK RIVIERA
	1975-1976	V8-5.7L	BUICK SKYLARK
	1979-1980	V8-5.7L	PONTIAC BONNEVILLE
	1978-1980	V8-5.7L	PONTIAC CATALINA
	1975-1976	V8-5.7L	PONTIAC VENTURA
<b>US1018H</b>	1978-1979	V6-3.2L	BUICK CENTURY
	1978-1979	V6-3.2L	BUICK REGAL
	1978-1979	V6-3.2L	CHEVROLET MONZA
	1975-1981	V6-3.8L	BUICK CENTURY
	1976-1985	V6-3.8L	BUICK LESABRE
	1975-1987	V6-3.8L	BUICK REGAL
	1979-1985	V6-3.8L	BUICK RIVIERA
	1975-1980	V6-3.8L	BUICK SKYHAWK
	1975-1979	V6-3.8L	BUICK SKYLARK
	1980-1981	V6-3.8L	CHEVROLET CAMARO
	1980-1984	V6-3.8L	CHEVROLET CAPRICE
	1978-1984	V6-3.8L	CHEVROLET EL CAMINO
	1980-1984	V6-3.8L	CHEVROLET IMPALA
	1978-1983	V6-3.8L	CHEVROLET MALIBU
	1978-1984	V6-3.8L	CHEVROLET MONTE CARLO
	1978-1980	V6-3.8L	CHEVROLET MONZA
	1980-1984	V6-3.8L	GMC CABALLERO
	1977-1981	V6-3.8L	OLDSMOBILE CUTLASS
	1978-1984	V6-3.8L	OLDSMOBILE CUTLASS CALAIS
	1980-1982	V6-3.8L	OLDSMOBILE CUTLASS CRUISER
	1978-1987	V6-3.8L	OLDSMOBILE CUTLASS SALON
	1980-1987	V6-3.8L	OLDSMOBILE CUTLASS SUPREME
	1977-1985	V6-3.8L	OLDSMOBILE DELTA 88
	1977-1979	V6-3.8L	OLDSMOBILE OMEGA
	1975-1980	V6-3.8L	OLDSMOBILE STARFIRE

USMW	Years	Cyl.	Specifications
	1980-1986	V6-3.8L	PONTIAC BONNEVILLE
	1978-1981	V6-3.8L	PONTIAC CATALINA
	1977-1989	V6-3.8L	PONTIAC FIREBIRD
	1979	V6-3.8L	PONTIAC GRAND AM
	1980-1981	V6-3.8L	PONTIAC GRAND LEMANS
	1978-1987	V6-3.8L	PONTIAC GRAND PRIX
	1977-1981	V6-3.8L	PONTIAC LEMANS
	1984	V6-3.8L	PONTIAC PARISIENNE
	1977-1979	V6-3.8L	PONTIAC PHOENIX
	1976-1980	V6-3.8L	PONTIAC SUNBIRD
	1977	V6-3.8L	PONTIAC VENTURA
	1980-1984	V6-4.1L	BUICK ELECTRA
	1980-1984	V6-4.1L	BUICK LESABRE
	1982-1984	V6-4.1L	BUICK REGAL
	1981-1984	V6-4.1L	BUICK RIVIERA
	1980-1982	V6-4.1L	CADILLAC DEVILLE
	1981-1982	V6-4.1L	CADILLAC ELDORADO
	1980-1982	V6-4.1L	CADILLAC FLEETWOOD
	1981-1982	V6-4.1L	CADILLAC SEVILLE
	1981-1983	V6-4.1L	OLDSMOBILE 98
	1981-1984	V6-4.1L	OLDSMOBILE TORONADO
	1982	V6-4.1L	PONTIAC BONNEVILLE
	1982	V6-4.1L	PONTIAC GRAND PRIX
	1975	V8-5.7L	BUICK APOLLO
	1975-1978	V8-5.7L	BUICK CENTURY
	1977-1980	V8-5.7L	BUICK ELECTRA
	1980	V8-5.7L	BUICK ESTATE WAGON
	1975-1980	V8-5.7L	BUICK LESABRE
	1975-1977	V8-5.7L	BUICK REGAL
	1977-1979	V8-5.7L	BUICK RIVIERA
	1975-1978	V8-5.7L	BUICK SKYLARK
	1979-1980	V8-5.7L	PONTIAC BONNEVILLE
	1978-1980	V8-5.7L	PONTIAC CATALINA
	1975-1976	V8-5.7L	PONTIAC VENTURA
<b>US1021</b>	1965-1971	L6-3.8L	JEEP CJ5D (MEX)
	1965-1971	L6-3.8L	JEEP CJ5S (MEX)
	1965-1974	L6-3.8L	JEEP CJ7 (MEX)
	1968-1969	L6-3.8L	JEEP J162 (MEX)
	1967-1972	L6-3.8L	JEEP J164 (MEX)
	1967-1972	L6-3.8L	JEEP J164V (MEX)
	1968-1971	L6-3.8L	JEEP J262S (MEX)
	1967	L6-3.8L	JEEP J264D (MEX)
	1967-1972	L6-3.8L	JEEP J364R (MEX)
	1965-1971	L6-4.2L	JEEP CJ5D (MEX)
	1965-1971	L6-4.2L	JEEP CJ5S (MEX)
	1965-1974	L6-4.2L	JEEP CJ7 (MEX)
	1965-1969	L6-4.2L	JEEP J162 (MEX)
	1965-1972	L6-4.2L	JEEP J164 (MEX)
	1965-1972	L6-4.2L	JEEP J164V (MEX)
	1968-1971	L6-4.2L	JEEP J262S (MEX)
	1965-1967	L6-4.2L	JEEP J264D (MEX)
	1965-1972	L6-4.2L	JEEP J364R (MEX)
	1973	L6-4.6L	JEEP CJ7 (MEX)
<b>US1028</b>	1973-1974	V8-4.7L	FORD B100 (MEX)
	1965-1978	V8-4.7L	FORD F-100 (MEX)
	1965-1974	V8-4.7L	FORD F-350 (MEX)
	1973-1974	V8-5.0L	FORD B100 (MEX)
	1975-1977	V8-5.0L	FORD BRONCO
	1967-1968	V8-5.0L	FORD F-350 (MEX)
	1969	V8-5.0L	FORD FALCON (MEX)
	1969	V8-5.0L	FORD MUSTANG (MEX)
	1969	V8-5.8L	FORD GALAXIE 500 (MEX)
<b>US1028H</b>	1973-1974	V8-4.7L	FORD B100 (MEX)
	1965-1978	V8-4.7L	FORD F-100 (MEX)
	1965-1974	V8-4.7L	FORD F-350 (MEX)
	1973-1974	V8-5.0L	FORD B100 (MEX)
	1975-1977	V8-5.0L	FORD BRONCO
	1967-1968	V8-5.0L	FORD F-350 (MEX)
	1969	V8-5.0L	FORD FALCON (MEX)

USMW	Years	Cyl.	Specifications
	1969	V8-5.0L	FORD MUSTANG (MEX)
	1969	V8-5.8L	FORD GALAXIE 500 (MEX)
<b>US1040</b>	1975-1978	V8-6.6L	CHRYSLER CORDOBA
	1975-1978	V8-6.6L	CHRYSLER NEW YORKER
	1975-1978	V8-6.6L	CHRYSLER NEWPORT
	1976-1978	V8-6.6L	DODGE B200
	1976-1978	V8-6.6L	DODGE B300
	1975-1978	V8-6.6L	DODGE CHARGER
	1975-1976	V8-6.6L	DODGE CORONET
	1976-1978	V8-6.6L	DODGE D100
	1977-1978	V8-6.6L	DODGE D150
	1975-1978	V8-6.6L	DODGE D200
	1976-1978	V8-6.6L	DODGE D300
	1978	V8-6.6L	DODGE MAGNUM
	1975-1978	V8-6.6L	DODGE MONACO
	1976-1978	V8-6.6L	DODGE RAMCHARGER
	1975-1977	V8-6.6L	DODGE ROYAL MONACO
	1975-1977	V8-6.6L	DODGE W100
	1976-1978	V8-6.6L	DODGE W200
	1976-1978	V8-6.6L	DODGE W300
	1975-1978	V8-6.6L	PLYMOUTH FURY
	1975-1977	V8-6.6L	PLYMOUTH GRAN FURY
	1976-1978	V8-6.6L	PLYMOUTH PB200
	1976-1978	V8-6.6L	PLYMOUTH PB300
	1976-1978	V8-6.6L	PLYMOUTH TRAILDUSTER
	1975	V8-7.2L	CHRYSLER IMPERIAL
	1975-1978	V8-7.2L	CHRYSLER NEW YORKER
	1975-1978	V8-7.2L	CHRYSLER NEWPORT
	1975-1978	V8-7.2L	DODGE B200
	1975-1978	V8-7.2L	DODGE B300
	1975-1976	V8-7.2L	DODGE CORONET
	1975-1978	V8-7.2L	DODGE D100
	1978	V8-7.2L	DODGE D150
	1975-1978	V8-7.2L	DODGE D200
	1975-1978	V8-7.2L	DODGE D300
	1975-1978	V8-7.2L	DODGE MONACO
	1975-1978	V8-7.2L	DODGE RAMCHARGER
	1975-1977	V8-7.2L	DODGE ROYAL MONACO
	1975-1977	V8-7.2L	DODGE W100
	1975-1978	V8-7.2L	DODGE W200
	1975-1978	V8-7.2L	DODGE W300
	1975-1978	V8-7.2L	PLYMOUTH FURY
	1975-1977	V8-7.2L	PLYMOUTH GRAN FURY
	1976-1978	V8-7.2L	PLYMOUTH PB200
	1976-1978	V8-7.2L	PLYMOUTH PB300
	1975-1978	V8-7.2L	PLYMOUTH TRAILDUSTER
<b>US1042</b>	1975-1979	L4-1.8L	FORD COURIER
	1977-1978	L4-1.8L	MAZDA B1800
	1979-1982	L4-2.0L	FORD COURIER
	1979-1982	L4-2.0L	MAZDA 626
	1979-1984	L4-2.0L	MAZDA B2000
<b>US1044</b>	1962-1966	L6-2.4L	FORD CLUB WAGON
	1960-1964	L6-2.4L	FORD COUNTRY SEDAN
	1960-1964	L6-2.4L	FORD COUNTRY SQUIRE
	1961-1965	L6-2.4L	FORD ECONOLINE
	1960-1964	L6-2.4L	FORD FALCON
	1961-1964	L6-2.4L	FORD FALCON SEDAN DELIVERY
	1960-1964	L6-2.4L	FORD P-100
	1960-1964	L6-2.4L	FORD RANCH WAGON
	1960-1964	L6-2.4L	FORD RANCHERO
	1962-1964	L6-2.4L	FORD STATION BUS
	1960-1963	L6-2.4L	MERCURY COMET
	1962-1963	L6-2.4L	MERCURY VILLAGER
	1966-1972	L6-2.8L	FORD BRONCO
	1962-1967	L6-2.8L	FORD CLUB WAGON
	1960-1969	L6-2.8L	FORD COUNTRY SEDAN
	1960-1969	L6-2.8L	FORD COUNTRY SQUIRE
	1968-1971	L6-2.8L	FORD E-100 ECONOLINE
	1968-1971	L6-2.8L	FORD E-200 ECONOLINE

USMW	Years	Cyl.	Specifications
	1969-1970	L6-2.8L	FORD E-300 ECONOLINE
	1962-1966	L6-2.8L	FORD ECONOLINE
	1962-1966	L6-2.8L	FORD FAIRLANE
	1960-1969	L6-2.8L	FORD FALCON
	1961-1965	L6-2.8L	FORD FALCON SEDAN DELIVERY
	1969-1972	L6-2.8L	FORD MAVERICK
	1964-1965	L6-2.8L	FORD MUSTANG
	1961-1970	L6-2.8L	FORD P-100
	1961-1970	L6-2.8L	FORD P-350
	1960-1969	L6-2.8L	FORD RANCH WAGON
	1961-1965	L6-2.8L	FORD RANCHERO
	1963-1964	L6-2.8L	FORD SPRINT
	1965	L6-2.8L	FORD STATION BUS
	1961-1972	L6-2.8L	MERCURY COMET
	1961-1963	L6-2.8L	MERCURY METEOR
	1962-1967	L6-2.8L	MERCURY VILLAGER
	1966-1967	L6-2.8L	MERCURY VOYAGER
	1973-1974	L6-3.3L	FORD BRONCO
	1963-1967	L6-3.3L	FORD CLUB WAGON
	1963-1970	L6-3.3L	FORD COUNTRY SEDAN
	1963-1970	L6-3.3L	FORD COUNTRY SQUIRE
	1963-1969	L6-3.3L	FORD FAIRLANE
	1963-1970	L6-3.3L	FORD FALCON
	1963-1965	L6-3.3L	FORD FALCON SEDAN DELIVERY
	1963	L6-3.3L	FORD FORD 300
	1963	L6-3.3L	FORD GALAXIE
	1963	L6-3.3L	FORD GALAXIE 500
	1975	L6-3.3L	FORD GRANADA
	1969-1974	L6-3.3L	FORD MAVERICK
	1964-1970	L6-3.3L	FORD MUSTANG
	1963-1970	L6-3.3L	FORD RANCH WAGON
	1964-1968	L6-3.3L	FORD RANCHERO
	1963-1964	L6-3.3L	FORD SPRINT
	1963	L6-3.3L	FORD SUNLINER
	1968	L6-3.3L	FORD TORINO
	1963	L6-3.3L	FORD VICTORIA
	1964-1967	L6-3.3L	MERCURY CALIENTE
	1963-1975	L6-3.3L	MERCURY COMET
	1963	L6-3.3L	MERCURY COUNTRY CRUISER
	1964	L6-3.3L	MERCURY CYCLONE
	1963	L6-3.3L	MERCURY METEOR
	1975	L6-3.3L	MERCURY MONARCH
	1968	L6-3.3L	MERCURY MONTEGO
	1963-1967	L6-3.3L	MERCURY VILLAGER
	1966-1967	L6-3.3L	MERCURY VOYAGER
<b>US1045</b>	1975	V8-7.5L	BUICK ELECTRA
	1975	V8-7.5L	BUICK ESTATE WAGON
	1975	V8-7.5L	BUICK LESABRE
	1975	V8-7.5L	BUICK RIVIERA
<b>US1047</b>	1979	V6-2.8L	FORD MUSTANG
	1975-1978	V6-2.8L	FORD MUSTANG II
	1975-1979	V6-2.8L	FORD PINTO
	1975-1979	V6-2.8L	MERCURY BOBCAT
	1979	V6-2.8L	MERCURY CAPRI
<b>US1053</b>	1988-1991	V6-3.9L	DODGE B150
	1988-1991	V6-3.9L	DODGE B250
	1988-1989	V6-3.9L	DODGE D100
	1988-1991	V6-3.9L	DODGE D150
	1988-1991	V6-3.9L	DODGE D250
	1987-1991	V6-3.9L	DODGE DAKOTA
	1989	V6-3.9L	DODGE W100
	1989-1991	V6-3.9L	DODGE W150
	1975-1983	V8-5.2L	CHRYSLER CORDOBA
	1983-1989	V8-5.2L	CHRYSLER FIFTH AVENUE
	1981-1982	V8-5.2L	CHRYSLER IMPERIAL
	1977-1981	V8-5.2L	CHRYSLER LEBARON
	1979-1982	V8-5.2L	CHRYSLER NEW YORKER
	1979-1981	V8-5.2L	CHRYSLER NEWPORT
	1978-1981	V8-5.2L	CHRYSLER TOWN & COUNTRY

USMW	Years	Cyl.	Specifications
1976-1980	V8-5.2L	DODGE ASPEN	
1975-1980	V8-5.2L	DODGE B100	
1981-1991	V8-5.2L	DODGE B150	
1975-1980	V8-5.2L	DODGE B200	
1981-1991	V8-5.2L	DODGE B250	
1975-1980	V8-5.2L	DODGE B300	
1981-1991	V8-5.2L	DODGE B350	
1980	V8-5.2L	DODGE CB300	
1975-1978	V8-5.2L	DODGE CHARGER	
1970-1971	V8-5.2L	DODGE CHARGER (MEX)	
1975-1976	V8-5.2L	DODGE CORONET	
1970-1971	V8-5.2L	DODGE CORONET (MEX)	
1975-1989	V8-5.2L	DODGE D100	
1977-1991	V8-5.2L	DODGE D150	
1975-1980	V8-5.2L	DODGE D200	
1981-1991	V8-5.2L	DODGE D250	
1975-1980	V8-5.2L	DODGE D300	
1981-1983	V8-5.2L	DODGE D350	
1980-1982	V8-5.2L	DODGE D350 (MEX)	
1989	V8-5.2L	DODGE DAKOTA	
1975-1976	V8-5.2L	DODGE DART	
1977-1989	V8-5.2L	DODGE DIPLOMAT	
1978-1979	V8-5.2L	DODGE MAGNUM	
1980-1983	V8-5.2L	DODGE MIRADA	
1975-1978	V8-5.2L	DODGE MONACO	
1970-1974	V8-5.2L	DODGE MONACO (MEX)	
1975-1991	V8-5.2L	DODGE RAMCHARGER	
1980	V8-5.2L	DODGE RD200	
1975-1977	V8-5.2L	DODGE ROYAL MONACO	
1979-1981	V8-5.2L	DODGE ST. REGIS	
1975-1989	V8-5.2L	DODGE W100	
1977-1991	V8-5.2L	DODGE W150	
1975-1980	V8-5.2L	DODGE W200	
1981-1991	V8-5.2L	DODGE W250	
1975-1980	V8-5.2L	DODGE W300	
1982-1983	V8-5.2L	DODGE W350	
1975-1976	V8-5.2L	PLYMOUTH DUSTER	
1975-1978	V8-5.2L	PLYMOUTH FURY	
1975-1989	V8-5.2L	PLYMOUTH GRAN FURY	
1975-1980	V8-5.2L	PLYMOUTH PB100	
1981-1983	V8-5.2L	PLYMOUTH PB150	
1975-1980	V8-5.2L	PLYMOUTH PB200	
1981-1983	V8-5.2L	PLYMOUTH PB250	
1975-1980	V8-5.2L	PLYMOUTH PB300	
1981-1983	V8-5.2L	PLYMOUTH PB350	
1975-1976	V8-5.2L	PLYMOUTH SCAMP	
1975-1981	V8-5.2L	PLYMOUTH TRAILDUSTER	
1975-1976	V8-5.2L	PLYMOUTH VALIANT	
1970-1975	V8-5.2L	PLYMOUTH VALIANT (MEX)	
1976-1980	V8-5.2L	PLYMOUTH VOLARE	
1975-1979	V8-5.9L	CHRYSLER CORDOBA	
1980-1982	V8-5.9L	CHRYSLER CORDOBA (MEX)	
1978-1979	V8-5.9L	CHRYSLER LEBARON	
1977-1982	V8-5.9L	CHRYSLER LEBARON (MEX)	
1977-1980	V8-5.9L	CHRYSLER NEW YORKER	
1975-1980	V8-5.9L	CHRYSLER NEWPORT	
1978-1979	V8-5.9L	CHRYSLER TOWN & COUNTRY	
1976-1980	V8-5.9L	DODGE ASPEN	
1976-1978	V8-5.9L	DODGE B100	
1975-1980	V8-5.9L	DODGE B200	
1981-1992	V8-5.9L	DODGE B250	
1975-1980	V8-5.9L	DODGE B300	
1981-1992	V8-5.9L	DODGE B350	
1980	V8-5.9L	DODGE CB300	
1975-1978	V8-5.9L	DODGE CHARGER	
1972	V8-5.9L	DODGE CHARGER (MEX)	
1975-1976	V8-5.9L	DODGE CORONET	
1975-1988	V8-5.9L	DODGE D100	
1977-1991	V8-5.9L	DODGE D150	

USMW	Years	Cyl.	Specifications
1980-1990	V8-5.9L	DODGE D150 (MEX)	
1975-1980	V8-5.9L	DODGE D200	
1981-1992	V8-5.9L	DODGE D250	
1989-1990	V8-5.9L	DODGE D250 (MEX)	
1975-1980	V8-5.9L	DODGE D300	
1981-1992	V8-5.9L	DODGE D350	
1980-1990	V8-5.9L	DODGE D350 (MEX)	
1980-1981	V8-5.9L	DODGE D400	
1980-1981	V8-5.9L	DODGE D450	
1975-1976	V8-5.9L	DODGE DART	
1977-1982	V8-5.9L	DODGE DART (MEX)	
1978-1979	V8-5.9L	DODGE DIPLOMAT	
1978-1979	V8-5.9L	DODGE MAGNUM	
1980-1982	V8-5.9L	DODGE MAGNUM (MEX)	
1988-1991	V8-5.9L	DODGE MICROBUS (MEX)	
1980	V8-5.9L	DODGE MIRADA	
1975-1978	V8-5.9L	DODGE MONACO	
1972-1973	V8-5.9L	DODGE MONACO (MEX)	
1975-1992	V8-5.9L	DODGE RAMCHARGER	
1980-1990	V8-5.9L	DODGE RAMCHARGER (MEX)	
1980	V8-5.9L	DODGE RD200	
1975-1977	V8-5.9L	DODGE ROYAL MONACO	
1979-1980	V8-5.9L	DODGE ST. REGIS	
1975-1988	V8-5.9L	DODGE W100	
1977-1991	V8-5.9L	DODGE W150	
1975-1980	V8-5.9L	DODGE W200	
1981-1992	V8-5.9L	DODGE W250	
1989-1990	V8-5.9L	DODGE W250 (MEX)	
1975-1980	V8-5.9L	DODGE W300	
1981-1992	V8-5.9L	DODGE W350	
1975-1976	V8-5.9L	PLYMOUTH DUSTER	
1975-1978	V8-5.9L	PLYMOUTH FURY	
1975-1980	V8-5.9L	PLYMOUTH GRAN FURY	
1976-1978	V8-5.9L	PLYMOUTH PB100	
1975-1980	V8-5.9L	PLYMOUTH PB200	
1981	V8-5.9L	PLYMOUTH PB250	
1975-1980	V8-5.9L	PLYMOUTH PB300	
1981-1983	V8-5.9L	PLYMOUTH PB350	
1975-1981	V8-5.9L	PLYMOUTH TRAILDUSTER	
1976	V8-5.9L	PLYMOUTH VALIANT	
1974-1979	V8-5.9L	PLYMOUTH VALIANT (MEX)	
1976-1980	V8-5.9L	PLYMOUTH VOLARE	
<b>US1053H</b> 1988-1991	V6-3.9L	DODGE B150	
1988-1991	V6-3.9L	DODGE B250	
1988-1989	V6-3.9L	DODGE D100	
1988-1991	V6-3.9L	DODGE D150	
1988-1991	V6-3.9L	DODGE D250	
1987-1991	V6-3.9L	DODGE DAKOTA	
1989	V6-3.9L	DODGE W100	
1989-1991	V6-3.9L	DODGE W150	
1975-1983	V8-5.2L	CHRYSLER CORDOBA	
1983-1989	V8-5.2L	CHRYSLER FIFTH AVENUE	
1981-1982	V8-5.2L	CHRYSLER IMPERIAL	
1977-1981	V8-5.2L	CHRYSLER LEBARON	
1979-1982	V8-5.2L	CHRYSLER NEW YORKER	
1979-1981	V8-5.2L	CHRYSLER NEWPORT	
1978-1981	V8-5.2L	CHRYSLER TOWN & COUNTRY	
1976-1980	V8-5.2L	DODGE ASPEN	
1975-1980	V8-5.2L	DODGE B100	
1981-1991	V8-5.2L	DODGE B150	
1975-1980	V8-5.2L	DODGE B200	
1981-1991	V8-5.2L	DODGE B250	
1975-1980	V8-5.2L	DODGE B300	
1981-1991	V8-5.2L	DODGE B350	
1980	V8-5.2L	DODGE CB300	
1975-1978	V8-5.2L	DODGE CHARGER	
1970-1971	V8-5.2L	DODGE CHARGER (MEX)	
1975-1976	V8-5.2L	DODGE CORONET	
1970-1971	V8-5.2L	DODGE CORONET (MEX)	



USMW	Years	Cyl.	Specifications	USMW	Years	Cyl.	Specifications
	1975-1989	V8-5.2L	<b>DODGE D100</b>		1978-1979	V8-5.9L	<b>DODGE MAGNUM</b>
	1977-1991	V8-5.2L	<b>DODGE D150</b>		1980-1982	V8-5.9L	<b>DODGE MAGNUM (MEX)</b>
	1975-1980	V8-5.2L	<b>DODGE D200</b>		1988-1991	V8-5.9L	<b>DODGE MICROBUS (MEX)</b>
	1981-1991	V8-5.2L	<b>DODGE D250</b>		1980	V8-5.9L	<b>DODGE MIRADA</b>
	1975-1980	V8-5.2L	<b>DODGE D300</b>		1975-1978	V8-5.9L	<b>DODGE MONACO</b>
	1981-1983	V8-5.2L	<b>DODGE D350</b>		1972-1973	V8-5.9L	<b>DODGE MONACO (MEX)</b>
	1980-1982	V8-5.2L	<b>DODGE D350 (MEX)</b>		1975-1992	V8-5.9L	<b>DODGE RAMCHARGER</b>
	1989	V8-5.2L	<b>DODGE DAKOTA</b>		1980-1990	V8-5.9L	<b>DODGE RAMCHARGER (MEX)</b>
	1975-1976	V8-5.2L	<b>DODGE DART</b>		1980	V8-5.9L	<b>DODGE RD200</b>
	1977-1989	V8-5.2L	<b>DODGE DIPLOMAT</b>		1975-1977	V8-5.9L	<b>DODGE ROYAL MONACO</b>
	1978-1979	V8-5.2L	<b>DODGE MAGNUM</b>		1979-1980	V8-5.9L	<b>DODGE ST. REGIS</b>
	1980-1983	V8-5.2L	<b>DODGE MIRADA</b>		1975-1988	V8-5.9L	<b>DODGE W100</b>
	1975-1978	V8-5.2L	<b>DODGE MONACO</b>		1977-1991	V8-5.9L	<b>DODGE W150</b>
	1970-1973	V8-5.2L	<b>DODGE MONACO (MEX)</b>		1975-1980	V8-5.9L	<b>DODGE W200</b>
	1975-1991	V8-5.2L	<b>DODGE RAMCHARGER</b>		1981-1992	V8-5.9L	<b>DODGE W250</b>
	1980	V8-5.2L	<b>DODGE RD200</b>		1989-1990	V8-5.9L	<b>DODGE W250 (MEX)</b>
	1975-1977	V8-5.2L	<b>DODGE ROYAL MONACO</b>		1975-1980	V8-5.9L	<b>DODGE W300</b>
	1979-1981	V8-5.2L	<b>DODGE ST. REGIS</b>		1981-1992	V8-5.9L	<b>DODGE W350</b>
	1975-1989	V8-5.2L	<b>DODGE W100</b>		1975-1976	V8-5.9L	<b>PLYMOUTH DUSTER</b>
	1977-1991	V8-5.2L	<b>DODGE W150</b>		1975-1978	V8-5.9L	<b>PLYMOUTH FURY</b>
	1975-1980	V8-5.2L	<b>DODGE W200</b>		1975-1980	V8-5.9L	<b>PLYMOUTH GRAN FURY</b>
	1981-1991	V8-5.2L	<b>DODGE W250</b>		1976-1978	V8-5.9L	<b>PLYMOUTH PB100</b>
	1975-1980	V8-5.2L	<b>DODGE W300</b>		1975-1980	V8-5.9L	<b>PLYMOUTH PB200</b>
	1982-1983	V8-5.2L	<b>DODGE W350</b>		1981	V8-5.9L	<b>PLYMOUTH PB250</b>
	1975-1976	V8-5.2L	<b>PLYMOUTH DUSTER</b>		1975-1980	V8-5.9L	<b>PLYMOUTH PB300</b>
	1975-1978	V8-5.2L	<b>PLYMOUTH FURY</b>		1981-1983	V8-5.9L	<b>PLYMOUTH PB350</b>
	1975-1989	V8-5.2L	<b>PLYMOUTH GRAN FURY</b>		1975-1981	V8-5.9L	<b>PLYMOUTH TRAILDUSTER</b>
	1975-1980	V8-5.2L	<b>PLYMOUTH PB100</b>		1976	V8-5.9L	<b>PLYMOUTH VALIANT</b>
	1981-1983	V8-5.2L	<b>PLYMOUTH PB150</b>		1974-1979	V8-5.9L	<b>PLYMOUTH VALIANT (MEX)</b>
	1975-1980	V8-5.2L	<b>PLYMOUTH PB200</b>		1976-1980	V8-5.9L	<b>PLYMOUTH VOLARE</b>
	1981-1983	V8-5.2L	<b>PLYMOUTH PB250</b>	<b>US1061</b>	1959-1964	L4-1.7L	<b>BUICK OPEL (MEX)</b>
	1975-1980	V8-5.2L	<b>PLYMOUTH PB300</b>		1965-1972	L4-2.1L	<b>BUICK OPEL (MEX)</b>
	1981-1983	V8-5.2L	<b>PLYMOUTH PB350</b>	<b>US1069</b>	1975-1976	V8-4.3L	<b>CHEVROLET MONZA</b>
	1975-1976	V8-5.2L	<b>PLYMOUTH SCAMP</b>		1976-1979	V8-5.0L	<b>CHEVROLET MONZA</b>
	1975-1981	V8-5.2L	<b>PLYMOUTH TRAILDUSTER</b>		1977-1979	V8-5.0L	<b>OLDSMOBILE STARFIRE</b>
	1975-1976	V8-5.2L	<b>PLYMOUTH VALIANT</b>		1979	V8-5.0L	<b>PONTIAC PHOENIX</b>
	1970-1975	V8-5.2L	<b>PLYMOUTH VALIANT (MEX)</b>		1979	V8-5.0L	<b>PONTIAC SUNBIRD</b>
	1976-1980	V8-5.2L	<b>PLYMOUTH VOLARE</b>		1975	V8-5.7L	<b>CHEVROLET MONZA</b>
	1975-1979	V8-5.9L	<b>CHRYSLER CORDOBA</b>	<b>US1070</b>	1975	V8-5.0L	<b>FORD MUSTANG (MEX)</b>
	1980-1982	V8-5.9L	<b>CHRYSLER CORDOBA (MEX)</b>		1975-1976	V8-5.0L	<b>FORD MUSTANG II</b>
	1978-1979	V8-5.9L	<b>CHRYSLER LEBARON</b>	<b>US1075</b>	1965-1967	V8-5.0L	<b>FORD F-350 (MEX)</b>
	1977-1982	V8-5.9L	<b>CHRYSLER LEBARON (MEX)</b>		1965-1967	V8-5.8L	<b>FORD F-350 (MEX)</b>
	1977-1980	V8-5.9L	<b>CHRYSLER NEW YORKER</b>		1975-1976	V8-5.9L	<b>FORD F-100</b>
	1975-1980	V8-5.9L	<b>CHRYSLER NEWPORT</b>		1975-1976	V8-5.9L	<b>FORD F-150</b>
	1978-1979	V8-5.9L	<b>CHRYSLER TOWN &amp; COUNTRY</b>		1975-1976	V8-5.9L	<b>FORD F-250</b>
	1976-1980	V8-5.9L	<b>DODGE ASPEN</b>		1975-1976	V8-5.9L	<b>FORD F-350</b>
	1976-1978	V8-5.9L	<b>DODGE B100</b>		1975-1976	V8-6.4L	<b>FORD F-100</b>
	1975-1980	V8-5.9L	<b>DODGE B200</b>		1975-1976	V8-6.4L	<b>FORD F-150</b>
	1981-1992	V8-5.9L	<b>DODGE B250</b>		1975-1976	V8-6.4L	<b>FORD F-250</b>
	1975-1980	V8-5.9L	<b>DODGE B300</b>		1975-1976	V8-6.4L	<b>FORD F-350</b>
	1981-1992	V8-5.9L	<b>DODGE B350</b>	<b>US1075H</b>	1975-1976	V8-5.9L	<b>FORD F-100</b>
	1980	V8-5.9L	<b>DODGE CB300</b>		1975-1976	V8-5.9L	<b>FORD F-150</b>
	1975-1978	V8-5.9L	<b>DODGE CHARGER</b>		1975-1976	V8-5.9L	<b>FORD F-250</b>
	1972	V8-5.9L	<b>DODGE CHARGER (MEX)</b>		1975-1976	V8-5.9L	<b>FORD F-350</b>
	1975-1976	V8-5.9L	<b>DODGE CORONET</b>		1975-1976	V8-6.4L	<b>FORD F-100</b>
	1975-1988	V8-5.9L	<b>DODGE D100</b>		1975-1976	V8-6.4L	<b>FORD F-150</b>
	1977-1991	V8-5.9L	<b>DODGE D150</b>		1975-1976	V8-6.4L	<b>FORD F-250</b>
	1980-1990	V8-5.9L	<b>DODGE D150 (MEX)</b>		1975-1976	V8-6.4L	<b>FORD F-350</b>
	1975-1980	V8-5.9L	<b>DODGE D200</b>	<b>US1077</b>	1978-1979	L6-3.8L	<b>AMERICAN MOTORS CONCORD</b>
	1981-1992	V8-5.9L	<b>DODGE D250</b>		1975-1978	L6-3.8L	<b>AMERICAN MOTORS GREMLIN</b>
	1989-1990	V8-5.9L	<b>DODGE D250 (MEX)</b>		1975-1977	L6-3.8L	<b>AMERICAN MOTORS HORNET</b>
	1975-1980	V8-5.9L	<b>DODGE D300</b>		1975-1978	L6-3.8L	<b>AMERICAN MOTORS PACER</b>
	1981-1992	V8-5.9L	<b>DODGE D350</b>		1979	L6-3.8L	<b>AMERICAN MOTORS SPIRIT</b>
	1980-1990	V8-5.9L	<b>DODGE D350 (MEX)</b>		1976-1978	L6-3.8L	<b>JEEP CJ7</b>
	1980-1981	V8-5.9L	<b>DODGE D400</b>		1975	L6-3.8L	<b>JEEP CJ7 (MEX)</b>
	1980-1981	V8-5.9L	<b>DODGE D450</b>		1978-1979	L6-4.2L	<b>AMERICAN MOTORS AMERICAN (MEX)</b>
	1975-1976	V8-5.9L	<b>DODGE DART</b>		1978-1979	L6-4.2L	<b>AMERICAN MOTORS AMX</b>
	1977-1982	V8-5.9L	<b>DODGE DART (MEX)</b>		1978-1979	L6-4.2L	<b>AMERICAN MOTORS CONCORD</b>
	1978-1979	V8-5.9L	<b>DODGE DIPLOMAT</b>		1975-1978	L6-4.2L	<b>AMERICAN MOTORS GREMLIN</b>



# WATER PUMP BUYER'S GUIDE

**USMW**  
Professional Series

USMW	Years	Cyl.	Specifications
	1975-1979	L6-4.2L	AMERICAN MOTORS GREMLIN (MEX)
	1975-1977	L6-4.2L	AMERICAN MOTORS HORNET
	1975-1978	L6-4.2L	AMERICAN MOTORS MATADOR
	1975-1979	L6-4.2L	AMERICAN MOTORS PACER
	1979	L6-4.2L	AMERICAN MOTORS SPIRIT
	1975-1979	L6-4.2L	JEEP CHEROKEE
	1976-1979	L6-4.2L	JEEP CJ7
	1975-1978	L6-4.2L	JEEP CJ7 (MEX)
	1975-1979	L6-4.2L	JEEP J10
	1976	L6-4.2L	JEEP J20
	1975-1979	L6-4.6L	AMERICAN MOTORS AMERICAN (MEX)
	1975-1976	L6-4.6L	AMERICAN MOTORS CLASSIC (MEX)
	1979	L6-4.6L	AMERICAN MOTORS GREMLIN (MEX)
	1975-1979	L6-4.6L	AMERICAN MOTORS PACER (MEX)
	1973-1983	L6-4.6L	JEEP CJ5D (MEX)
	1974-1983	L6-4.6L	JEEP CJ7 (MEX)
	1980-1983	L6-4.6L	JEEP J100 (MEX)
	1973-1983	L6-4.6L	JEEP J164 (MEX)
	1973-1983	L6-4.6L	JEEP J164V (MEX)
	1973-1979	L6-4.6L	JEEP J364R (MEX)
	1976-1979	L6-4.6L	JEEP WAGONEER (MEX)
<b>US1088</b>	1975	L4-2.3L	CHEVROLET MONZA
	1975	L4-2.3L	CHEVROLET VEGA
	1975	L4-2.3L	PONTIAC ASTRE
<b>US1099</b>	1966-1967	L4-2.5L	INTERNATIONAL 900A
	1966-1967	L4-2.5L	INTERNATIONAL M SERIES VAN
	1966-1971	L4-2.5L	INTERNATIONAL M1100
	1966-1971	L4-2.5L	INTERNATIONAL M1200
	1966-1971	L4-2.5L	INTERNATIONAL M800
	1966-1971	L4-2.5L	INTERNATIONAL SCOUT
	1971	L4-2.5L	INTERNATIONAL SCOUT II
	1966	L6-4.3L	INTERNATIONAL 1000A
	1967-1969	L6-4.3L	INTERNATIONAL 1000B
	1968-1969	L6-4.3L	INTERNATIONAL 1000C
	1969-1970	L6-4.3L	INTERNATIONAL 1000D
	1966	L6-4.3L	INTERNATIONAL 1100A
	1967-1969	L6-4.3L	INTERNATIONAL 1100B
	1968-1969	L6-4.3L	INTERNATIONAL 1100C
	1969-1970	L6-4.3L	INTERNATIONAL 1100D
	1966	L6-4.3L	INTERNATIONAL 1200A
	1967-1969	L6-4.3L	INTERNATIONAL 1200B
	1968-1969	L6-4.3L	INTERNATIONAL 1200C
	1969-1970	L6-4.3L	INTERNATIONAL 1200D
	1966	L6-4.3L	INTERNATIONAL 1300A
	1967-1969	L6-4.3L	INTERNATIONAL 1300B
	1968-1969	L6-4.3L	INTERNATIONAL 1300C
	1970	L6-4.3L	INTERNATIONAL 1300D
	1966-1970	L6-4.3L	INTERNATIONAL M1100
	1966-1970	L6-4.3L	INTERNATIONAL M1200
	1966-1967	L6-4.3L	INTERNATIONAL M1400
	1969-1970	L6-4.3L	INTERNATIONAL SCOUT
	1971-1972	V8-4.3L	INTERNATIONAL 1110
	1971-1972	V8-4.3L	INTERNATIONAL 1310
	1966	V8-4.3L	INTERNATIONAL 1000A
	1967-1969	V8-4.3L	INTERNATIONAL 1000B
	1968-1969	V8-4.3L	INTERNATIONAL 1000C
	1969-1970	V8-4.3L	INTERNATIONAL 1000D
	1966	V8-4.3L	INTERNATIONAL 1100A
	1967-1969	V8-4.3L	INTERNATIONAL 1100B
	1968-1969	V8-4.3L	INTERNATIONAL 1100C
	1969-1970	V8-4.3L	INTERNATIONAL 1100D
	1966	V8-4.3L	INTERNATIONAL 1200A
	1967-1969	V8-4.3L	INTERNATIONAL 1200B
	1968-1969	V8-4.3L	INTERNATIONAL 1200C
	1969-1970	V8-4.3L	INTERNATIONAL 1200D
	1966	V8-4.3L	INTERNATIONAL 1300A
	1967-1969	V8-4.3L	INTERNATIONAL 1300B
	1968-1969	V8-4.3L	INTERNATIONAL 1300C
	1970	V8-4.3L	INTERNATIONAL 1300D

USMW	Years	Cyl.	Specifications
	1967-1969	V8-4.3L	INTERNATIONAL 908B
	1968-1969	V8-4.3L	INTERNATIONAL 908C
	1972	V8-4.3L	INTERNATIONAL DM10
	1966-1970	V8-4.3L	INTERNATIONAL M1100
	1966-1970	V8-4.3L	INTERNATIONAL M1200
	1966-1967	V8-4.3L	INTERNATIONAL M1400
	1967-1970	V8-4.3L	INTERNATIONAL MA1200
	1966-1968	V8-4.3L	INTERNATIONAL SCOUT
	1974	V8-5.0L	INTERNATIONAL 100
	1975	V8-5.0L	INTERNATIONAL 150
	1974-1975	V8-5.0L	INTERNATIONAL 200
	1971-1973	V8-5.0L	INTERNATIONAL 1010
	1971-1973	V8-5.0L	INTERNATIONAL 1110
	1971-1973	V8-5.0L	INTERNATIONAL 1210
	1971-1973	V8-5.0L	INTERNATIONAL 1310
	1966	V8-5.0L	INTERNATIONAL 1000A
	1967-1969	V8-5.0L	INTERNATIONAL 1000B
	1968-1969	V8-5.0L	INTERNATIONAL 1000C
	1969-1970	V8-5.0L	INTERNATIONAL 1000D
	1966	V8-5.0L	INTERNATIONAL 1100A
	1967-1969	V8-5.0L	INTERNATIONAL 1100B
	1968-1969	V8-5.0L	INTERNATIONAL 1100C
	1969-1970	V8-5.0L	INTERNATIONAL 1100D
	1966	V8-5.0L	INTERNATIONAL 1200A
	1967-1969	V8-5.0L	INTERNATIONAL 1200B
	1968-1969	V8-5.0L	INTERNATIONAL 1200C
	1969-1970	V8-5.0L	INTERNATIONAL 1200D
	1966	V8-5.0L	INTERNATIONAL 1300A
	1967-1969	V8-5.0L	INTERNATIONAL 1300B
	1968-1969	V8-5.0L	INTERNATIONAL 1300C
	1969-1970	V8-5.0L	INTERNATIONAL 1300D
	1967-1969	V8-5.0L	INTERNATIONAL 908B
	1968-1969	V8-5.0L	INTERNATIONAL 908C
	1972	V8-5.0L	INTERNATIONAL DM10
	1966-1972	V8-5.0L	INTERNATIONAL M1100
	1969-1972	V8-5.0L	INTERNATIONAL M1200
	1966-1969	V8-5.0L	INTERNATIONAL M1400
	1969-1971	V8-5.0L	INTERNATIONAL M800
	1967-1971	V8-5.0L	INTERNATIONAL MA1200
	1974	V8-5.0L	INTERNATIONAL MHC1310
	1972-1974	V8-5.0L	INTERNATIONAL MS1210
	1969-1970	V8-5.0L	INTERNATIONAL SCOUT
	1971-1975	V8-5.0L	INTERNATIONAL SCOUT II
	1975	V8-5.0L	INTERNATIONAL TRAVELALL
	1974	V8-5.6L	INTERNATIONAL 100
	1975	V8-5.6L	INTERNATIONAL 150
	1974-1975	V8-5.6L	INTERNATIONAL 200
	1971-1973	V8-5.6L	INTERNATIONAL 1010
	1971-1973	V8-5.6L	INTERNATIONAL 1110
	1971-1973	V8-5.6L	INTERNATIONAL 1210
	1971-1973	V8-5.6L	INTERNATIONAL 1310
	1967-1969	V8-5.6L	INTERNATIONAL 1000B
	1968-1969	V8-5.6L	INTERNATIONAL 1000C
	1969-1970	V8-5.6L	INTERNATIONAL 1000D
	1967-1969	V8-5.6L	INTERNATIONAL 1100B
	1968-1969	V8-5.6L	INTERNATIONAL 1100C
	1969-1970	V8-5.6L	INTERNATIONAL 1100D
	1967-1969	V8-5.6L	INTERNATIONAL 1200B
	1968-1969	V8-5.6L	INTERNATIONAL 1200C
	1969-1970	V8-5.6L	INTERNATIONAL 1200D
	1967-1969	V8-5.6L	INTERNATIONAL 1300B
	1968-1969	V8-5.6L	INTERNATIONAL 1300C
	1969-1970	V8-5.6L	INTERNATIONAL 1300D
	1972	V8-5.6L	INTERNATIONAL DM10
	1975	V8-5.6L	INTERNATIONAL MS
	1972-1974	V8-5.6L	INTERNATIONAL MS1210
	1971-1975	V8-5.6L	INTERNATIONAL SCOUT II
	1975	V8-5.6L	INTERNATIONAL TRAVELALL
	1971-1973	V8-5.7L	INTERNATIONAL 1010

USMW	Years	Cyl.	Specifications
	1971-1973	V8-5.7L	INTERNATIONAL 1110
	1971-1973	V8-5.7L	INTERNATIONAL 1210
	1971-1973	V8-5.7L	INTERNATIONAL 1310
	1972-1974	V8-5.7L	INTERNATIONAL SCOUT II
	1974	V8-6.4L	INTERNATIONAL 100
	1975	V8-6.4L	INTERNATIONAL 150
	1974-1975	V8-6.4L	INTERNATIONAL 200
	1971-1973	V8-6.4L	INTERNATIONAL 1010
	1971-1973	V8-6.4L	INTERNATIONAL 1110
	1971-1973	V8-6.4L	INTERNATIONAL 1210
	1971-1973	V8-6.4L	INTERNATIONAL 1310
	1968-1969	V8-6.4L	INTERNATIONAL 1000B
	1968-1969	V8-6.4L	INTERNATIONAL 1000C
	1969-1970	V8-6.4L	INTERNATIONAL 1000D
	1968-1969	V8-6.4L	INTERNATIONAL 1100B
	1968-1969	V8-6.4L	INTERNATIONAL 1100C
	1969-1970	V8-6.4L	INTERNATIONAL 1100D
	1968-1969	V8-6.4L	INTERNATIONAL 1200B
	1968-1969	V8-6.4L	INTERNATIONAL 1200C
	1969-1970	V8-6.4L	INTERNATIONAL 1200D
	1968-1969	V8-6.4L	INTERNATIONAL 1300B
	1968-1969	V8-6.4L	INTERNATIONAL 1300C
	1969-1970	V8-6.4L	INTERNATIONAL 1300D
	1972	V8-6.4L	INTERNATIONAL DM10
	1975	V8-6.4L	INTERNATIONAL MS
	1972-1974	V8-6.4L	INTERNATIONAL MS1210
	1974-1975	V8-6.4L	INTERNATIONAL SCOUT II
	1975	V8-6.4L	INTERNATIONAL TRAVELALL
<b>US1100</b>	1975	V8-4.3L	BUICK APOLLO
	1975-1976	V8-4.3L	BUICK SKYLARK
	1975-1981	V8-4.3L	OLDSMOBILE CUTLASS
	1978-1982	V8-4.3L	OLDSMOBILE CUTLASS CALAIS
	1980-1982	V8-4.3L	OLDSMOBILE CUTLASS CRUISER
	1975-1981	V8-4.3L	OLDSMOBILE CUTLASS SALON
	1980-1982	V8-4.3L	OLDSMOBILE CUTLASS SUPREME
	1976	V8-4.3L	OLDSMOBILE CUTLASS TIARA
	1977-1982	V8-4.3L	OLDSMOBILE DELTA 88
	1975-1977	V8-4.3L	OLDSMOBILE OMEGA
	1976	V8-4.3L	PONTIAC LEMANS
	1975-1976	V8-4.3L	PONTIAC VENTURA
	1981-1985	V8-5.0L	BUICK ELECTRA
	1981-1983	V8-5.0L	BUICK ESTATE WAGON
	1981-1985	V8-5.0L	BUICK LESABRE
	1980-1985	V8-5.0L	BUICK RIVIERA
	1980-1981	V8-5.0L	OLDSMOBILE 98
	1980-1985	V8-5.0L	OLDSMOBILE CUSTOM CRUISER
	1982-1984	V8-5.0L	OLDSMOBILE CUTLASS CALAIS
	1981-1983	V8-5.0L	OLDSMOBILE CUTLASS CRUISER
	1985-1986	V8-5.0L	OLDSMOBILE CUTLASS SALON
	1982-1984	V8-5.0L	OLDSMOBILE CUTLASS SUPREME
	1980-1985	V8-5.0L	OLDSMOBILE DELTA 88
	1980-1981	V8-5.0L	OLDSMOBILE TORONADO
	1981	V8-5.0L	PONTIAC BONNEVILLE
	1981	V8-5.0L	PONTIAC CATALINA
	1975	V8-5.7L	BUICK APOLLO
	1975-1981	V8-5.7L	BUICK CENTURY
	1976-1985	V8-5.7L	BUICK ELECTRA
	1977-1983	V8-5.7L	BUICK ESTATE WAGON
	1975-1985	V8-5.7L	BUICK LESABRE
	1975-1983	V8-5.7L	BUICK REGAL
	1977-1985	V8-5.7L	BUICK RIVIERA
	1975-1977	V8-5.7L	BUICK SKYLARK
	1981-1983	V8-5.7L	CHEVROLET CAPRICE
	1985	V8-5.7L	CHEVROLET IMPALA
	1982-1983	V8-5.7L	CHEVROLET MALIBU
	1982-1984	V8-5.7L	CHEVROLET MONTE CARLO
	1977-1981	V8-5.7L	OLDSMOBILE 98
	1977-1985	V8-5.7L	OLDSMOBILE CUSTOM CRUISER
	1975-1981	V8-5.7L	OLDSMOBILE CUTLASS

USMW	Years	Cyl.	Specifications
	1979-1982	V8-5.7L	OLDSMOBILE CUTLASS CALAIS
	1980-1983	V8-5.7L	OLDSMOBILE CUTLASS CRUISER
	1975-1981	V8-5.7L	OLDSMOBILE CUTLASS SALON
	1980-1984	V8-5.7L	OLDSMOBILE CUTLASS SUPREME
	1976	V8-5.7L	OLDSMOBILE CUTLASS TIARA
	1975-1985	V8-5.7L	OLDSMOBILE DELTA 88
	1975-1979	V8-5.7L	OLDSMOBILE OMEGA
	1977-1981	V8-5.7L	OLDSMOBILE TORONADO
	1977-1984	V8-5.7L	PONTIAC BONNEVILLE
	1976-1981	V8-5.7L	PONTIAC CATALINA
	1975-1978	V8-5.7L	PONTIAC FIREBIRD
	1976-1984	V8-5.7L	PONTIAC GRAND PRIX
	1977	V8-5.7L	PONTIAC GRAND SAFARI
	1975-1979	V8-5.7L	PONTIAC LEMANS
	1977-1979	V8-5.7L	PONTIAC PHOENIX
	1977	V8-5.7L	PONTIAC VENTURA
	1977	V8-6.6L	BUICK CENTURY
	1977-1979	V8-6.6L	BUICK ELECTRA
	1977-1979	V8-6.6L	BUICK ESTATE WAGON
	1975-1978	V8-6.6L	BUICK LESABRE
	1977-1978	V8-6.6L	BUICK RIVIERA
	1975-1979	V8-6.6L	OLDSMOBILE 98
	1975-1979	V8-6.6L	OLDSMOBILE CUSTOM CRUISER
	1977	V8-6.6L	OLDSMOBILE CUTLASS
	1977	V8-6.6L	OLDSMOBILE CUTLASS SALON
	1975-1979	V8-6.6L	OLDSMOBILE DELTA 88
	1977-1978	V8-6.6L	OLDSMOBILE TORONADO
	1975-1979	V8-6.6L	PONTIAC BONNEVILLE
	1975-1979	V8-6.6L	PONTIAC CATALINA
	1975-1979	V8-6.6L	PONTIAC FIREBIRD
	1975-1977	V8-6.6L	PONTIAC GRAND PRIX
	1975-1978	V8-6.6L	PONTIAC GRAND SAFARI
	1975-1977	V8-6.6L	PONTIAC LEMANS
	1975-1976	V8-7.5L	OLDSMOBILE 98
	1975-1976	V8-7.5L	OLDSMOBILE CUSTOM CRUISER
	1975-1976	V8-7.5L	OLDSMOBILE CUTLASS
	1975-1976	V8-7.5L	OLDSMOBILE CUTLASS SALON
	1976	V8-7.5L	OLDSMOBILE CUTLASS TIARA
	1975-1976	V8-7.5L	OLDSMOBILE DELTA 88
	1975-1976	V8-7.5L	OLDSMOBILE TORONADO
<b>US1107</b>	1980-1982	L4-2.5L	AMERICAN MOTORS CONCORD
	1981-1983	L4-2.5L	AMERICAN MOTORS EAGLE
	1980-1982	L4-2.5L	AMERICAN MOTORS SPIRIT
	1982-1984	L4-2.5L	CHEVROLET CAMARO
	1978-1980	L4-2.5L	CHEVROLET MONZA
	1980	L4-2.5L	JEEP CJ5
	1980-1983	L4-2.5L	JEEP CJ7
	1981-1983	L4-2.5L	JEEP SCRAMBLER
	1978-1980	L4-2.5L	OLDSMOBILE STARFIRE
	1977	L4-2.5L	PONTIAC ASTRE
	1982-1984	L4-2.5L	PONTIAC FIREBIRD
	1977-1978	L4-2.5L	PONTIAC PHOENIX
	1977-1980	L4-2.5L	PONTIAC SUNBIRD
	1977	L4-2.5L	PONTIAC VENTURA
	1978-1984	L6-4.1L	CHEVROLET C10
	1979-1984	L6-4.1L	CHEVROLET C10 (MEX)
	1978-1980	L6-4.1L	CHEVROLET C10 SUBURBAN
	1975-1984	L6-4.1L	CHEVROLET C20
	1980	L6-4.1L	CHEVROLET C30
	1975-1979	L6-4.1L	CHEVROLET CAMARO
	1978	L6-4.1L	CHEVROLET CS1073 (MEX)
	1975-1977	L6-4.1L	CHEVROLET EL CAMINO
	1977-1984	L6-4.1L	CHEVROLET G10
	1975-1984	L6-4.1L	CHEVROLET G20
	1981-1984	L6-4.1L	CHEVROLET G30
	1977-1979	L6-4.1L	CHEVROLET IMPALA
	1978-1984	L6-4.1L	CHEVROLET K10
	1978-1980	L6-4.1L	CHEVROLET K10 SUBURBAN
	1980	L6-4.1L	CHEVROLET K20

**WATER PUMPS**



USMW	Years	Cyl.	Specifications
	1978-1982	L6-4.1L	CHEVROLET K5 BLAZER
	1975-1977	L6-4.1L	CHEVROLET MALIBU
	1978-1981	L6-4.1L	CHEVROLET MALIBU (MEX)
	1975-1979	L6-4.1L	CHEVROLET NOVA
	1978	L6-4.1L	GMC C15
	1978	L6-4.1L	GMC C15 SUBURBAN
	1979-1984	L6-4.1L	GMC C1500
	1980-1984	L6-4.1L	GMC C1500 (MEX)
	1979-1980	L6-4.1L	GMC C1500 SUBURBAN
	1977-1978	L6-4.1L	GMC C25
	1979-1984	L6-4.1L	GMC C2500
	1980	L6-4.1L	GMC C3500
	1978	L6-4.1L	GMC G15
	1979-1984	L6-4.1L	GMC G1500
	1978	L6-4.1L	GMC G25
	1979-1984	L6-4.1L	GMC G2500
	1979-1984	L6-4.1L	GMC G3500
	1978-1982	L6-4.1L	GMC JIMMY
	1978	L6-4.1L	GMC K15
	1978	L6-4.1L	GMC K15 SUBURBAN
	1979-1984	L6-4.1L	GMC K1500
	1979-1980	L6-4.1L	GMC K1500 SUBURBAN
	1980	L6-4.1L	GMC K2500
	1977	L6-4.1L	GMC SPRINT
	1975-1976	L6-4.1L	OLDSMOBILE CUTLASS
	1975-1976	L6-4.1L	OLDSMOBILE OMEGA
	1975-1976	L6-4.1L	PONTIAC FIREBIRD
	1975-1977	L6-4.1L	PONTIAC LEMANS
	1975-1976	L6-4.1L	PONTIAC VENTURA
<b>US1109</b>	1976	V8-5.0L	CHEVROLET C10
	1976	V8-5.0L	CHEVROLET C10 SUBURBAN
	1976	V8-5.0L	CHEVROLET C20 SUBURBAN
	1976	V8-5.0L	CHEVROLET CAMARO
	1976	V8-5.0L	CHEVROLET EL CAMINO
	1976	V8-5.0L	CHEVROLET K10 SUBURBAN
	1976	V8-5.0L	CHEVROLET MALIBU
	1976	V8-5.0L	CHEVROLET MONTE CARLO
	1976	V8-5.0L	CHEVROLET NOVA
	1975	V8-5.7L	CHEVROLET BEL AIR
	1975-1976	V8-5.7L	CHEVROLET C10
	1975-1976	V8-5.7L	CHEVROLET C10 SUBURBAN
	1975-1976	V8-5.7L	CHEVROLET C20
	1975-1976	V8-5.7L	CHEVROLET C20 SUBURBAN
	1975-1976	V8-5.7L	CHEVROLET C30
	1975-1976	V8-5.7L	CHEVROLET CAMARO
	1975-1976	V8-5.7L	CHEVROLET CAPRICE
	1975-1976	V8-5.7L	CHEVROLET CS31003 (MEX)
	1975-1976	V8-5.7L	CHEVROLET EL CAMINO
	1975-1976	V8-5.7L	CHEVROLET G10
	1975-1976	V8-5.7L	CHEVROLET G20
	1975-1976	V8-5.7L	CHEVROLET G30
	1975-1976	V8-5.7L	CHEVROLET IMPALA
	1975-1976	V8-5.7L	CHEVROLET K10
	1975-1976	V8-5.7L	CHEVROLET K10 SUBURBAN
	1975-1976	V8-5.7L	CHEVROLET K20
	1975-1976	V8-5.7L	CHEVROLET K20 SUBURBAN
	1975-1976	V8-5.7L	CHEVROLET K5 BLAZER
	1975-1976	V8-5.7L	CHEVROLET MALIBU
	1975-1976	V8-5.7L	CHEVROLET MONTE CARLO
	1975-1976	V8-5.7L	CHEVROLET NOVA
	1975-1976	V8-5.7L	CHEVROLET P20
	1975-1976	V8-5.7L	CHEVROLET P30
	1975-1976	V8-5.7L	GMC C15
	1975-1976	V8-5.7L	GMC C15 SUBURBAN
	1975-1976	V8-5.7L	GMC C25
	1975-1976	V8-5.7L	GMC C25 SUBURBAN
	1975-1976	V8-5.7L	GMC G15
	1975-1976	V8-5.7L	GMC G25
	1975-1976	V8-5.7L	GMC G35

USMW	Years	Cyl.	Specifications
	1975-1976	V8-5.7L	GMC JIMMY
	1975-1976	V8-5.7L	GMC K15
	1975-1976	V8-5.7L	GMC K15 SUBURBAN
	1975-1976	V8-5.7L	GMC K25
	1975-1976	V8-5.7L	GMC K25 SUBURBAN
	1975-1976	V8-5.7L	GMC P25
	1975-1976	V8-5.7L	GMC P35
	1975	V8-6.6L	CHEVROLET BEL AIR
	1976	V8-6.6L	CHEVROLET C10
	1976	V8-6.6L	CHEVROLET C20
	1976	V8-6.6L	CHEVROLET C20 SUBURBAN
	1976	V8-6.6L	CHEVROLET C30
	1975-1976	V8-6.6L	CHEVROLET CAPRICE
	1975-1976	V8-6.6L	CHEVROLET EL CAMINO
	1976	V8-6.6L	CHEVROLET G10
	1975-1976	V8-6.6L	CHEVROLET G20
	1975-1976	V8-6.6L	CHEVROLET G30
	1975-1976	V8-6.6L	CHEVROLET IMPALA
	1975-1976	V8-6.6L	CHEVROLET K10
	1975-1976	V8-6.6L	CHEVROLET K10 SUBURBAN
	1975-1976	V8-6.6L	CHEVROLET K20
	1975-1976	V8-6.6L	CHEVROLET K20 SUBURBAN
	1975-1976	V8-6.6L	CHEVROLET K5 BLAZER
	1975-1976	V8-6.6L	CHEVROLET MALIBU
	1975-1976	V8-6.6L	CHEVROLET MONTE CARLO
	1976	V8-6.6L	CHEVROLET P30
	1976	V8-6.6L	GMC C15
	1976	V8-6.6L	GMC C25
	1976	V8-6.6L	GMC G15
	1975-1976	V8-6.6L	GMC G25
	1975-1976	V8-6.6L	GMC G35
	1975-1976	V8-6.6L	GMC JIMMY
	1975-1976	V8-6.6L	GMC K15
	1975-1976	V8-6.6L	GMC K15 SUBURBAN
	1975-1976	V8-6.6L	GMC K25
	1975-1976	V8-6.6L	GMC K25 SUBURBAN
<b>US1109H</b>	1976	V8-5.0L	CHEVROLET C10
	1976	V8-5.0L	CHEVROLET C10 SUBURBAN
	1976	V8-5.0L	CHEVROLET C20 SUBURBAN
	1976	V8-5.0L	CHEVROLET CAMARO
	1976	V8-5.0L	CHEVROLET EL CAMINO
	1976	V8-5.0L	CHEVROLET K10 SUBURBAN
	1976	V8-5.0L	CHEVROLET MALIBU
	1976	V8-5.0L	CHEVROLET MONTE CARLO
	1976	V8-5.0L	CHEVROLET NOVA
	1975	V8-5.7L	CHEVROLET BEL AIR
	1975-1976	V8-5.7L	CHEVROLET C10
	1975-1976	V8-5.7L	CHEVROLET C10 SUBURBAN
	1975-1976	V8-5.7L	CHEVROLET C20
	1975-1976	V8-5.7L	CHEVROLET C20 SUBURBAN
	1975-1976	V8-5.7L	CHEVROLET C30
	1975-1976	V8-5.7L	CHEVROLET CAMARO
	1975-1976	V8-5.7L	CHEVROLET CAPRICE
	1975-1976	V8-5.7L	CHEVROLET EL CAMINO
	1975-1976	V8-5.7L	CHEVROLET G10
	1975-1976	V8-5.7L	CHEVROLET G20
	1975-1976	V8-5.7L	CHEVROLET G30
	1975-1976	V8-5.7L	CHEVROLET IMPALA
	1975-1976	V8-5.7L	CHEVROLET K10
	1975-1976	V8-5.7L	CHEVROLET K10 SUBURBAN
	1975-1976	V8-5.7L	CHEVROLET K20
	1975-1976	V8-5.7L	CHEVROLET K20 SUBURBAN
	1975-1976	V8-5.7L	CHEVROLET K5 BLAZER
	1975-1976	V8-5.7L	CHEVROLET MALIBU
	1975-1976	V8-5.7L	CHEVROLET MONTE CARLO
	1975-1976	V8-5.7L	CHEVROLET NOVA
	1975-1976	V8-5.7L	CHEVROLET P20
	1975-1976	V8-5.7L	CHEVROLET P30
	1975-1976	V8-5.7L	GMC C15

USMW	Years	Cyl.	Specifications	USMW	Years	Cyl.	Specifications
	1975-1976	V8-5.7L	GMC C15 SUBURBAN		1975-1977	V8-7.5L	FORD RANCHERO
	1975-1976	V8-5.7L	GMC C25		1975-1976	V8-7.5L	FORD THUNDERBIRD
	1975-1976	V8-5.7L	GMC C25 SUBURBAN		1975-1976	V8-7.5L	FORD TORINO
	1975-1976	V8-5.7L	GMC G15		1975-1978	V8-7.5L	LINCOLN CONTINENTAL
	1975-1976	V8-5.7L	GMC G25		1975-1976	V8-7.5L	LINCOLN MARK IV
	1975-1976	V8-5.7L	GMC G35		1975-1976	V8-7.5L	MERCURY COUGAR
	1975-1976	V8-5.7L	GMC JIMMY		1975-1978	V8-7.5L	MERCURY MARQUIS
	1975-1976	V8-5.7L	GMC K15		1975-1976	V8-7.5L	MERCURY MONTEGO
	1975-1976	V8-5.7L	GMC K15 SUBURBAN	<b>US1120</b>	1982-1983	V6-4.3L	OLDSMOBILE CUTLASS SUPREME
	1975-1976	V8-5.7L	GMC K25		1975	V8-4.3L	BUICK APOLLO
	1975-1976	V8-5.7L	GMC K25 SUBURBAN		1975-1976	V8-4.3L	BUICK SKYLARK
	1975-1976	V8-5.7L	GMC P25		1975-1981	V8-4.3L	OLDSMOBILE CUTLASS
	1975-1976	V8-5.7L	GMC P35		1978-1982	V8-4.3L	OLDSMOBILE CUTLASS CALAIS
	1975	V8-6.6L	CHEVROLET BEL AIR		1975-1981	V8-4.3L	OLDSMOBILE CUTLASS SALON
	1976	V8-6.6L	CHEVROLET C10		1976	V8-4.3L	OLDSMOBILE CUTLASS TIARA
	1976	V8-6.6L	CHEVROLET C20		1977-1982	V8-4.3L	OLDSMOBILE DELTA 88
	1976	V8-6.6L	CHEVROLET C20 SUBURBAN		1975-1977	V8-4.3L	OLDSMOBILE OMEGA
	1976	V8-6.6L	CHEVROLET C30		1976	V8-4.3L	PONTIAC LEMANS
	1975-1976	V8-6.6L	CHEVROLET CAPRICE		1975-1976	V8-4.3L	PONTIAC VENTURA
	1975-1976	V8-6.6L	CHEVROLET EL CAMINO		1981-1987	V8-5.0L	BUICK ELECTRA
	1976	V8-6.6L	CHEVROLET G10		1981-1983	V8-5.0L	BUICK ESTATE WAGON
	1975-1976	V8-6.6L	CHEVROLET G20		1981-1985	V8-5.0L	BUICK LESABRE
	1975-1976	V8-6.6L	CHEVROLET G30		1986-1987	V8-5.0L	BUICK REGAL
	1975-1976	V8-6.6L	CHEVROLET IMPALA		1980-1985	V8-5.0L	BUICK RIVIERA
	1975-1976	V8-6.6L	CHEVROLET K10		1987-1990	V8-5.0L	CADILLAC BROUGHAM
	1975-1976	V8-6.6L	CHEVROLET K10 SUBURBAN		1986-1990	V8-5.0L	CHEVROLET CAPRICE
	1975-1976	V8-6.6L	CHEVROLET K20		1980-1984	V8-5.0L	OLDSMOBILE 98
	1975-1976	V8-6.6L	CHEVROLET K20 SUBURBAN		1980-1985	V8-5.0L	OLDSMOBILE CUSTOM CRUISER
	1975-1976	V8-6.6L	CHEVROLET K5 BLAZER		1982-1984	V8-5.0L	OLDSMOBILE CUTLASS CALAIS
	1975-1976	V8-6.6L	CHEVROLET MALIBU		1982-1983	V8-5.0L	OLDSMOBILE CUTLASS CRUISER
	1975-1976	V8-6.6L	CHEVROLET MONTE CARLO		1985-1987	V8-5.0L	OLDSMOBILE CUTLASS SALON
	1976	V8-6.6L	CHEVROLET P30		1982-1988	V8-5.0L	OLDSMOBILE CUTLASS SUPREME
	1976	V8-6.6L	GMC C15		1980-1985	V8-5.0L	OLDSMOBILE DELTA 88
	1976	V8-6.6L	GMC C25		1980-1985	V8-5.0L	OLDSMOBILE TORONADO
	1976	V8-6.6L	GMC G15		1981	V8-5.0L	PONTIAC BONNEVILLE
	1975-1976	V8-6.6L	GMC G25		1981	V8-5.0L	PONTIAC CATALINA
	1975-1976	V8-6.6L	GMC G35		1986	V8-5.0L	PONTIAC PARISIENNE
	1975-1976	V8-6.6L	GMC JIMMY		1987-1989	V8-5.0L	PONTIAC SAFARI
	1975-1976	V8-6.6L	GMC K15		1975	V8-5.7L	BUICK APOLLO
	1975-1976	V8-6.6L	GMC K15 SUBURBAN		1975-1981	V8-5.7L	BUICK CENTURY
	1975-1976	V8-6.6L	GMC K25		1976-1985	V8-5.7L	BUICK ELECTRA
	1975-1976	V8-6.6L	GMC K25 SUBURBAN		1977-1983	V8-5.7L	BUICK ESTATE WAGON
<b>US1110</b>	1977	L4-1.3L	RENAULT R5 (MEX)		1975-1990	V8-5.7L	BUICK LESABRE
	1975-1977	L6-4.1L	CHEVROLET C10		1975-1985	V8-5.7L	BUICK REGAL
	1975-1977	L6-4.1L	CHEVROLET C10 SUBURBAN		1977-1985	V8-5.7L	BUICK RIVIERA
	1975-1977	L6-4.1L	CHEVROLET CS1073 (MEX)		1975-1977	V8-5.7L	BUICK SKYLARK
	1975-1976	L6-4.1L	CHEVROLET G10		1980-1984	V8-5.7L	CADILLAC DEVILLE
	1975-1976	L6-4.1L	CHEVROLET IMPALA (MEX)		1980-1985	V8-5.7L	CADILLAC ELDORADO
	1975-1977	L6-4.1L	CHEVROLET K10		1980-1986	V8-5.7L	CADILLAC FLEETWOOD
	1975-1977	L6-4.1L	CHEVROLET K10 SUBURBAN		1980-1985	V8-5.7L	CADILLAC SEVILLE
	1975-1977	L6-4.1L	CHEVROLET K5 BLAZER		1980-1985	V8-5.7L	CHEVROLET CAPRICE
	1975-1977	L6-4.1L	GMC C15		1983-1984	V8-5.7L	CHEVROLET EL CAMINO
	1975-1977	L6-4.1L	GMC C15 SUBURBAN		1980-1985	V8-5.7L	CHEVROLET IMPALA
	1975-1977	L6-4.1L	GMC G15		1982-1983	V8-5.7L	CHEVROLET MALIBU
	1975-1977	L6-4.1L	GMC JIMMY		1982-1984	V8-5.7L	CHEVROLET MONTE CARLO
	1975-1977	L6-4.1L	GMC K15		1983-1984	V8-5.7L	GMC CABALLERO
	1975-1977	L6-4.1L	GMC K15 SUBURBAN		1977-1984	V8-5.7L	OLDSMOBILE 98
<b>US1114</b>	1975-1976	V8-7.5L	FORD CUSTOM 500		1977-1990	V8-5.7L	OLDSMOBILE CUSTOM CRUISER
	1975-1980	V8-7.5L	FORD E-250 ECONOLINE		1975-1981	V8-5.7L	OLDSMOBILE CUTLASS
	1975-1991	V8-7.5L	FORD E-250 ECONOLINE CLUB WAGON		1979-1984	V8-5.7L	OLDSMOBILE CUTLASS CALAIS
	1975-1992	V8-7.5L	FORD E-350 ECONOLINE		1980-1983	V8-5.7L	OLDSMOBILE CUTLASS CRUISER
	1977-1992	V8-7.5L	FORD E-350 ECONOLINE CLUB WAGON		1975-1985	V8-5.7L	OLDSMOBILE CUTLASS SALON
	1975-1976	V8-7.5L	FORD ELITE		1980-1985	V8-5.7L	OLDSMOBILE CUTLASS SUPREME
	1990-1992	V8-7.5L	FORD F SUPER DUTY		1976	V8-5.7L	OLDSMOBILE CUTLASS TIARA
	1975-1979	V8-7.5L	FORD F-100		1975-1985	V8-5.7L	OLDSMOBILE DELTA 88
	1975-1979	V8-7.5L	FORD F-150		1975-1979	V8-5.7L	OLDSMOBILE OMEGA
	1975-1992	V8-7.5L	FORD F-250		1977-1985	V8-5.7L	OLDSMOBILE TORONADO
	1975-1992	V8-7.5L	FORD F-350		1977-1984	V8-5.7L	PONTIAC BONNEVILLE
	1975-1978	V8-7.5L	FORD LTD		1976-1981	V8-5.7L	PONTIAC CATALINA

USMW	Years	Cyl.	Specifications
	1975-1978	V8-5.7L	PONTIAC FIREBIRD
	1976-1984	V8-5.7L	PONTIAC GRAND PRIX
	1977	V8-5.7L	PONTIAC GRAND SAFARI
	1975-1979	V8-5.7L	PONTIAC LEMANS
	1983-1985	V8-5.7L	PONTIAC PARISIENNE
	1977-1979	V8-5.7L	PONTIAC PHOENIX
	1977	V8-5.7L	PONTIAC VENTURA
	1977	V8-6.6L	BUICK CENTURY
	1977-1979	V8-6.6L	BUICK ELECTRA
	1977-1979	V8-6.6L	BUICK ESTATE WAGON
	1975-1978	V8-6.6L	BUICK LESABRE
	1977-1978	V8-6.6L	BUICK RIVIERA
	1975-1979	V8-6.6L	OLDSMOBILE 98
	1975-1979	V8-6.6L	OLDSMOBILE CUSTOM CRUISER
	1977	V8-6.6L	OLDSMOBILE CUTLASS
	1977	V8-6.6L	OLDSMOBILE CUTLASS SALON
	1975-1979	V8-6.6L	OLDSMOBILE DELTA 88
	1977-1978	V8-6.6L	OLDSMOBILE TORONADO
	1975-1979	V8-6.6L	PONTIAC BONNEVILLE
	1975-1979	V8-6.6L	PONTIAC CATALINA
	1975-1979	V8-6.6L	PONTIAC FIREBIRD
	1975-1977	V8-6.6L	PONTIAC GRAND PRIX
	1975-1978	V8-6.6L	PONTIAC GRAND SAFARI
	1975-1977	V8-6.6L	PONTIAC LEMANS
	1975-1976	V8-7.5L	OLDSMOBILE 98
	1975-1976	V8-7.5L	OLDSMOBILE CUSTOM CRUISER
	1975-1976	V8-7.5L	OLDSMOBILE CUTLASS
	1975-1976	V8-7.5L	OLDSMOBILE CUTLASS SALON
	1976	V8-7.5L	OLDSMOBILE CUTLASS TIARA
	1975-1976	V8-7.5L	OLDSMOBILE DELTA 88
	1975-1976	V8-7.5L	OLDSMOBILE TORONADO
<b>US1120H</b>	1982-1983	V6-4.3L	OLDSMOBILE CUTLASS SUPREME
	1975	V8-4.3L	BUICK APOLLO
	1975-1976	V8-4.3L	BUICK SKYLARK
	1975-1981	V8-4.3L	OLDSMOBILE CUTLASS
	1978-1982	V8-4.3L	OLDSMOBILE CUTLASS CALAIS
	1975-1981	V8-4.3L	OLDSMOBILE CUTLASS SALON
	1976	V8-4.3L	OLDSMOBILE CUTLASS TIARA
	1977-1982	V8-4.3L	OLDSMOBILE DELTA 88
	1975-1977	V8-4.3L	OLDSMOBILE OMEGA
	1976	V8-4.3L	PONTIAC LEMANS
	1975-1976	V8-4.3L	PONTIAC VENTURA
	1981-1985	V8-5.0L	BUICK ELECTRA
	1981-1983	V8-5.0L	BUICK ESTATE WAGON
	1981-1985	V8-5.0L	BUICK LESABRE
	1986-1987	V8-5.0L	BUICK REGAL
	1980-1985	V8-5.0L	BUICK RIVIERA
	1987-1990	V8-5.0L	CADILLAC BROUGHAM
	1986-1990	V8-5.0L	CHEVROLET CAPRICE
	1980-1984	V8-5.0L	OLDSMOBILE 98
	1980-1990	V8-5.0L	OLDSMOBILE CUSTOM CRUISER
	1982-1984	V8-5.0L	OLDSMOBILE CUTLASS CALAIS
	1982-1983	V8-5.0L	OLDSMOBILE CUTLASS CRUISER
	1985-1987	V8-5.0L	OLDSMOBILE CUTLASS SALON
	1982-1988	V8-5.0L	OLDSMOBILE CUTLASS SUPREME
	1980-1985	V8-5.0L	OLDSMOBILE DELTA 88
	1980-1985	V8-5.0L	OLDSMOBILE TORONADO
	1981	V8-5.0L	PONTIAC BONNEVILLE
	1981	V8-5.0L	PONTIAC CATALINA
	1986	V8-5.0L	PONTIAC PARISIENNE
	1987-1989	V8-5.0L	PONTIAC SAFARI
	1975	V8-5.7L	BUICK APOLLO
	1975-1981	V8-5.7L	BUICK CENTURY
	1976-1987	V8-5.7L	BUICK ELECTRA
	1977-1983	V8-5.7L	BUICK ESTATE WAGON
	1975-1990	V8-5.7L	BUICK LESABRE
	1975-1985	V8-5.7L	BUICK REGAL
	1977-1985	V8-5.7L	BUICK RIVIERA
	1975-1977	V8-5.7L	BUICK SKYLARK

USMW	Years	Cyl.	Specifications
	1980-1984	V8-5.7L	CADILLAC DEVILLE
	1980-1985	V8-5.7L	CADILLAC ELDORADO
	1980-1986	V8-5.7L	CADILLAC FLEETWOOD
	1980-1985	V8-5.7L	CADILLAC SEVILLE
	1980-1985	V8-5.7L	CHEVROLET CAPRICE
	1983-1984	V8-5.7L	CHEVROLET EL CAMINO
	1980-1985	V8-5.7L	CHEVROLET IMPALA
	1982-1983	V8-5.7L	CHEVROLET MALIBU
	1982-1984	V8-5.7L	CHEVROLET MONTE CARLO
	1983-1984	V8-5.7L	GMC CABALLERO
	1977-1984	V8-5.7L	OLDSMOBILE 98
	1977-1985	V8-5.7L	OLDSMOBILE CUSTOM CRUISER
	1975-1981	V8-5.7L	OLDSMOBILE CUTLASS
	1979-1984	V8-5.7L	OLDSMOBILE CUTLASS CALAIS
	1980-1983	V8-5.7L	OLDSMOBILE CUTLASS CRUISER
	1975-1985	V8-5.7L	OLDSMOBILE CUTLASS SALON
	1980-1985	V8-5.7L	OLDSMOBILE CUTLASS SUPREME
	1976	V8-5.7L	OLDSMOBILE CUTLASS TIARA
	1975-1985	V8-5.7L	OLDSMOBILE DELTA 88
	1975-1979	V8-5.7L	OLDSMOBILE OMEGA
	1977-1985	V8-5.7L	OLDSMOBILE TORONADO
	1977-1984	V8-5.7L	PONTIAC BONNEVILLE
	1976-1981	V8-5.7L	PONTIAC CATALINA
	1975-1978	V8-5.7L	PONTIAC FIREBIRD
	1976-1984	V8-5.7L	PONTIAC GRAND PRIX
	1977	V8-5.7L	PONTIAC GRAND SAFARI
	1975-1979	V8-5.7L	PONTIAC LEMANS
	1983-1985	V8-5.7L	PONTIAC PARISIENNE
	1977-1979	V8-5.7L	PONTIAC PHOENIX
	1977	V8-5.7L	PONTIAC VENTURA
	1977	V8-6.6L	BUICK CENTURY
	1977-1979	V8-6.6L	BUICK ELECTRA
	1977-1979	V8-6.6L	BUICK ESTATE WAGON
	1975-1978	V8-6.6L	BUICK LESABRE
	1977-1978	V8-6.6L	BUICK RIVIERA
	1975-1979	V8-6.6L	OLDSMOBILE 98
	1975-1979	V8-6.6L	OLDSMOBILE CUSTOM CRUISER
	1977	V8-6.6L	OLDSMOBILE CUTLASS
	1977	V8-6.6L	OLDSMOBILE CUTLASS SALON
	1975-1979	V8-6.6L	OLDSMOBILE DELTA 88
	1977-1978	V8-6.6L	OLDSMOBILE TORONADO
	1975-1979	V8-6.6L	PONTIAC BONNEVILLE
	1975-1979	V8-6.6L	PONTIAC CATALINA
	1975-1979	V8-6.6L	PONTIAC FIREBIRD
	1975-1977	V8-6.6L	PONTIAC GRAND PRIX
	1975-1978	V8-6.6L	PONTIAC GRAND SAFARI
	1975-1977	V8-6.6L	PONTIAC LEMANS
	1975-1976	V8-7.5L	OLDSMOBILE 98
	1975-1976	V8-7.5L	OLDSMOBILE CUSTOM CRUISER
	1975-1976	V8-7.5L	OLDSMOBILE CUTLASS
	1975-1976	V8-7.5L	OLDSMOBILE CUTLASS SALON
	1976	V8-7.5L	OLDSMOBILE CUTLASS TIARA
	1975-1976	V8-7.5L	OLDSMOBILE DELTA 88
	1975-1976	V8-7.5L	OLDSMOBILE TORONADO
<b>US1121</b>	1978-1979	V6-3.3L	CHEVROLET EL CAMINO
	1978-1979	V6-3.3L	CHEVROLET MALIBU
	1978-1979	V6-3.3L	CHEVROLET MONTE CARLO
	1978-1979	V6-3.3L	GMC CABALLERO
	1980-1981	V6-3.8L	CHEVROLET CAMARO
	1980-1984	V6-3.8L	CHEVROLET CAPRICE
	1980-1984	V6-3.8L	CHEVROLET EL CAMINO
	1980-1984	V6-3.8L	CHEVROLET IMPALA
	1980-1983	V6-3.8L	CHEVROLET MALIBU
	1980-1984	V6-3.8L	CHEVROLET MONTE CARLO
	1980-1984	V6-3.8L	GMC CABALLERO
	1980	V6-3.8L	PONTIAC GRAND LEMANS
	1980	V6-3.8L	PONTIAC LEMANS
	1985-1986	V6-4.3L	CHEVROLET ASTRO
	1985-1986	V6-4.3L	CHEVROLET C10



USMW	Years	Cyl.	Specifications	USMW	Years	Cyl.	Specifications
1985-1986	V6-4.3L	CHEVROLET C20		1979-1986	V8-5.0L	GMC C1500 SUBURBAN	
1985-1988	V6-4.3L	CHEVROLET CAPRICE		1977-1978	V8-5.0L	GMC C25	
1985-1987	V6-4.3L	CHEVROLET EL CAMINO		1977-1978	V8-5.0L	GMC C25 SUBURBAN	
1985-1986	V6-4.3L	CHEVROLET G10		1979-1986	V8-5.0L	GMC C2500	
1985-1986	V6-4.3L	CHEVROLET G20		1982-1986	V8-5.0L	GMC C2500 SUBURBAN	
1985-1986	V6-4.3L	CHEVROLET G30		1986	V8-5.0L	GMC C3500	
1985	V6-4.3L	CHEVROLET IMPALA		1978-1987	V8-5.0L	GMC CABALLERO	
1985-1986	V6-4.3L	CHEVROLET K10		1977-1978	V8-5.0L	GMC G15	
1985	V6-4.3L	CHEVROLET K20		1979-1986	V8-5.0L	GMC G1500	
1985-1988	V6-4.3L	CHEVROLET MONTE CARLO		1977-1978	V8-5.0L	GMC G25	
1990-1995	V6-4.3L	CHEVROLET P30		1979-1986	V8-5.0L	GMC G2500	
1987	V6-4.3L	CHEVROLET R10		1981	V8-5.0L	GMC G3500	
1987	V6-4.3L	CHEVROLET R20		1977-1987	V8-5.0L	GMC JIMMY	
1987	V6-4.3L	CHEVROLET V10		1977-1978	V8-5.0L	GMC K15	
1985-1986	V6-4.3L	GMC C1500		1977-1978	V8-5.0L	GMC K15 SUBURBAN	
1985-1986	V6-4.3L	GMC C2500		1979-1986	V8-5.0L	GMC K1500	
1985-1987	V6-4.3L	GMC CABALLERO		1979-1985	V8-5.0L	GMC K1500 SUBURBAN	
1985-1986	V6-4.3L	GMC G1500		1977-1978	V8-5.0L	GMC K25	
1985-1986	V6-4.3L	GMC G2500		1977-1978	V8-5.0L	GMC K25 SUBURBAN	
1985-1986	V6-4.3L	GMC G3500		1987	V8-5.0L	GMC R1500	
1985-1986	V6-4.3L	GMC K1500		1987	V8-5.0L	GMC R1500 SUBURBAN	
1985	V6-4.3L	GMC K2500		1987	V8-5.0L	GMC R2500	
1990-1995	V6-4.3L	GMC P3500		1977	V8-5.0L	GMC SPRINT	
1987	V6-4.3L	GMC R1500		1987	V8-5.0L	GMC V1500	
1987	V6-4.3L	GMC R2500		1980	V8-5.0L	OLDSMOBILE CUTLASS	
1985-1986	V6-4.3L	GMC SAFARI		1980	V8-5.0L	OLDSMOBILE CUTLASS CALAIS	
1987	V6-4.3L	GMC V1500		1980-1982	V8-5.0L	OLDSMOBILE CUTLASS CRUISER	
1986	V6-4.3L	PONTIAC BONNEVILLE		1980	V8-5.0L	OLDSMOBILE CUTLASS SALON	
1986-1987	V6-4.3L	PONTIAC GRAND PRIX		1980	V8-5.0L	OLDSMOBILE CUTLASS SUPREME	
1985-1986	V6-4.3L	PONTIAC PARISIENNE		1983-1986	V8-5.0L	PONTIAC BONNEVILLE	
1980-1981	V8-4.4L	CHEVROLET CAMARO		1977-1987	V8-5.0L	PONTIAC FIREBIRD	
1980-1982	V8-4.4L	CHEVROLET CAPRICE		1978-1980	V8-5.0L	PONTIAC GRAND AM	
1980-1982	V8-4.4L	CHEVROLET EL CAMINO		1980	V8-5.0L	PONTIAC GRAND LEMANS	
1980-1982	V8-4.4L	CHEVROLET IMPALA		1978-1987	V8-5.0L	PONTIAC GRAND PRIX	
1980-1982	V8-4.4L	CHEVROLET MALIBU		1977-1980	V8-5.0L	PONTIAC LEMANS	
1980-1982	V8-4.4L	CHEVROLET MONTE CARLO		1983-1986	V8-5.0L	PONTIAC PARISIENNE	
1980-1982	V8-4.4L	GMC CABALLERO		1977-1978	V8-5.0L	PONTIAC PHOENIX	
1977-1980	V8-5.0L	BUICK CENTURY		1978	V8-5.0L	PONTIAC SUNBIRD	
1978	V8-5.0L	BUICK LESABRE		1977	V8-5.0L	PONTIAC VENTURA	
1977-1980	V8-5.0L	BUICK REGAL		1977	V8-5.7L	BUICK CENTURY	
1977-1979	V8-5.0L	BUICK SKYLARK		1978-1979	V8-5.7L	BUICK LESABRE	
1987	V8-5.0L	CHEVROLET BLAZER		1977	V8-5.7L	BUICK REGAL	
1977-1986	V8-5.0L	CHEVROLET C10		1978-1979	V8-5.7L	BUICK SKYLARK	
1977-1986	V8-5.0L	CHEVROLET C10 SUBURBAN		1987-1988	V8-5.7L	CHEVROLET BLAZER	
1977-1986	V8-5.0L	CHEVROLET C20		1977-1986	V8-5.7L	CHEVROLET C10	
1977-1986	V8-5.0L	CHEVROLET C20 SUBURBAN		1981-1987	V8-5.7L	CHEVROLET C10 (MEX)	
1978-1986	V8-5.0L	CHEVROLET C30		1977-1986	V8-5.7L	CHEVROLET C10 SUBURBAN	
1977-1987	V8-5.0L	CHEVROLET CAMARO		1977-1986	V8-5.7L	CHEVROLET C20	
1977-1988	V8-5.0L	CHEVROLET CAPRICE		1985-1987	V8-5.7L	CHEVROLET C20 (MEX)	
1977-1987	V8-5.0L	CHEVROLET EL CAMINO		1977-1986	V8-5.7L	CHEVROLET C20 SUBURBAN	
1977-1986	V8-5.0L	CHEVROLET G10		1977-1986	V8-5.7L	CHEVROLET C30	
1977-1986	V8-5.0L	CHEVROLET G20		1979-1987	V8-5.7L	CHEVROLET C30 (MEX)	
1978-1985	V8-5.0L	CHEVROLET G30		1977-1987	V8-5.7L	CHEVROLET CAMARO	
1977-1985	V8-5.0L	CHEVROLET IMPALA		1977-1980	V8-5.7L	CHEVROLET CAPRICE	
1977-1986	V8-5.0L	CHEVROLET K10		1981	V8-5.7L	CHEVROLET CAPRICE (MEX)	
1977-1986	V8-5.0L	CHEVROLET K10 SUBURBAN		1977-1978	V8-5.7L	CHEVROLET CS31003 (MEX)	
1977-1985	V8-5.0L	CHEVROLET K20		1977-1979	V8-5.7L	CHEVROLET EL CAMINO	
1977-1986	V8-5.0L	CHEVROLET K20 SUBURBAN		1977-1986	V8-5.7L	CHEVROLET G10	
1977-1986	V8-5.0L	CHEVROLET K5 BLAZER		1977-1986	V8-5.7L	CHEVROLET G20	
1977-1983	V8-5.0L	CHEVROLET MALIBU		1977-1988	V8-5.7L	CHEVROLET G30	
1977-1988	V8-5.0L	CHEVROLET MONTE CARLO		1977-1985	V8-5.7L	CHEVROLET IMPALA	
1977-1979	V8-5.0L	CHEVROLET NOVA		1977-1986	V8-5.7L	CHEVROLET K10	
1987	V8-5.0L	CHEVROLET R10		1977-1986	V8-5.7L	CHEVROLET K10 SUBURBAN	
1987	V8-5.0L	CHEVROLET R10 SUBURBAN		1977-1986	V8-5.7L	CHEVROLET K20	
1987	V8-5.0L	CHEVROLET R20		1977-1986	V8-5.7L	CHEVROLET K20 SUBURBAN	
1987	V8-5.0L	CHEVROLET V10		1977-1986	V8-5.7L	CHEVROLET K30	
1977-1978	V8-5.0L	GMC C15		1977-1986	V8-5.7L	CHEVROLET K5 BLAZER	
1977-1978	V8-5.0L	GMC C15 SUBURBAN		1977-1981	V8-5.7L	CHEVROLET MALIBU	
1979-1986	V8-5.0L	GMC C1500		1979-1981	V8-5.7L	CHEVROLET MALIBU (MEX)	

**WATER PUMPS**

USMW	Years	Cyl.	Specifications
1986-1987	V8-5.7L	CHEVROLET	MICROBUS (MEX)
1977	V8-5.7L	CHEVROLET	MONTE CARLO
1982-1983	V8-5.7L	CHEVROLET	MONTE CARLO (MEX)
1977-1979	V8-5.7L	CHEVROLET	NOVA
1977-1979	V8-5.7L	CHEVROLET	P20
1977-1996	V8-5.7L	CHEVROLET	P30
1991-1995	V8-5.7L	CHEVROLET	P31 VAN (MEX)
1987	V8-5.7L	CHEVROLET	R10
1987-1988	V8-5.7L	CHEVROLET	R20
1987-1988	V8-5.7L	CHEVROLET	R30
1989-1991	V8-5.7L	CHEVROLET	R3500
1987	V8-5.7L	CHEVROLET	V10
1987	V8-5.7L	CHEVROLET	V20
1987	V8-5.7L	CHEVROLET	V20 SUBURBAN
1987-1988	V8-5.7L	CHEVROLET	V30
1989-1991	V8-5.7L	CHEVROLET	V3500
1977-1978	V8-5.7L	GMC	C15
1977-1978	V8-5.7L	GMC	C15 SUBURBAN
1979-1986	V8-5.7L	GMC	C1500
1981-1988	V8-5.7L	GMC	C1500 (MEX)
1979-1986	V8-5.7L	GMC	C1500 SUBURBAN
1977-1978	V8-5.7L	GMC	C25
1977-1978	V8-5.7L	GMC	C25 SUBURBAN
1979-1986	V8-5.7L	GMC	C2500
1985-1988	V8-5.7L	GMC	C2500 (MEX)
1979-1986	V8-5.7L	GMC	C2500 SUBURBAN
1980-1986	V8-5.7L	GMC	C3500
1980-1988	V8-5.7L	GMC	C3500 (MEX)
1978-1979	V8-5.7L	GMC	CABALLERO
1977-1978	V8-5.7L	GMC	G15
1979-1986	V8-5.7L	GMC	G1500
1977-1978	V8-5.7L	GMC	G25
1979-1986	V8-5.7L	GMC	G2500
1977-1978	V8-5.7L	GMC	G35
1979-1988	V8-5.7L	GMC	G3500
1977-1988	V8-5.7L	GMC	JIMMY
1977-1978	V8-5.7L	GMC	K15
1977-1978	V8-5.7L	GMC	K15 SUBURBAN
1979-1986	V8-5.7L	GMC	K1500
1979-1986	V8-5.7L	GMC	K1500 SUBURBAN
1977-1978	V8-5.7L	GMC	K25
1977-1978	V8-5.7L	GMC	K25 SUBURBAN
1979-1986	V8-5.7L	GMC	K2500
1977-1978	V8-5.7L	GMC	K35
1979-1986	V8-5.7L	GMC	K3500
1977-1978	V8-5.7L	GMC	P25
1979	V8-5.7L	GMC	P2500
1977-1978	V8-5.7L	GMC	P35
1979-1996	V8-5.7L	GMC	P3500
1987	V8-5.7L	GMC	R1500
1987-1988	V8-5.7L	GMC	R1500 SUBURBAN
1987-1989	V8-5.7L	GMC	R2500
1987-1988	V8-5.7L	GMC	R2500 SUBURBAN
1987-1991	V8-5.7L	GMC	R3500
1977	V8-5.7L	GMC	SPRINT
1987	V8-5.7L	GMC	V1500
1987-1988	V8-5.7L	GMC	V1500 SUBURBAN
1987	V8-5.7L	GMC	V2500
1987-1988	V8-5.7L	GMC	V2500 SUBURBAN
1987-1991	V8-5.7L	GMC	V3500
1979-1987	V8-5.7L	PONTIAC	FIREBIRD
1977-1978	V8-5.7L	PONTIAC	PHOENIX
1977-1980	V8-6.6L	CHEVROLET	C10
1977-1980	V8-6.6L	CHEVROLET	C20
1977-1980	V8-6.6L	CHEVROLET	C20 SUBURBAN
1977-1979	V8-6.6L	CHEVROLET	C30
1977-1980	V8-6.6L	CHEVROLET	G20
1977-1980	V8-6.6L	CHEVROLET	G30

USMW	Years	Cyl.	Specifications
1977-1980	V8-6.6L	CHEVROLET	K10
1977-1979	V8-6.6L	CHEVROLET	K10 SUBURBAN
1977-1980	V8-6.6L	CHEVROLET	K20
1977-1980	V8-6.6L	CHEVROLET	K20 SUBURBAN
1977-1980	V8-6.6L	CHEVROLET	K30
1977-1979	V8-6.6L	CHEVROLET	K5 BLAZER
1978	V8-6.6L	GMC	C15
1979-1980	V8-6.6L	GMC	C1500
1977-1978	V8-6.6L	GMC	C25
1978	V8-6.6L	GMC	C25 SUBURBAN
1979	V8-6.6L	GMC	C2500
1980	V8-6.6L	GMC	C2500 SUBURBAN
1979	V8-6.6L	GMC	G1500
1977-1978	V8-6.6L	GMC	G25
1979-1980	V8-6.6L	GMC	G2500
1977-1978	V8-6.6L	GMC	G35
1979-1980	V8-6.6L	GMC	G3500
1977-1979	V8-6.6L	GMC	JIMMY
1977-1978	V8-6.6L	GMC	K15
1977-1978	V8-6.6L	GMC	K15 SUBURBAN
1979-1980	V8-6.6L	GMC	K1500
1979	V8-6.6L	GMC	K1500 SUBURBAN
1977-1978	V8-6.6L	GMC	K25
1977-1978	V8-6.6L	GMC	K25 SUBURBAN
1979-1980	V8-6.6L	GMC	K2500
1979-1980	V8-6.6L	GMC	K2500 SUBURBAN
1977-1978	V8-6.6L	GMC	K35
1979-1980	V8-6.6L	GMC	K3500
US1121H	1978-1979	V6-3.3L	CHEVROLET EL CAMINO
	1978-1979	V6-3.3L	CHEVROLET MALIBU
	1978-1979	V6-3.3L	CHEVROLET MONTE CARLO
	1978-1979	V6-3.3L	GMC CABALLERO
	1980-1981	V6-3.8L	CHEVROLET CAMARO
	1980-1984	V6-3.8L	CHEVROLET CAPRICE
	1980-1984	V6-3.8L	CHEVROLET EL CAMINO
	1980-1984	V6-3.8L	CHEVROLET IMPALA
	1980-1983	V6-3.8L	CHEVROLET MALIBU
	1980-1984	V6-3.8L	CHEVROLET MONTE CARLO
	1980-1984	V6-3.8L	GMC CABALLERO
	1980	V6-3.8L	PONTIAC GRAND LEMANS
	1980	V6-3.8L	PONTIAC LEMANS
	1985-1986	V6-4.3L	CHEVROLET ASTRO
	1985-1986	V6-4.3L	CHEVROLET C10
	1985-1986	V6-4.3L	CHEVROLET C20
	1985-1988	V6-4.3L	CHEVROLET CAPRICE
	1985-1987	V6-4.3L	CHEVROLET EL CAMINO
	1985-1986	V6-4.3L	CHEVROLET G10
	1985-1986	V6-4.3L	CHEVROLET G20
	1985-1986	V6-4.3L	CHEVROLET G30
	1985	V6-4.3L	CHEVROLET IMPALA
	1985-1986	V6-4.3L	CHEVROLET K10
	1985	V6-4.3L	CHEVROLET K20
	1985-1988	V6-4.3L	CHEVROLET MONTE CARLO
	1990-1995	V6-4.3L	CHEVROLET P30
	1987	V6-4.3L	CHEVROLET R10
	1987	V6-4.3L	CHEVROLET R20
	1987	V6-4.3L	CHEVROLET V10
	1985-1986	V6-4.3L	GMC C1500
	1985-1986	V6-4.3L	GMC C2500
	1985-1987	V6-4.3L	GMC CABALLERO
	1985-1986	V6-4.3L	GMC G1500
	1985-1986	V6-4.3L	GMC G2500
	1985-1986	V6-4.3L	GMC G3500
	1985-1986	V6-4.3L	GMC K1500
	1985	V6-4.3L	GMC K2500
	1990-1995	V6-4.3L	GMC P3500
	1987	V6-4.3L	GMC R1500
	1987	V6-4.3L	GMC R2500
	1985-1986	V6-4.3L	GMC SAFARI

USMW	Years	Cyl.	Specifications	USMW	Years	Cyl.	Specifications
1987	V6-4.3L	GMC V1500		1980-1982	V8-5.0L	OLDSMOBILE CUTLASS CRUISER	
1986	V6-4.3L	PONTIAC BONNEVILLE		1980	V8-5.0L	OLDSMOBILE CUTLASS SALON	
1986-1987	V6-4.3L	PONTIAC GRAND PRIX		1980	V8-5.0L	OLDSMOBILE CUTLASS SUPREME	
1985-1986	V6-4.3L	PONTIAC PARISIENNE		1983-1986	V8-5.0L	PONTIAC BONNEVILLE	
1980-1981	V8-4.4L	CHEVROLET CAMARO		1977-1987	V8-5.0L	PONTIAC FIREBIRD	
1980-1982	V8-4.4L	CHEVROLET CAPRICE		1978-1980	V8-5.0L	PONTIAC GRAND AM	
1980-1982	V8-4.4L	CHEVROLET EL CAMINO		1980	V8-5.0L	PONTIAC GRAND LEMANS	
1980-1982	V8-4.4L	CHEVROLET IMPALA		1978-1987	V8-5.0L	PONTIAC GRAND PRIX	
1980-1982	V8-4.4L	CHEVROLET MALIBU		1977-1980	V8-5.0L	PONTIAC LEMANS	
1980-1982	V8-4.4L	CHEVROLET MONTE CARLO		1983-1986	V8-5.0L	PONTIAC PARISIENNE	
1980-1982	V8-4.4L	GMC CABALLERO		1977-1978	V8-5.0L	PONTIAC PHOENIX	
1977-1980	V8-5.0L	BUICK CENTURY		1978	V8-5.0L	PONTIAC SUNBIRD	
1978	V8-5.0L	BUICK LESABRE		1977	V8-5.0L	PONTIAC VENTURA	
1977-1980	V8-5.0L	BUICK REGAL		1977	V8-5.7L	BUICK CENTURY	
1977-1979	V8-5.0L	BUICK SKYLARK		1978-1979	V8-5.7L	BUICK LESABRE	
1987	V8-5.0L	CHEVROLET BLAZER		1977	V8-5.7L	BUICK REGAL	
1977-1986	V8-5.0L	CHEVROLET C10		1978-1979	V8-5.7L	BUICK SKYLARK	
1977-1986	V8-5.0L	CHEVROLET C10 SUBURBAN		1987-1988	V8-5.7L	CHEVROLET BLAZER	
1977-1986	V8-5.0L	CHEVROLET C20		1977-1986	V8-5.7L	CHEVROLET C10	
1977-1986	V8-5.0L	CHEVROLET C20 SUBURBAN		1981-1987	V8-5.7L	CHEVROLET C10 (MEX)	
1978-1986	V8-5.0L	CHEVROLET C30		1977-1986	V8-5.7L	CHEVROLET C10 SUBURBAN	
1977-1987	V8-5.0L	CHEVROLET CAMARO		1977-1986	V8-5.7L	CHEVROLET C20	
1977-1988	V8-5.0L	CHEVROLET CAPRICE		1985-1987	V8-5.7L	CHEVROLET C20 (MEX)	
1977-1987	V8-5.0L	CHEVROLET EL CAMINO		1977-1986	V8-5.7L	CHEVROLET C20 SUBURBAN	
1977-1986	V8-5.0L	CHEVROLET G10		1977-1986	V8-5.7L	CHEVROLET C30	
1977-1986	V8-5.0L	CHEVROLET G20		1979-1987	V8-5.7L	CHEVROLET C30 (MEX)	
1978-1985	V8-5.0L	CHEVROLET G30		1977-1987	V8-5.7L	CHEVROLET CAMARO	
1977-1985	V8-5.0L	CHEVROLET IMPALA		1977-1980	V8-5.7L	CHEVROLET CAPRICE	
1977-1986	V8-5.0L	CHEVROLET K10		1981	V8-5.7L	CHEVROLET CAPRICE (MEX)	
1977-1986	V8-5.0L	CHEVROLET K10 SUBURBAN		1977-1978	V8-5.7L	CHEVROLET CS31003 (MEX)	
1977-1985	V8-5.0L	CHEVROLET K20		1977-1979	V8-5.7L	CHEVROLET EL CAMINO	
1977-1986	V8-5.0L	CHEVROLET K20 SUBURBAN		1977-1986	V8-5.7L	CHEVROLET G10	
1977-1986	V8-5.0L	CHEVROLET K5 BLAZER		1977-1986	V8-5.7L	CHEVROLET G20	
1977-1983	V8-5.0L	CHEVROLET MALIBU		1977-1988	V8-5.7L	CHEVROLET G30	
1977-1988	V8-5.0L	CHEVROLET MONTE CARLO		1977-1985	V8-5.7L	CHEVROLET IMPALA	
1977-1979	V8-5.0L	CHEVROLET NOVA		1977-1986	V8-5.7L	CHEVROLET K10	
1987	V8-5.0L	CHEVROLET R10		1977-1986	V8-5.7L	CHEVROLET K10 SUBURBAN	
1987	V8-5.0L	CHEVROLET R10 SUBURBAN		1977-1986	V8-5.7L	CHEVROLET K20	
1987	V8-5.0L	CHEVROLET R20		1977-1986	V8-5.7L	CHEVROLET K20 SUBURBAN	
1987	V8-5.0L	CHEVROLET V10		1977-1986	V8-5.7L	CHEVROLET K30	
1977-1978	V8-5.0L	GMC C15		1977-1986	V8-5.7L	CHEVROLET K5 BLAZER	
1977-1978	V8-5.0L	GMC C15 SUBURBAN		1977-1981	V8-5.7L	CHEVROLET MALIBU	
1979-1986	V8-5.0L	GMC C1500		1979-1981	V8-5.7L	CHEVROLET MALIBU (MEX)	
1979-1986	V8-5.0L	GMC C1500 SUBURBAN		1986-1987	V8-5.7L	CHEVROLET MICROBUS (MEX)	
1977-1978	V8-5.0L	GMC C25		1977	V8-5.7L	CHEVROLET MONTE CARLO	
1977-1978	V8-5.0L	GMC C25 SUBURBAN		1982-1983	V8-5.7L	CHEVROLET MONTE CARLO (MEX)	
1979-1986	V8-5.0L	GMC C2500		1977-1979	V8-5.7L	CHEVROLET NOVA	
1982-1986	V8-5.0L	GMC C2500 SUBURBAN		1977-1979	V8-5.7L	CHEVROLET P20	
1986	V8-5.0L	GMC C3500		1977-1996	V8-5.7L	CHEVROLET P30	
1978-1987	V8-5.0L	GMC CABALLERO		1991-1995	V8-5.7L	CHEVROLET P31 VAN (MEX)	
1977-1978	V8-5.0L	GMC G15		1987	V8-5.7L	CHEVROLET R10	
1979-1986	V8-5.0L	GMC G1500		1987-1988	V8-5.7L	CHEVROLET R20	
1977-1978	V8-5.0L	GMC G25		1987-1988	V8-5.7L	CHEVROLET R30	
1979-1986	V8-5.0L	GMC G2500		1989-1991	V8-5.7L	CHEVROLET R3500	
1981	V8-5.0L	GMC G3500		1987	V8-5.7L	CHEVROLET V10	
1977-1987	V8-5.0L	GMC JIMMY		1987	V8-5.7L	CHEVROLET V20	
1977-1978	V8-5.0L	GMC K15		1987	V8-5.7L	CHEVROLET V20 SUBURBAN	
1977-1978	V8-5.0L	GMC K15 SUBURBAN		1987-1988	V8-5.7L	CHEVROLET V30	
1979-1986	V8-5.0L	GMC K1500		1989-1991	V8-5.7L	CHEVROLET V3500	
1979-1985	V8-5.0L	GMC K1500 SUBURBAN		1977-1978	V8-5.7L	GMC C15	
1977-1978	V8-5.0L	GMC K25		1977-1978	V8-5.7L	GMC C15 SUBURBAN	
1977-1978	V8-5.0L	GMC K25 SUBURBAN		1979-1986	V8-5.7L	GMC C1500	
1987	V8-5.0L	GMC R1500		1981-1988	V8-5.7L	GMC C1500 (MEX)	
1987	V8-5.0L	GMC R1500 SUBURBAN		1979-1986	V8-5.7L	GMC C1500 SUBURBAN	
1987	V8-5.0L	GMC R2500		1977-1978	V8-5.7L	GMC C25	
1977	V8-5.0L	GMC SPRINT		1977-1978	V8-5.7L	GMC C25 SUBURBAN	
1987	V8-5.0L	GMC V1500		1979-1986	V8-5.7L	GMC C2500	
1980	V8-5.0L	OLDSMOBILE CUTLASS		1985-1988	V8-5.7L	GMC C2500 (MEX)	
1980	V8-5.0L	OLDSMOBILE CUTLASS CALAIS		1979-1986	V8-5.7L	GMC C2500 SUBURBAN	

**WATER PUMPS**



USMW	Years	Cyl.	Specifications
	1980-1986	V8-5.7L	GMC C3500
	1980-1988	V8-5.7L	GMC C3500 (MEX)
	1978-1979	V8-5.7L	GMC CABALLERO
	1977-1978	V8-5.7L	GMC G15
	1979-1986	V8-5.7L	GMC G1500
	1977-1978	V8-5.7L	GMC G25
	1979-1986	V8-5.7L	GMC G2500
	1977-1978	V8-5.7L	GMC G35
	1979-1988	V8-5.7L	GMC G3500
	1977-1988	V8-5.7L	GMC JIMMY
	1977-1978	V8-5.7L	GMC K15
	1977-1978	V8-5.7L	GMC K15 SUBURBAN
	1979-1986	V8-5.7L	GMC K1500
	1979-1986	V8-5.7L	GMC K1500 SUBURBAN
	1977-1978	V8-5.7L	GMC K25
	1977-1978	V8-5.7L	GMC K25 SUBURBAN
	1979-1986	V8-5.7L	GMC K2500
	1979-1986	V8-5.7L	GMC K2500 SUBURBAN
	1977-1978	V8-5.7L	GMC K35
	1979-1986	V8-5.7L	GMC K3500
	1977-1978	V8-5.7L	GMC P25
	1979	V8-5.7L	GMC P2500
	1977-1978	V8-5.7L	GMC P35
	1979-1996	V8-5.7L	GMC P3500
	1987	V8-5.7L	GMC R1500
	1987-1988	V8-5.7L	GMC R1500 SUBURBAN
	1987-1989	V8-5.7L	GMC R2500
	1987-1988	V8-5.7L	GMC R2500 SUBURBAN
	1987-1991	V8-5.7L	GMC R3500
	1977	V8-5.7L	GMC SPRINT
	1987	V8-5.7L	GMC V1500
	1987-1988	V8-5.7L	GMC V1500 SUBURBAN
	1987	V8-5.7L	GMC V2500
	1987-1988	V8-5.7L	GMC V2500 SUBURBAN
	1987-1991	V8-5.7L	GMC V3500
	1979-1987	V8-5.7L	PONTIAC FIREBIRD
	1977-1978	V8-5.7L	PONTIAC PHOENIX
	1977-1980	V8-6.6L	CHEVROLET C10
	1977-1980	V8-6.6L	CHEVROLET C20
	1977-1980	V8-6.6L	CHEVROLET C20 SUBURBAN
	1977-1979	V8-6.6L	CHEVROLET C30
	1977-1980	V8-6.6L	CHEVROLET G20
	1977-1980	V8-6.6L	CHEVROLET G30
	1977-1980	V8-6.6L	CHEVROLET K10
	1977-1979	V8-6.6L	CHEVROLET K10 SUBURBAN
	1977-1980	V8-6.6L	CHEVROLET K20
	1977-1980	V8-6.6L	CHEVROLET K20 SUBURBAN
	1977-1980	V8-6.6L	CHEVROLET K30
	1977-1979	V8-6.6L	CHEVROLET K5 BLAZER
	1978	V8-6.6L	GMC C15
	1979-1980	V8-6.6L	GMC C1500
	1977-1978	V8-6.6L	GMC C25
	1978	V8-6.6L	GMC C25 SUBURBAN
	1979	V8-6.6L	GMC C2500
	1980	V8-6.6L	GMC C2500 SUBURBAN
	1979	V8-6.6L	GMC G1500
	1977-1978	V8-6.6L	GMC G25
	1979-1980	V8-6.6L	GMC G2500
	1977-1978	V8-6.6L	GMC G35
	1979-1980	V8-6.6L	GMC G3500
	1977-1979	V8-6.6L	GMC JIMMY
	1977-1978	V8-6.6L	GMC K15
	1977-1978	V8-6.6L	GMC K15 SUBURBAN
	1979-1980	V8-6.6L	GMC K1500
	1979	V8-6.6L	GMC K1500 SUBURBAN
	1977-1978	V8-6.6L	GMC K25
	1977-1978	V8-6.6L	GMC K25 SUBURBAN
	1979-1980	V8-6.6L	GMC K2500
	1979-1980	V8-6.6L	GMC K2500 SUBURBAN

USMW	Years	Cyl.	Specifications
	1977-1978	V8-6.6L	GMC K35
	1979-1980	V8-6.6L	GMC K3500
US1124	1975	L4-2.0L	DODGE COLT
US1127	1975-1982	L4-1.8L	CHEVROLET LUV
	1981-1985	L4-1.8L	ISUZU I-MARK
	1981-1982	L4-1.8L	ISUZU PICKUP
	1983-1987	L4-1.9L	ISUZU IMPULSE
	1983-1987	L4-1.9L	ISUZU PICKUP
	1984-1985	L4-1.9L	ISUZU TROOPER
	1984	L4-2.2L	ISUZU TROOPER
US1137	1975-1977	L6-4.8L	CHEVROLET C20
	1975-1977	L6-4.8L	CHEVROLET C20 SUBURBAN
	1975-1977	L6-4.8L	CHEVROLET C30
	1975-1977	L6-4.8L	CHEVROLET CS1073 (MEX)
	1975-1977	L6-4.8L	CHEVROLET CS31003 (MEX)
	1975-1977	L6-4.8L	CHEVROLET G20
	1975-1977	L6-4.8L	CHEVROLET G30
	1975-1977	L6-4.8L	CHEVROLET K20
	1975-1977	L6-4.8L	CHEVROLET K20 SUBURBAN
	1975-1977	L6-4.8L	CHEVROLET P20
	1975-1977	L6-4.8L	CHEVROLET P30
	1991	L6-4.8L	CHEVROLET P31 VAN (MEX)
	1975-1977	L6-4.8L	GMC C25
	1975-1977	L6-4.8L	GMC C25 SUBURBAN
	1975-1977	L6-4.8L	GMC G25
	1975-1977	L6-4.8L	GMC G35
	1975-1977	L6-4.8L	GMC K25
	1975-1977	L6-4.8L	GMC K25 SUBURBAN
	1975-1977	L6-4.8L	GMC P25
	1975-1977	L6-4.8L	GMC P35
US3400	1978-1979	L4-2.0L	AMERICAN MOTORS CONCORD
	1977-1978	L4-2.0L	AMERICAN MOTORS GREMLIN
	1979	L4-2.0L	AMERICAN MOTORS SPIRIT
US3401	1978-1979	V8-5.0L	AMERICAN MOTORS AMX
	1978-1979	V8-5.0L	AMERICAN MOTORS CONCORD
	1975-1976	V8-5.0L	AMERICAN MOTORS GREMLIN
	1975-1977	V8-5.0L	AMERICAN MOTORS HORNET
	1975-1977	V8-5.0L	AMERICAN MOTORS MATADOR
	1978-1979	V8-5.0L	AMERICAN MOTORS PACER
	1980-1981	V8-5.0L	JEEP CJ5
	1976-1981	V8-5.0L	JEEP CJ7
	1975-1978	V8-5.9L	AMERICAN MOTORS MATADOR
	1975-1983	V8-5.9L	JEEP CHEROKEE
	1984-1991	V8-5.9L	JEEP GRAND WAGONEER
	1975-1988	V8-5.9L	JEEP J10
	1975-1988	V8-5.9L	JEEP J20
	1975-1983	V8-5.9L	JEEP WAGONEER
	1975-1976	V8-6.6L	AMERICAN MOTORS MATADOR
	1975-1978	V8-6.6L	JEEP CHEROKEE
	1975-1978	V8-6.6L	JEEP J10
	1975-1978	V8-6.6L	JEEP J20
	1975-1978	V8-6.6L	JEEP WAGONEER
US3401H	1978-1979	V8-5.0L	AMERICAN MOTORS AMX
	1978-1979	V8-5.0L	AMERICAN MOTORS CONCORD
	1975-1976	V8-5.0L	AMERICAN MOTORS GREMLIN
	1975-1977	V8-5.0L	AMERICAN MOTORS HORNET
	1975-1977	V8-5.0L	AMERICAN MOTORS MATADOR
	1978-1979	V8-5.0L	AMERICAN MOTORS PACER
	1980-1981	V8-5.0L	JEEP CJ5
	1976-1981	V8-5.0L	JEEP CJ7
	1975-1978	V8-5.9L	AMERICAN MOTORS MATADOR
	1975-1983	V8-5.9L	JEEP CHEROKEE
	1984-1991	V8-5.9L	JEEP GRAND WAGONEER
	1975-1988	V8-5.9L	JEEP J10
	1975-1988	V8-5.9L	JEEP J20
	1975-1983	V8-5.9L	JEEP WAGONEER
	1975-1976	V8-6.6L	AMERICAN MOTORS MATADOR
	1975-1978	V8-6.6L	JEEP CHEROKEE
	1975-1978	V8-6.6L	JEEP J10

USMW	Years	Cyl.	Specifications
	1975-1978	V8-6.6L	<b>JEEP</b> J20
	1975-1978	V8-6.6L	<b>JEEP</b> WAGONEER
<b>US3403</b>	1983-1984	L4-2.5L	<b>AMERICAN MOTORS</b> EAGLE
	1984-1990	L4-2.5L	<b>JEEP</b> CHEROKEE
	1981-1983	L4-2.5L	<b>JEEP</b> CJ5
	1981-1986	L4-2.5L	<b>JEEP</b> CJ7
	1986-1990	L4-2.5L	<b>JEEP</b> COMANCHE
	1981-1985	L4-2.5L	<b>JEEP</b> SCRAMBLER
	1984-1987	L4-2.5L	<b>JEEP</b> WAGONEER
	1987-1990	L4-2.5L	<b>JEEP</b> WRANGLER
	1980-1983	L6-4.2L	<b>AMERICAN MOTORS</b> AMERICAN (MEX)
	1980	L6-4.2L	<b>AMERICAN MOTORS</b> AMX
	1980-1983	L6-4.2L	<b>AMERICAN MOTORS</b> CONCORD
	1980-1988	L6-4.2L	<b>AMERICAN MOTORS</b> EAGLE
	1980-1983	L6-4.2L	<b>AMERICAN MOTORS</b> GREMLIN (MEX)
	1980	L6-4.2L	<b>AMERICAN MOTORS</b> PACER
	1981-1983	L6-4.2L	<b>AMERICAN MOTORS</b> RALLY (MEX)
	1980-1983	L6-4.2L	<b>AMERICAN MOTORS</b> SPIRIT
	1980-1983	L6-4.2L	<b>JEEP</b> CHEROKEE
	1980-1983	L6-4.2L	<b>JEEP</b> CJ5
	1975-1986	L6-4.2L	<b>JEEP</b> CJ5D (MEX)
	1980-1986	L6-4.2L	<b>JEEP</b> CJ7
	1984-1986	L6-4.2L	<b>JEEP</b> GRAND WAGONEER
	1980-1987	L6-4.2L	<b>JEEP</b> J10
	1981-1985	L6-4.2L	<b>JEEP</b> SCRAMBLER
	1980-1983	L6-4.2L	<b>JEEP</b> WAGONEER
	1987-1990	L6-4.2L	<b>JEEP</b> WRANGLER
	1980-1983	L6-4.6L	<b>AMERICAN MOTORS</b> AMERICAN (MEX)
	1980-1983	L6-4.6L	<b>AMERICAN MOTORS</b> GREMLIN (MEX)
	1980-1983	L6-4.6L	<b>AMERICAN MOTORS</b> LERMA (MEX)
	1981-1983	L6-4.6L	<b>AMERICAN MOTORS</b> RALLY (MEX)
	1984-1985	L6-4.6L	<b>JEEP</b> CJ10 (MEX)
	1975-1986	L6-4.6L	<b>JEEP</b> CJ5D (MEX)
	1980-1986	L6-4.6L	<b>JEEP</b> CJ7 (MEX)
	1980-1986	L6-4.6L	<b>JEEP</b> J100 (MEX)
	1980-1986	L6-4.6L	<b>JEEP</b> J164 (MEX)
	1980-1986	L6-4.6L	<b>JEEP</b> J164V (MEX)
	1980-1984	L6-4.6L	<b>JEEP</b> J364R (MEX)
	1980-1986	L6-4.6L	<b>JEEP</b> WAGONEER (MEX)
<b>US3404</b>	1983	L4-2.5L	<b>AMERICAN MOTORS</b> EAGLE
	1981-1983	L6-4.2L	<b>AMERICAN MOTORS</b> CONCORD
	1981-1983	L6-4.2L	<b>AMERICAN MOTORS</b> EAGLE
	1981-1983	L6-4.2L	<b>AMERICAN MOTORS</b> SPIRIT
<b>US3406</b>	1982-1984	L4-1.6L	<b>RENAULT</b> FUEGO
	1975-1980	L4-1.6L	<b>RENAULT</b> R12 (MEX)
	1980-1985	L4-1.6L	<b>RENAULT</b> R18 (MEX)
	1981-1983	L4-1.6L	<b>RENAULT</b> R18I
<b>US3409</b>	1985-1987	L4-2.1L	<b>JEEP</b> CHEROKEE
	1986-1987	L4-2.1L	<b>JEEP</b> COMANCHE
	1985	L4-2.1L	<b>JEEP</b> WAGONEER
<b>US3410</b>	1988-1989	L4-2.2L	<b>EAGLE</b> MEDALLION
	1982-1985	L4-2.2L	<b>RENAULT</b> FUEGO
	1984-1986	L4-2.2L	<b>RENAULT</b> R18I
<b>US3411</b>	1990-1991	V6-3.0L	<b>DODGE</b> MONACO
	1988-1991	V6-3.0L	<b>EAGLE</b> PREMIER
<b>US3412</b>	1988-1989	L4-2.5L	<b>EAGLE</b> PREMIER
	1987-2001	L6-4.0L	<b>JEEP</b> CHEROKEE
	1987-1992	L6-4.0L	<b>JEEP</b> COMANCHE
	1992	L6-4.0L	<b>JEEP</b> GRAND CHEROKEE (MEX)
	1987-1990	L6-4.0L	<b>JEEP</b> WAGONEER
<b>US3413</b>	1984	L4-2.5L	<b>AMERICAN MOTORS</b> EAGLE
	1984-1990	L4-2.5L	<b>JEEP</b> CHEROKEE
	1981-1983	L4-2.5L	<b>JEEP</b> CJ5
	1981-1986	L4-2.5L	<b>JEEP</b> CJ7
	1986-1990	L4-2.5L	<b>JEEP</b> COMANCHE
	1981-1985	L4-2.5L	<b>JEEP</b> SCRAMBLER
	1984-1987	L4-2.5L	<b>JEEP</b> WAGONEER
	1987-1990	L4-2.5L	<b>JEEP</b> WRANGLER
	1984-1988	L6-4.2L	<b>AMERICAN MOTORS</b> EAGLE

USMW	Years	Cyl.	Specifications
	1981-1983	L6-4.2L	<b>JEEP</b> CHEROKEE
	1980-1983	L6-4.2L	<b>JEEP</b> CJ5
	1981-1986	L6-4.2L	<b>JEEP</b> CJ7
	1984-1986	L6-4.2L	<b>JEEP</b> GRAND WAGONEER
	1981-1987	L6-4.2L	<b>JEEP</b> J10
	1981-1985	L6-4.2L	<b>JEEP</b> SCRAMBLER
	1981-1983	L6-4.2L	<b>JEEP</b> WAGONEER
	1987-1990	L6-4.2L	<b>JEEP</b> WRANGLER
<b>US4002</b>	1978-1983	L6-3.3L	<b>FORD</b> FAIRMONT
	1975-1982	L6-3.3L	<b>FORD</b> GRANADA
	1983	L6-3.3L	<b>FORD</b> LTD
	1975-1977	L6-3.3L	<b>FORD</b> MAVERICK
	1979-1982	L6-3.3L	<b>FORD</b> MUSTANG
	1980-1982	L6-3.3L	<b>FORD</b> THUNDERBIRD
	1979-1982	L6-3.3L	<b>MERCURY</b> CAPRI
	1975-1977	L6-3.3L	<b>MERCURY</b> COMET
	1980-1982	L6-3.3L	<b>MERCURY</b> COUGAR
	1983	L6-3.3L	<b>MERCURY</b> MARQUIS
	1975-1977	L6-3.3L	<b>MERCURY</b> MONARCH
	1978-1983	L6-3.3L	<b>MERCURY</b> ZEPHYR
<b>US4003</b>	1978-1980	L4-1.6L	<b>FORD</b> FIESTA
<b>US4005</b>	1977-1982	L4-2.3L	<b>FORD</b> COURIER
	1978-1982	L4-2.3L	<b>FORD</b> FAIRMONT
	1981-1982	L4-2.3L	<b>FORD</b> GRANADA
	1979-1982	L4-2.3L	<b>FORD</b> MUSTANG
	1975-1978	L4-2.3L	<b>FORD</b> MUSTANG II
	1975-1980	L4-2.3L	<b>FORD</b> PINTO
	1975-1980	L4-2.3L	<b>MERCURY</b> BOBCAT
	1975-1982	L4-2.3L	<b>MERCURY</b> CAPRI
	1978-1982	L4-2.3L	<b>MERCURY</b> ZEPHYR
<b>US4014</b>	1981-1982	V8-4.2L	<b>FORD</b> LTD
	1980-1982	V8-4.2L	<b>FORD</b> THUNDERBIRD
	1980-1982	V8-4.2L	<b>MERCURY</b> COUGAR
	1981-1982	V8-4.2L	<b>MERCURY</b> GRAND MARQUIS
	1981-1982	V8-4.2L	<b>MERCURY</b> MARQUIS
	1987-1988	V8-5.0L	<b>FORD</b> COUNTRY SQUIRE
	1980-1986	V8-5.0L	<b>FORD</b> LTD
	1987-1988	V8-5.0L	<b>FORD</b> LTD CROWN VICTORIA
	1980-1985	V8-5.0L	<b>FORD</b> THUNDERBIRD
	1983-1984	V8-5.0L	<b>LINCOLN</b> CONTINENTAL
	1980	V8-5.0L	<b>LINCOLN</b> MARK VI
	1984	V8-5.0L	<b>LINCOLN</b> MARK VII
	1982-1988	V8-5.0L	<b>LINCOLN</b> TOWN CAR
	1987-1988	V8-5.0L	<b>MERCURY</b> COLONY PARK
	1980-1985	V8-5.0L	<b>MERCURY</b> COUGAR
	1979-1988	V8-5.0L	<b>MERCURY</b> GRAND MARQUIS
	1980-1985	V8-5.0L	<b>MERCURY</b> MARQUIS
	1980-1986	V8-5.8L	<b>FORD</b> LTD
	1987-1991	V8-5.8L	<b>FORD</b> LTD CROWN VICTORIA
	1980	V8-5.8L	<b>LINCOLN</b> CONTINENTAL
	1980-1983	V8-5.8L	<b>LINCOLN</b> MARK VI
	1979-1988	V8-5.8L	<b>MERCURY</b> GRAND MARQUIS
	1980-1981	V8-5.8L	<b>MERCURY</b> MARQUIS
<b>US4016</b>	1985-1987	L6-3.8L	<b>FORD</b> COUGAR (MEX)
	1984-1990	L6-3.8L	<b>FORD</b> F-150 (MEX)
	1984	L6-3.8L	<b>FORD</b> THUNDERBIRD (MEX)
	1982-1983	V6-3.8L	<b>FORD</b> F-100
	1982	V6-3.8L	<b>FORD</b> GRANADA
	1983-1986	V6-3.8L	<b>FORD</b> LTD
	1983-1986	V6-3.8L	<b>FORD</b> MUSTANG
	1982-1987	V6-3.8L	<b>FORD</b> THUNDERBIRD
	1982	V6-3.8L	<b>LINCOLN</b> CONTINENTAL
	1983-1986	V6-3.8L	<b>MERCURY</b> CAPRI
	1982-1987	V6-3.8L	<b>MERCURY</b> COUGAR
	1983-1986	V6-3.8L	<b>MERCURY</b> MARQUIS
<b>US4018</b>	1983-1987	V8-6.9L	<b>FORD</b> E-250 ECONOLINE CLUB WAGON
	1983-1987	V8-6.9L	<b>FORD</b> E-350 ECONOLINE
	1983-1987	V8-6.9L	<b>FORD</b> E-350 ECONOLINE CLUB WAGON
	1983-1987	V8-6.9L	<b>FORD</b> F-250

USMW	Years	Cyl.	Specifications
	1983-1987	V8-6.9L	FORD F-350
	1988-1991	V8-7.3L	FORD E-250 ECONOLINE CLUB WAGON
	1988-1994	V8-7.3L	FORD E-350 ECONOLINE
	1988-1994	V8-7.3L	FORD E-350 ECONOLINE CLUB WAGON
	1990-1994	V8-7.3L	FORD F SUPER DUTY
	1988-1994	V8-7.3L	FORD F-250
	1988-1994	V8-7.3L	FORD F-350
<b>US4020</b>	1983-1986	L6-4.9L	FORD BRONCO
	1983	L6-4.9L	FORD E-100 ECONOLINE
	1983	L6-4.9L	FORD E-100 ECONOLINE CLUB WAGON
	1983-1986	L6-4.9L	FORD E-150 ECONOLINE
	1983-1986	L6-4.9L	FORD E-150 ECONOLINE CLUB WAGON
	1983-1986	L6-4.9L	FORD E-250 ECONOLINE
	1983-1986	L6-4.9L	FORD E-250 ECONOLINE CLUB WAGON
	1983-1986	L6-4.9L	FORD E-350 ECONOLINE
	1983-1986	L6-4.9L	FORD E-350 ECONOLINE CLUB WAGON
	1983	L6-4.9L	FORD F-100
	1983-1986	L6-4.9L	FORD F-150
	1983-1986	L6-4.9L	FORD F-250
	1983-1986	L6-4.9L	FORD F-350
<b>US4022</b>	1990	L4-2.3L	FORD GHIA (MEX)
	1984-1991	L4-2.3L	FORD TEMPO
	1986-1991	L4-2.3L	FORD TOPAZ (MEX)
	1984-1991	L4-2.3L	MERCURY TOPAZ
	1984-1989	L4-2.3L	MERCURY TOPAZ (MEX)
<b>US4023</b>	1986	V6-2.8L	FORD AEROSTAR
	1984-1985	V6-2.8L	FORD BRONCO II
	1983-1985	V6-2.8L	FORD RANGER
<b>US4024</b>	1980-1982	V8-4.2L	FORD MUSTANG
	1980-1982	V8-4.2L	MERCURY CAPRI
	1985	V8-5.0L	FORD LTD
	1979-1985	V8-5.0L	FORD MUSTANG
	1974-1984	V8-5.0L	FORD MUSTANG (MEX)
	1985	V8-5.0L	LINCOLN CONTINENTAL
	1985	V8-5.0L	LINCOLN MARK VII
	1979-1985	V8-5.0L	MERCURY CAPRI
<b>US4024H</b>	1980-1982	V8-4.2L	FORD MUSTANG
	1980-1982	V8-4.2L	MERCURY CAPRI
	1985	V8-5.0L	FORD LTD
	1979-1985	V8-5.0L	FORD MUSTANG
	1985	V8-5.0L	LINCOLN CONTINENTAL
	1985	V8-5.0L	LINCOLN MARK VII
	1979-1985	V8-5.0L	MERCURY CAPRI
<b>US4030N</b>	1980-1982	L6-4.9L	FORD BRONCO
	1975-1982	L6-4.9L	FORD E-100 ECONOLINE
	1975-1982	L6-4.9L	FORD E-100 ECONOLINE CLUB WAGON
	1975-1982	L6-4.9L	FORD E-150 ECONOLINE
	1975-1982	L6-4.9L	FORD E-150 ECONOLINE CLUB WAGON
	1975-1982	L6-4.9L	FORD E-250 ECONOLINE
	1977-1980	L6-4.9L	FORD E-250 ECONOLINE CLUB WAGON
	1975-1982	L6-4.9L	FORD E-350 ECONOLINE
	1977-1982	L6-4.9L	FORD E-350 ECONOLINE CLUB WAGON
	1975-1982	L6-4.9L	FORD F-100
	1975-1982	L6-4.9L	FORD F-150
	1975-1982	L6-4.9L	FORD F-250
	1975-1982	L6-4.9L	FORD F-350
<b>US4033</b>	1975-1977	L6-4.9L	FORD E-150 ECONOLINE
	1975-1977	L6-4.9L	FORD E-150 ECONOLINE CLUB WAGON
	1975-1977	L6-4.9L	FORD E-250 ECONOLINE
	1977	L6-4.9L	FORD E-250 ECONOLINE CLUB WAGON
	1975-1977	L6-4.9L	FORD E-350 ECONOLINE
	1977	L6-4.9L	FORD E-350 ECONOLINE CLUB WAGON
	1975-1977	L6-4.9L	FORD F-150
	1975-1977	L6-4.9L	FORD F-250
	1975-1977	L6-4.9L	FORD F-350
<b>US4034</b>	1986-1994	V6-3.0L	FORD TAURUS
	1986-1994	V6-3.0L	MERCURY SABLE
<b>US4035</b>	1984-1985	V8-5.0L	FORD MUSTANG
	1985	V8-5.0L	MERCURY CAPRI

USMW	Years	Cyl.	Specifications
<b>US4038</b>	1986-1993	V8-5.0L	FORD MUSTANG
	1986-1988	V8-5.0L	FORD THUNDERBIRD
	1986-1987	V8-5.0L	LINCOLN CONTINENTAL
	1985-1992	V8-5.0L	LINCOLN MARK VII
	1986	V8-5.0L	MERCURY CAPRI
	1986-1988	V8-5.0L	MERCURY COUGAR
<b>US4038H</b>	1986-1993	V8-5.0L	FORD MUSTANG
	1986-1988	V8-5.0L	FORD THUNDERBIRD
	1986-1987	V8-5.0L	LINCOLN CONTINENTAL
	1985-1992	V8-5.0L	LINCOLN MARK VII
	1986	V8-5.0L	MERCURY CAPRI
	1986-1988	V8-5.0L	MERCURY COUGAR
<b>US4039</b>	1986-1994	V6-3.0L	FORD AEROSTAR
	1991-1997	V6-3.0L	FORD RANGER
	1994	V6-3.0L	MAZDA B3000
<b>US4040</b>	1981-1985	L4-1.6L	FORD ESCORT
	1982-1985	L4-1.6L	FORD EXP
	1982-1983	L4-1.6L	MERCURY LN7
	1981-1985	L4-1.6L	MERCURY LYNX
	1985-1990	L4-1.9L	FORD ESCORT
	1986-1988	L4-1.9L	FORD EXP
	1985-1987	L4-1.9L	MERCURY LYNX
<b>US4041</b>	1991-1992	L4-2.3L	FORD GHIA (MEX)
	1992-1994	L4-2.3L	FORD TEMPO
	1992-1994	L4-2.3L	FORD TOPAZ (MEX)
	1992-1994	L4-2.3L	MERCURY TOPAZ
<b>US4042</b>	1997	V6-2.9L	FORD BRONCO (MEX)
	1986-1990	V6-2.9L	FORD BRONCO II
	1986-1992	V6-2.9L	FORD RANGER
<b>US4044</b>	1987-1992	V8-5.0L	FORD B200 (MEX)
	1987-1996	V8-5.0L	FORD BRONCO
	1987-1996	V8-5.0L	FORD E-150 ECONOLINE
	1987-1996	V8-5.0L	FORD E-150 ECONOLINE CLUB WAGON
	1987-1991	V8-5.0L	FORD E-250 ECONOLINE
	1999-2002	V8-5.0L	FORD ECONOLINE WAGON (MEX)
	1987-1996	V8-5.0L	FORD F-150
	1986-1990	V8-5.0L	FORD F-150 (MEX)
	1986-1990	V8-5.0L	FORD F-200 (MEX)
	1987-1996	V8-5.0L	FORD F-250
	1997	V8-5.0L	FORD F-250 (MEX)
	1987-1997	V8-5.0L	FORD F-350 (MEX)
	1989-1991	V8-5.0L	FORD P350 (MEX)
	1988-1996	V8-5.8L	FORD BRONCO
	1988-1996	V8-5.8L	FORD E-150 ECONOLINE
	1988-1996	V8-5.8L	FORD E-150 ECONOLINE CLUB WAGON
	1988-1996	V8-5.8L	FORD E-250 ECONOLINE
	1988-1991	V8-5.8L	FORD E-250 ECONOLINE CLUB WAGON
	1988-1996	V8-5.8L	FORD E-350 ECONOLINE
	1988-1996	V8-5.8L	FORD E-350 ECONOLINE CLUB WAGON
	1996	V8-5.8L	FORD ECONOLINE SUPER DUTY
	1988-1996	V8-5.8L	FORD F-150
	1986-1990	V8-5.8L	FORD F-200 (MEX)
	1988-1997	V8-5.8L	FORD F-250
	1988-1997	V8-5.8L	FORD F-350
	1987-1990	V8-5.8L	FORD F-350 (MEX)
	1988-1997	V8-5.8L	FORD P350 (MEX)
<b>US4044H</b>	1987-1992	V8-5.0L	FORD B200 (MEX)
	1987-1996	V8-5.0L	FORD BRONCO
	1987-1996	V8-5.0L	FORD E-150 ECONOLINE
	1987-1996	V8-5.0L	FORD E-150 ECONOLINE CLUB WAGON
	1987-1991	V8-5.0L	FORD E-250 ECONOLINE
	1999-2002	V8-5.0L	FORD ECONOLINE WAGON (MEX)
	1987-1996	V8-5.0L	FORD F-150
	1986-1990	V8-5.0L	FORD F-150 (MEX)
	1986-1990	V8-5.0L	FORD F-200 (MEX)
	1987-1996	V8-5.0L	FORD F-250
	1997	V8-5.0L	FORD F-250 (MEX)
	1987-1997	V8-5.0L	FORD F-350 (MEX)
	1989-1991	V8-5.0L	FORD P350 (MEX)



USMW	Years	Cyl.	Specifications
	1988-1996	V8-5.8L	FORD BRONCO
	1988-1996	V8-5.8L	FORD E-150 ECONOLINE
	1988-1996	V8-5.8L	FORD E-150 ECONOLINE CLUB WAGON
	1988-1996	V8-5.8L	FORD E-250 ECONOLINE
	1988-1991	V8-5.8L	FORD E-250 ECONOLINE CLUB WAGON
	1988-1996	V8-5.8L	FORD E-350 ECONOLINE
	1988-1996	V8-5.8L	FORD E-350 ECONOLINE CLUB WAGON
	1996	V8-5.8L	FORD ECONOLINE SUPER DUTY
	1988-1996	V8-5.8L	FORD F-150
	1986-1990	V8-5.8L	FORD F-200 (MEX)
	1988-1997	V8-5.8L	FORD F-250
	1988-1997	V8-5.8L	FORD F-350
	1987-1990	V8-5.8L	FORD F-350 (MEX)
	1988-1997	V8-5.8L	FORD P350 (MEX)
<b>US4045</b>	1988-1989	V6-2.9L	MERKUR SCORPIO
<b>US4048</b>	1987-1992	L6-4.9L	FORD BRONCO
	1987-1991	L6-4.9L	FORD E-150 ECONOLINE
	1987-1991	L6-4.9L	FORD E-150 ECONOLINE CLUB WAGON
	1987-1991	L6-4.9L	FORD E-250 ECONOLINE
	1987-1991	L6-4.9L	FORD E-250 ECONOLINE CLUB WAGON
	1987-1991	L6-4.9L	FORD E-350 ECONOLINE
	1987-1991	L6-4.9L	FORD E-350 ECONOLINE CLUB WAGON
	1987-1992	L6-4.9L	FORD F-150
	1987-1992	L6-4.9L	FORD F-250
	1987-1991	L6-4.9L	FORD F-350
<b>US4049</b>	1994-1997	L4-1.3L	FORD ASPIRE
	1988-1993	L4-1.3L	FORD FESTIVA
	1986	L4-1.5L	MAZDA FAMILIA (MEX)
	1994-1995	L4-1.6L	KIA SEPHIA
	1986-1994	L4-1.6L	MAZDA 323
	1986	L4-1.6L	MAZDA FAMILIA (MEX)
	1992-1993	L4-1.6L	MAZDA MX-3
	1988-1989	L4-1.6L	MERCURY TRACER
	1990-1994	L4-1.8L	MAZDA PROTEGE
<b>US4050</b>	1988-1993	V6-3.8L	FORD COUGAR (MEX)
	1988-1993	V6-3.8L	FORD THUNDERBIRD
	1988-1993	V6-3.8L	MERCURY COUGAR
<b>US4051</b>	1991-1993	V6-3.8L	FORD F-150 (MEX)
	1988-1993	V6-3.8L	FORD TAURUS
	1988-1993	V6-3.8L	LINCOLN CONTINENTAL
	1988-1993	V6-3.8L	MERCURY SABLE
<b>US4052</b>	1988-1991	V8-5.0L	FORD COUNTRY SQUIRE
	1991-1992	V8-5.0L	FORD GRAND MARQUIS (MEX)
	1988-1991	V8-5.0L	FORD LTD CROWN VICTORIA
	1988-1990	V8-5.0L	LINCOLN TOWN CAR
	1988-1991	V8-5.0L	MERCURY COLONY PARK
	1988-1991	V8-5.0L	MERCURY GRAND MARQUIS
	1979-1980	V8-5.8L	FORD LTD (MEX)
	1979-1981	V8-5.8L	MERCURY GRAND MARQUIS (MEX)
<b>US4052H</b>	1988-1991	V8-5.0L	FORD COUNTRY SQUIRE
	1991-1992	V8-5.0L	FORD GRAND MARQUIS (MEX)
	1988-1991	V8-5.0L	FORD LTD CROWN VICTORIA
	1988-1990	V8-5.0L	LINCOLN TOWN CAR
	1988-1991	V8-5.0L	MERCURY COLONY PARK
	1988-1991	V8-5.0L	MERCURY GRAND MARQUIS
	1979-1980	V8-5.8L	FORD LTD (MEX)
	1979-1981	V8-5.8L	MERCURY GRAND MARQUIS (MEX)
<b>US4053</b>	1995	L4-2.0L	KIA SPORTAGE
	1989-1992	L4-2.2L	FORD PROBE
	1988-1992	L4-2.2L	MAZDA 626
	1987-1993	L4-2.2L	MAZDA B2200
	1988-1992	L4-2.2L	MAZDA MX-6
<b>US4054</b>	1983-1988	L4-2.0L	FORD RANGER
	1986-1987	L4-2.3L	FORD AEROSTAR
	1983	L4-2.3L	FORD FAIRMONT
	1983-1986	L4-2.3L	FORD LTD
	1983-1993	L4-2.3L	FORD MUSTANG
	1983-1994	L4-2.3L	FORD RANGER
	1983-1988	L4-2.3L	FORD THUNDERBIRD

USMW	Years	Cyl.	Specifications
	1994	L4-2.3L	MAZDA B2300
	1983-1986	L4-2.3L	MERCURY CAPRI
	1984-1986	L4-2.3L	MERCURY COUGAR
	1983-1986	L4-2.3L	MERCURY MARQUIS
	1983	L4-2.3L	MERCURY ZEPHYR
	1985-1989	L4-2.3L	MERKUR XR4TI
<b>US4055</b>	1990-1995	V6-3.8L	FORD THUNDERBIRD
	1990	V6-3.8L	MERCURY COUGAR
<b>US4056</b>	1986-1991	L4-2.5L	FORD TAURUS
	1986	L4-2.5L	MERCURY SABLE
<b>US4057</b>	1991-1994	V8-4.9L	FORD COUGAR (MEX)
	1991-1993	V8-5.0L	FORD THUNDERBIRD
	1991-1993	V8-5.0L	MERCURY COUGAR
<b>US4059</b>	1990-1992	V6-3.0L	FORD PROBE
<b>US4060</b>	1990-1997	V6-4.0L	FORD AEROSTAR
	1991-2000	V6-4.0L	FORD EXPLORER
	1990	V6-4.0L	FORD EXPLORER (MEX)
	1990-2000	V6-4.0L	FORD RANGER
	1994-2000	V6-4.0L	MAZDA B4000
	1991-1994	V6-4.0L	MAZDA NAVAJO
<b>US4061</b>	1989-1995	V6-3.0L	FORD TAURUS
<b>US4065</b>	1991	L4-1.9L	FORD ESCORT
	1991	L4-1.9L	MERCURY TRACER
<b>US4066</b>	1992-1997	V8-4.6L	FORD CROWN VICTORIA
	1993-1997	V8-4.6L	FORD GRAND MARQUIS (MEX)
	1991-1997	V8-4.6L	LINCOLN TOWN CAR
	1992-1997	V8-4.6L	MERCURY GRAND MARQUIS
<b>US4067</b>	1972	V6-2.6L	MERCURY CAPRI
<b>US4068</b>	1988-1989	L4-1.6L	MAZDA 323
	1990-1993	L4-1.6L	MAZDA MIATA
	1991-1994	L4-1.6L	MERCURY CAPRI
	1991-1996	L4-1.8L	FORD ESCORT
	1990-1992	L4-1.8L	MAZDA PROTEGE
	1991-1996	L4-1.8L	MERCURY TRACER
<b>US4069</b>	1991-1996	L4-1.8L	FORD ESCORT
	1991-1996	L4-1.8L	MERCURY TRACER
	1996-1997	L4-1.9L	FORD VAGONETA (MEX)
<b>US4070</b>	1992-1994	V6-3.0L	FORD GHIA (MEX)
	1992-1994	V6-3.0L	FORD TEMPO
	1992-1993	V6-3.0L	FORD TOPAZ (MEX)
	1992-1994	V6-3.0L	MERCURY TOPAZ
<b>US4077</b>	1992-1994	V8-7.5L	FORD E-350 ECONOLINE
	1992-1994	V8-7.5L	FORD E-350 ECONOLINE CLUB WAGON
	1992-1994	V8-7.5L	FORD F SUPER DUTY
	1992-1994	V8-7.5L	FORD F-250
	1992-1994	V8-7.5L	FORD F-350
<b>US4078</b>	1999-2000	L4-1.8L	MAZDA PROTEGE
	1993-1997	L4-2.0L	FORD PROBE
	1993-2002	L4-2.0L	MAZDA 626
	1993-1997	L4-2.0L	MAZDA MX-6
	2001-2003	L4-2.0L	MAZDA PROTEGE
	2002-2003	L4-2.0L	MAZDA PROTEGE5
<b>US4079</b>	1992	L6-4.9L	FORD E-150 ECONOLINE
	1992	L6-4.9L	FORD E-150 ECONOLINE CLUB WAGON
	1992	L6-4.9L	FORD E-250 ECONOLINE
	1992	L6-4.9L	FORD E-350 ECONOLINE
	1992	L6-4.9L	FORD E-350 ECONOLINE CLUB WAGON
<b>US4081</b>	1988-1989	V8-7.5L	FORD E-250 ECONOLINE CLUB WAGON
	1987-1989	V8-7.5L	FORD E-350 ECONOLINE
	1988-1989	V8-7.5L	FORD E-350 ECONOLINE CLUB WAGON
	1988-1989	V8-7.5L	FORD F-250
	1988-1989	V8-7.5L	FORD F-350
<b>US4082</b>	1993-1995	V6-3.2L	FORD TAURUS
<b>US4083</b>	1984	L6-4.9L	FORD E-250 ECONOLINE
	1984	L6-4.9L	FORD E-250 ECONOLINE CLUB WAGON
	1984	L6-4.9L	FORD E-350 ECONOLINE
	1984	L6-4.9L	FORD E-350 ECONOLINE CLUB WAGON
<b>US4086</b>	1995-1996	V8-7.5L	FORD E-350 ECONOLINE
	1995-1996	V8-7.5L	FORD E-350 ECONOLINE CLUB WAGON

WATER PUMPS

USMW	Years	Cyl.	Specifications
	1996	V8-7.5L	FORD ECONOLINE SUPER DUTY
	1995-1997	V8-7.5L	FORD F SUPER DUTY
	1995-1997	V8-7.5L	FORD F-250
	1995-1997	V8-7.5L	FORD F-350
	1995-1997	V8-7.5L	FORD F53
<b>US4087</b>	1994-1995	V8-5.0L	FORD MUSTANG
<b>US4088</b>	1995-1997	L4-2.0L	FORD CONTOUR
	1994-1997	L4-2.0L	FORD MYSTIQUE (MEX)
	1995-1997	L4-2.0L	MERCURY MYSTIQUE
<b>US4089</b>	1994-1995	V6-3.8L	FORD F-150 (MEX)
	1994-1995	V6-3.8L	FORD SABLE (MEX)
	1994-1995	V6-3.8L	FORD TAURUS
	1995	V6-3.8L	FORD WINDSTAR
	1994	V6-3.8L	FORD WINDSTAR (MEX)
	1994	V6-3.8L	LINCOLN CONTINENTAL
	1994-1995	V6-3.8L	MERCURY SABLE
<b>US4090</b>	1994-1995	V6-3.8L	FORD COUGAR (MEX)
	1994-1995	V6-3.8L	FORD MUSTANG
	1994-1995	V6-3.8L	FORD THUNDERBIRD
	1994-1995	V6-3.8L	MERCURY COUGAR
<b>US4091</b>	1995-2000	V6-2.5L	FORD CONTOUR
	2002-2007	V6-2.5L	FORD MONDEO (MEX)
	2001	V6-2.5L	FORD MONDEO TREND (MEX)
	1995-2000	V6-2.5L	FORD MYSTIQUE (MEX)
	2000-2001	V6-2.5L	MAZDA MPV
	1999-2002	V6-2.5L	MERCURY COUGAR
	1995-2000	V6-2.5L	MERCURY MYSTIQUE
	2001-2003	V6-3.0L	FORD ESCAPE
	2005	V6-3.0L	FORD MONDEO ST (MEX)
	2001-2003	V6-3.0L	FORD TAURUS
	2002-2003	V6-3.0L	MAZDA MPV
	2001-2004	V6-3.0L	MAZDA TRIBUTE
	2001-2004	V6-3.0L	MERCURY SABLE
<b>US4093</b>	1995-1997	L4-2.3L	FORD RANGER
	1995-1997	L4-2.3L	MAZDA B2300
	1998-2001	L4-2.5L	FORD RANGER
	1998-2001	L4-2.5L	MAZDA B2500
<b>US4094</b>	1996-2002	V6-3.0L	FORD SABLE (MEX)
	1995-2007	V6-3.0L	FORD TAURUS
	1995-2000	V6-3.0L	FORD WINDSTAR
	1995-2005	V6-3.0L	MERCURY SABLE
<b>US4095</b>	1995-1997	V6-3.0L	FORD AEROSTAR
	1995-2008	V6-3.0L	FORD RANGER
	1995-2007	V6-3.0L	MAZDA B3000
<b>US4096</b>	1995-1996	L6-4.9L	FORD E-150 ECONOLINE
	1995-1996	L6-4.9L	FORD E-150 ECONOLINE CLUB WAGON
	1995-1996	L6-4.9L	FORD E-350 ECONOLINE
	1995-1996	L6-4.9L	FORD E-350 ECONOLINE CLUB WAGON
	1995	L6-4.9L	FORD F-250
	1995	V8-7.3L	FORD E-350 ECONOLINE
	1995	V8-7.3L	FORD E-350 ECONOLINE CLUB WAGON
	1995	V8-7.3L	FORD F SUPER DUTY
	1994-1995	V8-7.3L	FORD F-250
	1994-1995	V8-7.3L	FORD F-350
<b>US4097</b>	1995-2002	V8-4.6L	LINCOLN CONTINENTAL
<b>US4098</b>	1996-2000	V6-3.0L	FORD TAURUS
	1996-2000	V6-3.0L	MERCURY SABLE
<b>US4099</b>	1993-1994	L6-4.9L	FORD E-150 ECONOLINE
	1993-1994	L6-4.9L	FORD E-150 ECONOLINE CLUB WAGON
	1993-1996	L6-4.9L	FORD E-250 ECONOLINE
	1993-1994	L6-4.9L	FORD E-350 ECONOLINE
	1993-1994	L6-4.9L	FORD E-350 ECONOLINE CLUB WAGON
	1993-1996	L6-4.9L	FORD F-150
	1997	L6-4.9L	FORD F-150 (MEX)
	1993-1996	L6-4.9L	FORD F-250
	1993-1994	L6-4.9L	FORD F-350
<b>US4101</b>	1998	L6-4.8L	FORD EXPLORER (MEX)
	1996-2001	V8-5.0L	FORD EXPLORER
	1997-2001	V8-5.0L	MERCURY MOUNTAINEER

USMW	Years	Cyl.	Specifications
<b>US4102</b>	1996-2003	V6-3.8L	FORD WINDSTAR
	2004-2007	V6-3.9L	FORD FREESTAR
	2009	V6-4.2L	FORD F-150 (MEX)
	2004-2007	V6-4.2L	FORD FREESTAR
	2004-2007	V6-4.2L	MERCURY MONTEREY
<b>US4103</b>	1996	V6-3.8L	FORD COUGAR (MEX)
	1996-2004	V6-3.8L	FORD MUSTANG
	1996-1997	V6-3.8L	FORD THUNDERBIRD
	1996-1997	V6-3.8L	MERCURY COUGAR
	2004	V6-3.9L	FORD MUSTANG
<b>US4104</b>	1998-2000	L4-1.4L	FORD FIESTA (MEX)
<b>US4105</b>	2003	V6-4.2L	FORD E-150
	2003	V6-4.2L	FORD E-150 CLUB WAGON
	1997-2002	V6-4.2L	FORD E-150 ECONOLINE
	1997-2002	V6-4.2L	FORD E-150 ECONOLINE CLUB WAGON
	2003	V6-4.2L	FORD E-250
	1997-2002	V6-4.2L	FORD E-250 ECONOLINE
	1999-2002	V6-4.2L	FORD ECONOLINE WAGON (MEX)
	1997-2008	V6-4.2L	FORD F-150
	2004	V6-4.2L	FORD F-150 HERITAGE
<b>US4106</b>	1996-1999	V8-3.4L	FORD TAURUS
<b>US4107</b>	1997-2002	L4-2.0L	FORD ESCORT
	1997-1999	L4-2.0L	MERCURY TRACER
<b>US4108</b>	1997-2010	V6-4.0L	FORD EXPLORER
	2001-2010	V6-4.0L	FORD EXPLORER SPORT TRAC
	2005-2010	V6-4.0L	FORD MUSTANG
	2001-2011	V6-4.0L	FORD RANGER
	2001-2009	V6-4.0L	MAZDA B4000
	1998-2010	V6-4.0L	MERCURY MOUNTAINEER
<b>US4109</b>	2003	V10-6.8L	FORD E-350
	2003-2005	V10-6.8L	FORD E-350 CLUB WAGON
	1997-2002	V10-6.8L	FORD E-350 ECONOLINE
	1997-2002	V10-6.8L	FORD E-350 ECONOLINE CLUB WAGON
	2004-2009	V10-6.8L	FORD E-350 SUPER DUTY
	2000-2002	V10-6.8L	FORD E-450 ECONOLINE SUPER DUTY
	2000-2002	V10-6.8L	FORD E-450 ECONOLINE SUPER DUTY STRIPPED
	2003-2009	V10-6.8L	FORD E-450 SUPER DUTY
	2003	V10-6.8L	FORD E-450 SUPER DUTY STRIPPED CHASSIS
	2002	V10-6.8L	FORD E-550 ECONOLINE SUPER DUTY
	2003	V10-6.8L	FORD E-550 SUPER DUTY
	1997-1999	V10-6.8L	FORD ECONOLINE SUPER DUTY
	2000-2005	V10-6.8L	FORD EXCURSION
	1999-2009	V10-6.8L	FORD F-250 SUPER DUTY
	1999-2009	V10-6.8L	FORD F-350 SUPER DUTY
	1999-2008	V10-6.8L	FORD F-450 SUPER DUTY
	1999-2008	V10-6.8L	FORD F-550 SUPER DUTY
<b>US4110</b>	2003-2013	V8-4.6L	FORD E-150
	2003-2005	V8-4.6L	FORD E-150 CLUB WAGON
	2003-2013	V8-4.6L	FORD E-250
	2003-2004	V8-4.6L	FORD EXPEDITION
	2003-2010	V8-4.6L	FORD F-150
	2004	V8-4.6L	FORD F-150 HERITAGE
	2003-2005	V8-4.6L	LINCOLN AVIATOR
	2003-2013	V8-5.4L	FORD E-150
	2003-2005	V8-5.4L	FORD E-150 CLUB WAGON
	2003-2013	V8-5.4L	FORD E-250
	2004-2005	V8-5.4L	FORD E-250 SUPER DUTY
	2003	V8-5.4L	FORD E-350
	2003-2005	V8-5.4L	FORD E-350 CLUB WAGON
	2004-2013	V8-5.4L	FORD E-350 SUPER DUTY
	2000-2002	V8-5.4L	FORD E-450 ECONOLINE SUPER DUTY STRIPPED
	2003-2013	V8-5.4L	FORD E-450 SUPER DUTY
	2003	V8-5.4L	FORD E-450 SUPER DUTY STRIPPED CHASSIS
	2003-2005	V8-5.4L	FORD EXCURSION
	2003-2009	V8-5.4L	FORD EXPEDITION
	2003-2006	V8-5.4L	FORD F-150
	2004	V8-5.4L	FORD F-150 HERITAGE
	2003-2010	V8-5.4L	FORD F-250 SUPER DUTY
	2003-2010	V8-5.4L	FORD F-350 SUPER DUTY

USMW	Years	Cyl.	Specifications
	2006	V8-5.4L	LINCOLN MARK LT
	2002-2009	V8-5.4L	LINCOLN NAVIGATOR
<b>US4113</b>	1998-2002	V8-4.6L	FORD CROWN VICTORIA
	1998-2001	V8-4.6L	FORD GRAND MARQUIS (MEX)
	1996-2009	V8-4.6L	FORD MUSTANG
	1994-1997	V8-4.6L	FORD THUNDERBIRD
	1993-1998	V8-4.6L	LINCOLN MARK VIII
	1998-2002	V8-4.6L	LINCOLN TOWN CAR
	1994-1997	V8-4.6L	MERCURY COUGAR
	1998-2002	V8-4.6L	MERCURY GRAND MARQUIS
<b>US4114</b>	2003	V8-7.3L	FORD E-350
	2003	V8-7.3L	FORD E-350 CLUB WAGON
	1996-2002	V8-7.3L	FORD E-350 ECONOLINE
	1996-2002	V8-7.3L	FORD E-350 ECONOLINE CLUB WAGON
	2000-2002	V8-7.3L	FORD E-450 ECONOLINE SUPER DUTY
	2000-2002	V8-7.3L	FORD E-450 ECONOLINE SUPER DUTY STRIPPED
	2003	V8-7.3L	FORD E-450 SUPER DUTY
	2003	V8-7.3L	FORD E-450 SUPER DUTY STRIPPED CHASSIS
	2002	V8-7.3L	FORD E-550 ECONOLINE SUPER DUTY
	2003	V8-7.3L	FORD E-550 SUPER DUTY
	1996-1999	V8-7.3L	FORD ECONOLINE SUPER DUTY
	2000-2003	V8-7.3L	FORD EXCURSION
	1996-1997	V8-7.3L	FORD F SUPER DUTY
	1996-1997	V8-7.3L	FORD F-250
	1999-2003	V8-7.3L	FORD F-250 SUPER DUTY
	1996-1997	V8-7.3L	FORD F-350
	1999-2003	V8-7.3L	FORD F-350 SUPER DUTY
	1999-2003	V8-7.3L	FORD F-450 SUPER DUTY
	1999-2003	V8-7.3L	FORD F-550 SUPER DUTY
<b>US4115</b>	1998-2000	L4-2.0L	FORD CONTOUR
	2004	L4-2.0L	FORD ECOSPORT (MEX)
	2001-2004	L4-2.0L	FORD ESCAPE
	1998-2003	L4-2.0L	FORD ESCORT
	2000-2004	L4-2.0L	FORD FOCUS
	2001-2004	L4-2.0L	MAZDA TRIBUTE
	1999-2002	L4-2.0L	MERCURY COUGAR
	1998-2000	L4-2.0L	MERCURY MYSTIQUE
<b>US4118</b>	2000-2002	V6-3.0L	JAGUAR S-TYPE
	2000-2002	V6-3.0L	LINCOLN LS
<b>US4119</b>	1999-2002	V8-4.6L	FORD CROWN VICTORIA
	1999-2006	V8-4.6L	FORD MUSTANG
<b>US4121</b>	1999-2000	V8-4.6L	FORD F-150
	2000	V8-5.4L	FORD F-350 (MEX)
<b>US4122</b>	1997-2002	V8-4.6L	FORD E-150 ECONOLINE
	1997-2002	V8-4.6L	FORD E-150 ECONOLINE CLUB WAGON
	1997	V8-4.6L	FORD E-250 ECONOLINE
	1997-2002	V8-4.6L	FORD EXPEDITION
	1996	V8-4.6L	FORD EXPEDITION (MEX)
	1997-2002	V8-4.6L	FORD F-150
	1997-1999	V8-4.6L	FORD F-250
	2000-2009	V8-4.6L	FORD F-250 (MEX)
	1997-2010	V8-4.6L	FORD LOBO (MEX)
	1997-2002	V8-5.4L	FORD E-150 ECONOLINE
	1997-2002	V8-5.4L	FORD E-150 ECONOLINE CLUB WAGON
	1997-2002	V8-5.4L	FORD E-250 ECONOLINE
	1997-2002	V8-5.4L	FORD E-350 ECONOLINE
	1997-2002	V8-5.4L	FORD E-350 ECONOLINE CLUB WAGON
	1997-1999	V8-5.4L	FORD ECONOLINE SUPER DUTY
	2000-2002	V8-5.4L	FORD EXCURSION
	1997-2002	V8-5.4L	FORD EXPEDITION
	1997-2002	V8-5.4L	FORD F-150
	1997-1999	V8-5.4L	FORD F-250
	1999-2002	V8-5.4L	FORD F-250 SUPER DUTY
	1999	V8-5.4L	FORD F-350 (MEX)
	1999-2002	V8-5.4L	FORD F-350 SUPER DUTY
	2002-2003	V8-5.4L	FORD LOBO (MEX)
	2002	V8-5.4L	LINCOLN BLACKWOOD
	2010	V8-5.4L	LINCOLN MARK LT (MEX)
	1998-2001	V8-5.4L	LINCOLN NAVIGATOR

USMW	Years	Cyl.	Specifications
<b>US4123</b>	2000-2004	L4-2.0L	FORD FOCUS
<b>US4124</b>	2002-2005	V8-3.9L	FORD THUNDERBIRD
	2000-2006	V8-3.9L	LINCOLN LS
	2000-2002	V8-4.0L	JAGUAR S-TYPE
	1998-2005	V8-4.0L	JAGUAR VANDEN PLAS
	1998-2003	V8-4.0L	JAGUAR XJ8
	1998-2003	V8-4.0L	JAGUAR XJR
	1997-2002	V8-4.0L	JAGUAR XK8
	2000-2002	V8-4.0L	JAGUAR XKR
	2003-2008	V8-4.2L	JAGUAR S-TYPE
	2005-2009	V8-4.2L	JAGUAR SUPER V8
	2006-2009	V8-4.2L	JAGUAR VANDEN PLAS
	2009-2010	V8-4.2L	JAGUAR XF
	2004-2009	V8-4.2L	JAGUAR XJ8
	2004-2009	V8-4.2L	JAGUAR XJR
	2007-2009	V8-4.2L	JAGUAR XK
	2003-2006	V8-4.2L	JAGUAR XK8
	2003-2009	V8-4.2L	JAGUAR XKR
	2005-2009	V8-4.4L	LAND ROVER LR3
	2006-2009	V8-4.4L	LAND ROVER RANGE ROVER
	2006-2009	V8-4.4L	LAND ROVER RANGE ROVER SPORT
<b>US4125</b>	2007	V8-4.6L	FORD LOBO (MEX)
	2001-2004	V8-5.4L	FORD F-150
	2004	V8-5.4L	FORD F-150 HERITAGE
	2001-2008	V8-5.4L	FORD LOBO
	1999-2010	V8-5.4L	FORD LOBO (MEX)
<b>US4126</b>	2005-2009	L4-2.0L	FORD ECOSPORT (MEX)
	2012	L4-2.0L	FORD FOCUS
	2010-2011	L4-2.0L	FORD FOCUS (MEX)
	2002-2007	L4-2.0L	FORD MONDEO (MEX)
	2010-2012	L4-2.0L	FORD TRANSIT CONNECT
	2004-2005	L4-2.0L	MAZDA 3
	2005-2008	L4-2.3L	FORD ESCAPE
	2003-2011	L4-2.3L	FORD FOCUS
	2006-2009	L4-2.3L	FORD FUSION
	2001-2011	L4-2.3L	FORD RANGER
	2004-2012	L4-2.3L	MAZDA 3
	2006-2007	L4-2.3L	MAZDA 5
	2003-2008	L4-2.3L	MAZDA 6
	2001-2009	L4-2.3L	MAZDA B2300
	2007-2012	L4-2.3L	MAZDA CX-7
	2005-2011	L4-2.3L	MAZDA TRIBUTE
	2005-2008	L4-2.3L	MERCURY MARINER
	2006-2009	L4-2.3L	MERCURY MILAN
	2009-2012	L4-2.5L	FORD ESCAPE
	2010-2012	L4-2.5L	FORD FUSION
	2011-2012	L4-2.5L	LINCOLN MKZ
	2009-2010	L4-2.5L	MAZDA 6
	2009-2011	L4-2.5L	MERCURY MARINER
	2010-2011	L4-2.5L	MERCURY MILAN
<b>US4127</b>	2002-2010	V8-4.6L	FORD EXPLORER
	2007-2010	V8-4.6L	FORD EXPLORER SPORT TRAC
	2010	V8-4.6L	FORD EXPLORER SPORT TRAC (MEX)
	2009	V8-4.6L	FORD F-150
	2002-2010	V8-4.6L	MERCURY MOUNTAINEER
<b>US4128</b>	2001-2011	V8-4.6L	FORD CROWN VICTORIA
	2002-2004	V8-4.6L	FORD GRAND MARQUIS (MEX)
	2001-2004	V8-4.6L	FORD MUSTANG
	2001-2011	V8-4.6L	LINCOLN TOWN CAR
	2001-2011	V8-4.6L	MERCURY GRAND MARQUIS
	2003-2004	V8-4.6L	MERCURY MARAUDER
	2003	V8-5.4L	LINCOLN BLACKWOOD (MEX)
<b>US4129</b>	2003-2008	V6-3.0L	JAGUAR S-TYPE
	2003-2005	V6-3.0L	LINCOLN LS
<b>US4130</b>	1999-2002	V8-4.6L	FORD E-150 ECONOLINE
	2000-2002	V8-5.4L	FORD E-150 ECONOLINE
	2000-2002	V8-5.4L	FORD E-150 ECONOLINE CLUB WAGON
	1997-2002	V8-5.4L	FORD E-250 ECONOLINE
	1997-2002	V8-5.4L	FORD E-350 ECONOLINE



USMW	Years	Cyl.	Specifications
	1997-2002	V8-5.4L	FORD E-350 ECONOLINE CLUB WAGON
	2000-2002	V8-5.4L	FORD E-450 ECONOLINE SUPER DUTY
	2000-2002	V8-5.4L	FORD E-450 ECONOLINE SUPER DUTY STRIPPED
	2001-2002	V8-5.4L	FORD EXPEDITION
	2000-2002	V8-5.4L	FORD F-250 SUPER DUTY
<b>US4132</b>	2003-2006	V6-3.0L	FORD ESCAPE
	2003-2005	V6-3.0L	FORD TAURUS
	2003-2006	V6-3.0L	MAZDA MPV
	2005-2008	V6-3.0L	MAZDA TRIBUTE
	2005-2006	V6-3.0L	MERCURY MARINER
	2003-2005	V6-3.0L	MERCURY SABLE
<b>US5000</b>	1982-1986	L4-2.5L	BUICK CENTURY
	1980-1991	L4-2.5L	BUICK SKYLARK
	1986-1987	L4-2.5L	BUICK SOMERSET
	1985	L4-2.5L	BUICK SOMERSET REGAL
	1982-1986	L4-2.5L	CHEVROLET CELEBRITY
	1980-1983	L4-2.5L	CHEVROLET CITATION
	1984-1985	L4-2.5L	CHEVROLET CITATION II
	1985-1987	L4-2.5L	OLDSMOBILE CALAIS
	1988-1991	L4-2.5L	OLDSMOBILE CUTLASS CALAIS
	1982-1986	L4-2.5L	OLDSMOBILE CUTLASS CIERA
	1980-1984	L4-2.5L	OLDSMOBILE OMEGA
	1982-1986	L4-2.5L	PONTIAC 6000
	1984-1988	L4-2.5L	PONTIAC FIERO
	1985-1991	L4-2.5L	PONTIAC GRAND AM
	1980-1984	L4-2.5L	PONTIAC PHOENIX
<b>US5000P</b>	1982-1986	L4-2.5L	BUICK CENTURY
	1980-1985	L4-2.5L	BUICK SKYLARK
	1987	L4-2.5L	BUICK SOMERSET
	1982-1986	L4-2.5L	CHEVROLET CELEBRITY
	1980-1983	L4-2.5L	CHEVROLET CITATION
	1984-1985	L4-2.5L	CHEVROLET CITATION II
	1982-1986	L4-2.5L	OLDSMOBILE CUTLASS CIERA
	1980-1984	L4-2.5L	OLDSMOBILE OMEGA
	1982-1986	L4-2.5L	PONTIAC 6000
	1980-1984	L4-2.5L	PONTIAC PHOENIX
<b>US5001</b>	1986	V6-2.8L	BUICK CENTURY
	1980-1985	V6-2.8L	BUICK SKYLARK
	1985-1986	V6-2.8L	CHEVROLET CAMARO
	1982-1986	V6-2.8L	CHEVROLET CELEBRITY
	1980-1983	V6-2.8L	CHEVROLET CITATION
	1986-1988	V6-2.8L	CHEVROLET CITATION (MEX)
	1984-1985	V6-2.8L	CHEVROLET CITATION II
	1986	V6-2.8L	OLDSMOBILE CUTLASS CIERA
	1980-1984	V6-2.8L	OLDSMOBILE OMEGA
	1982-1986	V6-2.8L	PONTIAC 6000
	1985-1988	V6-2.8L	PONTIAC FIERO
	1985-1986	V6-2.8L	PONTIAC FIREBIRD
	1980-1984	V6-2.8L	PONTIAC PHOENIX
<b>US5003</b>	1980-1984	V8-6.0L	CADILLAC COMMERCIAL CHASSIS
	1980-1981	V8-6.0L	CADILLAC DEVILLE
	1980-1981	V8-6.0L	CADILLAC ELDORADO
	1980-1984	V8-6.0L	CADILLAC FLEETWOOD
	1980-1981	V8-6.0L	CADILLAC SEVILLE
	1977-1979	V8-7.0L	CADILLAC DEVILLE
	1977-1978	V8-7.0L	CADILLAC ELDORADO
	1977-1979	V8-7.0L	CADILLAC FLEETWOOD
<b>US5004</b>	1976-1987	L4-1.6L	CHEVROLET CHEVETTE
	1981-1987	L4-1.6L	PONTIAC T1000
<b>US5006</b>	1982-1984	V6-2.8L	CHEVROLET CAMARO
	1982-1986	V6-2.8L	CHEVROLET S10
	1983-1986	V6-2.8L	CHEVROLET S10 BLAZER
	1982-1986	V6-2.8L	GMC S15
	1983-1986	V6-2.8L	GMC S15 JIMMY
	1984-1986	V6-2.8L	JEEP CHEROKEE
	1986	V6-2.8L	JEEP COMANCHE
	1984-1986	V6-2.8L	JEEP WAGONEER
	1982-1984	V6-2.8L	PONTIAC FIREBIRD
<b>US5007</b>	1982	L4-1.8L	BUICK SKYHAWK

USMW	Years	Cyl.	Specifications
	1982	L4-1.8L	OLDSMOBILE FIRENZA
	1982	L4-1.8L	PONTIAC J2000
	1983-1986	L4-2.0L	BUICK SKYHAWK
	1982-1986	L4-2.0L	CADILLAC CIMARRON
	1982-1986	L4-2.0L	CHEVROLET CAVALIER
	1983-1986	L4-2.0L	OLDSMOBILE FIRENZA
	1984-1985	L4-2.0L	PONTIAC J2000 SUNBIRD
	1986	L4-2.0L	PONTIAC SUNBIRD
<b>US5008</b>	1992-1993	V8-6.2L	AM GENERAL HUMMER
	1987-1991	V8-6.2L	CHEVROLET BLAZER
	1982-1986	V8-6.2L	CHEVROLET C10
	1982-1986	V8-6.2L	CHEVROLET C10 SUBURBAN
	1982-1986	V8-6.2L	CHEVROLET C20
	1982-1986	V8-6.2L	CHEVROLET C20 SUBURBAN
	1982-1986	V8-6.2L	CHEVROLET C30
	1983-1993	V8-6.2L	CHEVROLET G20
	1983-1993	V8-6.2L	CHEVROLET G30
	1982-1986	V8-6.2L	CHEVROLET K10
	1982-1986	V8-6.2L	CHEVROLET K10 SUBURBAN
	1982-1986	V8-6.2L	CHEVROLET K20
	1982-1986	V8-6.2L	CHEVROLET K20 SUBURBAN
	1982-1986	V8-6.2L	CHEVROLET K30
	1982-1986	V8-6.2L	CHEVROLET K5 BLAZER
	1985-1993	V8-6.2L	CHEVROLET P30
	1987	V8-6.2L	CHEVROLET R10
	1987-1988	V8-6.2L	CHEVROLET R10 SUBURBAN
	1987-1988	V8-6.2L	CHEVROLET R20
	1987-1988	V8-6.2L	CHEVROLET R20 SUBURBAN
	1989	V8-6.2L	CHEVROLET R2500
	1987-1988	V8-6.2L	CHEVROLET R30
	1989-1991	V8-6.2L	CHEVROLET R3500
	1987	V8-6.2L	CHEVROLET V10
	1987-1988	V8-6.2L	CHEVROLET V10 SUBURBAN
	1987	V8-6.2L	CHEVROLET V20
	1987-1988	V8-6.2L	CHEVROLET V20 SUBURBAN
	1987-1988	V8-6.2L	CHEVROLET V30
	1989-1991	V8-6.2L	CHEVROLET V3500
	1982-1986	V8-6.2L	GMC C1500
	1982-1986	V8-6.2L	GMC C1500 SUBURBAN
	1982-1986	V8-6.2L	GMC C2500
	1982-1986	V8-6.2L	GMC C2500 SUBURBAN
	1982-1986	V8-6.2L	GMC C3500
	1983-1993	V8-6.2L	GMC G2500
	1983-1993	V8-6.2L	GMC G3500
	1982-1991	V8-6.2L	GMC JIMMY
	1982-1986	V8-6.2L	GMC K1500
	1982-1986	V8-6.2L	GMC K1500 SUBURBAN
	1982-1986	V8-6.2L	GMC K2500
	1982-1986	V8-6.2L	GMC K2500 SUBURBAN
	1982-1986	V8-6.2L	GMC K3500
	1985-1993	V8-6.2L	GMC P3500
	1987	V8-6.2L	GMC R1500
	1987	V8-6.2L	GMC R1500 SUBURBAN
	1987-1989	V8-6.2L	GMC R2500
	1987	V8-6.2L	GMC R2500 SUBURBAN
	1987-1991	V8-6.2L	GMC R3500
	1987	V8-6.2L	GMC V1500
	1987	V8-6.2L	GMC V1500 SUBURBAN
	1987	V8-6.2L	GMC V2500
	1987	V8-6.2L	GMC V2500 SUBURBAN
	1987-1991	V8-6.2L	GMC V3500
<b>US5010</b>	1982-1984	V8-4.1L	CADILLAC DEVILLE
	1982-1985	V8-4.1L	CADILLAC ELDORADO
	1982-1985	V8-4.1L	CADILLAC FLEETWOOD
	1982-1985	V8-4.1L	CADILLAC SEVILLE
<b>US5012</b>	1982-1984	V6-4.3L	BUICK REGAL
	1982-1983	V6-4.3L	CHEVROLET MALIBU
	1982-1983	V6-4.3L	CHEVROLET MONTE CARLO
	1982-1984	V6-4.3L	OLDSMOBILE CUTLASS CALAIS

USMW	Years	Cyl.	Specifications
	1984	V6-4.3L	OLDSMOBILE CUTLASS SUPREME
<b>US5013</b>	1982-1985	L4-1.9L	CHEVROLET S10
	1983-1984	L4-1.9L	CHEVROLET S10 BLAZER
	1982-1985	L4-1.9L	GMC S15
	1983-1984	L4-1.9L	GMC S15 JIMMY
<b>US5014</b>	1982-1985	V6-4.3L	BUICK CENTURY
	1985	V6-4.3L	BUICK ELECTRA
	1985	V6-4.3L	CADILLAC COMMERCIAL CHASSIS
	1985	V6-4.3L	CADILLAC DEVILLE
	1985	V6-4.3L	CADILLAC FLEETWOOD
	1982-1985	V6-4.3L	CHEVROLET CELEBRITY
	1985	V6-4.3L	OLDSMOBILE 98
	1982-1985	V6-4.3L	OLDSMOBILE CUTLASS CIERA
	1982-1985	V6-4.3L	PONTIAC 6000
	<b>US5015</b>	1983-1984	L4-2.0L
1983-1984		L4-2.0L	CHEVROLET S10 BLAZER
1983-1984		L4-2.0L	GMC S15
1983-1984		L4-2.0L	GMC S15 JIMMY
<b>US5016</b>	1984-1991	V8-5.7L	CHEVROLET CORVETTE
<b>US5016H</b>	1984-1991	V8-5.7L	CHEVROLET CORVETTE
<b>US5017</b>	1985-1986	L4-1.8L	BUICK SKYHAWK
	1985	L4-1.8L	PONTIAC J2000 SUNBIRD
	1986	L4-1.8L	PONTIAC SUNBIRD
<b>US5020</b>	1985-1986	V6-2.8L	CADILLAC CIMARRON
	1985-1986	V6-2.8L	CHEVROLET CAVALIER
	1985-1986	V6-2.8L	OLDSMOBILE FIRENZA
<b>US5022</b>	1985-1986	L4-2.5L	CHEVROLET ASTRO
	1985-1986	L4-2.5L	CHEVROLET CAMARO
	1985-1986	L4-2.5L	CHEVROLET S10
	1985-1986	L4-2.5L	CHEVROLET S10 BLAZER
	1985-1986	L4-2.5L	GMC S15
	1985-1986	L4-2.5L	GMC S15 JIMMY
	1985-1986	L4-2.5L	GMC SAFARI
	1985-1986	L4-2.5L	PONTIAC FIREBIRD
	<b>US5023</b>	1987-1992	V8-4.1L
1985-1990		V8-4.1L	CADILLAC COMMERCIAL CHASSIS
1985-1987		V8-4.1L	CADILLAC DEVILLE
1986-1987		V8-4.1L	CADILLAC ELDORADO
1985-1987		V8-4.1L	CADILLAC FLEETWOOD
1986-1987		V8-4.1L	CADILLAC SEVILLE
1988-1989		V8-4.5L	CADILLAC COMMERCIAL CHASSIS
1988-1990		V8-4.5L	CADILLAC DEVILLE
1988-1990		V8-4.5L	CADILLAC ELDORADO
1988-1990		V8-4.5L	CADILLAC FLEETWOOD
1988-1990		V8-4.5L	CADILLAC SEVILLE
1993		V8-4.9L	CADILLAC 60 SPECIAL
1991-1993		V8-4.9L	CADILLAC COMMERCIAL CHASSIS
1991-1995		V8-4.9L	CADILLAC DEVILLE
1991-1993		V8-4.9L	CADILLAC ELDORADO
1991-1992		V8-4.9L	CADILLAC FLEETWOOD
1991-1993	V8-4.9L	CADILLAC SEVILLE	
<b>US5027</b>	1985-1986	L4-1.8L	CHEVROLET CHEVETTE
	1983-1984	L4-1.8L	ISUZU I-MARK
<b>US5028</b>	1982-1985	V6-3.0L	BUICK CENTURY
	1985	V6-3.0L	BUICK ELECTRA
	1985	V6-3.0L	OLDSMOBILE 98
	1982-1985	V6-3.0L	OLDSMOBILE CUTLASS CIERA
	1984-1985	V6-3.8L	BUICK CENTURY
	1985	V6-3.8L	BUICK ELECTRA
	1985	V6-3.8L	OLDSMOBILE 98
	1984-1985	V6-3.8L	OLDSMOBILE CUTLASS CIERA
<b>US5029</b>	1985-1988	L3-1.0L	CHEVROLET SPRINT
	1986-1995	L4-1.3L	SUZUKI SAMURAI
	1989	L4-1.3L	SUZUKI SIDEKICK
<b>US5030</b>	1998	L6-4.1L	CHEVROLET C1500 (MEX)
	1998-2002	L6-4.1L	CHEVROLET P30 VAN (MEX)
	1980	L6-4.8L	CHEVROLET C10
	1981-1986	L6-4.8L	CHEVROLET C10 (MEX)
	1978-1986	L6-4.8L	CHEVROLET C20

USMW	Years	Cyl.	Specifications
	1978-1982	L6-4.8L	CHEVROLET C20 SUBURBAN
	1978-1986	L6-4.8L	CHEVROLET C30
	1978	L6-4.8L	CHEVROLET CS1073 (MEX)
	1978	L6-4.8L	CHEVROLET CS31003 (MEX)
	1978-1980	L6-4.8L	CHEVROLET G20
	1978	L6-4.8L	CHEVROLET G30
	1980	L6-4.8L	CHEVROLET K10
	1978-1986	L6-4.8L	CHEVROLET K20
	1978-1982	L6-4.8L	CHEVROLET K20 SUBURBAN
	1977-1986	L6-4.8L	CHEVROLET K30
	1975-1979	L6-4.8L	CHEVROLET P10
	1978-1979	L6-4.8L	CHEVROLET P20
	1978-1989	L6-4.8L	CHEVROLET P30
	1987-1988	L6-4.8L	CHEVROLET R20
	1987-1988	L6-4.8L	CHEVROLET R30
	1987	L6-4.8L	CHEVROLET V20
	1987-1988	L6-4.8L	CHEVROLET V30
	1980	L6-4.8L	GMC C1500
	1981-1986	L6-4.8L	GMC C1500 (MEX)
	1978	L6-4.8L	GMC C25
	1978	L6-4.8L	GMC C25 SUBURBAN
	1979-1986	L6-4.8L	GMC C2500
	1979-1984	L6-4.8L	GMC C2500 SUBURBAN
	1980-1986	L6-4.8L	GMC C3500
	1978	L6-4.8L	GMC G25
	1978	L6-4.8L	GMC G35
	1980	L6-4.8L	GMC K1500
	1978	L6-4.8L	GMC K25
	1978	L6-4.8L	GMC K25 SUBURBAN
	1979-1986	L6-4.8L	GMC K2500
	1979-1984	L6-4.8L	GMC K2500 SUBURBAN
	1977-1978	L6-4.8L	GMC K35
	1979-1986	L6-4.8L	GMC K3500
	1975-1978	L6-4.8L	GMC P15
	1979	L6-4.8L	GMC P1500
	1978	L6-4.8L	GMC P25
	1979	L6-4.8L	GMC P2500
	1978	L6-4.8L	GMC P35
	1979-1989	L6-4.8L	GMC P3500
	1987-1988	L6-4.8L	GMC R2500
	1987-1988	L6-4.8L	GMC R3500
	1987	L6-4.8L	GMC V2500
	1987-1988	L6-4.8L	GMC V3500
<b>US5031</b>	1985-1988	L4-1.5L	CHEVROLET SPECTRUM
	1989	L4-1.5L	GEO SPECTRUM
	1985-1989	L4-1.5L	ISUZU I-MARK
<b>US5032</b>	1987-1989	L4-2.0L	BUICK SKYHAWK
	1987-1989	L4-2.0L	CHEVROLET BERETTA
	1987-1990	L4-2.0L	CHEVROLET CAVALIER
	1987-1989	L4-2.0L	CHEVROLET CORSICA
	1987-1988	L4-2.0L	OLDSMOBILE FIRENZA
	1993-1996	L4-2.2L	BUICK CENTURY
	1990-1996	L4-2.2L	CHEVROLET BERETTA
	1991-2002	L4-2.2L	CHEVROLET CAVALIER
	1990-1996	L4-2.2L	CHEVROLET CORSICA
	1994-1995	L4-2.2L	CHEVROLET LLV
	1997-1999	L4-2.2L	CHEVROLET LUV (MEX)
	1994-2003	L4-2.2L	CHEVROLET S10
2001-2002	L4-2.2L	CHEVROLET S10 (MEX)	
1994-2003	L4-2.2L	GMC SONOMA	
1996-2000	L4-2.2L	ISUZU HOMBRE	
1993-1996	L4-2.2L	OLDSMOBILE CUTLASS CIERA	
1995-2002	L4-2.2L	PONTIAC SUNFIRE	
<b>US5033</b>	1995	L4-2.2L	CHEVROLET CENTURY (MEX)
	1994-1996	L4-2.2L	CHEVROLET CUTLASS (MEX)
	1990-1994	L4-2.8L	CHEVROLET CAVALIER (MEX)
	1982-1990	L4-2.8L	CHEVROLET CELEBRITY (MEX)
	1983-1990	L4-2.8L	CHEVROLET CENTURY (MEX)
	1986-1989	L4-2.8L	CHEVROLET CUTLASS (MEX)

WATER PUMPS

USMW	Years	Cyl.	Specifications
	1989-1997	L4-3.1L	CHEVROLET CENTURY (MEX)
	1986-1997	L4-3.1L	CHEVROLET CUTLASS (MEX)
	1991-1996	L4-3.1L	CHEVROLET EUROSPOUT (MEX)
	1999-2001	L4-3.1L	CHEVROLET GRAND AM (MEX)
	1990-1994	L4-3.1L	CHEVROLET S10 BLAZER (MEX)
	1997	L4-3.3L	CHEVROLET LUMINA VAN (MEX)
	1999-2002	L4-3.4L	CHEVROLET GRAND AM (MEX)
	1987-1989	V6-2.8L	BUICK CENTURY
	1988-1989	V6-2.8L	BUICK REGAL
	1987-1988	V6-2.8L	CADILLAC CIMARRON
	1987-1989	V6-2.8L	CHEVROLET BERETTA
	1987-1989	V6-2.8L	CHEVROLET CAVALIER
	1987-1989	V6-2.8L	CHEVROLET CELEBRITY
	1987-1989	V6-2.8L	CHEVROLET CORSICA
	1987-1989	V6-2.8L	OLDSMOBILE CUTLASS CIERA
	1987-1989	V6-2.8L	OLDSMOBILE CUTLASS CRUISER
	1988-1989	V6-2.8L	OLDSMOBILE CUTLASS SUPREME
	1987-1989	V6-2.8L	PONTIAC 6000
	1988-1989	V6-2.8L	PONTIAC GRAND PRIX
	1994-2005	V6-3.1L	BUICK CENTURY
	1989-1996	V6-3.1L	BUICK REGAL
	1994-1998	V6-3.1L	BUICK SKYLARK
	1990-1996	V6-3.1L	CHEVROLET BERETTA
	1990-1994	V6-3.1L	CHEVROLET CAVALIER
	1990	V6-3.1L	CHEVROLET CELEBRITY
	1990-1996	V6-3.1L	CHEVROLET CORSICA
	1990-2001	V6-3.1L	CHEVROLET LUMINA
	1990-1996	V6-3.1L	CHEVROLET LUMINA APV
	1997-2003	V6-3.1L	CHEVROLET MALIBU
	1995-1999	V6-3.1L	CHEVROLET MONTE CARLO
	1994-1998	V6-3.1L	OLDSMOBILE ACHIEVA
	2004	V6-3.1L	OLDSMOBILE ALERO
	1997-1999	V6-3.1L	OLDSMOBILE CUTLASS
	1994-1996	V6-3.1L	OLDSMOBILE CUTLASS CIERA
	1994	V6-3.1L	OLDSMOBILE CUTLASS CRUISER
	1989-1997	V6-3.1L	OLDSMOBILE CUTLASS SUPREME
	1987	V6-3.1L	OLDSMOBILE FIRENZA
	1990-1994	V6-3.1L	OLDSMOBILE SILHOUETTE
	1988-1991	V6-3.1L	PONTIAC 6000
	1994-1998	V6-3.1L	PONTIAC GRAND AM
	1989-2003	V6-3.1L	PONTIAC GRAND PRIX
	1991-1994	V6-3.1L	PONTIAC SUNBIRD
	1990-1995	V6-3.1L	PONTIAC TRANS SPORT
	2002-2005	V6-3.4L	BUICK RENDEZVOUS
	2000-2005	V6-3.4L	CHEVROLET IMPALA
	1991-1997	V6-3.4L	CHEVROLET LUMINA
	1995-2005	V6-3.4L	CHEVROLET MONTE CARLO
	1997-2005	V6-3.4L	CHEVROLET VENTURE
	1999-2004	V6-3.4L	OLDSMOBILE ALERO
	1991-1996	V6-3.4L	OLDSMOBILE CUTLASS SUPREME
	1996-2004	V6-3.4L	OLDSMOBILE SILHOUETTE
	2001-2005	V6-3.4L	PONTIAC AZTEK
	1999-2005	V6-3.4L	PONTIAC GRAND AM
	1991-1996	V6-3.4L	PONTIAC GRAND PRIX
	1999-2005	V6-3.4L	PONTIAC MONTANA
	1996-1998	V6-3.4L	PONTIAC TRANS SPORT
	2006-2007	V6-3.5L	BUICK RENDEZVOUS
	2005-2006	V6-3.5L	BUICK TERRAZA
	2004-2006	V6-3.5L	CHEVROLET MALIBU
	2005-2006	V6-3.5L	CHEVROLET UPLANDER
	2005-2006	V6-3.5L	PONTIAC G6
	2005-2006	V6-3.5L	PONTIAC MONTANA
<b>US5035</b>	1987-1993	V6-2.8L	CHEVROLET S10
	1987-1989	V6-2.8L	CHEVROLET S10 BLAZER
	1987-1990	V6-2.8L	GMC S15
	1987-1989	V6-2.8L	GMC S15 JIMMY
	1991-1993	V6-2.8L	GMC SONOMA
	1989-1991	V6-2.8L	ISUZU TROOPER
	1991-1994	V6-3.1L	ISUZU PICKUP

USMW	Years	Cyl.	Specifications
	1991-1992	V6-3.1L	ISUZU RODEO
<b>US5036</b>	1982-1986	L4-1.8L	BUICK SKYHAWK
	1982-1986	L4-1.8L	OLDSMOBILE FIRENZA
	1982-1983	L4-1.8L	PONTIAC J2000
	1984	L4-1.8L	PONTIAC J2000 SUNBIRD
	1987-1988	L4-2.0L	BUICK SKYHAWK
	1987-1988	L4-2.0L	OLDSMOBILE FIRENZA
	1987-1989	L4-2.0L	PONTIAC GRAND AM
	1989-1990	L4-2.0L	PONTIAC LEMANS
	1987-1994	L4-2.0L	PONTIAC SUNBIRD
<b>US5037</b>	1987-1989	V6-2.8L	CHEVROLET CAMARO
	1987-1989	V6-2.8L	PONTIAC FIREBIRD
	1990-1992	V6-3.1L	CHEVROLET CAMARO
	1990-1992	V6-3.1L	PONTIAC FIREBIRD
<b>US5038</b>	1990-1993	V8-7.4L	CHEVROLET C1500
	1991-2000	V8-7.4L	CHEVROLET C2500
	1992-1999	V8-7.4L	CHEVROLET C2500 SUBURBAN
	1988-2000	V8-7.4L	CHEVROLET C3500
	1996-2000	V8-7.4L	CHEVROLET EXPRESS 3500
	1988-1996	V8-7.4L	CHEVROLET G30
	1991-2000	V8-7.4L	CHEVROLET K2500
	1992-1999	V8-7.4L	CHEVROLET K2500 SUBURBAN
	1988-2000	V8-7.4L	CHEVROLET K3500
	1989-1991	V8-7.4L	CHEVROLET R2500 SUBURBAN
	1991-2000	V8-7.4L	GMC C2500
	1992-1999	V8-7.4L	GMC C2500 SUBURBAN
	1988-2000	V8-7.4L	GMC C3500
	1988-1996	V8-7.4L	GMC G3500
	1991-2000	V8-7.4L	GMC K2500
	1992-1999	V8-7.4L	GMC K2500 SUBURBAN
	1988-2000	V8-7.4L	GMC K3500
	1989-1991	V8-7.4L	GMC R2500 SUBURBAN
	1991-2000	V8-7.4L	GMC SAVANA 3500
<b>US5038H</b>	1990-1993	V8-7.4L	CHEVROLET C1500
	1991-2000	V8-7.4L	CHEVROLET C2500
	1992-1999	V8-7.4L	CHEVROLET C2500 SUBURBAN
	1988-2000	V8-7.4L	CHEVROLET C3500
	1996-2000	V8-7.4L	CHEVROLET EXPRESS 3500
	1988-1996	V8-7.4L	CHEVROLET G30
	1991-2000	V8-7.4L	CHEVROLET K2500
	1992-1999	V8-7.4L	CHEVROLET K2500 SUBURBAN
	1988-2000	V8-7.4L	CHEVROLET K3500
	1989-1991	V8-7.4L	CHEVROLET R2500 SUBURBAN
	1991-2000	V8-7.4L	GMC C2500
	1992-1999	V8-7.4L	GMC C2500 SUBURBAN
	1988-2000	V8-7.4L	GMC C3500
	1988-1996	V8-7.4L	GMC G3500
	1991-2000	V8-7.4L	GMC K2500
	1992-1999	V8-7.4L	GMC K2500 SUBURBAN
	1988-2000	V8-7.4L	GMC K3500
	1989-1991	V8-7.4L	GMC R2500 SUBURBAN
	1991-2000	V8-7.4L	GMC SAVANA 3500
<b>US5040</b>	1987-1990	L4-2.5L	CHEVROLET ASTRO
	1987-1993	L4-2.5L	CHEVROLET LLV
	1987-1993	L4-2.5L	CHEVROLET S10
	1987-1988	L4-2.5L	CHEVROLET S10 BLAZER
	1987-1990	L4-2.5L	GMC S15
	1987-1988	L4-2.5L	GMC S15 JIMMY
	1987-1990	L4-2.5L	GMC SAFARI
	1991-1993	L4-2.5L	GMC SONOMA
<b>US5041</b>	1987-1992	L4-2.5L	BUICK CENTURY
	1987-1990	L4-2.5L	CHEVROLET CELEBRITY
	1990-1992	L4-2.5L	CHEVROLET LUMINA
	1987-1992	L4-2.5L	OLDSMOBILE CUTLASS CIERA
	1987-1990	L4-2.5L	OLDSMOBILE CUTLASS CRUISER
	1987-1991	L4-2.5L	PONTIAC 6000
<b>US5043</b>	1988-1995	L4-2.3L	BUICK SKYLARK
	1990-1994	L4-2.3L	CHEVROLET BERETTA
	1995	L4-2.3L	CHEVROLET CAVALIER



USMW	Years	Cyl.	Specifications
	1992-1995	L4-2.3L	OLDSMOBILE ACHIEVA
	1987	L4-2.3L	OLDSMOBILE CALAIS
	1988-1991	L4-2.3L	OLDSMOBILE CUTLASS CALAIS
	1990-1991	L4-2.3L	OLDSMOBILE CUTLASS SUPREME
	1988-1995	L4-2.3L	PONTIAC GRAND AM
	1990-1991	L4-2.3L	PONTIAC GRAND PRIX
	1995	L4-2.3L	PONTIAC SUNFIRE
<b>US5045</b>	1988-1993	L4-1.6L	PONTIAC LEMANS
<b>US5048</b>	1998	L4-1.6L	CHEVROLET TRACKER
	1989-1997	L4-1.6L	GEO TRACKER
	1995-1996	L4-1.6L	SUZUKI ESTEEM
	1989-1998	L4-1.6L	SUZUKI SIDEKICK
	1996-1998	L4-1.6L	SUZUKI X-90
	1999-2005	L4-2.2L	CHEVROLET TRACKER (MEX)
<b>US5049</b>	1987-1995	V6-4.3L	CHEVROLET ASTRO
	1995	V6-4.3L	CHEVROLET BLAZER
	1988-1995	V6-4.3L	CHEVROLET C1500
	1988-1995	V6-4.3L	CHEVROLET C2500
	1989-1993	V6-4.3L	CHEVROLET CAPRICE
	1987-1995	V6-4.3L	CHEVROLET G10
	1987-1995	V6-4.3L	CHEVROLET G20
	1987-1996	V6-4.3L	CHEVROLET G30
	1988-1995	V6-4.3L	CHEVROLET K1500
	1992-1994	V6-4.3L	CHEVROLET K1500 SUBURBAN
	1988-1995	V6-4.3L	CHEVROLET K2500
	1988-1995	V6-4.3L	CHEVROLET S10
	1988-1994	V6-4.3L	CHEVROLET S10 BLAZER
	1988-1995	V6-4.3L	GMC C1500
	1988-1995	V6-4.3L	GMC C2500
	1987-1995	V6-4.3L	GMC G1500
	1987-1995	V6-4.3L	GMC G2500
	1987-1995	V6-4.3L	GMC G3500
	1992-1995	V6-4.3L	GMC JIMMY
	1988-1995	V6-4.3L	GMC K1500
	1988-1995	V6-4.3L	GMC K2500
	1988-1990	V6-4.3L	GMC S15
	1988-1991	V6-4.3L	GMC S15 JIMMY
	1987-1995	V6-4.3L	GMC SAFARI
	1991-1995	V6-4.3L	GMC SONOMA
	1991	V6-4.3L	GMC SYCLONE
	1992-1993	V6-4.3L	GMC TYPHOON
	1991-1994	V6-4.3L	OLDSMOBILE BRAVADA
	1991-1992	V8-5.0L	CADILLAC BROUGHAM
	1988-1995	V8-5.0L	CHEVROLET C1500
	1988-1995	V8-5.0L	CHEVROLET C2500
	1988-1992	V8-5.0L	CHEVROLET CAMARO
	1989-1990	V8-5.0L	CHEVROLET CAPRICE
	1987-1995	V8-5.0L	CHEVROLET G10
	1987-1995	V8-5.0L	CHEVROLET G20
	1988-1995	V8-5.0L	CHEVROLET K1500
	1988-1995	V8-5.0L	CHEVROLET K2500
	1988-1995	V8-5.0L	GMC C1500
	1988-1995	V8-5.0L	GMC C2500
	1987-1995	V8-5.0L	GMC G1500
	1987-1995	V8-5.0L	GMC G2500
	1988-1995	V8-5.0L	GMC K1500
	1988-1995	V8-5.0L	GMC K2500
	1988-1992	V8-5.0L	PONTIAC FIREBIRD
	1995-1996	V8-5.7L	AM GENERAL HUMMER
	1990-1992	V8-5.7L	CADILLAC BROUGHAM
	1992-1993	V8-5.7L	CADILLAC COMMERCIAL CHASSIS
	1993	V8-5.7L	CADILLAC FLEETWOOD
	1992-1995	V8-5.7L	CHEVROLET 400 (MEX)
	1989-1994	V8-5.7L	CHEVROLET BLAZER
	1988-1995	V8-5.7L	CHEVROLET C1500
	1988-1991	V8-5.7L	CHEVROLET C1500 (MEX)
	1992-1995	V8-5.7L	CHEVROLET C1500 SUBURBAN
	1988-1995	V8-5.7L	CHEVROLET C2500
	1988-1991	V8-5.7L	CHEVROLET C2500 (MEX)

USMW	Years	Cyl.	Specifications
	1992-1995	V8-5.7L	CHEVROLET C2500 SUBURBAN
	1988-1995	V8-5.7L	CHEVROLET C3500
	1989-1991	V8-5.7L	CHEVROLET C3500 (MEX)
	1988-1992	V8-5.7L	CHEVROLET CAMARO
	1989-1990	V8-5.7L	CHEVROLET CAPRICE
	1987-1993	V8-5.7L	CHEVROLET G10
	1987-1995	V8-5.7L	CHEVROLET G20
	1987-1996	V8-5.7L	CHEVROLET G30
	1988-1995	V8-5.7L	CHEVROLET K1500
	1995	V8-5.7L	CHEVROLET K1500 SUBURBAN
	1988-1995	V8-5.7L	CHEVROLET K2500
	1992-1995	V8-5.7L	CHEVROLET K2500 SUBURBAN
	1988-1995	V8-5.7L	CHEVROLET K3500
	1990-1996	V8-5.7L	CHEVROLET MICROBUS (MEX)
	1989-1991	V8-5.7L	CHEVROLET P30 VAN (MEX)
	1996	V8-5.7L	CHEVROLET P31 VAN (MEX)
	1987-1988	V8-5.7L	CHEVROLET R10 SUBURBAN
	1989-1991	V8-5.7L	CHEVROLET R1500 SUBURBAN
	1987-1988	V8-5.7L	CHEVROLET R20 SUBURBAN
	1989-1991	V8-5.7L	CHEVROLET R2500 SUBURBAN
	1994-1995	V8-5.7L	CHEVROLET SILVERADO (MEX)
	2000-2002	V8-5.7L	CHEVROLET SONORA (MEX)
	1995	V8-5.7L	CHEVROLET TAHOE
	1987-1988	V8-5.7L	CHEVROLET V10 SUBURBAN
	1989-1991	V8-5.7L	CHEVROLET V1500 SUBURBAN
	1988	V8-5.7L	CHEVROLET V20 SUBURBAN
	1989-1991	V8-5.7L	CHEVROLET V2500 SUBURBAN
	1988-1995	V8-5.7L	GMC C1500
	1989-1990	V8-5.7L	GMC C1500 (MEX)
	1992-1995	V8-5.7L	GMC C1500 SUBURBAN
	1988-1995	V8-5.7L	GMC C2500
	1989-1991	V8-5.7L	GMC C2500 (MEX)
	1992-1995	V8-5.7L	GMC C2500 SUBURBAN
	1988-1995	V8-5.7L	GMC C3500
	1989-1991	V8-5.7L	GMC C3500 (MEX)
	1987-1993	V8-5.7L	GMC G1500
	1987-1995	V8-5.7L	GMC G2500
	1987-1996	V8-5.7L	GMC G3500
	1989-1991	V8-5.7L	GMC JIMMY
	1988-1995	V8-5.7L	GMC K1500
	1992-1995	V8-5.7L	GMC K1500 SUBURBAN
	1988-1995	V8-5.7L	GMC K2500
	1992-1995	V8-5.7L	GMC K2500 SUBURBAN
	1988-1995	V8-5.7L	GMC K3500
	1990-1991	V8-5.7L	GMC MICROBUS (MEX)
	1989-1991	V8-5.7L	GMC P3500 VAN (MEX)
	1989-1991	V8-5.7L	GMC R1500 SUBURBAN
	1989-1991	V8-5.7L	GMC R2500 SUBURBAN
	1989-1991	V8-5.7L	GMC V1500 SUBURBAN
	1989-1991	V8-5.7L	GMC V2500 SUBURBAN
	1992-1995	V8-5.7L	GMC YUKON
	1988-1992	V8-5.7L	PONTIAC FIREBIRD
<b>US5049H</b>	1987-1995	V6-4.3L	CHEVROLET ASTRO
	1995	V6-4.3L	CHEVROLET BLAZER
	1988-1995	V6-4.3L	CHEVROLET C1500
	1988-1995	V6-4.3L	CHEVROLET C2500
	1989-1993	V6-4.3L	CHEVROLET CAPRICE
	1992	V6-4.3L	CHEVROLET COMMERCIAL CHASSIS
	1987-1995	V6-4.3L	CHEVROLET G10
	1987-1995	V6-4.3L	CHEVROLET G20
	1987-1996	V6-4.3L	CHEVROLET G30
	1988-1995	V6-4.3L	CHEVROLET K1500
	1988-1995	V6-4.3L	CHEVROLET K2500
	1988-1995	V6-4.3L	CHEVROLET S10
	1988-1994	V6-4.3L	CHEVROLET S10 BLAZER
	1988-1995	V6-4.3L	GMC C1500
	1988-1995	V6-4.3L	GMC C2500
	1987-1995	V6-4.3L	GMC G1500
	1987-1995	V6-4.3L	GMC G2500

**WATER PUMPS**

USMW	Years	Cyl.	Specifications
	1987-1995	V6-4.3L	<b>GMC</b> G3500
	1992-1995	V6-4.3L	<b>GMC</b> JIMMY
	1988-1995	V6-4.3L	<b>GMC</b> K1500
	1988-1995	V6-4.3L	<b>GMC</b> K2500
	1988-1990	V6-4.3L	<b>GMC</b> S15
	1988-1991	V6-4.3L	<b>GMC</b> S15 JIMMY
	1987-1995	V6-4.3L	<b>GMC</b> SAFARI
	1991-1995	V6-4.3L	<b>GMC</b> SONOMA
	1991	V6-4.3L	<b>GMC</b> SYCLONE
	1992-1993	V6-4.3L	<b>GMC</b> TYPHOON
	1991-1994	V6-4.3L	<b>OLDSMOBILE</b> BRAVADA
	1991-1992	V8-5.0L	<b>CADILLAC</b> BROUGHAM
	1988-1995	V8-5.0L	<b>CHEVROLET</b> C1500
	1988-1995	V8-5.0L	<b>CHEVROLET</b> C2500
	1988-1992	V8-5.0L	<b>CHEVROLET</b> CAMARO
	1989-1990	V8-5.0L	<b>CHEVROLET</b> CAPRICE
	1987-1995	V8-5.0L	<b>CHEVROLET</b> G10
	1987-1995	V8-5.0L	<b>CHEVROLET</b> G20
	1988-1995	V8-5.0L	<b>CHEVROLET</b> K1500
	1988-1995	V8-5.0L	<b>CHEVROLET</b> K2500
	1988-1995	V8-5.0L	<b>GMC</b> C1500
	1988-1995	V8-5.0L	<b>GMC</b> C2500
	1987-1995	V8-5.0L	<b>GMC</b> G1500
	1987-1995	V8-5.0L	<b>GMC</b> G2500
	1988-1995	V8-5.0L	<b>GMC</b> K1500
	1988-1995	V8-5.0L	<b>GMC</b> K2500
	1988-1992	V8-5.0L	<b>PONTIAC</b> FIREBIRD
	1995-1996	V8-5.7L	<b>AM GENERAL</b> HUMMER
	1990-1992	V8-5.7L	<b>CADILLAC</b> BROUGHAM
	1992-1993	V8-5.7L	<b>CADILLAC</b> COMMERCIAL CHASSIS
	1993	V8-5.7L	<b>CADILLAC</b> FLEETWOOD
	1992-1995	V8-5.7L	<b>CHEVROLET</b> 400 (MEX)
	1989-1994	V8-5.7L	<b>CHEVROLET</b> BLAZER
	1988-1995	V8-5.7L	<b>CHEVROLET</b> C1500
	1988-1991	V8-5.7L	<b>CHEVROLET</b> C1500 (MEX)
	1992-1995	V8-5.7L	<b>CHEVROLET</b> C1500 SUBURBAN
	1988-1995	V8-5.7L	<b>CHEVROLET</b> C2500
	1988-1991	V8-5.7L	<b>CHEVROLET</b> C2500 (MEX)
	1992-1995	V8-5.7L	<b>CHEVROLET</b> C2500 SUBURBAN
	1988-1995	V8-5.7L	<b>CHEVROLET</b> C3500
	1989-1991	V8-5.7L	<b>CHEVROLET</b> C3500 (MEX)
	1988-1992	V8-5.7L	<b>CHEVROLET</b> CAMARO
	1989-1990	V8-5.7L	<b>CHEVROLET</b> CAPRICE
	1987-1993	V8-5.7L	<b>CHEVROLET</b> G10
	1987-1995	V8-5.7L	<b>CHEVROLET</b> G20
	1987-1996	V8-5.7L	<b>CHEVROLET</b> G30
	1988-1995	V8-5.7L	<b>CHEVROLET</b> K1500
	1992-1995	V8-5.7L	<b>CHEVROLET</b> K1500 SUBURBAN
	1988-1995	V8-5.7L	<b>CHEVROLET</b> K2500
	1992-1995	V8-5.7L	<b>CHEVROLET</b> K2500 SUBURBAN
	1988-1995	V8-5.7L	<b>CHEVROLET</b> K3500
	1990-1996	V8-5.7L	<b>CHEVROLET</b> MICROBUS (MEX)
	1989-1991	V8-5.7L	<b>CHEVROLET</b> P30 VAN (MEX)
	1996	V8-5.7L	<b>CHEVROLET</b> P31 VAN (MEX)
	1987-1988	V8-5.7L	<b>CHEVROLET</b> R10 SUBURBAN
	1989-1991	V8-5.7L	<b>CHEVROLET</b> R1500 SUBURBAN
	1987-1988	V8-5.7L	<b>CHEVROLET</b> R20 SUBURBAN
	1995	V8-5.7L	<b>CHEVROLET</b> R25
	1989-1991	V8-5.7L	<b>CHEVROLET</b> R2500 SUBURBAN
	1994-1995	V8-5.7L	<b>CHEVROLET</b> SILVERADO (MEX)
	2000-2002	V8-5.7L	<b>CHEVROLET</b> SONORA
	2000-2002	V8-5.7L	<b>CHEVROLET</b> SONORA (MEX)
	1995	V8-5.7L	<b>CHEVROLET</b> TAHOE
	1987-1988	V8-5.7L	<b>CHEVROLET</b> V10 SUBURBAN
	1989-1991	V8-5.7L	<b>CHEVROLET</b> V1500 SUBURBAN
	1988	V8-5.7L	<b>CHEVROLET</b> V20 SUBURBAN
	1989-1991	V8-5.7L	<b>CHEVROLET</b> V2500 SUBURBAN
	1988-1995	V8-5.7L	<b>GMC</b> C1500
	1989-1990	V8-5.7L	<b>GMC</b> C1500 (MEX)

USMW	Years	Cyl.	Specifications
	1992-1995	V8-5.7L	<b>GMC</b> C1500 SUBURBAN
	1988-1995	V8-5.7L	<b>GMC</b> C2500
	1989-1991	V8-5.7L	<b>GMC</b> C2500 (MEX)
	1992-1995	V8-5.7L	<b>GMC</b> C2500 SUBURBAN
	1988-1995	V8-5.7L	<b>GMC</b> C3500
	1989-1991	V8-5.7L	<b>GMC</b> C3500 (MEX)
	1987-1993	V8-5.7L	<b>GMC</b> G1500
	1987-1995	V8-5.7L	<b>GMC</b> G2500
	1987-1996	V8-5.7L	<b>GMC</b> G3500
	1989-1991	V8-5.7L	<b>GMC</b> JIMMY
	1988-1995	V8-5.7L	<b>GMC</b> K1500
	1992-1995	V8-5.7L	<b>GMC</b> K1500 SUBURBAN
	1988-1995	V8-5.7L	<b>GMC</b> K2500
	1992-1995	V8-5.7L	<b>GMC</b> K2500 SUBURBAN
	1988-1995	V8-5.7L	<b>GMC</b> K3500
	1990-1991	V8-5.7L	<b>GMC</b> MICROBUS (MEX)
	1989-1991	V8-5.7L	<b>GMC</b> P3500 VAN (MEX)
	1989-1991	V8-5.7L	<b>GMC</b> R1500 SUBURBAN
	1989-1991	V8-5.7L	<b>GMC</b> R2500 SUBURBAN
	1989-1991	V8-5.7L	<b>GMC</b> V1500 SUBURBAN
	1989-1991	V8-5.7L	<b>GMC</b> V2500 SUBURBAN
	1992-1995	V8-5.7L	<b>GMC</b> YUKON
	1988-1992	V8-5.7L	<b>PONTIAC</b> FIREBIRD
<b>US5050</b>	1986	V6-3.0L	<b>BUICK</b> LESABRE
	1986-1988	V6-3.0L	<b>BUICK</b> SKYLARK
	1986-1987	V6-3.0L	<b>BUICK</b> SOMERSET
	1985	V6-3.0L	<b>BUICK</b> SOMERSET REGAL
	1985-1987	V6-3.0L	<b>OLDSMOBILE</b> CALAIS
	1988	V6-3.0L	<b>OLDSMOBILE</b> CUTLASS CALAIS
	1986	V6-3.0L	<b>OLDSMOBILE</b> DELTA 88
	1985-1987	V6-3.0L	<b>PONTIAC</b> GRAND AM
	1989-1993	V6-3.3L	<b>BUICK</b> CENTURY
	1989-1993	V6-3.3L	<b>BUICK</b> SKYLARK
	1992-1993	V6-3.3L	<b>OLDSMOBILE</b> ACHIEVA
	1989-1991	V6-3.3L	<b>OLDSMOBILE</b> CUTLASS CALAIS
	1989-1993	V6-3.3L	<b>OLDSMOBILE</b> CUTLASS CIERA
	1989-1993	V6-3.3L	<b>OLDSMOBILE</b> CUTLASS CRUISER
	1992-1993	V6-3.3L	<b>PONTIAC</b> GRAND AM
	1986-1988	V6-3.8L	<b>BUICK</b> CENTURY
	1986-1990	V6-3.8L	<b>BUICK</b> ELECTRA
	1986-1995	V6-3.8L	<b>BUICK</b> LESABRE
	1991-1995	V6-3.8L	<b>BUICK</b> PARK AVENUE
	1988-1991	V6-3.8L	<b>BUICK</b> REATA
	1990-1995	V6-3.8L	<b>BUICK</b> REGAL
	1986-1995	V6-3.8L	<b>BUICK</b> RIVIERA
	1995	V6-3.8L	<b>CHEVROLET</b> CAMARO
	1992-1995	V6-3.8L	<b>CHEVROLET</b> LUMINA APV
	1992-1995	V6-3.8L	<b>OLDSMOBILE</b> 88
	1986-1995	V6-3.8L	<b>OLDSMOBILE</b> 98
	1986-1988	V6-3.8L	<b>OLDSMOBILE</b> CUTLASS CIERA
	1987-1988	V6-3.8L	<b>OLDSMOBILE</b> CUTLASS CRUISER
	1986-1991	V6-3.8L	<b>OLDSMOBILE</b> DELTA 88
	1992-1995	V6-3.8L	<b>OLDSMOBILE</b> SILHOUETTE
	1986-1992	V6-3.8L	<b>OLDSMOBILE</b> TORONADO
	1987-1995	V6-3.8L	<b>PONTIAC</b> BONNEVILLE
	1995	V6-3.8L	<b>PONTIAC</b> FIREBIRD
	1992-1995	V6-3.8L	<b>PONTIAC</b> TRANS SPORT
<b>US5051</b>	1991-1993	V8-5.0L	<b>BUICK</b> COMMERCIAL CHASSIS
	1991	V8-5.0L	<b>BUICK</b> ROADMASTER
	1991-1993	V8-5.0L	<b>CHEVROLET</b> CAPRICE
	1991-1992	V8-5.0L	<b>OLDSMOBILE</b> CUSTOM CRUISER
	1992-1993	V8-5.7L	<b>BUICK</b> ROADMASTER
	1991-1993	V8-5.7L	<b>CHEVROLET</b> CAPRICE
	1992	V8-5.7L	<b>OLDSMOBILE</b> CUSTOM CRUISER
<b>US5054</b>	1991-1992	L4-1.9L	<b>SATURN</b> SC
	1993-2002	L4-1.9L	<b>SATURN</b> SC1
	1993-2002	L4-1.9L	<b>SATURN</b> SC2
	1991-2002	L4-1.9L	<b>SATURN</b> SL
	1991-2002	L4-1.9L	<b>SATURN</b> SL1

USMW	Years	Cyl.	Specifications
	1991-2002	L4-1.9L	<b>SATURN</b> SL2
	1993-1999	L4-1.9L	<b>SATURN</b> SW1
	1993-2001	L4-1.9L	<b>SATURN</b> SW2
<b>US5056</b>	1990-1995	V8-5.7L	<b>CHEVROLET</b> CORVETTE
<b>US5057</b>	2002	L4-1.4L	<b>CHEVROLET</b> CORSA (MEX)
	1994-1995	L4-1.4L	<b>CHEVROLET</b> JOY (MEX)
	2002	L4-1.4L	<b>CHEVROLET</b> MONZA POP (MEX)
	1996-2001	L4-1.4L	<b>CHEVROLET</b> POP (MEX)
	1994-1995	L4-1.4L	<b>CHEVROLET</b> SWING (MEX)
	2009-2010	L4-1.6L	<b>CHEVROLET</b> CHEVY (MEX)
	2004-2008	L4-1.6L	<b>CHEVROLET</b> CHEVY C2 (MEX)
	1999-2003	L4-1.6L	<b>CHEVROLET</b> CHEVY PICKUP (MEX)
	1996-2003	L4-1.6L	<b>CHEVROLET</b> JOY (MEX)
	2000	L4-1.6L	<b>CHEVROLET</b> MILENIO (MEX)
	1997-2003	L4-1.6L	<b>CHEVROLET</b> MONZA (MEX)
	2002-2003	L4-1.6L	<b>CHEVROLET</b> POP (MEX)
	1996-2003	L4-1.6L	<b>CHEVROLET</b> SWING (MEX)
	1999	L4-1.6L	<b>CHEVROLET</b> TIGRA (MEX)
	2000-2002	L4-1.6L	<b>CHEVROLET</b> VAGONETA (MEX)
<b>US5058</b>	1998-2000	L3-1.0L	<b>CHEVROLET</b> METRO
	1989-1997	L3-1.0L	<b>GEO</b> METRO
	1992-1994	L3-1.0L	<b>SUZUKI</b> SWIFT
	1998-2001	L4-1.3L	<b>CHEVROLET</b> METRO
	1995-1997	L4-1.3L	<b>GEO</b> METRO
	1989-2001	L4-1.3L	<b>SUZUKI</b> SWIFT
<b>US5062</b>	1988-1993	V8-6.2L	<b>CHEVROLET</b> C1500
	1988-1993	V8-6.2L	<b>CHEVROLET</b> C2500
	1988-1993	V8-6.2L	<b>CHEVROLET</b> C3500
	1988-1993	V8-6.2L	<b>CHEVROLET</b> K1500
	1988-1993	V8-6.2L	<b>CHEVROLET</b> K2500
	1988-1993	V8-6.2L	<b>CHEVROLET</b> K3500
	1989-1991	V8-6.2L	<b>CHEVROLET</b> R1500 SUBURBAN
	1989-1991	V8-6.2L	<b>CHEVROLET</b> R2500 SUBURBAN
	1989-1991	V8-6.2L	<b>CHEVROLET</b> V1500 SUBURBAN
	1989-1991	V8-6.2L	<b>CHEVROLET</b> V2500 SUBURBAN
	1988-1993	V8-6.2L	<b>GMC</b> C1500
	1988-1993	V8-6.2L	<b>GMC</b> C2500
	1988-1993	V8-6.2L	<b>GMC</b> C3500
	1988-1993	V8-6.2L	<b>GMC</b> K1500
	1988-1993	V8-6.2L	<b>GMC</b> K2500
	1988-1993	V8-6.2L	<b>GMC</b> K3500
	1988-1991	V8-6.2L	<b>GMC</b> R1500 SUBURBAN
	1988-1991	V8-6.2L	<b>GMC</b> R2500 SUBURBAN
	1988-1991	V8-6.2L	<b>GMC</b> V1500 SUBURBAN
	1988-1991	V8-6.2L	<b>GMC</b> V2500 SUBURBAN
	1994-1996	V8-6.5L	<b>AM GENERAL</b> HUMMER
	1994	V8-6.5L	<b>CHEVROLET</b> BLAZER
	1994-1996	V8-6.5L	<b>CHEVROLET</b> C1500
	1995-1996	V8-6.5L	<b>CHEVROLET</b> C1500 SUBURBAN
	1992-1996	V8-6.5L	<b>CHEVROLET</b> C2500
	1994-1996	V8-6.5L	<b>CHEVROLET</b> C2500 SUBURBAN
	1992-1996	V8-6.5L	<b>CHEVROLET</b> C3500
	1994-1995	V8-6.5L	<b>CHEVROLET</b> G20
	1994-1996	V8-6.5L	<b>CHEVROLET</b> G30
	1994-1996	V8-6.5L	<b>CHEVROLET</b> K1500
	1995-1996	V8-6.5L	<b>CHEVROLET</b> K1500 SUBURBAN
	1992-1996	V8-6.5L	<b>CHEVROLET</b> K2500
	1994-1996	V8-6.5L	<b>CHEVROLET</b> K2500 SUBURBAN
	1992-1996	V8-6.5L	<b>CHEVROLET</b> K3500
	1994-1996	V8-6.5L	<b>CHEVROLET</b> P30
	1995-1996	V8-6.5L	<b>CHEVROLET</b> TAHOE
	1994-1996	V8-6.5L	<b>GMC</b> C1500
	1995-1996	V8-6.5L	<b>GMC</b> C1500 SUBURBAN
	1992-1996	V8-6.5L	<b>GMC</b> C2500
	1994-1996	V8-6.5L	<b>GMC</b> C2500 SUBURBAN
	1992-1996	V8-6.5L	<b>GMC</b> C3500
	1994-1995	V8-6.5L	<b>GMC</b> G2500
	1994-1996	V8-6.5L	<b>GMC</b> G3500
	1994-1996	V8-6.5L	<b>GMC</b> K1500

USMW	Years	Cyl.	Specifications
	1995-1996	V8-6.5L	<b>GMC</b> K1500 SUBURBAN
	1992-1996	V8-6.5L	<b>GMC</b> K2500
	1994-1996	V8-6.5L	<b>GMC</b> K2500 SUBURBAN
	1992-1996	V8-6.5L	<b>GMC</b> K3500
	1994-1996	V8-6.5L	<b>GMC</b> P3500
	1994-1996	V8-6.5L	<b>GMC</b> YUKON
<b>US5063</b>	1992	V8-5.7L	<b>CHEVROLET</b> CORVETTE
<b>US5064</b>	1993	V8-4.6L	<b>CADILLAC</b> ALLANTE
	1994	V8-4.6L	<b>CADILLAC</b> DEVILLE
	1993-1994	V8-4.6L	<b>CADILLAC</b> ELDORADO
	1993-1994	V8-4.6L	<b>CADILLAC</b> SEVILLE
<b>US5066</b>	1993-1996	V8-5.7L	<b>CHEVROLET</b> CORVETTE
<b>US5067</b>	1986-1991	L4-2.5L	<b>BUICK</b> SKYLARK
	1986-1987	L4-2.5L	<b>BUICK</b> SOMERSET
	1985	L4-2.5L	<b>BUICK</b> SOMERSET REGAL
	1985-1987	L4-2.5L	<b>OLDSMOBILE</b> CALAIS
	1985-1987	L4-2.5L	<b>OLDSMOBILE</b> CUTLASS CIERA
	1987	L4-2.5L	<b>OLDSMOBILE</b> CUTLASS CRUISER
	1985-1991	L4-2.5L	<b>PONTIAC</b> GRAND AM
<b>US5068</b>	1993-1997	V8-5.7L	<b>CHEVROLET</b> CAMARO
	1994-1997	V8-5.7L	<b>CHEVROLET</b> FIREBIRD (MEX)
	1993-1997	V8-5.7L	<b>PONTIAC</b> FIREBIRD
<b>US5069</b>	1994-1996	V8-4.3L	<b>CHEVROLET</b> CAPRICE
	1994-1996	V8-5.7L	<b>BUICK</b> COMMERCIAL CHASSIS
	1994-1996	V8-5.7L	<b>BUICK</b> ROADMASTER
	1994-1996	V8-5.7L	<b>CADILLAC</b> COMMERCIAL CHASSIS
	1994-1996	V8-5.7L	<b>CADILLAC</b> FLEETWOOD
	1994-1996	V8-5.7L	<b>CHEVROLET</b> CAPRICE
	1994-1996	V8-5.7L	<b>CHEVROLET</b> IMPALA
<b>US5070</b>	1993-1995	V6-3.4L	<b>CHEVROLET</b> CAMARO
	1993-1995	V6-3.4L	<b>PONTIAC</b> FIREBIRD
<b>US5072</b>	1995-2003	V8-4.0L	<b>OLDSMOBILE</b> AURORA
	2004-2005	V8-4.0L	<b>PONTIAC</b> BONNEVILLE
	1995-2005	V8-4.6L	<b>CADILLAC</b> DEVILLE
	1993	V8-4.6L	<b>CADILLAC</b> DEVILLE (MEX)
	1995-2002	V8-4.6L	<b>CADILLAC</b> ELDORADO
	1995-2004	V8-4.6L	<b>CADILLAC</b> SEVILLE
	1996-1997	V8-4.9L	<b>CADILLAC</b> DEVILLE (MEX)
<b>US5073</b>	1992	V8-5.7L	<b>CHEVROLET</b> C1500
	1992	V8-5.7L	<b>CHEVROLET</b> C1500 SUBURBAN
	1992	V8-5.7L	<b>CHEVROLET</b> C2500 SUBURBAN
	1992	V8-5.7L	<b>CHEVROLET</b> K1500 SUBURBAN
	1992	V8-5.7L	<b>CHEVROLET</b> K2500 SUBURBAN
	1992	V8-5.7L	<b>GMC</b> C1500
	1992	V8-5.7L	<b>GMC</b> C1500 SUBURBAN
	1992	V8-5.7L	<b>GMC</b> C2500 SUBURBAN
	1992	V8-5.7L	<b>GMC</b> K1500 SUBURBAN
	1992	V8-5.7L	<b>GMC</b> K2500 SUBURBAN
<b>US5074</b>	1997-1998	V8-6.5L	<b>AM GENERAL</b> HUMMER
	1996-1998	V8-6.5L	<b>CHEVROLET</b> C1500
	1996-1999	V8-6.5L	<b>CHEVROLET</b> C1500 SUBURBAN
	1996-1999	V8-6.5L	<b>CHEVROLET</b> C2500
	1996-1999	V8-6.5L	<b>CHEVROLET</b> C2500 SUBURBAN
	1996-1999	V8-6.5L	<b>CHEVROLET</b> C3500
	1996-1998	V8-6.5L	<b>CHEVROLET</b> EXPRESS 2500
	1996-1998	V8-6.5L	<b>CHEVROLET</b> EXPRESS 3500
	1996-1998	V8-6.5L	<b>CHEVROLET</b> K1500
	1996-1999	V8-6.5L	<b>CHEVROLET</b> K1500 SUBURBAN
	1996-1999	V8-6.5L	<b>CHEVROLET</b> K2500
	1996-1999	V8-6.5L	<b>CHEVROLET</b> K2500 SUBURBAN
	1996-1999	V8-6.5L	<b>CHEVROLET</b> K3500
	1997-1998	V8-6.5L	<b>CHEVROLET</b> P30
	1996-1999	V8-6.5L	<b>CHEVROLET</b> TAHOE
	1996-1997	V8-6.5L	<b>GMC</b> C1500
	1996-1999	V8-6.5L	<b>GMC</b> C1500 SUBURBAN
	1996-1999	V8-6.5L	<b>GMC</b> C2500
	1996-1999	V8-6.5L	<b>GMC</b> C2500 SUBURBAN
	1996-1999	V8-6.5L	<b>GMC</b> C3500
	1996-1998	V8-6.5L	<b>GMC</b> K1500

**WATER PUMPS**



USMW	Years	Cyl.	Specifications
	1996-1999	V8-6.5L	GMC K1500 SUBURBAN
	1996-1999	V8-6.5L	GMC K2500
	1996-1999	V8-6.5L	GMC K2500 SUBURBAN
	1996-1999	V8-6.5L	GMC K3500
	1996-1998	V8-6.5L	GMC P3500
	1996-1998	V8-6.5L	GMC SAVANA 2500
	1996-1998	V8-6.5L	GMC SAVANA 3500
	1996-1997	V8-6.5L	GMC YUKON
<b>US5075</b>	2005-2009	V6-3.8L	BUICK LACROSSE
	1996-2005	V6-3.8L	BUICK LESABRE
	2006-2008	V6-3.8L	BUICK LUCERNE
	1996-2005	V6-3.8L	BUICK PARK AVENUE
	1996-2004	V6-3.8L	BUICK REGAL
	1996-1999	V6-3.8L	BUICK RIVIERA
	1996-2002	V6-3.8L	CHEVROLET CAMARO
	1999-2002	V6-3.8L	CHEVROLET GRAND AM (MEX)
	2000-2005	V6-3.8L	CHEVROLET IMPALA
	1998-1999	V6-3.8L	CHEVROLET LUMINA
	1998-2005	V6-3.8L	CHEVROLET MONTE CARLO
	1996-1999	V6-3.8L	OLDSMOBILE 88
	1996	V6-3.8L	OLDSMOBILE 98
	1998-1999	V6-3.8L	OLDSMOBILE INTRIGUE
	1996-1999	V6-3.8L	OLDSMOBILE LSS
	1997-1998	V6-3.8L	OLDSMOBILE REGENCY
	1996-2005	V6-3.8L	PONTIAC BONNEVILLE
	1996-2002	V6-3.8L	PONTIAC FIREBIRD
	1997-2008	V6-3.8L	PONTIAC GRAND PRIX
<b>US5076</b>	1996-1998	L4-2.4L	BUICK SKYLARK
	1996-2002	L4-2.4L	CHEVROLET CAVALIER
	1997-1999	L4-2.4L	CHEVROLET MALIBU
	2000-2001	L4-2.4L	CHEVROLET MALIBU (MEX)
	1996-1998	L4-2.4L	OLDSMOBILE ACHIEVA
	1999-2001	L4-2.4L	OLDSMOBILE ALERO
	1996-2001	L4-2.4L	PONTIAC GRAND AM
	1996-2002	L4-2.4L	PONTIAC SUNFIRE
<b>US5077</b>	1996-2005	V6-4.3L	CHEVROLET ASTRO
	1996-2005	V6-4.3L	CHEVROLET BLAZER
	1996-1998	V6-4.3L	CHEVROLET C1500
	1996-2011	V6-4.3L	CHEVROLET EXPRESS 1500
	1996-2005	V6-4.3L	CHEVROLET EXPRESS 2500
	1996-1998	V6-4.3L	CHEVROLET K1500
	1996-1999	V6-4.3L	CHEVROLET P30
	2001	V6-4.3L	CHEVROLET P30 VAN (MEX)
	1996-2004	V6-4.3L	CHEVROLET S10
	1999-2011	V6-4.3L	CHEVROLET SILVERADO 1500
	1996-1998	V6-4.3L	GMC C1500
	1996-2001	V6-4.3L	GMC JIMMY
	1996-1998	V6-4.3L	GMC K1500
	1996-1999	V6-4.3L	GMC P3500
	1996-2005	V6-4.3L	GMC SAFARI
	1996-2011	V6-4.3L	GMC SAVANA 1500
	1996-2005	V6-4.3L	GMC SAVANA 2500
	1999-2011	V6-4.3L	GMC SIERRA 1500
	1996-2004	V6-4.3L	GMC SONOMA
	1997-2000	V6-4.3L	ISUZU HOMBRE
	1996-2001	V6-4.3L	OLDSMOBILE BRAVADA
	1999	V8-4.3L	CHEVROLET C1500 (MEX)
	1996-1999	V8-5.0L	CHEVROLET C1500
	1996-1998	V8-5.0L	CHEVROLET C2500
	1996-2002	V8-5.0L	CHEVROLET EXPRESS 1500
	1996-2002	V8-5.0L	CHEVROLET EXPRESS 2500
	1996-1999	V8-5.0L	CHEVROLET K1500
	1998	V8-5.0L	CHEVROLET K2500
	1996-1999	V8-5.0L	GMC C1500
	1996-1998	V8-5.0L	GMC C2500
	1996-1999	V8-5.0L	GMC K1500
	1998	V8-5.0L	GMC K2500
	1996-2002	V8-5.0L	GMC SAVANA 1500
	1996-2002	V8-5.0L	GMC SAVANA 2500

USMW	Years	Cyl.	Specifications
	1999-2000	V8-5.7L	CADILLAC ESCALADE
	1996-1997	V8-5.7L	CHEVROLET 400 (MEX)
	1996-1997	V8-5.7L	CHEVROLET BOSS TRUCK (MEX)
	1996-1999	V8-5.7L	CHEVROLET C1500
	2000	V8-5.7L	CHEVROLET C1500 (MEX)
	1996-1999	V8-5.7L	CHEVROLET C1500 SUBURBAN
	1996-2000	V8-5.7L	CHEVROLET C2500
	1998	V8-5.7L	CHEVROLET C2500 (MEX)
	1996-1999	V8-5.7L	CHEVROLET C2500 SUBURBAN
	1996-2000	V8-5.7L	CHEVROLET C3500
	1996-2002	V8-5.7L	CHEVROLET EXPRESS 1500
	1996-2002	V8-5.7L	CHEVROLET EXPRESS 2500
	1996-2002	V8-5.7L	CHEVROLET EXPRESS 3500
	1996-1999	V8-5.7L	CHEVROLET K1500
	2000	V8-5.7L	CHEVROLET K1500 (MEX)
	1996-1999	V8-5.7L	CHEVROLET K1500 SUBURBAN
	1996-2000	V8-5.7L	CHEVROLET K2500
	2000	V8-5.7L	CHEVROLET K2500 (MEX)
	1996-1999	V8-5.7L	CHEVROLET K2500 SUBURBAN
	1996-2000	V8-5.7L	CHEVROLET K3500
	1996-1999	V8-5.7L	CHEVROLET P30
	1998-1999	V8-5.7L	CHEVROLET P31 VAN (MEX)
	1996-1997	V8-5.7L	CHEVROLET SILVERADO (MEX)
	1999-2001	V8-5.7L	CHEVROLET SILVERADO 1500 (MEX)
	1999-2001	V8-5.7L	CHEVROLET SILVERADO 2500 (MEX)
	1996-2000	V8-5.7L	CHEVROLET TAHOE
	1996-1999	V8-5.7L	GMC C1500
	1996-1999	V8-5.7L	GMC C1500 SUBURBAN
	1996-2000	V8-5.7L	GMC C2500
	1996-1999	V8-5.7L	GMC C2500 SUBURBAN
	1996-2000	V8-5.7L	GMC C3500
	1996-1999	V8-5.7L	GMC K1500
	1996-1999	V8-5.7L	GMC K1500 SUBURBAN
	1996-2000	V8-5.7L	GMC K2500
	1996-1999	V8-5.7L	GMC K2500 SUBURBAN
	1996-2000	V8-5.7L	GMC K3500
	1996-1999	V8-5.7L	GMC P3500
	1996-2002	V8-5.7L	GMC SAVANA 1500
	1996-2002	V8-5.7L	GMC SAVANA 2500
	1996-2002	V8-5.7L	GMC SAVANA 3500
	1996-1999	V8-5.7L	GMC YUKON
<b>US5079</b>	1994-1997	V6-2.5L	SAAB 900
	1997-2001	V6-3.0L	CADILLAC CATERA
	1995-1997	V6-3.0L	SAAB 9000
	1999-2003	V6-3.0L	SAAB 41887
	2001-2005	V6-3.0L	SATURN L300
	2000	V6-3.0L	SATURN LS2
	2000	V6-3.0L	SATURN LW2
	2001-2003	V6-3.0L	SATURN LW300
	2002-2003	V6-3.0L	SATURN VUE
	2003-2004	V6-3.2L	CADILLAC CTS
	2004-2005	V6-3.2L	CHEVROLET VECTRA (MEX)
<b>US5081</b>	1998-2002	V8-5.7L	CHEVROLET CAMARO
	1997-2004	V8-5.7L	CHEVROLET CORVETTE
	1998-2001	V8-5.7L	CHEVROLET FIREBIRD TRANS AM (MEX)
	1998-2002	V8-5.7L	PONTIAC FIREBIRD
	2004	V8-5.7L	PONTIAC GTO
<b>US5085</b>	2001-2002	V6-3.5L	OLDSMOBILE AURORA
	1999-2002	V6-3.5L	OLDSMOBILE INTRIGUE
<b>US5086</b>	1999-2001	V8-6.5L	AM GENERAL HUMMER
	1999	V8-6.5L	CHEVROLET C1500 SUBURBAN
	1999-2000	V8-6.5L	CHEVROLET C2500
	1999	V8-6.5L	CHEVROLET C2500 SUBURBAN
	1999-2002	V8-6.5L	CHEVROLET C3500
	1999-2002	V8-6.5L	CHEVROLET EXPRESS 2500
	1999-2002	V8-6.5L	CHEVROLET EXPRESS 3500
	1999	V8-6.5L	CHEVROLET K1500 SUBURBAN
	1999-2000	V8-6.5L	CHEVROLET K2500
	1999	V8-6.5L	CHEVROLET K2500 SUBURBAN

USMW	Years	Cyl.	Specifications
	1999-2000	V8-6.5L	CHEVROLET K3500
	1999	V8-6.5L	CHEVROLET P30
	1999	V8-6.5L	GMC C1500 SUBURBAN
	1999-2000	V8-6.5L	GMC C2500
	1999	V8-6.5L	GMC C2500 SUBURBAN
	1999-2002	V8-6.5L	GMC C3500
	1999	V8-6.5L	GMC K1500 SUBURBAN
	1999-2000	V8-6.5L	GMC K2500
	1999	V8-6.5L	GMC K2500 SUBURBAN
	1999-2000	V8-6.5L	GMC K3500
	1999	V8-6.5L	GMC P3500
	1999-2002	V8-6.5L	GMC SAVANA 2500
	1999-2002	V8-6.5L	GMC SAVANA 3500
	2002-2004	V8-6.5L	HUMMER H1
<b>US5087</b>	2003	V6-4.3L	CHEVROLET SONORA (MEX)
	2003	V8-4.8L	CHEVROLET EXPRESS 2500
	2003	V8-4.8L	GMC SAVANA 2500
	2002-2003	V8-5.3L	CADILLAC ESCALADE
	2002-2003	V8-5.3L	CHEVROLET AVALANCHE 1500
	2003	V8-5.3L	CHEVROLET EXPRESS 1500
	2003	V8-5.3L	CHEVROLET EXPRESS 2500
	1999-2003	V8-5.3L	CHEVROLET SILVERADO 1500
	1999-2000	V8-5.3L	CHEVROLET SILVERADO 2500
	2003	V8-5.3L	CHEVROLET SILVERADO 2500 (MEX)
	2003-2004	V8-5.3L	CHEVROLET SONORA (MEX)
	2000-2003	V8-5.3L	CHEVROLET SUBURBAN 1500
	2000	V8-5.3L	CHEVROLET SUBURBAN 2500
	2002-2003	V8-5.3L	CHEVROLET TAHOE
	2003	V8-5.3L	GMC SAVANA 1500
	2003	V8-5.3L	GMC SAVANA 2500
	1999-2003	V8-5.3L	GMC SIERRA 1500
	1999-2000	V8-5.3L	GMC SIERRA 2500
	2000-2003	V8-5.3L	GMC YUKON
	2000-2003	V8-5.3L	GMC YUKON XL 1500
	2003-2004	V8-5.3L	ISUZU ASCENDER
	2000	V8-5.7L	CHEVROLET C2500 (MEX)
	2001-2003	V8-5.7L	CHEVROLET SILVERADO 3500 (MEX)
	2001-2002	V8-5.7L	CHEVROLET SUBURBAN 1500 (MEX)
	2002-2003	V8-6.0L	CADILLAC ESCALADE
	2003	V8-6.0L	CHEVROLET EXPRESS 2500
	2003	V8-6.0L	CHEVROLET EXPRESS 3500
	2003	V8-6.0L	CHEVROLET SILVERADO 1500
	2001	V8-6.0L	CHEVROLET SILVERADO 1500 HD
	1999-2001	V8-6.0L	CHEVROLET SILVERADO 2500
	2001	V8-6.0L	CHEVROLET SILVERADO 2500 HD
	2001	V8-6.0L	CHEVROLET SILVERADO 3500
	2003	V8-6.0L	CHEVROLET SONORA (MEX)
	2001	V8-6.0L	CHEVROLET SUBURBAN 2500
	2003	V8-6.0L	GMC SAVANA 2500
	2003	V8-6.0L	GMC SAVANA 3500
	2001	V8-6.0L	GMC SIERRA 1500 HD
	1999-2001	V8-6.0L	GMC SIERRA 2500
	2001	V8-6.0L	GMC SIERRA 2500 HD
	2001	V8-6.0L	GMC SIERRA 3500
	2001	V8-6.0L	GMC SIERRA C3
	2000-2001	V8-6.0L	GMC YUKON XL 2500
	2003	V8-6.0L	HUMMER H2
<b>US5089</b>	2002-2006	V8-8.1L	CHEVROLET AVALANCHE 2500
	2001-2007	V8-8.1L	CHEVROLET SILVERADO 2500 HD
	2001-2007	V8-8.1L	CHEVROLET SILVERADO 3500
	2001-2006	V8-8.1L	CHEVROLET SUBURBAN 2500
	2001-2007	V8-8.1L	GMC SIERRA 2500 HD
	2001-2007	V8-8.1L	GMC SIERRA 3500
	2001-2006	V8-8.1L	GMC YUKON XL 2500
<b>US5090</b>	2001-2002	V8-8.1L	CHEVROLET C3500
	2001-2002	V8-8.1L	CHEVROLET EXPRESS 3500
	2001-2002	V8-8.1L	GMC C3500
	2001-2002	V8-8.1L	GMC SAVANA 3500
<b>US5092</b>	2011-2013	L4-2.0L	BUICK REGAL

USMW	Years	Cyl.	Specifications
	2013	L4-2.0L	BUICK VERANO
	2005-2010	L4-2.0L	CHEVROLET COBALT
	2008-2010	L4-2.0L	CHEVROLET HHR
	2007-2009	L4-2.0L	PONTIAC SOLSTICE
	2003-2011	L4-2.0L	SAAB 41885
	2010-2011	L4-2.0L	SAAB 9-3X
	2004-2007	L4-2.0L	SATURN ION
	2007-2010	L4-2.0L	SATURN SKY
	2002-2005	L4-2.2L	CHEVROLET CAVALIER
	2004-2005	L4-2.2L	CHEVROLET CLASSIC
	2005-2010	L4-2.2L	CHEVROLET COBALT
	2006-2011	L4-2.2L	CHEVROLET HHR
	2004-2008	L4-2.2L	CHEVROLET MALIBU
	2003-2005	L4-2.2L	CHEVROLET VECTRA (MEX)
	2001-2006	L4-2.2L	CHEVROLET ZAFIRA (MEX)
	2002-2004	L4-2.2L	OLDSMOBILE ALERO
	2005-2006	L4-2.2L	PONTIAC G4 (MEX)
	2007-2010	L4-2.2L	PONTIAC G5
	2002-2005	L4-2.2L	PONTIAC GRAND AM
	2005-2006	L4-2.2L	PONTIAC PURSUIT
	2002-2005	L4-2.2L	PONTIAC SUNFIRE
	2001-2002	L4-2.2L	SATURN L100
	2001-2003	L4-2.2L	SATURN L200
	2001-2004	L4-2.2L	SATURN L300
	2000	L4-2.2L	SATURN LS
	2000	L4-2.2L	SATURN LS1
	2000	L4-2.2L	SATURN LW1
	2001-2003	L4-2.2L	SATURN LW200
	2002-2007	L4-2.2L	SATURN VUE
	2010-2014	L4-2.4L	BUICK LACROSSE
	2011-2013	L4-2.4L	BUICK REGAL
	2012-2013	L4-2.4L	BUICK VERANO
	2012-2013	L4-2.4L	CHEVROLET CAPTIVA SPORT
	2006-2008	L4-2.4L	CHEVROLET COBALT
	2010-2013	L4-2.4L	CHEVROLET EQUINOX
	2006-2011	L4-2.4L	CHEVROLET HHR
	2008-2013	L4-2.4L	CHEVROLET MALIBU
	2010-2013	L4-2.4L	GMC TERRAIN
	2006	L4-2.4L	PONTIAC G4 (MEX)
	2007-2008	L4-2.4L	PONTIAC G5
	2006-2010	L4-2.4L	PONTIAC G6
	2006	L4-2.4L	PONTIAC PURSUIT
	2006-2009	L4-2.4L	PONTIAC SOLSTICE
	2007-2009	L4-2.4L	SATURN AURA
	2003-2006	L4-2.4L	SATURN ION
	2007-2010	L4-2.4L	SATURN VUE
<b>US5097</b>	2004-2006	L4-2.8L	CHEVROLET COLORADO
	2004-2006	L4-2.8L	GMC CANYON
	2006	L4-2.8L	ISUZU I-280
	2007-2011	L4-2.9L	CHEVROLET COLORADO
	2007-2011	L4-2.9L	GMC CANYON
	2007-2008	L4-2.9L	ISUZU I-290
	2006	L4-2.9L	ISUZU I-350
	2007-2008	L4-2.9L	ISUZU I-370
	2004-2006	L5-3.5L	CHEVROLET COLORADO
	2004-2006	L5-3.5L	GMC CANYON
	2006	L5-3.5L	HUMMER H3
	2007-2011	L5-3.7L	CHEVROLET COLORADO
	2006-2011	L5-3.7L	GMC CANYON
	2010-2012	L5-3.7L	GMC CANYON (MEX)
	2007-2010	L5-3.7L	HUMMER H3
	2009-2010	L5-3.7L	HUMMER H3T
	2004-2007	L6-4.2L	BUICK RAINIER
	2002-2009	L6-4.2L	CHEVROLET TRAILBLAZER
	2002-2009	L6-4.2L	GMC ENVOY
	2003-2008	L6-4.2L	ISUZU ASCENDER
	2002-2004	L6-4.2L	OLDSMOBILE BRAVADA
	2005-2009	L6-4.2L	SAAB 9-7X
<b>US6006</b>	2010-2013	V8-6.2L	FORD F-150

**WATER PUMPS**

USMW	Years	Cyl.	Specifications
	2011-2013	V8-6.2L	FORD F-250 SUPER DUTY
	2011-2013	V8-6.2L	FORD F-350 SUPER DUTY
<b>US6007</b>	2004-2006	L5-2.7L	DODGE SPRINTER 2500
	2004-2006	L5-2.7L	DODGE SPRINTER 3500
	2004-2006	L5-2.7L	MERCEDES-BENZ SPRINTER (MEX)
<b>US6008</b>	2003	L5-2.7L	DODGE SPRINTER 2500
	2003	L5-2.7L	DODGE SPRINTER 3500
<b>US6009</b>	2007-2011	V8-4.8L	CHEVROLET EXPRESS 2500
	2007-2011	V8-4.8L	CHEVROLET EXPRESS 3500
	2007-2011	V8-4.8L	CHEVROLET SILVERADO 1500
	2010-2011	V8-4.8L	CHEVROLET SILVERADO 2500 (MEX)
	2007-2009	V8-4.8L	CHEVROLET TAHOE
	2007-2011	V8-4.8L	GMC SAVANA 2500
	2007-2011	V8-4.8L	GMC SAVANA 3500
	2007-2011	V8-4.8L	GMC SIERRA 1500
	2007-2009	V8-4.8L	GMC YUKON
	2007	V8-5.3L	BUICK RAINIER
	2007-2011	V8-5.3L	CHEVROLET AVALANCHE
	2010	V8-5.3L	CHEVROLET AVALANCHE (MEX)
	2010	V8-5.3L	CHEVROLET CHEYENNE (MEX)
	2009-2011	V8-5.3L	CHEVROLET COLORADO
	2007-2011	V8-5.3L	CHEVROLET EXPRESS 1500
	2008	V8-5.3L	CHEVROLET EXPRESS 1500 (MEX)
	2007-2011	V8-5.3L	CHEVROLET SILVERADO 1500
	2010-2011	V8-5.3L	CHEVROLET SILVERADO 2500 (MEX)
	2010-2012	V8-5.3L	CHEVROLET SUBURBAN (MEX)
	2007-2011	V8-5.3L	CHEVROLET SUBURBAN 1500
	2007-2011	V8-5.3L	CHEVROLET TAHOE
	2011-2012	V8-5.3L	CHEVROLET TAHOE (MEX)
	2007-2008	V8-5.3L	CHEVROLET TRAILBLAZER
	2009-2011	V8-5.3L	GMC CANYON
	2007-2009	V8-5.3L	GMC ENVOY
	2007-2011	V8-5.3L	GMC SAVANA 1500
	2010-2012	V8-5.3L	GMC SIERRA (MEX)
	2007-2011	V8-5.3L	GMC SIERRA 1500
	2007-2011	V8-5.3L	GMC YUKON
	2007-2011	V8-5.3L	GMC YUKON XL 1500
	2008-2009	V8-5.3L	HUMMER H2
	2008-2010	V8-5.3L	HUMMER H3
	2009-2010	V8-5.3L	HUMMER H3T
	2007-2009	V8-5.3L	SAAB 9-7X
	2009-2011	V8-6.0L	CADILLAC ESCALADE
	2007-2009	V8-6.0L	CHEVROLET AVALANCHE
	2007-2011	V8-6.0L	CHEVROLET EXPRESS 2500
	2007-2011	V8-6.0L	CHEVROLET EXPRESS 3500
	2009-2011	V8-6.0L	CHEVROLET EXPRESS 4500
	2007-2011	V8-6.0L	CHEVROLET SILVERADO 1500
	2007	V8-6.0L	CHEVROLET SILVERADO 1500 HD
	2007-2011	V8-6.0L	CHEVROLET SILVERADO 2500 HD
	2007	V8-6.0L	CHEVROLET SILVERADO 3500
	2007-2011	V8-6.0L	CHEVROLET SILVERADO 3500 HD
	2007-2009	V8-6.0L	CHEVROLET SUBURBAN 1500
	2007-2011	V8-6.0L	CHEVROLET SUBURBAN 2500
	2008-2011	V8-6.0L	CHEVROLET TAHOE
	2007-2009	V8-6.0L	CHEVROLET TRAILBLAZER
	2007-2011	V8-6.0L	GMC SAVANA 2500
	2007-2011	V8-6.0L	GMC SAVANA 3500
	2007-2011	V8-6.0L	GMC SIERRA 1500
	2007	V8-6.0L	GMC SIERRA 1500 HD
	2007-2011	V8-6.0L	GMC SIERRA 2500 HD
	2007	V8-6.0L	GMC SIERRA 3500
	2007-2011	V8-6.0L	GMC SIERRA 3500 HD
	2008-2011	V8-6.0L	GMC YUKON
	2007-2009	V8-6.0L	GMC YUKON XL 1500
	2007-2011	V8-6.0L	GMC YUKON XL 2500
	2007	V8-6.0L	HUMMER H2
	2008-2009	V8-6.0L	SAAB 9-7X
	2007-2011	V8-6.2L	CADILLAC ESCALADE
	2009-2011	V8-6.2L	CHEVROLET SILVERADO 1500

USMW	Years	Cyl.	Specifications
	2008-2009	V8-6.2L	CHEVROLET TAHOE
	2009	V8-6.2L	GMC SIERRA (MEX)
	2009-2011	V8-6.2L	GMC SIERRA 1500
	2007-2011	V8-6.2L	GMC YUKON
	2009	V8-6.2L	GMC YUKON DENALI AWD (MEX)
	2007-2011	V8-6.2L	GMC YUKON XL 1500
<b>US6018</b>	2007-2008	L4-1.5L	HONDA FIT
	2006	L4-1.5L	HONDA FIT (MEX)
<b>US6020</b>	2006-2011	V6-3.5L	CHEVROLET IMPALA
	2007-2010	V6-3.5L	CHEVROLET MALIBU
	2006-2007	V6-3.5L	CHEVROLET MONTE CARLO
	2007-2010	V6-3.5L	PONTIAC G6
	2007-2008	V6-3.5L	SATURN AURA
	2008-2010	V6-3.5L	SATURN VUE
	2009-2011	V6-3.9L	BUICK LUCERNE
	2006-2007	V6-3.9L	BUICK TERRAZA
	2006-2011	V6-3.9L	CHEVROLET IMPALA
	2006-2007	V6-3.9L	CHEVROLET MALIBU
	2006	V6-3.9L	CHEVROLET MONTE CARLO
	2006-2008	V6-3.9L	CHEVROLET UPLANDER
	2009	V6-3.9L	CHEVROLET UPLANDER (MEX)
	2006-2009	V6-3.9L	PONTIAC G6
	2006	V6-3.9L	PONTIAC MONTANA
	2007-2009	V6-3.9L	PONTIAC MONTANA (MEX)
	2006-2007	V6-3.9L	SATURN RELAY
<b>US6022</b>	2006-2008	L4-2.0L	AUDI A3
	2005-2009	L4-2.0L	AUDI A4
	2005-2009	L4-2.0L	AUDI A4 QUATTRO
	2008-2009	L4-2.0L	AUDI TT
	2009-2012	L4-2.0L	AUDI TT QUATTRO
	2007-2009	L4-2.0L	VOLKSWAGEN EOS
	2012	L4-2.0L	VOLKSWAGEN GOLF
	2006-2008	L4-2.0L	VOLKSWAGEN GTI
	2006-2008	L4-2.0L	VOLKSWAGEN JETTA
	2006-2008	L4-2.0L	VOLKSWAGEN PASSAT
<b>US6023</b>	2007-2010	V6-3.5L	FORD EDGE
	2009-2010	V6-3.5L	FORD FLEX
	2010-2011	V6-3.5L	FORD FUSION
	2008-2010	V6-3.5L	FORD TAURUS
	2008-2009	V6-3.5L	FORD TAURUS X
	2010	V6-3.5L	LINCOLN MKS
	2010	V6-3.5L	LINCOLN MKT
	2007-2010	V6-3.5L	LINCOLN MKX
	2007-2011	V6-3.5L	LINCOLN MKZ
	2007	V6-3.5L	MAZDA CX-9
	2008-2009	V6-3.5L	MERCURY SABLE
	2009-2010	V6-3.7L	LINCOLN MKS
	2010	V6-3.7L	LINCOLN MKT
	2009-2011	V6-3.7L	MAZDA 6
	2008-2011	V6-3.7L	MAZDA CX-9
<b>US6030</b>	2003-2005	L4-1.8L	MERCEDES-BENZ C230
<b>US6034</b>	2004-2006	L4-1.9L	VOLKSWAGEN BEETLE
	2004-2005	L4-1.9L	VOLKSWAGEN GOLF
	2004	L4-1.9L	VOLKSWAGEN JETTA
	2009	L4-1.9L	VOLKSWAGEN JETTA (MEX)
	2010-2013	L4-2.0L	AUDI A3
	2009	L4-2.0L	AUDI TT
	2009	L4-2.0L	AUDI TT QUATTRO
	2013	L4-2.0L	VOLKSWAGEN BEETLE
	2010-2013	L4-2.0L	VOLKSWAGEN GOLF
	2008-2009	L4-2.0L	VOLKSWAGEN GTI
	2008-2013	L4-2.0L	VOLKSWAGEN JETTA
	2004-2008	L4-2.0L	VOLKSWAGEN PASSAT
<b>US6037</b>	2003-2009	V6-4.0L	TOYOTA 4RUNNER
	2007-2009	V6-4.0L	TOYOTA FJ CRUISER
	2005-2012	V6-4.0L	TOYOTA TACOMA
	2005-2011	V6-4.0L	TOYOTA TUNDRA
<b>US6038</b>	2007-2009	L4-1.8L	DODGE CALIBER
	2008-2009	L4-2.0L	DODGE AVENGER (MEX)



USMW	Years	Cyl.	Specifications	USMW	Years	Cyl.	Specifications
	2010	L4-2.0L	<b>DODGE</b> AVENGER SE (MEX)		2006	V6-3.5L	<b>MERCEDES-BENZ</b> C350
	2007-2012	L4-2.0L	<b>DODGE</b> CALIBER		2006	V6-3.5L	<b>MERCEDES-BENZ</b> CLK350
	2007-2012	L4-2.0L	<b>JEEP</b> COMPASS		2006	V6-3.5L	<b>MERCEDES-BENZ</b> E350
	2007-2012	L4-2.0L	<b>JEEP</b> PATRIOT		2006	V6-3.5L	<b>MERCEDES-BENZ</b> ML350
	2008-2011	L4-2.0L	<b>MITSUBISHI</b> LANCER		2006	V6-3.5L	<b>MERCEDES-BENZ</b> R350
	2008-2011	L4-2.0L	<b>MITSUBISHI</b> OUTLANDER		2006	V6-3.5L	<b>MERCEDES-BENZ</b> SLK280
	2011	L4-2.0L	<b>MITSUBISHI</b> OUTLANDER SPORT		2005-2006	V6-3.5L	<b>MERCEDES-BENZ</b> SLK350
	2011-2012	L4-2.4L	<b>CHRYSLER</b> 200	<b>US6142</b>	2006-2007	V6-2.5L	<b>MERCEDES-BENZ</b> C230
	2010	L4-2.4L	<b>CHRYSLER</b> CIRRUS LIMITED (MEX)		2006-2007	V6-3.0L	<b>MERCEDES-BENZ</b> C280
	2010	L4-2.4L	<b>CHRYSLER</b> CIRRUS TOURING (MEX)		2008-2012	V6-3.0L	<b>MERCEDES-BENZ</b> C300
	2007-2010	L4-2.4L	<b>CHRYSLER</b> SEBRING		2007	V6-3.0L	<b>MERCEDES-BENZ</b> E280 (MEX)
	2008-2012	L4-2.4L	<b>DODGE</b> AVENGER		2006-2008	V6-3.0L	<b>MERCEDES-BENZ</b> SLK280
	2013	L4-2.4L	<b>DODGE</b> AVENGER GTS (MEX)		2009-2011	V6-3.0L	<b>MERCEDES-BENZ</b> SLK300
	2010-2011	L4-2.4L	<b>DODGE</b> AVENGER SE (MEX)		2006-2011	V6-3.5L	<b>MERCEDES-BENZ</b> C350
	2007-2011	L4-2.4L	<b>DODGE</b> CALIBER		2006-2009	V6-3.5L	<b>MERCEDES-BENZ</b> CLK350
	2010-2011	L4-2.4L	<b>DODGE</b> CALIBER SE (MEX)		2006-2011	V6-3.5L	<b>MERCEDES-BENZ</b> E350
	2010-2011	L4-2.4L	<b>DODGE</b> CALIBER SXT (MEX)		2010-2012	V6-3.5L	<b>MERCEDES-BENZ</b> GLK350
	2009-2012	L4-2.4L	<b>DODGE</b> JOURNEY		2006-2011	V6-3.5L	<b>MERCEDES-BENZ</b> ML350
	2011	L4-2.4L	<b>DODGE</b> JOURNEY SE (MEX)		2006-2011	V6-3.5L	<b>MERCEDES-BENZ</b> R350
	2011	L4-2.4L	<b>DODGE</b> JOURNEY SXT (MEX)		2005-2011	V6-3.5L	<b>MERCEDES-BENZ</b> SLK350
	2007-2012	L4-2.4L	<b>JEEP</b> COMPASS	<b>US6143</b>	2006-2013	V6-2.5L	<b>LEXUS</b> IS250
	2007-2012	L4-2.4L	<b>JEEP</b> PATRIOT		2006	V6-3.0L	<b>LEXUS</b> GS300
	2010-2013	L4-2.4L	<b>JEEP</b> PATRIOT (MEX)		2007-2013	V6-3.5L	<b>LEXUS</b> GS350
	2009-2011	L4-2.4L	<b>MITSUBISHI</b> LANCER		2007-2013	V6-3.5L	<b>LEXUS</b> GS450H
<b>US6046</b>	2004-2008	L4-1.6L	<b>CHEVROLET</b> AVEO		2006-2013	V6-3.5L	<b>LEXUS</b> IS350
	2007-2008	L4-1.6L	<b>CHEVROLET</b> AVEO5	<b>US6144</b>	2010-2012	V10-6.8L	<b>FORD</b> E-350 SUPER DUTY
<b>US6047</b>	2007-2012	V6-3.5L	<b>LEXUS</b> ES350		2010-2012	V10-6.8L	<b>FORD</b> E-450 SUPER DUTY
	2007-2012	V6-3.5L	<b>LEXUS</b> RX350		2010	V10-6.8L	<b>FORD</b> F-250 SUPER DUTY
	2010-2012	V6-3.5L	<b>LEXUS</b> RX450H		2010	V10-6.8L	<b>FORD</b> F-350 SUPER DUTY
	2005-2014	V6-3.5L	<b>TOYOTA</b> AVALON		2011	V10-6.8L	<b>FORD</b> F-450 SUPER DUTY
	2007-2014	V6-3.5L	<b>TOYOTA</b> CAMRY		2009-2011	V10-6.8L	<b>FORD</b> F-550 SUPER DUTY
	2008-2014	V6-3.5L	<b>TOYOTA</b> HIGHLANDER		2007-2009	V8-4.6L	<b>FORD</b> E-150
	2006-2012	V6-3.5L	<b>TOYOTA</b> RAV4		2007-2009	V8-4.6L	<b>FORD</b> E-250
	2007-2014	V6-3.5L	<b>TOYOTA</b> SIENNA		2007-2008	V8-4.6L	<b>FORD</b> F-150
	2011	V6-3.5L	<b>TOYOTA</b> SIENNA CE (MEX)		2007-2008	V8-5.4L	<b>FORD</b> EXPEDITION
	2009-2014	V6-3.5L	<b>TOYOTA</b> VENZA		2006-2009	V8-5.4L	<b>FORD</b> F-150
<b>US6048</b>	2007-2013	V6-3.3L	<b>HYUNDAI</b> AZERA		2007-2008	V8-5.4L	<b>LINCOLN</b> MARK LT
	2007-2009	V6-3.3L	<b>HYUNDAI</b> SANTA FE		2007-2008	V8-5.4L	<b>LINCOLN</b> NAVIGATOR
	2006-2010	V6-3.3L	<b>HYUNDAI</b> SONATA	<b>US6145</b>	2005-2009	V6-3.4L	<b>CHEVROLET</b> EQUINOX
	2010-2012	V6-3.5L	<b>HYUNDAI</b> SANTA FE		2006-2009	V6-3.4L	<b>PONTIAC</b> TORRENT
	2011-2012	V6-3.5L	<b>KIA</b> SEDONA	<b>US6146</b>	2009-2011	V6-3.0L	<b>AUDI</b> A6 QUATTRO
	2011-2013	V6-3.5L	<b>KIA</b> SORENTO		2009-2013	V6-3.0L	<b>AUDI</b> Q7
	2006-2010	V6-3.8L	<b>HYUNDAI</b> AZERA		2011	V6-3.0L	<b>AUDI</b> Q7 30 ANIV QUATTRO (MEX)
	2007-2008	V6-3.8L	<b>HYUNDAI</b> ENTOURAGE		2011-2012	V6-3.0L	<b>AUDI</b> Q7 QUATTRO (MEX)
	2009-2013	V6-3.8L	<b>HYUNDAI</b> GENESIS		2010-2012	V6-3.0L	<b>AUDI</b> S4
	2010-2013	V6-3.8L	<b>HYUNDAI</b> GENESIS COUPE		2010-2012	V6-3.0L	<b>AUDI</b> S5
	2007-2012	V6-3.8L	<b>HYUNDAI</b> VERACRUZ		2010-2012	V6-3.0L	<b>VOLKSWAGEN</b> TOUAREG
	2007-2009	V6-3.8L	<b>KIA</b> AMANTI		2012	V6-3.0L	<b>VOLKSWAGEN</b> TOUAREG TDI (MEX)
	2009	V6-3.8L	<b>KIA</b> BORREGO		2006-2008	V6-3.2L	<b>AUDI</b> A4
	2006-2010	V6-3.8L	<b>KIA</b> SEDONA		2005-2009	V6-3.2L	<b>AUDI</b> A4 QUATTRO
	2007-2009	V6-3.8L	<b>KIA</b> SORENTO		2006-2009	V6-3.2L	<b>AUDI</b> A6
<b>US6049</b>	2006-2010	H4-2.5L	<b>SUBARU</b> FORESTER		2005-2008	V6-3.2L	<b>AUDI</b> A6 QUATTRO
	2006-2011	H4-2.5L	<b>SUBARU</b> IMPREZA	<b>US6149</b>	2006-2012	L4-2.4L	<b>MITSUBISHI</b> ECLIPSE
	2006-2012	H4-2.5L	<b>SUBARU</b> LEGACY		2004-2011	L4-2.4L	<b>MITSUBISHI</b> GALANT
	2006-2012	H4-2.5L	<b>SUBARU</b> OUTBACK		2004-2006	L4-2.4L	<b>MITSUBISHI</b> LANCER
<b>US6050</b>	2006-2012	L5-2.5L	<b>VOLKSWAGEN</b> BEETLE		2004-2006	L4-2.4L	<b>MITSUBISHI</b> OUTLANDER
	2005-2009	L5-2.5L	<b>VOLKSWAGEN</b> BORA (MEX)	<b>US6152</b>	2005-2006	L6-3.2L	<b>MERCEDES-BENZ</b> E320
	2008-2011	L5-2.5L	<b>VOLKSWAGEN</b> CRAFTER (MEX)	<b>US6154</b>	2008-2009	V8-5.3L	<b>BUICK</b> LACROSSE
	2010-2012	L5-2.5L	<b>VOLKSWAGEN</b> GOLF		2006-2009	V8-5.3L	<b>CHEVROLET</b> IMPALA
	2005-2012	L5-2.5L	<b>VOLKSWAGEN</b> JETTA		2006-2007	V8-5.3L	<b>CHEVROLET</b> MONTE CARLO
	2011	L5-2.5L	<b>VOLKSWAGEN</b> JETTA BICENTENARIO (MEX)		2005-2008	V8-5.3L	<b>PONTIAC</b> GRAND PRIX
	2011-2013	L5-2.5L	<b>VOLKSWAGEN</b> JETTA SPORT (MEX)	<b>US6155</b>	2007-2009	V6-3.0L	<b>DODGE</b> SPRINTER 2500
	2011-2013	L5-2.5L	<b>VOLKSWAGEN</b> JETTA STYLE (MEX)		2007-2009	V6-3.0L	<b>DODGE</b> SPRINTER 3500
	2012-2013	L5-2.5L	<b>VOLKSWAGEN</b> JETTA STYLE ACTIVE (MEX)		2007-2009	V6-3.0L	<b>JEEP</b> GRAND CHEROKEE
	2012	L5-2.5L	<b>VOLKSWAGEN</b> PASSAT		2007-2009	V6-3.0L	<b>MERCEDES-BENZ</b> E320
	2006-2009	L5-2.5L	<b>VOLKSWAGEN</b> RABBIT		2007-2009	V6-3.0L	<b>MERCEDES-BENZ</b> GL320
<b>US6056</b>	2006-2011	L4-1.8L	<b>HONDA</b> CIVIC		2010-2011	V6-3.0L	<b>MERCEDES-BENZ</b> GL350
<b>US6075</b>	2006	V6-2.5L	<b>MERCEDES-BENZ</b> C230		2007-2009	V6-3.0L	<b>MERCEDES-BENZ</b> ML320
	2006	V6-3.0L	<b>MERCEDES-BENZ</b> C280		2010-2011	V6-3.0L	<b>MERCEDES-BENZ</b> ML350

USMW	Years	Cyl.	Specifications
	2007-2008	V6-3.0L	MERCEDES-BENZ R320
	2010-2011	V6-3.0L	MERCEDES-BENZ R350
	2010-2011	V6-3.0L	MERCEDES-BENZ SPRINTER 2500
	2010-2011	V6-3.0L	MERCEDES-BENZ SPRINTER 3500
<b>US6156</b>	2004-2008	R2-1.3L	MAZDA RX-8
<b>US6159</b>	2003-2005	L4-2.0L	MINI COOPER
<b>US6160</b>	2006	H4-2.5L	SUBARU FORESTER
<b>US6184</b>	2009-2011	L4-1.6L	CHEVROLET AVEO
	2010	L4-1.6L	CHEVROLET AVEO (MEX)
	2009-2011	L4-1.6L	CHEVROLET AVEO5
	2009-2010	L4-1.6L	PONTIAC G3
	2011	L4-1.8L	CHEVROLET CRUZE
	2012	L4-1.8L	CHEVROLET CRUZE (MEX)
	2011-2013	L4-1.8L	CHEVROLET CRUZE LT (MEX)
	2008	L4-1.8L	SATURN ASTRA
<b>US6186</b>	2005-2007	V6-3.0L	FORD FIVE HUNDRED
	2005-2007	V6-3.0L	FORD FREESTYLE
	2005-2007	V6-3.0L	MERCURY MONTEGO
<b>US6197</b>	2008-2013	V8-5.7L	LEXUS LX570
	2008-2013	V8-5.7L	TOYOTA LAND CRUISER
	2008-2014	V8-5.7L	TOYOTA SEQUOIA
	2007-2014	V8-5.7L	TOYOTA TUNDRA
<b>US6198</b>	2011-2012	V6-2.5L	INFINITI G25
	2007	V6-3.5L	INFINITI G35
	2007-2008	V6-3.5L	INFINITI M35
	2007-2012	V6-3.5L	NISSAN ALTIMA
	2009-2012	V6-3.5L	NISSAN MAXIMA
	2007-2012	V6-3.5L	NISSAN MURANO
	2011-2012	V6-3.5L	NISSAN QUEST
<b>US6212</b>	2005-2006	L4-1.9L	VOLKSWAGEN JETTA
<b>US6215</b>	2007-2009	V6-2.7L	HYUNDAI SANTA FE
	2007-2010	V6-2.7L	KIA OPTIMA
	2007-2010	V6-2.7L	KIA RONDO
<b>US6216</b>	2003-2011	L4-1.3L	HONDA CIVIC
<b>US6217</b>	2008-2010	V6-2.7L	CHRYSLER 300
	2008-2010	V6-2.7L	CHRYSLER SEBRING
	2008-2010	V6-2.7L	DODGE AVENGER
	2008-2010	V6-2.7L	DODGE CHARGER
	2008	V6-2.7L	DODGE MAGNUM
<b>US6218</b>	2009-2013	L4-1.8L	NISSAN CUBE
	2007-2012	L4-1.8L	NISSAN VERSA
	2007-2012	L4-2.0L	NISSAN SENTRA
	2010-2012	L4-2.0L	NISSAN SENTRA (MEX)
<b>US6219</b>	2006-2012	L4-2.0L	MAZDA 3
	2006-2012	L4-2.0L	MAZDA MX-5 MIATA
	2006-2009	L4-2.3L	MAZDA 3
	2008-2010	L4-2.3L	MAZDA 5
	2010-2012	L4-2.5L	MAZDA 3
	2012	L4-2.5L	MAZDA 5
	2011-2012	L4-2.5L	MAZDA 6
	2010-2012	L4-2.5L	MAZDA CX-7
<b>US6220</b>	2011	L4-2.0L	HYUNDAI TUCSON
	2011-2013	L4-2.0L	KIA FORTE
	2010-2013	L4-2.0L	KIA FORTEOUP
	2010-2012	L4-2.4L	HYUNDAI SANTA FE
	2006-2010	L4-2.4L	HYUNDAI SONATA
	2010-2011	L4-2.4L	HYUNDAI TUCSON
	2010-2012	L4-2.4L	KIA FORTE
	2010-2013	L4-2.4L	KIA FORTEOUP
	2006-2010	L4-2.4L	KIA OPTIMA
	2007-2010	L4-2.4L	KIA RONDO
	2011-2013	L4-2.4L	KIA SORENTO
<b>US6221</b>	2009-2010	V6-3.0L	AUDI Q7
	2007-2009	V6-3.6L	AUDI Q7
	2009-2013	V6-3.6L	VOLKSWAGEN CC
	2006-2012	V6-3.6L	VOLKSWAGEN PASSAT
	2009	V6-3.6L	VOLKSWAGEN PASSAT (MEX)
	2007-2013	V6-3.6L	VOLKSWAGEN TOUAREG
<b>US6222</b>	2007-2010	L6-6.7L	DODGE RAM 2500

USMW	Years	Cyl.	Specifications
	2007-2010	L6-6.7L	DODGE RAM 3500
	2008-2010	L6-6.7L	DODGE RAM 4500
	2008-2010	L6-6.7L	DODGE RAM 5500
	2011-2012	L6-6.7L	RAM 2500
	2011-2012	L6-6.7L	RAM 3500
	2011-2012	L6-6.7L	RAM 4500
	2011-2012	L6-6.7L	RAM 5500
<b>US6223</b>	2007-2012	L4-2.3L	ACURA RDX
<b>US6228</b>	2003	L4-2.4L	MINI COOPER
<b>US6231</b>	2008-2010	V6-3.3L	CHRYSLER TOWN & COUNTRY
	2008-2010	V6-3.3L	DODGE GRAND CARAVAN
	2008-2010	V6-3.8L	CHRYSLER TOWN & COUNTRY
	2008-2010	V6-3.8L	DODGE GRAND CARAVAN
	2010	V6-3.8L	VOLKSWAGEN ROUTAN (MEX)
<b>US6232</b>	2008-2013	L4-1.8L	SCION XD
	2009-2014	L4-1.8L	TOYOTA COROLLA
	2009-2013	L4-1.8L	TOYOTA MATRIX
<b>US6233</b>	2009-2012	L4-2.4L	ACURA TSX
	2008-2012	L4-2.4L	HONDA ACCORD
	2010-2011	L4-2.4L	HONDA CR-V
<b>US6235</b>	2007-2012	V8-4.6L	MERCEDES-BENZ GL450
	2007-2010	V8-5.5L	MERCEDES-BENZ CL550
	2007-2009	V8-5.5L	MERCEDES-BENZ CLK550
	2007-2011	V8-5.5L	MERCEDES-BENZ CLS550
	2007-2011	V8-5.5L	MERCEDES-BENZ E550
	2009-2012	V8-5.5L	MERCEDES-BENZ G550
	2008-2012	V8-5.5L	MERCEDES-BENZ GL550
	2008-2011	V8-5.5L	MERCEDES-BENZ ML550
	2007-2011	V8-5.5L	MERCEDES-BENZ S550
	2007-2012	V8-5.5L	MERCEDES-BENZ SL550
<b>US6240</b>	2007-2011	V6-3.0L	MINI COOPER
<b>US6241</b>	2004-2006	L6-2.5L	SUZUKI VERONA
<b>US6242</b>	2005-2011	L4-2.5L	NISSAN FRONTIER
	2006	V6-2.4L	NISSAN FRONTIER (MEX)
<b>US6244</b>	2007-2013	L4-1.6L	MINI COOPER
	2011-2013	L4-1.6L	MINI COOPER COUNTRYMAN
<b>US6249</b>	2009	V6-3.2L	AUDI A4 QUATTRO
	2008-2010	V6-3.2L	AUDI A5 QUATTRO
	2010-2011	V6-3.2L	AUDI A6
	2009-2012	V6-3.2L	AUDI Q5
	2010-2012	V6-3.2L	AUDI Q5 QUATTRO (MEX)
<b>US6250</b>	2009-2012	V6-3.0L	FORD ESCAPE
	2010-2012	V6-3.0L	FORD FUSION
	2009-2011	V6-3.0L	MERCURY MARINER
	2010-2011	V6-3.0L	MERCURY MILAN
<b>US6252</b>	2011-2013	L4-2.5L	SCION TC
	2010-2013	L4-2.5L	TOYOTA CAMRY
	2009-2013	L4-2.5L	TOYOTA RAV4
	2009-2013	L4-2.7L	TOYOTA HIGHLANDER
	2011-2012	L4-2.7L	TOYOTA SIENNA
	2009-2013	L4-2.7L	TOYOTA VENZA
<b>US6338</b>	2008-2011	V8-4.6L	LEXUS GS460
	2007-2013	V8-4.6L	LEXUS LS460
	2008-2013	V8-5.0L	LEXUS IS F
	2008-2013	V8-5.0L	LEXUS LS600H
<b>US6341</b>	2009	L6-5.9L	DODGE RAM 2500
	2009	L6-5.9L	DODGE RAM 3500
	2009	V8-5.7L	CHRYSLER ASPEN
	2009	V8-5.7L	DODGE DURANGO
	2009-2010	V8-5.7L	DODGE RAM 1500
	2009-2010	V8-5.7L	DODGE RAM 2500
	2009	V8-5.7L	DODGE RAM 3500
	2011-2012	V8-5.7L	RAM 1500
	2011-2012	V8-5.7L	RAM 2500
	2011-2012	V8-5.7L	RAM 3500
<b>US6349</b>	2009	V6-3.0L	MERCEDES-BENZ R320
<b>US6350</b>	2009-2013	L4-1.5L	HONDA FIT
<b>US6599</b>	2010-2014	V6-4.0L	TOYOTA 4RUNNER
	2010-2014	V6-4.0L	TOYOTA FJ CRUISER

USMW	Years	Cyl.	Specifications
	2011-2014	V6-4.0L	TOYOTA TUNDRA
<b>US6657</b>	2002-2005	V6-2.5L	JAGUAR X-TYPE
	2002-2008	V6-3.0L	JAGUAR X-TYPE
<b>US6662</b>	2013	L4-1.4L	BUICK ENCORE
	2011-2013	L4-1.4L	CHEVROLET CRUZE
	2012-2013	L4-1.4L	CHEVROLET SONIC
<b>US6687</b>	2009-2011	L4-1.6L	NISSAN VERSA
<b>US6699</b>	2012-2013	V6-3.6L	JEEP WRANGLER
<b>US7100</b>	1980-1983	L6-3.7L	CHRYSLER CORDOBA
	1983	L6-3.7L	CHRYSLER FIFTH AVENUE
	1978-1981	L6-3.7L	CHRYSLER LEBARON
	1982	L6-3.7L	CHRYSLER NEW YORKER
	1980-1981	L6-3.7L	CHRYSLER NEWPORT
	1978-1981	L6-3.7L	CHRYSLER TOWN & COUNTRY
	1986-1989	L6-3.7L	CHRYSLER VOLARE (MEX)
	1976-1980	L6-3.7L	DODGE ASPEN
	1975-1980	L6-3.7L	DODGE B100
	1981-1987	L6-3.7L	DODGE B150
	1975-1980	L6-3.7L	DODGE B200
	1981-1987	L6-3.7L	DODGE B250
	1975-1980	L6-3.7L	DODGE B300
	1976	L6-3.7L	DODGE CHARGER
	1975-1976	L6-3.7L	DODGE CORONET
	1965-1970	L6-3.7L	DODGE CORONET (MEX)
	1975-1987	L6-3.7L	DODGE D100
	1970	L6-3.7L	DODGE D100 (MEX)
	1971-1974	L6-3.7L	DODGE D100 1/2 TON P/U (MEX)
	1977-1987	L6-3.7L	DODGE D150
	1980-1990	L6-3.7L	DODGE D150 (MEX)
	1975-1980	L6-3.7L	DODGE D200
	1981-1987	L6-3.7L	DODGE D250
	1975-1978	L6-3.7L	DODGE D300
	1967-1979	L6-3.7L	DODGE D300 (MEX)
	1980-1990	L6-3.7L	DODGE D350 (MEX)
	1975-1976	L6-3.7L	DODGE DART
	1965-1982	L6-3.7L	DODGE DART (MEX)
	1978-1983	L6-3.7L	DODGE DIPLOMAT
	1980-1983	L6-3.7L	DODGE MIRADA
	1977-1978	L6-3.7L	DODGE MONACO
	1975-1980	L6-3.7L	DODGE RAMCHARGER
	1979-1981	L6-3.7L	DODGE ST. REGIS
	1975-1987	L6-3.7L	DODGE W100
	1978-1987	L6-3.7L	DODGE W150
	1975-1980	L6-3.7L	DODGE W200
	1985-1987	L6-3.7L	DODGE W250 (MEX)
	1975-1978	L6-3.7L	DODGE W300
	1975-1976	L6-3.7L	PLYMOUTH DUSTER
	1975-1978	L6-3.7L	PLYMOUTH FURY
	1980-1983	L6-3.7L	PLYMOUTH GRAN FURY
	1975-1980	L6-3.7L	PLYMOUTH PB100
	1981-1983	L6-3.7L	PLYMOUTH PB150
	1975-1980	L6-3.7L	PLYMOUTH PB200
	1981-1983	L6-3.7L	PLYMOUTH PB250
	1975-1976	L6-3.7L	PLYMOUTH SCAMP
	1975-1980	L6-3.7L	PLYMOUTH TRAILDUSTER
	1975-1976	L6-3.7L	PLYMOUTH VALIANT
	1974-1981	L6-3.7L	PLYMOUTH VALIANT (MEX)
	1976-1980	L6-3.7L	PLYMOUTH VOLARE
	1976-1982	L6-3.7L	PLYMOUTH VOLARE (MEX)
<b>US7101</b>	1978-1983	L4-1.7L	DODGE OMNI
	1978-1983	L4-1.7L	PLYMOUTH HORIZON
<b>US7104</b>	1979-1980	L4-1.6L	DODGE COLT
	1979-1980	L4-1.6L	PLYMOUTH CHAMP
	1979	L4-1.6L	PLYMOUTH COLT
<b>US7105</b>	1978-1979	L4-1.6L	DODGE CHALLENGER
	1978	L4-1.6L	DODGE COLT
	1978-1980	L4-1.6L	PLYMOUTH ARROW
	1978	L4-1.6L	PLYMOUTH COLT
	1978-1979	L4-1.6L	PLYMOUTH SAPPORO

USMW	Years	Cyl.	Specifications
<b>US7106</b>	1979-1980	L4-1.4L	DODGE COLT
	1979-1980	L4-1.4L	PLYMOUTH CHAMP
	1979	L4-1.4L	PLYMOUTH COLT
<b>US7108</b>	1981-1988	L4-1.6L	DODGE COLT
	1985-1988	L4-1.6L	NISSAN MIRAGE
	1981-1982	L4-1.6L	PLYMOUTH CHAMP
	1983-1988	L4-1.6L	PLYMOUTH COLT
	1989-1990	L4-1.8L	DODGE COLT
	1993-1994	L4-1.8L	EAGLE TALON
	1990-1994	L4-1.8L	NISSAN ECLIPSE
	1989-1990	L4-1.8L	PLYMOUTH COLT
	1990-1994	L4-1.8L	PLYMOUTH LASER
<b>US7110</b>	1986-1988	L4-2.2L	CHRYSLER DART (MEX)
	1983-1984	L4-2.2L	CHRYSLER E CLASS
	1984-1986	L4-2.2L	CHRYSLER LASER
	1982-1988	L4-2.2L	CHRYSLER LEBARON
	1982-1987	L4-2.2L	CHRYSLER LEBARON (MEX)
	1983-1988	L4-2.2L	CHRYSLER NEW YORKER
	1985-1991	L4-2.2L	CHRYSLER NEW YORKER (MEX)
	1987-1994	L4-2.2L	CHRYSLER PHANTOM (MEX)
	1990	L4-2.2L	CHRYSLER TC MASERATI
	1982-1988	L4-2.2L	CHRYSLER TOWN & COUNTRY
	1982-1983	L4-2.2L	DODGE 400
	1983-1988	L4-2.2L	DODGE 600
	1981-1988	L4-2.2L	DODGE ARIES
	1984-1987	L4-2.2L	DODGE CARAVAN
	1984-1987	L4-2.2L	DODGE CHARGER
	1987-1988	L4-2.2L	DODGE DAKOTA
	1982-1988	L4-2.2L	DODGE DART (MEX)
	1984-1988	L4-2.2L	DODGE DAYTONA
	1985-1988	L4-2.2L	DODGE LANCER
	1983-1988	L4-2.2L	DODGE MAGNUM (MEX)
	1984-1987	L4-2.2L	DODGE MINI RAM
	1981-1988	L4-2.2L	DODGE OMNI
	1982-1984	L4-2.2L	DODGE RAMPAGE
	1984-1987	L4-2.2L	DODGE ROYAL MINI RAM
	1987-1988	L4-2.2L	DODGE SHADOW
	1988	L4-2.2L	DODGE SHADOW (MEX)
	1985-1988	L4-2.2L	PLYMOUTH CARAVELLE
	1981-1988	L4-2.2L	PLYMOUTH HORIZON
	1981-1988	L4-2.2L	PLYMOUTH RELIANT
	1983	L4-2.2L	PLYMOUTH SCAMP
	1987-1988	L4-2.2L	PLYMOUTH SUNDANCE
	1982-1988	L4-2.2L	PLYMOUTH VOLARE (MEX)
	1984-1987	L4-2.2L	PLYMOUTH VOYAGER
	1986	L4-2.5L	CHRYSLER LASER
	1986-1988	L4-2.5L	CHRYSLER LEBARON
	1987-1988	L4-2.5L	CHRYSLER MAGNUM (MEX)
	1986-1987	L4-2.5L	CHRYSLER NEW YORKER
	1986-1988	L4-2.5L	CHRYSLER PHANTOM (MEX)
	1988	L4-2.5L	CHRYSLER SHADOW (MEX)
	1986-1988	L4-2.5L	CHRYSLER TOWN & COUNTRY
	1986-1988	L4-2.5L	DODGE 600
	1986-1988	L4-2.5L	DODGE ARIES
	1988	L4-2.5L	DODGE CARAVAN
	1986-1988	L4-2.5L	DODGE DAYTONA
	1988	L4-2.5L	DODGE DYNASTY
	1988	L4-2.5L	DODGE GRAND CARAVAN
	1986-1988	L4-2.5L	DODGE LANCER
	1987-1988	L4-2.5L	DODGE MINI RAM
	1988	L4-2.5L	DODGE SHADOW
	1986-1988	L4-2.5L	PLYMOUTH CARAVELLE
	1988	L4-2.5L	PLYMOUTH GRAND VOYAGER
	1986-1988	L4-2.5L	PLYMOUTH RELIANT
	1988	L4-2.5L	PLYMOUTH SUNDANCE
	1987-1988	L4-2.5L	PLYMOUTH VOYAGER
<b>US7111</b>	1983-1984	L4-2.6L	CHRYSLER E CLASS
	1985	L4-2.6L	CHRYSLER EXECUTIVE LIMOUSINE
	1983-1984	L4-2.6L	CHRYSLER EXECUTIVE SEDAN



USMW	Years	Cyl.	Specifications
	1982-1985	L4-2.6L	CHRYSLER LEBARON
	1983-1985	L4-2.6L	CHRYSLER NEW YORKER
	1982-1985	L4-2.6L	CHRYSLER TOWN & COUNTRY
	1982-1983	L4-2.6L	DODGE 400
	1983-1985	L4-2.6L	DODGE 600
	1981-1985	L4-2.6L	DODGE ARIES
	1984-1987	L4-2.6L	DODGE CARAVAN
	1984-1987	L4-2.6L	DODGE MINI RAM
	1984-1987	L4-2.6L	DODGE ROYAL MINI RAM
	1985	L4-2.6L	PLYMOUTH CARAVELLE
	1981-1985	L4-2.6L	PLYMOUTH RELIANT
	1984-1987	L4-2.6L	PLYMOUTH VOYAGER
<b>US7113</b>	1984	L4-1.6L	DODGE CHARGER
	1983-1986	L4-1.6L	DODGE OMNI
	1983-1986	L4-1.6L	PLYMOUTH HORIZON
<b>US7114</b>	1983-1984	L4-2.0L	DODGE POWER RAM 50
	1983-1989	L4-2.0L	DODGE RAM 50
	1983-1989	L4-2.0L	MITSUBISHI MIGHTY MAX
	2003-2005	L4-2.4L	DODGE H-100 (MEX)
	1990-1993	L4-2.4L	DODGE RAM 50
	1990-1996	L4-2.4L	MITSUBISHI MIGHTY MAX
	1987-1990	L4-2.4L	MITSUBISHI VAN
	1983	L4-2.6L	DODGE POWER RAM 50
	1983-1985	L4-2.6L	DODGE RAM 50
<b>US7115</b>	2006-2009	L4-1.4L	DODGE ATTITUDE (MEX)
	2010	L4-1.4L	DODGE ATTITUDE GL (MEX)
	1981-1984	L4-1.4L	DODGE COLT
	1981-1982	L4-1.4L	PLYMOUTH CHAMP
	1983-1984	L4-1.4L	PLYMOUTH COLT
	1985-1994	L4-1.5L	DODGE COLT
	2004-2006	L4-1.5L	DODGE VERNA (MEX)
	1989-1996	L4-1.5L	EAGLE SUMMIT
	1995-1999	L4-1.5L	HYUNDAI ACCENT
	1986-1994	L4-1.5L	HYUNDAI EXCEL
	1991-1995	L4-1.5L	HYUNDAI SCOUPE
	1985-1996	L4-1.5L	MITSUBISHI MIRAGE
	1987-1994	L4-1.5L	MITSUBISHI PRECIS
	1985-1994	L4-1.5L	PLYMOUTH COLT
	1984	L4-2.6L	DODGE CONQUEST
	1984	L4-2.6L	PLYMOUTH CONQUEST
<b>US7116</b>	1976-1977	L4-2.0L	DODGE COLT
	1979-1982	L4-2.0L	DODGE D50
	1976-1978	L4-2.0L	PLYMOUTH ARROW
	1979-1982	L4-2.0L	PLYMOUTH ARROW PICKUP
	1976-1978	L4-2.0L	PLYMOUTH COLT
	1978-1983	L4-2.6L	DODGE CHALLENGER
	1978-1980	L4-2.6L	DODGE COLT
	1985-1986	L4-2.6L	DODGE CONQUEST
	1979-1982	L4-2.6L	DODGE D50
	1984-1986	L4-2.6L	DODGE POWER RAM 50
	1987-1988	L4-2.6L	DODGE RAIDER
	1984	L4-2.6L	DODGE RAM 50
	1983-1989	L4-2.6L	MITSUBISHI MIGHTY MAX
	1983-1989	L4-2.6L	MITSUBISHI MONTERO
	1983-1987	L4-2.6L	MITSUBISHI STARION
	1979-1980	L4-2.6L	PLYMOUTH ARROW
	1979-1982	L4-2.6L	PLYMOUTH ARROW PICKUP
	1978-1979	L4-2.6L	PLYMOUTH COLT
	1985-1986	L4-2.6L	PLYMOUTH CONQUEST
	1978-1983	L4-2.6L	PLYMOUTH SAPPORO
<b>US7117</b>	1983-1985	L4-2.3L	DODGE POWER RAM 50
	1983-1985	L4-2.3L	DODGE RAM 50
	1983-1985	L4-2.3L	MITSUBISHI MIGHTY MAX
<b>US7118</b>	1983-1988	L4-1.8L	MITSUBISHI CORDIA
	1984-1991	L4-2.0L	DODGE COLT
	1984-1988	L4-2.0L	MITSUBISHI CORDIA
	1984-1991	L4-2.0L	PLYMOUTH COLT
	1989-1991	L4-2.4L	HYUNDAI SONATA
	1985-1987	L4-2.4L	MITSUBISHI GALANT

USMW	Years	Cyl.	Specifications
<b>US7120</b>	1987	L4-2.6L	CHRYSLER CONQUEST
	1985-1986	L4-2.6L	DODGE CONQUEST
	1985-1986	L4-2.6L	DODGE POWER RAM 50
	1987-1989	L4-2.6L	DODGE RAIDER
	1985-1989	L4-2.6L	DODGE RAM 50
	1987-1988	L4-2.6L	MAZDA B2600
	1983-1984	L4-2.6L	MITSUBISHI MONTERO
	1985-1987	L4-2.6L	MITSUBISHI STARION
	1985-1986	L4-2.6L	PLYMOUTH CONQUEST
<b>US7121</b>	2000	V6-3.0L	CHRYSLER GRAND VOYAGER
	1990-1995	V6-3.0L	CHRYSLER LEBARON
	1988-1989	V6-3.0L	CHRYSLER NEW YORKER
	1992-1994	V6-3.0L	CHRYSLER NEW YORKER (MEX)
	1992	V6-3.0L	CHRYSLER SHADOW (MEX)
	1989-1992	V6-3.0L	CHRYSLER SPIRIT (MEX)
	1990-1991	V6-3.0L	CHRYSLER TC MASERATI
	2000	V6-3.0L	CHRYSLER VOYAGER
	1992-1997	V6-3.0L	CHRYSLER VOYAGER (MEX)
	1987-2000	V6-3.0L	DODGE CARAVAN
	1990-1993	V6-3.0L	DODGE DAYTONA
	1988-1993	V6-3.0L	DODGE DYNASTY
	1988-2000	V6-3.0L	DODGE GRAND CARAVAN
	1987-1988	V6-3.0L	DODGE MINI RAM
	1989	V6-3.0L	DODGE RAIDER
	1990-1991	V6-3.0L	DODGE RAM 50
	1987	V6-3.0L	DODGE ROYAL MINI RAM
	1992-1994	V6-3.0L	DODGE SHADOW
	1989-1995	V6-3.0L	DODGE SPIRIT
	1991-1996	V6-3.0L	DODGE STEALTH
	1990-1998	V6-3.0L	HYUNDAI SONATA
	1997-1999	V6-3.0L	MITSUBISHI 3000GT
	1992-1996	V6-3.0L	MITSUBISHI DIAMANTE
	1988	V6-3.0L	MITSUBISHI GALANT
	1990-1994	V6-3.0L	MITSUBISHI MIGHTY MAX
	1989-1994	V6-3.0L	MITSUBISHI MONTERO
	1989-1990	V6-3.0L	MITSUBISHI SIGMA
	1989-1995	V6-3.0L	PLYMOUTH ACCLAIM
	1988-2000	V6-3.0L	PLYMOUTH GRAND VOYAGER
	1992-1994	V6-3.0L	PLYMOUTH SUNDANCE
	1987-2000	V6-3.0L	PLYMOUTH VOYAGER
<b>US7122</b>	1989	L4-2.2L	CHRYSLER DART (MEX)
	1989	L4-2.2L	CHRYSLER LEBARON
	1989	L4-2.2L	CHRYSLER PHANTOM (MEX)
	1989	L4-2.2L	CHRYSLER SHADOW (MEX)
	1989	L4-2.2L	CHRYSLER TC MASERATI
	1989	L4-2.2L	DODGE ARIES
	1989	L4-2.2L	DODGE DART (MEX)
	1989	L4-2.2L	DODGE DAYTONA
	1989	L4-2.2L	DODGE LANCER
	1989	L4-2.2L	DODGE OMNI
	1989	L4-2.2L	DODGE SHADOW
	1989	L4-2.2L	DODGE SHADOW (MEX)
	1989	L4-2.2L	PLYMOUTH HORIZON
	1989	L4-2.2L	PLYMOUTH RELIANT
	1989	L4-2.2L	PLYMOUTH SUNDANCE
	1989	L4-2.5L	CHRYSLER LEBARON
	1989	L4-2.5L	CHRYSLER PHANTOM (MEX)
	1989	L4-2.5L	CHRYSLER SHADOW (MEX)
	1989	L4-2.5L	CHRYSLER SPIRIT (MEX)
	1989	L4-2.5L	DODGE ARIES
	1989	L4-2.5L	DODGE CARAVAN
	1989	L4-2.5L	DODGE DAKOTA
	1989	L4-2.5L	DODGE DAYTONA
	1989	L4-2.5L	DODGE DYNASTY
	1989	L4-2.5L	DODGE LANCER
	1989	L4-2.5L	DODGE SHADOW
	1989	L4-2.5L	DODGE SPIRIT
	1989	L4-2.5L	DODGE SPIRIT (MEX)
	1989	L4-2.5L	PLYMOUTH ACCLAIM

USMW	Years	Cyl.	Specifications
	1989	L4-2.5L	PLYMOUTH RELIANT
	1989	L4-2.5L	PLYMOUTH SUNDANCE
	1989	L4-2.5L	PLYMOUTH VOYAGER
<b>US7124</b>	1987-1989	L4-2.5L	CHRYSLER CONQUEST
	1987-1989	L4-2.6L	CHRYSLER STARION
<b>US7126</b>	2000	V6-3.3L	CHRYSLER GRAND VOYAGER
	1990-1991	V6-3.3L	CHRYSLER IMPERIAL
	1990-1993	V6-3.3L	CHRYSLER NEW YORKER
	1990-2000	V6-3.3L	CHRYSLER TOWN & COUNTRY
	2000	V6-3.3L	CHRYSLER VOYAGER
	1993-1999	V6-3.3L	CHRYSLER VOYAGER (MEX)
	1990-2000	V6-3.3L	DODGE CARAVAN
	1990-1993	V6-3.3L	DODGE DYNASTY
	1990-2000	V6-3.3L	DODGE GRAND CARAVAN
	1990-2000	V6-3.3L	PLYMOUTH GRAND VOYAGER
	1991-2000	V6-3.3L	PLYMOUTH VOYAGER
	1991-2001	V6-3.8L	CHRYSLER GRAND VOYAGER (MEX)
	1991-1993	V6-3.8L	CHRYSLER IMPERIAL
	1991-1993	V6-3.8L	CHRYSLER NEW YORKER
	1995-2000	V6-3.8L	CHRYSLER TOWN & COUNTRY
	1996-1999	V6-3.8L	DODGE CARAVAN
	1994-2000	V6-3.8L	DODGE GRAND CARAVAN
	1994-1999	V6-3.8L	PLYMOUTH GRAND VOYAGER
	1997	V6-3.8L	PLYMOUTH GRAND VOYAGER (MEX)
	1999	V6-3.8L	PLYMOUTH VOYAGER
<b>US7127</b>	1990	L4-2.2L	CHRYSLER LEBARON
	1990	L4-2.2L	CHRYSLER PHANTOM (MEX)
	1990-1991	L4-2.2L	CHRYSLER SHADOW (MEX)
	1990	L4-2.2L	DODGE DAYTONA
	1990	L4-2.2L	DODGE OMNI
	1990-1994	L4-2.2L	DODGE SHADOW
	1990	L4-2.2L	DODGE SHADOW (MEX)
	1993	L4-2.2L	DODGE SPIRIT (MEX)
	1990	L4-2.2L	PLYMOUTH HORIZON
	1990-1994	L4-2.2L	PLYMOUTH SUNDANCE
	1990-1993	L4-2.5L	CHRYSLER LEBARON
	1993-1995	L4-2.5L	CHRYSLER LEBARON (MEX)
	1990-1994	L4-2.5L	CHRYSLER PHANTOM (MEX)
	1990-1994	L4-2.5L	CHRYSLER SHADOW (MEX)
	1990-1995	L4-2.5L	CHRYSLER SPIRIT (MEX)
	1990-1995	L4-2.5L	CHRYSLER VOYAGER (MEX)
	1990-1995	L4-2.5L	DODGE CARAVAN
	1990-1995	L4-2.5L	DODGE DAKOTA
	1990-1993	L4-2.5L	DODGE DAYTONA
	1990-1993	L4-2.5L	DODGE DYNASTY
	1990-1994	L4-2.5L	DODGE SHADOW
	1990-1994	L4-2.5L	DODGE SHADOW (MEX)
	1990-1995	L4-2.5L	DODGE SPIRIT
	1990-1995	L4-2.5L	DODGE SPIRIT (MEX)
	1990-1995	L4-2.5L	PLYMOUTH ACCLAIM
	1990-1994	L4-2.5L	PLYMOUTH SUNDANCE
	1990-1995	L4-2.5L	PLYMOUTH VOYAGER
<b>US7128</b>	1990-1991	V8-5.2L	DODGE DAKOTA
<b>US7129</b>	1991-1996	V6-3.0L	DODGE STEALTH
	1991-1999	V6-3.0L	CHRYSLER 3000GT
	1992-1994	V6-3.0L	CHRYSLER DIAMANTE
<b>US7131</b>	1989-1990	L4-1.6L	DODGE COLT
	1989-1990	L4-1.6L	EAGLE SUMMIT
	1992-1995	L4-1.6L	HYUNDAI ELANTRA
	1989-1992	L4-1.6L	CHRYSLER MIRAGE
	1989-1990	L4-1.6L	PLYMOUTH COLT
<b>US7135</b>	1993-1994	L4-1.8L	DODGE COLT
	1992-1996	L4-1.8L	EAGLE SUMMIT
	1992-1994	L4-1.8L	CHRYSLER EXPO LRV
	1993-1996	L4-1.8L	CHRYSLER MIRAGE
	1992-1994	L4-1.8L	PLYMOUTH COLT
<b>US7136</b>	1996-2002	L4-2.5L	DODGE DAKOTA
	1991-2000	L4-2.5L	CHRYSLER CHEROKEE
	1991-1992	L4-2.5L	CHRYSLER COMANCHE

USMW	Years	Cyl.	Specifications
	1991-2002	L4-2.5L	CHRYSLER WRANGLER
	1993-1998	L6-4.0L	CHRYSLER GRAND CHEROKEE
	1991-1999	L6-4.0L	CHRYSLER WRANGLER
<b>US7139</b>	1991-1992	L4-2.2L	CHRYSLER SPIRIT
	1992-1993	V6-3.0L	CHRYSLER DAYTONA
<b>US7140</b>	1993-1996	V6-3.3L	CHRYSLER CONCORDE
	1992	V6-3.3L	CHRYSLER CONCORDE (MEX)
	1993-1997	V6-3.3L	DODGE INTREPID
	1993-1997	V6-3.3L	EAGLE VISION
<b>US7141</b>	1993-1994	V6-3.3L	EAGLE VISION
	1993-1994	V6-3.5L	CHRYSLER CONCORDE
	1992	V6-3.5L	CHRYSLER CONCORDE (MEX)
	1994	V6-3.5L	CHRYSLER LHS
	1994	V6-3.5L	CHRYSLER NEW YORKER
	1993-1994	V6-3.5L	DODGE INTREPID
<b>US7145</b>	1989-1993	L6-5.9L	DODGE D250
	1989-1993	L6-5.9L	DODGE D350
	1994-2009	L6-5.9L	DODGE RAM 2500
	1994-2009	L6-5.9L	DODGE RAM 3500
	1989-1993	L6-5.9L	DODGE W250
	1989-1993	L6-5.9L	DODGE W350
<b>US7145HN</b>	1989-1993	L6-5.9L	DODGE D250
	1989-1993	L6-5.9L	DODGE D350
	1994-2009	L6-5.9L	DODGE RAM 2500
	1994-2009	L6-5.9L	DODGE RAM 3500
	1989-1993	L6-5.9L	DODGE W250
	1989-1993	L6-5.9L	DODGE W350
<b>US7146</b>	1992-1996	V10-8.0L	DODGE VIPER
<b>US7148</b>	1995-1998	L4-2.0L	EAGLE TALON
	1995-1999	L4-2.0L	CHRYSLER ECLIPSE
	1993	L4-2.0L	CHRYSLER GALANT
	1993-1996	L4-2.4L	EAGLE SUMMIT
	1996-1999	L4-2.4L	CHRYSLER ECLIPSE
	1993-1995	L4-2.4L	CHRYSLER EXPO
	1993-1994	L4-2.4L	CHRYSLER EXPO LRV
	1994-1998	L4-2.4L	CHRYSLER GALANT
	1993-1994	L4-2.4L	PLYMOUTH COLT
<b>US7150</b>	2000	L4-2.0L	CHRYSLER CIRRRUS
	1995	L4-2.0L	CHRYSLER CIRRRUS (MEX)
	1995-1999	L4-2.0L	CHRYSLER SEBRING
	1995-1999	L4-2.0L	DODGE AVENGER
	1995-2005	L4-2.0L	DODGE NEON
	1995-2000	L4-2.0L	DODGE STRATUS
	1995-1998	L4-2.0L	EAGLE TALON
	1995-1999	L4-2.0L	CHRYSLER ECLIPSE
	1996-2000	L4-2.0L	PLYMOUTH BREEZE
	1995	L4-2.0L	PLYMOUTH BREEZE (MEX)
	1995-2001	L4-2.0L	PLYMOUTH NEON
<b>US7151</b>	1995-1997	V6-3.5L	CHRYSLER CONCORDE
	1995-1997	V6-3.5L	CHRYSLER LHS
	1995-1996	V6-3.5L	CHRYSLER NEW YORKER
	1995-1997	V6-3.5L	DODGE INTREPID
	1995-1997	V6-3.5L	EAGLE VISION
	1997	V6-3.5L	PLYMOUTH PROWLER
<b>US7152</b>	1998	L4-2.4L	CHRYSLER CIRRRUS (MEX)
	1995-2000	V6-2.5L	CHRYSLER CIRRRUS
	1995-2000	V6-2.5L	CHRYSLER SEBRING
	1995-2000	V6-2.5L	DODGE AVENGER
	1995-2000	V6-2.5L	DODGE STRATUS
	2001-2005	V6-3.0L	CHRYSLER SEBRING
	2001-2005	V6-3.0L	DODGE STRATUS
	2000-2005	V6-3.0L	CHRYSLER ECLIPSE
	1999-2003	V6-3.0L	CHRYSLER GALANT
	1997-2004	V6-3.5L	CHRYSLER DIAMANTE
	2005-2009	V6-3.5L	CHRYSLER MONTERO (MEX)
	2006-2012	V6-3.8L	CHRYSLER ECLIPSE
	2004-2011	V6-3.8L	CHRYSLER ENDEAVOR
	2010-2011	V6-3.8L	CHRYSLER ENDEAVOR (MEX)
	2004-2009	V6-3.8L	CHRYSLER GALANT

USMW	Years	Cyl.	Specifications
	2008-2011	V6-3.8L	<b>MINI</b> MONTERO (MEX)
<b>US7153</b>	1995-1996	L4-2.4L	<b>CHRYSLER</b> CIRRUS
	1996	L4-2.4L	<b>CHRYSLER</b> SEBRING
	1996	L4-2.4L	<b>DODGE</b> CARAVAN
	1996	L4-2.4L	<b>DODGE</b> GRAND CARAVAN
	1995-1996	L4-2.4L	<b>DODGE</b> STRATUS
	1996	L4-2.4L	<b>PLYMOUTH</b> GRAND VOYAGER
	1996	L4-2.4L	<b>PLYMOUTH</b> VOYAGER
<b>US7156</b>	2001-2006	L4-2.0L	<b>DODGE</b> STRATUS (MEX)
	1996-2000	L4-2.4L	<b>CHRYSLER</b> CIRRUS
	1999-2009	L4-2.4L	<b>CHRYSLER</b> CIRRUS (MEX)
	2001-2010	L4-2.4L	<b>CHRYSLER</b> PT CRUISER
	1996-2006	L4-2.4L	<b>CHRYSLER</b> SEBRING
	1996-1997	L4-2.4L	<b>CHRYSLER</b> STRATUS (MEX)
	2000-2003	L4-2.4L	<b>CHRYSLER</b> VOYAGER
	1996-1997	L4-2.4L	<b>CHRYSLER</b> VOYAGER (MEX)
	1996-2007	L4-2.4L	<b>DODGE</b> CARAVAN
	1996-1997	L4-2.4L	<b>DODGE</b> GRAND CARAVAN
	1996-2006	L4-2.4L	<b>DODGE</b> STRATUS
	1998-2006	L4-2.4L	<b>DODGE</b> STRATUS (MEX)
	2002-2005	L4-2.4L	<b>JEEP</b> LIBERTY
	2003-2006	L4-2.4L	<b>JEEP</b> WRANGLER
	1997-2000	L4-2.4L	<b>PLYMOUTH</b> BREEZE
	1996-1997	L4-2.4L	<b>PLYMOUTH</b> GRAND VOYAGER
1996-2000	L4-2.4L	<b>PLYMOUTH</b> VOYAGER	
<b>US7158</b>	1997	V6-3.5L	<b>CHRYSLER</b> CONCORDE
	1997	V6-3.5L	<b>CHRYSLER</b> LHS
	1997	V6-3.5L	<b>DODGE</b> INTREPID
	1997	V6-3.5L	<b>EAGLE</b> VISION
	1997	V6-3.5L	<b>PLYMOUTH</b> PROWLER
<b>US7159</b>	1992	V6-3.9L	<b>DODGE</b> B150
	1992	V6-3.9L	<b>DODGE</b> B250
	1992	V6-3.9L	<b>DODGE</b> D150
	1992	V6-3.9L	<b>DODGE</b> DAKOTA
	1992	V8-5.2L	<b>DODGE</b> B150
	1992	V8-5.2L	<b>DODGE</b> B250
	1992	V8-5.2L	<b>DODGE</b> B350
	1992	V8-5.2L	<b>DODGE</b> D150
	1992	V8-5.2L	<b>DODGE</b> RAMCHARGER
	1992	V8-5.9L	<b>DODGE</b> MICROBUS (MEX)
<b>US7160</b>	1993-1994	V6-3.9L	<b>DODGE</b> B150
	1995-1998	V6-3.9L	<b>DODGE</b> B1500
	1993-1994	V6-3.9L	<b>DODGE</b> B250
	1995-1997	V6-3.9L	<b>DODGE</b> B2500
	1993	V6-3.9L	<b>DODGE</b> D150
	1992-1993	V6-3.9L	<b>DODGE</b> D250
	1993-2003	V6-3.9L	<b>DODGE</b> DAKOTA
	1998-1999	V6-3.9L	<b>DODGE</b> DURANGO
	1994-2001	V6-3.9L	<b>DODGE</b> RAM 1500
	1999-2003	V6-3.9L	<b>DODGE</b> RAM 1500 VAN
	2001	V6-3.9L	<b>DODGE</b> RAM 2500 VAN
	1992-1993	V6-3.9L	<b>DODGE</b> W150
	1993-1994	V8-5.2L	<b>DODGE</b> B150
	1995-1998	V8-5.2L	<b>DODGE</b> B1500
	1993-1994	V8-5.2L	<b>DODGE</b> B250
	1995-1998	V8-5.2L	<b>DODGE</b> B2500
	1993-1994	V8-5.2L	<b>DODGE</b> B350
	1995-1998	V8-5.2L	<b>DODGE</b> B3500
	1993	V8-5.2L	<b>DODGE</b> D150
	1992-1993	V8-5.2L	<b>DODGE</b> D250
	1993-1999	V8-5.2L	<b>DODGE</b> DAKOTA
	1998-2000	V8-5.2L	<b>DODGE</b> DURANGO
	1994-2001	V8-5.2L	<b>DODGE</b> RAM 1500
	1999-2003	V8-5.2L	<b>DODGE</b> RAM 1500 VAN
	1994-1996	V8-5.2L	<b>DODGE</b> RAM 2500
	1998-2001	V8-5.2L	<b>DODGE</b> RAM 2500 (MEX)
	1999-2003	V8-5.2L	<b>DODGE</b> RAM 2500 VAN
	1994	V8-5.2L	<b>DODGE</b> RAM 3500 (MEX)
	1999-2003	V8-5.2L	<b>DODGE</b> RAM 3500 VAN

USMW	Years	Cyl.	Specifications	
	1992-1993	V8-5.2L	<b>DODGE</b> RAMCHARGER	
	1999-2001	V8-5.2L	<b>DODGE</b> RAMCHARGER (MEX)	
	1992-1993	V8-5.2L	<b>DODGE</b> W150	
	1992-1993	V8-5.2L	<b>DODGE</b> W250	
	1993-1998	V8-5.2L	<b>JEEP</b> GRAND CHEROKEE	
	1992	V8-5.2L	<b>JEEP</b> GRAND CHEROKEE 4WD (MEX)	
	1993	V8-5.2L	<b>JEEP</b> GRAND WAGONEER	
	1998	V8-5.9L	<b>DODGE</b> B1500	
	1993-1994	V8-5.9L	<b>DODGE</b> B250	
	1995-1998	V8-5.9L	<b>DODGE</b> B2500	
	1993-1994	V8-5.9L	<b>DODGE</b> B350	
	1995-1998	V8-5.9L	<b>DODGE</b> B3500	
	1993	V8-5.9L	<b>DODGE</b> D150	
	1993	V8-5.9L	<b>DODGE</b> D250	
	1993	V8-5.9L	<b>DODGE</b> D350	
	1998-2003	V8-5.9L	<b>DODGE</b> DAKOTA	
	1998-2003	V8-5.9L	<b>DODGE</b> DURANGO	
	1993-1997	V8-5.9L	<b>DODGE</b> MICROBUS (MEX)	
	1994-2003	V8-5.9L	<b>DODGE</b> RAM 1500	
	1999-2003	V8-5.9L	<b>DODGE</b> RAM 1500 VAN	
	1994-2002	V8-5.9L	<b>DODGE</b> RAM 2500	
	1999-2003	V8-5.9L	<b>DODGE</b> RAM 2500 VAN	
	1994-2002	V8-5.9L	<b>DODGE</b> RAM 3500	
	1999-2003	V8-5.9L	<b>DODGE</b> RAM 3500 VAN	
	1993	V8-5.9L	<b>DODGE</b> RAMCHARGER	
	1994-2000	V8-5.9L	<b>DODGE</b> RAMCHARGER (MEX)	
	1993	V8-5.9L	<b>DODGE</b> W150	
	1993	V8-5.9L	<b>DODGE</b> W250	
	1993	V8-5.9L	<b>DODGE</b> W350	
	1998	V8-5.9L	<b>JEEP</b> GRAND CHEROKEE	
<b>US7161</b>	2005-2007	V6-2.7L	<b>CHRYSLER</b> 300	
	2001-2006	V6-2.7L	<b>CHRYSLER</b> CIRRUS (MEX)	
	1998-2004	V6-2.7L	<b>CHRYSLER</b> CONCORDE	
	2001-2007	V6-2.7L	<b>CHRYSLER</b> SEBRING	
	2006-2007	V6-2.7L	<b>DODGE</b> CHARGER	
	1998-2004	V6-2.7L	<b>DODGE</b> INTREPID	
	2005-2007	V6-2.7L	<b>DODGE</b> MAGNUM	
	2001-2006	V6-2.7L	<b>DODGE</b> STRATUS	
	<b>US7162</b>	1998-2001	V6-3.2L	<b>CHRYSLER</b> CONCORDE
		1998-2001	V6-3.2L	<b>DODGE</b> INTREPID
1999-2004		V6-3.5L	<b>CHRYSLER</b> 300M	
2002-2004		V6-3.5L	<b>CHRYSLER</b> CONCORDE	
1999-2001		V6-3.5L	<b>CHRYSLER</b> LHS	
2004		V6-3.5L	<b>CHRYSLER</b> PACIFICA	
2001-2002		V6-3.5L	<b>CHRYSLER</b> PROWLER	
2000-2004		V6-3.5L	<b>DODGE</b> INTREPID	
1999-2001		V6-3.5L	<b>PLYMOUTH</b> PROWLER	
<b>US7163</b>		2004-2010	V6-3.7L	<b>DODGE</b> DAKOTA
	2010-2011	V6-3.7L	<b>DODGE</b> DAKOTA (MEX)	
	2004-2009	V6-3.7L	<b>DODGE</b> DURANGO	
	2007-2011	V6-3.7L	<b>DODGE</b> NITRO	
	2002-2010	V6-3.7L	<b>DODGE</b> RAM 1500	
	2006-2010	V6-3.7L	<b>JEEP</b> COMMANDER	
	2005-2010	V6-3.7L	<b>JEEP</b> GRAND CHEROKEE	
	2002-2012	V6-3.7L	<b>JEEP</b> LIBERTY	
	2006-2009	V6-3.7L	<b>MINI</b> RAIDER	
	2011-2012	V6-3.7L	<b>RAM</b> 1500	
	2011	V6-3.7L	<b>RAM</b> DAKOTA	
	2007-2009	V8-4.7L	<b>CHRYSLER</b> ASPEN	
	2000-2010	V8-4.7L	<b>DODGE</b> DAKOTA	
	2000-2009	V8-4.7L	<b>DODGE</b> DURANGO	
	2010	V8-4.7L	<b>DODGE</b> RAM (MEX)	
	2002-2010	V8-4.7L	<b>DODGE</b> RAM 1500	
	2003-2009	V8-4.7L	<b>DODGE</b> RAM 2500 (MEX)	
	2006-2009	V8-4.7L	<b>JEEP</b> COMMANDER	
	1999-2009	V8-4.7L	<b>JEEP</b> GRAND CHEROKEE	
	2008	V8-4.7L	<b>JEEP</b> GRAND CHEROKEE (MEX)	
2006-2007	V8-4.7L	<b>MINI</b> RAIDER		
2011-2012	V8-4.7L	<b>RAM</b> 1500		



USMW	Years	Cyl.	Specifications
	2011	V8-4.7L	<b>RAM DAKOTA</b>
<b>US7164</b>	1999-2004	L6-4.0L	<b>JEEP GRAND CHEROKEE</b>
	2000-2006	L6-4.0L	<b>JEEP TJ</b>
	2000-2006	L6-4.0L	<b>JEEP WRANGLER</b>
<b>US7165</b>	2001	V6-3.3L	<b>CHRYSLER GRAND VOYAGER (MEX)</b>
	2001-2007	V6-3.3L	<b>CHRYSLER TOWN &amp; COUNTRY</b>
	2001-2003	V6-3.3L	<b>CHRYSLER VOYAGER</b>
	2001-2008	V6-3.3L	<b>CHRYSLER VOYAGER (MEX)</b>
	2001-2007	V6-3.3L	<b>DODGE CARAVAN</b>
	2001-2007	V6-3.3L	<b>DODGE GRAND CARAVAN</b>
	2002	V6-3.8L	<b>CHRYSLER GRAND VOYAGER (MEX)</b>
	2001-2007	V6-3.8L	<b>CHRYSLER TOWN &amp; COUNTRY</b>
	2001-2007	V6-3.8L	<b>DODGE GRAND CARAVAN</b>
<b>US7166</b>	2004-2006	V10-8.3L	<b>DODGE RAM 1500</b>
	2003-2006	V10-8.3L	<b>DODGE VIPER</b>
<b>US7167</b>	2003-2009	L4-2.4L	<b>CHRYSLER PT CRUISER</b>
	2003-2005	L4-2.4L	<b>DODGE NEON</b>
<b>US7168</b>	2007-2008	V8-5.7L	<b>CHRYSLER ASPEN</b>
	2004-2008	V8-5.7L	<b>DODGE DURANGO</b>
	2003-2008	V8-5.7L	<b>DODGE RAM 1500</b>
	2003-2008	V8-5.7L	<b>DODGE RAM 2500</b>
	2003-2008	V8-5.7L	<b>DODGE RAM 3500</b>
<b>US7169</b>	1994-2003	V10-8.0L	<b>DODGE RAM 2500</b>
	1994-2003	V10-8.0L	<b>DODGE RAM 3500</b>
<b>US8901</b>	1983-1990	L4-2.5L	<b>ISUZU CAMPO</b>
	1991-1994	L4-2.5L	<b>ISUZU MONTEREY II</b>
	1995-1998	L4-2.8L	<b>ISUZU FRONTERA</b>
	1987-1991	L4-2.8L	<b>ISUZU TROOPER</b>
	1992-1999	L4-3.1L	<b>ISUZU MONTEREY II</b>
<b>US8902</b>	1993-1999	L4-2.8L	<b>MISUBISHI PAJERO</b>
<b>US8903</b>	1984-1989	L4-1.6L	<b>SUBARU LEONE</b>
<b>US8904</b>	1987-1996	L4-2.4L	<b>TOYOTA 4RUNNER</b>
	1995-2004	L4-2.4L	<b>TOYOTA HIACE</b>
	1988-2001	L4-2.4L	<b>TOYOTA HILUX</b>
	1990-1993	L4-2.4L	<b>TOYOTA LAND CRUISER</b>
	1989-1997	L4-2.4L	<b>VOLKSWAGEN TARO</b>
<b>US8905</b>	1991-1993	L4-1.4L	<b>FORD ESCORT</b>
	1989-1994	L4-1.4L	<b>FORD FIESTA</b>
	1991-1993	L4-1.4L	<b>FORD ORION</b>
	1991-1993	L4-1.6L	<b>FORD ESCORT</b>
	1989-1994	L4-1.6L	<b>FORD FIESTA</b>
	1991-1993	L4-1.6L	<b>FORD ORION</b>
<b>US8908</b>	1990-1992	L4-1.6L	<b>DAIHATSU ROCKY</b>
<b>US8914</b>	1986	L4-1.4L	<b>RENAULT ENCORE (MEX)</b>
	1984-1986	L4-1.7L	<b>AMERICAN MOTORS ALLIANCE (MEX)</b>
	1985-1986	L4-1.7L	<b>AMERICAN MOTORS ENCORE (MEX)</b>
	1985-1987	L4-1.7L	<b>RENAULT ALLIANCE</b>
	1985-1986	L4-1.7L	<b>RENAULT ENCORE</b>
	2001-2006	L4-2.0L	<b>RENAULT CLIO (MEX)</b>
	2001-2006	L4-2.0L	<b>RENAULT CLIO SPORT (MEX)</b>
	2001-2004	L4-2.0L	<b>RENAULT MEGANE (MEX)</b>
	2004-2009	L4-2.0L	<b>RENAULT MEGANE II (MEX)</b>
	1984-1986	L4-2.0L	<b>RENAULT R18 (MEX)</b>
	2002-2004	L4-2.0L	<b>RENAULT SCENIC (MEX)</b>
	2005-2008	L4-2.0L	<b>RENAULT SCENIC II (MEX)</b>
<b>US8917</b>	1999-2002	L4-1.6L	<b>DAEWOO LANOS</b>
<b>US8922</b>	2006-2010	L4-2.5L	<b>DODGE H100 (MEX)</b>
	1997-2007	L4-2.5L	<b>HYUNDAI H100</b>
	1997-2007	L4-2.5L	<b>HYUNDAI H200</b>
	1992-1996	L4-2.5L	<b>MISUBISHI L200</b>
	2001-2006	L4-2.5L	<b>MISUBISHI MONTERO</b>
<b>US8923</b>	1996-2006	L4-2.5L	<b>MAZDA SERIE B</b>
<b>US8925</b>	2009	L4-1.8L	<b>NISSAN TIIDA (MEX)</b>
	2004-2008	L4-2.0L	<b>CHEVROLET ASTRA (MEX)</b>
	2006-2009	L4-2.0L	<b>CHEVROLET OPTRA (MEX)</b>
	1999-2002	L4-2.0L	<b>DAEWOO NUBIRA</b>
	2004-2008	L4-2.0L	<b>SUZUKI FORENZA</b>
	2005-2008	L4-2.0L	<b>SUZUKI RENO</b>
	2001-2003	L4-2.2L	<b>CHEVROLET ASTRA (MEX)</b>

USMW	Years	Cyl.	Specifications
	2000-2006	L4-2.2L	<b>CHEVROLET LUV (MEX)</b>
	1999-2002	L4-2.2L	<b>DAEWOO LEGANZA</b>
	2004-2006	L4-2.4L	<b>CHEVROLET ASTRA (MEX)</b>
	2008-2009	L4-2.4L	<b>CHEVROLET CAPTIVA SPORT (MEX)</b>
	2010	L4-3.5L	<b>NISSAN MAXIMA SPORT (MEX)</b>
	2010	L4-3.5L	<b>NISSAN MAXIMA TRACKING (MEX)</b>
<b>US8926</b>	1994-1995	V8-4.0L	<b>BMW 840CI</b>
	1997-1998	V8-4.4L	<b>BMW 540I</b>
	1997-1998	V8-4.4L	<b>BMW 740I</b>
	1996-1998	V8-4.4L	<b>BMW 740IL</b>
	1996-1997	V8-4.4L	<b>BMW 840CI</b>
<b>US8927</b>	2008-2010	L4-1.6L	<b>NISSAN APRIO (MEX)</b>
	2002-2010	L4-1.6L	<b>NISSAN PLATINA (MEX)</b>
	2001-2009	L4-1.6L	<b>RENAULT CLIO (MEX)</b>
	2004-2009	L4-1.6L	<b>RENAULT KANGOO (MEX)</b>
<b>US8928</b>	2004-2008	L4-1.0L	<b>PONTIAC MATIZ</b>
	2004-2009	L4-1.0L	<b>PONTIAC MATIZ (MEX)</b>
<b>US8929</b>	1990-1991	L4-1.0L	<b>SUZUKI CARRY</b>
<b>US8930</b>	1993-1998	L4-2.7L	<b>FORD MAVERICK</b>
	1993-2002	L4-2.7L	<b>NISSAN TERRANO</b>
<b>US8931</b>	2001-2009	L4-1.6L	<b>FORD COURIER (MEX)</b>
	2001-2009	L4-1.6L	<b>FORD FIESTA (MEX)</b>
	2002-2007	L4-1.6L	<b>FORD FIESTA IKON (MEX)</b>
	2001-2008	L4-1.6L	<b>FORD KA (MEX)</b>
<b>US8932</b>	2010-2011	V6-2.8L	<b>CADILLAC SRX</b>
	2007-2008	V6-2.8L	<b>CHEVROLET VECTRA (MEX)</b>
	2006-2009	V6-2.8L	<b>SAAB 41885</b>
	2010-2011	V6-2.8L	<b>SAAB 41887</b>
	2010-2011	V6-3.0L	<b>CADILLAC CTS</b>
	2010-2011	V6-3.0L	<b>CADILLAC SRX</b>
	2010-2011	V6-3.0L	<b>CHEVROLET EQUINOX</b>
	2010-2011	V6-3.0L	<b>GMC TERRAIN</b>
	2009-2010	V6-3.2L	<b>SUZUKI GRAND VITARA</b>
	2008-2011	V6-3.6L	<b>BUICK ENCLAVE</b>
	2005-2011	V6-3.6L	<b>BUICK LACROSSE</b>
	2004-2006	V6-3.6L	<b>BUICK RENDEZVOUS</b>
	2004-2011	V6-3.6L	<b>CADILLAC CTS</b>
	2004-2009	V6-3.6L	<b>CADILLAC SRX</b>
	2005-2011	V6-3.6L	<b>CADILLAC STS</b>
	2010-2011	V6-3.6L	<b>CHEVROLET CAMARO</b>
	2008-2009	V6-3.6L	<b>CHEVROLET EQUINOX</b>
	2008-2011	V6-3.6L	<b>CHEVROLET MALIBU</b>
	2009-2011	V6-3.6L	<b>CHEVROLET TRAVERSE</b>
	2007-2011	V6-3.6L	<b>GMC ACADIA</b>
	2010	V6-3.6L	<b>GMC ACADIA (MEX)</b>
	2010	V6-3.6L	<b>GMC ACADIA AWD (MEX)</b>
	2007-2009	V6-3.6L	<b>PONTIAC G6</b>
	2008-2009	V6-3.6L	<b>PONTIAC G8</b>
	2008-2009	V6-3.6L	<b>PONTIAC TORRENT</b>
	2007-2009	V6-3.6L	<b>SATURN AURA</b>
	2007-2010	V6-3.6L	<b>SATURN OUTLOOK</b>
	2008-2010	V6-3.6L	<b>SATURN VUE</b>
	2007-2009	V6-3.6L	<b>SUZUKI XL-7</b>
	2006	V8-2.8L	<b>CHEVROLET VECTRA (MEX)</b>
<b>US8933</b>	2000-2008	L4-1.8L	<b>CHEVROLET ASTRA</b>
	2000-2008	L4-1.8L	<b>CHEVROLET ASTRA (MEX)</b>
	2001-2006	L4-1.8L	<b>CHEVROLET ZAFIRA (MEX)</b>
<b>US8934</b>	1998-2000	L4-1.3L	<b>FORD FIESTA</b>
	1998-2001	L4-1.3L	<b>FORD FIESTA (MEX)</b>
<b>US8935</b>	2001-2004	L4-1.0L	<b>DODGE ATOS (MEX)</b>
	1998-2007	L4-1.0L	<b>HYUNDAI ATOS</b>
	2005-2009	L4-1.1L	<b>DODGE ATOS</b>
	2005-2012	L4-1.1L	<b>DODGE ATOS (MEX)</b>
<b>US8936</b>	1986-1996	L4-1.0L	<b>CITROEN AX</b>
	1996-2003	L4-1.0L	<b>CITROEN SAXO</b>
	1996-2004	L4-1.0L	<b>PEUGEOT 106</b>
	1986-1989	L4-1.1L	<b>CITROEN AX</b>
	1986-1989	L4-1.1L	<b>CITROEN BX</b>
	1996-2003	L4-1.1L	<b>CITROEN SAXO</b>

**WATER PUMPS**

USMW	Years	Cyl.	Specifications
	1991-1997	L4-1.1L	CITROEN ZX
	1992-2004	L4-1.1L	PEUGEOT 106
	1987-1999	L4-1.1L	PEUGEOT 205
	1987-1996	L4-1.3L	CITROEN AX
	1993-1995	L4-1.3L	PEUGEOT 106
	1987-1996	L4-1.4L	CITROEN AX
	1989-1993	L4-1.4L	CITROEN BX
	1996-2003	L4-1.4L	CITROEN SAXO
	1997-2004	L4-1.4L	CITROEN XSARA
	1991-1997	L4-1.4L	CITROEN ZX
	1992-2004	L4-1.4L	PEUGEOT 106
	1987-1999	L4-1.4L	PEUGEOT 205
	2000-2008	L4-1.4L	PEUGEOT 206
	2000-2009	L4-1.4L	PEUGEOT 206 (MEX)
<b>US8937</b>	2002-2008	L4-1.6L	PEUGEOT 206
	2001-2009	L4-1.6L	PEUGEOT 206 (MEX)
	2008-2009	L4-1.6L	PEUGEOT 207 (MEX)
	2007-2009	L4-1.6L	PEUGEOT GRAND RAID (MEX)
	2005-2008	L4-1.6L	PEUGEOT PARTNER
	2004-2009	L4-1.6L	PEUGEOT PARTNER (MEX)
<b>US8938</b>	2003-2008	L4-1.8L	CHEVROLET CORSA (MEX)
	2003-2008	L4-1.8L	CHEVROLET MERIVA (MEX)
	2004-2009	L4-1.8L	CHEVROLET TORNADO (MEX)
	2008-2009	L4-1.8L	FIAT IDEA ADVENTURE (MEX)
	2005-2009	L4-1.8L	FIAT PALIO (MEX)
	2007-2009	L4-1.8L	FIAT STRADA (MEX)
<b>US8940</b>	2005-2008	V8-5.7L	CHRYSLER 300
	2006-2008	V8-5.7L	DODGE CHARGER
	2005-2008	V8-5.7L	DODGE MAGNUM
	2006-2008	V8-5.7L	JEEP COMMANDER
	2005-2008	V8-5.7L	JEEP GRAND CHEROKEE
	2005-2010	V8-6.1L	CHRYSLER 300
	2008-2010	V8-6.1L	DODGE CHALLENGER
	2006-2010	V8-6.1L	DODGE CHARGER
	2006-2008	V8-6.1L	DODGE MAGNUM
	2006-2010	V8-6.1L	JEEP GRAND CHEROKEE
<b>US8941</b>	1988-1997	L6-4.2L	NISSAN PATROL
<b>US8942</b>	1996-2002	L4-1.6L	OPEL VECTRA '96
	1993-1998	L4-1.8L	OPEL ASTRA
	1992-1995	L4-1.8L	OPEL VECTRA
	1993-1998	L4-2.0L	OPEL ASTRA
	1993-1997	L4-2.0L	OPEL CALIBRA
	1993-1997	L4-2.0L	OPEL FRONTERA
	1990-1995	L4-2.0L	OPEL OMEGA
	1992-1995	L4-2.0L	OPEL VECTRA
	1996-2002	L4-2.0L	OPEL VECTRA '96
<b>US8943</b>	2003-2010	L4-1.1L	CHERY QQ
<b>US8944</b>	1977-1987	L4-1.0L	FIAT 127
	1980-1983	L4-1.0L	FIAT 147
	1985-1989	L4-1.0L	FIAT FIORINO
	1979-1983	L4-1.0L	FIAT STRADA
	1989-1994	L4-1.0L	FIAT UNO
	1987-1990	L4-1.1L	FIAT DUNA
	1990-1992	L4-1.1L	FIAT FIORINO'90
	1989-1994	L4-1.1L	FIAT UNO
	1980-1987	L4-1.3L	FIAT 127
	1987-1990	L4-1.3L	FIAT DUNA
	1983-1989	L4-1.3L	FIAT FIORINO
	1989-1992	L4-1.3L	FIAT FIORINO'90
	1993-2000	L4-1.3L	FIAT FIORINO'93
	1986-1994	L4-1.3L	FIAT PANDA
	1983-1994	L4-1.3L	FIAT UNO
	1979	L4-1.5L	FIAT STRADA
<b>US8945</b>	2007-2008	L4-1.2L	FIAT PANDA
	2007-2012	L4-1.2L	FIAT PANDA (MEX)
<b>US8946</b>	2007-2008	L4-1.4L	FIAT GRANDE PUNTO
	2007-2009	L4-1.4L	FIAT GRANDE PUNTO (MEX)
<b>US8948</b>	1995-2001	L4-1.6L	FIAT BRAVO
	1998-2001	L4-1.6L	FIAT PALIO

USMW	Years	Cyl.	Specifications
	2004-2005	L4-1.6L	FIAT PALIO (MEX)
	2001-2007	L4-1.6L	FIAT STILO
<b>US8949</b>	2008-2009	L4-1.4L	SEAT LEON (MEX)
	2001-2009	L4-1.6L	SEAT IBIZA (MEX)
	2007-2009	L4-1.6L	VOLKSWAGEN CROSSFOX (MEX)
	2009-2011	L4-1.6L	VOLKSWAGEN GOL (MEX)
	2005-2009	L4-1.6L	VOLKSWAGEN LUPO (MEX)
	2003-2007	L4-1.6L	VOLKSWAGEN POLO (MEX)
	2007-2009	L4-1.6L	VOLKSWAGEN SPORTVAN (MEX)
	2005-2008	L4-1.8L	SEAT IBIZA (MEX)
	2010	L4-2.0L	SEAT IBIZA (MEX)
	2003-2009	L4-2.0L	SEAT IBIZA (MEX)
<b>US8950</b>	1990-2002	L6-4.2L	TOYOTA LAND CRUISER
<b>US8951</b>	2005-2010	V6-3.5L	CHRYSLER 300
	2007-2009	V6-3.5L	CHRYSLER CIRRUS (MEX)
	2005-2006	V6-3.5L	CHRYSLER PACIFICA
	2007-2010	V6-3.5L	CHRYSLER SEBRING
	2008-2010	V6-3.5L	DODGE AVENGER
	2009-2010	V6-3.5L	DODGE CHALLENGER
	2006-2010	V6-3.5L	DODGE CHARGER
	2009-2010	V6-3.5L	DODGE JOURNEY
	2005-2008	V6-3.5L	DODGE MAGNUM
	2007-2008	V6-4.0L	CHRYSLER PACIFICA
	2008-2010	V6-4.0L	CHRYSLER TOWN & COUNTRY
	2008-2010	V6-4.0L	DODGE GRAND CARAVAN
	2007-2011	V6-4.0L	DODGE NITRO
<b>US8955</b>	2006-2009	V8-4.4L	CADILLAC STS
	2006-2009	V8-4.4L	CADILLAC XLR
	2004-2009	V8-4.6L	CADILLAC SRX
	2005-2010	V8-4.6L	CADILLAC STS
	2004-2009	V8-4.6L	CADILLAC XLR
<b>US8956</b>	2006-2011	V8-4.6L	BUICK LUCERNE
	2006-2011	V8-4.6L	CADILLAC DTS
<b>US8958</b>	1994-1997	L4-1.7L	NISSAN FAMILIA
	1993-1997	L4-1.7L	NISSAN PULSER
	1993-1997	L4-1.7L	NISSAN SUNNY
<b>US8959</b>	1996-2012	L4-1.6L	AUDI A3
	1999-2005	L4-1.6L	VOLKSWAGEN BORA
	1997-2008	L4-1.6L	VOLKSWAGEN GOLF
	1999-2005	L4-1.6L	VOLKSWAGEN JETTA
	2004-2010	L4-1.6L	VOLKSWAGEN PASSAT
	2001-2007	L4-2.0L	AUDI A4
<b>US8960</b>	2007-2011	V6-3.8L	JEEP WRANGLER
	2010	V6-3.8L	JEEP WRANGLER (MEX)
<b>US8962</b>	1994-2004	L4-1.4L	GENERAL MOTORS ASTRA
	1995-2006	L4-1.4L	GENERAL MOTORS CORSA
	1994-2004	L4-1.6L	GENERAL MOTORS ASTRA
	1993-2000	L4-1.6L	GENERAL MOTORS CORSA
<b>US8963</b>	2011-2013	V8-5.0L	FORD F-150
	2011-2013	V8-5.0L	FORD MUSTANG
<b>US8965</b>	1996-2001	L4-3.9L	MITSUBISHI CANTOR
<b>US8967</b>	2006-2007	L4-1.4L	NISSAN MICRA
<b>US8968</b>	2005-2008	V6-3.8L	CHRYSLER PACIFICA
<b>US8970</b>	2008-2012	L4-2.4L	SCION XB
<b>US8971</b>	2011-2013	V8-5.7L	CHRYSLER 300
	2011-2013	V8-5.7L	DODGE CHALLENGER
	2011-2013	V8-5.7L	DODGE CHARGER
	2011-2012	V8-5.7L	DODGE DURANGO
	2011-2012	V8-5.7L	JEEP GRAND CHEROKEE
	2012-2013	V8-6.4L	CHRYSLER 300
	2011-2013	V8-6.4L	DODGE CHALLENGER
	2012-2013	V8-6.4L	DODGE CHARGER
	2012-2013	V8-6.4L	JEEP GRAND CHEROKEE
<b>US8979</b>	2009-2010	V8-5.7L	CHRYSLER 300
	2009-2010	V8-5.7L	DODGE CHALLENGER
	2009-2010	V8-5.7L	DODGE CHARGER
	2009-2010	V8-5.7L	JEEP COMMANDER
	2009-2010	V8-5.7L	JEEP GRAND CHEROKEE
<b>US8980</b>	2011-2012	V6-3.5L	FORD EDGE

USMW	Years	Cyl.	Specifications
	2011-2012	V6-3.5L	FORD EXPLORER
	2011-2012	V6-3.5L	FORD FLEX
	2012	V6-3.5L	FORD FUSION
	2011-2012	V6-3.5L	FORD TAURUS
	2012	V6-3.5L	LINCOLN MKX
	2012	V6-3.5L	LINCOLN MKZ
	2011-2012	V6-3.7L	FORD EDGE
	2011-2012	V6-3.7L	LINCOLN MKS
	2011-2012	V6-3.7L	LINCOLN MKT
	2011	V6-3.7L	LINCOLN MKX
<b>US8981</b>	2011-2014	V6-3.6L	CHRYSLER 200
	2011-2014	V6-3.6L	CHRYSLER 300
	2011-2014	V6-3.6L	CHRYSLER TOWN & COUNTRY
	2011-2013	V6-3.6L	DODGE AVENGER
	2011-2014	V6-3.6L	DODGE CHALLENGER
	2011-2014	V6-3.6L	DODGE CHARGER
	2011-2014	V6-3.6L	DODGE DURANGO
	2011-2014	V6-3.6L	DODGE GRAND CARAVAN
	2011-2014	V6-3.6L	DODGE JOURNEY
	2011-2014	V6-3.6L	JEEP GRAND CHEROKEE
	2012	V6-3.6L	RAM C/V
	2011-2012	V6-3.6L	VOLKSWAGEN ROUTAN
<b>US8982</b>	2011-2013	L4-2.0L	HYUNDAI SONATA
	2011-2013	L4-2.0L	KIA OPTIMA
	2011-2012	L4-2.0L	KIA SPORTAGE
	2011-2013	L4-2.4L	HYUNDAI SONATA
	2011-2014	L4-2.4L	KIA OPTIMA
	2012-2013	L4-2.4L	KIA SORENTO
	2011-2013	L4-2.4L	KIA SPORTAGE
<b>US8983</b>	2010-2013	L4-1.3L	HONDA INSIGHT
	2011-2013	L4-1.5L	HONDA CR-Z
<b>US9003</b>	1974-1978	L4-1.6L	FIAT 124
	1974-1978	L4-1.8L	FIAT 124
	1975-1978	L4-1.8L	FIAT 131
	1979-1982	L4-2.0L	FIAT 124
	1979-1981	L4-2.0L	FIAT BRAVA
<b>US9005</b>	1975	L4-2.2L	TOYOTA CORONA
	1975	L4-2.2L	TOYOTA PICKUP
<b>US9008</b>	1978-1981	L4-2.0L	NISSAN 510
	1975-1976	L4-2.0L	NISSAN 610
	1975-1979	L4-2.0L	NISSAN 620
	1975-1977	L4-2.0L	NISSAN 710
	1980	L4-2.0L	NISSAN 720
<b>US9009</b>	1965-1984	L4-1.6L	NISSAN NISSAN SEDAN (MEX)
	1970-1983	L4-1.6L	NISSAN PICKUP (MEX)
	1965-1984	L4-1.6L	NISSAN STATION WAGON (MEX)
	1980	L4-2.0L	NISSAN 720
	1981-1983	L4-2.2L	NISSAN 720
<b>US9010</b>	1980	L4-1.4L	NISSAN 310
	1975-1978	L4-1.4L	NISSAN B210
	1981	L4-1.5L	NISSAN 310
<b>US9011</b>	1977-1981	L6-2.4L	NISSAN 810
	1982-1984	L6-2.4L	NISSAN MAXIMA
	1981	L6-2.8L	NISSAN 810
	1975-1978	L6-2.8L	NISSAN 280Z
	1979-1983	L6-2.8L	NISSAN 280ZX
	1982-1983	L6-2.8L	NISSAN MAXIMA
<b>US9012</b>	1975-1976	L4-1.6L	TOYOTA COROLLA
<b>US9015</b>	1978-1979	L4-1.2L	TOYOTA COROLLA
	1981-1982	L4-1.3L	TOYOTA STARLET
<b>US9016</b>	1976	L4-1.6L	TOYOTA COROLLA
<b>US9017</b>	1978-1980	L4-2.2L	TOYOTA CELICA
	1978-1982	L4-2.2L	TOYOTA CORONA
	1978-1980	L4-2.2L	TOYOTA PICKUP
	1984	L4-2.4L	TOYOTA 4RUNNER
	1981-1984	L4-2.4L	TOYOTA CELICA
	1981-1984	L4-2.4L	TOYOTA PICKUP
<b>US9018</b>	1977-1979	L4-1.6L	TOYOTA COROLLA
	1980-1982	L4-1.8L	TOYOTA COROLLA

USMW	Years	Cyl.	Specifications
<b>US9020</b>	1977-1978	L4-1.3L	MAZDA GLC
	1979-1980	L4-1.4L	MAZDA GLC
	1981-1983	L4-1.5L	MAZDA GLC
<b>US9021</b>	1977	L4-1.2L	TOYOTA COROLLA
<b>US9025</b>	1980	H4-1.6L	SUBARU BRAT
	1980-1984	H4-1.6L	SUBARU DL
	1980-1987	H4-1.6L	SUBARU GL
	1980	H4-1.6L	SUBARU GLF
	1980-1987	H4-1.6L	SUBARU STANDARD
	1980-1987	H4-1.8L	SUBARU BRAT
	1980-1984	H4-1.8L	SUBARU DL
	1980-1984	H4-1.8L	SUBARU GL
	1980-1982	H4-1.8L	SUBARU GLF
	1981-1982	H4-1.8L	SUBARU STANDARD
<b>US9026</b>	1980-1982	L4-1.2L	NISSAN 210
	1979-1982	L4-1.4L	NISSAN 210
	1975-1978	L4-1.4L	NISSAN B210
	1980-1982	L4-1.5L	NISSAN 210
<b>US9027</b>	1975-1977	L4-2.2L	TOYOTA CELICA
	1976-1977	L4-2.2L	TOYOTA CORONA
	1976-1977	L4-2.2L	TOYOTA PICKUP
<b>US9028</b>	1980	L4-1.5L	TOYOTA TERCEL
<b>US9029</b>	1980-1981	L4-1.8L	HONDA ACCORD
	1980-1981	L4-1.8L	HONDA PRELUDE
<b>US9031</b>	1978-1981	L4-2.0L	NISSAN 510
	1975-1976	L4-2.0L	NISSAN 610
	1975-1979	L4-2.0L	NISSAN 620
	1975-1977	L4-2.0L	NISSAN 710
	1980-1986	L4-2.0L	NISSAN 720
	1977-1981	L4-2.0L	NISSAN 200SX
	1981-1983	L4-2.2L	NISSAN 720
	1982-1983	L4-2.2L	NISSAN 200SX
	1983-1986	L4-2.4L	NISSAN 720
	1986-1989	L4-2.4L	NISSAN D21
	1987	L4-2.4L	NISSAN PATHFINDER
<b>US9033N</b>	1975-1977	L4-1.2L	HONDA CIVIC
<b>US9034</b>	1975-1979	L4-1.5L	HONDA CIVIC
	1976-1978	L4-1.6L	HONDA ACCORD
	1979	L4-1.8L	HONDA ACCORD
	1979	L4-1.8L	HONDA PRELUDE
<b>US9035</b>	1980-1983	L4-1.5L	HONDA CIVIC
	1982-1983	L4-1.8L	HONDA ACCORD
	1982	L4-1.8L	HONDA PRELUDE
<b>US9039N</b>	1980	L6-2.6L	TOYOTA CELICA
	1980	L6-2.6L	TOYOTA CRESSIDA
	1981	L6-2.8L	TOYOTA CELICA
	1981-1982	L6-2.8L	TOYOTA CRESSIDA
<b>US9040N</b>	1982-1986	L6-2.8L	TOYOTA CELICA
	1983-1988	L6-2.8L	TOYOTA CRESSIDA
<b>US9041</b>	1982	L4-1.5L	NISSAN 310
	1983	L4-1.5L	NISSAN PULSAR NX
	1983	L4-1.5L	NISSAN SENTRA
	1984-1987	L4-1.5L	NISSAN TSURU (MEX)
	1983	L4-1.6L	NISSAN PULSAR
	1983-1988	L4-1.6L	NISSAN PULSAR NX
	1982-1988	L4-1.6L	NISSAN SENTRA
<b>US9043N</b>	1980-1983	L4-1.3L	HONDA CIVIC
<b>US9044</b>	1983-1986	L4-1.7L	NISSAN SENTRA
<b>US9045</b>	1980-1988	L4-1.5L	TOYOTA TERCEL
<b>US9046</b>	1984-1987	L4-1.6L	TOYOTA COROLLA
<b>US9047</b>	2008-2011	L4-2.0L	AUDI A3
	2010-2012	L4-2.0L	AUDI A4
	2010-2012	L4-2.0L	AUDI A4 QUATTRO
	2010-2012	L4-2.0L	AUDI A5
	2010-2012	L4-2.0L	AUDI A5 QUATTRO
	2012	L4-2.0L	AUDI A6
	2011-2012	L4-2.0L	AUDI Q5
	2010-2012	L4-2.0L	AUDI TT QUATTRO
	2012	L4-2.0L	VOLKSWAGEN BEETLE

WATER PUMPS



USMW	Years	Cyl.	Specifications
	2009-2012	L4-2.0L	VOLKSWAGEN CC
	2009-2012	L4-2.0L	VOLKSWAGEN EOS
	2010-2012	L4-2.0L	VOLKSWAGEN GTI
	2008-2012	L4-2.0L	VOLKSWAGEN JETTA
	2009-2010	L4-2.0L	VOLKSWAGEN PASSAT
	2011-2012	L4-2.0L	VOLKSWAGEN TIGUAN
<b>US9048</b>	1983-1986	L4-2.0L	TOYOTA CAMRY
	1986	L4-2.0L	TOYOTA CELICA
<b>US9049</b>	1976-1984	L4-2.1L	VOLVO 242
	1976-1985	L4-2.1L	VOLVO 244
	1976-1985	L4-2.1L	VOLVO 245
	1983-1984	L4-2.3L	VOLVO 244
	1983-1984	L4-2.3L	VOLVO 245
	1984	L4-2.3L	VOLVO 760
<b>US9050</b>	1981-1985	L4-1.5L	MAZDA GLC
<b>US9052</b>	1980-1983	L5-2.2L	AUDI 4000
	1980-1988	L5-2.2L	AUDI 5000
	1989	L5-2.2L	AUDI 200 QUATTRO
	1984-1987	L5-2.2L	AUDI 4000 QUATTRO
	1986-1988	L5-2.2L	AUDI 5000 QUATTRO
	1981-1987	L5-2.2L	AUDI COUPE
	1983-1985	L5-2.2L	AUDI QUATTRO
	1983-1988	L5-2.2L	VOLKSWAGEN QUANTUM
	1988	L5-2.3L	AUDI 90
	1987-1988	L5-2.3L	AUDI 5000
	1987	L5-2.3L	AUDI 5000 QUATTRO
	1988	L5-2.3L	AUDI 80 QUATTRO
	1988	L5-2.3L	AUDI 90 QUATTRO
	1987	L5-2.3L	AUDI COUPE
<b>US9053</b>	1975-1978	R2-1.1L	MAZDA RX-3
	1979-1985	R2-1.1L	MAZDA RX-7
	1976-1978	R2-1.3L	MAZDA COSMO
	1975-1977	R2-1.3L	MAZDA ROTARY PICKUP
	1975-1978	R2-1.3L	MAZDA RX-4
<b>US9056</b>	1984-1985	L4-1.8L	HONDA ACCORD
	1983-1987	L4-1.8L	HONDA PRELUDE
<b>US9057</b>	1985-1988	L4-1.6L	CHEVROLET NOVA
	1989-1992	L4-1.6L	GEO PRIZM
	1990-1993	L4-1.6L	TOYOTA CELICA
	1983-1992	L4-1.6L	TOYOTA COROLLA
<b>US9058</b>	1990-1992	V6-3.0L	INFINITI M30
	1987-1988	V6-3.0L	NISSAN 200SX
	1984-1989	V6-3.0L	NISSAN 300ZX
	1986-1994	V6-3.0L	NISSAN D21
	1995	V6-3.0L	NISSAN PICKUP
<b>US9059</b>	1984-1986	L4-1.8L	TOYOTA CAMRY
	1984-1985	L4-1.8L	TOYOTA COROLLA
	1986	L4-2.0L	TOYOTA CAMRY
<b>US9060</b>	1983-1985	L4-2.0L	MAZDA 626
	1986	L4-2.0L	MAZDA B2000
<b>US9061</b>	1983-1985	H4-1.9L	VOLKSWAGEN VANAGON
<b>US9063</b>	1987	L4-1.6L	NISSAN PULSAR NX
	1984-1986	L4-1.8L	NISSAN 200SX
	1982-1984	L4-1.8L	NISSAN NISSAN SEDAN (MEX)
	1981-1986	L4-1.8L	NISSAN PICKUP (MEX)
	1982-1987	L4-1.8L	NISSAN SAKURA (MEX)
	1980-1984	L4-1.8L	NISSAN SAMURAI (MEX)
	1982-1984	L4-1.8L	NISSAN STATION WAGON (MEX)
	1984-1988	L4-2.0L	NISSAN 200SX
<b>US9064</b>	1983-1984	L4-1.3L	TOYOTA STARLET
<b>US9065</b>	1986	L4-1.3L	VOLKSWAGEN VARIANT (MEX)
	1982-1983	L4-1.6L	AUDI 4000
	1982-1984	L4-1.6L	VOLKSWAGEN ATLANTIC (MEX)
	1985-1988	L4-1.6L	VOLKSWAGEN GOLF
	1982-1992	L4-1.6L	VOLKSWAGEN JETTA
	1982-1985	L4-1.6L	VOLKSWAGEN QUANTUM
	1983-1984	L4-1.6L	VOLKSWAGEN RABBIT
	1981-1983	L4-1.6L	VOLKSWAGEN RABBIT PICKUP
	1986	L4-1.6L	VOLKSWAGEN VARIANT (MEX)

USMW	Years	Cyl.	Specifications
	2004	L4-1.6L	VOLKSWAGEN VW VAN (MEX)
	1981-1983	L4-1.7L	AUDI 4000
	1982-1986	L4-1.7L	VOLKSWAGEN ATLANTIC (MEX)
	1978-1986	L4-1.7L	VOLKSWAGEN CARIBE (MEX)
	1987	L4-1.7L	VOLKSWAGEN GOLF (MEX)
	1981-1984	L4-1.7L	VOLKSWAGEN JETTA
	1982-1983	L4-1.7L	VOLKSWAGEN QUANTUM
	1981-1984	L4-1.7L	VOLKSWAGEN RABBIT
	1981-1982	L4-1.7L	VOLKSWAGEN RABBIT CONVERTIBLE
	1981-1982	L4-1.7L	VOLKSWAGEN RABBIT PICKUP
	1981-1983	L4-1.7L	VOLKSWAGEN SCIROCCO
	1984-1987	L4-1.8L	AUDI 4000
	1984-1987	L4-1.8L	VOLKSWAGEN ATLANTIC (MEX)
	2003	L4-1.8L	VOLKSWAGEN CABRIO (MEX)
	1985-1993	L4-1.8L	VOLKSWAGEN CABRIOLET
	1985-1987	L4-1.8L	VOLKSWAGEN CARIBE (MEX)
	1988-2001	L4-1.8L	VOLKSWAGEN COMBI (MEX)
	1990-1992	L4-1.8L	VOLKSWAGEN CORRADO
	1984-1987	L4-1.8L	VOLKSWAGEN CORSAR (MEX)
	1994-2009	L4-1.8L	VOLKSWAGEN DERBY (MEX)
	1987-1993	L4-1.8L	VOLKSWAGEN FOX
	1985-1992	L4-1.8L	VOLKSWAGEN GOLF
	1987-1997	L4-1.8L	VOLKSWAGEN GOLF (MEX)
	1984-1992	L4-1.8L	VOLKSWAGEN JETTA
	1987-1997	L4-1.8L	VOLKSWAGEN JETTA (MEX)
	1988-2001	L4-1.8L	VOLKSWAGEN PANEL (MEX)
	1986-1993	L4-1.8L	VOLKSWAGEN PASSAT (MEX)
	1986	L4-1.8L	VOLKSWAGEN PASSAT SANTANA (MEX)
	1998-2009	L4-1.8L	VOLKSWAGEN POINTER (MEX)
	1984-1985	L4-1.8L	VOLKSWAGEN QUANTUM
	1983-1984	L4-1.8L	VOLKSWAGEN RABBIT
	1983-1984	L4-1.8L	VOLKSWAGEN RABBIT CONVERTIBLE
	1984-1988	L4-1.8L	VOLKSWAGEN SCIROCCO
	1986	L4-1.8L	VOLKSWAGEN VARIANT (MEX)
	2002-2009	L4-1.8L	VOLKSWAGEN VW VAN (MEX)
	1997-1998	L4-1.9L	VOLKSWAGEN JETTA
	1996-1997	L4-1.9L	VOLKSWAGEN PASSAT
	1991	L4-1.9L	VOLKSWAGEN PASSAT (MEX)
	1988-1990	L4-2.0L	AUDI 80
	1988	L4-2.0L	AUDI 90
	1995-2002	L4-2.0L	VOLKSWAGEN CABRIO
	1990-1999	L4-2.0L	VOLKSWAGEN GOLF
	1990-1999	L4-2.0L	VOLKSWAGEN JETTA
	1990-1996	L4-2.0L	VOLKSWAGEN PASSAT
	1997	L4-2.0L	VOLKSWAGEN PASSAT (MEX)
<b>US9066</b>	1975-1980	L4-1.5L	VOLKSWAGEN DASHER
	1975-1980	L4-1.5L	VOLKSWAGEN RABBIT
	1980	L4-1.5L	VOLKSWAGEN RABBIT PICKUP
	1975-1978	L4-1.5L	VOLKSWAGEN SCIROCCO
	1980	L4-1.6L	AUDI 4000
	1975-1979	L4-1.6L	AUDI FOX
	1978-1981	L4-1.6L	VOLKSWAGEN ATLANTIC (MEX)
	1977-1984	L4-1.6L	VOLKSWAGEN CARIBE (MEX)
	1976-1981	L4-1.6L	VOLKSWAGEN DASHER
	1980-1982	L4-1.6L	VOLKSWAGEN JETTA
	1976-1983	L4-1.6L	VOLKSWAGEN RABBIT
	1980-1982	L4-1.6L	VOLKSWAGEN RABBIT PICKUP
	1976-1980	L4-1.6L	VOLKSWAGEN SCIROCCO
	1986	L4-1.6L	VOLKSWAGEN VARIANT (MEX)
	1981	L4-1.7L	AUDI 4000
	1978-1981	L4-1.7L	VOLKSWAGEN ATLANTIC (MEX)
	1981-1984	L4-1.7L	VOLKSWAGEN RABBIT
	1980	L4-1.7L	VOLKSWAGEN RABBIT CONVERTIBLE
	1981-1983	L4-1.7L	VOLKSWAGEN RABBIT PICKUP
	1981	L4-1.7L	VOLKSWAGEN SCIROCCO
	1984	L4-1.8L	VOLKSWAGEN CARIBE (MEX)
<b>US9067</b>	1984-1987	L4-2.0L	FORD ESCORT
	1984-1986	L4-2.0L	FORD TEMPO
	1984-1985	L4-2.0L	MAZDA 626

USMW	Years	Cyl.	Specifications
	1984-1987	L4-2.0L	MERCURY LYNX
	1984-1986	L4-2.0L	MERCURY TOPAZ
<b>US9068</b>	1990-1993	L4-2.3L	VOLVO 240
	1985-1989	L4-2.3L	VOLVO 244
	1985-1989	L4-2.3L	VOLVO 245
	1985-1992	L4-2.3L	VOLVO 740
	1985	L4-2.3L	VOLVO 745
	1985-1990	L4-2.3L	VOLVO 760
	1989-1991	L4-2.3L	VOLVO 780
	1991-1995	L4-2.3L	VOLVO 940
<b>US9069</b>	1985-1987	L4-1.3L	HONDA CIVIC
	1984-1987	L4-1.5L	HONDA CIVIC
	1984-1987	L4-1.5L	HONDA WAGOVAN
<b>US9071</b>	1979-1983	L5-2.0L	AUDI 5000
	1982-1984	L6-2.4L	VOLVO 244
	1982-1984	L6-2.4L	VOLVO 245
	1980-1981	L6-2.4L	VOLVO 264
	1980	L6-2.4L	VOLVO 265
	1986	L6-2.4L	VOLVO 740
	1985	L6-2.4L	VOLVO 745
	1983-1985	L6-2.4L	VOLVO 760
<b>US9074</b>	1993-1998	V6-3.0L	MERCURY VILLAGER
	1985-1994	V6-3.0L	NISSAN MAXIMA
	1993-1998	V6-3.0L	NISSAN QUEST
<b>US9075</b>	1985-1987	L4-1.6L	TOYOTA COROLLA
<b>US9076</b>	1988	L4-1.6L	CHEVROLET NOVA
	1990-1992	L4-1.6L	GEO PRIZM
	1987-1991	L4-1.6L	TOYOTA COROLLA
	1985-1989	L4-1.6L	TOYOTA MR2
<b>US9077</b>	1975	L6-3.0L	VOLVO 164
<b>US9078</b>	1969-1974	L6-3.9L	TOYOTA LAND CRUISER
<b>US9080</b>	1985-1989	H4-1.8L	SUBARU DL
	1985-1989	H4-1.8L	SUBARU GL
	1985-1989	H4-1.8L	SUBARU GL-10
	1986-1989	H4-1.8L	SUBARU RX
	1987	H4-1.8L	SUBARU STANDARD
	1985-1991	H4-1.8L	SUBARU XT
<b>US9082</b>	1972-1980	L4-1.8L	MG GT
	1972-1980	L4-1.8L	MG MGB
<b>US9083</b>	1986-1989	L4-2.0L	HONDA ACCORD
	1985-1987	L4-2.0L	HONDA PRELUDE
<b>US9084</b>	1971-1973	L4-1.1L	FIAT 128
	1974-1976	L4-1.3L	FIAT 128
	1975-1978	L4-1.3L	FIAT X 1/9
	1979-1982	L4-1.5L	FIAT STRADA
	1979-1982	L4-1.5L	FIAT X 1/9
<b>US9085</b>	1979-1982	L4-1.5L	FIAT STRADA
	1979-1982	L4-1.5L	FIAT X 1/9
<b>US9086</b>	1981-1982	L4-1.5L	TOYOTA TERCEL
<b>US9087</b>	1986-1987	L4-2.0L	TOYOTA CELICA
<b>US9092</b>	1984-1985	L4-2.0L	TOYOTA VAN
	1986-1989	L4-2.2L	TOYOTA VAN
<b>US9093</b>	1984	H4-1.8L	SUBARU BRAT
<b>US9094</b>	1981-1983	L4-2.2L	TOYOTA PICKUP
<b>US9097</b>	1986-1987	V6-2.5L	ACURA LEGEND
	1987-1988	V6-2.5L	STERLING 825
	1987-1990	V6-2.7L	ACURA LEGEND
	1995-1997	V6-2.7L	HONDA ACCORD
	1989-1990	V6-2.7L	STERLING 827
<b>US9098</b>	1992-1994	L4-1.5L	TOYOTA PASEO
	1987-1994	L4-1.5L	TOYOTA TERCEL
<b>US9099</b>	1987-1991	L4-2.0L	TOYOTA CAMRY
	1987-1989	L4-2.0L	TOYOTA CELICA
	1996-2000	L4-2.0L	TOYOTA RAV4
	1992-2001	L4-2.2L	TOYOTA CAMRY
	1990-1999	L4-2.2L	TOYOTA CELICA
	1991-1995	L4-2.2L	TOYOTA MR2
	1999-2001	L4-2.2L	TOYOTA SOLARA
<b>US9100</b>	1989-1992	L6-3.0L	TOYOTA CRESSIDA

USMW	Years	Cyl.	Specifications
	1986-1992	L6-3.0L	TOYOTA SUPRA
<b>US9102</b>	1986-1988	R2-1.3L	MAZDA RX-7
<b>US9104</b>	1986-1994	V6-3.0L	NISSAN D21
	1987-1995	V6-3.0L	NISSAN PATHFINDER
	1995	V6-3.0L	NISSAN PICKUP
<b>US9105</b>	1989-1993	L4-2.3L	ISUZU AMIGO
	1988-1989	L4-2.3L	ISUZU IMPULSE
	1986-1995	L4-2.3L	ISUZU PICKUP
	1986-1987	L4-2.3L	ISUZU TROOPER
<b>US9106</b>	1985-1989	L4-2.0L	ISUZU IMPULSE
<b>US9107</b>	1986-1990	L4-2.0L	SAAB 9000
<b>US9108</b>	1981-1993	L4-2.0L	SAAB 900
	1991-1994	L4-2.1L	SAAB 900
<b>US9109</b>	1988-1991	H6-2.7L	SUBARU XT
<b>US9110</b>	1987-1988	L4-2.4L	NISSAN VAN
<b>US9111</b>	1986-1987	L4-2.0L	MAZDA 626
	1987	L4-2.0L	MAZDA B2000
<b>US9114</b>	1982-1986	L4-2.0L	NISSAN STANZA
<b>US9115</b>	1986-1989	L4-1.6L	ACURA INTEGRA
<b>US9116</b>	1987-1989	L4-1.8L	NISSAN ICHI VAN (MEX)
	1985-1990	L4-1.8L	NISSAN PICKUP (MEX)
	1987-1989	L4-1.8L	NISSAN PULSAR NX
	1987-1989	L4-2.0L	NISSAN STANZA
<b>US9117</b>	1980-1981	L6-2.8L	BMW 528I
	1983-1984	L6-3.2L	BMW 533I
	1980-1984	L6-3.2L	BMW 633CSI
	1980-1984	L6-3.2L	BMW 733I
	1985-1993	L6-3.5L	BMW 535I
	1988	L6-3.5L	BMW 535IS
	1985-1989	L6-3.5L	BMW 635CSI
	1988-1992	L6-3.5L	BMW 735I
	1988-1992	L6-3.5L	BMW 735IL
	1987	L6-3.5L	BMW L6
	1986-1987	L6-3.5L	BMW L7
	1988	L6-3.5L	BMW M5
	1987-1988	L6-3.5L	BMW M6
<b>US9119</b>	1987	L6-2.5L	BMW 325I
	1987	L6-2.5L	BMW 325IS
	1986-1987	L6-2.7L	BMW 325
	1984-1987	L6-2.7L	BMW 325E
	1986-1987	L6-2.7L	BMW 325ES
	1982-1987	L6-2.7L	BMW 528E
<b>US9120</b>	1988-1993	L6-2.5L	BMW 325I
	1988-1991	L6-2.5L	BMW 325IS
	1988-1991	L6-2.5L	BMW 325IX
	1989-1990	L6-2.5L	BMW 525I
	1988	L6-2.5L	BMW 528E
	1988	L6-2.7L	BMW 325
<b>US9122</b>	1979	L6-2.8L	BMW 528I
	1975-1978	L6-3.0L	BMW 530I
	1977-1978	L6-3.0L	BMW 630CSI
	1978-1979	L6-3.2L	BMW 633CSI
	1978-1979	L6-3.2L	BMW 733I
	1985-1987	L6-3.5L	BMW 735I
<b>US9128</b>	1988-1994	V12-5.0L	BMW 750IL
	1995	V12-5.0L	BMW 750IL (MEX)
<b>US9129</b>	1988-1991	L4-2.0L	HONDA PRELUDE
	1990-1991	L4-2.1L	HONDA PRELUDE
<b>US9130</b>	1988-1995	L4-1.5L	HONDA CIVIC
	1993-1995	L4-1.5L	HONDA CIVIC DEL SOL
	1988-1991	L4-1.5L	HONDA CRX
	1988-1991	L4-1.6L	HONDA CIVIC
	1993-1995	L4-1.6L	HONDA CIVIC DEL SOL
	1988-1991	L4-1.6L	HONDA CRX
<b>US9131</b>	1988-1990	L4-2.0L	HONDA PRELUDE
<b>US9132</b>	1981-1982	L4-2.2L	CHEVROLET LUV
	1981-1987	L4-2.2L	ISUZU PICKUP
	1986-1987	L4-2.2L	ISUZU TROOPER
<b>US9133</b>	1994-1996	L4-2.6L	HONDA PASSPORT

WATER PUMPS

USMW	Years	Cyl.	Specifications
	1989-1994	L4-2.6L	ISUZU AMIGO
	1988-1995	L4-2.6L	ISUZU PICKUP
	1991-1997	L4-2.6L	ISUZU RODEO
	1988-1991	L4-2.6L	ISUZU TROOPER
<b>US9140</b>	1986-1993	L4-2.0L	TOYOTA CELICA
	1991-1995	L4-2.0L	TOYOTA MR2
<b>US9141</b>	1985-1995	L4-2.4L	TOYOTA 4RUNNER
	1985	L4-2.4L	TOYOTA CELICA
	1985-1995	L4-2.4L	TOYOTA PICKUP
<b>US9142</b>	1988-1990	V6-3.0L	TOYOTA 4RUNNER
	1988-1990	V6-3.0L	TOYOTA PICKUP
<b>US9145</b>	1989-1992	V6-3.0L	TOYOTA 4RUNNER
	1989-1992	V6-3.0L	TOYOTA PICKUP
<b>US9146</b>	1979	V6-2.7L	VOLVO 262
	1979	V6-2.7L	VOLVO 264
	1979	V6-2.7L	VOLVO 265
	1980-1981	V6-2.8L	VOLVO 262
	1980-1982	V6-2.8L	VOLVO 264
	1980-1981	V6-2.8L	VOLVO 265
<b>US9147</b>	1976-1978	V6-2.7L	VOLVO 262
	1976-1978	V6-2.7L	VOLVO 264
	1976-1978	V6-2.7L	VOLVO 265
<b>US9149</b>	1980-1983	L4-1.8L	BMW 320I
	1977-1979	L4-2.0L	BMW 320I
<b>US9150</b>	1986-1991	H4-2.1L	VOLKSWAGEN VANAGON
<b>US9152</b>	1984-1985	L4-1.8L	BMW 318I
<b>US9153</b>	1975-1976	L4-2.0L	BMW 2002
<b>US9154</b>	1985-1986	L6-2.4L	BMW 524TD
	1987	L6-2.4L	BMW 524TD (MEX)
	1984-1985	L6-2.4L	LINCOLN CONTINENTAL
	1984-1985	L6-2.4L	LINCOLN MARK VII
<b>US9155</b>	1988-1992	L6-4.0L	TOYOTA LAND CRUISER
<b>US9158</b>	1980	L4-2.0L	SAAB 99
<b>US9160</b>	1989	L4-1.6L	ISUZU I-MARK
<b>US9161</b>	1985-1989	H4-1.8L	SUBARU DL
	1985-1989	H4-1.8L	SUBARU GL
	1985-1989	H4-1.8L	SUBARU GL-10
	1990-1994	H4-1.8L	SUBARU LOYALE
	1986-1989	H4-1.8L	SUBARU RX
	1987	H4-1.8L	SUBARU STANDARD
<b>US9162</b>	1990	L4-2.4L	NISSAN AXCESS
	1990-1992	L4-2.4L	NISSAN STANZA
<b>US9163</b>	1988-1989	L6-3.6L	JAGUAR VANDEN PLAS
	1988-1989	L6-3.6L	JAGUAR XJ6
	1990-1992	L6-4.0L	JAGUAR VANDEN PLAS
	1990-1992	L6-4.0L	JAGUAR XJ6
	1993-1994	L6-4.0L	JAGUAR XJS
<b>US9165</b>	1975-1979	V12-5.3L	JAGUAR XJ12
	1976-1992	V12-5.3L	JAGUAR XJS
	1994-1996	V12-6.0L	JAGUAR XJ12
	1993	V12-6.0L	JAGUAR XJRS
	1994-1995	V12-6.0L	JAGUAR XJS
<b>US9166</b>	1988-1991	V6-3.0L	MAZDA 929
	1989-1995	V6-3.0L	MAZDA MPV
<b>US9167</b>	1989-1993	L4-2.6L	MAZDA B2600
	1989-1994	L4-2.6L	MAZDA MPV
<b>US9168</b>	1989-1992	L4-2.0L	MITSUBISHI GALANT
	1992	L4-2.4L	EAGLE SUMMIT
	1992	L4-2.4L	MITSUBISHI EXPO
	1992	L4-2.4L	PLYMOUTH COLT
<b>US9170</b>	1979	L6-2.6L	TOYOTA CELICA
	1978-1979	L6-2.6L	TOYOTA CRESSIDA
<b>US9171</b>	1989-1991	L5-2.2L	AUDI 200
	1989-1991	L5-2.2L	AUDI 200 QUATTRO
	1991-1992	L5-2.3L	AUDI 80
	1988-1991	L5-2.3L	AUDI 90
	1989-1991	L5-2.3L	AUDI 100
	1989-1991	L5-2.3L	AUDI 100 QUATTRO
	1988-1992	L5-2.3L	AUDI 80 QUATTRO

USMW	Years	Cyl.	Specifications
	1988-1991	L5-2.3L	AUDI 90 QUATTRO
	1990-1991	L5-2.3L	AUDI COUPE QUATTRO
<b>US9172</b>	1975-1978	L4-2.3L	MERCEDES-BENZ 230
	1975-1983	L4-2.4L	MERCEDES-BENZ 240D
	1978-1985	L5-3.0L	MERCEDES-BENZ 300CD
	1975-1985	L5-3.0L	MERCEDES-BENZ 300D
	1978-1985	L5-3.0L	MERCEDES-BENZ 300SD
	1981-1985	L5-3.0L	MERCEDES-BENZ 300TD
	1989	L6-3.0L	MERCEDES-BENZ 300D (MEX)
<b>US9173</b>	1984	L4-2.3L	MERCEDES-BENZ 190E
<b>US9175</b>	1985-1993	L4-2.3L	MERCEDES-BENZ 190E
	1986-1991	L4-2.3L	MERCEDES-BENZ 230E (MEX)
<b>US9176</b>	1975-1976	V8-4.5L	MERCEDES-BENZ 450SE
	1975-1980	V8-4.5L	MERCEDES-BENZ 450SEL
	1975-1980	V8-4.5L	MERCEDES-BENZ 450SL
	1975-1980	V8-4.5L	MERCEDES-BENZ 450SLC
<b>US9177</b>	1977-1982	L4-2.0L	PORSCHE 924
<b>US9179</b>	1965-1969	L4-1.3L	NISSAN PICKUP (MEX)
	1990-1992	L4-1.8L	NISSAN ICHI VAN (MEX)
	1991-1994	L4-1.8L	NISSAN PICKUP (MEX)
<b>US9180</b>	1975-1976	L4-2.3L	TOYOTA CROWN
<b>US9189</b>	1979-1980	L6-4.2L	TOYOTA LAND CRUISER
<b>US9193</b>	1980-1987	L4-2.0L	PEUGEOT 505
<b>US9198</b>	1981-1983	L4-2.2L	NISSAN 720
	1983-1986	L4-2.5L	NISSAN 720
<b>US9200</b>	1984-1985	L4-2.4L	TOYOTA PICKUP
<b>US9201</b>	1990-1996	V6-3.0L	NISSAN 300ZX
<b>US9202</b>	1987-1993	L6-2.6L	MERCEDES-BENZ 190E
	1987-1989	L6-2.6L	MERCEDES-BENZ 260E
	1992	L6-2.6L	MERCEDES-BENZ 260E (MEX)
	1987-1989	L6-2.6L	MERCEDES-BENZ 260SE (MEX)
	1990-1992	L6-2.6L	MERCEDES-BENZ 300E
	1988-1989	L6-3.0L	MERCEDES-BENZ 300CE
	1993	L6-3.0L	MERCEDES-BENZ 300CE (MEX)
	1986-1993	L6-3.0L	MERCEDES-BENZ 300E
	1988-1991	L6-3.0L	MERCEDES-BENZ 300SE
	1988-1991	L6-3.0L	MERCEDES-BENZ 300SEL
	1986	L6-3.0L	MERCEDES-BENZ 300SL (MEX)
	1988-1993	L6-3.0L	MERCEDES-BENZ 300TE
	1986-1987	L6-3.0L	MERCEDES-BENZ 300TE (MEX)
<b>US9203</b>	1966-1969	L4-1.2L	FIAT 124
<b>US9206</b>	1989-1998	L4-2.4L	NISSAN 240SX
	1990-1994	L4-2.4L	NISSAN D21
	1998-2004	L4-2.4L	NISSAN FRONTIER
	2008	L4-2.4L	NISSAN FRONTIER PICKUP (MEX)
	1991-1994	L4-2.4L	NISSAN ICHI VAN (MEX)
	1995-1997	L4-2.4L	NISSAN PICKUP
	1991-2012	L4-2.4L	NISSAN PICKUP (MEX)
	2000-2007	L4-2.4L	NISSAN URVAN (MEX)
	2000-2004	L4-2.4L	NISSAN XTERRA
	2008-2011	L4-2.5L	NISSAN CABSTAR (MEX)
	2009-2012	L4-2.5L	NISSAN PICKUP (MEX)
	2009-2012	L4-2.5L	NISSAN PICKUP 4WD (MEX)
<b>US9207</b>	1989-1990	L4-1.6L	NISSAN PULSAR NX
	1989-1990	L4-1.6L	NISSAN SENTRA
<b>US9208</b>	1989-1991	R2-1.3L	MAZDA RX-7
<b>US9209</b>	1997	L4-2.2L	ACURA CL
	1990-1997	L4-2.2L	HONDA ACCORD
	1995-1997	L4-2.2L	HONDA ODYSSEY
	1992-1996	L4-2.2L	HONDA PRELUDE
	1996-1997	L4-2.2L	ISUZU OASIS
	1998-1999	L4-2.3L	ACURA CL
	1998-2002	L4-2.3L	HONDA ACCORD
	1998	L4-2.3L	HONDA ODYSSEY
	1998-1999	L4-2.3L	ISUZU OASIS
<b>US9211</b>	1975-1982	L6-4.2L	JAGUAR XJ6
<b>US9212</b>	1993-1995	L4-1.8L	HYUNDAI ELANTRA
	1990-1994	L4-2.0L	EAGLE TALON
	1992-1998	L4-2.0L	HYUNDAI SONATA



USMW	Years	Cyl.	Specifications
	1990-1994	L4-2.0L	mitsubishi Eclipse
	1989-1992	L4-2.0L	mitsubishi Galant
	1990-1994	L4-2.0L	Plymouth Laser
<b>US9213</b>	2000	L4-1.6L	Nissan Sentra (MEX)
	1991-2002	L4-2.0L	Infiniti G20
	1995-1998	L4-2.0L	Nissan 200SX
	1996-2000	L4-2.0L	Nissan Lucino (MEX)
	1991-1993	L4-2.0L	Nissan NX
	1992	L4-2.0L	Nissan Primera (MEX)
	1991-2001	L4-2.0L	Nissan Sentra
	1996-1997	L4-2.0L	Nissan Sentra (MEX)
	1993-1996	L4-2.0L	Nissan Tsuru (MEX)
<b>US9214</b>	1995-1998	L4-1.6L	Nissan 200SX
	1995-2000	L4-1.6L	Nissan Lucino (MEX)
	1991-1993	L4-1.6L	Nissan NX
	1991-1999	L4-1.6L	Nissan Sentra
	1993-2004	L4-1.6L	Nissan TsuBame (MEX)
	1988-2012	L4-1.6L	Nissan Tsuru (MEX)
<b>US9215</b>	2005	H4-2.0L	Saab 9-2X
	2002-2005	H4-2.0L	Subaru Impreza
	2006	H4-2.5L	Saab 9-2X
	2004-2006	H4-2.5L	Subaru Baja
	2004-2012	H4-2.5L	Subaru Forester
	2004-2012	H4-2.5L	Subaru Impreza
	2005-2009	H4-2.5L	Subaru Legacy
	2005-2009	H4-2.5L	Subaru Outback
	2010	L4-2.5L	Subaru Forester (MEX)
	2010	L4-2.5L	Subaru Impreza (MEX)
<b>US9216</b>	1991-1997	L4-2.4L	Toyota Previa
<b>US9218</b>	1991-1995	V6-3.2L	Acura Legend
<b>US9219</b>	1991-2005	V6-3.0L	Acura NSX
	1997-2005	V6-3.2L	Acura NSX
<b>US9220</b>	1990-1991	L4-1.6L	Geo Storm
	1990-1992	L4-1.6L	Isuzu Impulse
	1991	L4-1.6L	Isuzu Stylus
<b>US9221</b>	1990-1993	L4-1.6L	Geo Storm
	1991-1993	L4-1.6L	Isuzu Stylus
	1992-1993	L4-1.8L	Geo Storm
	1992	L4-1.8L	Isuzu Impulse
	1992	L4-1.8L	Isuzu Stylus
<b>US9222</b>	1990-1992	L6-3.0L	Mercedes-Benz 300CE
	1990-1993	L6-3.0L	Mercedes-Benz 300SL
<b>US9223</b>	1993-1997	H4-1.8L	Subaru Impreza
	1995-2004	H4-2.2L	Subaru Impreza
	1990-1999	H4-2.2L	Subaru Legacy
	2005-2006	H4-2.5L	Saab 9-2X
	2003-2006	H4-2.5L	Subaru Baja
	1998-2005	H4-2.5L	Subaru Forester
	1998-2005	H4-2.5L	Subaru Impreza
	1996-2005	H4-2.5L	Subaru Legacy
	2000-2005	H4-2.5L	Subaru Outback
	2008-2009	L4-2.0L	Subaru Impreza (MEX)
	2008-2009	L4-2.0L	Subaru Legacy (MEX)
<b>US9224</b>	1990-1995	L4-1.8L	Acura Integra
<b>US9225</b>	1989-1991	V6-3.0L	Mazda 929
<b>US9226</b>	1990-1991	V8-3.6L	Audi V8 Quattro
	1992-1994	V8-4.2L	Audi V8 Quattro
<b>US9227</b>	1982-1984	L4-1.0L	Suzuki SJ410
<b>US9228</b>	1986-1989	L5-2.5L	Mercedes-Benz 190D
	1990	L5-2.5L	Mercedes-Benz 190DT (MEX)
	1986	L5-2.5L	Mercedes-Benz 250D (MEX)
	1990-1993	L5-2.5L	Mercedes-Benz 300D
	1986	L5-3.0L	Mercedes-Benz 300D (MEX)
	1987	L6-3.0L	Mercedes-Benz 300D
	1986-1987	L6-3.0L	Mercedes-Benz 300SDL
	1987	L6-3.0L	Mercedes-Benz 300TD
	1995-1999	L6-3.0L	Mercedes-Benz E300
	1992-1993	L6-3.4L	Mercedes-Benz 300SD
	1991	L6-3.4L	Mercedes-Benz 350SD

USMW	Years	Cyl.	Specifications
	1990-1991	L6-3.4L	Mercedes-Benz 350SDL
	1994-1995	L6-3.4L	Mercedes-Benz S350
<b>US9230</b>	1984-1985	V8-3.8L	Mercedes-Benz 380SE
	1982-1983	V8-3.8L	Mercedes-Benz 380SEC
	1981-1983	V8-3.8L	Mercedes-Benz 380SEL
	1981-1985	V8-3.8L	Mercedes-Benz 380SL
	1981	V8-3.8L	Mercedes-Benz 380SLC
	1986	V8-5.0L	Mercedes-Benz 500SE (MEX)
	1984-1985	V8-5.0L	Mercedes-Benz 500SEC
	1987	V8-5.0L	Mercedes-Benz 500SEC (MEX)
	1984-1985	V8-5.0L	Mercedes-Benz 500SEL
	1986	V8-5.0L	Mercedes-Benz 500SL (MEX)
<b>US9231</b>	1986	V8-4.2L	Mercedes-Benz 420SE (MEX)
	1986-1991	V8-4.2L	Mercedes-Benz 420SEL
	1986	V8-4.2L	Mercedes-Benz 420SL (MEX)
	1986	V8-5.6L	Mercedes-Benz 560SE (MEX)
	1986-1991	V8-5.6L	Mercedes-Benz 560SEC
	1986-1991	V8-5.6L	Mercedes-Benz 560SEL
	1994-1996	V8-5.6L	Mercedes-Benz 560SEL (MEX)
	1986-1989	V8-5.6L	Mercedes-Benz 560SL
<b>US9232</b>	1982-1984	L4-1.0L	Suzuki SJ410
<b>US9234</b>	1986	L6-2.5L	Bmw 525i (MEX)
	1991-1993	L6-3.6L	Bmw M5
<b>US9236</b>	1995	V12-5.0L	Bmw 850 (MEX)
	1993-1994	V12-5.0L	Bmw 850Ci
	1996-1997	V12-5.0L	Bmw 850Ci (MEX)
	1991-1992	V12-5.0L	Bmw 850i
	1990	V12-5.0L	Bmw 850i (MEX)
	1994-1995	V12-5.6L	Bmw 850CSI
<b>US9237</b>	1989-1992	L4-1.3L	Daihatsu Charade
<b>US9238</b>	1988-1992	L3-1.0L	Daihatsu Charade
<b>US9239</b>	1990-1993	V8-4.5L	Infiniti Q45
<b>US9241</b>	1987-1991	V8-5.0L	Porsche 928
	1993-1995	V8-5.4L	Porsche 928
<b>US9242</b>	1978-1986	V8-4.5L	Porsche 928
<b>US9245</b>	1987-1988	L4-2.5L	Porsche 924
	1983-1989	L4-2.5L	Porsche 944
<b>US9250</b>	1992-1995	L4-1.5L	Honda Civic
	1992-1995	L4-1.6L	Honda Civic
<b>US9251</b>	1992-1996	L4-2.3L	Honda Prelude
<b>US9252</b>	1992-1994	V6-3.0L	Nissan Maxima
<b>US9253</b>	1995	L5-2.5L	Acura TL
	1992-1994	L5-2.5L	Acura Vigor
<b>US9254</b>	1992-1997	H6-3.3L	Subaru SVX
<b>US9255</b>	1993-1994	H4-2.2L	Subaru Legacy
<b>US9256</b>	1993-1997	L6-3.0L	Lexus GS300
	1992-1999	L6-3.0L	Lexus SC300
	1993-1998	L6-3.0L	Toyota Supra
<b>US9257</b>	1998-2000	V8-4.0L	Lexus GS400
	1997-2000	V8-4.0L	Lexus LS400
	1998-2000	V8-4.0L	Lexus SC400
	2001-2007	V8-4.3L	Lexus GS430
	2001-2006	V8-4.3L	Lexus LS430
	2002-2010	V8-4.3L	Lexus SC430
	2003-2009	V8-4.7L	Lexus GX470
	1998-2007	V8-4.7L	Lexus LX470
	2003-2009	V8-4.7L	Toyota 4Runner
	1998-2007	V8-4.7L	Toyota Land Cruiser
	2001-2009	V8-4.7L	Toyota Sequoia
	2000-2009	V8-4.7L	Toyota Tundra
<b>US9258</b>	1990-1991	V6-2.5L	Lexus ES250
	1988-1991	V6-2.5L	Toyota Camry
	1992-1993	V6-3.0L	Lexus ES300
	1992-1993	V6-3.0L	Toyota Camry
<b>US9259</b>	1993-1994	V6-2.5L	Ford Probe
<b>US9260</b>	1992-1995	V6-3.0L	Mazda 929
<b>US9261</b>	2000	L6-2.0L	Bmw Z3 (MEX)
	2001-2005	L6-2.2L	Bmw 320i (MEX)
	2001	L6-2.2L	Bmw Z3 (MEX)

**WATER PUMPS**

USMW	Years	Cyl.	Specifications
	2000	L6-2.5L	BMW 323CI
	1998-2000	L6-2.5L	BMW 323I
	1997-2001	L6-2.5L	BMW 323I (MEX)
	1998-1999	L6-2.5L	BMW 323IS
	2001	L6-2.5L	BMW 323TI (MEX)
	2001-2006	L6-2.5L	BMW 325CI
	2007	L6-2.5L	BMW 325CI (MEX)
	1992-2005	L6-2.5L	BMW 325I
	1996-2012	L6-2.5L	BMW 325I (MEX)
	1992-1995	L6-2.5L	BMW 325IS
	2001-2005	L6-2.5L	BMW 325XI
	1991-2005	L6-2.5L	BMW 525I
	2006-2010	L6-2.5L	BMW 525I (MEX)
	1993	L6-2.5L	BMW 525IT
	2004-2005	L6-2.5L	BMW X3
	2006-2009	L6-2.5L	BMW X3 (MEX)
	1999-2002	L6-2.5L	BMW X3
	2003-2005	L6-2.5L	BMW Z4
	2007-2009	L6-2.5L	BMW Z4 (MEX)
	2000	L6-2.8L	BMW 328CI
	1996-2000	L6-2.8L	BMW 328I
	1995	L6-2.8L	BMW 328I (MEX)
	1996-1999	L6-2.8L	BMW 328IS
	1996	L6-2.8L	BMW 528 (MEX)
	1997-2000	L6-2.8L	BMW 528I
	1997	L6-2.8L	BMW 728I (MEX)
	1997-2000	L6-2.8L	BMW Z3
	2006-2010	L6-3.0L	BMW 130I (MEX)
	2001-2006	L6-3.0L	BMW 330CI
	2001-2005	L6-3.0L	BMW 330I
	2007	L6-3.0L	BMW 330I (MEX)
	2001-2005	L6-3.0L	BMW 330XI
	2001-2005	L6-3.0L	BMW 530I
	2008-2010	L6-3.0L	BMW 530I (MEX)
	1995	L6-3.0L	BMW M3
	1994-1996	L6-3.0L	BMW M3 (MEX)
	2004-2006	L6-3.0L	BMW X3
	2001-2006	L6-3.0L	BMW X5
	2001-2002	L6-3.0L	BMW Z3
	2003-2005	L6-3.0L	BMW Z4
	1996-1999	L6-3.2L	BMW M3
	1998-2000	L6-3.2L	BMW Z3
US9262	2001-2003	L5-2.5L	VOLKSWAGEN EUROVAN (MEX)
	2002-2008	V6-2.8L	SEAT ALHAMBRA (MEX)
	1997	V6-2.8L	VOLKSWAGEN COMBI (MEX)
	1992-1994	V6-2.8L	VOLKSWAGEN CORRADO
	1997-2002	V6-2.8L	VOLKSWAGEN EUROVAN
	1995-2002	V6-2.8L	VOLKSWAGEN GOLF
	1994-2002	V6-2.8L	VOLKSWAGEN JETTA
	1993-1997	V6-2.8L	VOLKSWAGEN PASSAT
	1997	V6-2.8L	VOLKSWAGEN PASSAT (MEX)
US9263	1993-1995	V6-2.8L	AUDI 90
	1992-1994	V6-2.8L	AUDI 100
	1992-1994	V6-2.8L	AUDI 100 QUATTRO
	1993-1994	V6-2.8L	AUDI 90 QUATTRO
	1995	V6-2.8L	AUDI A6
	1995	V6-2.8L	AUDI A6 QUATTRO
	1994-1995	V6-2.8L	AUDI CABRIOLET
US9264	1990-1998	L4-2.3L	SAAB 9000
US9268	1993-1997	V6-3.0L	INFINITI J30
US9269	1996-1997	L6-4.5L	LEXUS LX450
	1993-1997	L6-4.5L	TOYOTA LAND CRUISER
US9270	1993-2001	L4-2.4L	NISSAN ALTIMA
US9271	1993-1997	L4-1.6L	GEO PRIZM
	1993-1997	L4-1.6L	TOYOTA COROLLA
US9272	1993-1997	L4-1.8L	GEO PRIZM
	1994-1997	L4-1.8L	TOYOTA CELICA
	1993-1997	L4-1.8L	TOYOTA COROLLA
US9273	1993-2001	L4-2.2L	HONDA PRELUDE

USMW	Years	Cyl.	Specifications
US9274	1993-1995	L5-2.5L	VOLKSWAGEN EUROVAN
	2004	L5-2.5L	VOLKSWAGEN EUROVAN (MEX)
US9275	1991-1995	L4-1.8L	BMW 318I
	1997	L4-1.8L	BMW 318I (MEX)
	1991-1995	L4-1.8L	BMW 318IS
	1995	L4-1.8L	BMW 318TI
	1997	L4-1.8L	BMW 325 (MEX)
	1995-1996	L4-1.8L	BMW 325I (MEX)
	1996-1998	L4-1.9L	BMW 318I
	1996-1997	L4-1.9L	BMW 318IS
	1996-1999	L4-1.9L	BMW 318TI
	1996-1998	L4-1.9L	BMW Z3
	1999	L4-1.9L	BMW Z3 (MEX)
	1993-1994	L6-3.4L	BMW M5 (MEX)
US9276	1994-1995	V8-3.0L	BMW 530I
	1994-1995	V8-4.0L	BMW 540I
	1993-1994	V8-4.0L	BMW 740I
	1993-1994	V8-4.0L	BMW 740IL
US9277	2003	V12-5.8L	MERCEDES-BENZ CL600 (MEX)
	1996-1997	V12-6.0L	MERCEDES-BENZ 600CL (MEX)
	1993	V12-6.0L	MERCEDES-BENZ 600SEC
	1994-1997	V12-6.0L	MERCEDES-BENZ 600SEC (MEX)
	1992-1993	V12-6.0L	MERCEDES-BENZ 600SEL
	1991-1997	V12-6.0L	MERCEDES-BENZ 600SEL (MEX)
	1993	V12-6.0L	MERCEDES-BENZ 600SL
	1998-1999	V12-6.0L	MERCEDES-BENZ CL600
	1994-1999	V12-6.0L	MERCEDES-BENZ S600
	1994-2002	V12-6.0L	MERCEDES-BENZ SL600
US9278	1996-1997	V6-3.2L	ACURA SLX
	1994-1997	V6-3.2L	HONDA PASSPORT
	1993-1997	V6-3.2L	ISUZU RODEO
	1992-1997	V6-3.2L	ISUZU TROOPER
US9279	1992-1994	L5-2.2L	AUDI S4
	1995	L5-2.2L	AUDI S6
US9280	1993-1994	L6-4.0L	JAGUAR VANDEN PLAS
	1993-1994	L6-4.0L	JAGUAR XJ6
	1993-1994	L6-4.0L	JAGUAR XJS
US9281	1966-1972	L4-1.1L	RENAULT R10 (MEX)
	1965-1975	L4-1.1L	RENAULT R8S (MEX)
US9282	1967-1972	L4-1.3L	RENAULT R10 (MEX)
	1971-1983	L4-1.3L	RENAULT R12 (MEX)
	1979-1984	L4-1.3L	RENAULT R12 TL (MEX)
	1979-1984	L4-1.3L	RENAULT R5 (MEX)
	1978	L4-1.3L	RENAULT R5 L (MEX)
	1977-1983	L4-1.3L	RENAULT R5 LS (MEX)
	1968-1975	L4-1.3L	RENAULT R8S (MEX)
US9284	1985	L4-1.5L	NISSAN TSURU (MEX)
	1987-1992	L4-1.6L	NISSAN HIKARI (MEX)
	1986-1987	L4-1.6L	NISSAN TSURU (MEX)
US9288	1993-1995	V6-3.2L	ACURA LEGEND
US9289	1994-2001	L4-1.8L	ACURA INTEGRA
US9291	1993-1995	V6-3.0L	TOYOTA PICKUP
	1993-1994	V6-3.0L	TOYOTA T100
US9292	2000	L6-3.0L	LEXUS SC300
	1993-1998	L6-3.0L	TOYOTA SUPRA
US9293	1995-2004	L4-2.4L	TOYOTA TACOMA
	1996-2010	L4-2.7L	TOYOTA 4RUNNER
	2006-2011	L4-2.7L	TOYOTA HIACE (MEX)
	2004-2010	L4-2.7L	TOYOTA HILUX (MEX)
	1994-1998	L4-2.7L	TOYOTA T100
	1995-2012	L4-2.7L	TOYOTA TACOMA
US9295	1975-1976	L4-1.6L	MAZDA 808
	1975-1976	L4-1.6L	MAZDA B1600
US9296	1975-1985	L4-2.0L	TOYOTA PICKUP
US9300	1977	L4-1.6L	MAZDA 808
US9302	1987	V6-3.9L	ISUZU PICKUP
US9304	1993-1996	V8-4.5L	INFINITI Q45
US9305	2001-2002	L4-1.5L	KIA RIO
	1995	L4-1.5L	MAZDA PROTEGE

USMW	Years	Cyl.	Specifications
	2003-2005	L4-1.6L	KIA RIO
	1995-1997	L4-1.6L	KIA SEPHIA
	1994-1995	L4-1.6L	MAZDA MX-3
	1999-2001	L4-1.6L	MAZDA PROTEGE
	1995-1997	L4-1.8L	KIA SEPHIA
	1994-2005	L4-1.8L	MAZDA MIATA
	1995-1998	L4-1.8L	MAZDA PROTEGE
<b>US9306</b>	1994-2003	V6-3.0L	LEXUS ES300
	1999-2003	V6-3.0L	LEXUS RX300
	1995-2004	V6-3.0L	TOYOTA AVALON
	1994-2006	V6-3.0L	TOYOTA CAMRY
	2001-2003	V6-3.0L	TOYOTA HIGHLANDER
	1998-2003	V6-3.0L	TOYOTA SIENNA
	1999-2003	V6-3.0L	TOYOTA SOLARA
	2004-2006	V6-3.3L	LEXUS ES330
	2004-2006	V6-3.3L	LEXUS RX330
	2006-2008	V6-3.3L	LEXUS RX400H
	2004-2006	V6-3.3L	TOYOTA CAMRY
	2004-2010	V6-3.3L	TOYOTA HIGHLANDER
	2004-2006	V6-3.3L	TOYOTA SIENNA
	2007	V6-3.3L	TOYOTA SIENNA (MEX)
	2004-2008	V6-3.3L	TOYOTA SOLARA
<b>US9307</b>	1994-1998	L4-2.0L	SAAB 900
	1999-2003	L4-2.0L	SAAB 41885
	1994-1998	L4-2.3L	SAAB 900
	1999-2002	L4-2.3L	SAAB 41885
	1999-2009	L4-2.3L	SAAB 41887
<b>US9309</b>	1997	L6-3.0L	NISSAN CEFIRO (MEX)
	1996-2001	V6-3.0L	INFINITI I30
	1995-2001	V6-3.0L	NISSAN MAXIMA
	2001-2003	V6-3.5L	INFINITI QX4
	2001-2004	V6-3.5L	NISSAN PATHFINDER
<b>US9310</b>	1994-1996	V6-3.5L	MITSUBISHI MONTERO
<b>US9311</b>	1996-1997	L6-3.6L	MERCEDES-BENZ C36 AMG
<b>US9313</b>	1993	L6-2.8L	MERCEDES-BENZ 280E (MEX)
	1993	L6-2.8L	MERCEDES-BENZ 300E
	1994-1995	L6-2.8L	MERCEDES-BENZ C280
	1993	L6-3.2L	MERCEDES-BENZ 300CE
	1993	L6-3.2L	MERCEDES-BENZ 300E
	1993	L6-3.2L	MERCEDES-BENZ 300TE
	1994-1995	L6-3.2L	MERCEDES-BENZ E320
	1994-1996	L6-3.2L	MERCEDES-BENZ SL320
<b>US9314</b>	1994	L4-2.2L	MERCEDES-BENZ 220E (MEX)
	1999-2000	L4-2.3L	MERCEDES-BENZ C230
	1996-1997	L4-2.3L	MERCEDES-BENZ SLK (MEX)
<b>US9315</b>	1992-1993	V8-4.2L	MERCEDES-BENZ 400E
	1992	V8-4.2L	MERCEDES-BENZ 400SE
	1993	V8-4.2L	MERCEDES-BENZ 400SEL
	1994-1995	V8-4.2L	MERCEDES-BENZ E420
	1994-1995	V8-4.2L	MERCEDES-BENZ S420
	1992-1993	V8-5.0L	MERCEDES-BENZ 500E
	1993	V8-5.0L	MERCEDES-BENZ 500SEC
	1992-1993	V8-5.0L	MERCEDES-BENZ 500SEL
	1990-1993	V8-5.0L	MERCEDES-BENZ 500SL
	1994	V8-5.0L	MERCEDES-BENZ E500
	1994-1995	V8-5.0L	MERCEDES-BENZ S500
	1994-1996	V8-5.0L	MERCEDES-BENZ SL500
<b>US9318</b>	1992-1994	V6-1.8L	MAZDA MX-3
	1995-1997	V6-2.5L	FORD PROBE
	1993-2002	V6-2.5L	MAZDA 626
	1995-2002	V6-2.5L	MAZDA MILLENNIA
	1993-1997	V6-2.5L	MAZDA MX-6
<b>US9320</b>	1993-1995	V6-3.0L	TOYOTA 4RUNNER
	1993-1995	V6-3.0L	TOYOTA PICKUP
	1993-1994	V6-3.0L	TOYOTA T100
<b>US9321</b>	1994-1995	L4-1.6L	HONDA CIVIC DEL SOL
	1992-1993	L4-1.7L	ACURA INTEGRA
<b>US9324</b>	1996-2002	V6-3.4L	TOYOTA 4RUNNER
	1995-1998	V6-3.4L	TOYOTA T100

USMW	Years	Cyl.	Specifications
	1995-2004	V6-3.4L	TOYOTA TACOMA
	2000-2004	V6-3.4L	TOYOTA TUNDRA
<b>US9325</b>	1995-1998	V6-3.4L	TOYOTA T100
	1995-2000	V6-3.4L	TOYOTA TACOMA
	2000-2004	V6-3.4L	TOYOTA TUNDRA
<b>US9327</b>	1977-1979	L6-4.2L	TOYOTA LAND CRUISER
<b>US9328</b>	1995-2002	V6-2.3L	MAZDA MILLENNIA
<b>US9332</b>	1996	V8-4.0L	BMW 540I (MEX)
	1995	V8-4.0L	BMW 740I
	1995	V8-4.0L	BMW 740IL
	1994-1995	V8-4.0L	BMW 840CI
<b>US9333</b>	1995	V6-2.8L	AUDI 90
	1996-1997	V6-2.8L	AUDI 90 (MEX)
	1995	V6-2.8L	AUDI 90 QUATTRO
	1996-2001	V6-2.8L	AUDI A4
	1996-2001	V6-2.8L	AUDI A4 QUATTRO
	1995-2001	V6-2.8L	AUDI A6
	1995-2001	V6-2.8L	AUDI A6 QUATTRO
	1995-1998	V6-2.8L	AUDI CABRIOLET
	2000	V6-2.8L	AUDI S4 QUATTRO (MEX)
	1998-2005	V6-2.8L	VOLKSWAGEN PASSAT
<b>US9334</b>	1997-1998	L4-1.5L	TOYOTA TERCEL
<b>US9335</b>	1998	L4-1.9L	VOLKSWAGEN PASSAT
<b>US9337</b>	1981-1987	L6-4.2L	TOYOTA LAND CRUISER
<b>US9338</b>	1997-2000	V6-3.3L	INFINITI QX4
	1999-2004	V6-3.3L	NISSAN FRONTIER
	1996-2000	V6-3.3L	NISSAN PATHFINDER
	2000-2004	V6-3.3L	NISSAN XTERRA
<b>US9339</b>	2000-2004	L4-1.9L	VOLVO S40
	1999	L4-1.9L	VOLVO S40 (MEX)
	2000-2004	L4-1.9L	VOLVO V40
	1999	L4-1.9L	VOLVO V40 (MEX)
	1994-1997	L5-2.3L	VOLVO 850
	1998-2004	L5-2.3L	VOLVO C70
	2001-2004	L5-2.3L	VOLVO S60
	1998-2000	L5-2.3L	VOLVO S70
	1998-2000	L5-2.3L	VOLVO V70
	1993-1997	L5-2.4L	VOLVO 850
	2008-2009	L5-2.4L	VOLVO C30 (MEX)
	1998-2002	L5-2.4L	VOLVO C70
	2004-2010	L5-2.4L	VOLVO S40
	2001-2009	L5-2.4L	VOLVO S60
	1998-2000	L5-2.4L	VOLVO S70
	2005-2011	L5-2.4L	VOLVO V50
	1998-2007	L5-2.4L	VOLVO V70
	2007-2011	L5-2.5L	FORD FOCUS (MEX)
	2008-2012	L5-2.5L	VOLVO C30
	2006-2012	L5-2.5L	VOLVO C70
	2005-2011	L5-2.5L	VOLVO S40
	2003-2012	L5-2.5L	VOLVO S60
	2004-2006	L5-2.5L	VOLVO S80
	2003-2007	L5-2.5L	VOLVO V70
	2003-2007	L5-2.5L	VOLVO XC70
	2003-2006	L5-2.5L	VOLVO XC90
	2007	L5-2.5L	VOLVO XC90 (MEX)
	2007	L5-2.5L	VOLVO XC90 AWD (MEX)
	2004-2006	L6-2.8L	VOLVO S80 (MEX)
	2003-2006	L6-2.8L	VOLVO XC90 AWD (MEX)
	1992-1994	L6-2.9L	VOLVO 960
	2007-2010	V8-4.4L	VOLVO S80
	2005-2011	V8-4.4L	VOLVO XC90
<b>US9340</b>	1995-1997	L6-2.9L	VOLVO 960
	1997-1998	L6-2.9L	VOLVO S90
	1997-1998	L6-2.9L	VOLVO V90
<b>US9342</b>	1999-2002	L4-1.8L	SUZUKI ESTEEM
	1996-1998	L4-1.8L	SUZUKI SIDEKICK
	1999-2003	L4-2.0L	CHEVROLET TRACKER
	2005-2008	L4-2.0L	CHEVROLET TRACKER (MEX)
	2002-2003	L4-2.0L	SUZUKI AERIO

**WATER PUMPS**



USMW	Years	Cyl.	Specifications
	2007-2009	L4-2.0L	SUZUKI SX4
	1999-2003	L4-2.0L	SUZUKI VITARA
	2004-2007	L4-2.3L	SUZUKI AERIO
<b>US9343</b>	1992-1993	L6-3.2L	MERCEDES-BENZ 300SE
	1994-1996	L6-3.2L	MERCEDES-BENZ S320
<b>US9344</b>	1996-1997	L6-2.8L	MERCEDES-BENZ C280
	1999	L6-2.8L	MERCEDES-BENZ E280 (MEX)
	1996-1997	L6-3.2L	MERCEDES-BENZ E320
	1997	L6-3.2L	MERCEDES-BENZ SL320
<b>US9345</b>	1995	L6-2.8L	MERCEDES-BENZ C280
	1993	L6-3.2L	MERCEDES-BENZ 300CE
	1993	L6-3.2L	MERCEDES-BENZ 300E
	1993	L6-3.2L	MERCEDES-BENZ 300TE
	1994-1995	L6-3.2L	MERCEDES-BENZ E320
	1994-1996	L6-3.2L	MERCEDES-BENZ SL320
	1995	L6-3.6L	MERCEDES-BENZ C36 AMG
<b>US9346</b>	1992-1993	V8-4.2L	MERCEDES-BENZ 400E
	1992	V8-4.2L	MERCEDES-BENZ 400SE
	1993	V8-4.2L	MERCEDES-BENZ 400SEL
	1994-1997	V8-4.2L	MERCEDES-BENZ E420
	1994-1999	V8-4.2L	MERCEDES-BENZ S420
	1992-1993	V8-5.0L	MERCEDES-BENZ 500E
	1993	V8-5.0L	MERCEDES-BENZ 500SEC
	1992-1993	V8-5.0L	MERCEDES-BENZ 500SEL
	1993	V8-5.0L	MERCEDES-BENZ 500SL
	1998-1999	V8-5.0L	MERCEDES-BENZ CL500
	1994	V8-5.0L	MERCEDES-BENZ E500
	1994-1999	V8-5.0L	MERCEDES-BENZ S500
	1994-1999	V8-5.0L	MERCEDES-BENZ SL500
<b>US9347</b>	1996-1998	L5-2.5L	ACURA TL
<b>US9348</b>	1996-1998	V6-3.2L	ACURA TL
<b>US9349</b>	1996-2001	L4-1.8L	ACURA INTEGRA
	1997-2001	L4-2.0L	HONDA CR-V
<b>US9351</b>	1997-1999	L6-3.2L	MERCEDES-BENZ S320
<b>US9352</b>	1996-2000	L4-1.6L	HONDA CIVIC
	1996-1997	L4-1.6L	HONDA CIVIC DEL SOL
<b>US9353</b>	1996-1998	L4-1.8L	HYUNDAI ELANTRA
	1997	L4-1.8L	HYUNDAI TIBURON
	1999-2012	L4-2.0L	HYUNDAI ELANTRA
	1997-2008	L4-2.0L	HYUNDAI TIBURON
	2005-2009	L4-2.0L	HYUNDAI TUCSON
	2010-2011	L4-2.0L	KIA SOUL
	2004-2009	L4-2.0L	KIA SPECTRA
	2005-2009	L4-2.0L	KIA SPECTRA5
	2005-2010	L4-2.0L	KIA SPORTAGE
<b>US9354</b>	1996-2004	V6-3.5L	ACURA RL
<b>US9356</b>	1995-1997	L6-4.0L	JAGUAR VANDEN PLAS
	1995-1997	L6-4.0L	JAGUAR XJ6
	1995-1997	L6-4.0L	JAGUAR XJR
	1993-1996	L6-4.0L	JAGUAR XJS
<b>US9359</b>	1997-2002	L4-1.5L	MINI COOPER
<b>US9360</b>	1997-2002	L4-1.8L	MINI COOPER
	2003-2004	L4-1.8L	MINI COOPER S
	2002-2007	L4-2.0L	MINI COOPER R
<b>US9362</b>	1997-1999	V8-3.7L	AUDI A8
	2000	V8-3.7L	AUDI A8 QUATTRO (MEX)
	1996-1999	V8-4.2L	AUDI A8 (MEX)
	1997-1999	V8-4.2L	AUDI A8 QUATTRO
<b>US9364</b>	1996-1997	L4-1.5L	HYUNDAI ACCENT
	2006-2009	L4-1.6L	DODGE ATTITUDE (MEX)
	2010	L4-1.6L	DODGE ATTITUDE GL (MEX)
	2004-2006	L4-1.6L	DODGE VERNA (MEX)
	2002-2011	L4-1.6L	HYUNDAI ACCENT
	2006-2011	L4-1.6L	KIA RIO
	2006-2012	L4-1.6L	KIA RIO5
<b>US9365</b>	1998-2002	V6-3.2L	HONDA PASSPORT
	1998-2000	V6-3.2L	ISUZU AMIGO
	1998-2004	V6-3.2L	ISUZU RODEO
	2001-2003	V6-3.2L	ISUZU RODEO SPORT

USMW	Years	Cyl.	Specifications
	1998-1999	V6-3.5L	ACURA SLX
	2002-2004	V6-3.5L	ISUZU AXIOM
	2004	V6-3.5L	ISUZU RODEO
	1998-2002	V6-3.5L	ISUZU TROOPER
	1999-2001	V6-3.5L	ISUZU VEHICROSS
<b>US9367</b>	1995-1998	L4-1.5L	TOYOTA PASEO
	1994-1998	L4-1.5L	TOYOTA TERCEL
<b>US9368</b>	1987-1988	V8-3.5L	LAND ROVER RANGE ROVER
	1993	V8-3.9L	LAND ROVER DEFENDER 110
	1994-1995	V8-3.9L	LAND ROVER DEFENDER 90
	1989-1995	V8-3.9L	LAND ROVER RANGE ROVER
	1993-1995	V8-4.2L	LAND ROVER RANGE ROVER
<b>US9369</b>	1994-1995	V8-3.9L	LAND ROVER DISCOVERY
	1993-1995	V8-3.9L	LAND ROVER RANGE ROVER
	1997	V8-4.0L	LAND ROVER DEFENDER 90
	1996-2002	V8-4.0L	LAND ROVER DISCOVERY
	1995-2000	V8-4.0L	LAND ROVER RANGE ROVER
	1995	V8-4.2L	LAND ROVER RANGE ROVER
	2003-2004	V8-4.6L	LAND ROVER DISCOVERY
	1996-2000	V8-4.6L	LAND ROVER RANGE ROVER
<b>US9371</b>	1996-1998	L4-1.5L	MAZDA PROTEGE
<b>US9374</b>	2007-2009	L4-1.5L	SUZUKI SWIFT (MEX)
	1999-2000	L4-1.6L	CHEVROLET TRACKER
	1997-2000	L4-1.6L	SUZUKI ESTEEM
	1999-2001	L4-1.6L	SUZUKI VITARA
<b>US9375</b>	1998-2000	L4-2.2L	ISUZU AMIGO
	1998-2003	L4-2.2L	ISUZU RODEO
	2001-2003	L4-2.2L	ISUZU RODEO SPORT
<b>US9376</b>	1998-2002	L4-1.8L	CHEVROLET PRIZM
	2003-2008	L4-1.8L	PONTIAC VIBE
	2000-2005	L4-1.8L	TOYOTA CELICA
	1998-2008	L4-1.8L	TOYOTA COROLLA
	2003-2008	L4-1.8L	TOYOTA MATRIX
	2006	L4-1.8L	TOYOTA MR2 (MEX)
	2000-2005	L4-1.8L	TOYOTA MR2 SPYDER
<b>US9377</b>	1999-2009	L4-1.8L	AUDI A3 (MEX)
	2001-2006	L4-1.8L	AUDI A4
	2007-2009	L4-1.8L	AUDI A4 (MEX)
	2001-2005	L4-1.8L	AUDI A4 QUATTRO
	2000-2004	L4-1.8L	AUDI S3 QUATTRO (MEX)
	2000-2006	L4-1.8L	AUDI TT
	2000-2006	L4-1.8L	AUDI TT QUATTRO
	2002-2007	L4-1.8L	SEAT ALHAMBRA (MEX)
	2005-2008	L4-1.8L	SEAT IBIZA (MEX)
	2001-2009	L4-1.8L	SEAT LEON (MEX)
	2001-2005	L4-1.8L	SEAT TOLEDO (MEX)
	1999-2005	L4-1.8L	VOLKSWAGEN BEETLE
	1999-2006	L4-1.8L	VOLKSWAGEN GOLF
	2000-2005	L4-1.8L	VOLKSWAGEN JETTA
	2009	L4-1.8L	VOLKSWAGEN JETTA (MEX)
	2000-2005	L4-1.8L	VOLKSWAGEN PASSAT
	2003-2009	L4-1.8L	VOLKSWAGEN POINTER P/U (MEX)
	2005-2008	L4-1.8L	VOLKSWAGEN SHARAN (MEX)
	2004-2007	L4-2.0L	AUDI A3 (MEX)
	2008-2011	L4-2.0L	AUDI S3 QUATTRO (MEX)
	2007-2010	L4-2.0L	AUDI TT (MEX)
	2005-2009	L4-2.0L	SEAT ALTEA (MEX)
	2003-2009	L4-2.0L	SEAT CORDOBA (MEX)
	2003-2009	L4-2.0L	SEAT IBIZA (MEX)
	2006-2009	L4-2.0L	SEAT LEON (MEX)
	2006	L4-2.0L	SEAT TOLEDO (MEX)
	1998-2005	L4-2.0L	VOLKSWAGEN BEETLE
	2006-2010	L4-2.0L	VOLKSWAGEN BEETLE (MEX)
	2006	L4-2.0L	VOLKSWAGEN BORA (MEX)
	2001-2004	L4-2.0L	VOLKSWAGEN DERBY (MEX)
	2007	L4-2.0L	VOLKSWAGEN GLI (MEX)
	1999-2006	L4-2.0L	VOLKSWAGEN GOLF
	2007	L4-2.0L	VOLKSWAGEN GOLF (MEX)
	2001-2003	L4-2.0L	VOLKSWAGEN GOLF GTI (MEX)

USMW	Years	Cyl.	Specifications
	1999-2013	L4-2.0L	VOLKSWAGEN JETTA
	2006-2013	L4-2.0L	VOLKSWAGEN JETTA (MEX)
	2000-2004	L4-2.0L	VOLKSWAGEN POINTER GTI (MEX)
	2003-2007	L4-2.0L	VOLKSWAGEN POLO (MEX)
<b>US9378</b>	2001-2009	L4-1.6L	SEAT CORDOBA (MEX)
	2001-2009	L4-1.6L	SEAT IBIZA (MEX)
	1999-2004	L4-1.9L	VOLKSWAGEN BEETLE
	2007-2009	L4-1.9L	VOLKSWAGEN BORA (MEX)
	2006-2009	L4-1.9L	VOLKSWAGEN EUROVAN (MEX)
	1999-2006	L4-1.9L	VOLKSWAGEN GOLF
	1999-2005	L4-1.9L	VOLKSWAGEN JETTA
	2007-2010	L4-1.9L	VOLKSWAGEN JETTA (MEX)
	2005	L4-1.9L	VOLKSWAGEN PASSAT
	1997	L5-2.0L	AUDI A3 (MEX)
<b>US9379</b>	2001-2005	V6-2.6L	MERCEDES-BENZ C240
	1998-2000	V6-2.8L	MERCEDES-BENZ C280
	2004-2008	V6-3.2L	CHRYSLER CROSSFIRE
	2001-2005	V6-3.2L	MERCEDES-BENZ C320
	1998-2005	V6-3.2L	MERCEDES-BENZ CLK320
	1998-2005	V6-3.2L	MERCEDES-BENZ E320
	1998-2003	V6-3.2L	MERCEDES-BENZ ML320
	2001-2004	V6-3.2L	MERCEDES-BENZ SLK320
	2003-2005	V6-3.7L	MERCEDES-BENZ ML350
	2006	V6-3.7L	MERCEDES-BENZ S350
	1998-2000	V8-4.3L	MERCEDES-BENZ C43 AMG
	1999-2003	V8-4.3L	MERCEDES-BENZ CLK430
	1998-2002	V8-4.3L	MERCEDES-BENZ E430
	2000-2006	V8-4.3L	MERCEDES-BENZ S430
	1998-1999	V8-4.3L	MERCEDES-BENZ S430 (MEX)
	2000-2006	V8-5.0L	MERCEDES-BENZ CL500
	2003-2006	V8-5.0L	MERCEDES-BENZ CLK500
	2007-2009	V8-5.0L	MERCEDES-BENZ CLK500 (MEX)
	2006	V8-5.0L	MERCEDES-BENZ CLS500
	2007	V8-5.0L	MERCEDES-BENZ CLS500 (MEX)
	2003-2006	V8-5.0L	MERCEDES-BENZ E500
	2002-2008	V8-5.0L	MERCEDES-BENZ G500
	2000	V8-5.0L	MERCEDES-BENZ G500L (MEX)
	2008	V8-5.0L	MERCEDES-BENZ ML500 4WD (MEX)
	2006-2007	V8-5.0L	MERCEDES-BENZ R500
	2000-2006	V8-5.0L	MERCEDES-BENZ S500
	2000-2006	V8-5.0L	MERCEDES-BENZ SL500
<b>US9380</b>	2008-2009	V12-5.5L	MERCEDES-BENZ S600L (MEX)
	1998-2002	V6-3.2L	MERCEDES-BENZ CLK320
	1998-2005	V6-3.2L	MERCEDES-BENZ E320
	2001-2003	V6-3.2L	MERCEDES-BENZ SLK320
	1999-2001	V8-4.3L	MERCEDES-BENZ ML430
	2002-2008	V8-5.0L	MERCEDES-BENZ G500
	2001	V8-5.0L	MERCEDES-BENZ G500L (MEX)
	2002-2007	V8-5.0L	MERCEDES-BENZ ML500
	2005-2006	V8-5.5L	MERCEDES-BENZ C55 AMG
	2007	V8-5.5L	MERCEDES-BENZ C55 AMG (MEX)
	2008-2010	V8-5.5L	MERCEDES-BENZ CL500 (MEX)
	2001-2002	V8-5.5L	MERCEDES-BENZ CL55 AMG
	2001-2006	V8-5.5L	MERCEDES-BENZ CLK55 AMG
	2008-2011	V8-5.5L	MERCEDES-BENZ CLS500 (MEX)
	2008-2011	V8-5.5L	MERCEDES-BENZ E500 (MEX)
	1999-2002	V8-5.5L	MERCEDES-BENZ E55 AMG
	2003-2004	V8-5.5L	MERCEDES-BENZ G55 AMG
	2008-2011	V8-5.5L	MERCEDES-BENZ GL500 (MEX)
	2000-2003	V8-5.5L	MERCEDES-BENZ ML55 AMG
	2007-2011	V8-5.5L	MERCEDES-BENZ S500L (MEX)
	2001-2002	V8-5.5L	MERCEDES-BENZ S55 AMG
	2008-2011	V8-5.5L	MERCEDES-BENZ SL500 (MEX)
<b>US9382</b>	1999-2001	L6-2.8L	VOLVO S80
	1999-2002	L6-2.9L	VOLVO S80
<b>US9383</b>	1997-1999	V6-3.0L	ACURA CL
	1998-2002	V6-3.0L	HONDA ACCORD
	2001-2003	V6-3.2L	ACURA CL
	1999-2003	V6-3.2L	ACURA TL

USMW	Years	Cyl.	Specifications
	2001-2002	V6-3.5L	ACURA MDX
	1999-2004	V6-3.5L	HONDA ODYSSEY
	2003-2004	V6-3.5L	HONDA PILOT
<b>US9385</b>	2001-2004	V6-2.5L	CHEVROLET TRACKER
	1999-2005	V6-2.5L	SUZUKI GRAND VITARA
	2004	V6-2.5L	SUZUKI VITARA
	2001-2008	V6-2.7L	SUZUKI GRAND VITARA
	2002-2006	V6-2.7L	SUZUKI XL-7
<b>US9388</b>	1997-2001	V8-4.1L	INFINITI Q45
<b>US9389</b>	1997-1999	L4-2.4L	MINI COOPER
<b>US9393</b>	1998-2001	L4-1.8L	KIA SEPHIA
	2000-2004	L4-1.8L	KIA SPECTRA
<b>US9394</b>	1996-1998	V6-3.0L	MAZDA MPV
<b>US9395</b>	1998-2004	L6-3.0L	LEXUS GS300
	2001-2005	L6-3.0L	LEXUS IS300
<b>US9396</b>	1981-1986	V6-2.5L	ALFA ROMEO GTV-6
	1987-1989	V6-2.5L	ALFA ROMEO MILANO
	1988-1989	V6-3.0L	ALFA ROMEO MILANO
<b>US9399</b>	2001-2005	L4-2.4L	CHRYSLER SEBRING
	2001-2005	L4-2.4L	DODGE STRATUS
	2001-2004	L4-2.4L	HYUNDAI SANTA FE
	1999-2005	L4-2.4L	HYUNDAI SONATA
	2003-2006	L4-2.4L	KIA OPTIMA
	2000-2005	L4-2.4L	MINI COOPER
	1999-2003	L4-2.4L	MINI COOPER
	2007-2009	L4-2.4L	MINI COOPER
	2008-2012	L4-2.4L	MINI COOPER
<b>US9400</b>	1991-1994	L4-2.0L	ALFA ROMEO SPIDER
<b>US9401</b>	1997	L4-1.8L	AUDI A3 (MEX)
	1997-2000	L4-1.8L	AUDI A4
	1995-1996	L4-1.8L	AUDI A4 (MEX)
	1997-2000	L4-1.8L	AUDI A4 QUATTRO
	1998-2001	L4-1.8L	VOLKSWAGEN PASSAT
<b>US9402</b>	1999-2002	V6-3.3L	MERCUY VILLAGER
	1999-2002	V6-3.3L	NISSAN QUEST
<b>US9403</b>	2000-2003	L4-2.0L	HONDA S2000
	2004-2009	L4-2.2L	HONDA S2000
<b>US9405</b>	2003-2006	L4-1.8L	PONTIAC VIBE
	2000-2005	L4-1.8L	TOYOTA CELICA
	2005-2006	L4-1.8L	TOYOTA COROLLA
	2003-2006	L4-1.8L	TOYOTA MATRIX
<b>US9406</b>	2004-2005	L4-1.3L	TOYOTA YARIS (MEX)
	2004-2006	L4-1.5L	SCION XA
	2004-2006	L4-1.5L	SCION XB
	2007-2011	L4-1.5L	TOYOTA AVANZA (MEX)
	2000-2005	L4-1.5L	TOYOTA ECHO
	2001-2009	L4-1.5L	TOYOTA PRIUS
	2007-2013	L4-1.5L	TOYOTA YARIS
	2006	L4-1.5L	TOYOTA YARIS (MEX)
	2011	L4-1.5L	TOYOTA YARIS CORE (MEX)
	2011	L4-1.5L	TOYOTA YARIS PREMIUM (MEX)
<b>US9410</b>	2007-2011	V10-5.2L	AUDI S6
	2007-2009	V10-5.2L	AUDI S8
	2000-2011	V8-4.2L	AUDI A6 QUATTRO
	2000-2012	V8-4.2L	AUDI A8 QUATTRO
	2007-2009	V8-4.2L	AUDI Q7
	2008-2009	V8-4.2L	AUDI Q7 AWD (MEX)
	2007-2008	V8-4.2L	AUDI RS4
	2003	V8-4.2L	AUDI RS6
	2004	V8-4.2L	AUDI RS6 QUATTRO (MEX)
	2008-2012	V8-4.2L	AUDI S5
	2002-2003	V8-4.2L	AUDI S6
	2001-2004	V8-4.2L	AUDI S6 QUATTRO (MEX)
	2001-2003	V8-4.2L	AUDI S8
	2004-2006	V8-4.2L	VOLKSWAGEN PHAETON
	2004-2009	V8-4.2L	VOLKSWAGEN TIGUAN
<b>US9414</b>	2001-2003	L4-2.0L	TOYOTA RAV4
	2010-2012	L4-2.4L	LEXUS HS250H
	2009-2010	L4-2.4L	PONTIAC VIBE

**WATER PUMPS**

USMW	Years	Cyl.	Specifications
	2005-2010	L4-2.4L	SCION TC
	2011-2012	L4-2.4L	SCION XB
	2002-2011	L4-2.4L	TOYOTA CAMRY
	2009-2010	L4-2.4L	TOYOTA COROLLA
	2001-2007	L4-2.4L	TOYOTA HIGHLANDER
	2009-2013	L4-2.4L	TOYOTA MATRIX
	2004-2008	L4-2.4L	TOYOTA RAV4
	2002-2008	L4-2.4L	TOYOTA SOLARA
<b>US9415</b>	2001-2003	V6-3.5L	MINI COOPER
	2004-2006	V6-3.8L	MINI COOPER
<b>US9416</b>	2000-2005	L4-1.8L	NISSAN ALMERA (MEX)
	2000-2006	L4-1.8L	NISSAN SENTRA
<b>US9419</b>	2001-2005	L4-1.7L	HONDA CIVIC
<b>US9421</b>	2006-2007	H6-3.0L	SUBARU B9 TRIBECA
	2008-2009	H6-3.0L	SUBARU LEGACY
	2001-2010	H6-3.0L	SUBARU OUTBACK
	2010-2012	H6-3.6L	SUBARU LEGACY
	2010-2012	H6-3.6L	SUBARU OUTBACK
	2008-2012	H6-3.6L	SUBARU TRIBECA
<b>US9426</b>	2007-2008	L4-1.8L	NISSAN TIIDA (MEX)
	2006-2007	L4-2.4L	NISSAN FRONTIER PICKUP (MEX)
	2008-2012	V6-3.5L	INFINITI EX35
	2003-2012	V6-3.5L	INFINITI FX35
	2003-2008	V6-3.5L	INFINITI G35
	2002-2004	V6-3.5L	INFINITI I35
	2006-2010	V6-3.5L	INFINITI M35
	2012	V6-3.5L	INFINITI M35H
	2003-2009	V6-3.5L	NISSAN 350Z
	2002-2006	V6-3.5L	NISSAN ALTIMA
	2002-2008	V6-3.5L	NISSAN MAXIMA
	2003-2007	V6-3.5L	NISSAN MURANO
	2008	V6-3.5L	NISSAN MURANO (MEX)
	2008	V6-3.5L	NISSAN MURANO AWD (MEX)
	2004-2009	V6-3.5L	NISSAN QUEST
	2008-2012	V6-3.7L	INFINITI G37
	2011-2012	V6-3.7L	INFINITI M37
	2009-2012	V6-3.7L	NISSAN 370Z
	2009-2012	V6-3.8L	NISSAN GT-R
	2005-2012	V6-4.0L	NISSAN FRONTIER
	2012	V6-4.0L	NISSAN NV1500
	2012	V6-4.0L	NISSAN NV2500
	2012	V6-4.0L	NISSAN NV3500
	2005-2012	V6-4.0L	NISSAN PATHFINDER
	2005-2012	V6-4.0L	NISSAN XTERRA
	2009-2011	V6-4.0L	SUZUKI EQUATOR
<b>US9427</b>	2002-2012	L4-2.5L	NISSAN ALTIMA
	2010-2011	L4-2.5L	NISSAN ALTIMA SL (MEX)
	2008-2012	L4-2.5L	NISSAN ROGUE
	2011	L4-2.5L	NISSAN ROGUE SL (MEX)
	2011	L4-2.5L	NISSAN ROGUE SL AWD (MEX)
	2002-2012	L4-2.5L	NISSAN SENTRA
	2008-2009	L4-2.5L	NISSAN URVAN (MEX)
	2002-2009	L4-2.5L	NISSAN X-TRAIL (MEX)
	2010	L4-2.5L	NISSAN X-TRAIL 4WD (MEX)
	2010	L4-2.5L	NISSAN X-TRAIL LE (MEX)
	2010	L4-2.5L	NISSAN X-TRAIL SLX (MEX)
<b>US9429</b>	2002-2005	V6-3.0L	AUDI A4
	2002-2006	V6-3.0L	AUDI A4 QUATTRO
	2002-2004	V6-3.0L	AUDI A6
	2005-2006	V6-3.0L	AUDI A6 (MEX)
	2002-2004	V6-3.0L	AUDI A6 QUATTRO
	2005-2006	V6-3.0L	AUDI A6 QUATTRO (MEX)
<b>US9434</b>	2002-2006	L4-2.0L	ACURA RSX
	2002-2005	L4-2.0L	HONDA CIVIC
	2007	L4-2.4L	HONDA ACCORD
	2002-2006	L4-2.4L	HONDA CR-V
	2009-2012	V6-3.5L	ACURA TL
	2008-2012	V6-3.5L	HONDA ACCORD
	2010-2011	V6-3.5L	HONDA ACCORD CROSSTOUR

USMW	Years	Cyl.	Specifications
	2012	V6-3.5L	HONDA CROSSTOUR
	2010-2012	V6-3.7L	ACURA MDX
	2010-2012	V6-3.7L	ACURA ZDX
<b>US9440</b>	1994-1996	L4-2.2L	MERCEDES-BENZ C220
	1997-2002	L4-2.3L	MERCEDES-BENZ C230
	1998-2004	L4-2.3L	MERCEDES-BENZ SLK230
<b>US9446</b>	2000-2004	V6-2.7L	AUDI A6 QUATTRO
	2001-2005	V6-2.7L	AUDI ALLROAD QUATTRO
	2000-2002	V6-2.7L	AUDI S4
<b>US9448</b>	2003-2006	V6-3.5L	KIA SORENTO
<b>US9450</b>	1995-2002	L4-2.0L	KIA SPORTAGE
<b>US9456</b>	2003-2005	L6-2.9L	VOLVO S80
	2003-2005	L6-2.9L	VOLVO XC90
<b>US9460</b>	1995-1996	V6-3.0L	MINI COOPER
	1997-2004	V6-3.0L	MINI COOPER S
	1996-2000	V6-3.5L	MINI COOPER R
	1999-2004	V6-3.5L	MINI COOPER S R
<b>US9461</b>	2004-2008	L4-2.4L	ACURA TSX
	2003-2007	L4-2.4L	HONDA ACCORD
	2007-2009	L4-2.4L	HONDA CR-V
	2003-2011	L4-2.4L	HONDA ELEMENT
<b>US9462</b>	1999-2001	V6-2.5L	HYUNDAI SONATA
	2001-2006	V6-2.7L	HYUNDAI SANTA FE
	2002-2005	V6-2.7L	HYUNDAI SONATA
	2003-2008	V6-2.7L	HYUNDAI TIBURON
	2005-2009	V6-2.7L	HYUNDAI TUCSON
	2001-2006	V6-2.7L	KIA OPTIMA
	2005-2010	V6-2.7L	KIA SPORTAGE
<b>US9463</b>	2001	V6-3.0L	HYUNDAI XG300
	2003-2006	V6-3.5L	HYUNDAI SANTA FE
	2002-2005	V6-3.5L	HYUNDAI XG350
	2004-2006	V6-3.5L	KIA AMANTI
	2002-2005	V6-3.5L	KIA SEDONA
<b>US9464</b>	1995-1998	V12-5.4L	BMW 750IL
	1995-1997	V12-5.4L	BMW 850CI
	1998	V12-5.4L	BMW 850CI (MEX)
<b>US9465</b>	1999-2003	V8-4.4L	BMW 540I
	1999-2001	V8-4.4L	BMW 740I
	1999-2001	V8-4.4L	BMW 740IL
	2000-2003	V8-4.4L	BMW X5
	2002-2003	V8-4.6L	BMW X5
	2003	V8-4.8L	BMW Z8
<b>US9467</b>	1998-2001	V12-5.4L	BMW 750IL
<b>US9468</b>	1999-2000	L4-1.6L	HONDA CIVIC
	1996-1997	L4-1.6L	HONDA CIVIC DEL SOL
	1996-2001	L4-1.8L	ACURA INTEGRA
<b>US9469</b>	2008-2009	L6-2.8L	AUDI A6 (MEX)
<b>US9470</b>	2003-2007	V6-3.0L	HONDA ACCORD
	2004-2008	V6-3.2L	ACURA TL
	2003-2006	V6-3.5L	ACURA MDX
	2005-2008	V6-3.5L	ACURA RL
	2007-2008	V6-3.5L	ACURA TL
	2010-2012	V6-3.5L	ACURA TSX
	2008-2011	V6-3.5L	HONDA ACCORD
	2013	V6-3.5L	HONDA ACCORD EX (MEX)
	2005-2012	V6-3.5L	HONDA ODYSSEY
	2005-2012	V6-3.5L	HONDA PILOT
	2006-2012	V6-3.5L	HONDA RIDGELINE
	2004-2007	V6-3.5L	SATURN VUE
	2007-2009	V6-3.7L	ACURA MDX
	2009-2012	V6-3.7L	ACURA RL
<b>US9471</b>	2002-2003	V6-2.8L	VOLKSWAGEN EUROVAN
	2002-2005	V6-2.8L	VOLKSWAGEN GOLF
	2002-2004	V6-2.8L	VOLKSWAGEN JETTA
	2008	V6-3.0L	AUDI Q7 AWD (MEX)
	2006-2009	V6-3.2L	AUDI A3
	2004-2005	V6-3.2L	AUDI A3 QUATTRO (MEX)
	2008	V6-3.2L	AUDI A5 (MEX)
	2004	V6-3.2L	AUDI S3 QUATTRO (MEX)



USMW	Years	Cyl.	Specifications
	2004-2009	V6-3.2L	AUDI TT QUATTRO
	2007-2008	V6-3.2L	VOLKSWAGEN EOS
	2004	V6-3.2L	VOLKSWAGEN GOLF
	2008	V6-3.2L	VOLKSWAGEN R32
	2004-2006	V6-3.2L	VOLKSWAGEN TOUAREG
	2007	V6-3.2L	VOLKSWAGEN TOUAREG AWD (MEX)
<b>US9472</b>	2002-2005	H4-2.5L	SUBARU FORESTER
	2010-2012	H4-2.5L	SUBARU LEGACY
<b>US9473</b>	2001-2002	L4-1.5L	KIA RIO
	2003-2005	L4-1.6L	KIA RIO
<b>US9474</b>	2002-2006	L4-1.6L	MINI COOPER
<b>US9475</b>	1997-1999	H6-2.5L	PORSCHE BOXSTER
	2000	H6-2.5L	PORSCHE BOXSTER (MEX)
	2000-2008	H6-2.7L	PORSCHE BOXSTER
	2007-2008	H6-2.7L	PORSCHE CAYMAN
	2000-2006	H6-3.2L	PORSCHE BOXSTER
	1999-2001	H6-3.4L	PORSCHE 911
	2007-2008	H6-3.4L	PORSCHE BOXSTER
	2006-2008	H6-3.4L	PORSCHE CAYMAN
	2002-2008	H6-3.6L	PORSCHE 911
	2005-2008	H6-3.8L	PORSCHE 911
<b>US9476</b>	1990-1997	V8-4.0L	LEXUS LS400
	1992-1997	V8-4.0L	LEXUS SC400
<b>US9477</b>	2001-2002	L4-2.4L	KIA OPTIMA
<b>US9486</b>	1987-1994	L3-1.2L	SUBARU JUSTY
<b>US9488</b>	2009-2012	V8-5.0L	INFINITI FX50
	2011-2012	V8-5.6L	INFINITI M56
	2004-2012	V8-5.6L	INFINITI QX56
	2005-2012	V8-5.6L	NISSAN ARMADA
	2012	V8-5.6L	NISSAN NV2500
	2012	V8-5.6L	NISSAN NV3500
	2004-2012	V8-5.6L	NISSAN PATHFINDER
	2004-2012	V8-5.6L	NISSAN TITAN
<b>US9489</b>	2006-2008	V6-3.0L	FORD ESCAPE
	2006-2009	V6-3.0L	FORD FUSION
	2006	V6-3.0L	LINCOLN ZEPHYR
	2003-2008	V6-3.0L	MAZDA 6
	2006-2008	V6-3.0L	MERCURY MARINER
	2006-2009	V6-3.0L	MERCURY MILAN
<b>US9493</b>	1977-1979	L6-4.2L	TOYOTA LAND CRUISER
<b>US9494</b>	2000-2006	L3-1.0L	HONDA INSIGHT
<b>US9495</b>	2002-2006	L4-2.0L	ACURA RSX
	2006-2011	L4-2.0L	HONDA CIVIC

USMW	Years	Cyl.	Specifications
------	-------	------	----------------

<b>US61</b>	
FORD	3C3Z 8501-A
FORD	3C3Z 8501-ABRM
<b>US63</b>	
GENERAL MOTORS	19168888
GENERAL MOTORS	97216136
<b>US64</b>	
GENERAL MOTORS	89017439
GENERAL MOTORS	89018166
SAAB	89 01 8166
<b>US65</b>	
GENERAL MOTORS	89017457
GENERAL MOTORS	89017592
GENERAL MOTORS	89017593
<b>US67</b>	
FORD	4C3Z 8501-ABRM
FORD	4C3Z 8501-AC
<b>US72</b>	
GENERAL MOTORS	97372515
GENERAL MOTORS	98031233
<b>US76</b>	
FORD	8C3Z 8501-B
<b>US77</b>	
FORD	BC3Z 8501-A
<b>US79</b>	
GENERAL MOTORS	19180610
<b>US488</b>	
FORD	B5A-8501-C
FORD	B6A-8501-B
FORD	B6A-8501-C
<b>US563</b>	
GENERAL MOTORS	3741033
GENERAL MOTORS	3774186
<b>US670</b>	
GENERAL MOTORS	3632119
<b>US713</b>	
CHRYSLER	1063 326
CHRYSLER	1064 750
<b>US723</b>	
FORD	C2AZ 8501-A
FORD	C2AZ 8501-B
FORD	C4AZ 8501-A
FORD	C4AZ 8501-B
<b>US819</b>	
FORD	C5AZ 8501-B
FORD	C5AZ 8501-K
FORD	C5OZ 8501-A
<b>US821</b>	
GENERAL MOTORS	1396879
GENERAL MOTORS	1396880
<b>US835</b>	
GENERAL MOTORS	2475788
GENERAL MOTORS	8885837
<b>US843</b>	
AMERICAN MOTORS	3209 691
AMERICAN MOTORS	J8120 129
<b>US850</b>	
GENERAL MOTORS	9772372
GENERAL MOTORS	9784281

GENERAL MOTORS	9788606
GENERAL MOTORS	9793130
<b>US855</b>	
GENERAL MOTORS	1363989
GENERAL MOTORS	1396317
GENERAL MOTORS	1396346
GENERAL MOTORS	1396715
GENERAL MOTORS	1396876
<b>US861</b>	
GENERAL MOTORS	3927565
GENERAL MOTORS	3990992
GENERAL MOTORS	6258458
<b>US895</b>	
GENERAL MOTORS	357261
<b>US896</b>	
GENERAL MOTORS	3861920
GENERAL MOTORS	3876172
GENERAL MOTORS	3929218
GENERAL MOTORS	3932422
GENERAL MOTORS	6258119
GENERAL MOTORS	12307798
<b>US898</b>	
GENERAL MOTORS	3929233
GENERAL MOTORS	3937996
GENERAL MOTORS	3957981
GENERAL MOTORS	3986364
GENERAL MOTORS	12307815
<b>US918</b>	
CHRYSLER	2585 291
CHRYSLER	3004 715
<b>US919</b>	
CHRYSLER	1752422
CHRYSLER	2421375
CHRYSLER	2448315
CHRYSLER	2485385
CHRYSLER	3004762
CHRYSLER	3004991
<b>US932</b>	
FORD	D6AZ 8501-A
<b>US953</b>	
FORD	D00Z 8501-C
FORD	D6ZZ 8501-B
<b>US960</b>	
FORD	D5DZ 8501-A
<b>US964</b>	
FORD	1233214
FORD	5011864
FORD	D1FZ 8501-A
FORD	D3RY 8501-A
<b>US975</b>	
GENERAL MOTORS	12300305
GENERAL MOTORS	12309445
<b>US981</b>	
GENERAL MOTORS	458486
GENERAL MOTORS	3856284
GENERAL MOTORS	3876173
GENERAL MOTORS	3957982
<b>US984</b>	
GENERAL MOTORS	6258551
<b>US985</b>	
GENERAL MOTORS	3998214

GENERAL MOTORS	6260822
<b>US986</b>	
AMERICAN MOTORS	8120 236
AMERICAN MOTORS	J8121 236
<b>US1002</b>	
GENERAL MOTORS	6272159
GENERAL MOTORS	12484890
GENERAL MOTORS	14085852
<b>US1006</b>	
TOYOTA	16100-29026
TOYOTA	16100-29055
<b>US1010</b>	
CHRYSLER	7124 4450
CHRYSLER	7522 1515
<b>US1012</b>	
CHRYSLER	MD001300
<b>US1018</b>	
GENERAL MOTORS	1260709
GENERAL MOTORS	25527536
<b>US1021</b>	
CHRYSLER	8120 131
<b>US1028</b>	
FORD	D3UZ 8501-A
<b>US1040</b>	
CHRYSLER	3780 127
<b>US1042</b>	
MAZDA	0381-15-010A
MAZDA	0381-15-010B
MAZDA	0381-99-151A
FORD	D77Z 8501-A
<b>US1044</b>	
FORD	D4DZ 8501-A
<b>US1045</b>	
GENERAL MOTORS	1247080
<b>US1047</b>	
FORD	D8ZZ 8501-A
<b>US1053</b>	
CHRYSLER	3780 108
<b>US1061</b>	
GENERAL MOTORS	1241680
GENERAL MOTORS	1334037
<b>US1069</b>	
GENERAL MOTORS	359913
<b>US1070</b>	
FORD	D5ZZ 8501-A
<b>US1075</b>	
FORD	D4TZ 8501-H
<b>US1077</b>	
CHRYSLER	8125 501
CHRYSLER	8129 459
<b>US1082</b>	
FORD	D0TZ 8501B
FORD	D4TZ 8501G
FORD	D4TZ 8501M
<b>US1083</b>	
FORD	D4TZ 8501E
FORD	D4TZ 8501K

<b>US1088</b>
GENERAL MOTORS 361053
<b>US1094</b>
FORD D5TZ 8501D
FORD D7HZ 8501-D
<b>US1096</b>
FORD D5TZ 8501E
FORD D7HZ 8501-E
<b>US1100</b>
GENERAL MOTORS 231886
<b>US1107</b>
GENERAL MOTORS 361054
GENERAL MOTORS 10120938
AMERICAN MOTORS 8132 274
CHRYSLER 8132 274
CHRYSLER JR77 5045
<b>US1109</b>
GENERAL MOTORS 474028
<b>US1110</b>
GENERAL MOTORS 361055
<b>US1113</b>
GENERAL MOTORS 376746
<b>US1114</b>
FORD D8TZ 8501-B
FORD E5TZ 8501-C
FORD F1TZ 8501-A
<b>US1120</b>
GENERAL MOTORS 231462
GENERAL MOTORS 556283
GENERAL MOTORS 12337519
<b>US1121</b>
GENERAL MOTORS 474029
GENERAL MOTORS 10048917
GENERAL MOTORS 12522033
GENERAL MOTORS 12524131
GENERAL MOTORS 12529305
GENERAL MOTORS 14085847
GENERAL MOTORS 88894341
<b>US1124</b>
CHRYSLER MD021450
<b>US1127</b>
GENERAL MOTORS 94202477
ISUZU 8-94202-477-1
ISUZU 8-94224-894-0
ISUZU 8-97012-298-0
<b>US1137</b>
GENERAL MOTORS 474056
<b>US3400</b>
CHRYSLER 8127 974
<b>US3401</b>
CHRYSLER 3234 427
CHRYSLER 8125 131
CHRYSLER J3234 427
CHRYSLER JR77 5050
CHRYSLER JR775 050
<b>US3403</b>
AMERICAN MOTORS 8130 749
CHRYSLER 8130 749
AMERICAN MOTORS 8133 033
CHRYSLER 8133 033

AMERICAN MOTORS J813 4320
CHRYSLER J813 4320
AMERICAN MOTORS JR77 5046
CHRYSLER JR77 5046
<b>US3404</b>
AMERICAN MOTORS 8133 034
CHRYSLER 8133 034
AMERICAN MOTORS J813 4321
CHRYSLER J813 4321
<b>US3405</b>
RENAULT 8982 775051
<b>US3406</b>
RENAULT 7701 462085
<b>US3408</b>
RENAULT 8982 775055
<b>US3409</b>
CHRYSLER JR775 056
<b>US3410</b>
RENAULT 7701 463182
CHRYSLER JR775 053
<b>US3411</b>
CHRYSLER T1464552
<b>US3412</b>
CHRYSLER 4626 215
CHRYSLER 4626 215AD
CHRYSLER 4626 215AE
CHRYSLER JR775 122
CHRYSLER R4626215
<b>US3413</b>
AMERICAN MOTORS JR77 5047
CHRYSLER JR77 5047
<b>US3414</b>
AMERICAN MOTORS 4797 143
CHRYSLER 4797 143
AMERICAN MOTORS 8350 2957
CHRYSLER 8350 2957
<b>US4002</b>
FORD D8BZ 8501-A
<b>US4003</b>
FORD D8RZ 8501-A
<b>US4005</b>
FORD D8FZ 8501-A
<b>US4014</b>
FORD E1AZ 8501-A
FORD E6AZ 8501-B
<b>US4016</b>
FORD E2DZ 8501-A
<b>US4018</b>
FORD E9TZ 8501-B
FORD XU2Z 8501-EA
<b>US4020</b>
FORD E9PZ 8501-A
FORD F0PZ 8501-A
<b>US4022</b>
FORD E93Z 8501-A
<b>US4023</b>
FORD E3TZ 8501-F

<b>US4024</b>
FORD E0ZZ 8501-A
FORD E4ZZ 8501-A
<b>US4033</b>
FORD E3TZ 8501-G
<b>US4034</b>
FORD E6DZ 8501-A
FORD F4DZ 8501-B
<b>US4035</b>
FORD E5ZZ 8501-A
<b>US4038</b>
FORD F0ZZ 8501-A
FORD F3ZZ 8501-B
<b>US4039</b>
FORD E69Z 8501-A
FORD F59Z 8501-B
FORD ZZMA-15-010
<b>US4040</b>
FORD E8FZ 8501-A
<b>US4041</b>
FORD F23Z 8501-B
FORD F33Z 8501-A
<b>US4042</b>
FORD E6TZ 8501-A
<b>US4044</b>
FORD E7TZ 8501-A
FORD F0TZ 8501-E
FORD F3TZ 8501-C
FORD F5TZ 8501H2-A
<b>US4045</b>
FORD E7RY 8501-A
<b>US4048</b>
FORD E7TZ 8501-B
FORD F0TZ 8501-F
<b>US4049</b>
KIA 0K930-15-010A
MAZDA 8AB4-15-010A
MAZDA 8AB7-15-010
MAZDA 8AD2-15-010A
MAZDA B630-15-010RMD
FORD E8BZ 8501-A
FORD E9BZ 8501-A
FORD F4BZ 8501-B
FORD F7BZ 8501-A
<b>US4050</b>
FORD F1SZ 8501-B
<b>US4051</b>
FORD E8DZ 8501-A
FORD E8DZ 8501-B
<b>US4052</b>
FORD E8AZ 8501-A
FORD F0AZ 8501-A
<b>US4053</b>
KIA 0FE1H-15-010H
FORD E92Z 8501-A
MAZDA FEMJ-15-100RMO
<b>US4054</b>
FORD E4BZ 8501-A
FORD E6ZZ 8501-A



MAZDA	ZZM0-15-010
<b>US4055</b>	
FORD	E9SZ 8501-B
<b>US4056</b>	
FORD	E9DZ 8501-B
<b>US4057</b>	
FORD	F1SZ 8501-A
<b>US4059</b>	
FORD	F02Z 8501-B
<b>US4060</b>	
FORD	F0TZ 8501-D
FORD	F0TZ 8501-G
FORD	F5TZ 8501-C
FORD	F7TZ 8501-AB
MAZDA	ZZL0-15-010A
MAZDA	ZZM5-15-010
<b>US4061</b>	
FORD	F0DZ 8501-A
<b>US4065</b>	
FORD	F0CZ 8501-A
<b>US4066</b>	
FORD	F1VY 8501-A
FORD	F4AZ 8501-A
FORD	F8AZ 8501-AA
<b>US4067</b>	
FORD	D2RY 8501-A
<b>US4068</b>	
MAZDA	8AB5-15-010A
MAZDA	8AB8-15-010
MAZDA	B660-15-010RME
FORD	E9JY 8501-B
<b>US4069</b>	
FORD	F1CZ 8501-A
FORD	F4CZ 8501-A
FORD	F6PZ 8501-AA
<b>US4070</b>	
FORD	F23Z 8501-A
<b>US4077</b>	
FORD	F2TZ 8501-A
<b>US4078</b>	
MAZDA	8AG9-15-010
FORD	F32Z 8501-B
MAZDA	FP01-15-010F
MAZDA	FS01-15-010F
MAZDA	FS01-15-010RMF
<b>US4079</b>	
FORD	F2UZ 8501-A
FORD	F3TZ 8501-E
FORD	F6TZ 8501-KB
<b>US4081</b>	
FORD	F2UZ 8501-C
<b>US4082</b>	
FORD	F3DZ 8501-A
<b>US4083</b>	
FORD	E9PZ 8501-C
<b>US4086</b>	
FORD	F4TZ 8501-B

<b>US4087</b>	
FORD	F4ZZ 8501-B
<b>US4088</b>	
FORD	F5RZ 8501-B
<b>US4089</b>	
FORD	F4DZ 8501-A
<b>US4090</b>	
FORD	F4SZ 8501-A
<b>US4091</b>	
MAZDA	AJ03-15-010B
MAZDA	AJY1-15-010
FORD	F63Z 8501-AA
MAZDA	GY01-15-010B
FORD	XS2Z 8501-BC
FORD	XS2Z 8501-CC
FORD	XS2Z 8501-CD
FORD	XS2Z 8501-CF
FORD	XS2Z 8501-EA
<b>US4093</b>	
MAZDA	1F00-15-010
FORD	F57Z 8501-A
FORD	F87Z 8501-BA
FORD	F87Z 8501-BB
FORD	XL5Z 8501-CA
MAZDA	ZZM3-15-010
<b>US4094</b>	
FORD	1F1Z 8501-AA
FORD	2S7Z 8501-BG
FORD	5F1Z 8501-A
FORD	5L8Z 8501-AA
FORD	F5DZ 8501-A
FORD	F6DZ 8501-FA
FORD	F8DZ 8501-AA
FORD	XF1Z 8501-AA
<b>US4095</b>	
FORD	F59Z 8501-A
FORD	F87Z 8501-DA
FORD	XL5Z 8501-AA
FORD	XL5Z 8501-AC
FORD	XL5Z 8501-AD
MAZDA	ZZM7-15-010
MAZDA	ZZR1-15-010
MAZDA	ZZR1-15-010A
MAZDA	ZZR1-15-010B
<b>US4096</b>	
FORD	1U2Z 8V501-CA
FORD	F4TZ 8501-ARM
FORD	F5TZ 8501-A
FORD	F5TZ 8501-BRM
<b>US4097</b>	
FORD	F50Y 8501-A
FORD	F80Z 8501-AA
FORD	YF3Z 8501-A
FORD	YF3Z 8501-AB
<b>US4098</b>	
FORD	F5DZ 8501-CL
FORD	F6DZ 8501-A
FORD	F7DZ 8501-A
<b>US4099</b>	
FORD	F6TZ 8501-KA
<b>US4101</b>	
FORD	F87Z 8501-CA

<b>US4102</b>	
FORD	3F2Z 8501-BB
FORD	5F2Z 8501-A
FORD	6U7Z 8501-A
FORD	6U7Z 8501-B
FORD	F68Z 8501-A
FORD	XF2Z 8501-AA
<b>US4103</b>	
FORD	3R3Z 8501-A
FORD	3R3Z 8501-BB
FORD	F6ZZ 8501-A
FORD	F7ZZ 8501-AA
FORD	F8ZZ 8501-AA
<b>US4104</b>	
FORD	YSG6 8501-A2C
<b>US4105</b>	
FORD	3L3Z 8501-DB
FORD	5L3Z 8501-A
FORD	F85Z 8501-AA
<b>US4106</b>	
FORD	F6DZ 8501-B
<b>US4107</b>	
FORD	F7CZ 8501-AB
<b>US4108</b>	
MAZDA	1F22-15-010
MAZDA	1F82-15-010
FORD	6L2Z 8501-A
FORD	F77Z 8501-AD
<b>US4109</b>	
FORD	4C3Z 8501-B
FORD	F81Z 8501-DA
FORD	YC3Z 8501-AA
FORD	YC3Z 8501-AB
<b>US4113</b>	
FORD	F3LY 8501-A
FORD	F6LZ 8501-AA
FORD	YW7Z 8501-AA
<b>US4114</b>	
FORD	2C3Z 8V501-BA
FORD	F6TZ 8501-AA
FORD	F7TZ 8501-CRM
FORD	F81Z 8501-ARM
FORD	F81Z 8501-CRM
FORD	F81Z 8501-FA
<b>US4115</b>	
FORD	F8RZ 8501-EN
FORD	F8RZ 8501-NE
MAZDA	YF09-15-100
<b>US4118</b>	
JAGUAR	C2S26232
JAGUAR	XR813290
FORD	XW4Z 8501-BA
FORD	XW4Z 8501-CD
<b>US4119</b>	
FORD	5R3Z 8501-A
JAGUAR	XR3Z 8501-AA
FORD	YR3Z 8501-AB
<b>US4121</b>	
FORD	1L3Z 8501-BA
FORD	XL3Z 8501-BA

<b>US4122</b>	
FORD	F65Z 8501-BA
FORD	XL3Z 8501-AA
FORD	YC2E 8501-BA
<b>US4123</b>	
FORD	YS4Z 8501-AA
<b>US4124</b>	
FORD	2W9Z 8501-BB
LAND ROVER	457 5902
JAGUAR	AJ88912
<b>US4125</b>	
FORD	1L3Z 8501-AB
<b>US4126</b>	
MAZDA	1F20-15-010
MAZDA	1F70-15-010
FORD	1S7Z 8501-AK
FORD	4S4Z 8501-AA
MAZDA	L327-15-100
MAZDA	L327-15-100A
MAZDA	L3G2-15-100
MAZDA	L3G2-15-100A
MAZDA	LF01-15-100
MAZDA	LF52-15-100
MAZDA	LF52-15-100A
<b>US4127</b>	
FORD	1L2Z 8501-BA
FORD	1L2Z 8501-BB
FORD	5L2Z 8501-A
<b>US4128</b>	
FORD	YW7Z 8501-BB
<b>US4129</b>	
FORD	2R8Z 8501-AE
FORD	5R8Z 8501-A
JAGUAR	AJ84817
JAGUAR	C2C32677
JAGUAR	C2C38862
<b>US4130</b>	
FORD	3L3Z8501-CA
<b>US4132</b>	
FORD	5L8Z 8501-A
FORD	5M8Z 8501-A
MAZDA	AJ03-15-010G
<b>US5000</b>	
GENERAL MOTORS	10013800
GENERAL MOTORS	10159526
GENERAL MOTORS	12481997
GENERAL MOTORS	12507232
<b>US5001</b>	
GENERAL MOTORS	10120945
GENERAL MOTORS	12482696
GENERAL MOTORS	14101304
<b>US5003</b>	
GENERAL MOTORS	12309978
<b>US5004</b>	
GENERAL MOTORS	10077051
GENERAL MOTORS	14071866
GENERAL MOTORS	14079351
<b>US5006</b>	
GENERAL MOTORS	10089659
CHRYSLER	8277 5049
CHRYSLER	JR77 5049

CHRYSLER	JR775 049
<b>US5007</b>	
GENERAL MOTORS	10065240
<b>US5008</b>	
AM GENERAL	5740079
GENERAL MOTORS	5740079
GENERAL MOTORS	12534418
GENERAL MOTORS	23500133
<b>US5010</b>	
GENERAL MOTORS	3634580
GENERAL MOTORS	3634838
<b>US5012</b>	
GENERAL MOTORS	12337663
GENERAL MOTORS	22514839
<b>US5013</b>	
GENERAL MOTORS	94239153
<b>US5014</b>	
GENERAL MOTORS	12337664
GENERAL MOTORS	22519584
<b>US5015</b>	
GENERAL MOTORS	14063641
<b>US5016</b>	
GENERAL MOTORS	10048919
<b>US5017</b>	
GENERAL MOTORS	12508606
GENERAL MOTORS	12517379
GENERAL MOTORS	52273124
GENERAL MOTORS	90392908
GENERAL MOTORS	93231147
<b>US5020</b>	
GENERAL MOTORS	10174979
GENERAL MOTORS	14089011
<b>US5022</b>	
GENERAL MOTORS	10032022
<b>US5023</b>	
GENERAL MOTORS	12369484
<b>US5027</b>	
GENERAL MOTORS	94118501
ISUZU	8-94118-501-0
ISUZU	8-97010-201-0
<b>US5028</b>	
GENERAL MOTORS	12334884
<b>US5029</b>	
GENERAL MOTORS	96054298
SUZUKI	17400-83811
SUZUKI	17400-83815
<b>US5030</b>	
GENERAL MOTORS	474055
GENERAL MOTORS	10046305
GENERAL MOTORS	12523505
<b>US5031</b>	
GENERAL MOTORS	94109591
ISUZU	8-94109-591-1
ISUZU	8-94376-866-0
<b>US5032</b>	
GENERAL MOTORS	10089654
GENERAL MOTORS	12363169
GENERAL MOTORS	12462265
GENERAL MOTORS	12518443

ISUZU	8-12462-265-0
<b>US5033</b>	
GENERAL MOTORS	10048949
GENERAL MOTORS	89017269
GENERAL MOTORS	89017311
<b>US5035</b>	
GENERAL MOTORS	10048950
GENERAL MOTORS	10120943
GENERAL MOTORS	12482690
ISUZU	8-10120-943-0
ISUZU	8-12482-690-0
<b>US5036</b>	
GENERAL MOTORS	90220568
GENERAL MOTORS	90392902
<b>US5037</b>	
GENERAL MOTORS	10120944
GENERAL MOTORS	12482694
<b>US5038</b>	
GENERAL MOTORS	12458326
GENERAL MOTORS	12521037
GENERAL MOTORS	12525123
GENERAL MOTORS	12527759
<b>US5040</b>	
GENERAL MOTORS	10181235
GENERAL MOTORS	10181327
GENERAL MOTORS	12458920
GENERAL MOTORS	12491038
<b>US5041</b>	
GENERAL MOTORS	12482000
<b>US5043</b>	
GENERAL MOTORS	24570464
GENERAL MOTORS	24571389
<b>US5045</b>	
GENERAL MOTORS	90392900
<b>US5048</b>	
GENERAL MOTORS	91172178
GENERAL MOTORS	91173496
GENERAL MOTORS	96059659
GENERAL MOTORS	96062832
SUZUKI	17400-60812
SUZUKI	17400-60813
SUZUKI	17400-60815
<b>US5049</b>	
AM GENERAL	5743939
GENERAL MOTORS	5743939
GENERAL MOTORS	10077059
GENERAL MOTORS	12369487
GENERAL MOTORS	12522031
GENERAL MOTORS	12532529
GENERAL MOTORS	12532531
GENERAL MOTORS	19201601
GENERAL MOTORS	88894005
<b>US5050</b>	
GENERAL MOTORS	12336298
GENERAL MOTORS	12482919
GENERAL MOTORS	12537495
<b>US5051</b>	
GENERAL MOTORS	10174846
GENERAL MOTORS	12458922
GENERAL MOTORS	12522034

<b>US5054</b>	
GENERAL MOTORS	19168612
GENERAL MOTORS	21006933
GENERAL MOTORS	21007155
GENERAL MOTORS	21007288
GENERAL MOTORS	21007655
GENERAL MOTORS	21015340
<b>US5056</b>	
GENERAL MOTORS	10159599
<b>US5057</b>	
GENERAL MOTORS	90392901
<b>US5058</b>	
GENERAL MOTORS	91173189
GENERAL MOTORS	91175666
GENERAL MOTORS	91176915
GENERAL MOTORS	17400-82824
SUZUKI	17400-82850
SUZUKI	17400-82851
<b>US5062</b>	
AM GENERAL	5743241
GENERAL MOTORS	5743241
GENERAL MOTORS	12514574
GENERAL MOTORS	15633466
GENERAL MOTORS	19168611
GENERAL MOTORS	88894044
<b>US5063</b>	
GENERAL MOTORS	12509653
<b>US5064</b>	
GENERAL MOTORS	7490004
<b>US5066</b>	
GENERAL MOTORS	12523499
<b>US5068</b>	
GENERAL MOTORS	12518277
GENERAL MOTORS	12527741
<b>US5069</b>	
GENERAL MOTORS	12523502
GENERAL MOTORS	12527740
<b>US5070</b>	
GENERAL MOTORS	12520914
<b>US5072</b>	
GENERAL MOTORS	7490007
GENERAL MOTORS	12487361
GENERAL MOTORS	12529993
GENERAL MOTORS	88894344
GENERAL MOTORS	89017467
GENERAL MOTORS	89017900
<b>US5073</b>	
GENERAL MOTORS	12522036
<b>US5074</b>	
AM GENERAL	5744474
GENERAL MOTORS	5744474
AM GENERAL	5744662
GENERAL MOTORS	5744662
AM GENERAL	5744938
GENERAL MOTORS	5744938
GENERAL MOTORS	12530176
GENERAL MOTORS	12534772
GENERAL MOTORS	88894036
<b>US5075</b>	
GENERAL MOTORS	12482903
GENERAL MOTORS	89018214

GENERAL MOTORS	89060462
<b>US5076</b>	
GENERAL MOTORS	24577255
<b>US5077</b>	
GENERAL MOTORS	12532528
GENERAL MOTORS	89017748
GENERAL MOTORS	89060527
ISUZU	8-12532-528-0
ISUZU	8-89060-527-0
<b>US5079</b>	
GENERAL MOTORS	55352002
GENERAL MOTORS	90543277
GENERAL MOTORS	93170697
SAAB	59 58 061
SAAB	88 21 944
<b>US5081</b>	
GENERAL MOTORS	12369537
GENERAL MOTORS	12456112
GENERAL MOTORS	12458934
GENERAL MOTORS	89017456
GENERAL MOTORS	89018053
<b>US5085</b>	
GENERAL MOTORS	12455105
GENERAL MOTORS	12458115
<b>US5086</b>	
AM GENERAL	5745093
GENERAL MOTORS	5745093
GENERAL MOTORS	12456231
GENERAL MOTORS	50745093
GENERAL MOTORS	88894035
<b>US5087</b>	
GENERAL MOTORS	12456113
GENERAL MOTORS	12458935
GENERAL MOTORS	88894290
ISUZU	8-88894-290-0
ISUZU	8-89017-439-0
ISUZU	8-89018-166-0
<b>US5089</b>	
GENERAL MOTORS	88893906
GENERAL MOTORS	89017693
GENERAL MOTORS	89017771
<b>US5090</b>	
GENERAL MOTORS	88893907
GENERAL MOTORS	89017773
<b>US5092</b>	
GENERAL MOTORS	12585226
GENERAL MOTORS	12591894
GENERAL MOTORS	12624936
GENERAL MOTORS	12630084
GENERAL MOTORS	24439798
GENERAL MOTORS	24467301
GENERAL MOTORS	55352570
SAAB	93 17 8602
SAAB	93 18 1118
SAAB	93 19 5308
<b>US5097</b>	
GENERAL MOTORS	12620226
GENERAL MOTORS	24576952
SAAB	12 62 0226
SAAB	24 57 6952
ISUZU	8-12620-226-0
ISUZU	8-24576-952-0

<b>US5099</b>	
GENERAL MOTORS	88972167
<b>US5103</b>	
GENERAL MOTORS	92149009
<b>US6000</b>	
VOLKSWAGEN / AUDI	079 121 012 D
<b>US6006</b>	
FORD	AL3Z8501A
<b>US6007</b>	
CHRYSLER	5138 057AA
<b>US6008</b>	
CHRYSLER	5103 576AA
<b>US6009</b>	
GENERAL MOTORS	12600767
GENERAL MOTORS	19208815
<b>US6018</b>	
HONDA	19200-RME-A01
<b>US6020</b>	
GENERAL MOTORS	89017757
GENERAL MOTORS	89060479
<b>US6022</b>	
VOLKSWAGEN / AUDI	06F 121 011
VOLKSWAGEN / AUDI	06F 121 011 X
<b>US6023</b>	
FORD	7T4Z 8501-B
FORD	7T4Z 8501-C
FORD	AA5Z 8501-A
<b>US6030</b>	
MERCEDES-BENZ	271 200 02 01
<b>US6034</b>	
VOLKSWAGEN / AUDI	038 121 011 G
VOLKSWAGEN / AUDI	03L 121 011 B
VOLKSWAGEN / AUDI	06H 121 026 AB
<b>US6037</b>	
TOYOTA	16100-09470
TOYOTA	16100-09471
<b>US6038</b>	
CHRYSLER	5047 138AA
CHRYSLER	5047 138AB
CHRYSLER	6804 6026AA
<b>US6046</b>	
GENERAL MOTORS	96352650
GENERAL MOTORS	96872702
<b>US6047</b>	
TOYOTA	16100-09440
TOYOTA	16100-09441
<b>US6048</b>	
HYUNDAI	25100-3C100
KIA	25100-3C100
HYUNDAI	25100-3C120
KIA	25100-3C120
<b>US6049</b>	
SUBARU	21110 AA690
SUBARU	21111 AA280
<b>US6050</b>	
VOLKSWAGEN / AUDI	07K 121 011 B
VOLKSWAGEN / AUDI	07K 121 011 BX
VOLKSWAGEN / AUDI	07K 121 011 G



<b>US6056</b>	
HONDA	06194-RNA-305
HONDA	19200-RNA-A01
HONDA	19200-RNA-A02
<b>US6075</b>	
MERCEDES-BENZ	272 200 04 01
MERCEDES-BENZ	272 200 04 91
<b>US6142</b>	
MERCEDES-BENZ	272 200 09 01
<b>US6143</b>	
TOYOTA	16100-39435
TOYOTA	16100-39436
<b>US6144</b>	
FORD	7L3Z-8501-A
<b>US6145</b>	
GENERAL MOTORS	19179031
<b>US6146</b>	
VOLKSWAGEN / AUDI	06E 121 005 D
VOLKSWAGEN / AUDI	06E 121 005 F
VOLKSWAGEN / AUDI	06E 121 008 N
VOLKSWAGEN / AUDI	06E 121 018 A
<b>US6149</b>	
CHRYSLER	1300A066
CHRYSLER	MD979395
<b>US6152</b>	
MERCEDES-BENZ	613 200 09 01
<b>US6154</b>	
GENERAL MOTORS	89018165
<b>US6155</b>	
CHRYSLER	5175 580AA
CHRYSLER	6808 7367AA
<b>US6156</b>	
MAZDA	N3H1-15-100B
MAZDA	N3H8-115-100A
<b>US6159</b>	
CHRYSLER	1300A065
CHRYSLER	1300A067
<b>US6160</b>	
SUBARU	21111 AA290
SUBARU	21114 AA051
<b>US6184</b>	
GENERAL MOTORS	24405895
<b>US6186</b>	
FORD	5F9Z 8501-BB
<b>US6197</b>	
TOYOTA	16100-09490
TOYOTA	16100-09491
TOYOTA	16100-39495
<b>US6198</b>	
NISSAN	21010-JA10A
NISSAN	21010-JK00C
NISSAN	B1010-JK00A
<b>US6215</b>	
HYUNDAI	25100-3E001
KIA	25100-3E001
<b>US6216</b>	
HONDA	19200-PZA-013
HONDA	19200-RMX-003

<b>US6217</b>	
CHRYSLER	4892 425AA
<b>US6218</b>	
NISSAN	21010-ET025
NISSAN	B1010-1GZ0A
NISSAN	B1010-EN20B
NISSAN	B1010-ET00A
<b>US6219</b>	
MAZDA	LF94-15-100
MAZDA	LF94-15-100A
<b>US6220</b>	
HYUNDAI	25100-25002
KIA	25100-25002
HYUNDAI	25100-2G100
HYUNDAI	25100-2G200
HYUNDAI	25100-2G600
<b>US6221</b>	
VOLKSWAGEN / AUDI	022 121 011 A
<b>US6222</b>	
CHRYSLER	6800 3402AA
CHRYSLER	6800 3402AB
<b>US6223</b>	
HONDA	19200-RWC-A01
<b>US6228</b>	
CHRYSLER	1300A069
CHRYSLER	MD978552
<b>US6231</b>	
CHRYSLER	4648 952AE
CHRYSLER	4648 952BA
<b>US6232</b>	
TOYOTA	16100-39465
<b>US6233</b>	
HONDA	19200-R40-A01
<b>US6235</b>	
MERCEDES-BENZ	273 200 02 01
<b>US6238</b>	
BMW	11 51 7 586 779
<b>US6240</b>	
CHRYSLER	1300A055
<b>US6241</b>	
SUZUKI	17400-86Z00
SUZUKI	17400-86Z03
<b>US6242</b>	
NISSAN	21010-EA010
<b>US6244</b>	
BMW	11 51 7 550 484
BMW	11 51 8 604 888
<b>US6247</b>	
KIA	25100-2B000
<b>US6249</b>	
VOLKSWAGEN / AUDI	06E 121 005 G
VOLKSWAGEN / AUDI	06E 121 005 P
VOLKSWAGEN / AUDI	06E 121 008 P
VOLKSWAGEN / AUDI	06E 121 018B
<b>US6250</b>	
FORD	9L8Z 8501-A
<b>US6252</b>	
TOYOTA	16100-09515

TOYOTA	16100-39515
<b>US6338</b>	
TOYOTA	16100-39505
TOYOTA	16100-39506
<b>US6341</b>	
CHRYSLER	5302 2192AE
CHRYSLER	5302 2192AF
CHRYSLER	5302 2192AJ
<b>US6349</b>	
MERCEDES-BENZ	642 200 10 01
<b>US6350</b>	
HONDA	19200-RB0-003
<b>US6351</b>	
TOYOTA	16100-39466
<b>US6599</b>	
TOYOTA	16100-39545
TOYOTA	16100-39545
<b>US6657</b>	
JAGUAR	C2S43292
<b>US6662</b>	
GENERAL MOTORS	55561623
GENERAL MOTORS	55579016
<b>US6699</b>	
CHRYSLER	6807 9412AB
CHRYSLER	6807 9412AC
<b>US7100</b>	
CHRYSLER	2808 679
CHRYSLER	4106 034
CHRYSLER	4131 243
<b>US7101</b>	
CHRYSLER	5214 490
CHRYSLER	5240 630
<b>US7103</b>	
CHRYSLER	2402 903
CHRYSLER	3780 109
CHRYSLER	3837 641
CHRYSLER	4728 533
CHRYSLER	5302 0185
<b>US7104</b>	
CHRYSLER	MD008431
<b>US7105</b>	
CHRYSLER	MD009000
CHRYSLER	MD997077
<b>US7106</b>	
CHRYSLER	MD030751
CHRYSLER	MD997464
<b>US7108</b>	
CHRYSLER	MD034152
CHRYSLER	MD974719
CHRYSLER	MD997078
CHRYSLER	MD997421
CHRYSLER	MD997485
CHRYSLER	MD997619
<b>US7110</b>	
CHRYSLER	4293 898
CHRYSLER	4323 148
CHRYSLER	5203 432
CHRYSLER	R429 3898
CHRYSLER	R4293898

<b>US7111</b>	
CHRYSLER	MD025190
<b>US7113</b>	
CHRYSLER	4173 703
CHRYSLER	4272 919
<b>US7114</b>	
CHRYSLER	MD971582
CHRYSLER	MD972051
CHRYSLER	MD997079
CHRYSLER	MD997615
<b>US7115</b>	
CHRYSLER	25100-21000
CHRYSLER	25100-22650
HYUNDAI	25100-22650
HYUNDAI	25100-24030
CHRYSLER	MD030863
CHRYSLER	MD974649
CHRYSLER	MD997076
CHRYSLER	MD997609
<b>US7116</b>	
CHRYSLER	MD021490
CHRYSLER	MD975292
CHRYSLER	MD997082
CHRYSLER	MD997149
<b>US7117</b>	
CHRYSLER	MD972001
CHRYSLER	MD997084
CHRYSLER	MD997150
<b>US7118</b>	
HYUNDAI	25100-32515
CHRYSLER	MD997081
CHRYSLER	MD997614
<b>US7120</b>	
MAZDA	8BU1-15-010
MAZDA	8BU1-15-010RM0
CHRYSLER	MD997158
CHRYSLER	MD997178
CHRYSLER	MD997616
<b>US7121</b>	
HYUNDAI	25100-35050
CHRYSLER	MD972003
CHRYSLER	MD972004
CHRYSLER	MD973940
CHRYSLER	MD980000
CHRYSLER	MD997244
CHRYSLER	MD997515
CHRYSLER	MD997634
CHRYSLER	R972003MAB
<b>US7122</b>	
CHRYSLER	4387 457
CHRYSLER	R4798497
<b>US7124</b>	
CHRYSLER	MD997403
CHRYSLER	MD997404
CHRYSLER	MD997623
<b>US7126</b>	
CHRYSLER	4448 878
CHRYSLER	4654 392AB
CHRYSLER	5010 898AA
<b>US7127</b>	
CHRYSLER	4483 453
CHRYSLER	4621 172

CHRYSLER	R4621172
<b>US7128</b>	
CHRYSLER	4483 754
<b>US7129</b>	
CHRYSLER	MD972005
CHRYSLER	MD997643
<b>US7131</b>	
HYUNDAI	25100-33012
CHRYSLER	MD997418
CHRYSLER	MD997620
<b>US7135</b>	
CHRYSLER	MD179030
CHRYSLER	MD300799
<b>US7136</b>	
CHRYSLER	4626 054
CHRYSLER	4626 054AD
CHRYSLER	4626 054AE
<b>US7137</b>	
CHRYSLER	5245 357
<b>US7139</b>	
CHRYSLER	4626 682
CHRYSLER	R4626682
<b>US7140</b>	
CHRYSLER	5281 175
<b>US7141</b>	
CHRYSLER	4556 541
CHRYSLER	4882 837AB
<b>US7145</b>	
CHRYSLER	5010 964AB
CHRYSLER	5086 959AA
CHRYSLER	R5003665AA
<b>US7146</b>	
CHRYSLER	5245 465
CHRYSLER	5245 720
<b>US7147</b>	
CHRYSLER	MD306414
<b>US7148</b>	
CHRYSLER	MD971538
CHRYSLER	MD972050
<b>US7150</b>	
CHRYSLER	4667 660
CHRYSLER	4667 660AB
CHRYSLER	4667 660AE
CHRYSLER	M04667660
<b>US7151</b>	
CHRYSLER	4663 296
CHRYSLER	5003 085AA
<b>US7152</b>	
CHRYSLER	1300A011
CHRYSLER	MD973025
CHRYSLER	MD977705
CHRYSLER	MD978743
CHRYSLER	MD978764
<b>US7153</b>	
CHRYSLER	4621 489
<b>US7156</b>	
CHRYSLER	4694 307
CHRYSLER	4694 307AB
CHRYSLER	4694 307AC

CHRYSLER	4694 307AE
CHRYSLER	4694307
CHRYSLER	MN187244
<b>US7158</b>	
CHRYSLER	4663 296AB
<b>US7159</b>	
CHRYSLER	5300 8354
<b>US7160</b>	
CHRYSLER	5302 0280
CHRYSLER	5302 1018
CHRYSLER	5302 1018AB
CHRYSLER	5302 1018AC
CHRYSLER	5302 1018AD
<b>US7161</b>	
CHRYSLER	4663 732
CHRYSLER	4663 732AB
CHRYSLER	4663 732AC
CHRYSLER	4663 732AD
CHRYSLER	4892 225AA
<b>US7162</b>	
CHRYSLER	4792 195
CHRYSLER	4792 195AB
<b>US7163</b>	
CHRYSLER	5302 0873AB
CHRYSLER	5302 0873AC
CHRYSLER	5302 1187AA
CHRYSLER	5302 2058AA
CHRYSLER	5302 2189AA
CHRYSLER	5302 2189AB
CHRYSLER	5302 2189AC
CHRYSLER	6804 5797AA
<b>US7164</b>	
CHRYSLER	5012 366AA
CHRYSLER	5012 366AB
CHRYSLER	5012 366AC
CHRYSLER	5012 366AD
<b>US7165</b>	
CHRYSLER	4781 157AA
CHRYSLER	4781 157AB
<b>US7166</b>	
CHRYSLER	5037 164 AE
CHRYSLER	5037 164AB
CHRYSLER	5037 164AC
<b>US7167</b>	
CHRYSLER	4884 159AA
<b>US7168</b>	
CHRYSLER	5302 1380AG
CHRYSLER	5302 1380AK
CHRYSLER	5302 1380AL
CHRYSLER	5302 1380AM
<b>US7169</b>	
CHRYSLER	4897 531AA
CHRYSLER	5300 5877
CHRYSLER	5302 1074AB
CHRYSLER	5302 1074AC
CHRYSLER	5302 1074AE
CHRYSLER	5302 1074AF
CHRYSLER	5302 1844AA
<b>US8901</b>	
GENERAL MOTORS	1334104
GENERAL MOTORS	1334113
GENERAL MOTORS	93179383

ISUZU	8-87018-560-0
ISUZU	8-94140-341-2
ISUZU	8-94310-251-0

<b>US8902</b>	
MINI	ME200411
MINI	ME996789

<b>US8903</b>	
SUBARU	21110-AA000
SUBARU	21110-AA001
SUBARU	21110-AA002
SUBARU	21110-AA003

<b>US8904</b>	
TOYOTA	16100-59155
TOYOTA	16100-59255

<b>US8905</b>	
FORD	1233205
FORD	5013320
FORD	5030651
FORD	A840X8591BCA

<b>US8908</b>	
DAIHATSU	16100-87183-000

<b>US8909</b>	
GENERAL MOTORS	4864 566

<b>US8911</b>	
PEUGEOT	1201-58
PEUGEOT	1201-E4
PEUGEOT	1201-E6
PEUGEOT	1207-25

<b>US8914</b>	
GENERAL MOTORS	4409162
GENERAL MOTORS	91160212
RENAULT	7701 462 809
RENAULT	7701 463 111
RENAULT	7701 463 397
MINI	M345611
MINI	M855991

<b>US8917</b>	
GENERAL MOTORS	94013802
GENERAL MOTORS	96182871
GENERAL MOTORS	96351971
GENERAL MOTORS	96352649
GENERAL MOTORS	96872700
DAEWOO	96352652

<b>US8922</b>	
HYUNDAI	25100-42540
MINI	MD972002
MINI	MD997686

<b>US8923</b>	
MAZDA	8ALA-15-100
MAZDA	8ALA-15-100A

<b>US8924</b>	
FORD	EF8501KT

<b>US8925</b>	
GENERAL MOTORS	1334139
GENERAL MOTORS	24409355
SUZUKI	17400-85Z00
DAEWOO	92064250

<b>US8926</b>	
BMW	11 51 0 393 340

<b>US8927</b>	
NISSAN	21010-00QAA

RENAULT	7700 274330
RENAULT	8200 146297

<b>US8928</b>	
SUZUKI	17400-60D01
SUZUKI	17400-70B00
DAEWOO	96518977

<b>US8929</b>	
SUZUKI	17400-70D00
SUZUKI	17400-71811

<b>US8930</b>	
NISSAN	21010-0F002
NISSAN	21010-80G85

<b>US8931</b>	
GENERAL MOTORS	1089795
GENERAL MOTORS	1229571
FORD	XS6E 6659
JAGUAR	XS6E 8501-AD

<b>US8932</b>	
GENERAL MOTORS	12618472
GENERAL MOTORS	12637479
SAAB	12 56 6029
SAAB	92 14 9009

<b>US8933</b>	
GENERAL MOTORS	1334135
GENERAL MOTORS	90543935

<b>US8934</b>	
FORD	1000398
FORD	1020567
FORD	1109341
FORD	1429037
FORD	1518911
MAZDA	1E04-15-010
FORD	96BX 8591-A2B
FORD	96BX 8591-AA

<b>US8935</b>	
NISSAN	21010-78203
HYUNDAI	25100-02500
HYUNDAI	25100-02501
HYUNDAI	25100-02502
HYUNDAI	25100-02555
HYUNDAI	25100-12500
HYUNDAI	25100-12501

<b>US8936</b>	
PEUGEOT	1201-47
PEUGEOT	1201-E3
PEUGEOT	1207-18
PEUGEOT	1207-23

<b>US8937</b>	
PEUGEOT	1201-A2
PEUGEOT	1201-E5

<b>US8938</b>	
GENERAL MOTORS	93385844

<b>US8940</b>	
CHRYSLER	4792 838AA
CHRYSLER	4792 838AB

<b>US8941</b>	
NISSAN	21010-03J25

<b>US8942</b>	
GENERAL MOTORS	1334054
GENERAL MOTORS	90444123

<b>US8943</b>	
CHERY	BJ040315Z
CHERY	BJ060510ZC

<b>US8944</b>	
FIAT	4336009
FIAT	5882691
FIAT	5890406

<b>US8945</b>	
FIAT	46526243
FIAT	46805736
FIAT	55184080

<b>US8946</b>	
GENERAL MOTORS	4640058

<b>US8948</b>	
FIAT	46400058
FIAT	46444355
FIAT	71716878

<b>US8949</b>	
VOLKSWAGEN / AUDI	030 121 005 N
VOLKSWAGEN / AUDI	030 121 005 NV
VOLKSWAGEN / AUDI	030 121 005 NX
VOLKSWAGEN / AUDI	030 121 008 D
VOLKSWAGEN / AUDI	030 121 008 DX
VOLKSWAGEN / AUDI	030 131 005 T

<b>US8950</b>	
TOYOTA	16100-19235

<b>US8951</b>	
CHRYSLER	4792 968AD

<b>US8953</b>	
GENERAL MOTORS	97180326
ISUZU	8-97180326

<b>US8955</b>	
GENERAL MOTORS	12595614

<b>US8956</b>	
GENERAL MOTORS	12583033

<b>US8957</b>	
HYUNDAI	25100-41000
MINI	ME015030
MINI	ME015040
MINI	ME015045
MINI	ME015050

<b>US8958</b>	
NISSAN	21010-54A15
NISSAN	21010-54A26
NISSAN	21010-54A27
MAZDA	BA010-54A26
MAZDA	BA010-54A27

<b>US8959</b>	
VOLKSWAGEN / AUDI	06B 121 011
VOLKSWAGEN / AUDI	06B 121 011 A
VOLKSWAGEN / AUDI	06B 121 011 B
VOLKSWAGEN / AUDI	06B 121 011 C
VOLKSWAGEN / AUDI	06B 121 011 E
VOLKSWAGEN / AUDI	06B 121 011 L
VOLKSWAGEN / AUDI	06B 121 011 N

<b>US8960</b>	
CHRYSLER	4666 044AA

<b>US8961</b>	
KIA	OK65A-15-100



<b>US8962</b>	
GENERAL MOTORS	1334066
GENERAL MOTORS	9192797
GENERAL MOTORS	90444079
<b>US8963</b>	
FORD	BR3Z 8501-C
FORD	BR3Z 8501-H
<b>US8964</b>	
HYUNDAI	OVN01-15-100
KIA	OVN01-15-100
<b>US8965</b>	
MITSUBISHI	ME015217
MITSUBISHI	ME995424
MITSUBISHI	ME996868
<b>US8967</b>	
NISSAN	21010-BX000
<b>US8968</b>	
CHRYSLER	4648 952AB
CHRYSLER	4648 952AD
<b>US8969</b>	
ISUZU	8-97073-951-0
ISUZU	8-97109-676-0
<b>US8970</b>	
TOYOTA	16100-0H040
TOYOTA	16100-0H050
<b>US8971</b>	
CHRYSLER	5302 2340AC
CHRYSLER	RL022340AC
<b>US8979</b>	
CHRYSLER	5302 2095AD
CHRYSLER	5302 2095AE
CHRYSLER	5302 2095AF
<b>US8980</b>	
FORD	AT4Z8501A
<b>US8981</b>	
CHRYSLER	5184 498AI
CHRYSLER	RL184498AI
<b>US8982</b>	
HYUNDAI	25100-2G500
HYUNDAI	25100-2G510
<b>US8983</b>	
HONDA	19200-RBJ-003
<b>US9003</b>	
FIAT	4331825
FIAT	5882689
<b>US9005</b>	
TOYOTA	16110-38020
<b>US9008</b>	
NISSAN	21010-23028
NISSAN	21010-N8527
NISSAN	21010-U6727
NISSAN	BA010-23028
NISSAN	BA010-N8527
<b>US9009</b>	
NISSAN	21010-21028
NISSAN	21010-21089
<b>US9010</b>	
NISSAN	21010-M6626
NISSAN	BA010-M6626

<b>US9011</b>	
NISSAN	21010-17S27
NISSAN	21010-17SY7
NISSAN	21010-P7586
NISSAN	21010-P7589
<b>US9012</b>	
TOYOTA	16100-25012
TOYOTA	16100-25012-84
<b>US9015</b>	
TOYOTA	16100-19016
TOYOTA	16100-19017-77
<b>US9016</b>	
TOYOTA	16110-26020
TOYOTA	16110-26020-84
<b>US9017</b>	
TOYOTA	16100-39316
TOYOTA	16100-39317
TOYOTA	16100-3931777
<b>US9018</b>	
TOYOTA	16100-26022
TOYOTA	16100-26022-84
TOYOTA	16100-26023
TOYOTA	16100-28020
TOYOTA	16100-28020-77
TOYOTA	16110-26021
TOYOTA	16110-26021-84
TOYOTA	16110-28010
TOYOTA	16110-28010-77
<b>US9020</b>	
MAZDA	0324-15-010D
MAZDA	0324-15-010E
MAZDA	8AS4-15-010A
<b>US9021</b>	
TOYOTA	16100-29047
TOYOTA	16100-29048
<b>US9025</b>	
SUBARU	21110 AA050
SUBARU	21110 AA060
<b>US9026</b>	
NISSAN	21010-H7227
NISSAN	BA010-H7289
<b>US9027</b>	
TOYOTA	16110-38022
TOYOTA	16110-38022-77
<b>US9028</b>	
TOYOTA	16100-19025
<b>US9029</b>	
HONDA	19200-PB2-010
HONDA	19200-PB2-405
<b>US9031</b>	
NISSAN	21010-80W26
NISSAN	21010-80W89
NISSAN	21010-82W25
NISSAN	21010-G3925
NISSAN	21010-G3926
NISSAN	21010-G3928
NISSAN	21010-N5829
NISSAN	21010-N5885
NISSAN	BA010-80W89
<b>US9034</b>	
HONDA	19110-657-335

HONDA	19110-657-405
HONDA	19110-671-335
HONDA	19110-673-335
HONDA	19110-689-335
HONDA	19110-689-405
HONDA	19200-657-010
<b>US9035</b>	
HONDA	19200-PA6-030
HONDA	19200-PC1-000
<b>US9039</b>	
TOYOTA	16100-49045
TOYOTA	16100-49595
TOYOTA	16100-49666
TOYOTA	16110-45100
TOYOTA	16110-49045
TOYOTA	16110-49086-77
<b>US9041</b>	
NISSAN	21010-01M25
NISSAN	21010-50A25
NISSAN	21010-50A27
NISSAN	21010-50A94
NISSAN	21010-50AY8
NISSAN	21010-60UY6
<b>US9044</b>	
NISSAN	21010-16A85
NISSAN	21010-16AY5
<b>US9045</b>	
TOYOTA	16100-19027
TOYOTA	16100-19028-77
TOYOTA	16110-19025
TOYOTA	16110-19026
<b>US9046</b>	
TOYOTA	16110-15020
TOYOTA	16110-15085
TOYOTA	16110-19036
TOYOTA	16110-19036-84
<b>US9048</b>	
TOYOTA	16110-69035
TOYOTA	16110-69036-77
<b>US9049</b>	
VOLVO	270681-0
VOLVO	275619-0
<b>US9050</b>	
MAZDA	8A81-15-010
MAZDA	8ABT-15-010A
MAZDA	E301-15-010A
MAZDA	E301-15-010B
MAZDA	E301-15-010C
<b>US9052</b>	
VOLKSWAGEN / AUDI	035 121 004 A
VOLKSWAGEN / AUDI	035 121 004 AX
VOLKSWAGEN / AUDI	052 121 005 A
<b>US9053</b>	
MAZDA	1757-23-925B
MAZDA	1757-99-151
MAZDA	3648-15-130B
MAZDA	8872-15-0101
MAZDA	8872-15-010B
MAZDA	8872-15-010D
MAZDA	N232-99-153A
MAZDA	N232-99-153B
MAZDA	N304-15-010C

<b>US9056</b>	
HONDA	19200-PD2-660
HONDA	19200-PD6-000
HONDA	19210-PD2-515
HONDA	19210-PD6-505
HONDA	19210-PD6-515
<b>US9057</b>	
GENERAL MOTORS	94840612
GENERAL MOTORS	94847609
TOYOTA	16110-19046
TOYOTA	16110-19047-77
TOYOTA	16110-19076
TOYOTA	16110-19086
<b>US9058</b>	
NISSAN	21010-02P26
NISSAN	21010-02P27
NISSAN	21010-02P85
<b>US9059</b>	
TOYOTA	16100-64H05
TOYOTA	16100-69085
TOYOTA	16100-69275
<b>US9060</b>	
MAZDA	8AG7-15-010A
MAZDA	F801-15-010C
MAZDA	F801-15-010D
MAZDA	FE79-15-010B
MAZDA	FE79-15-010C
<b>US9061</b>	
VOLKSWAGEN / AUDI	025 121 010 AX
VOLKSWAGEN / AUDI	026 121 010 DX
<b>US9063</b>	
NISSAN	21010-V5528
NISSAN	BA010-V5589
<b>US9064</b>	
TOYOTA	16100-19056
TOYOTA	16100-19166
<b>US9065</b>	
VOLKSWAGEN / AUDI	026 121 005 C
VOLKSWAGEN / AUDI	026 121 005 G
VOLKSWAGEN / AUDI	026 121 005 H
VOLKSWAGEN / AUDI	026 121 005 JX
VOLKSWAGEN / AUDI	037 121 005 B
VOLKSWAGEN / AUDI	037 121 005 C
VOLKSWAGEN / AUDI	037 121 010 C
VOLKSWAGEN / AUDI	068 121 005 A
<b>US9066</b>	
VOLKSWAGEN / AUDI	068 121 005 B
VOLKSWAGEN / AUDI	068 121 005 C
<b>US9067</b>	
MAZDA	8AG6-15-010A
FORD	E43Z 8501-B
FORD	E7FZ 8501-B
KIA	RF01-99-154
KIA	RF01-99-154A
<b>US9068</b>	
VOLVO	271275-0
VOLVO	271975-0
<b>US9069</b>	
HONDA	19200-PE0-010
HONDA	19200-PE0-415
HONDA	19200-PE0-515

<b>US9071</b>	
VOLKSWAGEN / AUDI	069 121 005 D
VOLVO	1257185-0
<b>US9074</b>	
NISSAN	B1010-16E03
FORD	F3XZ 8501-BA
<b>US9075</b>	
TOYOTA	16110-19155
<b>US9076</b>	
GENERAL MOTORS	94844775
TOYOTA	16110-16020-84
TOYOTA	16110-19115
<b>US9077</b>	
VOLVO	461094-0
<b>US9078</b>	
TOYOTA	16100-60080
<b>US9080</b>	
SUBARU	21110 AA025
SUBARU	21110 AA026
<b>US9082</b>	
MG	GWP130
<b>US9083</b>	
HONDA	19200-PH1-000
HONDA	19210-PH1-515
<b>US9084</b>	
FIAT	5936404
FIAT	5936406
FIAT	5960469
FIAT	5980756
FIAT	5983960
FIAT	7784974
<b>US9085</b>	
FIAT	4429226
FIAT	7671808
FIAT	7671810
<b>US9086</b>	
TOYOTA	16100-19066
TOYOTA	16100-19066-84
<b>US9087</b>	
TOYOTA	16110-79095
<b>US9092</b>	
TOYOTA	16100-79036
TOYOTA	16100-79036-77
<b>US9093</b>	
SUBARU	21110 AA070
<b>US9094</b>	
TOYOTA	16100-59127
TOYOTA	16100-59129
<b>US9097</b>	
HONDA	19200-P0G-A01
HONDA	19200-PH7-003
STERLING	26526500010
<b>US9098</b>	
TOYOTA	16110-19065-84
<b>US9099</b>	
TOYOTA	16110-79026-83
<b>US9100</b>	
TOYOTA	16100-49776

TOYOTA	16100-49805-83
<b>US9102</b>	
MAZDA	8AF2-15-010B
MAZDA	8AF2-15-010C
MAZDA	8AF3-15-010A
MAZDA	8AF3-15-010B
MAZDA	8AF4-15-010B
<b>US9104</b>	
NISSAN	21010-12G26
NISSAN	21010-12G28
<b>US9105</b>	
ISUZU	8-94146-326-0
ISUZU	8-94146-326-1
ISUZU	8-94332-637-1
ISUZU	8-94376-846-0
ISUZU	8-97021-773-0
ISUZU	8-97081-624-0
<b>US9106</b>	
ISUZU	8-94131-330-1
ISUZU	8-94332-636-0
ISUZU	8-94376-845-0
<b>US9107</b>	
SAAB	93 21 670
<b>US9108</b>	
SAAB	75 07 460
SAAB	88 17 900
<b>US9109</b>	
SUBARU	21110 AA110
<b>US9110</b>	
NISSAN	21010-17C28
<b>US9111</b>	
MAZDA	FE79-15-010E
MAZDA	FE79-15-010RMJ
<b>US9114</b>	
NISSAN	21010-D0126
NISSAN	BA010-D0126
<b>US9115</b>	
HONDA	19210-PG6-305
<b>US9116</b>	
NISSAN	21010-06EY6
NISSAN	BA010-06E26
<b>US9117</b>	
BMW	11 51 1 312 129
BMW	11 51 1 312 539
BMW	11 51 1 707 415
BMW	11 51 1 720 883
BMW	11 51 9 070 761
<b>US9119</b>	
BMW	11 51 1 706 588
BMW	11 51 1 711 492
BMW	11 51 9 071 562
<b>US9120</b>	
BMW	11 51 1 719 836
BMW	11 51 1 720 609
BMW	11 51 9 070 759
<b>US9122</b>	
BMW	11 51 1 705 236
BMW	11 51 9 070 757
<b>US9128</b>	
BMW	11 51 0 007 040



# WATER PUMP QUICK REFERENCE



<b>US9129</b>	
HONDA	19210-PK2-305
<b>US9130</b>	
HONDA	19200-P01-004
HONDA	19200-P10-A02
<b>US9131</b>	
HONDA	19210-PH3-305
<b>US9132</b>	
GENERAL MOTORS	94239649
ISUZU	8-94120-768-1
ISUZU	8-94239-649-0
ISUZU	8-94376-837-0
ISUZU	8-94376-859-1
<b>US9133</b>	
ISUZU	8-94174-226-2
ISUZU	8-94332-638-2
ISUZU	8-94376-847-0
ISUZU	8-97021-774-0
ISUZU	8-97081-623-0
<b>US9140</b>	
TOYOTA	16110-79115
<b>US9141</b>	
TOYOTA	16100-39346-83
<b>US9142</b>	
TOYOTA	16100-69465-83
<b>US9145</b>	
TOYOTA	16100-69475-83
<b>US9146</b>	
VOLVO	1218158-0
<b>US9147</b>	
VOLVO	1218096-0
<b>US9149</b>	
BMW	11 51 1 258 933
BMW	11 51 9 070 752
<b>US9150</b>	
VOLKSWAGEN / AUDI	025 121 010 CX
<b>US9152</b>	
BMW	11 51 1 721 477
BMW	11 51 9 070 755
<b>US9153</b>	
BMW	11 51 1 256 600
BMW	11 51 9 056 401
<b>US9154</b>	
BMW	11 51 2 241 641
BMW	11 51 9 070 765
FORD	E45Y 8501-A
<b>US9155</b>	
TOYOTA	16100-69255
TOYOTA	16110-61180
<b>US9158</b>	
SAAB	83 46 546
<b>US9159</b>	
SAAB	83 58 491
AMERICAN MOTORS	8358 491
<b>US9160</b>	
ISUZU	8-94376-868-0
ISUZU	8-94437-048-1

<b>US9161</b>	
SUBARU	21110 AA016
SUBARU	21110 AA017
<b>US9162</b>	
NISSAN	21010-30R05
NISSAN	21010-30R06
<b>US9163</b>	
JAGUAR	EAC7242
JAGUAR	EAC9213
JAGUAR	EBC4437
JAGUAR	EBC8550
<b>US9165</b>	
JAGUAR	EAC3033
JAGUAR	JLM 10819
JAGUAR	JLM10648
JAGUAR	JLM10819
JAGUAR	JLM361
JAGUAR	JLM9697
<b>US9166</b>	
MAZDA	8AH3-15-010A
MAZDA	8AH3-15-010B
MAZDA	JE96-15-010RMB
MAZDA	JF03-15-010RME
<b>US9167</b>	
MAZDA	8AL1-15-010A
MAZDA	8AL1-15-010C
<b>US9168</b>	
CHRYSLER	MD972053
CHRYSLER	MD997622
<b>US9170</b>	
TOYOTA	16110-49025
TOYOTA	16110-49026-77
<b>US9171</b>	
VOLKSWAGEN / AUDI	034 121 004
VOLKSWAGEN / AUDI	034 121 004 X
<b>US9172</b>	
MERCEDES-BENZ	110 200 17 20
<b>US9173</b>	
MERCEDES-BENZ	102 200 42 01
<b>US9175</b>	
MERCEDES-BENZ	102 200 62 01
<b>US9176</b>	
MERCEDES-BENZ	117 200 38 01
<b>US9177</b>	
PORSCHE	060 121 010 X
PORSCHE	060 121 011
<b>US9178</b>	
MERCEDES-BENZ	115 200 1220
MERCEDES-BENZ	115 200 1620
<b>US9179</b>	
NISSAN	21010-13200
NISSAN	21010-13201
NISSAN	21010-13202
NISSAN	21010-13205
NISSAN	21010-13206
NISSAN	21010-13225
NISSAN	21010-13226
<b>US9180</b>	
TOYOTA	16110-45070
TOYOTA	16120-41060

TOYOTA	16120-42011
<b>US9189</b>	
TOYOTA	16100-61012
TOYOTA	16100-61041
TOYOTA	16100-61130
<b>US9193</b>	
PEUGEOT	1201 71
PEUGEOT	1202 82
<b>US9198</b>	
NISSAN	21010-09W25
NISSAN	21010-31W26
<b>US9200</b>	
TOYOTA	16100-59137
TOYOTA	16100-59139
<b>US9201</b>	
NISSAN	21010-22P25
NISSAN	B1010-22P27
<b>US9202</b>	
MERCEDES-BENZ	103 200 37 01
<b>US9203</b>	
FIAT	4129810
FIAT	4129812
FIAT	5882684
<b>US9206</b>	
NISSAN	21010-40F25
NISSAN	21010-86G00
NISSAN	21010-86G25
NISSAN	B1010-40F27
<b>US9207</b>	
NISSAN	21010-77A00
NISSAN	21010-77AY0
<b>US9208</b>	
MAZDA	8AFB-15-010A
MAZDA	8AFC-15-010A
MAZDA	8AFD-15-010
<b>US9209</b>	
HONDA	19200-POA-003
ISUZU	5-86202-375-0
<b>US9211</b>	
JAGUAR	JLM 398
JAGUAR	JLM9696
<b>US9212</b>	
HYUNDAI	25100-33132
CHRYSLER	MD972052
CHRYSLER	MD997417
<b>US9213</b>	
NISSAN	21010-53J05
<b>US9214</b>	
NISSAN	21010-0M302
NISSAN	21010-53Y01
NISSAN	21010-88R00
NISSAN	21010-88R10
NISSAN	21010-F4300
<b>US9215</b>	
SUBARU	21111 AA026
SUBARU	21111 AA240
SUBARU	21111 AA250
SAAB	32 00 5906
<b>US9216</b>	
TOYOTA	16100-79165-83



<b>US9218</b>	
HONDA	19200-PY3-010
<b>US9219</b>	
HONDA	19200-PR7-305
HONDA	19200-PR7-A01
HONDA	19200-PR7-A02
HONDA	19200-PR7-A03
<b>US9220</b>	
GENERAL MOTORS	94360200
ISUZU	8-97031-473-0
<b>US9221</b>	
GENERAL MOTORS	97031472
ISUZU	8-97031-472-0
<b>US9222</b>	
MERCEDES-BENZ	104 200 31 01
<b>US9223</b>	
SUBARU	21111 AA007
SUBARU	21111 AA110
SAAB	32 00 5905
SAAB	32 01 0616
<b>US9224</b>	
HONDA	19200-PR4-013
<b>US9225</b>	
MAZDA	8AH6-15-010
MAZDA	8AH6-15-010B
<b>US9226</b>	
VOLKSWAGEN / AUDI	077 121 004 A
VOLKSWAGEN / AUDI	077 121 004 G
<b>US9227</b>	
SUZUKI	17400-73001
SUZUKI	17400-73002
SUZUKI	17400-73003
SUZUKI	17400-73012
SUZUKI	17400-73013
SUZUKI	17400-73810
SUZUKI	17400-73811
SUZUKI	17400-73812
<b>US9228</b>	
MERCEDES-BENZ	602 200 04 20
MERCEDES-BENZ	605 200 08 20
<b>US9230</b>	
MERCEDES-BENZ	117 200 33 01
<b>US9231</b>	
MERCEDES-BENZ	116 200 17 01
<b>US9232</b>	
SUZUKI	17400-78820
SUZUKI	17400-78821
<b>US9234</b>	
BMW	11 51 1 315 563
<b>US9236</b>	
BMW	11 51 0 007 041
<b>US9237</b>	
DAIHATSU	16100-87182-000
<b>US9238</b>	
DAIHATSU	16100-87790-000
<b>US9239</b>	
NISSAN	21010-60U26

<b>US9241</b>	
PORSCHE	928 106 015 20
<b>US9242</b>	
PORSCHE	928 106 015 11
PORSCHE	928 106 015 22
<b>US9245</b>	
PORSCHE	944 106 021 09
PORSCHE	944 106 021 13
PORSCHE	951 106 021 10
<b>US9250</b>	
HONDA	19200-P08-004
<b>US9251</b>	
HONDA	19200-P14-A01
<b>US9252</b>	
NISSAN	21010-97E00
<b>US9253</b>	
HONDA	19200-PV1-A01
HONDA	19200-PV3-003
<b>US9254</b>	
SUBARU	21111 AA033
<b>US9255</b>	
SUBARU	21111 AA065
<b>US9256</b>	
TOYOTA	16100-49837-83
TOYOTA	16110-49115
TOYOTA	16110-49116
<b>US9257</b>	
TOYOTA	16100-09200
TOYOTA	16100-09201
TOYOTA	16100-50023-83
TOYOTA	16100-59275-83
<b>US9258</b>	
TOYOTA	16100-69455-83
<b>US9259</b>	
FORD	F32Z 8501-A
<b>US9260</b>	
MAZDA	8AH7-15-010A
<b>US9261</b>	
BMW	11 51 1 433 828
BMW	11 51 1 722 536
BMW	11 51 1 730 414
BMW	11 51 1 740 241
BMW	11 51 1 744 243
BMW	11 51 7 527 799
BMW	11 51 7 527 910
BMW	11 51 7 546 994
BMW	11 51 7 563 183
<b>US9262</b>	
VOLKSWAGEN / AUDI	021 121 004
VOLKSWAGEN / AUDI	021 121 004 A
VOLKSWAGEN / AUDI	021 121 004 AX
VOLKSWAGEN / AUDI	021 121 004 X
<b>US9263</b>	
VOLKSWAGEN / AUDI	078 121 004 C
VOLKSWAGEN / AUDI	078 121 004 CX
<b>US9264</b>	
SAAB	93 21 688
<b>US9266</b>	
MAZDA	N3A1-15-010D

MAZDA	N3A2-15-010D
MAZDA	N3C1-15-010
MAZDA	N3C1-15-010D
MAZDA	N3C2-15-010
MAZDA	N3C2-15-010D
<b>US9268</b>	
NISSAN	B1010-0P529
<b>US9269</b>	
TOYOTA	16100-69325
<b>US9270</b>	
NISSAN	21010-1E400
NISSAN	21010-1E401
NISSAN	21010-1E403
NISSAN	21010-1E4Y0
NISSAN	21010-F4400
<b>US9271</b>	
GENERAL MOTORS	94856254
TOYOTA	16110-19146
TOYOTA	16110-19205
<b>US9272</b>	
GENERAL MOTORS	94854103
TOYOTA	16110-19176
TOYOTA	16110-19185
<b>US9273</b>	
HONDA	19200-P13-003
<b>US9274</b>	
VOLKSWAGEN / AUDI	074 121 005 M
VOLKSWAGEN / AUDI	074 121 005 N
<b>US9275</b>	
BMW	11 51 0 393 338
BMW	11 51 1 721 872
BMW	11 51 1 727 468
BMW	11 51 1 734 595
BMW	11 51 1 734 602
<b>US9276</b>	
BMW	11 51 0 007 042
<b>US9277</b>	
MERCEDES-BENZ	120 200 11 01
<b>US9278</b>	
ISUZU	8-97061-280-0
ISUZU	8-97125-975-0
<b>US9279</b>	
VOLKSWAGEN / AUDI	054 121 004 A
VOLKSWAGEN / AUDI	054 121 004 AX
<b>US9280</b>	
JAGUAR	NBB2200DA
<b>US9282</b>	
RENAULT	7701 452 155
RENAULT	7701 457 416
RENAULT	7701 502 962
RENAULT	7702 001 510
<b>US9284</b>	
NISSAN	21010-50A89
NISSAN	21010-B17G2
<b>US9288</b>	
HONDA	19200-PY3-A00
<b>US9289</b>	
HONDA	19200-P72-003

<b>US9291</b>	
TOYOTA	16100-69495-83
<b>US9292</b>	
TOYOTA	16110-49097
TOYOTA	16110-49125
TOYOTA	16110-49126
<b>US9293</b>	
TOYOTA	16100-79445-83
<b>US9295</b>	
MAZDA	0459-15-010
MAZDA	0459-99-151
<b>US9296</b>	
TOYOTA	16100-49415
TOYOTA	16100-49416
TOYOTA	16100-49425
<b>US9299</b>	
MERCEDES-BENZ	110 200 02 20
MERCEDES-BENZ	110 200 20 20
MERCEDES-BENZ	110 201 00 10
<b>US9300</b>	
MAZDA	0305-15-010D
MAZDA	0305-15-010E
MAZDA	0305-99-151
<b>US9301</b>	
RENAULT	7701 457 670
RENAULT	7701 505 397
<b>US9302</b>	
ISUZU	8-94439-850-1
ISUZU	8-97021-171-0
<b>US9304</b>	
NISSAN	B1010-67U28
<b>US9305</b>	
KIA	0K24A-15-010
MAZDA	8ABB-15-010A
MAZDA	B6BF-15-010F
MAZDA	B6BF-15-010RMF
MAZDA	ZL01-15-010
<b>US9306</b>	
TOYOTA	16100-29085
<b>US9307</b>	
SAAB	59 60 414
SAAB	88 22 710
SAAB	88 22 793
SAAB	93 16 6829
<b>US9309</b>	
NISSAN	21010-31U25
NISSAN	21010-31U26
NISSAN	21010-31U27
NISSAN	21010-31U28
NISSAN	21010-31U29
NISSAN	21010-31U85
<b>US9310</b>	
CHRYSLER	MD972440
<b>US9311</b>	
MERCEDES-BENZ	104 200 44 01
<b>US9312</b>	
MERCEDES-BENZ	104 200 32 01
<b>US9313</b>	
MERCEDES-BENZ	104 200 33 01

<b>US9314</b>	
MERCEDES-BENZ	111 200 23 01
<b>US9315</b>	
MERCEDES-BENZ	119 200 15 01
<b>US9318</b>	
FORD	F42Z 8501-A
MAZDA	KL47-15-010C
MAZDA	KL47-15-010RMC
<b>US9320</b>	
TOYOTA	16100-69385
<b>US9321</b>	
HONDA	19200-P30-003
<b>US9324</b>	
TOYOTA	16100-69398-83
<b>US9325</b>	
TOYOTA	16100-69535
<b>US9328</b>	
MAZDA	KJ01-15-010H
<b>US9332</b>	
BMW	11 51 0 007 043
BMW	11 51 1 742 517
<b>US9333</b>	
VOLKSWAGEN / AUDI	078 121 004 H
VOLKSWAGEN / AUDI	078 121 004 HX
VOLKSWAGEN / AUDI	078 121 004 J
VOLKSWAGEN / AUDI	078 121 004 JX
VOLKSWAGEN / AUDI	078 121 004 QX
VOLKSWAGEN / AUDI	078 121 006 X
<b>US9334</b>	
TOYOTA	16110-19106
<b>US9335</b>	
VOLKSWAGEN / AUDI	028 121 004
VOLKSWAGEN / AUDI	028 121 004 V
VOLKSWAGEN / AUDI	028 121 004 X
<b>US9337</b>	
TOYOTA	16110-61081
TOYOTA	16110-61081-77
<b>US9338</b>	
NISSAN	21010-0W002
NISSAN	21010-0W003
NISSAN	21010-0W025
NISSAN	21010-0W027
NISSAN	21010-4S10A
NISSAN	21010-4S125
NISSAN	21010-4S126
<b>US9339</b>	
VOLVO	271855-0
VOLVO	271985-0
VOLVO	271986-0
VOLVO	30684432-0
VOLVO	30751700-0
VOLVO	8694626-0
VOLVO	8694627-0
VOLVO	8694630-0
<b>US9340</b>	
VOLVO	8694628-0
<b>US9342</b>	
GENERAL MOTORS	91174494
SUZUKI	17400-77810
SUZUKI	17400-77812

SUZUKI	17400-77813
SUZUKI	17400-78890
SUZUKI	17400-78892
SUZUKI	17400-85Z01
<b>US9343</b>	
MERCEDES-BENZ	104 200 48 01
<b>US9344</b>	
MERCEDES-BENZ	104 200 49 01
MERCEDES-BENZ	104 200 54 01
MERCEDES-BENZ	104 200 57 01
<b>US9345</b>	
MERCEDES-BENZ	104 200 47 01
<b>US9346</b>	
MERCEDES-BENZ	119 200 21 01
<b>US9347</b>	
HONDA	19200-P1R-003
<b>US9348</b>	
HONDA	19200-P5G-004
<b>US9349</b>	
HONDA	19200-P75-003
<b>US9351</b>	
MERCEDES-BENZ	104 200 58 01
<b>US9352</b>	
HONDA	19200-P2A-A01
<b>US9353</b>	
HYUNDAI	25100-23001
HYUNDAI	25100-23002
HYUNDAI	25100-23003
HYUNDAI	25100-23010
HYUNDAI	25100-23530
<b>US9354</b>	
HONDA	19200-P5A-004
<b>US9356</b>	
JAGUAR	EBC10566
JAGUAR	EBC10967
<b>US9359</b>	
CHRYSLER	MD365087
<b>US9360</b>	
CHRYSLER	MD309756
<b>US9362</b>	
VOLKSWAGEN / AUDI	077 121 004 F
VOLKSWAGEN / AUDI	077 121 004 HX
<b>US9364</b>	
HYUNDAI	25100-22900
HYUNDAI	25100-26900
HYUNDAI	25100-26902
KIA	25100-26902
<b>US9365</b>	
ISUZU	8-97167-554-0
<b>US9367</b>	
TOYOTA	16110-19107
<b>US9368</b>	
LAND ROVER	RTC 6339
LAND ROVER	STC 483
<b>US9369</b>	
LAND ROVER	ST 1693
LAND ROVER	ST 4378

<b>US9370</b>	
MERCEDES-BENZ	617 200 06 20
<b>US9371</b>	
MAZDA	8ABC-15-010
MAZDA	8ABE-15-010
MAZDA	ZL01-15-010A
<b>US9374</b>	
GENERAL MOTORS	91174230
SUZUKI	17400-61820
<b>US9375</b>	
ISUZU	8-90466-343-0
ISUZU	8-92064-250-0
ISUZU	8-92065-969-0
ISUZU	8-93284-724-0
<b>US9376</b>	
GENERAL MOTORS	88973887
GENERAL MOTORS	94858649
TOYOTA	16100-09170
<b>US9377</b>	
VOLKSWAGEN / AUDI	06A 121 011 F
VOLKSWAGEN / AUDI	06A 121 011 L
VOLKSWAGEN / AUDI	06A 121 011 LX
VOLKSWAGEN / AUDI	06A 121 011 T
VOLKSWAGEN / AUDI	06A 121 011 TX
VOLKSWAGEN / AUDI	06A 121 012
VOLKSWAGEN / AUDI	06A 121 012 X
<b>US9378</b>	
VOLKSWAGEN / AUDI	038 121 011 A
VOLKSWAGEN / AUDI	038 121 011 AX
VOLKSWAGEN / AUDI	038 121 011 J
VOLKSWAGEN / AUDI	038 121 011 JX
VOLKSWAGEN / AUDI	045 121 011 H
<b>US9379</b>	
MERCEDES-BENZ	112 200 15 01
CHRYSLER	5097 158AA
CHRYSLER	5097 159AA
CHRYSLER	5097 159AC
CHRYSLER	5102 893AA
CHRYSLER	5102 894AA
<b>US9380</b>	
MERCEDES-BENZ	112 200 14 01
<b>US9382</b>	
VOLVO	3121900-0
<b>US9383</b>	
HONDA	19200-P8A-A01
HONDA	19200-P8A-A02
HONDA	19200-P8A-A03
<b>US9385</b>	
GENERAL MOTORS	91176170
SUZUKI	17400-66810
SUZUKI	17400-85830
<b>US9388</b>	
NISSAN	B1010-1P128
<b>US9389</b>	
CHRYSLER	MD972934
<b>US9393</b>	
KIA	0K247-15-010A
KIA	0K247-15-010B
KIA	25100-2Y000
KIA	25100-2Y010
KIA	25100-2Y011

<b>US9394</b>	
MAZDA	8AL4-15-010
MAZDA	8AL4-15-010A
MAZDA	JE96-15-010B
MAZDA	JE96-15-010RM
<b>US9395</b>	
TOYOTA	16110-49156
<b>US9396</b>	
ALFA ROMEO	60555345
ALFA ROMEO	60703264
ALFA ROMEO	60534336
<b>US9399</b>	
KIA	25100-38002
HYUNDAI	25100-38200
KIA	25100-38200
CHRYSLER	MD976464
CHRYSLER	MD976943
<b>US9400</b>	
ALFA ROMEO	60534758
<b>US9401</b>	
VOLKSWAGEN / AUDI	026 121 005 L
VOLKSWAGEN / AUDI	050 121 010 CX
<b>US9402</b>	
NISSAN	21010-7B000
FORD	XF5Z 8501-AA
FORD	XF5Z 8501-BA
<b>US9403</b>	
HONDA	19210-PCX-003
<b>US9405</b>	
GENERAL MOTORS	88972819
GENERAL MOTORS	88974712
TOYOTA	16100-29145
TOYOTA	16100-29146
TOYOTA	16100-29415-83
<b>US9406</b>	
TOYOTA	16100-29156-83
<b>US9410</b>	
VOLKSWAGEN / AUDI	077 121 004 M
VOLKSWAGEN / AUDI	077 121 004 MX
VOLKSWAGEN / AUDI	077 121 004 N
VOLKSWAGEN / AUDI	077 121 004 NX
VOLKSWAGEN / AUDI	077 121 004 P
VOLKSWAGEN / AUDI	077 121 004 PX
VOLKSWAGEN / AUDI	079 121 011 H
VOLKSWAGEN / AUDI	079 121 011 Q
VOLKSWAGEN / AUDI	079 121 012 B
VOLKSWAGEN / AUDI	079 121 014 D
VOLKSWAGEN / AUDI	079 121 014 F
<b>US9414</b>	
TOYOTA	19185381
TOYOTA	16100-28041
<b>US9415</b>	
CHRYSLER	MD979171
<b>US9416</b>	
NISSAN	21010-F4600
<b>US9419</b>	
HONDA	19200-PLM-A01
<b>US9421</b>	
SUBARU	21110 AA360
SUBARU	21110 AA510

<b>US9426</b>	
SUZUKI	17400-82Z00
NISSAN	21010-7Y00A
NISSAN	21010-7Y025
NISSAN	21010-7Y026
NISSAN	21010-AL525
NISSAN	21010-AL526
NISSAN	21010-AL527
NISSAN	21010-AL528
NISSAN	21010-JK00A
NISSAN	B1010-JK20A
<b>US9427</b>	
NISSAN	21010-6N226
NISSAN	21010-8J000
NISSAN	21010-F461A
NISSAN	21010-F462A
NISSAN	B1010-F461B
<b>US9429</b>	
VOLKSWAGEN / AUDI	06C 121 004 H
VOLKSWAGEN / AUDI	06C 121 004 HX
<b>US9434</b>	
HONDA	19200-PNA-003
HONDA	19200-PNL-E01
HONDA	19200-RBB-013
HONDA	19200-RFE-003
<b>US9440</b>	
MERCEDES-BENZ	111 200 40 01
MERCEDES-BENZ	111 200 42 01
<b>US9446</b>	
VOLKSWAGEN / AUDI	078 121 006 A
VOLKSWAGEN / AUDI	078 121 006 AX
<b>US9448</b>	
KIA	25100-39800
KIA	25100-39802
<b>US9450</b>	
KIA	25100-3X000
<b>US9460</b>	
CHRYSLER	1300A012
<b>US9461</b>	
HONDA	19200-RAA-A01
HONDA	19200-RAD-003
<b>US9462</b>	
KIA	25100-37102
KIA	25100-37201
HYUNDAI	25100-37202
KIA	25100-37202
KIA	25100-3E000
<b>US9463</b>	
HYUNDAI	25100-39010
KIA	25100-39010
HYUNDAI	25100-39012
KIA	25100-39012
<b>US9464</b>	
BMW	11 51 1 741 980
<b>US9465</b>	
BMW	11 51 0 393 336
BMW	11 51 0 393 337
BMW	11 51 0 393 339
<b>US9467</b>	
BMW	11 51 1 714 212



<b>US9468</b>	
HONDA	19200-P72-013
<b>US9470</b>	
GENERAL MOTORS	12581517
GENERAL MOTORS	12635743
HONDA	19200-R70-A11
HONDA	19200-RCA-A01
HONDA	19200-RDM-A01
HONDA	19200-RDM-A02
HONDA	19200-RDV-J01
<b>US9471</b>	
VOLKSWAGEN / AUDI	022 121 011
VOLKSWAGEN / AUDI	022 121 011 V
VOLKSWAGEN / AUDI	022 121 011 X
<b>US9472</b>	
SUBARU	21111 AA230
<b>US9473</b>	
KIA	0K30E-15-010
KIA	25100-2X401
<b>US9474</b>	
BMW	11 51 7 513 062
<b>US9475</b>	
PORSCHE	996 106 011 53
PORSCHE	996 106 011 55
PORSCHE	997 101 011 02
PORSCHE	997 106 011 05
PORSCHE	997 106 011 70
PORSCHE	997 106 011 71
<b>US9476</b>	
TOYOTA	16100-59276
<b>US9477</b>	
CHRYSLER	25100-38200
<b>US9486</b>	
SUBARU	21118 KA000
SUBARU	21135 KA000
<b>US9487</b>	
RENAULT	7701 452 781
RENAULT	7701 457 771
RENAULT	7701 461 173
RENAULT	7702 452 782
<b>US9488</b>	
NISSAN	21010-7S000
NISSAN	21010-AR725
<b>US9489</b>	
FORD	9L8Z 8501-C
MAZDA	AJ57-15-010
MAZDA	AJ57-15-010A
MAZDA	AJ57-15-010B
MAZDA	AJTM-15-010
<b>US9493</b>	
TOYOTA	16100-61070
TOYOTA	16100-61080
<b>US9494</b>	
HONDA	19210-PHM-010
<b>US9495</b>	
HONDA	19200-PRB-A01
HONDA	19200-RBC-013
<b>US9496</b>	
LAND ROVER	PEB 102240L

<b>US4030N</b>	
FORD	E2TZ 8501-A
FORD	E9PZ 8501-D
<b>US65N</b>	
GENERAL MOTORS	89018052
<b>US9033N</b>	
HONDA	19110-634-375
HONDA	19110-634-405
<b>US9040N</b>	
TOYOTA	16100-49655
TOYOTA	16100-49656-77
<b>US9043N</b>	
HONDA	19200-PE8-405
HONDA	19200-PE8-600

**ALFA ROMEO**

60534758	US9400
60555345	US9396
60703264	US9396
60534336	US9396

**AM GENERAL**

5740079	US5008
5743241	US5062
5743939	US5049
5744474	US5074
5744662	US5074
5744938	US5074
5745093	US5086

**AMERICAN MOTORS**

3209 691	US843
4797 143	US3414
8120 236	US986
8130 749	US3403
8132 274	US1107
8133 033	US3403
8133 034	US3404
8350 2957	US3414
8358 491	US9159
J8120 129	US843
J8121 236	US986
J813 4320	US3403
J813 4321	US3404
JR77 5046	US3403
JR77 5047	US3413

**BMW**

11 51 0 007 040	US9128
11 51 0 007 041	US9236
11 51 0 007 042	US9276
11 51 0 007 043	US9332
11 51 0 393 336	US9465
11 51 0 393 337	US9465
11 51 0 393 338	US9275
11 51 0 393 339	US9465
11 51 0 393 340	US8926
11 51 1 256 600	US9153
11 51 1 258 933	US9149
11 51 1 312 129	US9117
11 51 1 312 539	US9117
11 51 1 315 563	US9234
11 51 1 433 828	US9261
11 51 1 705 236	US9122
11 51 1 706 588	US9119
11 51 1 707 415	US9117
11 51 1 711 492	US9119
11 51 1 714 212	US9467
11 51 1 719 836	US9120
11 51 1 720 609	US9120
11 51 1 720 883	US9117
11 51 1 721 477	US9152
11 51 1 721 872	US9275
11 51 1 722 536	US9261
11 51 1 727 468	US9275
11 51 1 730 414	US9261
11 51 1 734 595	US9275
11 51 1 734 602	US9275
11 51 1 740 241	US9261
11 51 1 741 980	US9464
11 51 1 742 517	US9332
11 51 1 744 243	US9261
11 51 2 241 641	US9154
11 51 7 513 062	US9474
11 51 7 527 799	US9261

11 51 7 527 910	US9261
11 51 7 546 994	US9261
11 51 7 550 484	US6244
11 51 7 563 183	US9261
11 51 7 586 779	US6238
11 51 8 604 888	US6244
11 51 9 056 401	US9153
11 51 9 070 752	US9149
11 51 9 070 755	US9152
11 51 9 070 757	US9122
11 51 9 070 759	US9120
11 51 9 070 761	US9117
11 51 9 070 765	US9154
11 51 9 071 562	US9119

**CHERY**

BJ040315Z	US8943
BJ060510ZC	US8943

**CHRYSLER**

1752422	US919
2421375	US919
2448315	US919
2485385	US919
3004762	US919
3004991	US919
1063 326	US713
1064 750	US713
1300A011	US7152
1300A012	US9460
1300A055	US6240
1300A065	US6159
1300A066	US6149
1300A067	US6159
1300A069	US6228
2402 903	US7103
25100-21000	US7115
25100-22650	US7115
25100-38200	US9477
2585 291	US918
2808 679	US7100
3004 715	US918
3234 427	US3401
3780 108	US1053
3780 109	US7103
3780 127	US1040
3837 641	US7103
4106 034	US7100
4131 243	US7100
4173 703	US7113
4272 919	US7113
4293 898	US7110
4323 148	US7110
4387 457	US7122
4448 878	US7126
4483 453	US7127
4483 754	US7128
4556 541	US7141
4621 172	US7127
4621 489	US7153
4626 054	US7136
4626 054AD	US7136
4626 054AE	US7136
4626 215	US3412
4626 215AD	US3412
4626 215AE	US3412
4626 682	US7139
4648 952AB	US8968
4648 952AD	US8968

4648 952AE	US6231
4648 952BA	US6231
4654 392AB	US7126
4663 296	US7151
4663 296AB	US7158
4663 732	US7161
4663 732AB	US7161
4663 732AC	US7161
4663 732AD	US7161
4666 044AA	US8960
4667 660	US7150
4667 660AB	US7150
4667 660AE	US7150
4694 307	US7156
4694 307AB	US7156
4694 307AC	US7156
4694 307AE	US7156
4694307	US7156
4728 533	US7103
4781 157AA	US7165
4781 157AB	US7165
4792 195	US7162
4792 195AB	US7162
4792 838AA	US8940
4792 838AB	US8940
4792 968AD	US8951
4797 143	US3414
4882 837AB	US7141
4884 159AA	US7167
4892 225AA	US7161
4892 425AA	US6217
4897 531AA	US7169
5003 085AA	US7151
5010 898AA	US7126
5010 964AB	US7145
5012 366AA	US7164
5012 366AB	US7164
5012 366AC	US7164
5012 366AD	US7164
5037 164 AE	US7166
5037 164AB	US7166
5037 164AC	US7166
5047 138AA	US6038
5047 138AB	US6038
5086 959AA	US7145
5097 158AA	US9379
5097 159AA	US9379
5097 159AC	US9379
5102 893AA	US9379
5102 894AA	US9379
5103 576AA	US6008
5138 057AA	US6007
5175 580AA	US6155
5184 498AI	US8981
5203 432	US7110
5214 490	US7101
5240 630	US7101
5245 357	US7137
5245 465	US7146
5245 720	US7146
5281 175	US7140
5300 5877	US7169
5300 8354	US7159
5302 0185	US7103
5302 0280	US7160
5302 0873AB	US7163
5302 0873AC	US7163
5302 1018	US7160
5302 1018AB	US7160



# WATER PUMP CROSS REFERENCE



5302 1018AC	US7160
5302 1018AD	US7160
5302 1074AB	US7169
5302 1074AC	US7169
5302 1074AE	US7169
5302 1074AF	US7169
5302 1187AA	US7163
5302 1380AG	US7168
5302 1380AK	US7168
5302 1380AL	US7168
5302 1380AM	US7168
5302 1844AA	US7169
5302 2058AA	US7163
5302 2095AD	US8979
5302 2095AE	US8979
5302 2095AF	US8979
5302 2189AA	US7163
5302 2189AB	US7163
5302 2189AC	US7163
5302 2192AE	US6341
5302 2192AF	US6341
5302 2192AJ	US6341
5302 2340AC	US8971
6800 3402AA	US6222
6800 3402AB	US6222
6804 5797AA	US7163
6804 6026AA	US6038
6807 9412AB	US6699
6807 9412AC	US6699
6808 7367AA	US6155
7124 4450	US1010
7522 1515	US1010
8120 131	US1021
8125 131	US3401
8125 501	US1077
8127 974	US3400
8129 459	US1077
8130 749	US3403
8132 274	US1107
8133 033	US3403
8133 034	US3404
8277 5049	US5006
8350 2957	US3414
J3234 427	US3401
J813 4320	US3403
J813 4321	US3404
JR77 5045	US1107
JR77 5046	US3403
JR77 5047	US3413
JR77 5049	US5006
JR77 5050	US3401
JR775 049	US5006
JR775 050	US3401
JR775 053	US3410
JR775 056	US3409
JR775 122	US3412
M04667660	US7150
MD001300	US1012
MD008431	US7104
MD009000	US7105
MD021450	US1124
MD021490	US7116
MD025190	US7111
MD030751	US7106
MD030863	US7115
MD034152	US7108
MD179030	US7135
MD300799	US7135

MD306414	US7147
MD309756	US9360
MD365087	US9359
MD971538	US7148
MD971582	US7114
MD972001	US7117
MD972003	US7121
MD972004	US7121
MD972005	US7129
MD972050	US7148
MD972051	US7114
MD972052	US9212
MD972053	US9168
MD972440	US9310
MD972934	US9389
MD973025	US7152
MD973940	US7121
MD974649	US7115
MD974719	US7108
MD975292	US7116
MD976464	US9399
MD976943	US9399
MD977705	US7152
MD978552	US6228
MD978743	US7152
MD978764	US7152
MD979171	US9415
MD979395	US6149
MD980000	US7121
MD997076	US7115
MD997077	US7105
MD997078	US7108
MD997079	US7114
MD997081	US7118
MD997082	US7116
MD997084	US7117
MD997149	US7116
MD997150	US7117
MD997158	US7120
MD997178	US7120
MD997244	US7121
MD997403	US7124
MD997404	US7124
MD997417	US9212
MD997418	US7131
MD997421	US7108
MD997464	US7106
MD997485	US7108
MD997515	US7121
MD997609	US7115
MD997614	US7118
MD997615	US7114
MD997616	US7120
MD997619	US7108
MD997620	US7131
MD997622	US9168
MD997623	US7124
MD997634	US7121
MD997643	US7129
MN187244	US7156
R429 3898	US7110
R4293898	US7110
R4621172	US7127
R4626215	US3412
R4626682	US7139
R4798497	US7122
R5003665AA	US7145
R972003MAB	US7121

RL022340AC	US8971
RL184498AI	US8981
T1464552	US3411

<b>DAEWOO</b>	
92064250	US8925
96352652	US8917
96518977	US8928

<b>DAIHATSU</b>	
16100-87182-000	US9237
16100-87183-000	US8908
16100-87790-000	US9238

<b>FIAT</b>	
4129810	US9203
4129812	US9203
4331825	US9003
4336009	US8944
4429226	US9085
5882684	US9203
5882689	US9003
5882691	US8944
5890406	US8944
5936404	US9084
5936406	US9084
5960469	US9084
5980756	US9084
5983960	US9084
7671808	US9085
7671810	US9085
7784974	US9084
46400058	US8948
46444355	US8948
46526243	US8945
46805736	US8945
55184080	US8945
71716878	US8948

<b>FORD</b>	
1000398	US8934
1020567	US8934
1109341	US8934
1233205	US8905
1233214	US964
1429037	US8934
1518911	US8934
5011864	US964
5013320	US8905
5030651	US8905
1F1Z 8501-AA	US4094
1L2Z 8501-BA	US4127
1L2Z 8501-BB	US4127
1L3Z 8501-AB	US4125
1L3Z 8501-BA	US4121
1S7Z 8501-AK	US4126
1U2Z 8V501-CA	US4096
2C3Z 8V501-BA	US4114
2R8Z 8501-AE	US4129
2S7Z 8501-BG	US4094
2W9Z 8501-BB	US4124
3C3Z 8501-A	US61
3C3Z 8501-ABRM	US61
3F2Z 8501-BB	US4102
3L3Z 8501-DB	US4105
3L3Z8501-CA	US4130
3R3Z 8501-A	US4103
3R3Z 8501-BB	US4103
4C3Z 8501-ABRM	US67
4C3Z 8501-AC	US67



4C3Z 8501-B	US4109	E2DZ 8501-A	US4016	F4DZ 8501-A	US4089
4S4Z 8501-AA	US4126	E2TZ 8501-A	US4030N	F4DZ 8501-B	US4034
5F1Z 8501-A	US4094	E3TZ 8501-F	US4023	F4SZ 8501-A	US4090
5F2Z 8501-A	US4102	E3TZ 8501-G	US4033	F4TZ 8501-ARM	US4096
5F9Z 8501-BB	US6186	E43Z 8501-B	US9067	F4TZ 8501-B	US4086
5L2Z 8501-A	US4127	E45Y 8501-A	US9154	F4ZZ 8501-B	US4087
5L3Z 8501-A	US4105	E4BZ 8501-A	US4054	F50Y 8501-A	US4097
5L8Z 8501-A	US4132	E4ZZ 8501-A	US4024	F57Z 8501-A	US4093
5L8Z 8501-AA	US4094	E5TZ 8501-C	US1114	F59Z 8501-A	US4095
5M8Z 8501-A	US4132	E5ZZ 8501-A	US4035	F59Z 8501-B	US4039
5R3Z 8501-A	US4119	E69Z 8501-A	US4039	F5DZ 8501-A	US4094
5R8Z 8501-A	US4129	E6AZ 8501-B	US4014	F5DZ 8501-CL	US4098
6L2Z 8501-A	US4108	E6DZ 8501-A	US4034	F5RZ 8501-B	US4088
6U7Z 8501-A	US4102	E6TZ 8501-A	US4042	F5TZ 8501-A	US4096
6U7Z 8501-B	US4102	E6ZZ 8501-A	US4054	F5TZ 8501-BRM	US4096
7L3Z 8501-A	US6144	E7FZ 8501-B	US9067	F5TZ 8501-C	US4060
7T4Z 8501-B	US6023	E7RY 8501-A	US4045	F5TZ 8501H2-A	US4044
7T4Z 8501-C	US6023	E7TZ 8501-A	US4044	F63Z 8501-AA	US4091
8C3Z 8501-B	US76	E7TZ 8501-B	US4048	F65Z 8501-BA	US4122
96BX 8591-A2B	US8934	E8AZ 8501-A	US4052	F68Z 8501-A	US4102
96BX 8591-AA	US8934	E8BZ 8501-A	US4049	F6DZ 8501-A	US4098
9L8Z 8501-A	US6250	E8DZ 8501-A	US4051	F6DZ 8501-B	US4106
9L8Z 8501-C	US9489	E8DZ 8501-B	US4051	F6DZ 8501-FA	US4094
A840X8591BCA	US8905	E8FZ 8501-A	US4040	F6LZ 8501-AA	US4113
AA5Z 8501-A	US6023	E92Z 8501-A	US4053	F6PZ 8501-AA	US4069
AL3Z8501A	US6006	E93Z 8501-A	US4022	F6TZ 8501-AA	US4114
AT4Z8501A	US8980	E9BZ 8501-A	US4049	F6TZ 8501-KA	US4099
B5A-8501-C	US488	E9DZ 8501-B	US4056	F6TZ 8501-KB	US4079
B6A-8501-B	US488	E9JY 8501-B	US4068	F6ZZ 8501-A	US4103
B6A-8501-C	US488	E9PZ 8501-A	US4020	F77Z 8501-AD	US4108
BC3Z 8501-A	US77	E9PZ 8501-C	US4083	F7BZ 8501-A	US4049
BR3Z 8501-C	US8963	E9PZ 8501-D	US4030N	F7CZ 8501-AB	US4107
BR3Z 8501-H	US8963	E9SZ 8501-B	US4055	F7DZ 8501-A	US4098
C2AZ 8501-A	US723	E9TZ 8501-B	US4018	F7TZ 8501-AB	US4060
C2AZ 8501-B	US723	EF8501KT	US8924	F7TZ 8501-CRM	US4114
C4AZ 8501-A	US723	F02Z 8501-B	US4059	F7ZZ 8501-AA	US4103
C4AZ 8501-B	US723	F0AZ 8501-A	US4052	F80Z 8501-AA	US4097
C5AZ 8501-B	US819	F0CZ 8501-A	US4065	F81Z 8501-ARM	US4114
C5AZ 8501-K	US819	F0DZ 8501-A	US4061	F81Z 8501-CRM	US4114
C5OZ 8501-A	US819	F0PZ 8501-A	US4020	F81Z 8501-DA	US4109
D00Z 8501-C	US953	F0TZ 8501-D	US4060	F81Z 8501-FA	US4114
D0TZ 8501B	US1082	F0TZ 8501-E	US4044	F85Z 8501-AA	US4105
D1FZ 8501-A	US964	F0TZ 8501-F	US4048	F87Z 8501-BA	US4093
D2RY 8501-A	US4067	F0TZ 8501-G	US4060	F87Z 8501-BB	US4093
D3RY 8501-A	US964	F0ZZ 8501-A	US4038	F87Z 8501-CA	US4101
D3UZ 8501-A	US1028	F1CZ 8501-A	US4069	F87Z 8501-DA	US4095
D4DZ 8501-A	US1044	F1SZ 8501-A	US4057	F8AZ 8501-AA	US4066
D4TZ 8501E	US1083	F1SZ 8501-B	US4050	F8DZ 8501-AA	US4094
D4TZ 8501G	US1082	F1TZ 8501-A	US1114	F8RZ 8501-EN	US4115
D4TZ 8501-H	US1075	F1VY 8501-A	US4066	F8RZ 8501-NE	US4115
D4TZ 8501K	US1083	F23Z 8501-A	US4070	F8ZZ 8501-AA	US4103
D4TZ 8501M	US1082	F23Z 8501-B	US4041	XF1Z 8501-AA	US4094
D5DZ 8501-A	US960	F2TZ 8501-A	US4077	XF2Z 8501-AA	US4102
D5TZ 8501D	US1094	F2UZ 8501-A	US4079	XF5Z 8501-AA	US9402
D5TZ 8501E	US1096	F2UZ 8501-C	US4081	XF5Z 8501-BA	US9402
D5ZZ 8501-A	US1070	F32Z 8501-A	US9259	XL3Z 8501-AA	US4122
D6AZ 8501-A	US932	F32Z 8501-B	US4078	XL3Z 8501-BA	US4121
D6ZZ 8501-B	US953	F33Z 8501-A	US4041	XL5Z 8501-AA	US4095
D77Z 8501-A	US1042	F3DZ 8501-A	US4082	XL5Z 8501-AC	US4095
D7HZ 8501-D	US1094	F3LY 8501-A	US4113	XL5Z 8501-AD	US4095
D7HZ 8501-E	US1096	F3TZ 8501-C	US4044	XL5Z 8501-CA	US4093
D8BZ 8501-A	US4002	F3TZ 8501-E	US4079	XS2Z 8501-BC	US4091
D8FZ 8501-A	US4005	F3XZ 8501-BA	US9074	XS2Z 8501-CC	US4091
D8RZ 8501-A	US4003	F3ZZ 8501-B	US4038	XS2Z 8501-CD	US4091
D8TZ 8501-B	US1114	F42Z 8501-A	US9318	XS2Z 8501-CF	US4091
D8ZZ 8501-A	US1047	F4AZ 8501-A	US4066	XS2Z 8501-EA	US4091
E0ZZ 8501-A	US4024	F4BZ 8501-B	US4049	XS6E 6659	US8931
E1AZ 8501-A	US4014	F4CZ 8501-A	US4069	XU2Z 8501-EA	US4018



# WATER PUMP CROSS REFERENCE



XW4Z 8501-BA	US4118
XW4Z 8501-CD	US4118
YC2E 8501-BA	US4122
YC3Z 8501-AA	US4109
YC3Z 8501-AB	US4109
YF3Z 8501-A	US4097
YF3Z 8501-AB	US4097
YR3Z 8501-AB	US4119
YS4Z 8501-AA	US4123
YSG6 8501-A2C	US4104
YW7Z 8501-AA	US4113
YW7Z 8501-BB	US4128
ZZMA-15-010	US4039

## GENERAL MOTORS

231462	US1120
231886	US1100
357261	US895
359913	US1069
361053	US1088
361054	US1107
361055	US1110
376746	US1113
458486	US981
474028	US1109
474029	US1121
474055	US5030
474056	US1137
556283	US1120
1089795	US8931
1229571	US8931
1241680	US1061
1247080	US1045
1260709	US1018
1334037	US1061
1334054	US8942
1334066	US8962
1334104	US8901
1334113	US8901
1334135	US8933
1334139	US8925
1363989	US855
1396317	US855
1396346	US855
1396715	US855
1396876	US855
1396879	US821
1396880	US821
2475788	US835
3632119	US670
3634580	US5010
3634838	US5010
3741033	US563
3774186	US563
3856284	US981
3861920	US896
3876172	US896
3876173	US981
3927565	US861
3929218	US896
3929233	US898
3932422	US896
3937996	US898
3957981	US898
3957982	US981
3986364	US898
3990992	US861
3998214	US985
4409162	US8914

4640058	US8946
5740079	US5008
5743241	US5062
5743939	US5049
5744474	US5074
5744662	US5074
5744938	US5074
5745093	US5086
6258119	US896
6258458	US861
6258551	US984
6260822	US985
6272159	US1002
7490004	US5064
7490007	US5072
8885837	US835
9192797	US8962
9772372	US850
9784281	US850
9788606	US850
9793130	US850
10013800	US5000
10032022	US5022
10046305	US5030
10048917	US1121
10048919	US5016
10048949	US5033
10048950	US5035
10065240	US5007
10077051	US5004
10077059	US5049
10089654	US5032
10089659	US5006
10120938	US1107
10120943	US5035
10120944	US5037
10120945	US5001
10159526	US5000
10159599	US5056
10174846	US5051
10174979	US5020
10181235	US5040
10181327	US5040
12300305	US975
12307798	US896
12307815	US898
12309445	US975
12309978	US5003
12334884	US5028
12336298	US5050
12337519	US1120
12337663	US5012
12337664	US5014
12363169	US5032
12369484	US5023
12369487	US5049
12369537	US5081
12455105	US5085
12456112	US5081
12456113	US5087
12456231	US5086
12458115	US5085
12458326	US5038
12458920	US5040
12458922	US5051
12458934	US5081
12458935	US5087
12462265	US5032
12481997	US5000

12482000	US5041
12482690	US5035
12482694	US5037
12482696	US5001
12482903	US5075
12482919	US5050
12484890	US1002
12487361	US5072
12491038	US5040
12507232	US5000
12508606	US5017
12509653	US5063
12514574	US5062
12517379	US5017
12518277	US5068
12518443	US5032
12520914	US5070
12521037	US5038
12522031	US5049
12522033	US1121
12522034	US5051
12522036	US5073
12523499	US5066
12523502	US5069
12523505	US5030
12524131	US1121
12525123	US5038
12527740	US5069
12527741	US5068
12527759	US5038
12529305	US1121
12529993	US5072
12530176	US5074
12532528	US5077
12532529	US5049
12532531	US5049
12534418	US5008
12534772	US5074
12537495	US5050
12581517	US9470
12583033	US8956
12585226	US5092
12591894	US5092
12595614	US8955
12600767	US6009
12618472	US8932
12620226	US5097
12624936	US5092
12630084	US5092
12635743	US9470
12637479	US8932
14063641	US5015
14071866	US5004
14079351	US5004
14085847	US1121
14085852	US1002
14089011	US5020
14101304	US5001
15633466	US5062
19168611	US5062
19168612	US5054
19168888	US63
19179031	US6145
19180610	US79
19201601	US5049
19208815	US6009
21006933	US5054
21007155	US5054

21007288	US5054
21007655	US5054
21015340	US5054
22514839	US5012
22519584	US5014
23500133	US5008
24405895	US6184
24409355	US8925
24439798	US5092
24467301	US5092
24570464	US5043
24571389	US5043
24576952	US5097
24577255	US5076
25527536	US1018
50745093	US5086
52273124	US5017
55352002	US5079
55352570	US5092
55561623	US6662
55579016	US6662
88893906	US5089
88893907	US5090
88894005	US5049
88894035	US5086
88894036	US5074
88894044	US5062
88894290	US5087
88894341	US1121
88894344	US5072
88972167	US5099
88972819	US9405
88973887	US9376
88974712	US9405
89017269	US5033
89017311	US5033
89017439	US64
89017456	US5081
89017457	US65
89017467	US5072
89017592	US65
89017593	US65
89017693	US5089
89017748	US5077
89017757	US6020
89017771	US5089
89017773	US5090
89017900	US5072
89018052	US65N
89018053	US5081
89018165	US6154
89018166	US64
89018214	US5075
89060462	US5075
89060479	US6020
89060527	US5077
90220568	US5036
90392900	US5045
90392901	US5057
90392902	US5036
90392908	US5017
90444079	US8962
90444123	US8942
90543277	US5079
90543935	US8933
91160212	US8914
91172178	US5048
91173189	US5058

91173496	US5048
91174230	US9374
91174494	US9342
91175666	US5058
91176170	US9385
91176915	US5058
92149009	US5103
93170697	US5079
93179383	US8901
93231147	US5017
93385844	US8938
94013802	US8917
94109591	US5031
94118501	US5027
94202477	US1127
94239153	US5013
94239649	US9132
94360200	US9220
94840612	US9057
94844775	US9076
94847609	US9057
94854103	US9272
94856254	US9271
94858649	US9376
96054298	US5029
96059659	US5048
96062832	US5048
96182871	US8917
96351971	US8917
96352649	US8917
96352650	US6046
96872700	US8917
96872702	US6046
97031472	US9221
97180326	US8953
97216136	US63
97372515	US72
98031233	US72
17400-82824	US5058
4864 566	US8909

**HONDA**

06194-RNA-305	US6056
19110-634-375	US9033N
19110-634-405	US9033N
19110-657-335	US9034
19110-657-405	US9034
19110-671-335	US9034
19110-673-335	US9034
19110-689-335	US9034
19110-689-405	US9034
19200-657-010	US9034
19200-P01-004	US9130
19200-P08-004	US9250
19200-P0A-003	US9209
19200-P0G-A01	US9097
19200-P10-A02	US9130
19200-P13-003	US9273
19200-P14-A01	US9251
19200-P1R-003	US9347
19200-P2A-A01	US9352
19200-P30-003	US9321
19200-P5A-004	US9354
19200-P5G-004	US9348
19200-P72-003	US9289
19200-P72-013	US9468
19200-P75-003	US9349
19200-P8A-A01	US9383
19200-P8A-A02	US9383

19200-P8A-A03	US9383
19200-PA6-030	US9035
19200-PB2-010	US9029
19200-PB2-405	US9029
19200-PC1-000	US9035
19200-PD2-660	US9056
19200-PD6-000	US9056
19200-PE0-010	US9069
19200-PE0-415	US9069
19200-PE0-515	US9069
19200-PE8-405	US9043N
19200-PE8-600	US9043N
19200-PH1-000	US9083
19200-PH7-003	US9097
19200-PLM-A01	US9419
19200-PNA-003	US9434
19200-PNL-E01	US9434
19200-PR4-013	US9224
19200-PR7-305	US9219
19200-PR7-A01	US9219
19200-PR7-A02	US9219
19200-PR7-A03	US9219
19200-PRB-A01	US9495
19200-PV1-A01	US9253
19200-PV3-003	US9253
19200-PY3-010	US9218
19200-PY3-A00	US9288
19200-PZA-013	US6216
19200-R40-A01	US6233
19200-R70-A11	US9470
19200-RAA-A01	US9461
19200-RAD-003	US9461
19200-RB0-003	US6350
19200-RBB-013	US9434
19200-RBC-013	US9495
19200-RBJ-003	US8983
19200-RCA-A01	US9470
19200-RDM-A01	US9470
19200-RDM-A02	US9470
19200-RDV-J01	US9470
19200-RFE-003	US9434
19200-RME-A01	US6018
19200-RMX-003	US6216
19200-RNA-A01	US6056
19200-RNA-A02	US6056
19200-RWC-A01	US6223
19210-PCX-003	US9403
19210-PD2-515	US9056
19210-PD6-505	US9056
19210-PD6-515	US9056
19210-PG6-305	US9115
19210-PH1-515	US9083
19210-PH3-305	US9131
19210-PHM-010	US9494
19210-PK2-305	US9129

**HYUNDAI**

25100-02500	US8935
25100-02501	US8935
25100-02502	US8935
25100-02555	US8935
25100-12500	US8935
25100-12501	US8935
25100-22650	US7115
25100-22900	US9364
25100-23001	US9353
25100-23002	US9353
25100-23003	US9353
25100-23010	US9353



25100-23530	US9353
25100-24030	US7115
25100-25002	US6220
25100-26900	US9364
25100-26902	US9364
25100-2G100	US6220
25100-2G200	US6220
25100-2G500	US8982
25100-2G510	US8982
25100-2G600	US6220
25100-32515	US7118
25100-33012	US7131
25100-33132	US9212
25100-35050	US7121
25100-37202	US9462
25100-38200	US9399
25100-39010	US9463
25100-39012	US9463
25100-3C100	US6048
25100-3C120	US6048
25100-3E001	US6215
25100-41000	US8957
25100-42540	US8922
OVN01-15-100	US8964

### ISUZU

5-86202-375-0	US9209
8-10120-943-0	US5035
8-12462-265-0	US5032
8-12482-690-0	US5035
8-12532-528-0	US5077
8-12620-226-0	US5097
8-24576-952-0	US5097
8-87018-560-0	US8901
8-88894-290-0	US5087
8-89017-439-0	US5087
8-89018-166-0	US5087
8-89060-527-0	US5077
8-90466-343-0	US9375
8-92064-250-0	US9375
8-92065-969-0	US9375
8-93284-724-0	US9375
8-94109-591-1	US5031
8-94118-501-0	US5027
8-94120-768-1	US9132
8-94131-330-1	US9106
8-94140-341-2	US8901
8-94146-326-0	US9105
8-94146-326-1	US9105
8-94174-226-2	US9133
8-94202-477-1	US1127
8-94224-894-0	US1127
8-94239-649-0	US9132
8-94310-251-0	US8901
8-94332-636-0	US9106
8-94332-637-1	US9105
8-94332-638-2	US9133
8-94376-837-0	US9132
8-94376-845-0	US9106
8-94376-846-0	US9105
8-94376-847-0	US9133
8-94376-859-1	US9132
8-94376-866-0	US5031
8-94376-868-0	US9160
8-94437-048-1	US9160
8-94439-850-1	US9302
8-97010-201-0	US5027
8-97012-298-0	US1127
8-97021-171-0	US9302

8-97021-773-0	US9105
8-97021-774-0	US9133
8-97031-472-0	US9221
8-97031-473-0	US9220
8-97061-280-0	US9278
8-97073-951-0	US8969
8-97081-623-0	US9133
8-97081-624-0	US9105
8-97109-676-0	US8969
8-97125-975-0	US9278
8-97167-554-0	US9365
8-97180326	US8953

### JAGUAR

AJ84817	US4129
AJ88912	US4124
C2C32677	US4129
C2C38862	US4129
C2S26232	US4118
C2S43292	US6657
EAC3033	US9165
EAC7242	US9163
EAC9213	US9163
EBC10566	US9356
EBC10967	US9356
EBC4437	US9163
EBC8550	US9163
JLM 10819	US9165
JLM 398	US9211
JLM10648	US9165
JLM10819	US9165
JLM361	US9165
JLM9696	US9211
JLM9697	US9165
NBB2200DA	US9280
XR3Z 8501-AA	US4119
XR813290	US4118
XS6E 8501-AD	US8931

### KIA

0FE1H-15-010H	US4053
0K247-15-010A	US9393
0K247-15-010B	US9393
0K24A-15-010	US9305
0K30E-15-010	US9473
0K930-15-010A	US4049
25100-25002	US6220
25100-26902	US9364
25100-2B000	US6247
25100-2X401	US9473
25100-2Y000	US9393
25100-2Y010	US9393
25100-2Y011	US9393
25100-37102	US9462
25100-37201	US9462
25100-37202	US9462
25100-38002	US9399
25100-38200	US9399
25100-39010	US9463
25100-39012	US9463
25100-39800	US9448
25100-39802	US9448
25100-3C100	US6048
25100-3C120	US6048
25100-3E000	US9462
25100-3E001	US6215
25100-3X000	US9450
OK65A-15-100	US8961
OVN01-15-100	US8964
RF01-99-154	US9067

RF01-99-154A	US9067
--------------	--------

### LAND ROVER

457 5902	US4124
PEB 102240L	US9496
RTC 6339	US9368
ST 1693	US9369
ST 4378	US9369
STC 483	US9368

### MAZDA

0305-15-010D	US9300
0305-15-010E	US9300
0305-99-151	US9300
0324-15-010D	US9020
0324-15-010E	US9020
0381-15-010A	US1042
0381-15-010B	US1042
0381-99-151A	US1042
0459-15-010	US9295
0459-99-151	US9295
1757-23-925B	US9053
1757-99-151	US9053
1E04-15-010	US8934
1F00-15-010	US4093
1F20-15-010	US4126
1F22-15-010	US4108
1F70-15-010	US4126
1F82-15-010	US4108
3648-15-130B	US9053
8872-15-0101	US9053
8872-15-010B	US9053
8872-15-010D	US9053
8A81-15-010	US9050
8AB4-15-010A	US4049
8AB5-15-010A	US4068
8AB7-15-010	US4049
8AB8-15-010	US4068
8ABB-15-010A	US9305
8ABC-15-010	US9371
8ABE-15-010	US9371
8ABT-15-010A	US9050
8AD2-15-010A	US4049
8AF2-15-010B	US9102
8AF2-15-010C	US9102
8AF3-15-010A	US9102
8AF3-15-010B	US9102
8AF4-15-010B	US9102
8AFB-15-010A	US9208
8AFC-15-010A	US9208
8AFD-15-010	US9208
8AG6-15-010A	US9067
8AG7-15-010A	US9060
8AG9-15-010	US4078
8AH3-15-010A	US9166
8AH3-15-010B	US9166
8AH6-15-010	US9225
8AH6-15-010B	US9225
8AH7-15-010A	US9260
8AL1-15-010A	US9167
8AL1-15-010C	US9167
8AL4-15-010	US9394
8AL4-15-010A	US9394
8ALA-15-100	US8923
8ALA-15-100A	US8923
8AS4-15-010A	US9020
8BU1-15-010	US7120
8BU1-15-010RM0	US7120
AJ03-15-010B	US4091
AJ03-15-010G	US4132

AJ57-15-010	US9489
AJ57-15-010A	US9489
AJ57-15-010B	US9489
AJTM-15-010	US9489
AJY1-15-010	US4091
B630-15-010RMD	US4049
B660-15-010RME	US4068
B6BF-15-010F	US9305
B6BF-15-010RMF	US9305
BA010-54A26	US8958
BA010-54A27	US8958
E301-15-010A	US9050
E301-15-010B	US9050
E301-15-010C	US9050
F801-15-010C	US9060
F801-15-010D	US9060
FE79-15-010B	US9060
FE79-15-010C	US9060
FE79-15-010E	US9111
FE79-15-010RMJ	US9111
FEMJ-15-100RMO	US4053
FP01-15-010F	US4078
FS01-15-010F	US4078
FS01-15-010RMF	US4078
GY01-15-010B	US4091
JE96-15-010B	US9394
JE96-15-010RM	US9394
JE96-15-010RMB	US9166
JF03-15-010RME	US9166
KJ01-15-010H	US9328
KL47-15-010C	US9318
KL47-15-010RMC	US9318
L327-15-100	US4126
L327-15-100A	US4126
L3G2-15-100	US4126
L3G2-15-100A	US4126
LF01-15-100	US4126
LF52-15-100	US4126
LF52-15-100A	US4126
LF94-15-100	US6219
LF94-15-100A	US6219
N232-99-153A	US9053
N232-99-153B	US9053
N304-15-010C	US9053
N3A1-15-010D	US9266
N3A2-15-010D	US9266
N3C1-15-010	US9266
N3C1-15-010D	US9266
N3C2-15-010	US9266
N3C2-15-010D	US9266
N3H1-15-100B	US6156
N3H8-115-100A	US6156
YF09-15-100	US4115
ZL01-15-010	US9305
ZL01-15-010A	US9371
ZZL0-15-010A	US4060
ZZM0-15-010	US4054
ZZM3-15-010	US4093
ZZM5-15-010	US4060
ZZM7-15-010	US4095
ZZR1-15-010	US4095
ZZR1-15-010A	US4095
ZZR1-15-010B	US4095

**MERCEDES-BENZ**

102 200 42 01	US9173
102 200 62 01	US9175
103 200 37 01	US9202
104 200 31 01	US9222

104 200 32 01	US9312
104 200 33 01	US9313
104 200 44 01	US9311
104 200 47 01	US9345
104 200 48 01	US9343
104 200 49 01	US9344
104 200 54 01	US9344
104 200 57 01	US9344
104 200 58 01	US9351
110 200 02 20	US9299
110 200 17 20	US9172
110 200 20 20	US9299
110 201 00 10	US9299
111 200 23 01	US9314
111 200 40 01	US9440
111 200 42 01	US9440
112 200 14 01	US9380
112 200 15 01	US9379
115 200 1220	US9178
115 200 1620	US9178
116 200 17 01	US9231
117 200 33 01	US9230
117 200 38 01	US9176
119 200 15 01	US9315
119 200 21 01	US9346
120 200 11 01	US9277
271 200 02 01	US6030
272 200 04 01	US6075
272 200 04 91	US6075
272 200 09 01	US6142
273 200 02 01	US6235
602 200 04 20	US9228
605 200 08 20	US9228
613 200 09 01	US6152
617 200 06 20	US9370
642 200 10 01	US6349

**MG**

GWP130	US9082
--------	--------

**MITSUBISHI**

M345611	US8914
M855991	US8914
MD972002	US8922
MD997686	US8922
ME015030	US8957
ME015040	US8957
ME015045	US8957
ME015050	US8957
ME015217	US8965
ME200411	US8902
ME995424	US8965
ME996789	US8902
ME996868	US8965

**NISSAN**

21010-00QAA	US8927
21010-01M25	US9041
21010-02P26	US9058
21010-02P27	US9058
21010-02P85	US9058
21010-03J25	US8941
21010-06EY6	US9116
21010-09W25	US9198
21010-0F002	US8930
21010-0M302	US9214
21010-0W002	US9338
21010-0W003	US9338
21010-0W025	US9338
21010-0W027	US9338

21010-12G26	US9104
21010-12G28	US9104
21010-13200	US9179
21010-13201	US9179
21010-13202	US9179
21010-13205	US9179
21010-13206	US9179
21010-13225	US9179
21010-13226	US9179
21010-16A85	US9044
21010-16AY5	US9044
21010-17C28	US9110
21010-17S27	US9011
21010-17SY7	US9011
21010-1E400	US9270
21010-1E401	US9270
21010-1E403	US9270
21010-1E4Y0	US9270
21010-21028	US9009
21010-21089	US9009
21010-22P25	US9201
21010-23028	US9008
21010-30R05	US9162
21010-30R06	US9162
21010-31U25	US9309
21010-31U26	US9309
21010-31U27	US9309
21010-31U28	US9309
21010-31U29	US9309
21010-31U85	US9309
21010-31W26	US9198
21010-40F25	US9206
21010-4S10A	US9338
21010-4S125	US9338
21010-4S126	US9338
21010-50A25	US9041
21010-50A27	US9041
21010-50A89	US9284
21010-50A94	US9041
21010-50AY8	US9041
21010-53J05	US9213
21010-53Y01	US9214
21010-54A15	US8958
21010-54A26	US8958
21010-54A27	US8958
21010-60U26	US9239
21010-60UY6	US9041
21010-6N226	US9427
21010-77A00	US9207
21010-77AY0	US9207
21010-78203	US8935
21010-7B000	US9402
21010-7S000	US9488
21010-7Y00A	US9426
21010-7Y025	US9426
21010-7Y026	US9426
21010-80G85	US8930
21010-80W26	US9031
21010-80W89	US9031
21010-82W25	US9031
21010-86G00	US9206
21010-86G25	US9206
21010-88R00	US9214
21010-88R10	US9214
21010-8J000	US9427
21010-97E00	US9252
21010-AL525	US9426
21010-AL526	US9426

21010-AL527	US9426
21010-AL528	US9426
21010-AR725	US9488
21010-B17G2	US9284
21010-BX000	US8967
21010-D0126	US9114
21010-EA010	US6242
21010-ET025	US6218
21010-F4300	US9214
21010-F4400	US9270
21010-F4600	US9416
21010-F461A	US9427
21010-F462A	US9427
21010-G3925	US9031
21010-G3926	US9031
21010-G3928	US9031
21010-H7227	US9026
21010-JA10A	US6198
21010-JK00A	US9426
21010-JK00C	US6198
21010-M6626	US9010
21010-N5829	US9031
21010-N5885	US9031
21010-N8527	US9008
21010-P7586	US9011
21010-P7589	US9011
21010-U6727	US9008
21010-V5528	US9063
B1010-0P529	US9268
B1010-16E03	US9074
B1010-1GZ0A	US6218
B1010-1P128	US9388
B1010-22P27	US9201
B1010-40F27	US9206
B1010-67U28	US9304
B1010-EN20B	US6218
B1010-ET00A	US6218
B1010-F461B	US9427
B1010-JK00A	US6198
B1010-JK20A	US9426
BA010-06E26	US9116
BA010-23028	US9008
BA010-80W89	US9031
BA010-D0126	US9114
BA010-H7289	US9026
BA010-M6626	US9010
BA010-N8527	US9008
BA010-V5589	US9063

### PEUGEOT

1201 71	US9193
1201-47	US8936
1201-58	US8911
1201-A2	US8937
1201-E3	US8936
1201-E4	US8911
1201-E5	US8937
1201-E6	US8911
1202 82	US9193
1207-18	US8936
1207-23	US8936
1207-25	US8911

### PORSCHE

060 121 010 X	US9177
060 121 011	US9177
928 106 015 11	US9242
928 106 015 20	US9241
928 106 015 22	US9242

944 106 021 09	US9245
944 106 021 13	US9245
951 106 021 10	US9245
996 106 011 53	US9475
996 106 011 55	US9475
997 101 011 02	US9475
997 106 011 05	US9475
997 106 011 70	US9475
997 106 011 71	US9475

### RENAULT

7700 274330	US8927
7701 452 155	US9282
7701 452 781	US9487
7701 457 416	US9282
7701 457 670	US9301
7701 457 771	US9487
7701 461 173	US9487
7701 462 809	US8914
7701 462085	US3406
7701 463 111	US8914
7701 463 397	US8914
7701 463182	US3410
7701 502 962	US9282
7701 505 397	US9301
7702 001 510	US9282
7702 452 782	US9487
8200 146297	US8927
8982 775051	US3405
8982 775055	US3408

### SAAB

12 56 6029	US8932
12 62 0226	US5097
24 57 6952	US5097
32 00 5905	US9223
32 00 5906	US9215
32 01 0616	US9223
59 58 061	US5079
59 60 414	US9307
75 07 460	US9108
83 46 546	US9158
83 58 491	US9159
88 17 900	US9108
88 21 944	US5079
88 22 710	US9307
88 22 793	US9307
89 01 8166	US64
92 14 9009	US8932
93 16 6829	US9307
93 17 8602	US5092
93 18 1118	US5092
93 19 5308	US5092
93 21 670	US9107
93 21 688	US9264

### STERLING

26526500010	US9097
-------------	--------

### SUBARU

21110 AA016	US9161
21110 AA017	US9161
21110 AA025	US9080
21110 AA026	US9080
21110 AA050	US9025
21110 AA060	US9025
21110 AA070	US9093
21110 AA110	US9109
21110 AA360	US9421
21110 AA510	US9421
21110 AA690	US6049

21110-AA000	US8903
21110-AA001	US8903
21110-AA002	US8903
21110-AA003	US8903
21111 AA007	US9223
21111 AA026	US9215
21111 AA033	US9254
21111 AA065	US9255
21111 AA110	US9223
21111 AA230	US9472
21111 AA240	US9215
21111 AA250	US9215
21111 AA280	US6049
21111 AA290	US6160
21114 AA051	US6160
21118 KA000	US9486
21135 KA000	US9486

### SUZUKI

17400-60812	US5048
17400-60813	US5048
17400-60815	US5048
17400-60D01	US8928
17400-61820	US9374
17400-66810	US9385
17400-70B00	US8928
17400-70D00	US8929
17400-71811	US8929
17400-73001	US9227
17400-73002	US9227
17400-73003	US9227
17400-73012	US9227
17400-73013	US9227
17400-73810	US9227
17400-73811	US9227
17400-73812	US9227
17400-77810	US9342
17400-77812	US9342
17400-77813	US9342
17400-78820	US9232
17400-78821	US9232
17400-78890	US9342
17400-78892	US9342
17400-82850	US5058
17400-82851	US5058
17400-82Z00	US9426
17400-83811	US5029
17400-83815	US5029
17400-85830	US9385
17400-85Z00	US8925
17400-85Z01	US9342
17400-86Z00	US6241
17400-86Z03	US6241

### TOYOTA

19185381	US9414
16100-09170	US9376
16100-09200	US9257
16100-09201	US9257
16100-09440	US6047
16100-09441	US6047
16100-09470	US6037
16100-09471	US6037
16100-09490	US6197
16100-09491	US6197
16100-09515	US6252
16100-0H040	US8970
16100-0H050	US8970
16100-19016	US9015



16100-19017-77	US9015
16100-19025	US9028
16100-19027	US9045
16100-19028-77	US9045
16100-19056	US9064
16100-19066	US9086
16100-19066-84	US9086
16100-19166	US9064
16100-19235	US8950
16100-25012	US9012
16100-25012-84	US9012
16100-26022	US9018
16100-26022-84	US9018
16100-26023	US9018
16100-28020	US9018
16100-28020-77	US9018
16100-28041	US9414
16100-29026	US1006
16100-29047	US9021
16100-29048	US9021
16100-29055	US1006
16100-29085	US9306
16100-29145	US9405
16100-29146	US9405
16100-29156-83	US9406
16100-29415-83	US9405
16100-39316	US9017
16100-39317	US9017
16100-3931777	US9017
16100-39346-83	US9141
16100-39435	US6143
16100-39436	US6143
16100-39465	US6232
16100-39466	US6351
16100-39495	US6197
16100-39505	US6338
16100-39506	US6338
16100-39515	US6252
16100-39545	US6599
16100-39545	US6599
16100-49045	US9039
16100-49415	US9296
16100-49416	US9296
16100-49425	US9296
16100-49595	US9039
16100-49655	US9040N
16100-49656-77	US9040N
16100-49666	US9039
16100-49776	US9100
16100-49805-83	US9100
16100-49837-83	US9256
16100-50023-83	US9257
16100-59127	US9094
16100-59129	US9094
16100-59137	US9200
16100-59139	US9200
16100-59155	US8904
16100-59255	US8904
16100-59275-83	US9257
16100-59276	US9476
16100-60080	US9078
16100-61012	US9189
16100-61041	US9189
16100-61070	US9493
16100-61080	US9493
16100-61130	US9189
16100-64H05	US9059
16100-69085	US9059
16100-69255	US9155

16100-69275	US9059
16100-69325	US9269
16100-69385	US9320
16100-69398-83	US9324
16100-69455-83	US9258
16100-69465-83	US9142
16100-69475-83	US9145
16100-69495-83	US9291
16100-69535	US9325
16100-79036	US9092
16100-79036-77	US9092
16100-79165-83	US9216
16100-79445-83	US9293
16110-15020	US9046
16110-15085	US9046
16110-16020-84	US9076
16110-19025	US9045
16110-19026	US9045
16110-19036	US9046
16110-19036-84	US9046
16110-19046	US9057
16110-19047-77	US9057
16110-19065-84	US9098
16110-19076	US9057
16110-19086	US9057
16110-19106	US9334
16110-19107	US9367
16110-19115	US9076
16110-19146	US9271
16110-19155	US9075
16110-19176	US9272
16110-19185	US9272
16110-19205	US9271
16110-26020	US9016
16110-26020-84	US9016
16110-26021	US9018
16110-26021-84	US9018
16110-28010	US9018
16110-28010-77	US9018
16110-38020	US9005
16110-38022	US9027
16110-38022-77	US9027
16110-45070	US9180
16110-45100	US9039
16110-49025	US9170
16110-49026-77	US9170
16110-49045	US9039
16110-49086-77	US9039
16110-49097	US9292
16110-49115	US9256
16110-49116	US9256
16110-49125	US9292
16110-49126	US9292
16110-49156	US9395
16110-61081	US9337
16110-61081-77	US9337
16110-61180	US9155
16110-69035	US9048
16110-69036-77	US9048
16110-79026-83	US9099
16110-79095	US9087
16110-79115	US9140
16120-41060	US9180
16120-42011	US9180

**VOLKSWAGEN / AUDI**

021 121 004	US9262
021 121 004 A	US9262
021 121 004 AX	US9262

021 121 004 X	US9262
022 121 011	US9471
022 121 011 A	US6221
022 121 011 V	US9471
022 121 011 X	US9471
025 121 010 AX	US9061
025 121 010 CX	US9150
026 121 005 C	US9065
026 121 005 G	US9065
026 121 005 H	US9065
026 121 005 JX	US9065
026 121 005 L	US9401
026 121 010 DX	US9061
028 121 004	US9335
028 121 004 V	US9335
028 121 004 X	US9335
030 121 005 N	US8949
030 121 005 NV	US8949
030 121 005 NX	US8949
030 121 008 D	US8949
030 121 008 DX	US8949
030 131 005 T	US8949
034 121 004	US9171
034 121 004 X	US9171
035 121 004 A	US9052
035 121 004 AX	US9052
037 121 005 B	US9065
037 121 005 C	US9065
037 121 010 C	US9065
038 121 011 A	US9378
038 121 011 AX	US9378
038 121 011 G	US6034
038 121 011 J	US9378
038 121 011 JX	US9378
03L 121 011 B	US6034
045 121 011 H	US9378
050 121 010 CX	US9401
052 121 005 A	US9052
054 121 004 A	US9279
054 121 004 AX	US9279
068 121 005 A	US9065
068 121 005 B	US9066
068 121 005 C	US9066
069 121 005 D	US9071
06A 121 011 F	US9377
06A 121 011 L	US9377
06A 121 011 LX	US9377
06A 121 011 T	US9377
06A 121 011 TX	US9377
06A 121 012	US9377
06A 121 012 X	US9377
06B 121 011	US8959
06B 121 011 A	US8959
06B 121 011 B	US8959
06B 121 011 C	US8959
06B 121 011 E	US8959
06B 121 011 L	US8959
06B 121 011 N	US8959
06C 121 004 H	US9429
06C 121 004 HX	US9429
06E 121 005 D	US6146
06E 121 005 F	US6146
06E 121 005 G	US6249
06E 121 005 P	US6249
06E 121 008 N	US6146
06E 121 008 P	US6249
06E 121 018 A	US6146
06E 121 018B	US6249
06F 121 011	US6022























# WATER PUMP CROSS REFERENCE

**USMW**  
*Professional Series*

06F 121 011 X	US6022
06H 121 026 AB	US6034
074 121 005 M	US9274
074 121 005 N	US9274
077 121 004 A	US9226
077 121 004 F	US9362
077 121 004 G	US9226
077 121 004 HX	US9362
077 121 004 M	US9410
077 121 004 MX	US9410
077 121 004 N	US9410
077 121 004 NX	US9410
077 121 004 P	US9410
077 121 004 PX	US9410
078 121 004 C	US9263
078 121 004 CX	US9263
078 121 004 H	US9333
078 121 004 HX	US9333
078 121 004 J	US9333
078 121 004 JX	US9333
078 121 004 QX	US9333
078 121 006 A	US9446
078 121 006 AX	US9446
078 121 006 X	US9333
079 121 011 H	US9410
079 121 011 Q	US9410
079 121 012 B	US9410
079 121 012 D	US6000
079 121 014 D	US9410
079 121 014 F	US9410
07K 121 011 B	US6050
07K 121 011 BX	US6050
07K 121 011 G	US6050

## **VOLVO**

1218096-0	US9147
1218158-0	US9146
1257185-0	US9071
270681-0	US9049
271275-0	US9068
271855-0	US9339
271975-0	US9068
271985-0	US9339
271986-0	US9339
275619-0	US9049
30684432-0	US9339
30751700-0	US9339
3121900-0	US9382
461094-0	US9077
8694626-0	US9339
8694627-0	US9339
8694628-0	US9340
8694630-0	US9339













			
<b>US61</b>	<b>US63</b>	<b>US64</b>	<b>US64-T</b>
			
<b>US65</b>	<b>US65N</b>	<b>US65-T</b>	<b>US65N-T</b>
			
<b>US67</b>	<b>US72</b>	<b>US76</b>	<b>US77</b>
			
<b>US79</b>	<b>US488</b>	<b>US563</b>	<b>US670</b>
			
<b>US713</b>	<b>US723</b>	<b>US801</b>	<b>US819</b>

**Note:** The photos or illustrations shown above are for reference purposes only. It does not suggest or imply that all the referenced pumps are manufactured by US Motor Works.





















			
<b>US821</b>	<b>US835</b>	<b>US843</b>	<b>US850</b>
			
<b>US851</b>	<b>US855</b>	<b>US861</b>	<b>US895</b>
			
<b>US896</b>	<b>US898</b>	<b>US898H</b>	<b>US918</b>
			
<b>US919</b>	<b>US932</b>	<b>US953</b>	<b>US953H</b>
			
<b>US960</b>	<b>US964</b>	<b>US975</b>	<b>US981</b>

**Note:** The photos or illustrations shown above are for reference purposes only. It does not suggest or imply that all the referenced pumps are manufactured by US Motor Works.



			
<b>US984</b>	<b>US984H</b>	<b>US985</b>	<b>US986</b>
			
<b>US1002</b>	<b>US1002H</b>	<b>US1006</b>	<b>US1010</b>
			
<b>US1012</b>	<b>US1018</b>	<b>US1018H</b>	<b>US1021</b>
			
<b>US1028</b>	<b>US1028H</b>	<b>US1040</b>	<b>US1042</b>
			
<b>US1044</b>	<b>US1045</b>	<b>US1047</b>	<b>US1053</b>

**Note:** The photos or illustrations shown above are for reference purposes only. It does not suggest or imply that all the referenced pumps are manufactured by US Motor Works.





















			
<b>US1061</b>	<b>US1069</b>	<b>US1070</b>	<b>US1075</b>
			
<b>US1075H</b>	<b>US1077</b>	<b>US1082</b>	<b>US1083</b>
			
<b>US1088</b>	<b>US1094</b>	<b>US1096</b>	<b>US1099</b>
			
<b>US1100</b>	<b>US1107</b>	<b>US1109</b>	<b>US1109H</b>
			
<b>US1110</b>	<b>US1114</b>	<b>US1120</b>	<b>US1120H</b>

**Note:** The photos or illustrations shown above are for reference purposes only. It does not suggest or imply that all the referenced pumps are manufactured by US Motor Works.



			
<b>US1121</b>	<b>US1121H</b>	<b>US1124</b>	<b>US1127</b>
			
<b>US1137</b>	<b>US3400</b>	<b>US3401</b>	<b>US3401H</b>
			
<b>US3403</b>	<b>US3404</b>	<b>US3406</b>	<b>US3408</b>
			
<b>US3409</b>	<b>US3410</b>	<b>US3411</b>	<b>US3412</b>
			
<b>US3413</b>	<b>US3414</b>	<b>US4002</b>	<b>US4003</b>

**Note:** The photos or illustrations shown above are for reference purposes only. It does not suggest or imply that all the referenced pumps are manufactured by US Motor Works.

			
<b>US4005</b>	<b>US4014</b>	<b>US4016</b>	<b>US4018</b>
			
<b>US4020</b>	<b>US4022</b>	<b>US4023</b>	<b>US4024</b>
			
<b>US4024H</b>	<b>US4030N</b>	<b>US4033</b>	<b>US4034</b>
			
<b>US4035</b>	<b>US4038</b>	<b>US4038H</b>	<b>US4039</b>
			
<b>US4040</b>	<b>US4041</b>	<b>US4042</b>	<b>US4044</b>

**Note:** The photos or illustrations shown above are for reference purposes only. It does not suggest or imply that all the referenced pumps are manufactured by US Motor Works.

			
<b>US4044H</b>	<b>US4045</b>	<b>US4048</b>	<b>US4049</b>
			
<b>US4050</b>	<b>US4051</b>	<b>US4052</b>	<b>US4052H</b>
			
<b>US4053</b>	<b>US4054</b>	<b>US4055</b>	<b>US4056</b>
			
<b>US4057</b>	<b>US4059</b>	<b>US4060</b>	<b>US4061</b>
			
<b>US4065</b>	<b>US4066</b>	<b>US4067</b>	<b>US4068</b>

**Note:** The photos or illustrations shown above are for reference purposes only. It does not suggest or imply that all the referenced pumps are manufactured by US Motor Works.











			
<b>US4069</b>	<b>US4070</b>	<b>US4077</b>	<b>US4078</b>
			
<b>US4079</b>	<b>US4081</b>	<b>US4082</b>	<b>US4083</b>
			
<b>US4086</b>	<b>US4087</b>	<b>US4088</b>	<b>US4089</b>
			
<b>US4090</b>	<b>US4091</b>	<b>US4093</b>	<b>US4094</b>
			
<b>US4095</b>	<b>US4096</b>	<b>US4097</b>	<b>US4098</b>

**Note:** The photos or illustrations shown above are for reference purposes only. It does not suggest or imply that all the referenced pumps are manufactured by US Motor Works.

			
<b>US4099</b>	<b>US4101</b>	<b>US4102</b>	<b>US4103</b>
			
<b>US4104</b>	<b>US4105</b>	<b>US4106</b>	<b>US4107</b>
			
<b>US4108</b>	<b>US4109</b>	<b>US4110</b>	<b>US4113</b>
			
<b>US4114</b>	<b>US4115</b>	<b>US4118</b>	<b>US4119</b>
			
<b>US4121</b>	<b>US4122</b>	<b>US4123</b>	<b>US4124</b>

**Note:** The photos or illustrations shown above are for reference purposes only. It does not suggest or imply that all the referenced pumps are manufactured by US Motor Works.













			
<b>US4125</b>	<b>US4126</b>	<b>US4127</b>	<b>US4128</b>
			
<b>US4129</b>	<b>US4130</b>	<b>US4132</b>	<b>US5000</b>
			
<b>US5001</b>	<b>US5003</b>	<b>US5004</b>	<b>US5006</b>
			
<b>US5007</b>	<b>US5008</b>	<b>US5010</b>	<b>US5012</b>
			
<b>US5013</b>	<b>US5014</b>	<b>US5015</b>	<b>US5016</b>

**Note:** The photos or illustrations shown above are for reference purposes only. It does not suggest or imply that all the referenced pumps are manufactured by US Motor Works.



			
<b>US5016H</b>	<b>US5017</b>	<b>US5020</b>	<b>US5022</b>
			
<b>US5023</b>	<b>US5027</b>	<b>US5028</b>	<b>US5029</b>
			
<b>US5030</b>	<b>US5031</b>	<b>US5032</b>	<b>US5033</b>
			
<b>US5035</b>	<b>US5036</b>	<b>US5037</b>	<b>US5038</b>
			
<b>US5038H</b>	<b>US5040</b>	<b>US5041</b>	<b>US5043</b>

**Note:** The photos or illustrations shown above are for reference purposes only. It does not suggest or imply that all the referenced pumps are manufactured by US Motor Works.

			
<b>US5045</b>	<b>US5048</b>	<b>US5049</b>	<b>US5049H</b>
			
<b>US5050</b>	<b>US5051</b>	<b>US5054</b>	<b>US5056</b>
			
<b>US5057</b>	<b>US5058</b>	<b>US5062</b>	<b>US5063</b>
			
<b>US5064</b>	<b>US5066</b>	<b>US5067</b>	<b>US5068</b>
			
<b>US5069</b>	<b>US5070</b>	<b>US5072</b>	<b>US5073</b>

**Note:** The photos or illustrations shown above are for reference purposes only. It does not suggest or imply that all the referenced pumps are manufactured by US Motor Works.

			
<b>US5074</b>	<b>US5075</b>	<b>US5076</b>	<b>US5077</b>
			
<b>US5077H</b>	<b>US5079</b>	<b>US5081</b>	<b>US5085</b>
			
<b>US5086</b>	<b>US5087</b>	<b>US5089</b>	<b>US5090</b>
			
<b>US5092</b>	<b>US5097</b>	<b>US5099</b>	<b>US6000</b>
			
<b>US6006</b>	<b>US6007</b>	<b>US6008</b>	<b>US6009</b>

**Note:** The photos or illustrations shown above are for reference purposes only. It does not suggest or imply that all the referenced pumps are manufactured by US Motor Works.



			
<b>US6018</b>	<b>US6020</b>	<b>US6022</b>	<b>US6023</b>
			
<b>US6030</b>	<b>US6034</b>	<b>US6037</b>	<b>US6038</b>
			
<b>US6046</b>	<b>US6047</b>	<b>US6048</b>	<b>US6049</b>
			
<b>US6050</b>	<b>US6056</b>	<b>US6075</b>	<b>US6142</b>
			
<b>US6143</b>	<b>US6144</b>	<b>US6145</b>	<b>US6146</b>

**Note:** The photos or illustrations shown above are for reference purposes only. It does not suggest or imply that all the referenced pumps are manufactured by US Motor Works.



			
<b>US6149</b>	<b>US6152</b>	<b>US6154</b>	<b>US6155</b>
			
<b>US6156</b>	<b>US6159</b>	<b>US6184</b>	<b>US6186</b>
			
<b>US6197</b>	<b>US6198</b>	<b>US6215</b>	<b>US6216</b>
			
<b>US6217</b>	<b>US6218</b>	<b>US6219</b>	<b>US6220</b>
			
<b>US6221</b>	<b>US6222</b>	<b>US6223</b>	<b>US6228</b>

**Note:** The photos or illustrations shown above are for reference purposes only. It does not suggest or imply that all the referenced pumps are manufactured by US Motor Works.

			
<b>US6231</b>	<b>US6232</b>	<b>US6233</b>	<b>US6240</b>
			
<b>US6241</b>	<b>US6242</b>	<b>US6244</b>	<b>US6249</b>
			
<b>US6250</b>	<b>US6252</b>	<b>US6338</b>	<b>US6341</b>
			
<b>US6349</b>	<b>US6350</b>	<b>US6599</b>	<b>US6657</b>
			
<b>US6662</b>	<b>US6699</b>	<b>US7100</b>	<b>US7101</b>

**Note:** The photos or illustrations shown above are for reference purposes only. It does not suggest or imply that all the referenced pumps are manufactured by US Motor Works.





















			
<b>US7103</b>	<b>US7103H</b>	<b>US7104</b>	<b>US7105</b>
			
<b>US7106</b>	<b>US7108</b>	<b>US7110</b>	<b>US7111</b>
			
<b>US7113</b>	<b>US7114</b>	<b>US7115</b>	<b>US7116</b>
			
<b>US7117</b>	<b>US7118</b>	<b>US7120</b>	<b>US7121</b>
			
<b>US7121-2</b>	<b>US7122</b>	<b>US7123</b>	<b>US7123H</b>

**Note:** The photos or illustrations shown above are for reference purposes only. It does not suggest or imply that all the referenced pumps are manufactured by US Motor Works.

			
<b>US7124</b>	<b>US7126</b>	<b>US7127</b>	<b>US7128</b>
			
<b>US7129</b>	<b>US7131</b>	<b>US7135</b>	<b>US7136</b>
			
<b>US7137</b>	<b>US7139</b>	<b>US7140</b>	<b>US7141</b>
			
<b>US7145</b>	<b>US7145HN</b>	<b>US7146</b>	<b>US7148</b>
			
<b>US7150</b>	<b>US7151</b>	<b>US7152</b>	<b>US7153</b>

**Note:** The photos or illustrations shown above are for reference purposes only. It does not suggest or imply that all the referenced pumps are manufactured by US Motor Works.

			
<b>US7156</b>	<b>US7158</b>	<b>US7159</b>	<b>US7160</b>
			
<b>US7161</b>	<b>US7162</b>	<b>US7163</b>	<b>US7164</b>
	<b>PHOTO NOT AVAILABLE</b>		
<b>US7165</b>	<b>US7166</b>	<b>US7167</b>	<b>US7168</b>
			
<b>US7169</b>	<b>US8901</b>	<b>US8902</b>	<b>US8903</b>
			
<b>US8904</b>	<b>US8905</b>	<b>US8908</b>	<b>US8909</b>

**Note:** The photos or illustrations shown above are for reference purposes only. It does not suggest or imply that all the referenced pumps are manufactured by US Motor Works.

















			
<b>US8911</b>	<b>US8914</b>	<b>US8917</b>	<b>US8922</b>
			
<b>US8923</b>	<b>US8924</b>	<b>US8925</b>	<b>US8926</b>
			
<b>US8927</b>	<b>US8928</b>	<b>US8929</b>	<b>US8930</b>
			
<b>US8931</b>	<b>US8932</b>	<b>US8933</b>	<b>US8934</b>
			
<b>US8935</b>	<b>US8936</b>	<b>US8937</b>	<b>US8938</b>

**Note:** The photos or illustrations shown above are for reference purposes only. It does not suggest or imply that all the referenced pumps are manufactured by US Motor Works.



 <b>US8940</b>	 <b>US8941</b>	 <b>US8942</b>	 <b>US8943</b>
 <b>US8944</b>	 <b>US8945</b>	 <b>US8946</b>	 <b>US8948</b>
 <b>US8949</b>	 <b>US8950</b>	 <b>US8951</b>	 <b>US8953</b>
 <b>US8955</b>	 <b>US8956</b>	 <b>US8957</b>	 <b>US8958</b>
 <b>US8959</b>	 <b>US8960</b>	 <b>US8961</b>	 <b>US8962</b>



















**Note:** The photos or illustrations shown above are for reference purposes only. It does not suggest or imply that all the referenced pumps are manufactured by US Motor Works.

			
<b>US8963</b>	<b>US8964</b>	<b>US8965</b>	<b>US8967</b>
			
<b>US8968</b>	<b>US8969</b>	<b>US8970</b>	<b>US8971</b>
			
<b>US8979</b>	<b>US8980</b>	<b>US8981</b>	<b>US8983</b>
			
<b>US9003</b>	<b>US9005</b>	<b>US9008</b>	<b>US9009</b>
			
<b>US9010</b>	<b>US9011</b>	<b>US9012</b>	<b>US9015</b>

**Note:** The photos or illustrations shown above are for reference purposes only. It does not suggest or imply that all the referenced pumps are manufactured by US Motor Works.

 <b>US9016</b>	 <b>US9017</b>	 <b>US9018</b>	 <b>US9020</b>
 <b>US9021</b>	 <b>US9025</b>	 <b>US9026</b>	 <b>US9027</b>
 <b>US9028</b>	 <b>US9029</b>	 <b>US9031</b>	 <b>US9033N</b>
 <b>US9034</b>	 <b>US9035</b>	 <b>US9039</b>	 <b>US9040N</b>
 <b>US9041</b>	 <b>US9043N</b>	 <b>US9044</b>	 <b>US9045</b>

**Note:** The photos or illustrations shown above are for reference purposes only. It does not suggest or imply that all the referenced pumps are manufactured by US Motor Works.

			
<b>US9046</b>	<b>US9048</b>	<b>US9049</b>	<b>US9050</b>
			
<b>US9052</b>	<b>US9053</b>	<b>US9056</b>	<b>US9057</b>
			
<b>US9058</b>	<b>US9059</b>	<b>US9060</b>	<b>US9061</b>
			
<b>US9063</b>	<b>US9064</b>	<b>US9065</b>	<b>US9066</b>
			
<b>US9067</b>	<b>US9068</b>	<b>US9069</b>	<b>US9071</b>

**Note:** The photos or illustrations shown above are for reference purposes only. It does not suggest or imply that all the referenced pumps are manufactured by US Motor Works.



 <b>US9074</b>	 <b>US9075</b>	 <b>US9076</b>	 <b>US9077</b>
 <b>US9078</b>	 <b>US9080</b>	 <b>US9082</b>	 <b>US9083</b>
 <b>US9084</b>	 <b>US9085</b>	 <b>US9086</b>	 <b>US9087</b>
 <b>US9092</b>	 <b>US9093</b>	 <b>US9094</b>	 <b>US9097</b>
 <b>US9098</b>	 <b>US9099</b>	 <b>US9100</b>	 <b>US9102</b>

**Note:** The photos or illustrations shown above are for reference purposes only. It does not suggest or imply that all the referenced pumps are manufactured by US Motor Works.

			
<b>US9104</b>	<b>US9105</b>	<b>US9106</b>	<b>US9107</b>
			
<b>US9108</b>	<b>US9109</b>	<b>US9110</b>	<b>US9111</b>
			
<b>US9114</b>	<b>US9115</b>	<b>US9116</b>	<b>US9117</b>
			
<b>US9119</b>	<b>US9120</b>	<b>US9122</b>	<b>US9128</b>
			
<b>US9129</b>	<b>US9130</b>	<b>US9131</b>	<b>US9132</b>

**Note:** The photos or illustrations shown above are for reference purposes only. It does not suggest or imply that all the referenced pumps are manufactured by US Motor Works.

			
<b>US9133</b>	<b>US9140</b>	<b>US9141</b>	<b>US9142</b>
			
<b>US9145</b>	<b>US9146</b>	<b>US9147</b>	<b>US9149</b>
			
<b>US9150</b>	<b>US9152</b>	<b>US9153</b>	<b>US9154</b>
			
<b>US9155</b>	<b>US9160</b>	<b>US9161</b>	<b>US9162</b>
			
<b>US9163</b>	<b>US9165</b>	<b>US9166</b>	<b>US9167</b>

**Note:** The photos or illustrations shown above are for reference purposes only. It does not suggest or imply that all the referenced pumps are manufactured by US Motor Works.

			
<b>US9168</b>	<b>US9170</b>	<b>US9171</b>	<b>US9172</b>
			
<b>US9173</b>	<b>US9175</b>	<b>US9176</b>	<b>US9177</b>
			
<b>US9178</b>	<b>US9179</b>	<b>US9180</b>	<b>US9189</b>
			
<b>US9193</b>	<b>US9198</b>	<b>US9200</b>	<b>US9201</b>
			
<b>US9202</b>	<b>US9203</b>	<b>US9206</b>	<b>US9207</b>

**Note:** The photos or illustrations shown above are for reference purposes only. It does not suggest or imply that all the referenced pumps are manufactured by US Motor Works.



			
<b>US9208</b>	<b>US9209</b>	<b>US9211</b>	<b>US9212</b>
			
<b>US9213</b>	<b>US9214</b>	<b>US9215</b>	<b>US9216</b>
			
<b>US9218</b>	<b>US9219</b>	<b>US9220</b>	<b>US9221</b>
			
<b>US9222</b>	<b>US9223</b>	<b>US9224</b>	<b>US9225</b>
			
<b>US9226</b>	<b>US9227</b>	<b>US9228</b>	<b>US9230</b>

**Note:** The photos or illustrations shown above are for reference purposes only. It does not suggest or imply that all the referenced pumps are manufactured by US Motor Works.

			
<b>US9231</b>	<b>US9232</b>	<b>US9234</b>	<b>US9236</b>
			
<b>US9237</b>	<b>US9238</b>	<b>US9239</b>	<b>US9241</b>
			
<b>US9242</b>	<b>US9245</b>	<b>US9250</b>	<b>US9251</b>
			
<b>US9252</b>	<b>US9253</b>	<b>US9254</b>	<b>US9255</b>
			
<b>US9256</b>	<b>US9257</b>	<b>US9258</b>	<b>US9259</b>

**Note:** The photos or illustrations shown above are for reference purposes only. It does not suggest or imply that all the referenced pumps are manufactured by US Motor Works.

			
US9260	US9261	US9262	US9263
			
US9264	US9268	US9269	US9270
			
US9271	US9272	US9273	US9274
			
US9275	US9276	US9277	US9278
			
US9279	US9280	US9282	US9284

**Note:** The photos or illustrations shown above are for reference purposes only. It does not suggest or imply that all the referenced pumps are manufactured by US Motor Works.

			
<b>US9288</b>	<b>US9289</b>	<b>US9291</b>	<b>US9292</b>
			
<b>US9293</b>	<b>US9296</b>	<b>US9299</b>	<b>US9300</b>
			
<b>US9301</b>	<b>US9302</b>	<b>US9304</b>	<b>US9305</b>
			
<b>US9306</b>	<b>US9307</b>	<b>US9309</b>	<b>US9310</b>
			
<b>US9311</b>	<b>US9312</b>	<b>US9313</b>	<b>US9314</b>

**Note:** The photos or illustrations shown above are for reference purposes only. It does not suggest or imply that all the referenced pumps are manufactured by US Motor Works.



<p><b>PHOTO NOT AVAILABLE</b></p> <p><b>US9315</b></p>	 <p><b>US9318</b></p>	 <p><b>US9320</b></p>	 <p><b>US9321</b></p>
 <p><b>US9324</b></p>	 <p><b>US9325</b></p>	 <p><b>US9328</b></p>	 <p><b>US9332</b></p>
 <p><b>US9333</b></p>	 <p><b>US9334</b></p>	 <p><b>US9335</b></p>	 <p><b>US9337</b></p>
 <p><b>US9338</b></p>	 <p><b>US9339</b></p>	 <p><b>US9340</b></p>	 <p><b>US9342</b></p>
 <p><b>US9343</b></p>	 <p><b>US9344</b></p>	 <p><b>US9345</b></p>	 <p><b>US9346</b></p>

















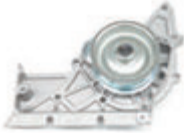



**Note:** The photos or illustrations shown above are for reference purposes only. It does not suggest or imply that all the referenced pumps are manufactured by US Motor Works.

			
<b>US9347</b>	<b>US9348</b>	<b>US9349</b>	<b>US9351</b>
			<p style="font-size: 2em; font-weight: bold; margin: 0;">PHOTO NOT AVAILABLE</p>
<b>US9352</b>	<b>US9353</b>	<b>US9354</b>	<b>US9356</b>
			
<b>US9359</b>	<b>US9360</b>	<b>US9362</b>	<b>US9364</b>
			
<b>US9365</b>	<b>US9367</b>	<b>US9368</b>	<b>US9369</b>
			
<b>US9371</b>	<b>US9374</b>	<b>US9375</b>	<b>US9376</b>

**Note:** The photos or illustrations shown above are for reference purposes only. It does not suggest or imply that all the referenced pumps are manufactured by US Motor Works.







			
<b>US9377</b>	<b>US9378</b>	<b>US9379</b>	<b>US9380</b>
			<b>PHOTO NOT AVAILABLE</b>
<b>US9382</b>	<b>US9383</b>	<b>US9385</b>	<b>US9388</b>
			
<b>US9389</b>	<b>US9393</b>	<b>US9394</b>	<b>US9395</b>
			
<b>US9399</b>	<b>US9401</b>	<b>US9402</b>	<b>US9403</b>
			
<b>US9405</b>	<b>US9406</b>	<b>US9410</b>	<b>US9414</b>

**Note:** The photos or illustrations shown above are for reference purposes only. It does not suggest or imply that all the referenced pumps are manufactured by US Motor Works.

			
<b>US9415</b>	<b>US9416</b>	<b>US9419</b>	<b>US9421</b>
			
<b>US9426</b>	<b>US9427</b>	<b>US9429</b>	<b>US9434</b>
			
<b>US9440</b>	<b>US9446</b>	<b>US9448</b>	<b>US9450</b>
			
<b>US9456</b>	<b>US9460</b>	<b>US9461</b>	<b>US9462</b>
			
<b>US9463</b>	<b>US9464</b>	<b>US9465</b>	<b>US9467</b>

**Note:** The photos or illustrations shown above are for reference purposes only. It does not suggest or imply that all the referenced pumps are manufactured by US Motor Works.



			
US9468	US9470	US9471	US9472
			
US9473	US9474	US9475	US9476
	<b>PHOTO NOT AVAILABLE</b>		
US9477	US9486	US9488	US9489
	<b>PHOTO NOT AVAILABLE</b>		
US9493	US9494	US9495	US9499

**Note:** The photos or illustrations shown above are for reference purposes only. It does not suggest or imply that all the referenced pumps are manufactured by US Motor Works.

**CAUTION:**  
ENGLISH

- Always refer to OEM replacement interval guidelines, installation instructions, special tool requirements, and specifications before installing timing kit parts.
- Failure to follow the OEM instructions and guidelines will void any warranty expressed or implied.
- For maximum timing belt and system life, timing belts, tensioners and idlers should be replaced at the same time.
- Check for engine damage and check compression before beginning the job. Interference engines can experience valve to piston damage if a timing belt failure has occurred.
- Do not turn crankshaft or camshaft with timing belt removed.
- Observe all tightening torques.

**PRECAUCIÓN:**  
SPANISH

- Refiérase siempre al manual del fabricante para saber intervalos de reemplazo, instrucciones de instalación, requerimientos de herramienta especial y especificaciones antes de instalar partes de distribución.
- De no seguirse las instrucciones y guías del fabricante, invalidará cualquier garantía expresa o implicada.
- Para máxima vida útil de la banda y sistema del tiempo, la banda del tiempo, tensores y poleas deben reemplazarse al mismo tiempo.
- Revise algún daño en el motor, revise también la compresión antes de iniciar el trabajo. Los motores de interferencia pueden experimentar daño en las válvulas o los pistones si ha ocurrido una falla en la banda del tiempo.
- No gire el cigüeñal ni el árbol de levas con la banda removida.
- Observe todos los torques de apriete o ajuste.

## TIMING KITS WITH WATER PUMPS

US Motor Works is pleased to announce our new line of timing kits with water pumps including all the parts needed to do the job right!

OEM's recommend that timing belts should be replaced every 60,000 to 100,000 miles, they also recommend that all the components of the timing system should all be replaced at once.

Replacing all the timing belt system components at the same time assures the entire system will operate and perform correctly and to the OEM specifications. The US Motor Works TIMING KIT WITH WATER PUMP package allows you to replace all the components designed to work and fit together to the optimum conditions, while at the same time increase the sales and decrease the potential returns.

TIMING KIT WITH WATER PUMPS INCLUDE:

- NEW WATER PUMP (Including gasket(s) and all accessories needed)
- TIMING BELT(s)
- TENSIONER(s)
- IDLER(s)
- HYDRAULIC TENSIONER (if applicable)





# TIMING KIT WITH WATER PUMP **USMW** APPLICATION GUIDE

Professional Series

Model Years	Engine Liters	Application Description	USMW
<b>ACURA</b>			
<b>CL</b>			
1997	L4-2.2L		USTK244-186
1999-1998	L4-2.3L		USTK244-186
1999-1997	V6-3.0L		USTK286A
2003-2001	V6-3.2L		USTK286
<b>INTEGRA</b>			
1993-1992	L4-1.7L		USTK227
2001-1994	L4-1.8L	WITH VTEC ENGINE	USTK247
2001-1996	L4-1.8L		USTK184
<b>MDX</b>			
2002-2001	V6-3.5L		USTK286
2006-2003	V6-3.5L		USTK329
2010-2007	V6-3.7L		USTK329
<b>RL</b>			
2004-1996	V6-3.5L		USTK279-280
2008-2005	V6-3.5L		USTK329
<b>SLX</b>			
1997-1996	V6-3.2L		USTK221A
1999-1998	V6-3.5L	STANDARD TRANS.	USTK303
<b>TL</b>			
1998-1996	V6-3.2L		USTK193A
1999	V6-3.2L	DOHC 122 CI	USTK286A
2003-2000	V6-3.2L		USTK286
2008-2004	V6-3.2L		USTK329
2011-2007	V6-3.5L		USTK329
2011-2009	V6-3.7L		USTK329
<b>VIGOR</b>			
1994-1992	L5-2.5L		USTK211A
<b>ZDX</b>			
2010	V6-3.7L		USTK329
<b>ACURA</b>			
<b>INTEGRA</b>			
1995-1990	L4-1.8L		USTK184A
<b>LEGEND</b>			
1995-1991	V6-3.2L		USTK193
<b>TL</b>			
1998-1995	L5-2.5L		USTK211
<b>AUDI</b>			
<b>90</b>			
1995	V6-2.8L	12 VALVE	USTK218
1995-1993	V6-2.8L	30 VALVE	USTK218A
<b>100</b>			
1994-1992	V6-2.8L	30 VALVE	USTK218A
<b>90 QUATTRO</b>			
1995	V6-2.8L	12 VALVE	USTK218
1995	V6-2.8L	30 VALVE	USTK218A
<b>A3</b>			
2010	L4-2.0L		USTK913
2008-2006	L4-2.0L		USTK334
<b>A4</b>			
2001	L4-1.8L		USTK306
2000-1997	L4-1.8L		USTK317
2006-2001	L4-1.8L	NON TURBO	USTK306A
2008-2005	L4-2.0L		USTK334
1997-1996	V6-2.8L	12 VALVE	USTK218
2001-1997	V6-2.8L		USTK297
2005-2002	V6-3.0L	MANUAL BELT TENSIONER	USTK330
<b>A4 QUATTRO</b>			
2001	L4-1.8L		USTK306
2000-1997	L4-1.8L		USTK317
2005-2001	L4-1.8L	NON TURBO	USTK306A
2008-2005	L4-2.0L		USTK334
1997-1996	V6-2.8L	12 VALVE	USTK218
2001-1997	V6-2.8L		USTK297
2004-2002	V6-3.0L	MANUAL BELT TENSIONER	USTK330

Model Years	Engine Liters	Application Description	USMW
<b>A6</b>			
2004-2002	V6-3.0L	MANUAL BELT TENSIONER	USTK330
<b>A6</b>			
1998-1995	V6-2.8L	12 VALVE	USTK218
2001-1998	V6-2.8L		USTK297
<b>A6 QUATTRO</b>			
1998-1995	V6-2.8L	12 VALVE	USTK218
2001-1998	V6-2.8L		USTK297
2004-2000	V6-2.7L		USTK297B
2004-2002	V6-3.0L	MANUAL BELT TENSIONER	USTK330
2000	V8-4.2L		USTK297C
2004-2001	V8-4.2L		USTK297A
<b>A8 QUATTRO</b>			
2006-2001	V8-4.2L		USTK297A
<b>ALLROAD QUATTRO</b>			
2005-2001	V6-2.7L		USTK297B
<b>CABRIOLET</b>			
1995-1994	V6-2.8L	30 VALVE	USTK218A
1998-1995	V6-2.8L	12 VALVE	USTK218
<b>RS6</b>			
2004-2003	V8-4.2L		USTK297A
<b>S4</b>			
2002-2000	V6-2.7L		USTK297B
<b>S6</b>			
2003-2002	V8-4.2L		USTK297A
<b>S8</b>			
2003-2001	V8-4.2L		USTK297A
<b>TT</b>			
2000	L4-1.8L		USTK306B
2008	L4-2.0L		USTK334
2006-2001	L4-1.8L		USTK306
<b>TT QUATTRO</b>			
2000	L4-1.8L		USTK306B
2006-2001	L4-1.8L		USTK306
<b>CHEVROLET</b>			
<b>AVEO</b>			
2008-2004	L4-1.6L		USTK335
<b>AVEO5</b>			
2008-2007	L4-1.6L		USTK335
<b>CHEVY</b>			
2010-1998	L4-1.6L	MEXICO	USTK203
<b>OPTRA</b>			
2007-2004	L4-2.0L		USTK309
<b>CHRYSLER</b>			
<b>300</b>			
2010-2005	V6-3.5L		USTK295B
<b>300M</b>			
2004-2003	V6-3.5L		USTK295A
2002-1998	V6-3.5L		USTK295
<b>CIRRUS</b>			
2000	L4-2.4L		USTK265B
<b>CONCORDE</b>			
2002	V6-3.5L		USTK295
1994-1993	V6-3.5L		USTK219
1997-1995	V6-3.5L		USTK255
2001-1998	V6-3.2L		USTK295
2004-2003	V6-3.5L		USTK295A
<b>DAYTONA</b>			
1990	L4-2.0L		USTK153
1993-1990	L4-2.5L		USTK153
<b>DYANSTY</b>			
1990-1988	V6-3.0L		USTK139
<b>GRAND CARAVAN</b>			
2000	V6-3.0L		USTK139



Model Years	Engine Liters	Application Description	USMW
<b>INTREPID</b>			
1994-1993	V6-3.5L		USTK219
1997-1995	V6-3.5L		USTK255
2001-1998	V6-3.2L		USTK295
2002-2000	V6-3.5L		USTK295
<b>LEBARON</b>			
1990	L4-2.0L		USTK153
1993-1990	L4-2.5L		USTK153
1995-1990	V6-3.0L		USTK139
<b>LHS</b>			
1994	V6-3.5L		USTK219
1997-1995	V6-3.5L		USTK255
2001-1999	V6-3.5L		USTK295
<b>NEON</b>			
1997-1995	L4-2.0L		USTK246
1997-1995	L4-2.0L	OPTIONAL, W/HYD. TIMING SETUP	USTK246A
<b>NEW YORKER</b>			
1994	V6-3.5L		USTK219
1989-1988	V6-3.0L		USTK139
1996-1995	V6-3.5L		USTK255
<b>PACIFICA</b>			
2004	V6-3.5L		USTK295A
2006-2005	V6-3.5L		USTK295B
2008-2007	V6-4.0L		USTK295B
<b>PT CRUISER</b>			
2002-2001	L4-2.4L		USTK265B
2009-2003	L4-2.4L		USTK265A
<b>SEBRING</b>			
1999-1995	L4-2.0L	OPTIONAL, W/HYD. TIMING SETUP	USTK246
1999-1995	L4-2.0L	OPTIONAL, W/MECHANICAL TENSIONER. TIMING SETUP	USTK246A
2002-1998	L4-2.4L		USTK265B
2006-2003	L4-2.4L		USTK265A
2005-2001	V6-3.0L	INC. HYD. TENSIONER	USTK259
2010-2007	V6-3.5L		USTK295B
<b>TOWN AND COUNTRY</b>			
2010-2008	V6-4.0L		USTK295B
<b>VOYAGER</b>			
2003	L4-2.4L		USTK265A
2002-2000	L4-2.4L		USTK265B
2000	V6-3.0L		USTK139
<b>DAEWOO</b>			
<b>LEGANZA</b>			
2002-1999	L4-2.2L		USTK305
<b>NUBIRA</b>			
2002-1999	L4-2.0L		USTK309
<b>DODGE</b>			
<b>AVENGER</b>			
1999-1995	L4-2.0L	OPTIONAL, W/HYD. TIMING SETUP	USTK246
1999-1995	L4-2.0L	OPTIONAL, W/MECHANICAL TENSIONER. TIMING SETUP	USTK246A
2010-2008	V6-3.5L		USTK295B
<b>CARAVAN</b>			
1995-1990	L4-2.5L		USTK153
2002-1998	L4-2.4L	W/ WP BYPASS TUBE	USTK265B
2000-1987	V6-3.0L		USTK139
<b>CHALLENGER</b>			
2010-2009	V6-3.5L		USTK295B
<b>CHARGER</b>			
2010-2006	V6-3.5L		USTK295B
<b>DAKOTA</b>			
1995-1990	L4-2.5L		USTK153
<b>DAYTONA</b>			
1990	L4-2.2L		USTK153
1995-1990	L4-2.5L		USTK153
1993-1990	V6-3.0L		USTK139

Model Years	Engine Liters	Application Description	USMW
<b>DYNASTY</b>			
1993-1990	L4-2.5L		USTK153
1993-1988	V6-3.0L		USTK139
<b>GRAND CARAVAN</b>			
2000-1988	V6-3.0L		USTK139
2010-2008	V6-4.0L		USTK295B
<b>INTREPID</b>			
1994-1993	V6-3.5L		USTK219
1997-1995	V6-3.5L		USTK255
2001-1998	V6-3.2L		USTK295
2002-2001	V6-3.5L		USTK295
2004-2003	V6-3.5L		USTK295A
<b>JOURNEY</b>			
2010-2009	V6-3.5L		USTK295B
<b>MAGNUM</b>			
2008-2005	V6-3.5L		USTK295B
<b>NEON</b>			
1999-1995	L4-2.0L	OPTIONAL, W/HYD. TIMING SETUP	USTK246
1999-1995	L4-2.0L	OPTIONAL, W/MECHANICAL TENSIONER. TIMING SETUP	USTK246A
2005-1995	L4-2.0L	MECHANICAL TENSIONER	USTK245
2005-1995	L4-2.0L	HYDRAULIC TENSIONER	USTK245C
2005-2003	L4-2.4L		USTK265A
<b>NITRO</b>			
2010-2009	V6-4.0L		USTK295B
<b>OMNI</b>			
1990	L4-2.2L		USTK153
<b>SHADOW</b>			
1994-1990	L4-2.2L		USTK153
1994-1990	L4-2.5L		USTK153
1994-1992	V6-3.0L		USTK139
<b>SPIRIT</b>			
1995-1990	L4-2.5L		USTK153
1995-1989	V6-3.0L		USTK139
<b>STEALTH</b>			
1996-1991	V6-3.0L	SOHC	USTK139
1996-1991	V6-3.0L	DOHC	USTK195
<b>STRATUS</b>			
2000-1995	L4-2.0L	MECHANICAL TENSIONER	USTK245
2000-1995	L4-2.0L	HYDRAULIC TENSIONER	USTK245C
2002-1998	L4-2.4L	W/ WP BYPASS TUBE	USTK265B
2006-2003	L4-2.4L		USTK265A
2004-2001	V6-3.0L	INC. HYD. TENSIONER	USTK259
<b>EAGLE</b>			
<b>TALON</b>			
1998-1995	L4-2.0L		USTK246A
<b>VISION</b>			
1994-1993	V6-3.5L		USTK219
1997-1995	V6-3.5L		USTK255
<b>FORD</b>			
<b>CONTOUR</b>			
2000	L4-2.0L	DOHC	USTK294A
<b>ESCORT</b>			
1996-1991	L4-1.9L		USTK194
2001-2000	L4-2.0L	DOHC	USTK294A
2002-1997	L4-2.0L	SOHC	USTK283
<b>FOCUS</b>			
2003-2000	L4-2.0L	SOHC	USTK283A
2004-2000	L4-2.0L	DOHC	USTK294A
<b>PROBE</b>			
1997-1993	L4-2.0L		USTK228
<b>RANGER</b>			
1997-1995	L4-2.3L		USTK276
2001-1998	L4-2.5L		USTK276

TIMING KITS



# TIMING KIT WITH WATER PUMP **USMW** APPLICATION GUIDE

*Professional Series*

Model Years	Engine Liters	Application Description	USMW
<b>GEO</b>			
<b>PRIZM</b>			
1989	L4-1.6L		USTK036
1992-1990	L4-1.6L		USTK036
1997-1993	L4-1.8L		USTK235
<b>HONDA</b>			
<b>ACCORD</b>			
1989-1986	L4-2.0L		USTK160
1997-1990	L4-2.2L	WITHOUT VTEC ENGINE	USTK186-187
1997-1994	L4-2.2L	WITH VTEC ENGINE	USTK244-186
2002-1998	L4-2.3L		USTK244-186
1997-1995	V6-2.7L		USTK263
2002-1998	V6-3.0L	DOHC 3/23/99 AND ABOVE	USTK286A
2007-2003	V6-3.0L		USTK329
2011-2008	V6-3.5L		USTK329
<b>ACCORD CROSSTOUR</b>			
2011-2010	V6-3.5L		USTK329
<b>CIVIC</b>			
1995-1988	L4-1.5L		USTK143
1995-1992	L4-1.5L	VX	USTK223
1995-1992	L4-1.6L		USTK224
2000-1996	L4-1.6L	EXCEPT SI	USTK224A
2000-1999	L4-1.6L	SI ONLY	USTK227A
2005-2001	L4-1.7L		USTK312
<b>CIVIC DEL SOL</b>			
1995-1993	L4-1.5L		USTK143
1995-1993	L4-1.6L	SOHC	USTK224
1995-1994	L4-1.6L	DOHC	USTK227
1997-1996	L4-1.6L	EXCEPT SI	USTK224A
1997-1996	L4-1.6L	SI ONLY	USTK227A
<b>CR-V</b>			
2001-1997	L4-2.0L		USTK184
<b>CRX</b>			
1991-1988	L4-1.5L		USTK143
<b>ODYSSEY</b>			
1998	L4-2.3L		USTK244-186
1997-1995	L4-2.2L		USTK186-187
1999	V6-3.5L	DOHC	USTK286A
2004-2000	V6-3.5L		USTK286
2010-2005	V6-3.5L	MANUAL BELT TENSIONER	USTK329
<b>PASSPORT</b>			
1997-1994	V6-3.2L		USTK221A
2002-1998	V6-3.2L	STANDARD TRANS.	USTK303
<b>PILOT</b>			
2004-2003	V6-3.5L		USTK286
2010-2005	V6-3.5L	MANUAL BELT TENSIONER	USTK329
<b>PRELUDE</b>			
1987-1985	L4-2.0L		USTK160
1996-1992	L4-2.2L	SOHC	USTK186-187
1996-1992	L4-2.3L		USTK216-186
2001-1993	L4-2.2L	VTEC DOHC	USTK226-186
<b>RIDGELINE</b>			
2010-2006	V6-3.5L	MANUAL BELT TENSIONER	USTK329
<b>HYUNDAI</b>			
<b>ELANTRA</b>			
2005-1999	L4-2.0L		USTK284
<b>SANTA FE</b>			
2006-2001	V6-2.7L		USTK315
2006-2003	V6-3.5L	TURBO	USTK323
<b>SONATA</b>			
1998-1990	V6-3.0L		USTK139
2001-1999	V6-2.5L		USTK315
2005-2002	V6-2.7L		USTK315
<b>TIBURON</b>			
1997	L4-1.8L		USTK284
1997	L4-2.0L		USTK284

Model Years	Engine Liters	Application Description	USMW
2001-1998	L4-2.0L		USTK284
2005-2003	L4-2.0L		USTK284
2008-2003	V6-2.7L		USTK315
<b>TUCSON</b>			
2005	L4-2.0L		USTK284
2009-2005	V6-2.7L		USTK315
<b>XG350</b>			
2005-2002	V6-3.5L	TURBO	USTK323
<b>INFINITI</b>			
<b>QX4</b>			
2000-1997	V6-3.3L		USTK249
<b>ISUZU</b>			
<b>AMIGO</b>			
2000-1998	V6-3.2L		USTK303
<b>AXIOM</b>			
2003-2002	V6-3.5L		USTK303
<b>OASIS</b>			
1997-1996	L4-2.2L		USTK186-187
1999-1998	L4-2.3L		USTK244-186
<b>RODEO</b>			
1997-1993	V6-3.2L		USTK221A
2004-1998	V6-3.2L	AUTOMATIC TRANS.	USTK303
<b>RODEO SPORT</b>			
2003-2001	V6-3.2L	AUTOMATIC TRANS.	USTK303
<b>TROOPER</b>			
1997-1992	V6-3.2L		USTK221A
2002-1998	V6-3.5L	AUTOMATIC TRANS.	USTK303
<b>VEHICROSS</b>			
2001-1999	V6-3.5L	NON TURBO MANUAL TRANS	USTK303
<b>JEEP</b>			
<b>LIBERTY</b>			
2002	L4-2.4L	W/ WP BYPASS TUBE	USTK265B
2005-2002	L4-2.4L	CHECK TENSIONER DESIGN	USTK265A
<b>TJ</b>			
2006-2003	L4-2.4L		USTK265A
<b>WRANGLER</b>			
2006-2003	L4-2.4L		USTK265A
<b>KIA</b>			
<b>AMANTI</b>			
2006-2004	V6-3.5L	TURBO	USTK323
<b>MAGENTIS</b>			
2001	V6-2.5L		USTK315
2006-2002	V6-2.7L		USTK315
<b>OPTIMA</b>			
2001	V6-2.5L		USTK315
2006-2002	V6-2.7L		USTK315
<b>SEDONA</b>			
2005-2002	V6-3.5L	TURBO	USTK323
<b>SORENTO</b>			
2006-2003	V6-3.5L		USTK323A
<b>SPECTRA</b>			
2007-2004	L4-2.0L		USTK284
<b>SPECTRA5</b>			
2007-2005	L4-2.0L		USTK284
<b>SPORTAGE</b>			
2005	L4-2.0L		USTK284
2002-1995	L4-2.0L		USTK281
2010-2005	V6-2.7L		USTK315
<b>LEXUS</b>			
<b>ES250</b>			
1991-1990	V6-2.5L		USTK157
<b>ES300</b>			
1993-1992	V6-3.0L		USTK200
2003-2002	V6-3.0L		USTK257A

Model Years	Engine Liters	Application Description	USMW
2006-2004	V6-3.3L		USTK257A
<b>GS300</b>			
1997-1993	L6-3.0L		USTK215
2005-1998	L6-3.0L		USTK215A
<b>GS400</b>			
2000-1998	V8-4.0L		USTK298
<b>GS430</b>			
2007-2001	V8-4.3L		USTK298
<b>GX470</b>			
2009-2003	V8-4.7L		USTK298
<b>IS300</b>			
2005-2001	L6-3.0L		USTK215A
<b>LS400</b>			
1997-1990	V8-4.0L		USTK190
2000-1998	V8-4.0L		USTK298
<b>LS430</b>			
2006-2001	V8-4.3L		USTK298
<b>LX470</b>			
2007-1998	V8-4.7L		USTK298
<b>RX330</b>			
2006-2004	V6-3.3L		USTK257A
<b>RX400H</b>			
2008-2006	V6-3.3L		USTK257A
<b>SC300</b>			
2000-1992	L6-3.0L		USTK215
<b>SC400</b>			
1997-1992	V8-4.0L		USTK190
2000-1998	V8-4.0L		USTK298
<b>SC430</b>			
2010-2002	V8-4.3L		USTK298
<b>LEXUS</b>			
<b>ES300</b>			
2001-1994	V6-3.0L		USTK257
<b>RX300</b>			
2003-1999	V6-3.0L		USTK257
<b>MAZDA</b>			
<b>626</b>			
2001-1993	L4-2.0L		USTK228
<b>B2300</b>			
1997-1995	L4-2.3L		USTK276
<b>B2500</b>			
2001-1998	L4-2.5L	1975 CC	USTK276
<b>MX-6</b>			
1997-1993	L4-2.0L		USTK228
<b>PROTEGE</b>			
1997-1993	L4-2.0L		USTK222
<b>PROTEGE5</b>			
2003-2002	L4-2.0L		USTK228
<b>MERCURY</b>			
<b>COUGAR</b>			
2002-2000	L4-2.0L	DOHC	USTK294A
<b>MYSTIQUE</b>			
2000	L4-2.0L	DOHC	USTK294A
<b>TRACER</b>			
1996-1991	L4-1.9L		USTK194
1999-1997	L4-2.0L	SOHC	USTK283
<b>VILLAGER</b>			
1994-1993	V6-3.0L		USTK104
<b>MITSUBISHI</b>			
<b>3000GT</b>			
1998-1991	V6-3.0L	DOHC	USTK195
1999-1997	V6-3.0L	SOHC	USTK139
<b>DIAMANTE</b>			
1995-1992	V6-3.0L	DOHC	USTK195

Model Years	Engine Liters	Application Description	USMW
1996-1992	V6-3.0L	SOHC	USTK139
2004-1997	V6-3.5L	DOHC	USTK287
<b>ECLIPSE</b>			
1999-1995	L4-2.0L		USTK246A
2010-2006	V6-3.8L	DOHC 121 CI	USTK287
<b>ENDEAVOR</b>			
2010-2004	V6-3.8L	DOHC	USTK287
<b>GALANT</b>			
1988	V6-3.0L		USTK139
2003-1999	V6-3.0L		USTK259
2009-2004	V6-3.8L		USTK287
<b>LANCER</b>			
2007-2002	L4-2.0L		USTK201A
<b>MIGHTY MAX</b>			
1993-1990	V6-3.0L		USTK139
<b>MONTERO</b>			
1994-1989	V6-3.0L		USTK139
2000-1997	V6-3.5L		USTK287
<b>MONTERO SPORT</b>			
2003-1997	V6-3.0L		USTK259
2004-1999	V6-3.5L		USTK287
<b>SIGMA</b>			
1990-1989	V6-3.0L		USTK139
<b>NISSAN</b>			
<b>APRIO</b>			
2010-2008	L4-1.6L	MEXICO	USTK1095
<b>FRONTIER</b>			
2004-1999	V6-3.3L		USTK249
<b>MAXIMA</b>			
1994-1985	V6-3.0L		USTK104
<b>PATHFINDER</b>			
2000-1996	V6-3.3L		USTK249
<b>PLATINA</b>			
2010-2002	L4-1.6L	MEXICO	USTK1095
<b>QUEST</b>			
1994-1993	V6-3.0L		USTK104
<b>TSURU</b>			
1997-1984	L4-1.6L	MEXICO	USTK077
<b>XTERRA</b>			
2004-2000	V6-3.3L		USTK249
<b>PLYMOUTH</b>			
<b>ACCLAIM</b>			
1995-1990	L4-2.5L		USTK153
1995-1989	V6-3.0L		USTK139
<b>BREEZE</b>			
2000-1996	L4-2.0L	MECHANICAL TENSIONER	USTK245
2000-1996	L4-2.0L	HYDRAULIC TENSIONER	USTK245C
2000-1997	L4-2.4L	W/ WP BYPASS TUBE	USTK265B
<b>GRAND VOYAGER</b>			
1989-1988	V6-3.0L		USTK139
2000-1992	V6-3.0L		USTK139
<b>HORIZON</b>			
1990	L4-2.2L		USTK153
<b>NEON</b>			
1999-1995	L4-2.0L	OPTIONAL, W/HYD. TIMING SETUP	USTK246
1999-1995	L4-2.0L		USTK246A
2001-1995	L4-2.0L	MECHANICAL TENSIONER	USTK245
2001-1995	L4-2.0L	HYDRAULIC TENSIONER	USTK245C
<b>PROWLER</b>			
1997	V6-3.5L		USTK255
<b>SUNDANCE</b>			
1994-1990	L4-2.2L		USTK153
1994-1990	L4-2.5L		USTK153
1994-1992	V6-3.0L		USTK139



# TIMING KIT WITH WATER PUMP **USMW** APPLICATION GUIDE

*Professional Series*

Model Years	Engine Liters	Application Description	USMW
<b>VOYAGER</b>			
1995-1990	L4-2.5L		USTK153
2000-1998	L4-2.4L	W/O WP BYPASS TUBE	USTK265B
2000-1987	V6-3.0L		USTK139
<b>PONTIAC</b>			
<b>G3</b>			
2008-2007	L4-1.6L		USTK335
<b>LEMANS</b>			
1990	L4-2.0L		USTK163
<b>OPTIMA</b>			
1990	L4-2.0L		USTK163
<b>SUNBIRD</b>			
1994-1990	L4-2.0L		USTK163
<b>WAVE</b>			
2008-2005	L4-1.6L		USTK335
<b>RENAULT</b>			
<b>CLIO</b>			
2010-2003	L4-1.6L	MEXICO	USTK1095
<b>KANGOO</b>			
2010-2003	L4-1.6L	MEXICO	USTK1095
<b>SAAB</b>			
<b>9-2X</b>			
2005	H4-2.0L		USTK328
2006	H4-2.5L	DOHC	USTK328
2006-2005	H4-2.5L	SOHC; MANUAL TRANS.	USTK304
<b>SATURN</b>			
<b>VUE</b>			
2007-2004	V6-3.5L	MANUAL BELT TENSIONER	USTK329
<b>SUBARU</b>			
<b>BAJA</b>			
2006-2003	H4-2.5L		USTK307
2006-2004	H4-2.5L		USTK328
<b>FORESTER</b>			
1998	H4-2.5L	1997 CC	USTK277A
2006	H4-2.5L	AUG ENG.	USTK304B
2005-1999	H4-2.5L	SOHC; MANUAL TRANS.	USTK304
2005-2003	H4-2.5L	AUTOMATIC TRANS.	USTK304A
2008-2004	H4-2.5L	DOHC	USTK328
2010-2006	H4-2.5L		USTK304C
<b>IMPREZA</b>			
1993	H4-1.8L	W/O CALIF. EMISSIONS	USTK172
1998	H4-2.5L		USTK277A
2005	H4-2.0L		USTK328
2008	H4-2.5L		USTK304C
1997-1993	H4-1.8L		USTK254
1997-1995	H4-2.2L	W/O CALIF. EMISSIONS	USTK172
1997-1995	H4-2.2L	W/O INTERGRATED ASSY	USTK254
1998-1997	H4-2.2L	W/ CALIF. EMISSIONS	USTK172A
1998-1997	H4-2.2L	INTERGRATED ASSY.	USTK254A
2001-1999	H4-2.2L	SOHC; MANUAL TRANS.	USTK304
2005-1999	H4-2.5L	SOHC; MANUAL TRANS.	USTK304
2007-2006	H4-2.5L	FROM CHASSIS # 1JY029125	USTK304A
2008-2004	H4-2.5L		USTK328
<b>LEGACY</b>			
1999	H4-2.5L		USTK304
1998-1990	H4-2.2L	W/O CALIF. EMISSIONS	USTK172
1998-1994	H4-2.2L	W/O INTERGRATED ASSY	USTK254
1998-1995	H4-2.2L	W/ CALIF. EMISSIONS	USTK172A
1998-1997	H4-2.2L	W/ CALIF. EMISSIONS; INTERGRATED ASSY.	USTK254A
1999-1998	H4-2.5L		USTK277A
2005-2000	H4-2.5L	SOHC	USTK307
2009-2005	H4-2.5L	DOHC	USTK328
2009-2006	H4-2.5L		USTK307A
<b>OUTBACK</b>			
2005-2000	H4-2.5L		USTK307

Model Years	Engine Liters	Application Description	USMW
2009-2005	H4-2.5L	DOHC	USTK328
2009-2006	H4-2.5L	SOHC	USTK307A
<b>SUBARU</b>			
<b>IMPREZA</b>			
2004-2002	H4-2.0L		USTK328A
<b>SUZUKI</b>			
<b>SWIFT+</b>			
2008-2004	L4-1.6L		USTK335
<b>TOYOTA</b>			
<b>4RUNNER</b>			
1992-1988	V6-3.0L		USTK154
1995-1993	V6-3.0L	W/ OIL COOLER BYPASS	USTK240
1995-1994	V6-3.0L	W/O OIL COOLER BYPASS	USTK240A
2002-1996	V6-3.4L	MANUAL TRANS.	USTK271
2002-1996	V6-3.4L		USTK271A
2009-2003	V8-4.7L		USTK298
<b>CAMRY</b>			
1991-1987	L4-2.0L		USTK199
2001-1992	L4-2.2L		USTK199
1991-1988	V6-2.5L		USTK157
1993-1992	V6-3.0L		USTK200
2004-2002	V6-3.0L		USTK257A
2006-2004	V6-3.3L	UP TO 1EV006005	USTK257A
<b>CELICA</b>			
1989-1987	L4-2.0L		USTK199
1993-1990	L4-1.6L		USTK036
1997-1994	L4-1.8L		USTK235
1999-1990	L4-2.2L		USTK199
<b>COROLLA</b>			
1992-1988	L4-1.6L		USTK036
1997-1993	L4-1.8L		USTK235
<b>HIGHLANDER</b>			
2003-2001	V6-3.0L	TO CHASSIS # 1HV098995	USTK257A
2010-2004	V6-3.3L	TO CHASSIS # 1HV098995	USTK257A
<b>LAND CRUISER</b>			
2007-1998	V8-4.7L	SOHC	USTK298
<b>MR2</b>			
1995-1991	L4-2.2L		USTK199
<b>PICKUP</b>			
1992-1988	V6-3.0L		USTK154
1995-1993	V6-3.0L	W/ OIL COOLER BYPASS	USTK240
1995-1994	V6-3.0L	W/O OIL COOLER BYPASS	USTK240A
<b>RAV4</b>			
2000-1996	L4-2.0L		USTK199
<b>SEQUOIA</b>			
2009-2001	V8-4.7L		USTK298
<b>SIENNA</b>			
2006-2004	V6-3.3L		USTK257A
<b>SOLARA</b>			
2001-1999	L4-2.2L		USTK199
2008-2004	V6-3.3L	INC. HYD. TENSIONER	USTK257A
<b>SUPRA</b>			
1998-1993	L6-3.0L		USTK215
<b>T100</b>			
1994	V6-3.0L	W/O OIL COOLER BYPASS	USTK240A
1994-1993	V6-3.0L	W/ OIL COOLER BYPASS	USTK240
1998-1995	V6-3.4L		USTK271
1998-1995	V6-3.4L		USTK271A
<b>TACOMA</b>			
2004-1995	V6-3.4L	MANUAL TRANS.	USTK271
2004-1995	V6-3.4L	AUTOMATIC TRANS.	USTK271A
<b>TUNDRA</b>			
2008	V6-4.0L		USTK298
2004-2000	V6-3.4L	MANUAL TRANS.	USTK271
2004-2000	V6-3.4L	AUTOMATIC TRANS.	USTK271A
2009-2000	V8-4.7L		USTK298



Model Years	Engine Liters	Application Description	USMW
<b>TOYOTA</b>			
<b>AVALON</b>			
2004-1995	V6-3.0L		USTK257
<b>CAMRY</b>			
2001-1994	V6-3.0L		USTK257
<b>SIENNA</b>			
2003-1998	V6-3.0L		USTK257
<b>SOLARA</b>			
2003-1999	V6-3.0L		USTK257
<b>VOLKSWAGEN</b>			
<b>BEETLE</b>			
2000-1999	L4-1.8L		USTK306B
2003-1999	L4-1.9L		USTK321
2005-1998	L4-2.0L		USTK296
2005-2000	L4-1.8L		USTK306
2006-2004	L4-1.9L		USTK333
<b>CABRIO</b>			
1997-1995	L4-2.0L		USTK262
2002-1996	L4-2.0L	VIN 1HV098995 AND AFTER	USTK262A
<b>EOS</b>			
2008-2007	L4-2.0L		USTK334
<b>GOLF</b>			
2000	L4-1.8L		USTK306B
2010	L4-2.0L		USTK913
1997-1993	L4-2.0L		USTK262
1999-1997	L4-2.0L	VIN 1HV098995 AND AFTER	USTK262A
2004-1999	L4-1.9L	TURBO	USTK321
2006-2000	L4-1.8L	TO CHASSIS # 1JY029124	USTK306
2006-2004	L4-1.9L		USTK333
2007-1999	L4-2.0L		USTK296
<b>GOLF CITY</b>			
2009-2007	L4-2.0L		USTK296
<b>GTI</b>			
2008-2006	L4-2.0L		USTK334
<b>JETTA</b>			
2000	L4-1.8L		USTK306B
1997-1993	L4-2.0L		USTK262
1999-1997	L4-2.0L	VIN 1HV098995 AND AFTER	USTK262A
2004-1999	L4-1.9L	TURBO	USTK321
2005-2000	L4-1.8L	NON TURBO	USTK306
2006-2005	L4-1.9L		USTK333A
2008-2004	L4-1.9L		USTK333
2008-2006	L4-2.0L		USTK334
2009-1999	L4-2.0L		USTK296
2010-2009	L4-2.0L		USTK913
<b>JETTA CITY</b>			
2009-2007	L4-2.0L		USTK296
<b>PASSAT</b>			
2000	L4-1.8L		USTK306
1996-1995	L4-2.0L		USTK262
2005-2001	L4-1.8L		USTK306A
2005-2004	L4-2.0L		USTK333
2008-1998	L4-1.8L		USTK317
2008-2006	L4-2.0L		USTK334
2005-1999	V6-2.8L		USTK297
<b>PHAETON</b>			
2006-2004	V8-4.2L		USTK297A
<b>ROUTAN</b>			
2010-2009	V6-4.0L		USTK295B
<b>TOUAREG</b>			
2006-2004	V8-4.2L		USTK297A
<b>VOLKSWAGON</b>			
<b>POINTER</b>			
2008-1998	L4-1.6L		USTK260

Model Years	Engine Liters	Application Description	USMW
<b>VOLVO</b>			
<b>850</b>			
1997-1994	L5-2.3L	W/ CALIF. EMISSIONS	USTK252
1997-1995	L5-2.4L	W/ CALIF. EMISSIONS	USTK252
<b>960</b>			
1994	L6-2.9L		USTK252A
1997-1995	L6-2.9L	W/O WP BYPASS TUBE	USTK270A
<b>C30</b>			
2008	L5-2.4L		USTK331A
2010-2008	L5-2.5L	BEW ENGINE	USTK331B
2010-2009	L5-2.4L	BEW ENGINE	USTK331B
<b>C70</b>			
1999-1998	L5-2.4L	W/ CALIF. EMISSIONS	USTK252
2000-1998	L5-2.3L	W/O CALIF. EMISSIONS	USTK252
2004-2000	L5-2.3L	MANUAL BELT TENSIONER	USTK331
2004-2000	L5-2.4L	MANUAL BELT TENSIONER	USTK331
2007-2006	L5-2.5L		USTK331A
2010-2008	L5-2.5L	BEW ENGINE	USTK331B
<b>S40</b>			
2004-2000	L5-1.9L	MANUAL BELT TENSIONER	USTK331
2007-2004	L5-2.5L	FROM CHASSIS # 202465	USTK331A
2008-2004	L5-2.4L		USTK331A
2010-2004	L5-2.4L		USTK331B
2010-2008	L5-2.5L	BRM ENGINE	USTK331B
<b>S60</b>			
2004-2001	L5-2.3L	MANUAL BELT TENSIONER	USTK331
2005-2001	L5-2.4L	MANUAL BELT TENSIONER	USTK331
2005-2003	L5-2.5L	MANUAL BELT TENSIONER	USTK331
2007-2005	L5-2.4L		USTK331A
2007-2005	L5-2.5L	FROM CHASSIS # 206722	USTK331A
2009-2008	L5-2.4L		USTK331B
2009-2008	L5-2.5L		USTK331B
1998-1997	L6-2.9L	W/O WP BYPASS TUBE	USTK270A
<b>S70</b>			
2000	L5-2.3L	TO CHASSIS # 206721	USTK331
2000	L5-2.4L	TO CHASSIS # 202464	USTK331
1999-1998	L5-2.4L	W/O CALIF. EMISSIONS	USTK252
2000-1998	L5-2.3L		USTK252
<b>S80</b>			
2005	L5-2.5L		USTK331
2006	L5-2.5L		USTK331A
1999	L6-2.8L	W/O WP BYPASS TUBE	USTK270
2001-2000	L6-2.8L		USTK319
2005-2003	L6-2.9L		USTK319
<b>SC90</b>			
2006	L5-2.5L		USTK331A
<b>V40</b>			
2004-2000	L4-1.9L		USTK331
<b>V50</b>			
2007-2005	L5-2.5L		USTK331A
2008-2005	L5-2.4L		USTK331A
2010-2005	L5-2.4L	BEW ENGINE	USTK331B
2010-2008	L5-2.5L		USTK331B
<b>V70</b>			
2006	L5-2.4L		USTK331A
2007	L5-2.4L		USTK331B
1999-1998	L5-2.4L		USTK252
2000-1998	L5-2.3L		USTK252
2004-2000	L5-2.3L		USTK331
2005-2000	L5-2.4L		USTK331
2005-2003	L5-2.5L		USTK331
2007-2005	L5-2.5L		USTK331A
<b>V90</b>			
1998-1997	L6-2.9L		USTK270A
<b>XC70</b>			
2005-2003	L5-2.5L		USTK331
2007-2006	L5-2.5L		USTK331A

TIMING KITS



# TIMING KIT WITH WATER PUMP APPLICATION GUIDE

**USMW**  
*Professional Series*

Model Years	Engine Liters	Application Description	USMW
<b>XC90</b>			
2005-2003	L5-2.5L		USTK331
2004-2003	L6-2.9L	DOHC	USTK319

Model Years	Engine Liters	Application Description	USMW
-------------	---------------	-------------------------	------

USMW	Years	Cyl.	Specifications	
USTK036	1989	L4-1.6L	GEO PRIZM	
	1992-1988	L4-1.6L	TOYOTA COROLLA	
	1992-1990	L4-1.6L	GEO PRIZM	
	1993-1990	L4-1.6L	TOYOTA CELICA	
USTK077	1997-1984	L4-1.6L	NISSAN TSURU	
USTK104	1994-1985	V6-3.0L	NISSAN MAXIMA	
	1994-1993	V6-3.0L	MERCURY VILLAGER	
	1994-1993	V6-3.0L	NISSAN QUEST	
USTK139	1988	V6-3.0L	MITSUBISHI GALANT	
	1989-1988	V6-3.0L	CHRYSLER NEW YORKER	
	1989-1988	V6-3.0L	PLYMOUTH GRAND VOYAGER	
	1990-1988	V6-3.0L	CHRYSLER DYANSTY	
	1990-1989	V6-3.0L	MITSUBISHI SIGMA	
	1993-1988	V6-3.0L	DODGE DYNASTY	
	1993-1990	V6-3.0L	DODGE DAYTONA	
	1993-1990	V6-3.0L	MITSUBISHI MIGHTY MAX	
	1994-1989	V6-3.0L	MITSUBISHI MONTERO	
	1994-1992	V6-3.0L	DODGE SHADOW	
	1994-1992	V6-3.0L	PLYMOUTH SUNDANCE	
	1995-1989	V6-3.0L	DODGE SPIRIT	
	1995-1989	V6-3.0L	PLYMOUTH ACCLAIM	
	1995-1990	V6-3.0L	CHRYSLER LEBARON	
	1996-1991	V6-3.0L	DODGE STEALTH	
	1996-1992	V6-3.0L	MITSUBISHI DIAMANTE	
	1998-1990	V6-3.0L	HYUNDAI SONATA	
	1999-1997	V6-3.0L	MITSUBISHI 3000GT	
	2000	V6-3.0L	CHRYSLER GRAND CARAVAN	
	2000	V6-3.0L	CHRYSLER VOYAGER	
	2000-1987	V6-3.0L	DODGE CARAVAN	
	2000-1987	V6-3.0L	PLYMOUTH VOYAGER	
	2000-1988	V6-3.0L	DODGE GRAND CARAVAN	
2000-1992	V6-3.0L	PLYMOUTH GRAND VOYAGER		
USTK143	1991-1988	L4-1.5L	HONDA CRX	
	1995-1988	L4-1.5L	HONDA CIVIC	
	1995-1993	L4-1.5L	HONDA CIVIC DEL SOL	
USTK153	1990	L4-2.0L	CHRYSLER DAYTONA	
	1990	L4-2.0L	CHRYSLER LEBARON	
	1990	L4-2.2L	DODGE DAYTONA	
	1990	L4-2.2L	DODGE OMNI	
	1990	L4-2.2L	PLYMOUTH HORIZON	
	1993-1990	L4-2.5L	CHRYSLER DAYTONA	
	1993-1990	L4-2.5L	CHRYSLER LEBARON	
	1993-1990	L4-2.5L	DODGE DYNASTY	
	1994-1990	L4-2.2L	DODGE SHADOW	
	1994-1990	L4-2.5L	DODGE SHADOW	
	1994-1990	L4-2.2L	PLYMOUTH SUNDANCE	
	1994-1990	L4-2.5L	PLYMOUTH SUNDANCE	
	1995-1990	L4-2.5L	DODGE CARAVAN	
	1995-1990	L4-2.5L	DODGE DAKOTA	
	1995-1990	L4-2.5L	DODGE DAYTONA	
	1995-1990	L4-2.5L	DODGE SPIRIT	
	1995-1990	L4-2.5L	PLYMOUTH ACCLAIM	
	1995-1990	L4-2.5L	PLYMOUTH VOYAGER	
	USTK154	1992-1988	V6-3.0L	TOYOTA 4RUNNER
		1992-1988	V6-3.0L	TOYOTA PICKUP
USTK157	1991-1988	V6-2.5L	TOYOTA CAMRY	
	1991-1990	V6-2.5L	LEXUS ES250	
USTK160	1987-1985	L4-2.0L	HONDA PRELUDE	
	1989-1986	L4-2.0L	HONDA ACCORD	
USTK163	1990	L4-2.0L	PONTIAC LEMANS	
	1990	L4-2.0L	PONTIAC OPTIMA	
	1994-1990	L4-2.0L	PONTIAC SUNBIRD	
USTK172	1993	H4-1.8L	SUBARU IMPREZA	
	1997-1995	H4-2.2L	SUBARU IMPREZA	
	1998-1990	H4-2.2L	SUBARU LEGACY	
USTK172A	1998-1995	H4-2.2L	SUBARU LEGACY	
	1998-1997	H4-2.2L	SUBARU IMPREZA	
USTK184	2001-1996	L4-1.8L	ACURA INTEGRA	
	2001-1997	L4-2.0L	HONDA CR-V	

USMW	Years	Cyl.	Specifications	
USTK184A	1995-1990	L4-1.8L	ACURA INTEGRA	
USTK186-187	1996-1992	L4-2.2L	HONDA PRELUDE	
	1997-1990	L4-2.2L	HONDA ACCORD	
	1997-1995	L4-2.2L	HONDA ODYSSEY	
	1997-1996	L4-2.2L	ISUZU OASIS	
	1997-1990	V8-4.0L	LEXUS LS400	
USTK190	1997-1992	V8-4.0L	LEXUS SC400	
	1995-1991	V6-3.2L	ACURA LEGEND	
USTK193A	1998-1996	V6-3.2L	ACURA TL	
USTK194	1996-1991	L4-1.9L	FORD ESCORT	
	1996-1991	L4-1.9L	MERCURY TRACER	
USTK195	1995-1992	V6-3.0L	MITSUBISHI DIAMANTE	
	1996-1991	V6-3.0L	DODGE STEALTH	
	1998-1991	V6-3.0L	MITSUBISHI 3000GT	
USTK199	1989-1987	L4-2.0L	TOYOTA CELICA	
	1991-1987	L4-2.0L	TOYOTA CAMRY	
	1995-1991	L4-2.2L	TOYOTA MR2	
	1999-1990	L4-2.2L	TOYOTA CELICA	
	2000-1996	L4-2.0L	TOYOTA RAV4	
	2001-1992	L4-2.2L	TOYOTA CAMRY	
	2001-1999	L4-2.2L	TOYOTA SOLARA	
USTK200	1993-1992	V6-3.0L	LEXUS ES300	
	1993-1992	V6-3.0L	TOYOTA CAMRY	
USTK201A	2007-2002	L4-2.0L	MITSUBISHI LANCER	
USTK203	2010-1998	L4-1.6L	CHEVROLET CHEVY	
USTK211	1998-1995	L5-2.5L	ACURA TL	
USTK211A	1994-1992	L5-2.5L	ACURA VIGOR	
USTK215	1997-1993	L6-3.0L	LEXUS GS300	
	1998-1993	L6-3.0L	TOYOTA SUPRA	
	2000-1992	L6-3.0L	LEXUS SC300	
	2005-1998	L6-3.0L	LEXUS GS300	
USTK215A	2005-2001	L6-3.0L	LEXUS IS300	
	1996-1992	L4-2.3L	HONDA PRELUDE	
USTK218	1995	V6-2.8L	AUDI 90	
	1995	V6-2.8L	AUDI 90 QUATTRO	
USTK218A	1997-1996	V6-2.8L	AUDI A4	
	1997-1996	V6-2.8L	AUDI A4 QUATTRO	
	1998-1995	V6-2.8L	AUDI A6	
	1998-1995	V6-2.8L	AUDI A6 QUATTRO	
	1998-1995	V6-2.8L	AUDI CABRIOLET	
	1995	V6-2.8L	AUDI 90 QUATTRO	
	1994-1992	V6-2.8L	AUDI 100	
	1995-1993	V6-2.8L	AUDI 90	
USTK219	1995-1994	V6-2.8L	AUDI CABRIOLET	
	1994	V6-3.5L	CHRYSLER LHS	
	1994	V6-3.5L	CHRYSLER NEW YORKER	
	1994-1993	V6-3.5L	CHRYSLER CONCORDE	
	1994-1993	V6-3.5L	CHRYSLER INTREPID	
	1994-1993	V6-3.5L	DODGE INTREPID	
	1994-1993	V6-3.5L	EAGLE VISION	
	USTK221A	1997-1992	V6-3.2L	ISUZU TROOPER
		1997-1993	V6-3.2L	ISUZU RODEO
		1997-1994	V6-3.2L	HONDA PASSPORT
USTK223	1997-1996	V6-3.2L	ACURA SLX	
	1997-1996	V6-3.2L	ACURA SLX	
USTK224	1995-1992	L4-1.5L	HONDA CIVIC	
	1995-1993	L4-1.6L	HONDA CIVIC DEL SOL	
USTK224A	1997-1996	L4-1.6L	HONDA CIVIC DEL SOL	
	2000-1996	L4-1.6L	HONDA CIVIC	
USTK226-186	2001-1993	L4-2.2L	HONDA PRELUDE	
	1993-1992	L4-1.7L	ACURA INTEGRA	
USTK227	1995-1994	L4-1.6L	HONDA CIVIC DEL SOL	
	1997-1996	L4-1.6L	HONDA CIVIC DEL SOL	
USTK227A	2000-1999	L4-1.6L	HONDA CIVIC	
	1997-1993	L4-2.0L	FORD PROBE	
USTK228	1997-1993	L4-2.0L	MAZDA MX-6	
	1997-1993	L4-2.0L	MAZDA PROT G	
	2001-1993	L4-2.0L	MAZDA 626	
	2003-2002	L4-2.0L	MAZDA PROT G 5	

TIMING KITS



# TIMING KIT WITH WATER PUMP BUYER'S GUIDE

**USMW**  
Professional Series

USMW	Years	Cyl.	Specifications
USTK235	1997-1993	L4-1.8L	GEN PRIZM
	1997-1993	L4-1.8L	TOYOTA COROLLA
	1997-1994	L4-1.8L	TOYOTA CELICA
USTK240	1994-1993	V6-3.0L	TOYOTA T100
	1995-1993	V6-3.0L	TOYOTA 4RUNNER
	1995-1993	V6-3.0L	TOYOTA PICKUP
USTK240A	1994	V6-3.0L	TOYOTA T100
	1995-1994	V6-3.0L	TOYOTA 4RUNNER
	1995-1994	V6-3.0L	TOYOTA PICKUP
USTK244-186	1997	L4-2.2L	ACURA CL
	1998	L4-2.3L	HONDA ODYSSEY
	1997-1994	L4-2.2L	HONDA ACCORD
	1999-1998	L4-2.3L	ACURA CL
	1999-1998	L4-2.3L	ISUZU OASIS
	2002-1998	L4-2.3L	HONDA ACCORD
	2000-1995	L4-2.0L	DODGE STRATUS
USTK245	2000-1996	L4-2.0L	PLYMOUTH BREEZE
	2001-1995	L4-2.0L	PLYMOUTH NEON
	2005-1995	L4-2.0L	DODGE NEON
USTK245C	2000-1995	L4-2.0L	DODGE STRATUS
	2000-1996	L4-2.0L	PLYMOUTH BREEZE
	2001-1995	L4-2.0L	PLYMOUTH NEON
	2005-1995	L4-2.0L	DODGE NEON
USTK246	1997-1995	L4-2.0L	CHRYSLER NEON
	1999-1995	L4-2.0L	CHRYSLER SEBRING
	1999-1995	L4-2.0L	DODGE AVENGER
	1999-1995	L4-2.0L	DODGE NEON
	1999-1995	L4-2.0L	PLYMOUTH NEON
USTK246A	1997-1995	L4-2.0L	CHRYSLER NEON
	1998-1995	L4-2.0L	EAGLE TALON
	1999-1995	L4-2.0L	CHRYSLER SEBRING
	1999-1995	L4-2.0L	DODGE AVENGER
	1999-1995	L4-2.0L	DODGE NEON
	1999-1995	L4-2.0L	MITSUBISHI ECLIPSE
	1999-1995	L4-2.0L	PLYMOUTH NEON
USTK247	2001-1994	L4-1.8L	ACURA INTEGRA
USTK249	2000-1996	V6-3.3L	NISSAN PATHFINDER
	2000-1997	V6-3.3L	INFINITI QX4
	2004-1999	V6-3.3L	NISSAN FRONTIER
	2004-2000	V6-3.3L	NISSAN XTERRA
USTK252	1997-1994	L5-2.3L	VOLVO 850
	1997-1995	L5-2.4L	VOLVO 850
	1999-1998	L5-2.4L	VOLVO C70
	1999-1998	L5-2.4L	VOLVO S70
	1999-1998	L5-2.4L	VOLVO V70
	2000-1998	L5-2.3L	VOLVO C70
	2000-1998	L5-2.3L	VOLVO S70
	2000-1998	L5-2.3L	VOLVO V70
USTK252A	1994	L6-2.9L	VOLVO 960
USTK254	1997-1993	H4-1.8L	SUBARU IMPREZA
	1997-1995	H4-2.2L	SUBARU IMPREZA
	1998-1994	H4-2.2L	SUBARU LEGACY
USTK254A	1998-1997	H4-2.2L	SUBARU IMPREZA
	1998-1997	H4-2.2L	SUBARU LEGACY
USTK255	1997	V6-3.5L	PLYMOUTH PROWLER
	1996-1995	V6-3.5L	CHRYSLER NEW YORKER
	1997-1995	V6-3.5L	CHRYSLER CONCORDE
	1997-1995	V6-3.5L	CHRYSLER INTREPID
	1997-1995	V6-3.5L	CHRYSLER LHS
	1997-1995	V6-3.5L	DODGE INTREPID
	1997-1995	V6-3.5L	EAGLE VISION
USTK257	2001-1994	V6-3.0L	LEXUS ES300
	2001-1994	V6-3.0L	TOYOTA CAMRY
	2003-1998	V6-3.0L	TOYOTA SIENNA
	2003-1999	V6-3.0L	LEXUS RX300
	2003-1999	V6-3.0L	TOYOTA SOLARA
USTK257A	2004-1995	V6-3.0L	TOYOTA AVALON
	2003-2001	V6-3.0L	TOYOTA HIGHLANDER
2003-2002	V6-3.0L	LEXUS ES300	

USMW	Years	Cyl.	Specifications
USTK259	2004-2002	V6-3.0L	TOYOTA CAMRY
	2006-2004	V6-3.3L	LEXUS ES300
	2006-2004	V6-3.3L	LEXUS RX330
	2006-2004	V6-3.3L	TOYOTA CAMRY
	2006-2004	V6-3.3L	TOYOTA SIENNA
	2008-2004	V6-3.3L	TOYOTA SOLARA
	2008-2006	V6-3.3L	LEXUS RX400H
	2010-2004	V6-3.3L	TOYOTA HIGHLANDER
	2003-1997	V6-3.0L	MITSUBISHI MONTERO SPORT
	2003-1999	V6-3.0L	MITSUBISHI GALANT
USTK260	2004-2001	V6-3.0L	DODGE STRATUS
	2005-2001	V6-3.0L	CHRYSLER SEBRING
USTK262	2008-1998	L4-1.6L	VOLKSWAGON POINTER
USTK262	1996-1995	L4-2.0L	VOLKSWAGEN PASSAT
	1997-1993	L4-2.0L	VOLKSWAGEN GOLF
	1997-1993	L4-2.0L	VOLKSWAGEN JETTA
USTK262A	1997-1995	L4-2.0L	VOLKSWAGEN CABRIO
	1999-1997	L4-2.0L	VOLKSWAGEN GOLF
USTK263	1999-1997	L4-2.0L	VOLKSWAGEN JETTA
	2002-1996	L4-2.0L	VOLKSWAGEN CABRIO
USTK265A	1997-1995	V6-2.7L	HONDA ACCORD
USTK265B	2003	L4-2.4L	CHRYSLER VOYAGER
	2005-2002	L4-2.4L	JEEP LIBERTY
	2005-2003	L4-2.4L	DODGE NEON
	2006-2003	L4-2.4L	CHRYSLER SEBRING
	2006-2003	L4-2.4L	DODGE STRATUS
	2006-2003	L4-2.4L	JEEP TJ
	2006-2003	L4-2.4L	JEEP WRANGLER
	2009-2003	L4-2.4L	CHRYSLER PT CRUISER
	2000	L4-2.4L	CHRYSLER CIRRUS
	2002	L4-2.4L	JEEP LIBERTY
USTK270	2000-1997	L4-2.4L	PLYMOUTH BREEZE
	2000-1998	L4-2.4L	PLYMOUTH VOYAGER
	2002-1998	L4-2.4L	CHRYSLER SEBRING
	2002-1998	L4-2.4L	DODGE CARAVAN
	2002-1998	L4-2.4L	DODGE STRATUS
	2002-2000	L4-2.4L	CHRYSLER VOYAGER
	2002-2001	L4-2.4L	CHRYSLER PT CRUISER
	1999	L6-2.8L	VOLVO S80
USTK270A	1998-1997	L6-2.9L	VOLVO S60
	1998-1997	L6-2.9L	VOLVO V90
	19997-1995	L6-2.9L	VOLVO 960
USTK271	1998-1995	V6-3.4L	TOYOTA T100
	2002-1996	V6-3.4L	TOYOTA 4RUNNER
	2004-1995	V6-3.4L	TOYOTA TACOMA
	2004-2000	V6-3.4L	TOYOTA TUNDRA
USTK271A	1998-1995	V6-3.4L	TOYOTA T100
	2002-1996	V6-3.4L	TOYOTA 4RUNNER
	2004-1995	V6-3.4L	TOYOTA TACOMA
	2004-2000	V6-3.4L	TOYOTA TUNDRA
USTK276	1997-1995	L4-2.3L	FORD RANGER
	1997-1995	L4-2.3L	MAZDA B2300
	2001-1998	L4-2.5L	FORD RANGER
USTK277A	2001-1998	L4-2.5L	MAZDA B2500
	1998	H4-2.5L	SUBARU FORESTER
USTK279-280	1998	H4-2.5L	SUBARU IMPREZA
	1999-1998	H4-2.5L	SUBARU LEGACY
	2004-1996	V6-3.5L	ACURA RL
USTK281	2002-1995	L4-2.0L	KIA SPORTAGE
USTK283	1999-1997	L4-2.0L	MERCURY TRACER
	2002-1997	L4-2.0L	FORD ESCORT
USTK283A	2003-2000	L4-2.0L	FORD FOCUS
USTK284	1997	L4-1.8L	HYUNDAI TIBURON
	1997	L4-2.0L	HYUNDAI TIBURON
	2005	L4-2.0L	HYUNDAI TUCSON
	2005	L4-2.0L	KIA SPORTAGE
	2001-1998	L4-2.0L	HYUNDAI TIBURON
	2005-1999	L4-2.0L	HYUNDAI ELANTRA
	2005-2003	L4-2.0L	HYUNDAI TIBURON



USMW	Years	Cyl.	Specifications	
USTK286	2007-2004	L4-2.0L	KIA SPECTRA	
	2007-2005	L4-2.0L	KIA SPECTRA5	
	2002-2001	V6-3.5L	ACURA MDX	
	2003-2000	V6-3.2L	ACURA TL	
	2003-2001	V6-3.2L	ACURA CL	
	2004-2000	V6-3.5L	HONDA ODYSSEY	
USTK286A	2004-2003	V6-3.5L	HONDA PILOT	
	1999	V6-3.2L	ACURA TL	
	1999	V6-3.5L	HONDA ODYSSEY	
	1999-1997	V6-3.0L	ACURA CL	
USTK287	2002-1998	V6-3.0L	HONDA ACCORD	
	2000-1997	V6-3.5L	MITSUBISHI MONTERO	
	2004-1997	V6-3.5L	MITSUBISHI DIAMANTE	
	2004-1999	V6-3.5L	MITSUBISHI MONTERO SPORT	
	2009-2004	V6-3.8L	MITSUBISHI GALANT	
USTK294A	2010-2004	V6-3.8L	MITSUBISHI ENDEAVOR	
	2010-2006	V6-3.8L	MITSUBISHI ECLIPSE	
	2000	L4-2.0L	FORD CONTOUR	
	2000	L4-2.0L	MERCURY MYSTIQUE	
	2001-2000	L4-2.0L	FORD ESCORT	
	2002-2000	L4-2.0L	MERCURY COUGAR	
USTK295	2004-2000	L4-2.0L	FORD FOCUS	
	2004-2002	L4-2.0L	FORD FOCUS	
USTK295	2002	V6-3.5L	CHRYSLER CONCORDE	
	2001-1998	V6-3.2L	CHRYSLER CONCORDE	
	2001-1998	V6-3.2L	CHRYSLER INTREPID	
	2001-1998	V6-3.2L	DODGE INTREPID	
	2001-1999	V6-3.5L	CHRYSLER LHS	
	2002-1998	V6-3.5L	CHRYSLER 300M	
	2002-2000	V6-3.5L	CHRYSLER INTREPID	
	2002-2001	V6-3.5L	DODGE INTREPID	
	USTK295A	2004	V6-3.5L	CHRYSLER PACIFICA
		2004-2003	V6-3.5L	CHRYSLER 300M
2004-2003		V6-3.5L	CHRYSLER CONCORDE	
2004-2003		V6-3.5L	DODGE INTREPID	
USTK295B	2006-2005	V6-3.5L	CHRYSLER PACIFICA	
	2008-2005	V6-3.5L	DODGE MAGNUM	
	2008-2007	V6-4.0L	CHRYSLER PACIFICA	
	2010-2005	V6-3.5L	CHRYSLER 300	
	2010-2006	V6-3.5L	DODGE CHARGER	
	2010-2007	V6-3.5L	CHRYSLER SEBRING	
	2010-2008	V6-4.0L	CHRYSLER TOWN AND COUNTRY	
	2010-2008	V6-3.5L	DODGE AVENGER	
	2010-2008	V6-4.0L	DODGE GRAND CARAVAN	
	2010-2009	V6-3.5L	DODGE CHALLENGER	
	2010-2009	V6-3.5L	DODGE JOURNEY	
	2010-2009	V6-4.0L	DODGE NITRO	
	2010-2009	V6-4.0L	VOLKSWAGEN ROUTAN	
	USTK296	2005-1998	L4-2.0L	VOLKSWAGEN BEETLE
2007-1999		L4-2.0L	VOLKSWAGEN GOLF	
2009-1999		L4-2.0L	VOLKSWAGEN JETTA	
2009-2007		L4-2.0L	VOLKSWAGEN GOLF CITY	
2009-2007		L4-2.0L	VOLKSWAGEN JETTA CITY	
USTK297	2001-1997	V6-2.8L	AUDI A4	
	2001-1997	V6-2.8L	AUDI A4 QUATTRO	
	2001-1998	V6-2.8L	AUDI A6	
	2001-1998	V6-2.8L	AUDI A6 QUATTRO	
	2005-1999	V6-2.8L	VOLKSWAGEN PASSAT	
USTK297A	2003-2001	V8-4.2L	AUDI S8	
	2003-2002	V8-4.2L	AUDI S6	
	2004-2001	V8-4.2L	AUDI A6 QUATTRO	
	2004-2003	V8-4.2L	AUDI RS6	
	2006-2001	V8-4.2L	AUDI A8 QUATTRO	
	2006-2004	V8-4.2L	VOLKSWAGEN PHAETON	
USTK297B	2006-2004	V8-4.2L	VOLKSWAGEN TOUAREG	
	2002-2000	V6-2.7L	AUDI S4	
	2004-2000	V6-2.7L	AUDI A6 QUATTRO	
USTK297C	2005-2001	V6-2.7L	AUDI ALLROAD QUATTRO	
	2000	V8-4.2L	AUDI A6 QUATTRO	

USMW	Years	Cyl.	Specifications
USTK298	2008	V6-4.0L	TOYOTA TUNDRA
	2000-1998	V8-4.0L	LEXUS GS400
	2000-1998	V8-4.0L	LEXUS LS400
	2000-1998	V8-4.0L	LEXUS SC400
	2006-2001	V8-4.3L	LEXUS LS430
	2007-1998	V8-4.7L	LEXUS LX470
	2007-1998	V8-4.7L	TOYOTA LAND CRUISER
	2007-2001	V8-4.3L	LEXUS GS430
	2009-2000	V8-4.7L	TOYOTA TUNDRA
	2009-2001	V8-4.7L	TOYOTA SEQUOIA
	2009-2003	V8-4.7L	LEXUS GX470
	2009-2003	V8-4.7L	TOYOTA 4RUNNER
	2010-2002	V8-4.3L	LEXUS SC430
	USTK303	1999-1998	V6-3.5L
2000-1998		V6-3.2L	ISUZU AMIGO
2001-1999		V6-3.5L	ISUZU VEHICROSS
2002-1998		V6-3.2L	HONDA PASSPORT
2002-1998		V6-3.5L	ISUZU TROOPER
2003-2001		V6-3.2L	ISUZU RODEO SPORT
2003-2002		V6-3.5L	ISUZU AXIOM
USTK304	2004-1998	V6-3.2L	ISUZU RODEO
	1999	H4-2.5L	SUBARU LEGACY
	2001-1999	H4-2.2L	SUBARU IMPREZA
	2005-1999	H4-2.5L	SUBARU FORESTER
	2005-1999	H4-2.5L	SUBARU IMPREZA
USTK304A	2006-2005	H4-2.5L	SAAB 9-2X
	2005-2003	H4-2.5L	SUBARU FORESTER
USTK304B	2007-2006	H4-2.5L	SUBARU IMPREZA
	2006	H4-2.5L	SUBARU FORESTER
USTK304C	2008	H4-2.5L	SUBARU IMPREZA
USTK305	2010-2006	H4-2.5L	SUBARU FORESTER
USTK306	2002-1999	L4-2.2L	DAEWOO LEGANZA
	2000	L4-1.8L	VOLKSWAGEN PASSAT
	2001	L4-1.8L	AUDI A4
	2001	L4-1.8L	AUDI A4 QUATTRO
	2005-2000	L4-1.8L	VOLKSWAGEN BEETLE
	2005-2000	L4-1.8L	VOLKSWAGEN JETTA
	2006-2000	L4-1.8L	VOLKSWAGEN GOLF
	2006-2001	L4-1.8L	AUDI TT
	2006-2001	L4-1.8L	AUDI TT QUATTRO
	USTK306A	2005-2001	L4-1.8L
2005-2001		L4-1.8L	VOLKSWAGEN PASSAT
2006-2001		L4-1.8L	AUDI A4
USTK306B	2000	L4-1.8L	AUDI TT
	2000	L4-1.8L	AUDI TT QUATTRO
	2000	L4-1.8L	VOLKSWAGEN GOLF
	2000	L4-1.8L	VOLKSWAGEN JETTA
	2000-1999	L4-1.8L	VOLKSWAGEN BEETLE
USTK307	2005-2000	H4-2.5L	SUBARU LEGACY
	2005-2000	H4-2.5L	SUBARU OUTBACK
	2006-2003	H4-2.5L	SUBARU BAJA
USTK307A	2009-2006	H4-2.5L	SUBARU LEGACY
	2009-2006	H4-2.5L	SUBARU OUTBACK
USTK309	2002-1999	L4-2.0L	DAEWOO NUBIRA
	2007-2004	L4-2.0L	CHEVROLET OPTRA
USTK312	2005-2001	L4-1.7L	HONDA CIVIC
USTK315	2001	V6-2.5L	KIA MAGENTIS
	2001	V6-2.5L	KIA OPTIMA
	2001-1999	V6-2.5L	HYUNDAI SONATA
	2005-2002	V6-2.7L	HYUNDAI SONATA
	2006-2001	V6-2.7L	HYUNDAI SANTA FE
	2006-2002	V6-2.7L	KIA MAGENTIS
	2006-2002	V6-2.7L	KIA OPTIMA
	2008-2003	V6-2.7L	HYUNDAI TIBURON
	2009-2005	V6-2.7L	HYUNDAI TUCSON
	2010-2005	V6-2.7L	KIA SPORTAGE
USTK317	2000-1997	L4-1.8L	AUDI A4
	2000-1997	L4-1.8L	AUDI A4 QUATTRO
	2008-1998	L4-1.8L	VOLKSWAGEN PASSAT

TIMING KITS



# TIMING KIT WITH WATER PUMP BUYER'S GUIDE

**USMW**  
Professional Series

USMW	Years	Cyl.	Specifications	
USTK319	2001-2000	L6-2.8L	VOLVO S80	
	2004-2003	L6-2.9L	VOLVO XC90	
	2005-2003	L6-2.9L	VOLVO S80	
USTK321	2003-1999	L4-1.9L	VOLKSWAGEN BEETLE	
	2004-1999	L4-1.9L	VOLKSWAGEN GOLF	
	2004-1999	L4-1.9L	VOLKSWAGEN JETTA	
USTK323	2005-2002	V6-3.5L	HYUNDAI XG350	
	2005-2002	V6-3.5L	KIA SEDONA	
	2006-2003	V6-3.5L	HYUNDAI SANTA FE	
	2006-2004	V6-3.5L	KIA AMANTI	
USTK323A	2006-2003	V6-3.5L	KIA SORENTO	
USTK328	2005	H4-2.0L	SAAB 9-2X	
	2005	H4-2.0L	SUBARU IMPREZA	
	2006	H4-2.5L	SAAB 9-2X	
	2006-2004	H4-2.5L	SUBARU BAJA	
	2008-2004	H4-2.5L	SUBARU FORESTER	
	2008-2004	H4-2.5L	SUBARU IMPREZA	
	2009-2005	H4-2.5L	SUBARU LEGACY	
	2009-2005	H4-2.5L	SUBARU OUTBACK	
	2004-2002	H4-2.0L	SUBARU IMPREZA	
USTK328A	2010	V6-3.7L	ACURA ZDX	
	2006-2003	V6-3.5L	ACURA MDX	
	2007-2003	V6-3.0L	HONDA ACCORD	
	2007-2004	V6-3.5L	SATURN VUE	
	2008-2004	V6-3.2L	ACURA TL	
	2008-2005	V6-3.5L	ACURA RL	
	2010-2005	V6-3.5L	HONDA ODYSSEY	
	2010-2005	V6-3.5L	HONDA PILOT	
	2010-2006	V6-3.5L	HONDA RIDGELINE	
	2010-2007	V6-3.7L	ACURA MDX	
	2011-2007	V6-3.5L	ACURA TL	
	2011-2008	V6-3.5L	HONDA ACCORD	
	2011-2009	V6-3.7L	ACURA TL	
	2011-2010	V6-3.5L	HONDA ACCORD CROSSTOUR	
	USTK330	2004-2002	V6-3.0L	AUDI A4 QUATTRO
2004-2002		V6-3.0L	AUDI A6	
2004-2002		V6-3.0L	AUDI A6 QUATTRO	
2005-2002		V6-3.0L	AUDI A4	
USTK331	2000	L5-2.3L	VOLVO S70	
	2000	L5-2.4L	VOLVO S70	
	2005	L5-2.5L	VOLVO S80	
	2004-2000	L4-1.9L	VOLVO V40	
	2004-2000	L5-2.3L	VOLVO C70	
	2004-2000	L5-2.4L	VOLVO C70	
	2004-2000	L5-1.9L	VOLVO S40	
	2004-2000	L5-2.3L	VOLVO V70	
	2004-2001	L5-2.3L	VOLVO S60	
	2005-2000	L5-2.4L	VOLVO V70	
	2005-2001	L5-2.4L	VOLVO S60	
	2005-2003	L5-2.5L	VOLVO S60	
	2005-2003	L5-2.5L	VOLVO V70	
	2005-2003	L5-2.5L	VOLVO XC70	
	2005-2003	L5-2.5L	VOLVO XC90	
USTK331A	2006	L5-2.5L	VOLVO S80	
	2006	L5-2.5L	VOLVO SC90	
	2006	L5-2.4L	VOLVO V70	
	2008	L5-2.4L	VOLVO C30	
	2007-2004	L5-2.5L	VOLVO S40	
	2007-2005	L5-2.4L	VOLVO S60	
	2007-2005	L5-2.5L	VOLVO S60	
	2007-2005	L5-2.5L	VOLVO V50	
	2007-2005	L5-2.5L	VOLVO V70	
	2007-2006	L5-2.5L	VOLVO C70	
	2007-2006	L5-2.5L	VOLVO XC70	
	2008-2004	L5-2.4L	VOLVO S40	
	2008-2005	L5-2.4L	VOLVO V50	
	USTK331B	2007	L5-2.4L	VOLVO V70
		2009-2008	L5-2.4L	VOLVO S60
2009-2008		L5-2.5L	VOLVO S60	

USMW	Years	Cyl.	Specifications
USTK333	2010-2004	L5-2.4L	VOLVO S40
	2010-2005	L5-2.4L	VOLVO V50
	2010-2008	L5-2.5L	VOLVO C30
	2010-2008	L5-2.5L	VOLVO C70
	2010-2008	L5-2.5L	VOLVO S40
	2010-2008	L5-2.5L	VOLVO V50
	2010-2009	L5-2.4L	VOLVO C30
	2005-2004	L4-2.0L	VOLKSWAGEN PASSAT
	2006-2004	L4-1.9L	VOLKSWAGEN BEETLE
USTK333A	2006-2004	L4-1.9L	VOLKSWAGEN GOLF
	2008-2004	L4-1.9L	VOLKSWAGEN JETTA
USTK333A	2006-2005	L4-1.9L	VOLKSWAGEN JETTA
	2008	L4-2.0L	AUDI TT
USTK334	2008-2005	L4-2.0L	AUDI A4
	2008-2005	L4-2.0L	AUDI A4 QUATTRO
	2008-2006	L4-2.0L	AUDI A3
	2008-2006	L4-2.0L	VOLKSWAGEN GTI
	2008-2006	L4-2.0L	VOLKSWAGEN JETTA
	2008-2006	L4-2.0L	VOLKSWAGEN PASSAT
	2008-2006	L4-2.0L	VOLKSWAGEN EOS
	2008-2007	L4-2.0L	VOLKSWAGEN EOS
USTK335	2008-2004	L4-1.6L	CHEVROLET AVEO
	2008-2004	L4-1.6L	SUZUKI SWIFT+
	2008-2005	L4-1.6L	PONTIAC WAVE
	2008-2007	L4-1.6L	CHEVROLET AVEO5
	2008-2007	L4-1.6L	PONTIAC G3
USTK913	2010	L4-2.0L	AUDI A3
	2010	L4-2.0L	VOLKSWAGEN GOLF
	2010-2009	L4-2.0L	VOLKSWAGEN JETTA
USTK1095	2010-2002	L4-1.6L	NISSAN PLATINA
	2010-2003	L4-1.6L	RENAULT CLIO
	2010-2003	L4-1.6L	RENAULT KANGOO
	2010-2008	L4-1.6L	NISSAN APRIO

<b>AIRTEX</b>	
AWK1220	USTK199
AWK1221	USTK257
AWK1222	USTK186-187
AWK1223	USTK286
AWK1224	USTK271
AWK1225	USTK139
AWK1226	USTK312
AWK1227	USTK244-186
AWK1228	USTK224A
AWK1229	USTK257A
AWK1230	USTK329
AWK1231	USTK298
AWK1232	USTK259
AWK1233	USTK284
AWK1234	USTK143
AWK1235	USTK249
AWK1236	USTK283
AWK1237	USTK194
AWK1238	USTK228
AWK1239	USTK296
AWK1240	USTK331
AWK1241	USTK294A
AWK1242	USTK276
AWK1243	USTK153
AWK1244	USTK295
AWK1245	USTK036
AWK1246	USTK184
AWK1247	USTK235
AWK1248	USTK265A
AWK1249	USTK160
AWK1250	USTK283A
AWK1251	USTK104
AWK1252	USTK307
AWK1253	USTK245
AWK1254	USTK172
AWK1255	USTK223
AWK1256	USTK227
AWK1257	USTK195

<b>ASC</b>	
WPK0001	USTK199
WPK0002	USTK257
WPK0003	USTK186-187
WPK0004	USTK286
WPK0005	USTK271
WPK0006	USTK139
WPK0008	USTK312
WPK0009	USTK244-186
WPK0011	USTK224A
WPK0012	USTK257A
WPK0013	USTK329
WPK0014	USTK298
WPK0017	USTK259
WPK0018	USTK284
WPK0019	USTK143
WPK0020	USTK249
WPK0021	USTK283
WPK0022	USTK194
WPK0024	USTK228
WPK0025	USTK296
WPK0026	USTK331
WPK0027	USTK294A
WPK0028	USTK276
WPK0029	USTK153
WPK0030	USTK295
WPK0031	USTK036
WPK0032	USTK184
WPK0033	USTK235

WPK0034	USTK265A
WPK0035	USTK160
WPK0036	USTK283A
WPK0037	USTK104
WPK0038	USTK307
WPK0039	USTK245
WPK0040	USTK172
WPK0081	USTK223
WPK0127	USTK227
WPK0148	USTK195

<b>CRP</b>	
TB139LK1	USTK139
TB143LK1	USTK143
TB154LK1	USTK154
TB157LK1	USTK157
TB163LK1	USTK163
TB172LK1	USTK172
TB172LK2	USTK172A
TB184LK1	USTK184
TB184LK2	USTK184A
TB186-187LK1	USTK186-187
TB190LK1	USTK190
TB193LK1	USTK193
TB193LK2	USTK193A
TB194LK1	USTK194
TB195LK1	USTK195
TB199LK1	USTK199
TB199LK1-WH	USTK199
TB200LK1	USTK200
TB201LK2	USTK201A
TB211LK1	USTK211
TB211LK2	USTK211A
TB215LK1	USTK215
TB215LK2	USTK215A
TB216-186LK1	USTK216-186
TB218LK1-MI	USTK218
TB219LK1	USTK219
TB221LK2	USTK221A
TB224LK1	USTK224
TB224LK2	USTK224A
TB226-186LK1	USTK226-186
TB227LK1	USTK227
TB227LK2	USTK227A
TB240LK1	USTK240
TB240LK2	USTK240A
TB244-186LK1	USTK244-186
TB245LK1	USTK245
TB246LK1	USTK246
TB247LK1	USTK247
TB252LK1	USTK252
TB252LK2	USTK252A
TB254LK1	USTK254
TB254LK2	USTK254A
TB255LK1	USTK255
TB257LK1	USTK257
TB257LK2	USTK257A
TB259LK1	USTK259
TB262LK1	USTK262
TB262LK1-WH	USTK262
TB262LK2	USTK262A
TB263LK1	USTK263
TB265LK2	USTK265A
TB265LK3	USTK265B
TB271LK1	USTK271
TB271LK2	USTK271A
TB277LK2	USTK277A
TB279-280LK1	USTK279-280
TB281LK1	USTK281

TB283LK1	USTK283
TB283LK2	USTK283A
TB286LK1	USTK286
TB286LK2	USTK286A
TB287LK1	USTK287
TB287LK1-WH	USTK287
TB295LK1	USTK295
TB295LK2	USTK295A
TB295LK3	USTK295B
TB296LK1	USTK296
TB296LK1-MI	USTK296
TB297LK1	USTK297
TB297LK1-MI	USTK297
TB297LK2	USTK297A
TB297LK3	USTK297B
TB298LK1	USTK298
TB303LK1	USTK303
TB304LK1	USTK304
TB304LK2	USTK304A
TB304LK3	USTK304B
TB305LK1	USTK305
TB306LK1	USTK306
TB306LK2	USTK306A
TB306LK2-MI	USTK306A
TB306LK3	USTK306B
TB306LK3-MI	USTK306B
TB307LK1	USTK307
TB307LK2	USTK307A
TB312LK1	USTK312
TB315LK1	USTK315
TB317LK1	USTK317
TB321LK1	USTK321
TB321LK1-MI	USTK321
TB323LK1	USTK323
TB328LK1	USTK328
TB328LK2	USTK328A
TB329LK1	USTK329
TB330LK1	USTK330
TB331LK1	USTK331
TB331LK2	USTK331A
TB333LK1	USTK333
TB333LK2	USTK333A
TB333LK2-MI	USTK333A
TB334LK1	USTK334
TB335LK1	USTK335

<b>GATES</b>	
TCKWP077	USTK077
TCKWP1095	USTK1095
TCKWP139	USTK139
TCKWP143	USTK143
TCKWP154	USTK154
TCKWP157	USTK157
TCKWP163	USTK163
TCKWP172	USTK172
TCKWP184	USTK184
TCKWP184A	USTK184A
TCKWP186	USTK186-187
TCKWP190	USTK190
TCKWP193	USTK193
TCKWP193A	USTK193A
TCKWP194	USTK194
TCKWP195	USTK195
TCKWP199	USTK199
TCKWP199BH	USTK199
TCKWP200	USTK200
TCKWP201A	USTK201A
TCKWP203	USTK203
TCKWP211	USTK211



# TIMING BELT KIT COMPETITIVE CROSS REFERENCE



TCKWP211A	USTK211A	TCKWP331	USTK331
TCKWP215	USTK215	TCKWP335	USTK335
TCKWP215A	USTK215A		
TCKWP216	USTK216-186		
TCKWP219	USTK219		
TCKWP221	USTK221A		
TCKWP224	USTK224		
TCKWP224A	USTK224A		
TCKWP226	USTK226-186		
TCKWP227	USTK227		
TCKWP240	USTK240		
TCKWP240B	USTK240A		
TCKWP244	USTK244-186		
TCKWP245A	USTK245		
TCKWP245A	USTK245A		
TCKWP245B	USTK245B		
TCKWP246	USTK246		
TCKWP246A	USTK246A		
TCKWP247	USTK247		
TCKWP254	USTK254		
TCKWP254A	USTK254A		
TCKWP255	USTK255		
TCKWP257	USTK257		
TCKWP257A	USTK257A		
TCKWP259A	USTK259		
TCKWP259A	USTK259A		
TCKWP260	USTK260		
TCKWP262	USTK262		
TCKWP263	USTK263		
TCKWP265	USTK265		
TCKWP265A	USTK265A		
TCKWP265B	USTK265B		
TCKWP265C	USTK265C		
TCKWP271	USTK271		
TCKWP271A	USTK271A		
TCKWP277A	USTK277A		
TCKWP279	USTK279-280		
TCKWP281	USTK281		
TCKWP283	USTK283A		
TCKWP283A	USTK283		
TCKWP286	USTK286		
TCKWP286A	USTK286A		
TCKWP287	USTK287		
TCKWP295	USTK295		
TCKWP295A	USTK295A		
TCKWP295B	USTK295B		
TCKWP296	USTK296		
TCKWP296M	USTK296		
TCKWP297	USTK297		
TCKWP297A	USTK297B		
TCKWP298	USTK298		
TCKWP303	USTK303		
TCKWP304	USTK304		
TCKWP304A	USTK304A		
TCKWP306	USTK306		
TCKWP306A	USTK306A		
TCKWP306AM	USTK306A		
TCKWP307	USTK307		
TCKWP307A	USTK307A		
TCKWP312	USTK312		
TCKWP315	USTK315		
TCKWP317	USTK317		
TCKWP321	USTK321		
TCKWP321M	USTK321		
TCKWP323	USTK323		
TCKWP328	USTK328		
TCKWP328A	USTK328A		
TCKWP329	USTK329		



Kit #	Water Pump	Belt 1	Belt 2	Tensioner 1	Tensioner 2	Tensioner 3	Tensioner 4	Tensioner 5
USTK036								
USTK077								
USTK104								
USTK1095								
USTK139								
USTK143								
USTK146A								
USTK153								
USTK154								
USTK157								
USTK160								
USTK163								

Kit #	Water Pump	Belt 1	Belt 2	Tensioner 1	Tensioner 2	Tensioner 3	Tensioner 4	Tensioner 5
USTK172								
USTK172A								
USTK182B								
USTK184								
USTK184A								
USTK186-187								
USTK190								
USTK193								
USTK193A								
USTK194								
USTK195								
USTK199								

Kit #	Water Pump	Belt 1	Belt 2	Tensioner 1	Tensioner 2	Tensioner 3	Tensioner 4	Tensioner 5
USTK200								
USTK201A								
USTK203								
USTK211								
USTK211A								
USTK215								
USTK215A								
USTK216-186								
USTK219								
USTK221A								
USTK223								
USTK224								

TIMING KITS

Kit #	Water Pump	Belt 1	Belt 2	Tensioner 1	Tensioner 2	Tensioner 3	Tensioner 4	Tensioner 5
USTK224A								
USTK226-186								
USTK227								
USTK227A								
USTK228								
USTK235								
USTK240								
USTK240A								
USTK244-186								
USTK245								
USTK245A								
USTK245B								



Kit #	Water Pump	Belt 1	Belt 2	Tensioner 1	Tensioner 2	Tensioner 3	Tensioner 4	Tensioner 5
USTK246								
USTK246A								
USTK247								
USTK249								
USTK252								
USTK254								
USTK254A								
USTK255								
USTK257								
USTK257A								
USTK259								
USTK262								

Kit #	Water Pump	Belt 1	Belt 2	Tensioner 1	Tensioner 2	Tensioner 3	Tensioner 4	Tensioner 5
USTK262								
USTK263								
USTK265								
USTK265A								
USTK265B								
USTK265C								
USTK271								
USTK271A								
USTK276								
USTK277A								
USTK279-280								
USTK281								

Kit #	Water Pump	Belt 1	Belt 2	Tensioner 1	Tensioner 2	Tensioner 3	Tensioner 4	Tensioner 5
USTK283								
USTK283A								
USTK284								
USTK286								
USTK286A								
USTK287								
USTK294A								
USTK295								
USTK295A								
USTK295B								
USTK296								
USTK297								

Kit #	Water Pump	Belt 1	Belt 2	Tensioner 1	Tensioner 2	Tensioner 3	Tensioner 4	Tensioner 5
USTK297A								
USTK297B								
USTK298								
USTK303								
USTK304								
USTK304A								
USTK306								
USTK306A								
USTK307								
USTK307A								
USTK309								
USTK312								



Kit #	Water Pump	Belt 1	Belt 2	Tensioner 1	Tensioner 2	Tensioner 3	Tensioner 4	Tensioner 5
USTK315								
USTK317								
USTK321								
USTK323								
USTK323A								
USTK328								
USTK328A								
USTK329								
USTK331								
USTK331A								
USTK333								
USTK335								

TIMING KITS

# FAN CLUTCHES

USMW Fan Clutches are designed with quality in mind. All product applications have been designed and tested to meet or exceed original equipment specifications. Our advanced research and design in each of our fan clutches contain the highest quality material to create the most superior product available in todays market.



## GENERAL FEATURES:

- \* CNC Machined to Exact OE Specifications and Fit
- \* All Aluminum Body for Efficient Heat Dissipation
- \* High Quality Heavy Duty Bearing with Hi-Temp Moly Grease
- \* Broad Coverage for US Domestic and Import Vehicles
- \* Attractive / Informative Retail Packaging
- \* General Application Coverage / Clutch Specification / Industry Interchange  
Printed Directly on Stock Number Label



# NON-THERMAL FAN CLUTCHES

## An Economical Replacement Fan Clutch

- Non-Thermal Fan Clutches do not have a thermal spring.
- Non-Thermal Fan Clutches are continuously engaged.
- Non-Thermal Fan Clutches achieve proper RPM of the fan to properly keep the Engine cool.

P/N	TYPE	DESCRIPTION	FAN ROTATION DIRECTION	MTG. TYPE
21011	III	NON THERMAL - 7.25" STANDARD	CW/CCW	BOLT-ON
21012	III	NON THERMAL - 7.25" STANDARD	CW/CCW	BOLT-ON
21014	III	NON THERMAL - 7.25" STANDARD	CW/CCW	BOLT-ON
21016	III	NON THERMAL - 7.25" STANDARD	CW/CCW	BOLT-ON
21026	III	NON THERMAL - 7.25" STANDARD	CW/CCW	BOLT-ON
21034	III	NON THERMAL - 7.25" STANDARD	CW/CCW	BOLT-ON
21037	III	NON THERMAL - 7.25" STANDARD	CW/CCW	BOLT-ON
21038	III	NON THERMAL - 7.25" STANDARD	CW/CCW	BOLT-ON
21043	III	NON THERMAL - 7.25" STANDARD	CW/CCW	BOLT-ON
21049	III	NON THERMAL - 7.25" STANDARD	CW/CCW	BOLT-ON
21060	II	NON THERMAL - 6" STANDARD	CW/CCW	SCREW-ON
21061	III	NON THERMAL - 7.25" STANDARD	CW/CCW	SCREW-ON
21064	II	NON THERMAL - 6" STANDARD	CW/CCW	SCREW-ON
21161	III	NON THERMAL - 7.25" STANDARD	CW/CCW	SCREW-ON
21166	II	NON THERMAL - 6" STANDARD	CW/CCW	SCREW-ON
21188	II	NON THERMAL - 6" STANDARD	CW/CCW	BOLT-ON
21709	II	NON THERMAL - 6" STANDARD	CW/CCW	SCREW-ON





## FAN CLUTCH APPLICATION GUIDE

**USMW**  
*Professional Series*

ACURA .....	225	JEEP .....	266
AM GENERAL.....	225	KIA .....	267
AMERICAN MOTORS .....	225	LAND ROVER.....	268
AUDI .....	225	LEXUS.....	268
BMW.....	226	LINCOLN.....	268
BUICK.....	227	MAZDA.....	269
CADILLAC .....	229	MERCEDES-BENZ.....	269
CHECKER.....	229	MERCURY .....	271
CHEVROLET.....	230	MERKUR .....	272
CHRYSLER .....	241	MITSUBISHI .....	272
DAIHATSU .....	242	NISSAN .....	273
DODGE .....	242	OLDSMOBILE.....	274
FORD.....	247	PLYMOUTH.....	275
GEO.....	256	PONTIAC .....	277
GMC .....	256	RAM.....	278
HONDA.....	264	SAAB .....	278
HUMMER.....	264	SUBARU .....	278
INFINITI .....	264	SUZUKI.....	279
INTERNATIONAL .....	265	TOYOTA.....	279
ISUZU .....	265	VOLKSWAGEN .....	280
JAGUAR.....	266	VOLVO .....	280



Years	Engine	Disp.	Application Description	USMW
<b>ACURA</b>				
<b>SLX</b>				
1996-1997	V6-3.2L	3165cc	Base,Premium	22021
1998-1999	V6-3.5L	3494cc	Premium	22022
<b>AM GENERAL</b>				
<b>HUMMER</b>				
1995-1996	V8-5.7L	350 CID	Base	22140
1992-1993	V8-6.2L	379 CID	Diesel; Base	22052
1994-1996	V8-6.5L	395 CID	Diesel; Base	22605
1997	V8-6.5L	395 CID	Diesel; Base	22613
1998	V8-6.5L	395 CID	Diesel; From Chassis/VIN 180137; Base	22618
1999-2001	V8-6.5L	395 CID	Diesel; Base	22618
<b>AMERICAN MOTORS</b>				
<b>AMBASSADOR</b>				
1965-1970	L6-3.8L	232 CID		22049
1971	L6-4.2L	258 CID		22049
1970-1974	V8-5.0L	304 CID		22049
1970-1974	V8-5.9L	360 CID		22049
1968-1970	V8-6.4L	390 CID		22049
1971-1974	V8-6.6L	401 CID		22049
<b>AMERICAN (MEX)</b>				
1969-1970	L6-3.3L	199 CID		22049
1969-1974	L6-3.8L	232 CID		22049
1973-1980	L6-4.2L	258 CID		22049
1975-1980	L6-4.6L	282 CID		22049
<b>AMX</b>				
1980	L6-4.2L	258 CID	Heavy Duty Cooling; Base	22048
1978-1979	L6-4.2L	258 CID		22049
1968-1969	V8-4.7L	290 CID		22049
1971-1979	V8-5.0L	304 CID		22049
1968-1969	V8-5.6L	343 CID		22049
1970-1974	V8-5.9L	360 CID		22049
1968-1970	V8-6.4L	390 CID		22049
1971-1974	V8-6.6L	401 CID		22049
<b>CLASSIC (MEX)</b>				
1966-1970	L6-3.3L	199 CID		22049
1967-1974	L6-3.8L	232 CID		22049
1972-1974	L6-4.2L	258 CID		22049
1972-1976	L6-4.6L	282 CID		22049
<b>CONCORD</b>				
1978-1979	L4-2.0L	121 CID		22049
1982	L4-2.5L	151 CID	Heavy Duty Cooling; Base,DL,Limited	22043
1980-1981	L4-2.5L	151 CID	Heavy Duty Cooling; Base,DL,Limited	22048
1978-1979	L6-3.8L	232 CID		22049
1980	L6-4.2L	258 CID	Heavy Duty Cooling; Base,DL,Limited	22048
1981	L6-4.2L	258 CID	Exc.Calif; Base,Base,DL,Limited	22048
1982-1983	L6-4.2L	258 CID	Base,Base,DL,Limited	22048
1978-1979	L6-4.2L	258 CID		22049
1978-1979	V8-5.0L	304 CID		22049
<b>EAGLE</b>				
1983	L4-2.5L	150 CID	Heavy Duty Cooling (Exc.A/C); Base,DL SX4, Limited,SX4	22048
1984	L4-2.5L	150 CID	Serpentine Belt Drive; Base,Base,Limited	22148
1982	L4-2.5L	151 CID	Heavy Duty Cooling; Base,DL Kammback,DL SX4, Kammback,Limited,SX4	22043
1981	L4-2.5L	151 CID	Heavy Duty Cooling; Base,DL Kammback,DL SX4, Kammback,Limited,SX4	22048
1983	L4-2.5L	151 CID	Heavy Duty Cooling (Exc.A/C); Base,DL SX4, Limited,SX4	22048
1980	L6-4.2L	258 CID	DL,Limited,Sport	22048
1981	L6-4.2L	258 CID	Exc.Calif; Base,Base,DL Kammback,DL SX4, Kammback,Limited,SX4	22048
1982	L6-4.2L	258 CID	Base,DL Kammback,DL SX4,Kammback,Limited,SX4	22048
1983	L6-4.2L	258 CID	Base,DL SX4,Limited,SX4	22048
1984-1987	L6-4.2L	258 CID	Serpentine Belt Drive; Base,Limited	22148
1988	L6-4.2L	258 CID	Serpentine Belt Drive; Base	22148

Years	Engine	Disp.	Application Description	USMW
<b>GREMLIN</b>				
1977-1978	L4-2.0L	121 CID		22049
1970-1978	L6-3.8L	232 CID		22049
1971-1978	L6-4.2L	258 CID		22049
1972-1976	V8-5.0L	304 CID		22049
<b>GREMLIN (MEX)</b>				
1979-1980	L6-4.2L	258 CID		22049
1979-1980	L6-4.6L	282 CID		22049
<b>HORNET</b>				
1970-1977	L6-3.8L	232 CID		22049
1971-1977	L6-4.2L	258 CID		22049
1970-1977	V8-5.0L	304 CID		22049
1971-1974	V8-5.9L	360 CID		22049
<b>JAVELIN</b>				
1968-1974	L6-3.8L	232 CID		22049
1971-1974	L6-4.2L	258 CID		22049
1970-1974	V8-5.0L	304 CID		22049
1970-1974	V8-5.9L	360 CID		22049
1971-1974	V8-6.6L	401 CID		22049
<b>LERMA (MEX)</b>				
1980	L6-4.6L	282 CID		22049
<b>MARLIN</b>				
1965-1967	L6-3.8L	232 CID		22049
1965-1966	V8-4.7L	287 CID		22049
1967	V8-4.7L	290 CID		22049
1965-1966	V8-5.3L	327 CID		22049
1967	V8-5.6L	343 CID		22049
<b>MATADOR</b>				
1971-1974	L6-3.8L	232 CID		22049
1971-1978	L6-4.2L	258 CID		22049
1971-1977	V8-5.0L	304 CID		22049
1971-1978	V8-5.9L	360 CID		22049
1971-1976	V8-6.6L	401 CID		22049
<b>PACER</b>				
1975-1978	L6-3.8L	232 CID		22049
1980	L6-4.2L	258 CID	DL,Limited	22048
1975-1979	L6-4.2L	258 CID		22049
1978-1979	V8-5.0L	304 CID		22049
<b>REBEL</b>				
1967-1970	L6-3.8L	232 CID		22049
1967-1969	V8-4.7L	290 CID		22049
1970	V8-5.0L	304 CID		22049
1967-1969	V8-5.6L	343 CID		22049
1970	V8-5.9L	360 CID		22049
1970	V8-6.4L	390 CID		22049
<b>SPIRIT</b>				
1979	L4-2.0L	121 CID		22049
1982	L4-2.5L	151 CID	Heavy Duty Cooling; Base,DL	22043
1980	L4-2.5L	151 CID	Heavy Duty Cooling; Base,DL,Limited	22048
1981	L4-2.5L	151 CID	Heavy Duty Cooling; Base,DL	22048
1979	L6-3.8L	232 CID		22049
1980	L6-4.2L	258 CID	Heavy Duty Cooling; Base,DL,Limited	22048
1981	L6-4.2L	258 CID	Exc.Calif; Base,DL	22048
1982	L6-4.2L	258 CID	Base,DL	22048
1983	L6-4.2L	258 CID	DL,GT	22048
1979	L6-4.2L	258 CID		22049
1979	V8-5.0L	304 CID		22049
<b>AUDI</b>				
<b>A4</b>				
1997-2001	L4-1.8L	1781cc	Base	22302
1996-1997	V6-2.8L	2771cc	Base	22303
1998	V6-2.8L	2771cc	Avant,Base	22303
1999-2001	V6-2.8L	2771cc	Base	22303
<b>A4 (MEX)</b>				
2007-2009	L4-1.8L	1781cc		22302
<b>A4 QUATTRO</b>				
1997-1998	L4-1.8L	1781cc	Base	22302

**FAN CLUTCHES**



# FAN CLUTCH APPLICATION GUIDE



Years	Engine	Disp.	Application Description	USMW
1999-2001	L4-1.8L	1781cc	Avant,Base	22302
1996-1997	V6-2.8L	2771cc	Base	22303
1998-2001	V6-2.8L	2771cc	Avant,Base	22303
<b>A6</b>				
1998-2001	V6-2.8L	2771cc	Base	22303
<b>A6 QUATTRO</b>				
2000-2004	V6-2.7L	2671cc	Base	22303
1998	V6-2.8L	2771cc	Base	22303
1999-2001	V6-2.8L	2771cc	Avant,Base	22303
2000-2004	V8-4.2L	4172cc	Base	22316
<b>A8</b>				
1997-1999	V8-3.7L	3697cc	Base	22316
<b>A8 (MEX)</b>				
1996	V8-4.2L	4172cc		22316
<b>A8 QUATTRO</b>				
1997-1999	V8-4.2L	4172cc	Base	22316
2000-2003	V8-4.2L	4172cc	Base,L	22316
<b>ALLROAD QUATTRO</b>				
2001-2005	V6-2.7L	2671cc	Base	22303
<b>S4</b>				
1992-1994	L5-2.2L	2226cc	Base	22311
2000	V6-2.7L	2671cc	Base	22303
2001-2002	V6-2.7L	2671cc	Avant,Base	22303
<b>S6</b>				
1995	L5-2.2L	2226cc	Avant,Base	22311
2002-2003	V8-4.2L	4172cc	Avant	22316
<b>S6 QUATTRO (MEX)</b>				
2001-2004	V8-4.2L	4172cc		22316
<b>S8</b>				
2001-2003	V8-4.2L	4172cc	Base	22316
<b>V8 QUATTRO</b>				
1990-1991	V8-3.6L	3562cc	Base	22311
1992-1994	V8-4.2L	4172cc	Base	22311
<b>BMW</b>				
<b>325</b>				
1986-1988	L6-2.7L	2693cc	Base	22071
<b>3.0SI</b>				
1975-1976	L6-3.0L	2985cc		22071
<b>318 (MEX)</b>				
1986	L4-1.8L	1800cc		22071
<b>318I</b>				
1984-1985	L4-1.8L	1766cc	Base	22071
1991-1995	L4-1.8L	1796cc	Base	22071
1996-1998	L4-1.9L	1895cc	Base	22071
<b>318IS</b>				
1991-1995	L4-1.8L	1796cc	Base	22071
1996-1997	L4-1.9L	1895cc	Base	22071
<b>318TI</b>				
1995	L4-1.8L	1796cc	Base	22071
1996-1999	L4-1.9L	1895cc	Base	22071
<b>320I</b>				
1977-1979	L4-2.0L	1990cc		22071
<b>320I (MEX)</b>				
2001-2005	L6-2.2L	2171cc		22099
<b>323CI</b>				
2000	L6-2.5L	2494cc	Base	22099
<b>323I</b>				
1998-2000	L6-2.5L	2494cc	Base	22099
<b>323I (MEX)</b>				
1997-2001	L6-2.5L	2494cc		22099
<b>323IS</b>				
1998-1999	L6-2.5L	2494cc	Base	22099
<b>323TI (MEX)</b>				
2001	L6-2.5L	2494cc		22099
<b>325CI</b>				
2001-2006	L6-2.5L	2494cc	Base	22099

Years	Engine	Disp.	Application Description	USMW
<b>325CI (MEX)</b>				
2007	L6-2.5L	2494cc		22099
<b>325E</b>				
1984-1987	L6-2.7L	2693cc	Base	22071
<b>325ES</b>				
1986-1987	L6-2.7L	2693cc	Base	22071
<b>325I</b>				
1987-1991	L6-2.5L	2494cc	Base	22071
1992-2005	L6-2.5L	2494cc	Base	22099
<b>325I (MEX)</b>				
1996-2012	L6-2.5L	2494cc		22071
2006-2010	L6-2.5L	2497cc		22071
<b>325IS</b>				
1987-1991	L6-2.5L	2494cc	Base	22071
1992-1995	L6-2.5L	2494cc	Base	22099
<b>325IX</b>				
1988-1991	L6-2.5L	2494cc	Base	22071
<b>325XI</b>				
2001-2005	L6-2.5L	2494cc	Base	22099
<b>328CI</b>				
2000	L6-2.8L	2793cc	Base	22099
<b>328I</b>				
1996-2000	L6-2.8L	2793cc	Base	22099
<b>328I (MEX)</b>				
1995	L6-2.8L	2788cc		22099
<b>328IS</b>				
1996-1999	L6-2.8L	2793cc	Base	22099
<b>330CI</b>				
2001-2006	L6-3.0L	2979cc	Base	22099
<b>330I</b>				
2001-2005	L6-3.0L	2979cc	Base	22099
<b>330XI</b>				
2001-2005	L6-3.0L	2979cc	Base	22099
<b>524TD (MEX)</b>				
1987	L6-2.4L	2443cc		22071
<b>525I</b>				
1989-1990	L6-2.5L	2494cc	Base	22071
1991-2003	L6-2.5L	2494cc	Base	22099
<b>525I (MEX)</b>				
1986	L6-2.5L	2494cc		22071
2006-2009	L6-2.5L	2497cc		22071
<b>525I LUJO (MEX)</b>				
2010	L6-2.5L	2497cc		22071
<b>528 (MEX)</b>				
1996	L6-2.8L	2800cc		22099
<b>528E</b>				
1982-1988	L6-2.7L	2693cc	Base	22071
<b>528I</b>				
1979	L6-2.8L	2788cc		22071
1980-1981	L6-2.8L	2788cc	Base	22071
1997-2000	L6-2.8L	2793cc	Base	22099
<b>530I</b>				
2001-2003	L6-3.0L	2979cc	Base	22099
1975-1978	L6-3.0L	2985cc		22071
1994-1995	V8-3.0L	2997cc	Base	22099
<b>533I</b>				
1983-1984	L6-3.2L	3210cc	Base	22071
<b>535I</b>				
1985-1988	L6-3.5L	3430cc	Base	22071
1989-1993	L6-3.5L	3430cc	Base	22099
<b>535IS</b>				
1988	L6-3.5L	3430cc	Base	22071
<b>540I</b>				
1994-1995	V8-4.0L	3982cc	Base	22099
1997-2003	V8-4.4L	4398cc	Base	22099

Years	Engine	Disp.	Application Description	USMW
<b>540I (MEX)</b>				
1996	V8-4.0L	3982cc		22071
<b>630CSI</b>				
1977	L6-3.0L	2985cc		22071
<b>633CSI</b>				
1978-1979	L6-3.2L	3210cc		22071
1980-1984	L6-3.2L	3210cc	Base	22071
<b>635CSI</b>				
1985-1989	L6-3.5L	3430cc	Base	22071
<b>733I</b>				
1979	L6-3.2L	195 CID		22071
1978	L6-3.2L	3210cc		22071
1980-1984	L6-3.2L	3210cc	Base	22099
<b>735I</b>				
1985-1992	L6-3.5L	3430cc	Base	22099
<b>735IL</b>				
1988-1992	L6-3.5L	3430cc	Base	22099
<b>740I</b>				
1993-1995	V8-4.0L	3982cc	Base	22099
1997-2001	V8-4.4L	4398cc	Base	22099
<b>740IL</b>				
1993-1995	V8-4.0L	3982cc	Base	22099
1996-2001	V8-4.4L	4398cc	Base	22099
<b>745I</b>				
2002	V8-4.4L	4398cc	Base	22399
2003	V8-4.4L	4398cc	To 03/03; Base	22399
<b>745LI</b>				
2002	V8-4.4L	4398cc	Base	22399
2003	V8-4.4L	4398cc	To 03/03; Base	22399
<b>750IL</b>				
1988-1994	V12-5.0L	4988cc	Base	22099
1995-2001	V12-5.4L	5379cc	Base	22099
<b>760I</b>				
2004-2006	V12-6.0L	5972cc	Base	22399
<b>760LI</b>				
2003-2008	V12-6.0L	5972cc	Base	22399
<b>840CI</b>				
1994-1995	V8-4.0L	3982cc	Base	22099
1996-1997	V8-4.4L	4398cc	Base	22099
<b>850CI</b>				
1993-1994	V12-5.0L	4988cc	Base	22099
1995-1997	V12-5.4L	5379cc	Base	22099
<b>850CI (MEX)</b>				
1998	V12-5.4L	5379cc		22071
<b>850CSI</b>				
1994-1995	V12-5.6L	5576cc	Base	22099
<b>850I</b>				
1991-1992	V12-5.0L	4988cc	Base	22099
<b>850I (MEX)</b>				
1990	V12-5.0L	5000cc		22071
<b>L6</b>				
1987	L6-3.5L	3430cc	Base	22071
<b>L7</b>				
1986-1987	L6-3.5L	3430cc	Base	22099
<b>M3</b>				
1995	L6-3.0L	2990cc	Base,Lightweight	22099
1996-1999	L6-3.2L	3152cc	Base	22099
2001-2006	L6-3.2L	3246cc	Base	22099
<b>M3 (MEX)</b>				
1994	L6-3.0L	2990cc		22099
<b>M5</b>				
1988	L6-3.5L	3453cc	Base	22071
1991-1993	L6-3.6L	3553cc	Base	22099
2000-2003	V8-5.0L	4941cc	Base	22326
<b>M5 (MEX)</b>				
1999	V8-4.9L	4941cc		22326

Years	Engine	Disp.	Application Description	USMW
<b>M6</b>				
1987-1988	L6-3.5L	3453cc	Base	22071
<b>X3 AWD (MEX)</b>				
2006-2009	L6-2.5L	2494cc		22099
<b>X5</b>				
2001-2006	L6-3.0L	2979cc	3.0i	22099
2000-2003	V8-4.4L	4398cc	4.4i	22399
2002-2003	V8-4.6L	4598cc	4.6is	22399
<b>Z3</b>				
1996-1998	L4-1.9L	1895cc	Roadster	22071
1999-2002	L6-2.5L	2494cc	Roadster	22099
1997-1998	L6-2.8L	2793cc	Roadster	22099
1999-2000	L6-2.8L	2793cc	Coupe,Roadster	22099
2001-2002	L6-3.0L	2979cc	Coupe,Roadster	22099
1998	L6-3.2L	3152cc	M Roadster	22099
1999-2000	L6-3.2L	3152cc	M Coupe,M Roadster	22099
2001-2002	L6-3.2L	3246cc	M Coupe,M Roadster	22099
<b>Z8</b>				
2003	V8-4.8L	4837cc	Alpina	22326
2000-2003	V8-5.0L	4941cc	Base	22326
<b>BUICK</b>				
<b>APOLLO</b>				
1973-1975	L6-4.1L	250 CID		22045
1975	V8-4.3L	260 CID		22045
1973-1975	V8-5.7L	350 CID		22045
<b>CENTURION</b>				
1973	V8-5.7L	350 CID		22045
1971-1973	V8-7.5L	455 CID		22045
<b>CENTURY</b>				
1978-1979	V6-3.2L	196 CID		22043
1975-1979	V6-3.8L	231 CID		22043
1980	V6-3.8L	231 CID	Exc.A/C; Base,Estate,Limited,Sport	22043
1981	V6-3.8L	231 CID	Exc.A/C; Base,Estate,Limited,Sport	22049
1980	V8-4.3L	265 CID	Base,Estate,Limited	22045
1981	V8-4.3L	265 CID	A/C (Heavy Duty Cooling);Base,Estate,Limited,Sport	22049
1979	V8-4.9L	301 CID		22043
1980	V8-4.9L	301 CID	A/C; Base,Base,Estate,Limited,Sport	22049
1977-1979	V8-5.0L	305 CID		22043
1980	V8-5.0L	305 CID	A/C (Heavy Duty Cooling); Base,Estate,Limited	22045
1973-1979	V8-5.7L	350 CID		22043
1981	V8-5.7L	350 CID	Diesel; Exc.Heavy Duty Cooling; Base,Estate,Limited	22049
1977	V8-6.6L	403 CID		22054
1973-1974	V8-7.5L	455 CID		22043
<b>COMMERCIAL CHASSIS</b>				
1991	V8-5.0L	305 CID	Heavy Duty Cooling; Base	22145
1994-1996	V8-5.7L	350 CID	Heavy Duty Cooling; Base	22045
1992-1993	V8-5.7L	350 CID	Heavy Duty Cooling; Base	22145
<b>ELECTRA</b>				
1980-1984	V6-4.1L	252 CID	Limited,Park Avenue	22049
1980	V8-4.9L	301 CID	A/C; Estate Wagon,Estate Wagon	22049
1981	V8-5.0L	307 CID	Estate Wagon,Limited,Park Avenue	22049
1982-1984	V8-5.0L	307 CID	Drive Ratio 2.73; Estate Wagon,Estate Wagon, Limited,Park Avenue	22049
1985-1989	V8-5.0L	307 CID	Estate Wagon	22049
1977-1979	V8-5.7L	350 CID		22043
1980	V8-5.7L	350 CID	Diesel; Exc.Heavy Duty Cooling; Estate Wagon, Limited,Park Avenue	22049
1981-1983	V8-5.7L	350 CID	Diesel; Exc.Heavy Duty Cooling; Estate Wagon, Limited,Park Avenue	22049
1984-1985	V8-5.7L	350 CID	Diesel; Exc.Heavy Duty Cooling; Estate Wagon	22049
1959-1966	V8-6.6L	401 CID		22045
1977-1979	V8-6.6L	403 CID		22045
1964-1966	V8-7.0L	425 CID		22045
1967-1969	V8-7.0L	430 CID		22045
1970-1976	V8-7.5L	455 CID		22043
<b>ELECTRA PARK AVENUE</b>				
1978-1979	V8-5.7L	350 CID		22043

**FAN CLUTCHES**

Years	Engine	Disp.	Application Description	USMW
1978-1979	V8-6.6L	403 CID		<b>22045</b>
<b>ESTATE WAGON</b>				
1980	V8-4.9L	301 CID	A/C; Base,Base	<b>22049</b>
1981	V8-5.0L	307 CID	Base	<b>22049</b>
1982-1983	V8-5.0L	307 CID	Drive Ratio 2.73; Base,Base	<b>22049</b>
1977-1979	V8-5.7L	350 CID		<b>22043</b>
1980	V8-5.7L	350 CID	Diesel; Exc.Heavy Duty Cooling; Base	<b>22049</b>
1981-1983	V8-5.7L	350 CID	Diesel; Exc.Heavy Duty Cooling; Base	<b>22049</b>
1977-1979	V8-6.6L	403 CID		<b>22045</b>
1970-1976	V8-7.5L	455 CID		<b>22043</b>
<b>GRAN SPORT</b>				
1968-1972	V8-5.7L	350 CID		<b>22049</b>
1967-1969	V8-6.6L	400 CID		<b>22045</b>
1965-1966	V8-6.6L	401 CID		<b>22045</b>
1970-1972	V8-7.5L	455 CID		<b>22045</b>
<b>INVICTA</b>				
1959-1963	V8-6.6L	401 CID		<b>22045</b>
<b>LESABRE</b>				
1976-1979	V6-3.8L	231 CID		<b>22043</b>
1980	V6-3.8L	231 CID	Exc.A/C; Base,Base,Limited,Sport	<b>22043</b>
1981	V6-3.8L	231 CID	Exc.A/C; Base,Base,Limited,Sport	<b>22049</b>
1982	V6-3.8L	231 CID	Custom,Limited,Limited Edition F/E	<b>22049</b>
1983-1984	V6-3.8L	231 CID	Custom,Limited	<b>22049</b>
1985	V6-3.8L	231 CID	Collector's Edition,Custom,Limited	<b>22049</b>
1980	V6-4.1L	252 CID	Base,Limited	<b>22043</b>
1981	V6-4.1L	252 CID	Base,Limited,Sport	<b>22043</b>
1982	V6-4.1L	252 CID	Custom,Limited,Limited Edition F/E	<b>22049</b>
1983-1984	V6-4.1L	252 CID	Custom,Limited	<b>22049</b>
1964-1965	V8-4.9L	300 CID		<b>22043</b>
1977-1979	V8-4.9L	301 CID		<b>22043</b>
1980	V8-4.9L	301 CID	A/C; Base,Base,Limited	<b>22049</b>
1978	V8-5.0L	305 CID		<b>22043</b>
1981	V8-5.0L	307 CID	Base,Limited,Sport	<b>22049</b>
1982	V8-5.0L	307 CID	Drive Ratio 2.73; Custom,Limited Edition F/E	<b>22049</b>
1983-1984	V8-5.0L	307 CID	Drive Ratio 2.73; Custom,Limited	<b>22049</b>
1985	V8-5.0L	307 CID	Collector's Edition,Custom,Estate Wagon,Limited	<b>22049</b>
1986-1987	V8-5.0L	307 CID	Estate Wagon	<b>22049</b>
1988-1990	V8-5.0L	307 CID	Drive Ratio 2.94; Estate Wagon	<b>22049</b>
1967	V8-5.6L	340 CID		<b>22043</b>
1966	V8-5.6L	340 CID		<b>22049</b>
1968-1979	V8-5.7L	350 CID		<b>22043</b>
1980	V8-5.7L	350 CID	Diesel; Exc.Heavy Duty Cooling; Base,Limited	<b>22049</b>
1981	V8-5.7L	350 CID	Diesel; Exc.Heavy Duty Cooling; Base,Limited,Sport	<b>22049</b>
1982	V8-5.7L	350 CID	Diesel; Exc.Heavy Duty Cooling; Custom,Limited, Limited Edition F/E	<b>22049</b>
1983-1984	V8-5.7L	350 CID	Diesel; Exc.Heavy Duty Cooling; Custom,Limited	<b>22049</b>
1985	V8-5.7L	350 CID	Diesel; Exc.Heavy Duty Cooling; Collector's Edition, Custom,Estate Wagon,Limited	<b>22049</b>
1975	V8-6.6L	400 CID		<b>22045</b>
1962-1964	V8-6.6L	401 CID		<b>22045</b>
1977-1978	V8-6.6L	403 CID		<b>22045</b>
1964	V8-7.0L	425 CID		<b>22045</b>
1970-1976	V8-7.5L	455 CID		<b>22043</b>
<b>LESABRE ESTATE WAGON</b>				
1987	V8-5.0L	307 CID		<b>22049</b>
<b>RAINIER</b>				
2004-2005	L6-4.2L	256 CID	CXL,CXL Plus	<b>22310</b>
2006	L6-4.2L	256 CID	CXL	<b>22310</b>
2007	L6-4.2L	256 CID	CXL	<b>22330</b>
2004-2005	V8-5.3L	323 CID	CXL,CXL Plus	<b>22310</b>
2006	V8-5.3L	325 CID	CXL	<b>22310</b>
2007	V8-5.3L	325 CID	CXL	<b>22330</b>
<b>REGAL</b>				
1978-1979	V6-3.2L	196 CID		<b>22043</b>
1975-1979	V6-3.8L	231 CID		<b>22043</b>
1980	V6-3.8L	231 CID	Exc.A/C; Base,Limited,Sport	<b>22043</b>
1981	V6-3.8L	231 CID	Exc.A/C; Base,Limited,Sport	<b>22049</b>
1982	V6-3.8L	231 CID	Base,Estate Wagon,Limited,Sport	<b>22049</b>

Years	Engine	Disp.	Application Description	USMW
1983	V6-3.8L	231 CID	Base,Estate Wagon,Limited,T-Type	<b>22049</b>
1984-1985	V6-3.8L	231 CID	Base,Grand National,Limited,T-Type	<b>22049</b>
1986-1987	V6-3.8L	231 CID	Base,Limited	<b>22049</b>
1982	V6-4.1L	252 CID	Base,Estate Wagon,Limited,Limited Turbo	<b>22049</b>
1983	V6-4.1L	252 CID	Base,Estate Wagon,Limited	<b>22049</b>
1984	V6-4.1L	252 CID	Base,Limited	<b>22049</b>
1982-1984	V6-4.3L	260 CID	Diesel; Heavy Duty Cooling; Base,Limited	<b>22049</b>
1980	V8-4.3L	265 CID	Base,Limited	<b>22045</b>
1981	V8-4.3L	265 CID	A/C (Heavy Duty Cooling); Base,Limited	<b>22049</b>
1979	V8-4.9L	301 CID		<b>22043</b>
1980	V8-4.9L	301 CID	A/C; Base,Base,Limited	<b>22049</b>
1978-1979	V8-5.0L	305 CID		<b>22043</b>
1980	V8-5.0L	305 CID	A/C (Heavy Duty Cooling); Base,Base,Limited	<b>22045</b>
1986-1987	V8-5.0L	307 CID	Base,Limited	<b>22049</b>
1973-1977	V8-5.7L	350 CID		<b>22043</b>
1982-1983	V8-5.7L	350 CID	Diesel; Exc.Heavy Duty Cooling; Base,Estate Wagon, Limited	<b>22049</b>
1985	V8-5.7L	350 CID	Diesel; Exc.Heavy Duty Cooling; Base	<b>22049</b>
1973-1974	V8-7.5L	455 CID		<b>22043</b>
<b>RIVIERA</b>				
1979	V6-3.8L	231 CID		<b>22043</b>
1980	V6-3.8L	231 CID	Exc.A/C; Base,S	<b>22043</b>
1981	V6-3.8L	231 CID	Exc.A/C; Base,T-Type	<b>22049</b>
1982-1983	V6-3.8L	231 CID	T-Type	<b>22049</b>
1984-1985	V6-3.8L	231 CID	Base,Luxury,T-Type	<b>22049</b>
1981	V6-4.1L	252 CID	Base,T-Type	<b>22043</b>
1982	V6-4.1L	252 CID	Base,Limited Edition	<b>22049</b>
1983	V6-4.1L	252 CID	Base,Luxury,XX Anniversary Edition	<b>22049</b>
1984	V6-4.1L	252 CID	Base,Luxury	<b>22049</b>
1980	V8-5.0L	307 CID	Base,S	<b>22045</b>
1981	V8-5.0L	307 CID	Base,T-Type	<b>22049</b>
1982	V8-5.0L	307 CID	Base,Limited Edition	<b>22049</b>
1983	V8-5.0L	307 CID	Base,Luxury,XX Anniversary Edition	<b>22049</b>
1984-1985	V8-5.0L	307 CID	Base,Luxury	<b>22049</b>
1980	V8-5.7L	350 CID	Base,S	<b>22041</b>
1977-1979	V8-5.7L	350 CID		<b>22043</b>
1981	V8-5.7L	350 CID	Diesel; Exc.Heavy Duty Cooling; Base	<b>22049</b>
1982	V8-5.7L	350 CID	Diesel; Exc.Heavy Duty Cooling; Base,Limited Edition	<b>22049</b>
1983	V8-5.7L	350 CID	Diesel; Exc.Heavy Duty Cooling; Base,Luxury, XX Anniversary Edition	<b>22049</b>
1984-1985	V8-5.7L	350 CID	Diesel; Exc.Heavy Duty Cooling; Base,Luxury	<b>22049</b>
1963-1965	V8-6.6L	401 CID		<b>22045</b>
1977-1978	V8-6.6L	403 CID		<b>22045</b>
1963-1966	V8-7.0L	425 CID		<b>22045</b>
1967-1969	V8-7.0L	430 CID		<b>22045</b>
1970-1976	V8-7.5L	455 CID		<b>22043</b>
<b>ROADMASTER</b>				
1991	V8-5.0L	305 CID	Heavy Duty Cooling; Estate Wagon	<b>22145</b>
1994-1995	V8-5.7L	350 CID	Heavy Duty Cooling; Base,Estate Wagon,Limited	<b>22045</b>
1996	V8-5.7L	350 CID	Heavy Duty Cooling; Collector's Edition, Estate Wagon Collector's Edition, Limited Collector's Edition	<b>22045</b>
1992-1993	V8-5.7L	350 CID	Heavy Duty Cooling; Base,Estate Wagon,Limited	<b>22145</b>
<b>SKYHAWK</b>				
1980	V6-3.8L	231 CID	Exc.A/C; Base,Designers' Accent Edition Road Hawk,S	<b>22043</b>
<b>SKYLARK</b>				
1968-1971	L6-4.1L	250 CID		<b>22043</b>
1964-1967	V6-3.7L	225 CID		<b>22043</b>
1975-1979	V6-3.8L	231 CID		<b>22043</b>
1975-1976	V8-4.3L	260 CID		<b>22045</b>
1964-1967	V8-4.9L	300 CID		<b>22043</b>
1977	V8-4.9L	301 CID		<b>22043</b>
1977-1979	V8-5.0L	305 CID		<b>22043</b>
1966-1967	V8-5.6L	340 CID		<b>22043</b>
1968-1979	V8-5.7L	350 CID		<b>22043</b>
1965-1966	V8-6.6L	400 CID		<b>22045</b>
1971-1972	V8-7.5L	455 CID		<b>22043</b>



Years	Engine	Disp.	Application Description	USMW
<b>SPECIAL</b>				
1968	L6-4.1L	250 CID		22011
1969	L6-4.1L	250 CID		22043
1965-1967	V6-3.7L	225 CID		22043
1964-1967	V8-4.9L	300 CID		22043
1968-1969	V8-5.7L	350 CID		22043
<b>WILDCAT</b>				
1963-1966	V8-6.6L	401 CID		22045
1964-1966	V8-7.0L	425 CID		22045
1967-1969	V8-7.0L	430 CID		22045
1970	V8-7.5L	455 CID		22045
<b>CADILLAC</b>				
<b>60 SPECIAL</b>				
1968-1970	V8-7.7L	472 CID		22045
<b>BROUGHAM</b>				
1991-1992	V8-5.0L	305 CID	Base, d'Elegance	22145
1987-1990	V8-5.0L	307 CID	Base, d'Elegance	22043
1990-1992	V8-5.7L	350 CID	Base, d'Elegance	22145
<b>CALAIS</b>				
1965-1967	V8-7.0L	429 CID		22045
1968-1974	V8-7.7L	472 CID		22045
1975-1976	V8-8.2L	500 CID		22045
<b>COMMERCIAL CHASSIS</b>				
1994-1996	V8-5.7L	350 CID	Heavy Duty Cooling; Base, Brougham	22045
1992	V8-5.7L	350 CID	High Performance; Base, Estate, Limited, Sport	22145
1993	V8-5.7L	350 CID	Heavy Duty Cooling; Brougham	22145
1980-1984	V8-6.0L	368 CID	Base	22041
<b>DEVILLE</b>				
1980-1981	V6-4.1L	252 CID	Base, Cabriolet, d'Elegance	22041
1982	V6-4.1L	252 CID	Base, Cabriolet, d'Elegance	22043
1984	V8-4.1L	250 CID	Base, Cabriolet, d'Elegance	22026
1982-1983	V8-4.1L	250 CID	Base, Cabriolet, d'Elegance	22049
1979	V8-5.7L	350 CID		22041
1980-1981	V8-5.7L	350 CID	Diesel; Base, Cabriolet, d'Elegance	22041
1983-1984	V8-5.7L	350 CID	Diesel; Base, Cabriolet, d'Elegance	22043
1982	V8-5.7L	350 CID	Diesel; Base, Cabriolet, d'Elegance	22049
1980-1981	V8-6.0L	368 CID	Base, Cabriolet, d'Elegance	22041
1977-1979	V8-7.0L	425 CID		22041
1964-1967	V8-7.0L	429 CID		22045
1968-1974	V8-7.7L	472 CID		22045
1975-1976	V8-8.2L	500 CID		22045
<b>ELDORADO</b>				
1981	V6-4.1L	252 CID	Base, Biarritz, Brougham d'Elegance, Cabriolet	22049
1982	V6-4.1L	252 CID	Base, Biarritz, Cabriolet, Touring	22049
1982-1985	V8-4.1L	250 CID	Base, Biarritz, Cabriolet, Touring	22049
1979	V8-5.7L	350 CID		22041
1980	V8-5.7L	350 CID	Diesel; Base, Biarritz, Cabriolet	22041
1981	V8-5.7L	350 CID	Diesel; Base, Biarritz, Brougham d'Elegance, Cabriolet	22041
1983	V8-5.7L	350 CID	Diesel; Base, Biarritz, Cabriolet, Touring	22043
1982	V8-5.7L	350 CID	Diesel; Base, Biarritz, Cabriolet, Touring	22049
1984-1985	V8-5.7L	350 CID	Diesel; Base, Cabriolet, Touring	22049
1980	V8-6.0L	368 CID	Base, Biarritz, Cabriolet	22041
1981	V8-6.0L	368 CID	Base, Biarritz, Brougham d'Elegance, Cabriolet	22041
1977-1978	V8-7.0L	425 CID		22041
1964-1967	V8-7.0L	429 CID		22045
1968-1969	V8-7.7L	472 CID		22049
1970-1976	V8-8.2L	500 CID		22045
<b>ESCALADE</b>				
2002-2004	V8-5.3L	325 CID	Manual Temperature Controls; Base	22158
2005	V8-5.3L	325 CID	Base	22158
1999-2000	V8-5.7L	350 CID	Exc. A/C; Base,	22162
2002-2006	V8-6.0L	364 CID	Base	22158
<b>ESCALADE ESV</b>				
2003-2006	V8-6.0L	364 CID	Base	22158
<b>ESCALADE EXT</b>				
2002-2006	V8-6.0L	364 CID	Base	22158

Years	Engine	Disp.	Application Description	USMW
<b>FLEETWOOD</b>				
1980-1982	V6-4.1L	252 CID	Brougham, Brougham d'Elegance	22041
1984	V8-4.1L	250 CID	Brougham, Brougham d'Elegance	22026
1985	V8-4.1L	250 CID	RWD; Brougham, Brougham d'Elegance	22026
1982-1983	V8-4.1L	250 CID	Brougham, Brougham d'Elegance	22049
1986	V8-5.0L	307 CID	Brougham, Brougham d'Elegance	22043
1979	V8-5.7L	350 CID		22041
1980-1981	V8-5.7L	350 CID	Diesel; Brougham, Brougham d'Elegance	22041
1982-1985	V8-5.7L	350 CID	Diesel; Brougham, Brougham d'Elegance	22043
1994-1996	V8-5.7L	350 CID	Heavy Duty Cooling; Base, Brougham	22045
1993	V8-5.7L	350 CID	Heavy Duty Cooling; Base, Brougham	22145
1980-1981	V8-6.0L	368 CID	Base, Brougham, Brougham d'Elegance, Formal	22041
1982-1984	V8-6.0L	368 CID	Base, Formal	22041
1977-1979	V8-7.0L	425 CID		22041
<b>FLEETWOOD 75</b>				
1968-1974	V8-7.7L	472 CID		22045
1975-1976	V8-8.2L	500 CID		22045
<b>FLEETWOOD BROUGHAM</b>				
1971-1974	V8-7.7L	472 CID		22051
1976	V8-8.2L	500 CID		22045
1975	V8-8.2L	500 CID		22051
<b>SEVENTY-FIVE</b>				
1965-1967	V8-7.0L	429 CID		22026
<b>SEVILLE</b>				
1981	V6-4.1L	252 CID	Base, Elegante	22043
1982	V6-4.1L	252 CID	Base, Elegante	22049
1982-1985	V8-4.1L	250 CID	Base, Elegante	22049
1977-1979	V8-5.7L	350 CID		22041
1980	V8-5.7L	350 CID	Diesel; Base, Elegante	22041
1981	V8-5.7L	350 CID	Diesel; Base, Elegante	22041
1976	V8-5.7L	350 CID		22049
1982-1985	V8-5.7L	350 CID	Diesel; Base, Elegante	22049
1980-1981	V8-6.0L	368 CID	Base, Elegante	22041
<b>SIXTY SPECIAL</b>				
1964	V8-7.0L	429 CID		22016
1965-1967	V8-7.0L	429 CID		22026
<b>SRX</b>				
2004	V8-4.6L	281 CID	Base	22628
<b>CHECKER</b>				
<b>DELUXE LIMO</b>				
1969	V8-5.3L	327 CID		22016
1969	V8-5.7L	350 CID		22049
<b>DELUXE SEDAN</b>				
1969	V8-5.3L	327 CID		22016
1969	V8-5.7L	350 CID		22049
<b>MARATHON</b>				
1965	L6-3.8L	230 CID		22049
1975-1979	L6-4.1L	250 CID		22049
1980-1982	V8-4.4L	267 CID		22049
1977-1982	V8-5.0L	305 CID		22049
1977-1982	V8-5.7L	350 CID		22049
<b>MARATHON DELUX LIMO</b>				
1971	L6-4.1L	250 CID		22049
1970-1971	V8-5.7L	350 CID		22049
<b>MARATHON DELUX SEDAN</b>				
1970-1971	V8-5.7L	350 CID		22049
<b>MARATHON DELUX WAGON</b>				
1970	V8-5.7L	350 CID		22049
<b>MARATHON DELUXE</b>				
1972-1974	L6-4.1L	250 CID		22049
1980-1981	V8-4.4L	267 CID		22049
1977-1981	V8-5.0L	305 CID		22049
1972-1981	V8-5.7L	350 CID		22049
<b>MARATHON LIMO</b>				
1966	L6-3.8L	230 CID		22049
1966	V8-5.3L	327 CID		22016

FAN CLUTCHES

Years	Engine	Disp.	Application Description	USMW
<b>MARATHON SEDAN</b>				
1966-1968	L6-3.8L	230 CID		22049
1971-1974	L6-4.1L	250 CID		22049
1968	V8-5.0L	307 CID		22049
1965-1967	V8-5.3L	327 CID		22016
1968-1969	V8-5.3L	327 CID		22049
1969-1974	V8-5.7L	350 CID		22049
<b>MARATHON WAGON</b>				
1967-1968	L6-3.8L	230 CID		22049
1971-1974	L6-4.1L	250 CID		22049
1968	V8-5.0L	307 CID		22049
1965-1967	V8-5.3L	327 CID		22016
1968-1969	V8-5.3L	327 CID		22049
1969-1974	V8-5.7L	350 CID		22049
<b>TOWN CUSTOM</b>				
1965	L6-3.8L	230 CID		22049
<b>CHEVROLET</b>				
<b>3100 1/2 TON</b>				
1958	V8-4.6L	283 CID		22049
<b>3101 1/2 TON</b>				
1958	V8-4.6L	283 CID		22049
<b>3102 1/2 TON</b>				
1958	V8-4.6L	283 CID		22049
<b>3200 1/2 TON</b>				
1958	V8-4.6L	283 CID		22049
<b>3201 1/2 TON</b>				
1958	V8-4.6L	283 CID		22049
<b>3600 3/4 TON</b>				
1958	V8-4.6L	283 CID		22049
<b>3601 3/4 TON</b>				
1958	V8-4.6L	283 CID		22049
<b>3602 3/4 TON</b>				
1958	V8-4.6L	283 CID		22049
<b>3603 3/4 TON</b>				
1958	V8-4.6L	283 CID		22049
<b>400SS PICKUP (MEX)</b>				
1994	V8-5.7L	350 CID		22145
<b>ASTRO</b>				
1985-1986	L4-2.5L	151 CID	A/C; Base,CL,CS	22013
1988-1990	L4-2.5L	151 CID	A/C; Base,CL,CS,LT	22147
1987	L4-2.5L	151 CID	A/C; Base,CL,CS,LT	22179
1985-1986	V6-4.3L	262 CID	Exc.A/C; Base,CL,CS	22026
1990-1994	V6-4.3L	262 CID	Base,CL,CS,LT	22142
1995	V6-4.3L	262 CID	Base,CL,LS,LT	22145
1987	V6-4.3L	262 CID	Exc.A/C; Base,CL,CS,LT	22153
1988-1989	V6-4.3L	262 CID	Exc.A/C; Base,CL,CS,LT	22153
1996-2005	V6-4.3L	262 CID	Base,LS,LT	22158
<b>AVALANCHE 1500</b>				
2002	V8-5.3L	323 CID	2WD (4WD) (Heavy Duty Heater); Base On Road Edition,Z71	22158
2003	V8-5.3L	323 CID	2WD (4WD) (Heavy Duty Heater); Base,North Face, On Road Edition,W/HB,Z71	22158
2004	V8-5.3L	323 CID	2WD (4WD) (Heavy Duty Heater); Base,Z66,Z71	22158
2005	V8-5.3L	323 CID	Base,LS,LT,Z66,Z71	22158
2006	V8-5.3L	325 CID	LS,LT,Z66,Z71	22158
<b>AVALANCHE 2500</b>				
2002-2004	V8-8.1L	496 CID	Base	22158
2005-2006	V8-8.1L	496 CID	LS,LT	22158
<b>BELAIR</b>				
1963-1965	L6-3.8L	230 CID		22016
1955-1962	L6-3.8L	235 CID		22016
1966-1969	L6-4.1L	250 CID		22016
1970-1973	L6-4.1L	250 CID		22049
1955-1957	V8-4.3L	265 CID		22016
1957-1967	V8-4.6L	283 CID		22016
1968	V8-5.0L	307 CID		22049

Years	Engine	Disp.	Application Description	USMW
1962-1969	V8-5.3L	327 CID		22016
1958-1961	V8-5.7L	348 CID		22016
1969	V8-5.7L	350 CID		22016
1970-1975	V8-5.7L	350 CID		22049
1965-1969	V8-6.5L	396 CID		22016
1970-1975	V8-6.6L	400 CID		22045
1971-1972	V8-6.6L	402 CID		22045
1962-1965	V8-6.7L	409 CID		22016
1966-1969	V8-7.0L	427 CID		22016
1970-1975	V8-7.4L	454 CID		22045
<b>BISCAYNE</b>				
1963-1965	L6-3.8L	230 CID		22016
1958-1962	L6-3.8L	235 CID		22016
1966-1968	L6-4.1L	250 CID		22016
1969-1972	L6-4.1L	250 CID		22049
1958-1967	V8-4.6L	283 CID		22016
1968	V8-5.0L	307 CID		22049
1962-1969	V8-5.3L	327 CID		22016
1958-1961	V8-5.7L	348 CID		22016
1969-1972	V8-5.7L	350 CID		22049
1965-1969	V8-6.5L	396 CID		22016
1970-1972	V8-6.6L	400 CID		22045
1971-1972	V8-6.6L	402 CID		22045
1962-1965	V8-6.7L	409 CID		22016
1966-1969	V8-7.0L	427 CID		22016
1970-1972	V8-7.4L	454 CID		22045
<b>BLAZER</b>				
1995	V6-4.3L	262 CID	Heavy Duty Heater; Base,LT	22153
2004	V6-4.3L	262 CID	LS,Xtreme,ZR2	22158
2005	V6-4.3L	262 CID	Base,ZR2	22158
1996	V6-4.3L	262 CID	Heavy Duty Heater; Base,LS,LT	22162
1997-1998	V6-4.3L	262 CID	Heavy Duty Heater; Base,LS,LT	22162
1999	V6-4.3L	262 CID	Heavy Duty Heater; Base,LS,LT,Trailblazer	22162
2000	V6-4.3L	262 CID	Heavy Duty Heater; LS,LT,Trailblazer	22162
2001	V6-4.3L	262 CID	Heavy Duty Heater; LS,LT,Trailblazer,Xtreme	22162
2002	V6-4.3L	262 CID	Heavy Duty Heater; LS,Xtreme	22162
2003	V6-4.3L	262 CID	Heavy Duty Heater; LS,Xtreme,ZR2	22162
1987	V8-5.0L	305 CID	Custom Deluxe,Silverado	22049
1987	V8-5.7L	350 CID	Custom Deluxe,Silverado	22049
1988	V8-5.7L	350 CID	Scottsdale,Silverado	22049
1989-1991	V8-5.7L	350 CID	Scottsdale,Silverado	22153
1992-1993	V8-5.7L	350 CID	Cheyenne,Silverado	22153
1994	V8-5.7L	350 CID	Base,Silverado,Silverado Sport	22153
1987	V8-6.2L	379 CID	Diesel; Custom Deluxe,Silverado	22052
1988-1991	V8-6.2L	379 CID	Diesel; Scottsdale,Silverado	22052
1994	V8-6.5L	395 CID	Diesel; Base,Silverado,Silverado Sport	22605
<b>BLAZER 2WD</b>				
1978-1979	L6-4.1L	250 CID		22043
1970-1977	L6-4.1L	250 CID		22049
1970-1971	L6-4.8L	292 CID		22049
1977-1979	V8-5.0L	305 CID		22045
1970-1973	V8-5.0L	307 CID		22045
1970-1979	V8-5.7L	350 CID		22045
1978	V8-7.4L	454 CID		22045
<b>BLAZER 4WD</b>				
1978-1979	L6-4.1L	250 CID		22043
1969-1977	L6-4.1L	250 CID		22049
1970-1973	L6-4.8L	292 CID		22049
1977-1979	V8-5.0L	305 CID		22045
1969-1973	V8-5.0L	307 CID		22045
1969-1979	V8-5.7L	350 CID		22045
1975-1979	V8-6.6L	400 CID		22045
1977	V8-7.4L	454 CID		22045
<b>BOSS TRUCK (MEX)</b>				
1996	V8-5.7L	350 CID		22145
<b>C10</b>				
1980	L6-4.1L	250 CID	Exc.A/C; Big Ten,Cheyenne,Custom Deluxe, Scottsdale,Silverado	22043
1981	L6-4.1L	250 CID	Exc.A/C; Custom,Custom,Deluxe	22043

Years	Engine	Disp.	Application Description	USMW
1982	L6-4.1L	250 CID	Exc.A/C; Custom,Scottsdale,Silverado	22043
1983	L6-4.1L	250 CID	Exc.A/C; Custom,Silverado	22043
1984	L6-4.1L	250 CID	Exc.A/C; Custom,Scottsdale,Silverado	22043
1980	L6-4.8L	292 CID	Big Ten,Cheyenne,Custom Deluxe,Scottsdale, Silverado	22043
1985-1986	V6-4.3L	262 CID	Custom,Scottsdale,Silverado	22049
1983	V8-5.0L	305 CID	Custom,Silverado	22045
1984	V8-5.0L	305 CID	Custom,Scottsdale,Silverado	22045
1980	V8-5.0L	305 CID	Big Ten,Cheyenne,Custom Deluxe,Scottsdale, Silverado	22049
1981	V8-5.0L	305 CID	Custom,Deluxe	22049
1982-1986	V8-5.0L	305 CID	Custom,Scottsdale,Silverado	22049
1980	V8-5.7L	350 CID	Diesel; Exc.A/C; Big Ten,Cheyenne,Custom Deluxe, Scottsdale,Silverado	22045
1981	V8-5.7L	350 CID	Diesel; Exc.A/C; Custom,Custom,Deluxe	22045
1982	V8-5.7L	350 CID	Exc.A/C; Custom,Custom,Scottsdale,Silverado	22045
1983	V8-5.7L	350 CID	Exc.A/C; Custom,Custom,Silverado	22045
1984	V8-5.7L	350 CID	A/C; Custom,Custom,Scottsdale,Silverado	22045
1985-1986	V8-5.7L	350 CID	Custom,Scottsdale,Silverado	22049
1983	V8-6.2L	379 CID	Diesel; Custom,Silverado	22052
1984-1986	V8-6.2L	379 CID	Diesel; Custom,Scottsdale,Silverado	22052
1982	V8-6.2L	379 CID	Diesel; Custom,Custom,Scottsdale,Silverado	22602
1980	V8-7.4L	454 CID	Big Ten,Cheyenne,Custom Deluxe,Scottsdale, Silverado	22045
<b>C10 (MEX)</b>				
1987	V8-5.7L	350 CID		22051
<b>C10 1/2 TON</b>				
1963-1966	L6-3.8L	230 CID		22049
1961-1962	L6-3.8L	235 CID		22049
1978-1979	L6-4.1L	250 CID		22043
1966-1977	L6-4.1L	250 CID		22049
1978-1979	L6-4.8L	292 CID		22043
1963-1977	L6-4.8L	292 CID		22049
1961-1967	V8-4.6L	283 CID		22049
1976-1979	V8-5.0L	305 CID		22045
1968-1973	V8-5.0L	307 CID		22045
1966-1968	V8-5.3L	327 CID		22049
1969-1979	V8-5.7L	350 CID		22045
1969	V8-6.5L	396 CID		22051
1976-1979	V8-6.6L	400 CID		22045
1970-1972	V8-6.6L	402 CID		22045
1973-1979	V8-7.4L	454 CID		22045
<b>C10 1/2 TON SUBURBAN</b>				
1963-1966	L6-3.8L	230 CID		22049
1961-1962	L6-3.8L	235 CID		22049
1978-1979	L6-4.1L	250 CID		22043
1966-1977	L6-4.1L	250 CID		22049
1963-1974	L6-4.8L	292 CID		22049
1961-1967	V8-4.6L	283 CID		22049
1976-1979	V8-5.0L	305 CID		22045
1968-1973	V8-5.0L	307 CID		22045
1966-1968	V8-5.3L	327 CID		22049
1969-1979	V8-5.7L	350 CID		22045
1969	V8-6.5L	396 CID		22051
1970-1972	V8-6.6L	402 CID		22045
1973-1979	V8-7.4L	454 CID		22045
<b>C10 SUBURBAN</b>				
1980	L6-4.1L	250 CID	Exc.A/C; Custom Deluxe,Custom Deluxe,Scottsdale, Silverado	22043
1980	V8-5.0L	305 CID	Custom Deluxe,Scottsdale,Silverado	22045
1981	V8-5.0L	305 CID	Custom,Deluxe	22045
1983	V8-5.0L	305 CID	Custom,Silverado	22045
1984	V8-5.0L	305 CID	Custom,Scottsdale,Silverado	22045
1982-1986	V8-5.0L	305 CID	Custom,Scottsdale,Silverado	22049
1980	V8-5.7L	350 CID	Diesel;Custom Deluxe,Scottsdale, Silverado	22045
1981	V8-5.7L	350 CID	Custom,Deluxe	22045
1982	V8-5.7L	350 CID	Exc.A/C; Custom,Scottsdale,Silverado	22045
1983	V8-5.7L	350 CID	Exc.A/C; Custom,Silverado	22045

Years	Engine	Disp.	Application Description	USMW
1984	V8-5.7L	350 CID	A/C; Custom,Custom,Scottsdale,Silverado	22045
1985-1986	V8-5.7L	350 CID	Custom,Scottsdale,Silverado	22049
1983	V8-6.2L	379 CID	Diesel; Custom,Silverado	22052
1984-1986	V8-6.2L	379 CID	Diesel; Custom,Scottsdale,Silverado	22052
1982	V8-6.2L	379 CID	Diesel; Towing Package; Custom,Custom,Scottsdale, Silverado	22602
1980	V8-7.4L	454 CID	Custom Deluxe,Scottsdale,Silverado	22045
<b>C1405 PANEL (MEX)</b>				
1965-1966	L6-4.8L	292 CID		22051
1965-1966	V8-4.7L	283 CID		22051
<b>C1500</b>				
1988-1989	V6-4.3L	262 CID	Cheyenne,Scottsdale,Silverado	22153
1990	V6-4.3L	262 CID	Cheyenne,Scottsdale,Silverado,WT	22153
1991-1993	V6-4.3L	262 CID	Cheyenne,Silverado,WT	22153
1994-1995	V6-4.3L	262 CID	Base,Cheyenne,Silverado,WT	22153
1996	V6-4.3L	262 CID	Exc.A/C; Base,Base,Cheyenne,Silverado,WT	22162
1997	V6-4.3L	262 CID	Exc.A/C; Base,Base,Cheyenne,Silverado,WT	22162
1998	V6-4.3L	262 CID	Exc.A/C; Cheyenne,Cheyenne,Silverado,WT	22162
1988-1989	V8-5.0L	305 CID	Cheyenne,Scottsdale,Silverado	22153
1990	V8-5.0L	305 CID	Cheyenne,Scottsdale,Silverado,WT	22153
1991-1993	V8-5.0L	305 CID	Cheyenne,Silverado,WT	22153
1994-1995	V8-5.0L	305 CID	Base,Cheyenne,Silverado,WT	22153
1999	V8-5.0L	305 CID	A/C (Towing Package); LS,LS	22158
1996	V8-5.0L	305 CID	Exc.A/C; Base,Base,Cheyenne,Silverado,WT	22162
1997	V8-5.0L	305 CID	Exc.A/C; Base,Base,Cheyenne,Silverado,WT	22162
1998	V8-5.0L	305 CID	Exc.A/C; Cheyenne,Cheyenne,Silverado,WT	22162
1988-1989	V8-5.7L	350 CID	Cheyenne,Scottsdale,Silverado	22153
1990	V8-5.7L	350 CID	Cheyenne,Scottsdale,Silverado,WT	22153
1991-1993	V8-5.7L	350 CID	Cheyenne,Silverado,WT	22153
1994-1995	V8-5.7L	350 CID	Base,Cheyenne,Silverado,WT	22153
1999	V8-5.7L	350 CID	A/C (Towing Package); LS,LS	22158
1996	V8-5.7L	350 CID	Exc.A/C; Base,Base,Cheyenne,Silverado,WT	22162
1997	V8-5.7L	350 CID	Exc.A/C; Base,Base,Cheyenne,Silverado,WT	22162
1998	V8-5.7L	350 CID	Exc.A/C; Cheyenne,Cheyenne,Silverado,WT	22162
1988-1989	V8-6.2L	379 CID	Diesel; Cheyenne,Scottsdale,Silverado	22154
1990	V8-6.2L	379 CID	Diesel; Cheyenne,Scottsdale,Silverado,WT	22154
1991-1993	V8-6.2L	379 CID	Diesel; Cheyenne,Silverado,WT	22154
1994-1996	V8-6.5L	395 CID	Diesel; Base,Cheyenne,Silverado,WT	22605
1997	V8-6.5L	395 CID	Diesel; Base,Cheyenne,Silverado,WT	22613
1998	V8-6.5L	395 CID	Diesel; Cheyenne,Silverado,WT	22613
1990	V8-7.4L	454 CID	454 SS,Cheyenne,Scottsdale,Silverado,WT	22145
1991-1993	V8-7.4L	454 CID	454 SS,Cheyenne,Silverado,WT	22145
<b>C1500 SUBURBAN</b>				
1992-1994	V8-5.7L	350 CID	Base,Silverado	22153
1995	V8-5.7L	350 CID	Base,LS,LT	22153
1996	V8-5.7L	350 CID	Exc.A/C; Base,LS,LT	22162
1997	V8-5.7L	350 CID	Exc.A/C; Base,LS,LT	22162
1998-1999	V8-5.7L	350 CID	Exc.A/C; Base,LS	22162
1995-1996	V8-6.5L	395 CID	Diesel; Base,LS,LT	22605
1997	V8-6.5L	395 CID	Diesel; Base,LS,LT	22613
1998	V8-6.5L	395 CID	Diesel; Base,LS	22613
1999	V8-6.5L	395 CID	Diesel; Screw-on (GDF); Base,Base,LS	22614
<b>C20</b>				
1980	L6-4.1L	250 CID	Exc.A/C; Cheyenne,Cheyenne,Custom Deluxe, Scottsdale,Silverado	22043
1981	L6-4.1L	250 CID	Exc.A/C; Custom,Deluxe	22043
1982	L6-4.1L	250 CID	Exc.A/C; Custom,Scottsdale,Silverado	22043
1983	L6-4.1L	250 CID	Exc.A/C; Custom,Silverado	22043
1984	L6-4.1L	250 CID	Exc.A/C; Custom,Scottsdale,Silverado	22043
1980	L6-4.8L	292 CID	Exc.A/C; Cheyenne,Custom Deluxe, Scottsdale,Silverado	22043
1981	L6-4.8L	292 CID	Exc.A/C; Custom,Custom,Deluxe	22043
1982	L6-4.8L	292 CID	Custom,Scottsdale,Silverado	22043
1983	L6-4.8L	292 CID	Custom,Silverado	22043
1984	L6-4.8L	292 CID	A/C; Custom,Custom,Scottsdale,Silverado	22045
1985-1986	L6-4.8L	292 CID	Custom,Scottsdale,Silverado	22045
1985-1986	V6-4.3L	262 CID	Custom,Scottsdale,Silverado	22049
1980	V8-5.0L	305 CID	Cheyenne,Custom Deluxe,Scottsdale,Silverado	22045
1981	V8-5.0L	305 CID	Custom,Deluxe	22045





# FAN CLUTCH APPLICATION GUIDE



Years	Engine	Disp.	Application Description	USMW
1983	V8-5.0L	305 CID	Custom,Silverado	22045
1984	V8-5.0L	305 CID	Custom,Scottsdale,Silverado	22045
1982-1986	V8-5.0L	305 CID	Custom,Scottsdale,Silverado	22049
1980	V8-5.7L	350 CID	Cheyenne,Custom Deluxe,Scottsdale,Silverado	22045
1981	V8-5.7L	350 CID	Custom,Deluxe	22045
1982	V8-5.7L	350 CID	Exc.A/C; Custom,Custom,Scottsdale,Silverado	22045
1983	V8-5.7L	350 CID	Exc.A/C; Custom,Custom,Silverado	22045
1984	V8-5.7L	350 CID	A/C; Custom,Custom,Scottsdale,Silverado	22045
1985-1986	V8-5.7L	350 CID	Custom,Scottsdale,Silverado	22045
1983	V8-6.2L	379 CID	Diesel; Custom,Silverado	22052
1984-1986	V8-6.2L	379 CID	Diesel; Custom,Scottsdale,Silverado	22052
1982	V8-6.2L	379 CID	Diesel; Custom,Custom,Scottsdale,Silverado	22602
1980	V8-7.4L	454 CID	Cheyenne,Custom Deluxe,Scottsdale,Silverado	22045
1981	V8-7.4L	454 CID	Custom,Deluxe	22045
1982	V8-7.4L	454 CID	Custom,Scottsdale,Silverado	22045
1983	V8-7.4L	454 CID	Custom,Silverado	22045
1984-1986	V8-7.4L	454 CID	Custom,Scottsdale,Silverado	22045
<b>C20 (MEX)</b>				
1987	V8-5.7L	350 CID		22051
<b>C20 3/4 TON</b>				
1963-1965	L6-3.8L	230 CID		22049
1961-1962	L6-3.8L	235 CID		22049
1978-1979	L6-4.1L	250 CID		22043
1966-1977	L6-4.1L	250 CID		22049
1978-1979	L6-4.8L	292 CID		22043
1963-1977	L6-4.8L	292 CID		22049
1961-1967	V8-4.6L	283 CID		22049
1976-1979	V8-5.0L	305 CID		22045
1968-1973	V8-5.0L	307 CID		22045
1966-1968	V8-5.3L	327 CID		22049
1969-1979	V8-5.7L	350 CID		22045
1969	V8-6.5L	396 CID		22045
1976-1979	V8-6.6L	400 CID		22045
1970-1972	V8-6.6L	402 CID		22045
1973-1979	V8-7.4L	454 CID		22045
<b>C20 SUBURBAN</b>				
1980	L6-4.8L	292 CID	Exc.A/C; Custom Deluxe,Custom Deluxe,Scottsdale,Silverado	22043
1981	L6-4.8L	292 CID	Exc.A/C; Custom,Custom,Deluxe	22043
1982	L6-4.8L	292 CID	Custom,Scottsdale,Silverado	22043
1983	V8-5.0L	305 CID	Custom,Silverado	22045
1984	V8-5.0L	305 CID	Custom,Scottsdale,Silverado	22045
1980	V8-5.0L	305 CID	Custom Deluxe,Scottsdale,Silverado	22049
1981	V8-5.0L	305 CID	Custom,Deluxe	22049
1982-1986	V8-5.0L	305 CID	Custom,Scottsdale,Silverado	22049
1980	V8-5.7L	350 CID	Custom Deluxe,Scottsdale,Silverado	22045
1981	V8-5.7L	350 CID	Custom,Deluxe	22045
1982	V8-5.7L	350 CID	Exc.A/C; Custom,Custom,Scottsdale,Silverado	22045
1983	V8-5.7L	350 CID	Exc.A/C; Custom,Custom,Silverado	22045
1984	V8-5.7L	350 CID	A/C; Custom,Custom,Scottsdale,Silverado	22045
1985-1986	V8-5.7L	350 CID	Custom,Scottsdale,Silverado	22049
1983	V8-6.2L	379 CID	Diesel; Custom,Silverado	22052
1984-1986	V8-6.2L	379 CID	Diesel; Custom,Scottsdale,Silverado	22052
1982	V8-6.2L	379 CID	Diesel; Custom,Scottsdale,Silverado	22602
1980	V8-7.4L	454 CID	Custom Deluxe,Scottsdale,Silverado	22045
1981	V8-7.4L	454 CID	Custom,Deluxe	22045
1982	V8-7.4L	454 CID	Custom,Scottsdale,Silverado	22045
1983	V8-7.4L	454 CID	Custom,Silverado	22045
1984-1986	V8-7.4L	454 CID	Custom,Scottsdale,Silverado	22045
<b>C20905 (MEX)</b>				
1965-1967	L6-4.8L	292 CID		22051
1965-1967	V8-4.7L	283 CID		22051
<b>C2500</b>				
1988-1990	V6-4.3L	262 CID	Cheyenne,Scottsdale,Silverado	22153
1991-1993	V6-4.3L	262 CID	Cheyenne,Silverado	22153
1994-1995	V6-4.3L	262 CID	Base,Cheyenne,Silverado,WT	22153
1988-1990	V8-5.0L	305 CID	Cheyenne,Scottsdale,Silverado	22153
1991-1993	V8-5.0L	305 CID	Cheyenne,Silverado	22153
1994-1995	V8-5.0L	305 CID	Base,Cheyenne,Silverado,WT	22153

Years	Engine	Disp.	Application Description	USMW
1996	V8-5.0L	305 CID	Exc.A/C; Base,Base,Cheyenne,Silverado,WT	22162
1997	V8-5.0L	305 CID	Exc.A/C; Base,Base,Cheyenne,Silverado,WT	22162
1998	V8-5.0L	305 CID	Exc.A/C; Cheyenne,Cheyenne,Silverado,WT	22162
1988-1990	V8-5.7L	350 CID	Cheyenne,Scottsdale,Silverado	22153
1991-1993	V8-5.7L	350 CID	Cheyenne,Silverado	22153
1994-1995	V8-5.7L	350 CID	Base,Cheyenne,Silverado,WT	22153
1996	V8-5.7L	350 CID	Exc.A/C; Base,Base,Cheyenne,Silverado,WT	22162
1997	V8-5.7L	350 CID	Exc.A/C; Base,Base,Cheyenne,Silverado,WT	22162
1998	V8-5.7L	350 CID	Exc.A/C; Cheyenne,Cheyenne,Silverado,WT	22162
1999-2000	V8-5.7L	350 CID	Exc.A/C; Base,Base,LS	22162
1988-1990	V8-6.2L	379 CID	Diesel; Cheyenne,Scottsdale,Silverado	22154
1991-1993	V8-6.2L	379 CID	Diesel; Cheyenne,Silverado	22154
1994-1996	V8-6.5L	395 CID	Diesel; Base,Cheyenne,Silverado,WT	22605
1992-1993	V8-6.5L	395 CID	Diesel; Cheyenne,Silverado	22606
1997	V8-6.5L	395 CID	Diesel; Base,Cheyenne,Silverado,WT	22613
1998	V8-6.5L	395 CID	Diesel; Cheyenne,Silverado,WT	22613
1999	V8-6.5L	395 CID	Diesel; Screw-on (GDF); Base,Base,LS	22614
2000	V8-6.5L	395 CID	Diesel; Base,LS	22614
1991-1993	V8-7.4L	454 CID	Cheyenne,Silverado	22145
1994-1997	V8-7.4L	454 CID	Base,Cheyenne,Silverado,WT	22145
1998	V8-7.4L	454 CID	Cheyenne,Silverado,WT	22145
1999-2000	V8-7.4L	454 CID	Base,LS	22145
<b>C2500 (MEX)</b>				
1988-1991	V8-5.7L	350 CID	A/C,;	22145
1998	V8-5.7L	350 CID		22145
<b>C2500 SUBURBAN</b>				
1992-1994	V8-5.7L	350 CID	Base,Silverado	22153
1995	V8-5.7L	350 CID	Base,LS,LT	22153
1996	V8-5.7L	350 CID	Exc.A/C; Base,Base,LS,LT	22162
1997	V8-5.7L	350 CID	Exc.A/C; Base,Base,LS,LT	22162
1998-1999	V8-5.7L	350 CID	Exc.A/C; Base,Base,LS	22162
1994	V8-6.5L	395 CID	Diesel; Base,Silverado	22605
1995-1996	V8-6.5L	395 CID	Diesel; Base,LS,LT	22605
1997	V8-6.5L	395 CID	Diesel; Base,LS,LT	22613
1998	V8-6.5L	395 CID	Diesel; Base,LS	22613
1999	V8-6.5L	395 CID	Diesel; Screw-on (GDF); Base,Base,LS	22614
1992-1994	V8-7.4L	454 CID	Base,Silverado	22145
1995-1997	V8-7.4L	454 CID	Base,LS,LT	22145
1998-1999	V8-7.4L	454 CID	Base,LS	22145
<b>C30</b>				
1980	L6-4.1L	250 CID	Exc.A/C; Cheyenne,Cheyenne,Custom Deluxe,Scottsdale,Silverado	22043
1980	L6-4.8L	292 CID	Exc.A/C; Cheyenne,Cheyenne,Custom Deluxe,Scottsdale,Silverado	22043
1981	L6-4.8L	292 CID	Exc.A/C; Custom,Custom,Deluxe	22043
1982	L6-4.8L	292 CID	Custom,Scottsdale,Silverado	22043
1983	L6-4.8L	292 CID	Custom,Silverado	22043
1984	L6-4.8L	292 CID	A/C; Custom,Custom,Scottsdale,Silverado	22045
1985-1986	L6-4.8L	292 CID	Custom,Scottsdale,Silverado	22045
1986	V8-5.0L	305 CID	Custom,Scottsdale,Silverado	22049
1980	V8-5.7L	350 CID	Cheyenne,Custom Deluxe,Scottsdale,Silverado	22045
1981	V8-5.7L	350 CID	Custom,Deluxe	22045
1982	V8-5.7L	350 CID	Custom,Scottsdale,Silverado	22045
1983	V8-5.7L	350 CID	Exc.A/C; Custom,Custom,Silverado	22045
1984	V8-5.7L	350 CID	Custom,Scottsdale,Silverado	22045
1985-1986	V8-5.7L	350 CID	Custom,Scottsdale,Silverado	22049
1983	V8-6.2L	379 CID	Diesel; Custom,Silverado	22052
1984-1986	V8-6.2L	379 CID	Diesel; Custom,Scottsdale,Silverado	22052
1982	V8-6.2L	379 CID	Diesel; Custom,Scottsdale,Silverado	22602
1980	V8-7.4L	454 CID	Cheyenne,Custom Deluxe,Scottsdale,Silverado	22045
1981	V8-7.4L	454 CID	Custom,Deluxe	22045
1982	V8-7.4L	454 CID	Custom,Scottsdale,Silverado	22045
1983	V8-7.4L	454 CID	Custom,Silverado	22045
1984-1986	V8-7.4L	454 CID	Custom,Scottsdale,Silverado	22045
<b>C30 (MEX)</b>				
1987	V8-5.7L	350 CID		22051
<b>C30 1 TON</b>				
1964-1965	L6-3.8L	230 CID		22049
1961-1962	L6-3.8L	235 CID		22049



Years	Engine	Disp.	Application Description	USMW
1968-1979	L6-4.1L	250 CID		22045
1966-1967	L6-4.1L	250 CID		22049
1968-1979	L6-4.8L	292 CID		22045
1963-1967	L6-4.8L	292 CID		22049
1961-1967	V8-4.6L	283 CID		22049
1978-1979	V8-5.0L	305 CID		22045
1968-1973	V8-5.0L	307 CID		22045
1966-1968	V8-5.3L	327 CID		22049
1969-1979	V8-5.7L	350 CID		22045
1978	V8-5.7L	350 CID		22049
1969	V8-6.5L	396 CID		22045
1976-1979	V8-6.6L	400 CID		22045
1970-1972	V8-6.6L	402 CID		22045
1973-1979	V8-7.4L	454 CID		22045
<b>C3500</b>				
1988-1990	V8-5.7L	350 CID	Cheyenne,Scottsdale,Silverado	22153
1991-1993	V8-5.7L	350 CID	Cheyenne,Silverado	22153
1994-1995	V8-5.7L	350 CID	Base,Cheyenne,Silverado	22153
1996	V8-5.7L	350 CID	Exc.A/C; Base,Base,Cheyenne,Silverado	22162
1997	V8-5.7L	350 CID	Exc.A/C; Base,Base,Cheyenne,Silverado	22162
1998	V8-5.7L	350 CID	Exc.A/C; Cheyenne,Cheyenne,Silverado	22162
1999-2000	V8-5.7L	350 CID	Exc.A/C; Base,Base,LS	22162
1988-1990	V8-6.2L	379 CID	Diesel; Cheyenne,Scottsdale,Silverado	22154
1991-1993	V8-6.2L	379 CID	Diesel; Cheyenne,Silverado	22154
1994-1996	V8-6.5L	395 CID	Diesel; Base,Cheyenne,Silverado	22605
1992-1993	V8-6.5L	395 CID	Diesel; Cheyenne,Silverado	22606
1997	V8-6.5L	395 CID	Diesel; Base,Cheyenne,Silverado	22613
1998	V8-6.5L	395 CID	Diesel; Cheyenne,Silverado	22613
1999	V8-6.5L	395 CID	Diesel; Screw-on (GDF); Base,Base,LS	22614
2000	V8-6.5L	395 CID	Diesel; Base,LS	22614
1988-1990	V8-7.4L	454 CID	Cheyenne,Scottsdale,Silverado	22145
1991-1993	V8-7.4L	454 CID	Cheyenne,Silverado	22145
1994-1997	V8-7.4L	454 CID	Base,Cheyenne,Silverado	22145
1998	V8-7.4L	454 CID	Cheyenne,Silverado	22145
1999-2000	V8-7.4L	454 CID	Base,LS	22145
<b>C3605 (MEX)</b>				
1967	L6-4.8L	292 CID		22051
1967	V8-4.7L	283 CID		22051
<b>CAMARO</b>				
1982	L4-2.5L	151 CID	A/C (Exc.Heavy Duty Cooling); Sport,Sport	22049
1983-1986	L4-2.5L	151 CID	A/C; Sport	22049
1967-1969	L6-3.8L	230 CID		22049
1967-1979	L6-4.1L	250 CID		22049
1982-1984	V6-2.8L	173 CID	Berlinetta,Sport	22049
1980	V6-3.8L	229 CID	Base,Berlinetta,Rally Sport	22045
1981	V6-3.8L	229 CID	Berlinetta,Sport	22045
1980	V6-3.8L	231 CID	Base,Berlinetta,Rally Sport	22043
1981	V6-3.8L	231 CID	Exc.A/C; Berlinetta,Berlinetta,Sport	22049
1980	V8-4.4L	267 CID	Base,Berlinetta,Rally Sport	22045
1981	V8-4.4L	267 CID	Berlinetta,Sport	22045
1967-1969	V8-4.9L	302 CID		22049
1980	V8-5.0L	305 CID	Base,Berlinetta,Rally Sport,Z28	22045
1981	V8-5.0L	305 CID	Berlinetta,Sport,Z28	22045
1976-1979	V8-5.0L	305 CID		22049
1982	V8-5.0L	305 CID	Exc.A/C; Berlinetta,Berlinetta,Sport,Z28, Z28 Indianapolis 500 Pace Car	22049
1983	V8-5.0L	305 CID	Exc.A/C; Berlinetta,Sport,Z28	22049
1984	V8-5.0L	305 CID	Berlinetta,Sport,Z28	22049
1985	V8-5.0L	305 CID	Berlinetta,Sport,Z28,Z28 Iroc-Z	22049
1969-1973	V8-5.0L	307 CID		22049
1967-1969	V8-5.3L	327 CID		22049
1980	V8-5.7L	350 CID	Base,Berlinetta,Rally Sport,Z28	22045
1981	V8-5.7L	350 CID	Berlinetta,Sport,Z28	22045
1967-1979	V8-5.7L	350 CID		22049
1967-1970	V8-6.5L	396 CID		22049
1970	V8-6.6L	400 CID		22049
1971-1972	V8-6.6L	402 CID		22049
1969	V8-7.0L	427 CID		22049

Years	Engine	Disp.	Application Description	USMW
<b>CAPRICE</b>				
1977-1979	L6-4.1L	250 CID		22049
1980	V6-3.8L	229 CID	Classic,Classic Landau,Classic Sport	22043
1981	V6-3.8L	229 CID	Classic,Classic Estate,Classic Landau	22043
1982	V6-3.8L	229 CID	Classic,Classic Estate	22049
1983-1984	V6-3.8L	229 CID	Classic	22049
1982	V6-3.8L	231 CID	Classic,Classic Estate	22043
1983-1984	V6-3.8L	231 CID	Classic	22043
1980	V6-3.8L	231 CID	Classic,Classic Landau,Classic Sport	22049
1981	V6-3.8L	231 CID	Classic,Classic Estate,Classic Landau	22049
1985	V6-4.3L	262 CID	Exc.A/C; Classic,Classic	22049
1986	V6-4.3L	262 CID	Exc.A/C; Base,Base,Classic,Classic Brougham	22049
1987	V6-4.3L	262 CID	Base,Classic,Classic Brougham,Classic LS Brougham	22049
1988	V6-4.3L	262 CID	Base,Classic,Classic Brougham	22049
1989-1990	V6-4.3L	262 CID	Base,Classic	22145
1992	V6-4.3L	262 CID	Base	22145
1993	V6-4.3L	262 CID	Classic	22145
1994	V8-4.3L	265 CID	Classic,Classic LS	22045
1995-1996	V8-4.3L	265 CID	Classic	22045
1980	V8-4.4L	267 CID	Classic,Classic Landau,Classic Sport	22043
1981	V8-4.4L	267 CID	Classic,Classic Estate,Classic Landau	22043
1982	V8-4.4L	267 CID	Exc.A/C; Classic,Classic,Classic Estate	22049
1966-1967	V8-4.6L	283 CID		22011
1978-1979	V8-5.0L	305 CID		22043
1980	V8-5.0L	305 CID	Classic,Classic Landau,Classic Sport	22045
1981	V8-5.0L	305 CID	Classic,Classic Estate,Classic Landau	22045
1977	V8-5.0L	305 CID		22049
1982	V8-5.0L	305 CID	Exc.A/C; Classic,Classic,Classic Estate	22049
1983-1984	V8-5.0L	305 CID	Exc.A/C; Classic,Classic	22049
1985	V8-5.0L	305 CID	A/C (Exc.Heavy Duty Cooling); Classic,Classic	22049
1986	V8-5.0L	305 CID	Exc.A/C; Base,Base,Classic,Classic Brougham	22049
1987-1988	V8-5.0L	305 CID	Exc.Heavy Duty Cooling; Base,Base,Classic, Classic Brougham,Classic LS Brougham	22049
1989-1990	V8-5.0L	305 CID	Base,Classic,Classic Brougham,Classic LS Brougham	22145
1991-1992	V8-5.0L	305 CID	Base,Classic,Classic LTZ	22145
1993	V8-5.0L	305 CID	Classic,Classic LS	22145
1968	V8-5.0L	307 CID		22049
1986	V8-5.0L	307 CID	Classic,Classic Brougham	22049
1987	V8-5.0L	307 CID	Base,Classic	22049
1988-1990	V8-5.0L	307 CID	Classic	22049
1966	V8-5.3L	327 CID		22016
1967-1969	V8-5.3L	327 CID		22049
1978-1979	V8-5.7L	350 CID		22043
1994	V8-5.7L	350 CID	Classic,Classic LS	22045
1995-1996	V8-5.7L	350 CID	Classic	22045
1969-1977	V8-5.7L	350 CID		22049
1980	V8-5.7L	350 CID	Diesel; Exc.Heavy Duty Cooling; Classic,Classic, Classic Landau,Classic Sport	22049
1981	V8-5.7L	350 CID	Diesel; Exc.Heavy Duty Cooling; Classic,Classic, Classic Estate,Classic Landau	22049
1982	V8-5.7L	350 CID	Diesel; Exc.Heavy Duty Cooling; Classic,Classic, Classic Estate	22049
1983-1985	V8-5.7L	350 CID	Diesel; Exc.Heavy Duty Cooling; Classic,Classic	22049
1989-1990	V8-5.7L	350 CID	Base	22145
1991-1992	V8-5.7L	350 CID	Base,Classic,Classic LTZ	22145
1993	V8-5.7L	350 CID	Classic LTZ	22145
1966-1968	V8-6.5L	396 CID		22011
1969	V8-6.5L	396 CID		22045
1970-1976	V8-6.6L	400 CID		22049
1971-1972	V8-6.6L	402 CID		22049
1966-1968	V8-7.0L	427 CID		22011
1969	V8-7.0L	427 CID		22049
1970-1976	V8-7.4L	454 CID		22049
<b>CAPRICE ESTATE WAGON</b>				
1977	V8-5.0L	305 CID		22049
1973-1977	V8-5.7L	350 CID		22049
1973-1976	V8-6.6L	400 CID		22049
1973-1976	V8-7.4L	454 CID		22049

**FAN CLUTCHES**

Years	Engine	Disp.	Application Description	USMW
<b>CHEVELLE</b>				
1964-1969	L6-3.8L	230 CID		22049
1967-1968	L6-4.1L	250 CID		22011
1969-1973	L6-4.1L	250 CID		22049
1966	V6-3.8L	230 CID		22049
1967	V8-4.1L	250 CID		22011
1964-1967	V8-4.6L	283 CID		22011
1968-1973	V8-5.0L	307 CID		22049
1965-1967	V8-5.3L	327 CID		22011
1964-1966	V8-5.3L	327 CID		22016
1968	V8-5.3L	327 CID		22049
1969-1973	V8-5.7L	350 CID		22049
1965-1968	V8-6.5L	396 CID		22011
1969	V8-6.5L	396 CID		22049
1970	V8-6.6L	400 CID		22049
1970-1972	V8-6.6L	402 CID		22049
1970-1973	V8-7.4L	454 CID		22049
<b>CHEVELLE MALIBU</b>				
1974-1976	L6-4.1L	250 CID		22049
1976	V8-5.0L	305 CID		22049
1974-1976	V8-5.7L	350 CID		22049
1974-1976	V8-6.6L	400 CID		22049
1974-1975	V8-7.4L	454 CID		22049
<b>CHEVELLE MALIBU ESTATE WAGON</b>				
1976	V8-5.7L	350 CID		22049
1976	V8-6.6L	400 CID		22049
<b>CHEVETTE</b>				
1976-1977	L4-1.4L	85 CID		22013
1976-1979	L4-1.6L	98 CID		22013
1980-1982	L4-1.6L	98 CID	A/C; Base, Scooter	22013
1983	L4-1.6L	98 CID	A/C; Base, S, Scooter	22013
1984-1985	L4-1.6L	98 CID	A/C; Base, CS	22013
1986-1987	L4-1.6L	98 CID	A/C; CS	22013
1981	L4-1.8L	110 CID	Diesel; Base	22049
1982	L4-1.8L	110 CID	Diesel; Base, Diesel	22049
1983	L4-1.8L	110 CID	Diesel; Base, S	22049
1984-1985	L4-1.8L	110 CID	Diesel; Base, CS	22049
1986	L4-1.8L	110 CID	Diesel; CS	22049
<b>CHEVY II</b>				
1964-1966	L6-3.8L	230 CID		22016
1967	L6-4.1L	250 CID		22011
1964-1967	V8-4.6L	283 CID		22011
1965-1967	V8-5.3L	327 CID		22016
<b>COLORADO</b>				
2004	L4-2.8L	169 CID	Base, LS, Sport, Sport LS, Z71, Z71 LS, Z85, Z85 LS	22023
2005	L4-2.8L	169 CID	Sport, Sport LS, Z71, Z71 LS, Z85, Z85 LS	22023
2006	L4-2.8L	169 CID	LS, LT, WT	22023
2007-2008	L4-2.9L	178 CID	LS, LT, WT	22023
2009-2012	L4-2.9L	178 CID	LT, WT	22023
2004	L5-3.5L	211 CID	Base, LS, Sport, Sport LS, Z71, Z71 LS, Z85, Z85 LS	22173
2005	L5-3.5L	211 CID	Sport, Sport LS, Z71, Z71 LS, Z85, Z85 LS	22173
2006	L5-3.5L	211 CID	LT, WT	22173
2007	L5-3.7L	223 CID	LS, LT	22173
2008	L5-3.7L	223 CID	LS, LT, WT	22173
2009-2012	L5-3.7L	223 CID	LT, WT	22173
2009-2012	V8-5.3L	325 CID	LT	22615
<b>CORVETTE</b>				
1956	V8-4.3L	265 CID		22012
1960-1961	V8-4.6L	283 CID		22012
1957-1959	V8-4.6L	283 CID		22038
1980	V8-5.0L	305 CID	Base	22037
1962-1968	V8-5.3L	327 CID		22038
1969-1979	V8-5.7L	350 CID		22012
1980-1981	V8-5.7L	350 CID	Base	22037
1982	V8-5.7L	350 CID	Base, Collector's Edition	22037
1965	V8-6.5L	396 CID		22016
1966-1969	V8-7.0L	427 CID		22012
1970-1974	V8-7.4L	454 CID		22052

Years	Engine	Disp.	Application Description	USMW
<b>CS1073 (MEX)</b>				
1966-1978	L6-4.1L	250 CID		22051
1964-1978	L6-4.8L	292 CID		22051
1964-1967	V8-4.7L	283 CID		22051
1964-1969	V8-5.4L	327 CID		22051
<b>CS31003 (MEX)</b>				
1964-1978	L6-4.8L	292 CID		22051
1964-1967	V8-4.7L	283 CID		22051
1964-1969	V8-5.4L	327 CID		22051
1968-1978	V8-5.7L	350 CID		22051
<b>DELRAY</b>				
1958	V8-4.6L	283 CID		22049
1958	V8-5.7L	348 CID		22016
<b>EL CAMINO</b>				
1964-1969	L6-3.8L	230 CID		22049
1968	L6-4.1L	250 CID		22011
1967-1977	L6-4.1L	250 CID		22049
1978-1979	V6-3.3L	200 CID		22043
1980	V6-3.8L	229 CID	Base, Royal Knight	22049
1981	V6-3.8L	229 CID	Base, Conquista, Royal Knight	22049
1982	V6-3.8L	229 CID	Base, Conquista	22049
1983	V6-3.8L	229 CID	Conquista, SS	22049
1984	V6-3.8L	229 CID	Base, Conquista, SS	22049
1978-1979	V6-3.8L	231 CID		22043
1980	V6-3.8L	231 CID	Base, Royal Knight, SS	22049
1981	V6-3.8L	231 CID	Base, Conquista, Royal Knight, SS	22049
1982-1984	V6-3.8L	231 CID	Base, Conquista, SS	22049
1985-1986	V6-4.3L	262 CID	Base, Conquista, SS	22049
1987	V6-4.3L	262 CID	Base, SS	22049
1979	V8-4.4L	267 CID		22043
1980	V8-4.4L	267 CID	Base, Royal Knight, SS	22049
1981	V8-4.4L	267 CID	Base, Conquista, Royal Knight, SS	22049
1982	V8-4.4L	267 CID	Base, Conquista, SS	22049
1959-1967	V8-4.6L	283 CID		22011
1978-1979	V8-5.0L	305 CID		22043
1976-1977	V8-5.0L	305 CID		22049
1980	V8-5.0L	305 CID	Base, Royal Knight, SS	22049
1981	V8-5.0L	305 CID	Base, Conquista, Royal Knight, SS	22049
1982-1986	V8-5.0L	305 CID	Base, Conquista, SS	22049
1987	V8-5.0L	305 CID	Base, SS	22049
1968-1973	V8-5.0L	307 CID		22049
1968	V8-5.3L	327 CID		22011
1964-1967	V8-5.3L	327 CID		22016
1959-1960	V8-5.7L	348 CID		22011
1978-1979	V8-5.7L	350 CID		22043
1969-1977	V8-5.7L	350 CID		22049
1983-1984	V8-5.7L	350 CID	Diesel; Exc. Heavy Duty Cooling; Base, Base, Conquista, SS	22049
1966-1968	V8-6.5L	396 CID		22011
1969-1970	V8-6.5L	396 CID		22049
1970-1976	V8-6.6L	400 CID		22049
1972	V8-6.6L	402 CID		22049
1970-1975	V8-7.4L	454 CID		22049
<b>EXPRESS 1500</b>				
2003-2005	V6-4.3L	262 CID	Exc. A/C; Base, Base, LS	22158
2006	V6-4.3L	262 CID	Exc. A/C; Base, Base, LS, LT	22158
2007-2012	V6-4.3L	262 CID	Exc. A/C; Base, Base	22158
1996-2002	V6-4.3L	262 CID	Exc. A/C; Base, Base, LS	22162
1996-2002	V8-5.0L	305 CID	Exc. A/C; Base, Base, LS	22162
2003-2005	V8-5.3L	323 CID	Exc. A/C; Base, Base, LS	22158
2006	V8-5.3L	325 CID	Exc. A/C; Base, Base, LS, LT	22158
2007	V8-5.3L	325 CID	Exc. A/C; LS, LS, LT	22158
2008-2012	V8-5.3L	325 CID	Exc. A/C; Base, Base, LS, LT	22158
1996-2002	V8-5.7L	350 CID	Exc. A/C; Base, Base, LS	22162
<b>EXPRESS 2500</b>				
2003-2005	V6-4.3L	262 CID	Exc. A/C; Base, Base, LS	22158
1996-2002	V6-4.3L	262 CID	Exc. A/C; Base, Base, LS	22162
2003-2005	V8-4.8L	294 CID	Exc. A/C; Base, Base, LS	22158

Years	Engine	Disp.	Application Description	USMW
2006-2012	V8-4.8L	294 CID	Exc.A/C; Base,Base	22158
1996-2002	V8-5.0L	305 CID	Exc.A/C; Base,Base,LS	22162
2003-2005	V8-5.3L	323 CID	Exc.A/C; Base,Base,LS	22158
1996-2002	V8-5.7L	350 CID	Exc.A/C; Base,Base,LS	22162
2003-2005	V8-6.0L	364 CID	Exc.A/C; Base,Base,LS	22158
2006	V8-6.0L	364 CID	Exc.A/C; Base,Base	22158
2007-2010	V8-6.0L	364 CID	Exc.A/C; Base,Base,LS,LT	22158
2011	V8-6.0L	364 CID	Exc.A/C; Base,Base,LS,LT	22158
2012	V8-6.0L	364 CID	Exc.A/C; Base,Base,LS,LT	22158
1996	V8-6.5L	395 CID	Diesel; LS	22605
1997-1998	V8-6.5L	395 CID	Diesel; Base,LS	22613
1999-2002	V8-6.5L	395 CID	Diesel; Base,LS	22614
2009-2012	V8-6.6L	400 CID	Diesel; Base	22341
2006-2008	V8-6.6L	400 CID	Diesel; Base	22617
<b>EXPRESS 3500</b>				
2005	V8-4.8L	294 CID	Exc.A/C; Base,Base,LS	22158
2006-2012	V8-4.8L	294 CID	Exc.A/C; Base,Base	22158
1996-2002	V8-5.7L	350 CID	Exc.A/C; Base,Base,LS	22162
2003-2005	V8-6.0L	364 CID	Exc.A/C; Base,Base,LS	22158
2006-2012	V8-6.0L	364 CID	Exc.A/C; Base,Base,LS,LT	22158
1996	V8-6.5L	395 CID	Diesel; Base,LS	22605
1997-1998	V8-6.5L	395 CID	Diesel; Base,LS	22613
1999-2002	V8-6.5L	395 CID	Diesel; Base,LS	22614
2009-2012	V8-6.6L	400 CID	Diesel; Base	22341
2006-2008	V8-6.6L	400 CID	Diesel; Base	22617
1996-2000	V8-7.4L	454 CID	Base,LS	22145
2001-2002	V8-8.1L	496 CID	Base,LS	22158
<b>EXPRESS 4500</b>				
2009-2012	V8-6.0L	364 CID	Exc.A/C; Base,Base	22158
2009-2012	V8-6.6L	400 CID	Diesel; Base	22341
<b>G10</b>				
1980-1981	L6-4.1L	250 CID	Beauville,Chevy Van,Sportvan	22049
1982	L6-4.1L	250 CID	A/C (Heavy Duty Cooling); Beauville,Beauville, Chevy Van,Sportvan	22049
1983	L6-4.1L	250 CID	A/C (Heavy Duty Cooling); Base,Base,Beauville,Bonaventure,Chevy Van,Sportvan	22049
1984	L6-4.1L	250 CID	A/C (Heavy Duty Cooling); Beauville,Beauville, Bonaventure,Chevy Van,Sportvan	22049
1985-1986	V6-4.3L	262 CID	Beauville,Chevy Van,Sportvan	22026
1987-1995	V6-4.3L	262 CID	Beauville,Chevy Van,Sportvan	22153
1983	V8-5.0L	305 CID	Base,Beauville,Bonaventure,Chevy Van	22026
1984	V8-5.0L	305 CID	Beauville,Bonaventure,Chevy Van,Sportvan	22026
1985-1986	V8-5.0L	305 CID	Beauville,Chevy Van,Sportvan	22026
1981	V8-5.0L	305 CID	Beauville,Sportvan	22043
1980	V8-5.0L	305 CID	Beauville,Chevy Van,Sportvan	22045
1982	V8-5.0L	305 CID	Beauville,Chevy Van,Sportvan	22049
1987-1995	V8-5.0L	305 CID	Beauville,Chevy Van,Sportvan	22153
1980	V8-5.7L	350 CID	Beauville,Chevy Van,Sportvan	22026
1981-1986	V8-5.7L	350 CID	Sportvan	22026
1987-1993	V8-5.7L	350 CID	Sportvan	22153
<b>G10 1/2 TON VAN</b>				
1966-1969	L6-3.8L	230 CID		22049
1967-1979	L6-4.1L	250 CID		22049
1977-1979	V8-5.0L	305 CID		22049
1973	V8-5.0L	307 CID		22045
1968-1972	V8-5.0L	307 CID		22049
1970-1979	V8-5.7L	350 CID		22049
1973-1974	V8-7.4L	454 CID		22045
<b>G20</b>				
1980-1981	L6-4.1L	250 CID	Beauville,Chevy Van,Sportvan	22049
1982	L6-4.1L	250 CID	A/C (Heavy Duty Cooling); Beauville,Beauville, Chevy Van,Sportvan	22049
1983-1984	L6-4.1L	250 CID	A/C (Heavy Duty Cooling); Beauville,Beauville, Bonaventure,Chevy Van,Sportvan	22049
1985-1986	V6-4.3L	262 CID	Beauville,Chevy Van,Sportvan	22026
1987-1995	V6-4.3L	262 CID	Beauville,Chevy Van,Sportvan	22153
1981	V8-5.0L	305 CID	Beauville,Chevy Van,Sportvan	22026
1984	V8-5.0L	305 CID	Beauville,Bonaventure,Chevy Van,Sportvan	22026
1985-1986	V8-5.0L	305 CID	Beauville,Chevy Van,Sportvan	22026

Years	Engine	Disp.	Application Description	USMW
1980	V8-5.0L	305 CID	Beauville,Chevy Van	22045
1982	V8-5.0L	305 CID	Beauville,Chevy Van,Sportvan	22049
1983	V8-5.0L	305 CID	Beauville,Bonaventure,Chevy Van,Sportvan	22049
1987-1995	V8-5.0L	305 CID	Beauville,Chevy Van,Sportvan	22153
1980-1982	V8-5.7L	350 CID	Beauville,Chevy Van,Sportvan	22026
1983	V8-5.7L	350 CID	Sportvan	22026
1984	V8-5.7L	350 CID	Beauville,Bonaventure,Chevy Van,Sportvan	22026
1985-1986	V8-5.7L	350 CID	Beauville,Chevy Van,Sportvan	22026
1987	V8-5.7L	350 CID	Beauville,Chevy Van,Sportvan	22142
1988-1995	V8-5.7L	350 CID	Beauville,Chevy Van,Sportvan	22153
1983	V8-6.2L	379 CID	Diesel; Beauville,Bonaventure,Chevy Van,Sportvan	22052
1984	V8-6.2L	379 CID	Diesel; Beauville,Beauville,Bonaventure,Chevy Van, Sportvan	22052
1985-1993	V8-6.2L	379 CID	Diesel; Beauville,Chevy Van,Sportvan	22052
1994-1995	V8-6.5L	395 CID	Diesel; Beauville,Chevy Van,Sportvan	22154
1980	V8-6.6L	400 CID	Beauville,Chevy Van,Sportvan	22045
<b>G20 3/4 TON VAN</b>				
1967-1969	L6-3.8L	230 CID		22049
1968-1979	L6-4.1L	250 CID		22049
1974-1980	L6-4.8L	292 CID		22043
1977-1978	V8-5.0L	305 CID	Sportvan model	22045
1979	V8-5.0L	305 CID		22049
1968-1971	V8-5.0L	307 CID		22049
1970-1979	V8-5.7L	350 CID		22049
1975-1979	V8-6.6L	400 CID	Sportvan model	22045
1973-1974	V8-7.4L	454 CID		22045
<b>G30</b>				
1981	L6-4.1L	250 CID	Beauville,Chevy Van,Hi-Cube	22049
1982	L6-4.1L	250 CID	A/C (Heavy Duty Cooling); Beauville,Beauville, Chevy Van,Hi-Cube	22049
1983-1984	L6-4.1L	250 CID	A/C (Heavy Duty Cooling); Beauville,Beauville, Bonaventure,Chevy Van,Hi-Cube	22049
1985-1986	V6-4.3L	262 CID	Beauville,Chevy Van,Hi-Cube	22026
1987-1995	V6-4.3L	262 CID	Beauville,Chevy Van,Hi-Cube	22153
1982-1985	V8-5.0L	305 CID	Beauville,Chevy Van,Hi-Cube	22026
1980-1982	V8-5.7L	350 CID	Beauville,Chevy Van,Hi-Cube,Sportvan	22026
1983-1984	V8-5.7L	350 CID	Beauville,Bonaventure,Chevy Van,Hi-Cube,Sportvan	22026
1985-1986	V8-5.7L	350 CID	Beauville,Chevy Van,Hi-Cube,Sportvan	22026
1987-1996	V8-5.7L	350 CID	Beauville,Chevy Van,Hi-Cube,Sportvan	22153
1983	V8-6.2L	379 CID	Diesel; Beauville,Bonaventure,Chevy Van,Hi-Cube, Sportvan	22052
1984	V8-6.2L	379 CID	Diesel; Exc.A/C; Beauville,Beauville,Bonaventure, Chevy Van,Hi-Cube,Sportvan	22052
1985-1993	V8-6.2L	379 CID	Diesel; Beauville,Chevy Van,Hi-Cube,Sportvan	22052
1994-1996	V8-6.5L	395 CID	Diesel; Beauville,Chevy Van,Hi-Cube,Sportvan	22154
1980	V8-6.6L	400 CID	Beauville,Chevy Van,Hi-Cube,Sportvan	22045
1988-1996	V8-7.4L	454 CID	Beauville,Chevy Van,Hi-Cube,Sportvan	22145
<b>G30 1 TON VAN</b>				
1971-1979	L6-4.1L	250 CID		22049
1974-1979	L6-4.8L	292 CID		22043
1978-1979	V8-5.0L	305 CID		22045
1971-1979	V8-5.7L	350 CID		22049
1975-1979	V8-6.6L	400 CID		22045
1974	V8-7.4L	454 CID		22045
<b>IMPALA</b>				
1963-1964	L6-3.8L	230 CID		22016
1965	L6-3.8L	230 CID		22038
1966-1968	L6-4.1L	250 CID		22011
1969-1979	L6-4.1L	250 CID		22049
1980	V6-3.8L	229 CID	Base,Sport	22043
1981	V6-3.8L	229 CID	Base,Estate	22049
1982	V6-3.8L	229 CID	Exc.Heavy Duty Cooling; Base,Base,Estate	22049
1983-1984	V6-3.8L	229 CID	Exc.Heavy Duty Cooling; Base,Base	22049
1980	V6-3.8L	231 CID	Base,Sport	22049
1981-1982	V6-3.8L	231 CID	Base,Estate	22049
1983-1984	V6-3.8L	231 CID	Base	22049
1985	V6-4.3L	262 CID	Exc.A/C; Base,Base	22049
1980	V8-4.4L	267 CID	Base,Sport	22043
1981	V8-4.4L	267 CID	Base,Estate	22043

**FAN CLUTCHES**



Years	Engine	Disp.	Application Description	USMW
1982	V8-4.4L	267 CID	Exc.Heavy Duty Cooling; Base,Base,Estate	22049
1959-1967	V8-4.6L	283 CID		22011
1978-1979	V8-5.0L	305 CID		22043
1980	V8-5.0L	305 CID	Base,Sport	22045
1981	V8-5.0L	305 CID	Base,Estate	22045
1977	V8-5.0L	305 CID		22049
1982	V8-5.0L	305 CID	Exc.Heavy Duty Cooling; Base,Base,Estate	22049
1983-1985	V8-5.0L	305 CID	Exc.Heavy Duty Cooling; Base,Base	22049
1968	V8-5.0L	307 CID		22049
1964-1967	V8-5.3L	327 CID		22011
1962-1969	V8-5.3L	327 CID		22016
1959-1961	V8-5.7L	348 CID		22011
1978-1979	V8-5.7L	350 CID		22043
1970-1976	V8-5.7L	350 CID		22045
1981	V8-5.7L	350 CID	Diesel; Heavy Duty Cooling; Base,Base,Estate	22045
1994-1996	V8-5.7L	350 CID	SS	22045
1969-1977	V8-5.7L	350 CID		22049
1980	V8-5.7L	350 CID	Diesel; Exc.Heavy Duty Cooling; Base,Base,Sport	22049
1982	V8-5.7L	350 CID	Diesel; Exc.Heavy Duty Cooling; Base,Base,Estate	22049
1983-1985	V8-5.7L	350 CID	Diesel; Exc.Heavy Duty Cooling; Base,Base	22049
1965-1968	V8-6.5L	396 CID		22011
1969	V8-6.5L	396 CID		22045
1970-1976	V8-6.6L	400 CID		22045
1971-1972	V8-6.6L	402 CID		22045
1961-1965	V8-6.7L	409 CID		22011
1966-1968	V8-7.0L	427 CID		22011
1969	V8-7.0L	427 CID		22045
1970-1976	V8-7.4L	454 CID		22045
<b>IMPALA SS</b>				
1965	L6-4.1L	250 CID		22011
<b>K10</b>				
1980	L6-4.1L	250 CID	Exc.A/C; Cheyenne,Cheyenne,Custom Deluxe, Scottsdale,Silverado	22043
1981	L6-4.1L	250 CID	Exc.A/C; Custom,Custom,Deluxe	22043
1982	L6-4.1L	250 CID	Exc.A/C; Custom,Custom,Scottsdale,Silverado	22043
1983	L6-4.1L	250 CID	Exc.A/C; Custom,Custom,Silverado	22043
1984	L6-4.1L	250 CID	Exc.A/C; Custom,Custom,Scottsdale	22043
1980	L6-4.8L	292 CID	Exc.A/C; Cheyenne,Cheyenne,Custom Deluxe, Scottsdale,Silverado	22043
1985-1986	V6-4.3L	262 CID	Custom,Scottsdale,Silverado	22049
1981	V8-5.0L	305 CID	Custom,Deluxe	22045
1984	V8-5.0L	305 CID	Custom,Scottsdale	22045
1982	V8-5.0L	305 CID	Custom,Scottsdale,Silverado	22049
1983	V8-5.0L	305 CID	Custom,Silverado	22049
1985-1986	V8-5.0L	305 CID	Custom,Scottsdale,Silverado	22049
1980	V8-5.7L	350 CID	Cheyenne,Custom Deluxe,Scottsdale,Silverado	22045
1981	V8-5.7L	350 CID	Custom,Deluxe	22045
1982	V8-5.7L	350 CID	Exc.A/C; Custom,Custom,Scottsdale,Silverado	22045
1983	V8-5.7L	350 CID	Exc.A/C; Custom,Custom,Silverado	22045
1984	V8-5.7L	350 CID	A/C; Custom,Custom,Scottsdale	22045
1985-1986	V8-5.7L	350 CID	Custom,Scottsdale,Silverado	22049
1983	V8-6.2L	379 CID	Diesel; Custom,Silverado	22052
1984	V8-6.2L	379 CID	Diesel; Custom,Scottsdale	22052
1985-1986	V8-6.2L	379 CID	Diesel; Custom,Scottsdale,Silverado	22052
1982	V8-6.2L	379 CID	Diesel; Towing Package; Custom,Custom, Scottsdale,Silverado	22602
1980	V8-6.6L	400 CID	Cheyenne,Custom Deluxe,Scottsdale,Silverado	22045
1980	V8-7.4L	454 CID	Cheyenne,Custom Deluxe,Scottsdale,Silverado	22045
<b>K10 1/2 TON</b>				
1964-1965	L6-3.8L	230 CID		22049
1961-1962	L6-3.8L	235 CID		22049
1978-1979	L6-4.1L	250 CID		22043
1966-1977	L6-4.1L	250 CID		22049
1979	L6-4.8L	292 CID		22043
1964-1976	L6-4.8L	292 CID		22049
1961-1967	V8-4.6L	283 CID		22049
1977-1979	V8-5.0L	305 CID		22045
1968-1973	V8-5.0L	307 CID		22045
1967-1968	V8-5.3L	327 CID		22049

Years	Engine	Disp.	Application Description	USMW
1969-1979	V8-5.7L	350 CID		22045
1969	V8-6.5L	396 CID		22045
1975-1979	V8-6.6L	400 CID		22045
1971	V8-6.6L	402 CID		22045
1974-1979	V8-7.4L	454 CID		22045
<b>K10 SUBURBAN</b>				
1980	L6-4.1L	250 CID	Exc.A/C; Custom Deluxe,Custom Deluxe,Scottsdale, Silverado	22043
1980	V8-5.0L	305 CID	Custom Deluxe,Scottsdale,Silverado	22045
1981	V8-5.0L	305 CID	Custom,Deluxe	22045
1984	V8-5.0L	305 CID	Custom	22045
1982	V8-5.0L	305 CID	Custom,Scottsdale,Silverado	22049
1983	V8-5.0L	305 CID	Custom,Silverado	22049
1985-1986	V8-5.0L	305 CID	Custom,Scottsdale,Silverado	22049
1980	V8-5.7L	350 CID	Custom Deluxe,Scottsdale,Silverado	22045
1981	V8-5.7L	350 CID	Custom,Deluxe	22045
1982	V8-5.7L	350 CID	Exc.A/C; Custom,Custom,Scottsdale,Silverado	22045
1983	V8-5.7L	350 CID	Exc.A/C; Custom,Custom,Silverado	22045
1984	V8-5.7L	350 CID	A/C; Custom,Custom,Scottsdale	22045
1985-1986	V8-5.7L	350 CID	Custom,Scottsdale,Silverado	22049
1983	V8-6.2L	379 CID	Diesel; Custom,Silverado	22052
1984	V8-6.2L	379 CID	Diesel; Custom,Scottsdale	22052
1985-1986	V8-6.2L	379 CID	Diesel; Custom,Scottsdale,Silverado	22052
1982	V8-6.2L	379 CID	Diesel; Towing Package; Custom,Custom, Scottsdale,Silverado	22602
<b>K1500</b>				
1988-1989	V6-4.3L	262 CID	Cheyenne,Scottsdale,Silverado	22153
1990	V6-4.3L	262 CID	Cheyenne,Scottsdale,Silverado,WT	22153
1991	V6-4.3L	262 CID	Cheyenne,Silverado,Sport,WT	22153
1992-1993	V6-4.3L	262 CID	Cheyenne,Silverado,WT	22153
1994-1995	V6-4.3L	262 CID	Base,Cheyenne,Silverado,WT	22153
1996	V6-4.3L	262 CID	Exc.A/C; Base,Base,Cheyenne,Silverado,WT	22162
1997	V6-4.3L	262 CID	Exc.A/C; Base,Base,Cheyenne,Silverado,WT	22162
1998	V6-4.3L	262 CID	Exc.A/C; Cheyenne,Cheyenne,Silverado,WT	22162
1988-1989	V8-5.0L	305 CID	Cheyenne,Scottsdale,Silverado	22153
1990	V8-5.0L	305 CID	Cheyenne,Scottsdale,Silverado,WT	22153
1991	V8-5.0L	305 CID	Cheyenne,Silverado,Sport,WT	22153
1992-1993	V8-5.0L	305 CID	Cheyenne,Silverado,WT	22153
1994-1995	V8-5.0L	305 CID	Base,Cheyenne,Silverado,WT	22153
1996	V8-5.0L	305 CID	Exc.A/C; Base,Base,Cheyenne,Silverado,WT	22162
1997	V8-5.0L	305 CID	Exc.A/C; Base,Base,Cheyenne,Silverado,WT	22162
1998	V8-5.0L	305 CID	Exc.A/C; Cheyenne,Cheyenne,Silverado,WT	22162
1999	V8-5.0L	305 CID	Exc.A/C; LS,LS	22162
1988-1989	V8-5.7L	350 CID	Cheyenne,Scottsdale,Silverado	22153
1990	V8-5.7L	350 CID	Cheyenne,Scottsdale,Silverado,WT	22153
1991	V8-5.7L	350 CID	Cheyenne,Silverado,Sport,WT	22153
1992-1993	V8-5.7L	350 CID	Cheyenne,Silverado,WT	22153
1994-1995	V8-5.7L	350 CID	Base,Cheyenne,Silverado,WT	22153
1996	V8-5.7L	350 CID	Exc.A/C; Base,Base,Cheyenne,Silverado,WT	22162
1997	V8-5.7L	350 CID	Exc.A/C; Base,Base,Cheyenne,Silverado,WT	22162
1998	V8-5.7L	350 CID	Exc.A/C; Cheyenne,Cheyenne,Silverado,WT	22162
1999	V8-5.7L	350 CID	Exc.A/C; LS,LS	22162
1988-1989	V8-6.2L	379 CID	Diesel; Cheyenne,Scottsdale,Silverado	22154
1990	V8-6.2L	379 CID	Diesel; Cheyenne,Scottsdale,Silverado,WT	22154
1991	V8-6.2L	379 CID	Diesel; Cheyenne,Silverado,Sport,WT	22154
1992-1993	V8-6.2L	379 CID	Diesel; Cheyenne,Silverado,WT	22154
1994-1996	V8-6.5L	395 CID	Diesel; Base,Cheyenne,Silverado,WT	22605
1997	V8-6.5L	395 CID	Diesel; Base,Cheyenne,Silverado,WT	22613
1998	V8-6.5L	395 CID	Diesel; Cheyenne,Silverado,WT	22613
<b>K1500 SUBURBAN</b>				
1992-1994	V8-5.7L	350 CID	Base,Silverado	22153
1995	V8-5.7L	350 CID	Base,LS,LT	22153
1996	V8-5.7L	350 CID	Exc.A/C; Base,Base,LS,LT	22162
1997	V8-5.7L	350 CID	Exc.A/C; Base,Base,LS,LT	22162
1998-1999	V8-5.7L	350 CID	Exc.A/C; Base,Base,LS	22162
1995-1996	V8-6.5L	395 CID	Diesel; Base,LS,LT	22605
1997	V8-6.5L	395 CID	Diesel; Base,LS,LT	22613
1998	V8-6.5L	395 CID	Diesel; Base,LS	22613
1999	V8-6.5L	395 CID	Diesel; Screw-on (GDF); Base,Base,LS	22614



Years	Engine	Disp.	Application Description	USMW
<b>K20</b>				
1980	L6-4.1L	250 CID	Exc.A/C; Cheyenne,Cheyenne,Custom Deluxe,Scottsdale,Silverado	22043
1980	L6-4.8L	292 CID	Exc.A/C; Cheyenne,Cheyenne,Custom Deluxe,Scottsdale,Silverado	22043
1981	L6-4.8L	292 CID	Exc.A/C; Custom,Custom,Deluxe	22043
1982	L6-4.8L	292 CID	Custom,Scottsdale,Silverado	22043
1983	L6-4.8L	292 CID	Custom,Silverado	22043
1984	L6-4.8L	292 CID	A/C; Custom,Custom,Scottsdale	22045
1985-1986	L6-4.8L	292 CID	Custom,Scottsdale,Silverado	22045
1985	V6-4.3L	262 CID	Custom,Scottsdale,Silverado	22049
1980	V8-5.0L	305 CID	Cheyenne,Custom Deluxe,Scottsdale,Silverado	22045
1985	V8-5.0L	305 CID	Custom,Scottsdale,Silverado	22049
1980	V8-5.7L	350 CID	Cheyenne,Custom Deluxe,Scottsdale,Silverado	22045
1981	V8-5.7L	350 CID	Custom,Deluxe	22045
1982	V8-5.7L	350 CID	Exc.A/C; Custom,Custom,Scottsdale,Silverado	22045
1983	V8-5.7L	350 CID	Custom,Custom,Silverado	22049
1984	V8-5.7L	350 CID	Custom,Custom,Scottsdale	22049
1985-1986	V8-5.7L	350 CID	Custom,Scottsdale,Silverado	22049
1983	V8-6.2L	379 CID	Diesel; Custom,Silverado	22052
1984	V8-6.2L	379 CID	Diesel; Custom,Scottsdale	22052
1985-1986	V8-6.2L	379 CID	Diesel; Custom,Scottsdale,Silverado	22052
1982	V8-6.2L	379 CID	Diesel; Custom,Custom,Scottsdale,Silverado	22602
1980	V8-6.6L	400 CID	Cheyenne,Custom Deluxe,Scottsdale,Silverado	22045
1980	V8-7.4L	454 CID	Cheyenne,Custom Deluxe,Scottsdale,Silverado	22045
<b>K20 3/4 TON</b>				
1964-1965	L6-3.8L	230 CID		22049
1961-1962	L6-3.8L	235 CID		22049
1978-1979	L6-4.1L	250 CID		22043
1966-1976	L6-4.1L	250 CID		22049
1978-1979	L6-4.8L	292 CID		22043
1964-1977	L6-4.8L	292 CID		22049
1961-1967	V8-4.6L	283 CID		22049
1977-1978	V8-5.0L	305 CID		22045
1968-1973	V8-5.0L	307 CID		22045
1967-1968	V8-5.3L	327 CID		22049
1969-1979	V8-5.7L	350 CID		22045
1969	V8-6.5L	396 CID		22045
1975-1979	V8-6.6L	400 CID		22045
1971-1972	V8-6.6L	402 CID		22045
1973-1978	V8-7.4L	454 CID		22045
<b>K20 SUBURBAN</b>				
1980	L6-4.8L	292 CID	Exc.A/C; Custom Deluxe,Custom Deluxe,Scottsdale,Silverado	22043
1981	L6-4.8L	292 CID	Exc.A/C; Custom,Custom,Deluxe	22043
1982	L6-4.8L	292 CID	Custom,Scottsdale,Silverado	22043
1983	L6-4.8L	292 CID	Custom,Silverado	22043
1984	L6-4.8L	292 CID	A/C; Custom,Custom,Scottsdale	22045
1985-1986	L6-4.8L	292 CID	Custom,Scottsdale,Silverado	22045
1980	V8-5.7L	350 CID	Cheyenne,Custom Deluxe,Scottsdale,Silverado	22045
1981	V8-5.7L	350 CID	Custom,Deluxe	22045
1982	V8-5.7L	350 CID	Exc.A/C; Custom,Custom,Scottsdale,Silverado	22045
1983	V8-5.7L	350 CID	Custom,Silverado	22049
1984	V8-5.7L	350 CID	Custom,Scottsdale	22049
1985-1986	V8-5.7L	350 CID	Custom,Scottsdale,Silverado	22049
1983	V8-6.2L	379 CID	Diesel; Custom,Silverado	22052
1984	V8-6.2L	379 CID	Diesel; Custom,Scottsdale	22052
1985-1986	V8-6.2L	379 CID	Diesel; Custom,Scottsdale,Silverado	22052
1982	V8-6.2L	379 CID	Diesel; Custom,Scottsdale,Silverado	22602
1980	V8-6.6L	400 CID	Custom Deluxe,Scottsdale,Silverado	22045
1985	V8-7.4L	454 CID	Custom,Scottsdale,Silverado	22045
<b>K2500</b>				
1988-1990	V6-4.3L	262 CID	Cheyenne,Scottsdale,Silverado	22153
1991-1993	V6-4.3L	262 CID	Cheyenne,Silverado	22153
1994-1995	V6-4.3L	262 CID	Base,Cheyenne,Silverado,WT	22153
1988-1990	V8-5.0L	305 CID	Cheyenne,Scottsdale,Silverado	22153
1991-1993	V8-5.0L	305 CID	Cheyenne,Silverado	22153
1994-1995	V8-5.0L	305 CID	Base,Cheyenne,Silverado,WT	22153
1998	V8-5.0L	305 CID	Exc.A/C; Cheyenne,Cheyenne,Silverado,WT	22162
1988-1990	V8-5.7L	350 CID	Cheyenne,Scottsdale,Silverado	22153
1991-1993	V8-5.7L	350 CID	Cheyenne,Silverado	22153

Years	Engine	Disp.	Application Description	USMW
1994-1995	V8-5.7L	350 CID	Base,Cheyenne,Silverado,WT	22153
1996	V8-5.7L	350 CID	Exc.A/C; Base,Base,Cheyenne,Silverado,WT	22162
1997	V8-5.7L	350 CID	Exc.A/C; Base,Base,Cheyenne,Silverado,WT	22162
1998	V8-5.7L	350 CID	Exc.A/C; Cheyenne,Cheyenne,Silverado,WT	22162
1999-2000	V8-5.7L	350 CID	Exc.A/C; Base,Base,LS	22162
1988-1990	V8-6.2L	379 CID	Diesel; Cheyenne,Scottsdale,Silverado	22154
1991-1993	V8-6.2L	379 CID	Diesel; Cheyenne,Silverado	22154
1994-1996	V8-6.5L	395 CID	Diesel; Base,Cheyenne,Silverado,WT	22605
1992-1993	V8-6.5L	395 CID	Diesel; Cheyenne,Silverado	22606
1997	V8-6.5L	395 CID	Diesel; Base,Cheyenne,Silverado,WT	22613
1998	V8-6.5L	395 CID	Diesel; Cheyenne,Silverado,WT	22613
1999	V8-6.5L	395 CID	Diesel; Screw-on (GDF); Base,Base,LS	22614
2000	V8-6.5L	395 CID	Diesel; Base,LS	22614
1991-1993	V8-7.4L	454 CID	Cheyenne,Silverado	22145
1994-1997	V8-7.4L	454 CID	Base,Cheyenne,Silverado,WT	22145
1998	V8-7.4L	454 CID	Cheyenne,Silverado,WT	22145
1999-2000	V8-7.4L	454 CID	Base,LS	22145
<b>K2500 SUBURBAN</b>				
1992-1994	V8-5.7L	350 CID	Base,Silverado	22153
1995	V8-5.7L	350 CID	Base,LS,LT	22153
1996	V8-5.7L	350 CID	Exc.A/C; Base,Base,LS,LT	22162
1997	V8-5.7L	350 CID	Exc.A/C; Base,Base,LS,LT	22162
1998-1999	V8-5.7L	350 CID	Exc.A/C; Base,Base,LS	22162
1994	V8-6.5L	395 CID	Diesel; Base,Silverado	22605
1995-1996	V8-6.5L	395 CID	Diesel; Base,LS,LT	22605
1997	V8-6.5L	395 CID	Diesel; Base,LS,LT	22613
1998	V8-6.5L	395 CID	Diesel; Base,LS	22613
1999	V8-6.5L	395 CID	Diesel; Screw-on (GDF); Base,Base,LS	22614
1992-1994	V8-7.4L	454 CID	Base,Silverado	22145
1995-1997	V8-7.4L	454 CID	Base,LS,LT	22145
1998-1999	V8-7.4L	454 CID	Base,LS	22145
<b>K30</b>				
1980	L6-4.8L	292 CID	Exc.A/C; Cheyenne,Cheyenne,Custom Deluxe,Scottsdale,Silverado	22043
1981	L6-4.8L	292 CID	Exc.A/C; Custom,Custom,Deluxe	22043
1982	L6-4.8L	292 CID	Custom,Scottsdale,Silverado	22043
1983	L6-4.8L	292 CID	Custom,Silverado	22043
1984	L6-4.8L	292 CID	A/C; Custom,Custom,Scottsdale	22045
1985-1986	L6-4.8L	292 CID	Custom,Scottsdale,Silverado	22045
1980	V8-5.7L	350 CID	Cheyenne,Custom Deluxe,Scottsdale,Silverado	22045
1981	V8-5.7L	350 CID	Custom,Deluxe	22045
1982	V8-5.7L	350 CID	Exc.A/C; Custom,Custom,Scottsdale,Silverado	22045
1983	V8-5.7L	350 CID	Custom,Silverado	22049
1984	V8-5.7L	350 CID	Custom,Scottsdale	22049
1985-1986	V8-5.7L	350 CID	Custom,Scottsdale,Silverado	22049
1983	V8-6.2L	379 CID	Diesel; Custom,Silverado	22052
1984	V8-6.2L	379 CID	Diesel; Custom,Scottsdale	22052
1985-1986	V8-6.2L	379 CID	Diesel; Custom,Scottsdale,Silverado	22052
1982	V8-6.2L	379 CID	Diesel; Custom,Scottsdale,Silverado	22602
1980	V8-6.6L	400 CID	Cheyenne,Custom Deluxe,Scottsdale,Silverado	22045
1980	V8-7.4L	454 CID	Cheyenne,Custom Deluxe,Scottsdale,Silverado	22045
1981	V8-7.4L	454 CID	Custom,Deluxe	22045
1982	V8-7.4L	454 CID	Custom,Deluxe	22045
1982	V8-7.4L	454 CID	Custom,Scottsdale,Silverado	22045
1983	V8-7.4L	454 CID	Custom,Silverado	22045
1984	V8-7.4L	454 CID	Custom,Scottsdale	22045
1985-1986	V8-7.4L	454 CID	Custom,Scottsdale,Silverado	22045
<b>K30 1 TON</b>				
1978-1979	L6-4.8L	292 CID		22043
1973-1977	L6-4.8L	292 CID		22049
1977-1979	V8-5.7L	350 CID		22045
1973	V8-5.7L	350 CID		22049
1977-1979	V8-6.6L	400 CID		22045
1977	V8-7.4L	454 CID		22045
<b>K3500</b>				
1988-1990	V8-5.7L	350 CID	Cheyenne,Scottsdale,Silverado	22153
1991-1993	V8-5.7L	350 CID	Cheyenne,Silverado	22153
1994-1995	V8-5.7L	350 CID	Base,Cheyenne,Silverado	22153
1996	V8-5.7L	350 CID	Exc.A/C; Base,Base,Cheyenne,Silverado	22162
1997	V8-5.7L	350 CID	Exc.A/C; Base,Base,Cheyenne,Silverado	22162

FAN CLUTCHES

Years	Engine	Disp.	Application Description	USMW
1998	V8-5.7L	350 CID	Exc.A/C; Cheyenne,Cheyenne,Silverado	22162
1999-2000	V8-5.7L	350 CID	Exc.A/C; Base,Base,LS	22162
1988-1990	V8-6.2L	379 CID	Diesel; Cheyenne,Scottsdale,Silverado	22154
1991-1993	V8-6.2L	379 CID	Diesel; Cheyenne,Silverado	22154
1994-1996	V8-6.5L	395 CID	Diesel; Base,Cheyenne,Silverado	22605
1992-1993	V8-6.5L	395 CID	Diesel; Cheyenne,Silverado	22606
1997	V8-6.5L	395 CID	Diesel; Base,Cheyenne,Silverado	22613
1998	V8-6.5L	395 CID	Diesel; Cheyenne,Silverado	22613
1999	V8-6.5L	395 CID	Diesel; Screw-on (GDF); Base,Base,LS	22614
2000	V8-6.5L	395 CID	Diesel; Base,LS	22614
1988-1990	V8-7.4L	454 CID	Cheyenne,Scottsdale,Silverado	22145
1991-1993	V8-7.4L	454 CID	Cheyenne,Silverado	22145
1994-1997	V8-7.4L	454 CID	Base,Cheyenne,Silverado	22145
1998	V8-7.4L	454 CID	Cheyenne,Silverado	22145
1999-2000	V8-7.4L	454 CID	Base,LS	22145
<b>K5 BLAZER</b>				
1980	L6-4.1L	250 CID	Exc.A/C; Cheyenne,Cheyenne,Custom Deluxe,Silverado	22043
1981	L6-4.1L	250 CID	Exc.A/C; Custom,Custom,Deluxe,Silverado	22043
1982	L6-4.1L	250 CID	Exc.A/C; Custom,Custom,Silverado	22043
1983	V8-5.0L	305 CID	Custom,Silverado	22045
1984	V8-5.0L	305 CID	Custom,Scottsdale,Silverado	22045
1980	V8-5.0L	305 CID	Cheyenne,Custom Deluxe,Silverado	22049
1981	V8-5.0L	305 CID	Custom,Deluxe,Silverado	22049
1982-1986	V8-5.0L	305 CID	Custom,Silverado	22049
1980	V8-5.7L	350 CID	Cheyenne,Custom Deluxe,Silverado	22045
1981	V8-5.7L	350 CID	Custom,Deluxe,Silverado	22045
1982-1983	V8-5.7L	350 CID	Exc.A/C; Custom,Custom,Silverado	22045
1984	V8-5.7L	350 CID	A/C; Custom,Custom,Scottsdale,Silverado	22045
1985-1986	V8-5.7L	350 CID	Custom,Silverado	22049
1983	V8-6.2L	379 CID	Diesel; Custom,Silverado	22052
1984	V8-6.2L	379 CID	Diesel; Custom,Scottsdale,Silverado	22052
1985-1986	V8-6.2L	379 CID	Diesel; Custom,Silverado	22052
1982	V8-6.2L	379 CID	Diesel; Towing Package; Custom,Custom,Silverado	22602
<b>LAGUNA</b>				
1976	V8-5.0L	305 CID		22049
1973-1976	V8-5.7L	350 CID		22049
1974-1976	V8-6.6L	400 CID		22045
1973-1975	V8-7.4L	454 CID		22045
<b>LLV</b>				
1994-1995	L4-2.2L	134 CID	Base	22153
1987-1993	L4-2.5L	151 CID	Base	22147
<b>LUV</b>				
1972-1978	L4-1.8L	111 CID		22094
1980-1982	L4-1.8L	111 CID	A/C; Base,Mikado,Sport	22094
1981-1982	L4-2.2L	134 CID	Diesel; Base,Mikado,Sport	22094
<b>LUV 2WD</b>				
1979	L4-1.8L	111 CID		22094
<b>LUV 4WD</b>				
1979	L4-1.8L	111 CID		22094
<b>MALIBU</b>				
1964-1969	L6-3.8L	230 CID		22049
1968	L6-4.1L	250 CID		22011
1969-1977	L6-4.1L	250 CID		22049
1978-1979	V6-3.3L	200 CID		22043
1980	V6-3.8L	229 CID	A/C; Base,Base,Classic,Classic Estate, Classic Landau,Classic Sport,Estate,Sport	22049
1981	V6-3.8L	229 CID	A/C; Base,Base,Classic,Classic Landau	22049
1982	V6-3.8L	229 CID	Classic	22049
1978-1979	V6-3.8L	231 CID		22043
1980	V6-3.8L	231 CID	Base,Classic,Classic Estate,Classic Landau, Classic Sport,Estate,Sport	22043
1981	V6-3.8L	231 CID	Base,Classic,Classic Landau	22043
1982-1983	V6-3.8L	231 CID	Classic	22043
1982-1983	V6-4.3L	260 CID	Diesel; Classic	22049
1979	V8-4.4L	267 CID		22043
1981	V8-4.4L	267 CID	Base,Classic,Classic Landau	22045
1980	V8-4.4L	267 CID	Base,Classic,Classic Estate,Classic Landau, Classic Sport,Estate,Sport	22049

Years	Engine	Disp.	Application Description	USMW
1982	V8-4.4L	267 CID	Exc.A/C; Classic,Classic	22049
1964-1966	V8-4.6L	283 CID		22011
1979	V8-5.0L	305 CID		22043
1977-1978	V8-5.0L	305 CID		22049
1980	V8-5.0L	305 CID	Base,Classic,Classic Estate,Classic Landau, Classic Sport,Estate	22049
1981	V8-5.0L	305 CID	Base,Classic,Classic Landau	22049
1982-1983	V8-5.0L	305 CID	Exc.A/C; Classic,Classic	22049
1968-1973	V8-5.0L	307 CID		22049
1964-1966	V8-5.3L	327 CID		22016
1968	V8-5.3L	327 CID		22049
1979	V8-5.7L	350 CID		22043
1980	V8-5.7L	350 CID	Base,Estate,Sport	22045
1981	V8-5.7L	350 CID	Base	22045
1969-1978	V8-5.7L	350 CID		22049
1982-1983	V8-5.7L	350 CID	Diesel; Exc.Heavy Duty Cooling; Classic,Classic	22049
1966	V8-6.5L	396 CID		22011
1969-1970	V8-6.5L	396 CID		22049
1970-1972	V8-6.6L	402 CID		22049
1970-1973	V8-7.4L	454 CID		22049
<b>MONTE CARLO</b>				
1978-1979	V6-3.3L	200 CID		22043
1980	V6-3.8L	229 CID	A/C; Landau,Landau,Sport	22049
1981	V6-3.8L	229 CID	A/C; Base,Base,Landau	22049
1982	V6-3.8L	229 CID	Base	22049
1983	V6-3.8L	229 CID	Base,CL	22049
1984	V6-3.8L	229 CID	Base	22049
1978-1979	V6-3.8L	231 CID		22043
1980	V6-3.8L	231 CID	Landau,Sport	22043
1981	V6-3.8L	231 CID	Base,Landau	22043
1986-1987	V6-3.8L	231 CID		22043
1982	V6-3.8L	231 CID	Base	22049
1983	V6-3.8L	231 CID	Base,CL	22049
1984	V6-3.8L	231 CID	Base	22049
1982	V6-4.3L	260 CID	Diesel; Base	22049
1983	V6-4.3L	260 CID	Diesel; Base,CL	22049
1985	V6-4.3L	262 CID	Base	22049
1986-1988	V6-4.3L	262 CID	Base,LS	22049
1979	V8-4.4L	267 CID		22043
1981	V8-4.4L	267 CID	Base,Landau	22045
1980	V8-4.4L	267 CID	Landau,Sport	22049
1982	V8-4.4L	267 CID	Base	22049
1976-1979	V8-5.0L	305 CID		22043
1984-1985	V8-5.0L	305 CID	Base,SS	22045
1986-1988	V8-5.0L	305 CID	Base,LS,SS	22045
1980	V8-5.0L	305 CID	Landau,Sport	22049
1981	V8-5.0L	305 CID	Base,Landau	22049
1982	V8-5.0L	305 CID	Base	22049
1983	V8-5.0L	305 CID	Base,CL,SS	22049
1983	V8-5.7L	350 CID	Diesel; Exc.Heavy Duty Cooling; Base,Base,CL,SS	22045
1970-1977	V8-5.7L	350 CID		22049
1982-1984	V8-5.7L	350 CID	Diesel; Exc.Heavy Duty Cooling; Base,Base	22049
1970-1975	V8-6.6L	400 CID		22045
1976	V8-6.6L	400 CID		22049
1971-1972	V8-6.6L	402 CID		22045
1970-1975	V8-7.4L	454 CID		22045
<b>MONZA</b>				
1975-1977	L4-2.3L	140 CID		22049
1978-1979	L4-2.5L	151 CID		22049
1980	L4-2.5L	151 CID	A/C; 2+2,2+2 Sport,2+2 Spyder,Base,Spyder	22049
1978-1979	V6-3.2L	196 CID		22049
1978-1979	V6-3.8L	231 CID		22049
1980	V6-3.8L	231 CID	2+2,2+2 Sport,2+2 Spyder,Base,Spyder	22049
1975-1976	V8-4.3L	262 CID		22049
1976-1979	V8-5.0L	305 CID		22049
1975	V8-5.7L	350 CID		22049
<b>NOVA</b>				
1969-1970	L4-2.5L	153 CID		22049
1964-1966	L6-3.8L	230 CID		22016

Years	Engine	Disp.	Application Description	USMW
1968-1970	L6-3.8L	230 CID		22049
1967-1968	L6-4.1L	250 CID		22011
1969-1979	L6-4.1L	250 CID		22049
1975	V8-4.3L	262 CID		22049
1964-1967	V8-4.6L	283 CID		22011
1976-1979	V8-5.0L	305 CID		22049
1968	V8-5.0L	307 CID		22011
1969-1973	V8-5.0L	307 CID		22049
1965-1968	V8-5.3L	327 CID		22016
1968	V8-5.7L	350 CID		22011
1969-1979	V8-5.7L	350 CID		22049
1968	V8-6.5L	396 CID		22011
1969-1970	V8-6.5L	396 CID		22049
1970	V8-6.6L	402 CID		22049
<b>ONE-FIFTY</b>				
1957	V8-4.6L	283 CID		22049
<b>P10 VAN</b>				
1963-1969	L6-3.8L	230 CID		22049
1967-1974	L6-4.1L	250 CID		22049
1975-1979	L6-4.8L	292 CID		22045
1967	L6-4.8L	292 CID		22049
1973-1978	V8-5.7L	350 CID		22045
1977	V8-6.6L	400 CID		22045
1973	V8-7.4L	454 CID		22045
<b>P20 VAN</b>				
1963-1965	L6-3.8L	230 CID		22049
1966-1974	L6-4.1L	250 CID		22049
1968-1979	L6-4.8L	292 CID		22045
1964-1967	L6-4.8L	292 CID		22049
1962	V8-4.6L	283 CID		22049
1968-1973	V8-5.0L	307 CID		22045
1970-1979	V8-5.7L	350 CID		22045
1973-1979	V8-7.4L	454 CID		22045
<b>P30</b>				
1985	L6-4.8L	292 CID	Base,Step-Van	22049
1986	L6-4.8L	292 CID	Base	22049
1987-1989	L6-4.8L	292 CID	Base,Step-Van	22049
1990	V6-4.3L	262 CID	Base,Step-Van	22051
1991-1995	V6-4.3L	262 CID	Base	22051
1996-1999	V6-4.3L	262 CID	Base	22158
1994-1995	V8-5.7L	350 CID	Base	22045
1985	V8-5.7L	350 CID	Base,Step-Van	22049
1986	V8-5.7L	350 CID	Base	22049
1987-1990	V8-5.7L	350 CID	Base,Step-Van	22049
1991-1993	V8-5.7L	350 CID	Base	22049
1997-1999	V8-5.7L	350 CID	Base	22173
1985	V8-6.2L	379 CID	Diesel; Base,Step-Van	22052
1986	V8-6.2L	379 CID	Diesel; Base	22052
1987-1990	V8-6.2L	379 CID	Diesel; Base,Step-Van	22052
1991-1993	V8-6.2L	379 CID	Diesel; Base	22052
1994-1999	V8-6.5L	395 CID	Diesel; Base	22613
1986	V8-7.4L	454 CID	Base	22045
1987-1990	V8-7.4L	454 CID	Base,Step-Van	22045
1991-1997	V8-7.4L	454 CID	Base	22045
1985	V8-7.4L	454 CID	Base,Step-Van	22049
1998-1999	V8-7.4L	454 CID	Base	22145
<b>P30 VAN</b>				
1963-1965	L6-3.8L	230 CID		22049
1966-1979	L6-4.1L	250 CID		22049
1964-1979	L6-4.8L	292 CID		22045
1962	V8-4.6L	283 CID		22049
1968-1973	V8-5.0L	307 CID		22045
1970-1979	V8-5.7L	350 CID		22045
1972-1976	V8-6.6L	400 CID		22049
1973-1979	V8-7.4L	454 CID		22045
<b>R10</b>				
1987	V6-4.3L	262 CID	Custom Deluxe,Scottsdale,Silverado	22049
1987	V8-5.0L	305 CID	Custom Deluxe,Scottsdale,Silverado	22049
1987	V8-5.7L	350 CID	Custom Deluxe,Scottsdale,Silverado	22049

Years	Engine	Disp.	Application Description	USMW
1987	V8-6.2L	379 CID	Diesel; Custom Deluxe,Scottsdale,Silverado	22052
<b>R10 SUBURBAN</b>				
1987	V8-5.0L	305 CID	Custom Deluxe,Scottsdale,Silverado	22049
1987	V8-5.7L	350 CID	Custom Deluxe,Scottsdale,Silverado	22049
1988	V8-5.7L	350 CID	Scottsdale,Silverado	22049
1987	V8-6.2L	379 CID	Diesel; Custom Deluxe,Scottsdale,Silverado	22052
1988	V8-6.2L	379 CID	Diesel; Scottsdale,Silverado	22052
<b>R1500 SUBURBAN</b>				
1989-1991	V8-5.7L	350 CID	Scottsdale,Silverado	22153
1989-1991	V8-6.2L	379 CID	Diesel; Scottsdale,Silverado	22052
<b>R20</b>				
1987	L6-4.8L	292 CID	Custom Deluxe,Scottsdale,Silverado	22045
1988	L6-4.8L	292 CID	Cheyenne,Scottsdale,Silverado	22045
1987	V6-4.3L	262 CID	Custom Deluxe,Scottsdale,Silverado	22049
1987	V8-5.0L	305 CID	Custom Deluxe,Scottsdale,Silverado	22049
1987	V8-5.7L	350 CID	Custom Deluxe,Scottsdale,Silverado	22049
1988	V8-5.7L	350 CID	Cheyenne,Scottsdale,Silverado	22049
1987	V8-6.2L	379 CID	Diesel; Custom Deluxe,Scottsdale,Silverado	22052
1988	V8-6.2L	379 CID	Diesel; Cheyenne,Scottsdale,Silverado	22052
1987	V8-7.4L	454 CID	Custom Deluxe,Scottsdale,Silverado	22045
1988	V8-7.4L	454 CID	CCW; Silverado,Silverado	22145
<b>R20 SUBURBAN</b>				
1987	V8-5.7L	350 CID	Custom Deluxe,Scottsdale,Silverado	22049
1988	V8-5.7L	350 CID	Scottsdale,Silverado	22049
1987	V8-6.2L	379 CID	Diesel; Custom Deluxe,Scottsdale,Silverado	22052
1988	V8-6.2L	379 CID	Diesel; Scottsdale,Silverado	22052
1987	V8-7.4L	454 CID	Custom Deluxe,Scottsdale,Silverado	22045
1988	V8-7.4L	454 CID	CCW; Scottsdale,Scottsdale,Silverado	22145
<b>R2500</b>				
1989	V8-5.7L	350 CID	CCW; Silverado,Silverado	22145
1989	V8-6.2L	379 CID	Diesel; Cheyenne,Scottsdale,Silverado	22052
1989	V8-7.4L	454 CID	CCW; Cheyenne,Cheyenne,Scottsdale,Silverado	22145
<b>R2500 SUBURBAN</b>				
1989-1990	V8-5.7L	350 CID	CCW; Scottsdale,Scottsdale,Silverado	22145
1991	V8-5.7L	350 CID	Scottsdale,Scottsdale,Silverado	22145
1989-1991	V8-6.2L	379 CID	Diesel; Scottsdale,Silverado	22052
1989-1991	V8-7.4L	454 CID	CCW; Scottsdale,Scottsdale,Silverado	22145
<b>R30</b>				
1987	L6-4.8L	292 CID	Custom Deluxe,Scottsdale,Silverado	22045
1988	L6-4.8L	292 CID	Cheyenne,Scottsdale,Silverado	22045
1987	V8-5.7L	350 CID	Custom Deluxe,Scottsdale,Silverado	22045
1988	V8-5.7L	350 CID	Cheyenne,Scottsdale,Silverado	22045
1987	V8-6.2L	379 CID	Diesel; Custom Deluxe,Scottsdale,Silverado	22052
1988	V8-6.2L	379 CID	Diesel; Cheyenne,Scottsdale,Silverado	22052
1987	V8-7.4L	454 CID	Custom Deluxe,Scottsdale,Silverado	22045
1988	V8-7.4L	454 CID	CCW; Cheyenne,Cheyenne,Scottsdale,Silverado	22145
<b>R3500</b>				
1989-1990	V8-5.7L	350 CID	Cheyenne,Scottsdale,Silverado	22045
1991	V8-5.7L	350 CID	Cheyenne,Silverado	22045
1989-1990	V8-6.2L	379 CID	Diesel; Cheyenne,Scottsdale,Silverado	22052
1991	V8-6.2L	379 CID	Diesel; Cheyenne,Silverado	22052
1989	V8-7.4L	454 CID	Cheyenne,Scottsdale,Silverado	22045
1990	V8-7.4L	454 CID	CCW; Cheyenne,Cheyenne,Scottsdale,Silverado	22145
1991	V8-7.4L	454 CID	CCW; Cheyenne,Cheyenne,Silverado	22145
<b>S10</b>				
1985	L4-1.9L	119 CID	Base,Durango,Sport,Tahoe	22013
1982	L4-1.9L	119 CID	Base,Durango,Sport	22048
1983-1984	L4-1.9L	119 CID	Base,Durango,Sport,Tahoe	22048
1983-1984	L4-2.0L	122 CID	Base,Durango,Sport,Tahoe	22048
1983-1985	L4-2.2L	134 CID	Diesel; Base,Durango,Sport,Tahoe	22013
1997-1998	L4-2.2L	134 CID	Exc.A/C; Base,Base,LS	22136
1999-2000	L4-2.2L	134 CID	Exc.A/C; Base,Base,LS,Xtreme	22136
2001-2003	L4-2.2L	134 CID	Exc.A/C; Base,Base,LS,Xtreme,ZR5	22136
1994-1996	L4-2.2L	134 CID	Exc.A/C; Base,Base,LS	22156
1986	L4-2.5L	151 CID	Base,Durango,Sport,Tahoe	22026
1985	L4-2.5L	151 CID	Base,Durango,Sport,Tahoe	22048
1987	L4-2.5L	151 CID	Base,Sport,Tahoe	22147
1988	L4-2.5L	151 CID	Base,Durango,Sport,Tahoe	22147



Years	Engine	Disp.	Application Description	USMW
1992	L4-2.5L	151 CID	Base,EL,Tahoe	22147
1993	L4-2.5L	151 CID	Base,EL	22147
1989	L4-2.5L	151 CID	Front mount fan; Base,Base,Durango,Sport,Tahoe	22179
1990	L4-2.5L	151 CID	Front mount fan; Base,Base,Durango,Tahoe	22179
1991	L4-2.5L	151 CID	Exc.A/C; Baja,Baja,Base,Tahoe	22179
1984	V6-2.8L	173 CID	Base,Durango,Sport,Tahoe	22026
1986	V6-2.8L	173 CID	A/C; Base,Base,Durango,Sport,Tahoe	22045
1982	V6-2.8L	173 CID	Base,Durango,Sport	22048
1983	V6-2.8L	173 CID	Base,Durango,Sport,Tahoe	22048
1985	V6-2.8L	173 CID	A/C; Base,Base,Durango,Sport,Tahoe	22056
1992	V6-2.8L	173 CID	Base,EL,Tahoe	22142
1993	V6-2.8L	173 CID	Base,EL	22142
1987	V6-2.8L	173 CID	Exc.A/C; Base,Base,Sport,Tahoe	22179
1988-1989	V6-2.8L	173 CID	Exc.A/C; Base,Base,Durango,Sport,Tahoe	22179
1990	V6-2.8L	173 CID	Exc.A/C; Base,Base,Durango,Tahoe	22179
1991	V6-2.8L	173 CID	Exc.A/C; Baja,Baja,Base,Tahoe	22179
1988-1989	V6-4.3L	262 CID	A/C; Base,Base,Durango,Sport,Tahoe	22145
1990	V6-4.3L	262 CID	A/C; Base,Base,Durango,Tahoe	22145
1991	V6-4.3L	262 CID	A/C; Baja,Baja,Base,Tahoe	22145
1992	V6-4.3L	262 CID	A/C; Base,Base,EL,Tahoe	22145
1993	V6-4.3L	262 CID	A/C; Base,Base,EL	22145
1994-1995	V6-4.3L	262 CID	Exc.A/C; Base,Base,LS,SS,ZR2	22153
2004	V6-4.3L	262 CID	LS,ZR5	22158
1996-1998	V6-4.3L	262 CID	Exc.A/C; Base,Base,LS,SS,ZR2	22162
1999-2000	V6-4.3L	262 CID	Exc.A/C; Base,Base,LS,Xtreme,ZR2	22162
2001-2003	V6-4.3L	262 CID	Exc.A/C; Base,Base,LS,Xtreme,ZR2,ZR5	22162
<b>S10 BLAZER</b>				
1983-1984	L4-1.9L	119 CID	Base,Durango,Sport,Tahoe	22048
1983-1984	L4-2.0L	122 CID	Base,Durango,Sport,Tahoe	22048
1984	L4-2.2L	134 CID	Diesel; Base,Durango,Sport,Tahoe	22013
1986	L4-2.5L	151 CID	Base,Durango,Sport,Tahoe	22026
1985	L4-2.5L	151 CID	Base,Durango,Sport,Tahoe	22048
1987-1988	L4-2.5L	151 CID	Base,High Country,Sport,Tahoe	22147
1984	V6-2.8L	173 CID	Base,Durango,Sport,Tahoe	22026
1986	V6-2.8L	173 CID	A/C; Base,Base,Durango,Sport,Tahoe	22045
1983	V6-2.8L	173 CID	Base,Durango,Sport,Tahoe	22048
1985	V6-2.8L	173 CID	A/C; Base,Base,Durango,Sport,Tahoe	22056
1987-1988	V6-2.8L	173 CID	Exc.A/C; Base,Base,High Country,Sport,Tahoe	22179
1989	V6-2.8L	173 CID	Exc.A/C; Base,Base,High Country,Sport	22179
1991	V6-4.3L	262 CID	Base,Tahoe,Tahoe LT	22142
1992	V6-4.3L	262 CID	Base,Sport,Tahoe,Tahoe LT	22142
1993	V6-4.3L	262 CID	Base,Tahoe,Tahoe LT	22142
1988	V6-4.3L	262 CID	A/C; Base,Base,High Country,Sport,Tahoe	22145
1989	V6-4.3L	262 CID	A/C; Base,Base,High Country,Sport	22145
1990	V6-4.3L	262 CID	A/C; Base,Base,Sport,Tahoe	22145
1994	V6-4.3L	262 CID	Base,LT,Tahoe,Tahoe LT	22145
<b>SILVERADO (MEX)</b>				
1994-1995	V8-5.7L	350 CID		22153
1996-1997	V8-5.7L	350 CID		22158
<b>SILVERADO 1500</b>				
1999-2001	V6-4.3L	262 CID	Exc.A/C; Base,Base,LS,LT	22158
2002-2003	V6-4.3L	262 CID	Exc.A/C; Base,Base,LS,LT,WT	22158
2004	V6-4.3L	262 CID	Exc.A/C; Base,Base,LS,LT,WT,Z71	22158
1999-2001	V8-4.8L	294 CID	Exc.A/C; Base,Base,LS,LT	22158
2002-2003	V8-4.8L	294 CID	Exc.A/C; Base,Base,LS,LT,WT	22158
2004	V8-4.8L	294 CID	Exc.A/C; Base,Base,LS,LT,WT,Z71	22158
2005	V8-4.8L	294 CID	Base,LS,LT	22158
2006	V8-4.8L	294 CID	LS,LT,WT	22158
2007	V8-4.8L	294 CID	Classic LS,Classic LT,Classic WT	22158
1999-2001	V8-5.3L	323 CID	Exc.A/C; Base,Base,LS,LT	22158
2002-2003	V8-5.3L	323 CID	Exc.A/C; Base,Base,LS,LT,WT	22158
2004	V8-5.3L	323 CID	Exc.A/C; Base,Base,Hybrid,LS,LT,WT,Z71	22158
2005	V8-5.3L	323 CID	Base,Hybrid,LS,LT	22158
2006	V8-5.3L	323 CID	Hybrid,LS,LT,WT	22158
2007	V8-5.3L	323 CID	Classic Hybrid,Classic LS,Classic LT,Classic WT	22158
2003-2005	V8-6.0L	364 CID	SS	22158
2006	V8-6.0L	364 CID	LT,SS	22158
2007	V8-6.0L	364 CID	Classic LT,Classic SS	22158

Years	Engine	Disp.	Application Description	USMW
<b>SILVERADO 1500 HD</b>				
2001-2003	V8-6.0L	364 CID	Exc.A/C; LS,LS,LT	22158
2005	V8-6.0L	364 CID	Base,LS,LT	22158
2006	V8-6.0L	364 CID	LT	22158
2007	V8-6.0L	364 CID	Classic LT	22158
<b>SILVERADO 2500</b>				
1999-2000	V8-5.3L	323 CID	Exc.A/C; Base,Base,LS,LT	22158
1999-2003	V8-6.0L	364 CID	Exc.A/C; Base,Base,LS,LT	22158
2004	V8-6.0L	364 CID	Exc.A/C; Base,Base,LS,LT,WT	22158
<b>SILVERADO 2500 HD</b>				
2011-2012	V8-6.0L	364 CID	LT,LTZ,WT	22123
2001-2003	V8-6.0L	364 CID	Exc.A/C; Base,Base,LS,LT	22158
2004	V8-6.0L	364 CID	Exc.A/C; Base,Base,LS,LT,WT	22158
2005	V8-6.0L	364 CID	Exc.A/C; Base,Base,LS,LT	22158
2006	V8-6.0L	364 CID	Exc.A/C; LS,LS,LT,WT	22158
2007	V8-6.0L	364 CID	Classic LS,Classic LT,Classic WT,LT,LTZ,WT	22158
2008-2010	V8-6.0L	364 CID	LT,LTZ,WT	22158
2011-2012	V8-6.6L	400 CID	Diesel; LT,LTZ,WT	22342
2001-2003	V8-6.6L	400 CID	Diesel; Base,LS,LT	22617
2004	V8-6.6L	400 CID	Diesel; Base,LS,LT,WT	22617
2005	V8-6.6L	400 CID	Diesel; Base,LS,LT	22617
2006	V8-6.6L	400 CID	Diesel; LS,LT,WT	22625
2007	V8-6.6L	400 CID	Diesel; Classic LS,Classic LT,Classic WT,LT,LTZ,WT	22625
2008-2010	V8-6.6L	400 CID	Diesel; LT,LTZ,WT	22625
2001-2003	V8-8.1L	496 CID	Base,LS,LT	22158
2004	V8-8.1L	496 CID	Base,LS,LT,WT	22158
2005	V8-8.1L	496 CID	Base,LS,LT	22158
2006	V8-8.1L	496 CID	LS,LT,WT	22158
2007	V8-8.1L	496 CID	Classic LS,Classic LT,Classic WT	22158
<b>SILVERADO 3500</b>				
2001-2003	V8-6.0L	364 CID	Exc.A/C; Base,Base,LS,LT	22158
2004	V8-6.0L	364 CID	Exc.A/C; Base,Base,LS,LT,WT	22158
2005	V8-6.0L	364 CID	Exc.A/C; Base,Base,LS,LT	22158
2006	V8-6.0L	364 CID	Exc.A/C; LS,LS,LT,WT	22158
2007	V8-6.0L	364 CID	Classic LS,Classic LT,Classic WT	22158
2001-2003	V8-6.6L	400 CID	Diesel; Base,LS,LT	22617
2004	V8-6.6L	400 CID	Diesel; Base,LS,LT,WT	22617
2005	V8-6.6L	400 CID	Diesel; Base,LS,LT	22617
2006	V8-6.6L	400 CID	Diesel; LS,LT,WT	22625
2007	V8-6.6L	400 CID	Diesel; Classic LS,Classic LT,Classic WT	22625
2001-2003	V8-8.1L	496 CID	Base,LS,LT	22158
2004	V8-8.1L	496 CID	Base,LS,LT,WT	22158
2005	V8-8.1L	496 CID	Base,LS,LT	22158
2006	V8-8.1L	496 CID	LS,LT,WT	22158
2007	V8-8.1L	496 CID	Classic LS,Classic LT,Classic WT	22158
<b>SILVERADO 3500 (MEX)</b>				
2001-2003	V8-5.7L	350 CID		22158
<b>SILVERADO 3500 HD</b>				
2011-2012	V8-6.0L	364 CID	LT,LTZ,WT	22123
2007-2010	V8-6.0L	364 CID	LT,LTZ,WT	22158
2011-2012	V8-6.6L	400 CID	Diesel; LT,LTZ,WT	22342
2007-2010	V8-6.6L	400 CID	Diesel; LT,LTZ,WT	22625
<b>SSR</b>				
2003-2004	V8-5.3L	325 CID	Base	22310
2005-2006	V8-6.0L	364 CID	Base	22310
<b>SUBURBAN 1500</b>				
2000-2001	V8-5.3L	323 CID	Exc.A/C; Base,Base,LS,LT	22158
2002-2003	V8-5.3L	323 CID	Exc.A/C; LS,LS,LT	22158
2004	V8-5.3L	323 CID	Exc.A/C; LS,LS,LT,Z71	22158
2005	V8-5.3L	323 CID	LS,LT,Z71	22158
2006	V8-5.3L	325 CID	Base,LS,LT,Z71	22158
2006	V8-6.0L	364 CID	Exc.A/C; LTZ,LTZ	22158
<b>SUBURBAN 2500</b>				
2012	V8-6.0L	364 CID	LS,LT	22157
2000-2001	V8-6.0L	364 CID	Exc.A/C; Base,Base,LS,LT	22158
2002-2006	V8-6.0L	364 CID	Exc.A/C; LS,LS,LT	22158
2007	V8-6.0L	364 CID	LS,LT,LTZ	22158
2008-2011	V8-6.0L	364 CID	LS,LT	22158



Years	Engine	Disp.	Application Description	USMW
2001	V8-8.1L	496 CID	Base,LS,LT	22158
2002-2006	V8-8.1L	496 CID	LS,LT	22158
<b>TAHOE</b>				
2000-2001	V8-4.8L	294 CID	Exc.A/C; Base,Base,LS,LT	22158
2002	V8-4.8L	294 CID	Exc.A/C; LS,LS,LT	22158
2003-2004	V8-4.8L	294 CID	Exc.A/C; LS,LS,LT,Z71	22158
2005	V8-4.8L	294 CID	LS	22158
2006	V8-4.8L	294 CID	Base,LS	22158
2000-2001	V8-5.3L	323 CID	Exc.A/C; Base,Base,LS,LT	22158
2002	V8-5.3L	323 CID	Exc.A/C; LS,LS,LT	22158
2003-2004	V8-5.3L	323 CID	Exc.A/C; LS,LS,LT,Z71	22158
2005	V8-5.3L	323 CID	LS,LT,Z71	22158
2006	V8-5.3L	325 CID	Base,LS,LT,Z71	22158
1995	V8-5.7L	350 CID	Base,LS,LT	22145
1996	V8-5.7L	350 CID	Exc.A/C; Base,Base,LS,LT	22162
1997	V8-5.7L	350 CID	Exc.A/C; Base,Base,LS,LT	22162
1998-1999	V8-5.7L	350 CID	Exc.A/C; Base,Base,LS,LT	22162
2000	V8-5.7L	350 CID	Exc.A/C; Limited,Limited,Z71	22162
1995-1996	V8-6.5L	395 CID	Diesel; Base,LS,LT	22605
1997-1999	V8-6.5L	395 CID	Diesel; Base,LS,LT	22613
<b>TRACKER</b>				
1998-2000	L4-1.6L	98 CID	Base,LSi	22068
1999-2000	L4-2.0L	122 CID	Base,LSi	22033
2001-2003	L4-2.0L	122 CID	Base,LT,ZR2	22033
2001-2003	V6-2.5L	2500cc	LT,ZR2	22033
2004	V6-2.5L	2500cc	Base,LT,ZR2	22033
<b>TRAILBLAZER</b>				
2002-2003	L6-4.2L	256 CID	LS,LT,LTZ,North Face	22310
2004	L6-4.2L	256 CID	LS,LT,North Face	22310
2005-2006	L6-4.2L	256 CID	LS,LT	22310
2007	L6-4.2L	256 CID	LS,LT	22330
2008	L6-4.2L	256 CID	Base,Base,LT	22627
2009	L6-4.2L	256 CID	LT,LT	22627
2006	V8-5.3L	325 CID	LS,LT	22310
2007	V8-5.3L	325 CID	LS,LS,LT	22627
2008	V8-5.3L	325 CID	Base,Base,LT	22627
2006	V8-6.0L	364 CID	SS	22310
2007-2009	V8-6.0L	364 CID	Electric; SS	22330
<b>TRAILBLAZER EXT</b>				
2002	L6-4.2L	256 CID	LT,North Face	22310
2003-2004	L6-4.2L	256 CID	LS,LT,North Face	22310
2005-2006	L6-4.2L	256 CID	LS,LT	22310
2005	V8-5.3L	323 CID	LS,LT	22310
2003-2004	V8-5.3L	325 CID	LS,LT,North Face	22310
2006	V8-5.3L	325 CID	LS,LT	22310
<b>TWO-TEN</b>				
1957	V8-4.6L	283 CID		22049
<b>V10</b>				
1987	V6-4.3L	262 CID	Custom Deluxe,Scottsdale,Silverado	22049
1987	V8-5.0L	305 CID	Custom Deluxe,Scottsdale,Silverado	22049
1987	V8-5.7L	350 CID	Custom Deluxe,Scottsdale,Silverado	22049
1987	V8-6.2L	379 CID	Diesel; Custom Deluxe,Scottsdale,Silverado	22052
<b>V10 SUBURBAN</b>				
1987	V8-5.7L	350 CID	Custom Deluxe,Scottsdale,Silverado	22049
1988	V8-5.7L	350 CID	Scottsdale,Silverado	22049
1987	V8-6.2L	379 CID	Diesel; Custom Deluxe,Scottsdale,Silverado	22052
1988	V8-6.2L	379 CID	Diesel; Scottsdale,Silverado	22052
<b>V1500 SUBURBAN</b>				
1989-1991	V8-5.7L	350 CID	Scottsdale,Silverado	22140
1989-1991	V8-6.2L	379 CID	Diesel; Scottsdale,Silverado	22052
<b>V20</b>				
1987	L6-4.8L	292 CID	Custom Deluxe,Scottsdale,Silverado	22045
1987	V8-5.7L	350 CID	Custom Deluxe,Scottsdale,Silverado	22049
1987	V8-6.2L	379 CID	Diesel; Custom Deluxe,Scottsdale,Silverado	22052
<b>V20 SUBURBAN</b>				
1987	V8-5.7L	350 CID	Custom Deluxe,Scottsdale,Silverado	22049
1988	V8-5.7L	350 CID	Silverado	22049
1987	V8-6.2L	379 CID	Diesel; Custom Deluxe,Scottsdale,Silverado	22052

Years	Engine	Disp.	Application Description	USMW
1988	V8-6.2L	379 CID	Diesel; Scottsdale,Silverado	22052
1987	V8-7.4L	454 CID	Custom Deluxe,Scottsdale,Silverado	22045
1988	V8-7.4L	454 CID	CCW; Scottsdale,Scottsdale,Silverado	22145
<b>V2500 SUBURBAN</b>				
1989	V8-5.7L	350 CID	CCW; Scottsdale,Scottsdale,Silverado	22140
1990	V8-5.7L	350 CID	CCW; Scottsdale,Scottsdale,Silverado	22145
1991	V8-5.7L	350 CID	Scottsdale,Silverado	22145
1989-1991	V8-6.2L	379 CID	Diesel; Scottsdale,Silverado	22052
1990	V8-7.4L	454 CID	CCW; Scottsdale,Scottsdale,Silverado	22145
<b>V30</b>				
1987	L6-4.8L	292 CID	Custom Deluxe,Scottsdale,Silverado	22045
1988	L6-4.8L	292 CID	Cheyenne,Scottsdale,Silverado	22045
1987	V8-5.7L	350 CID	Custom Deluxe,Scottsdale,Silverado	22045
1988	V8-5.7L	350 CID	Cheyenne,Scottsdale,Silverado	22045
1987	V8-6.2L	379 CID	Diesel; Custom Deluxe,Scottsdale,Silverado	22052
1988	V8-6.2L	379 CID	Diesel; Cheyenne,Scottsdale,Silverado	22052
1987	V8-7.4L	454 CID	Custom Deluxe,Scottsdale,Silverado	22045
1988	V8-7.4L	454 CID	CCW; Cheyenne,Cheyenne,Scottsdale,Silverado	22145
<b>V3500</b>				
1989-1990	V8-5.7L	350 CID	Cheyenne,Scottsdale,Silverado	22045
1991	V8-5.7L	350 CID	Cheyenne,Silverado	22045
1989-1990	V8-6.2L	379 CID	Diesel; Cheyenne,Scottsdale,Silverado	22052
1991	V8-6.2L	379 CID	Diesel; Cheyenne,Silverado	22052
1989	V8-7.4L	454 CID	Cheyenne,Scottsdale,Silverado	22045
1990	V8-7.4L	454 CID	CCW; Cheyenne,Cheyenne,Scottsdale,Silverado	22145
1991	V8-7.4L	454 CID	CCW; Cheyenne,Cheyenne,Silverado	22145
<b>VEGA</b>				
1971-1977	L4-2.3L	140 CID		22049
<b>CHRYSLER</b>				
<b>300</b>				
1962-1966	V8-6.3L	383 CID		22043
1960-1965	V8-6.7L	413 CID		22043
1966-1971	V8-7.2L	440 CID		22026
<b>300E</b>				
1959	V8-6.7L	413 CID		22043
<b>ASPEN</b>				
2007-2009	V8-4.7L	285 CID	Heavy Duty Cooling; Limited,Limited	22164
2009	V8-5.7L	345 CID	Electric/Gas; Limited,Limited Hybrid	22070
2007-2008	V8-5.7L	345 CID	Heavy Duty Cooling; Limited,Limited	22164
<b>CONQUEST</b>				
1987	L4-2.6L	156 CID	Base	22092
<b>CORDOBA</b>				
1980	L6-3.7L	225 CID	A/C; 300,Base,Crown,LS	22043
1981-1982	L6-3.7L	225 CID	A/C; Base,Base,LS	22043
1983	L6-3.7L	225 CID	A/C; Base,Base	22043
1975-1979	V8-5.2L	318 CID		22026
1982	V8-5.2L	318 CID	A/C; Base,Base,LS	22043
1983	V8-5.2L	318 CID	A/C; Base,Base	22043
1981	V8-5.2L	318 CID	A/C; Base,Base,LS	22045
1980	V8-5.2L	318 CID	Max Cooling; 300,300,Base,Crown	22054
1975-1979	V8-5.9L	360 CID		22026
1975-1978	V8-6.6L	400 CID		22026
<b>FIFTH AVENUE</b>				
1983	L6-3.7L	225 CID	A/C; Base,Base	22043
1983	V8-5.2L	318 CID	A/C; Base,Base	22043
1984-1989	V8-5.2L	318 CID	Max Cooling; Base,Base	22045
<b>IMPERIAL</b>				
1982	V8-5.2L	318 CID	A/C; Base,Base	22043
1981	V8-5.2L	318 CID	A/C; Base,Base	22045
1959-1965	V8-6.7L	413 CID		22043
1966-1975	V8-7.2L	440 CID		22026
<b>LEBARON</b>				
1978-1979	L6-3.7L	225 CID		22026
1980	L6-3.7L	225 CID	A/C; Base,Medallion,Salon,Special	22043
1981	L6-3.7L	225 CID	A/C; Base,Base,Medallion,Salon,Special	22043
1977-1979	V8-5.2L	318 CID		22026
1981	V8-5.2L	318 CID	A/C; Base,Base,Medallion,Salon,Special	22045

Years	Engine	Disp.	Application Description	USMW
1980	V8-5.2L	318 CID	Max Cooling; Base,Base,Medallion,Salon,Special	22054
1978-1979	V8-5.9L	360 CID		22026
<b>NEW YORKER</b>				
1982	L6-3.7L	225 CID	A/C; Base,Base	22043
1979	V8-5.2L	318 CID		22026
1981	V8-5.2L	318 CID	A/C; Base,Base	22045
1982	V8-5.2L	318 CID	A/C; Base,Base	22045
1980	V8-5.2L	318 CID	Max Cooling; Base,Base	22054
1977-1979	V8-5.9L	360 CID		22026
1980	V8-5.9L	360 CID	Max Cooling; Base,Base	22054
1975-1978	V8-6.6L	400 CID		22026
1959-1965	V8-6.7L	413 CID		22043
1966-1978	V8-7.2L	440 CID		22026
<b>NEWPORT</b>				
1979	L6-3.7L	225 CID		22026
1980	L6-3.7L	225 CID	A/C; Base	22043
1981	L6-3.7L	225 CID	A/C; Base,Base	22043
1979	V8-5.2L	318 CID		22026
1981	V8-5.2L	318 CID	A/C; Base,Base	22045
1980	V8-5.2L	318 CID	Max Cooling; Base,Base	22054
1971-1979	V8-5.9L	360 CID		22026
1980	V8-5.9L	360 CID	Max Cooling; Base,Base	22054
1961-1964	V8-5.9L	361 CID		22049
1965-1971	V8-6.3L	383 CID		22043
1972-1978	V8-6.6L	400 CID		22026
1966-1978	V8-7.2L	440 CID		22026
<b>TOWN &amp; COUNTRY</b>				
1978-1979	L6-3.7L	225 CID		22026
1980	L6-3.7L	225 CID	A/C; Base	22043
1981	L6-3.7L	225 CID	A/C; Base,Base	22043
1978-1979	V8-5.2L	318 CID		22026
1981	V8-5.2L	318 CID	A/C; Base,Base	22045
1980	V8-5.2L	318 CID	Max Cooling; Base,Base	22054
1978-1979	V8-5.9L	360 CID		22026
1966-1971	V8-6.3L	383 CID		22043
1972-1977	V8-6.6L	400 CID		22026
1967-1977	V8-7.2L	440 CID		22026
<b>DAIHATSU</b>				
<b>ROCKY</b>				
1990-1992	L4-1.6L	1589cc	SE,SX	22406
<b>DODGE</b>				
<b>330</b>				
1963-1964	L6-3.7L	225 CID		22026
1963-1964	V8-5.2L	318 CID		22026
1964	V8-6.3L	383 CID		22043
<b>440</b>				
1963-1964	L6-3.7L	225 CID		22026
1963-1964	V8-5.2L	318 CID		22026
1964	V8-6.3L	383 CID		22043
<b>880</b>				
1963-1964	V8-6.3L	383 CID		22043
1963	V8-6.7L	413 CID		22043
<b>A100 1/2 TON</b>				
1964-1969	L6-2.8L	170 CID		22026
1970	L6-3.2L	198 CID		22043
1964-1970	L6-3.7L	225 CID		22026
1964-1966	V8-4.5L	273 CID		22043
1967-1970	V8-5.2L	318 CID		22026
<b>A100 1/2 TON VAN</b>				
1964-1969	L6-2.8L	170 CID		22026
1970	L6-3.2L	198 CID		22043
1964-1970	L6-3.7L	225 CID		22026
1964-1966	V8-4.5L	273 CID		22043
1967-1970	V8-5.2L	318 CID		22026
<b>ASPEN</b>				
1976-1979	L6-3.7L	225 CID		22026
1980	L6-3.7L	225 CID	A/C; Base	22043

Years	Engine	Disp.	Application Description	USMW
1976-1979	V8-5.2L	318 CID		22026
1980	V8-5.2L	318 CID	Max Cooling; Base,Base	22054
1976-1979	V8-5.9L	360 CID		22026
1980	V8-5.9L	360 CID	Max Cooling; Base,Base	22054
<b>B100</b>				
1980	L6-3.7L	225 CID	A/C; Base,Base	22043
1980	V8-5.2L	318 CID	A/C; Base,Base	22045
<b>B100 1/2 TON VAN</b>				
1971	L6-3.2L	198 CID		22043
1971-1979	L6-3.7L	225 CID		22026
1971-1979	V8-5.2L	318 CID		22026
1971-1978	V8-5.9L	360 CID		22026
1974	V8-7.2L	440 CID		22054
<b>B150</b>				
1982-1983	L6-3.7L	225 CID	Max Cooling; Base	22026
1981	L6-3.7L	225 CID	A/C; Base,Base	22043
1984-1987	L6-3.7L	225 CID	Max Cooling (A/C); Base,Base	22043
1988-1991	V6-3.9L	239 CID	A/C; Base	22043
1992-1993	V6-3.9L	239 CID	A/C; Base	22160
1994	V6-3.9L	239 CID	A/C (Exc.Max Cooling); Base,Base	22160
1990-1991	V8-5.2L	318 CID	Base	22026
1982-1983	V8-5.2L	318 CID	Max Cooling (A/C); Base,Base	22043
1984-1985	V8-5.2L	318 CID	A/C (Max Cooling); Base,Base	22043
1986-1989	V8-5.2L	318 CID	A/C; Base,Base	22043
1981	V8-5.2L	318 CID	A/C; Base,Base	22045
1992-1994	V8-5.2L	318 CID	Exc.Max Cooling; Base,Base	22160
<b>B1500</b>				
1995	V6-3.9L	239 CID	A/C (Exc.Max Cooling); Base,Base	22160
1996-1997	V6-3.9L	239 CID	A/C (Exc.Max Cooling); Base,Base	22160
1998	V6-3.9L	239 CID	Base	22160
1998	V8-5.2L	318 CID	Base	22159
1995	V8-5.2L	318 CID	Exc.Max Cooling; Base,Base	22160
1996-1997	V8-5.2L	318 CID	Exc.Max Cooling; Base,Base	22160
1998	V8-5.9L	360 CID	Base	22159
<b>B200</b>				
1980	L6-3.7L	225 CID	A/C; Base,Base	22043
1980	V8-5.2L	318 CID	A/C; Base,Base	22045
1980	V8-5.9L	360 CID	A/C; Base,Base	22045
<b>B200 3/4 TON VAN</b>				
1971	L6-3.2L	198 CID		22043
1971-1978	L6-3.7L	225 CID		22026
1971-1979	V8-5.2L	318 CID		22026
1971-1979	V8-5.9L	360 CID		22026
1971-1978	V8-6.6L	400 CID		22026
1974-1978	V8-7.2L	440 CID		22054
<b>B250</b>				
1982-1983	L6-3.7L	225 CID	Max Cooling; Base	22026
1981	L6-3.7L	225 CID	A/C; Base,Base	22043
1984-1987	L6-3.7L	225 CID	Max Cooling (A/C); Base,Base	22043
1988-1991	V6-3.9L	239 CID	A/C; Base	22043
1992-1993	V6-3.9L	239 CID	A/C; Base	22160
1994	V6-3.9L	239 CID	A/C (Exc.Max Cooling); Base,Base	22160
1990-1991	V8-5.2L	318 CID	Base	22026
1982-1983	V8-5.2L	318 CID	Max Cooling (A/C); Base,Base	22043
1984-1985	V8-5.2L	318 CID	A/C (Max Cooling); Base,Base	22043
1986-1989	V8-5.2L	318 CID	A/C; Base,Base	22043
1981	V8-5.2L	318 CID	A/C; Base,Base	22045
1992-1994	V8-5.2L	318 CID	Exc.Max Cooling; Base,Base	22160
1990-1992	V8-5.9L	360 CID	Base	22026
1984-1985	V8-5.9L	360 CID	A/C (Max Cooling); Base,Base	22043
1986-1989	V8-5.9L	360 CID	A/C; Base,Base	22043
1981	V8-5.9L	360 CID	A/C; Base,Base	22045
1993-1994	V8-5.9L	360 CID	Exc.Max Cooling; Base,Base	22160
<b>B2500</b>				
1995	V6-3.9L	239 CID	A/C (Exc.Max Cooling); Base,Base	22160
1996-1997	V6-3.9L	239 CID	A/C (Exc.Max Cooling); Base,Base	22160
1998	V8-5.2L	318 CID	LPG; Base,Base	22159
1995	V8-5.2L	318 CID	Exc.Max Cooling; Base,Base	22160

Years	Engine	Disp.	Application Description	USMW
1996-1997	V8-5.2L	318 CID	Exc.Max Cooling; Base,Base	22160
1998	V8-5.9L	360 CID	Base	22159
1995	V8-5.9L	360 CID	Exc.Max Cooling; Base,Base	22160
1996-1997	V8-5.9L	360 CID	Exc.Max Cooling; Base,Base	22160
<b>B300</b>				
1980	L6-3.7L	225 CID	A/C; Base,Base	22043
1980	V8-5.2L	318 CID	A/C; Base,Base	22045
1980	V8-5.9L	360 CID	A/C; Base,Base	22045
<b>B300 1 TON VAN</b>				
1971-1979	L6-3.7L	225 CID		22026
1971-1979	V8-5.2L	318 CID		22026
1971-1979	V8-5.9L	360 CID		22026
1976-1978	V8-6.6L	400 CID		22026
1975-1978	V8-7.2L	440 CID		22054
<b>B350</b>				
1990-1991	V8-5.2L	318 CID	Base	22026
1982-1983	V8-5.2L	318 CID	Max Cooling (A/C); Base,Base	22043
1984-1985	V8-5.2L	318 CID	A/C (Max Cooling); Base,Base	22043
1986-1989	V8-5.2L	318 CID	A/C; Base,Base	22043
1981	V8-5.2L	318 CID	A/C; Base,Base	22045
1992-1994	V8-5.2L	318 CID	Exc.Max Cooling; Base,Base	22160
1990-1992	V8-5.9L	360 CID	Base	22026
1982-1983	V8-5.9L	360 CID	Max Cooling (A/C); Base,Base	22043
1984-1985	V8-5.9L	360 CID	A/C (Max Cooling); Base,Base	22043
1986-1989	V8-5.9L	360 CID	A/C; Base,Base	22043
1981	V8-5.9L	360 CID	A/C; Base,Base	22045
1993-1994	V8-5.9L	360 CID	Exc.Max Cooling; Base,Base	22160
<b>B3500</b>				
1998	V8-5.2L	318 CID	LPG; Base,Base	22159
1995	V8-5.2L	318 CID	Exc.Max Cooling; Base,Base	22160
1996-1997	V8-5.2L	318 CID	Exc.Max Cooling; Base,Base	22160
1998	V8-5.9L	360 CID	Base	22159
1995	V8-5.9L	360 CID	Exc.Max Cooling; Base,Base	22160
1996-1997	V8-5.9L	360 CID	Exc.Max Cooling; Base,Base	22160
<b>CB300</b>				
1974-1978	L6-3.7L	225 CID		22026
1974-1979	V8-5.2L	318 CID		22026
1980	V8-5.2L	318 CID	A/C; Base,Base	22045
1974-1979	V8-5.9L	360 CID		22026
1980	V8-5.9L	360 CID	A/C; Base,Base	22045
1976-1978	V8-6.6L	400 CID		22026
1977-1979	V8-7.2L	440 CID		22045
<b>CHALLENGER</b>				
1980-1983	L4-2.6L	156 CID	Base,Premium	22092
1970-1971	L6-3.2L	198 CID		22043
1970-1972	L6-3.7L	225 CID		22026
1974	V8-5.2L	318 CID		22026
1970-1973	V8-5.2L	318 CID		22054
1970-1973	V8-5.6L	340 CID		22054
1974	V8-5.9L	360 CID		22026
1970-1971	V8-6.3L	383 CID		22054
1970-1971	V8-7.2L	440 CID		22054
<b>CHALLENGER-IMPORT</b>				
1978-1979	L4-2.6L	155 CID		22092
<b>CHARGER</b>				
1968-1976	L6-3.7L	225 CID		22026
1974-1978	V8-5.2L	318 CID		22026
1966-1973	V8-5.2L	318 CID		22054
1971-1973	V8-5.6L	340 CID		22054
1974-1978	V8-5.9L	360 CID		22026
1966	V8-5.9L	361 CID		22054
1966-1971	V8-6.3L	383 CID		22054
1972-1978	V8-6.6L	400 CID		22026
1967-1974	V8-7.2L	440 CID		22054
<b>COLT</b>				
1980	L4-2.6L	156 CID	Base	22092
<b>CONQUEST</b>				
1984-1986	L4-2.6L	156 CID	Base	22092

Years	Engine	Disp.	Application Description	USMW
<b>CORONET</b>				
1965-1976	L6-3.7L	225 CID		22026
1967	V8-3.7L	225 CID		22026
1965-1968	V8-4.5L	273 CID		22043
1974-1976	V8-5.2L	318 CID		22026
1965-1973	V8-5.2L	318 CID		22054
1972-1973	V8-5.6L	340 CID		22054
1974-1976	V8-5.9L	360 CID		22026
1973	V8-5.9L	360 CID		22054
1965-1966	V8-5.9L	361 CID		22054
1959	V8-6.3L	383 CID		22043
1965-1971	V8-6.3L	383 CID		22054
1972-1976	V8-6.6L	400 CID		22026
1967-1976	V8-7.2L	440 CID		22054
<b>CUSTOM</b>				
1963-1965	V8-6.3L	383 CID		22043
<b>D100</b>				
1986-1987	L6-3.7L	225 CID	Max Cooling (A/C); Custom,Custom	22043
1988-1989	V6-3.9L	239 CID	A/C; Custom,Custom	22043
1986-1989	V8-5.2L	318 CID	A/C; Custom,Custom	22043
1986-1987	V8-5.9L	360 CID	A/C; Custom,Custom	22043
1988	V8-5.9L	360 CID	A/C; Custom,Custom	22043
<b>D100 1/2 TON</b>				
1961-1965	L6-2.8L	170 CID		22026
1970-1971	L6-3.2L	198 CID		22043
1961-1979	L6-3.7L	225 CID		22026
1960-1979	V8-5.2L	318 CID		22026
1971-1979	V8-5.9L	360 CID		22026
1964-1971	V8-6.3L	383 CID		22043
1971-1978	V8-6.6L	400 CID		22026
1973-1978	V8-7.2L	440 CID		22045
<b>D150</b>				
1982-1983	L6-3.7L	225 CID	Max Cooling; Base,Miser	22026
1980-1981	L6-3.7L	225 CID	A/C; Base,Base	22043
1984-1987	L6-3.7L	225 CID	Max Cooling (A/C); Base,Base	22043
1980	L6-4.0L	243 CID	Diesel; A/C; Base,Base	22043
1990-1991	V6-3.9L	239 CID	Base,S	22026
1988-1989	V6-3.9L	239 CID	A/C; Base,Base	22043
1992-1993	V6-3.9L	239 CID	Base	22170
1990-1991	V8-5.2L	318 CID	Base,S	22026
1982-1983	V8-5.2L	318 CID	Max Cooling (A/C); Base,Base,Miser	22043
1984-1985	V8-5.2L	318 CID	A/C (Exc.Max Cooling); Base,Base	22043
1986-1989	V8-5.2L	318 CID	A/C; Base,Base	22043
1980-1981	V8-5.2L	318 CID	A/C; Base,Base	22045
1992-1993	V8-5.2L	318 CID	Max Cooling; Base,Base	22170
1990-1991	V8-5.9L	360 CID	Base	22026
1982	V8-5.9L	360 CID	Max Cooling (A/C); Base,Base,Miser	22043
1984-1985	V8-5.9L	360 CID	A/C (Exc.Max Cooling); Base,Base	22043
1986-1987	V8-5.9L	360 CID	A/C; Base,Base	22043
1988-1989	V8-5.9L	360 CID	A/C; Base,Base	22043
1980-1981	V8-5.9L	360 CID	A/C; Base,Base	22045
1993	V8-5.9L	360 CID	Max Cooling; Base,Base	22170
<b>D150 1/2 TON</b>				
1977-1979	L6-3.7L	225 CID		22026
1977-1979	V8-5.2L	318 CID		22026
1977-1979	V8-5.9L	360 CID		22026
1977-1978	V8-6.6L	400 CID		22026
1978	V8-7.2L	440 CID		22026
<b>D200</b>				
1980	L6-3.7L	225 CID	A/C; Base,Base	22043
1980	L6-4.0L	243 CID	Diesel; A/C; Base,Base	22043
1980	V8-5.2L	318 CID	A/C; Base,Base	22045
1980	V8-5.9L	360 CID	A/C; Base,Base	22045
<b>D200 3/4 TON</b>				
1961-1979	L6-3.7L	225 CID		22026
1960-1979	V8-5.2L	318 CID		22026
1971-1979	V8-5.9L	360 CID		22026
1968-1971	V8-6.3L	383 CID		22026

**FAN CLUTCHES**



Years	Engine	Disp.	Application Description	USMW
1964-1967	V8-6.3L	383 CID		<b>22043</b>
1971-1978	V8-6.6L	400 CID		<b>22026</b>
1973-1974	V8-7.2L	440 CID		<b>22026</b>
1975-1978	V8-7.2L	440 CID		<b>22045</b>
<b>D250</b>				
1982-1983	L6-3.7L	225 CID	Max Cooling; Base	<b>22026</b>
1981	L6-3.7L	225 CID	A/C; Base,Base	<b>22043</b>
1984-1987	L6-3.7L	225 CID	Max Cooling (A/C); Base,Base	<b>22043</b>
1989	L6-5.9L	359 CID	Diesel; Base	<b>22070</b>
1990-1993	L6-5.9L	359 CID	Diesel; Intercooler; Base,Base	<b>22070</b>
1990-1991	V6-3.9L	239 CID	Base	<b>22026</b>
1988-1989	V6-3.9L	239 CID	A/C; Base,Base	<b>22043</b>
1992-1993	V6-3.9L	239 CID	Base	<b>22170</b>
1990-1991	V8-5.2L	318 CID	Base	<b>22026</b>
1982-1983	V8-5.2L	318 CID	Max Cooling (A/C); Base,Base	<b>22043</b>
1984-1985	V8-5.2L	318 CID	A/C (Exc.Max Cooling); Base,Base	<b>22043</b>
1986-1989	V8-5.2L	318 CID	A/C; Base,Base	<b>22043</b>
1981	V8-5.2L	318 CID	A/C; Base,Base	<b>22045</b>
1992-1993	V8-5.2L	318 CID	Max Cooling; Base,Base	<b>22170</b>
1990-1991	V8-5.9L	360 CID	Base	<b>22026</b>
1982	V8-5.9L	360 CID	Max Cooling (A/C); Base,Base	<b>22043</b>
1984-1985	V8-5.9L	360 CID	A/C (Exc.Max Cooling); Base,Base	<b>22043</b>
1986-1987	V8-5.9L	360 CID	A/C; Base,Base	<b>22043</b>
1988-1989	V8-5.9L	360 CID	A/C; Base,Base	<b>22043</b>
1981	V8-5.9L	360 CID	A/C; Base,Base	<b>22045</b>
1992	V8-5.9L	360 CID	Base	<b>22045</b>
1993	V8-5.9L	360 CID	Max Cooling; Base,Base	<b>22170</b>
<b>D300</b>				
1980	V8-5.2L	318 CID	A/C; Base,Base	<b>22045</b>
1980	V8-5.9L	360 CID	A/C; Base,Base	<b>22045</b>
<b>D300 1 TON</b>				
1961-1978	L6-3.7L	225 CID		<b>22026</b>
1960-1979	V8-5.2L	318 CID		<b>22026</b>
1972-1979	V8-5.9L	360 CID		<b>22026</b>
1968-1971	V8-6.3L	383 CID		<b>22026</b>
1964-1967	V8-6.3L	383 CID		<b>22043</b>
1971-1978	V8-6.6L	400 CID		<b>22026</b>
1973-1974	V8-7.2L	440 CID		<b>22026</b>
1975-1978	V8-7.2L	440 CID		<b>22045</b>
<b>D350</b>				
1989	L6-5.9L	359 CID	Diesel; Base	<b>22070</b>
1990-1993	L6-5.9L	359 CID	Diesel; Intercooler; Base,Base	<b>22070</b>
1982-1983	V8-5.2L	318 CID	Max Cooling (A/C); Base,Base	<b>22043</b>
1981	V8-5.2L	318 CID	A/C; Base,Base	<b>22045</b>
1990-1991	V8-5.9L	360 CID	Base	<b>22026</b>
1982-1983	V8-5.9L	360 CID	Max Cooling (A/C); Base,Base	<b>22043</b>
1984-1985	V8-5.9L	360 CID	A/C (Exc.Max Cooling); Base,Base	<b>22043</b>
1986-1987	V8-5.9L	360 CID	A/C; Base,Base	<b>22043</b>
1988-1989	V8-5.9L	360 CID	A/C; Base,Base	<b>22043</b>
1981	V8-5.9L	360 CID	A/C; Base,Base	<b>22045</b>
1992	V8-5.9L	360 CID	Base	<b>22045</b>
1993	V8-5.9L	360 CID	Max Cooling; Base,Base	<b>22170</b>
<b>D350 (MEX)</b>				
1980	L6-3.7L	225 CID		<b>22026</b>
1980	V8-5.2L	318 CID		<b>22026</b>
1980	V8-5.9L	360 CID		<b>22026</b>
<b>D400</b>				
1980-1981	V8-5.9L	360 CID	A/C; Base,Base	<b>22045</b>
<b>D450</b>				
1980-1981	V8-5.9L	360 CID	A/C; Base,Base	<b>22045</b>
<b>D50</b>				
1979	L4-2.0L	122 CID		<b>22086</b>
1980	L4-2.0L	122 CID	Base	<b>22092</b>
1981-1982	L4-2.0L	122 CID	Custom	<b>22092</b>
1979	L4-2.6L	156 CID		<b>22086</b>
1980	L4-2.6L	156 CID	Sport	<b>22092</b>
1981	L4-2.6L	156 CID	Royal,Sport	<b>22092</b>
1982	L4-2.6L	156 CID	Custom,Royal,Sport	<b>22092</b>

Years	Engine	Disp.	Application Description	USMW
<b>DAKOTA</b>				
2004	V6-3.7L	226 CID	Base,SLT,SLT Plus,Sport,Sport Plus,Stampede,SXT	<b>22150</b>
2005	V6-3.7L	226 CID	Heavy Duty Cooling; Laramie,Laramie,SLT,Sport,ST	<b>22170</b>
2006-2007	V6-3.7L	226 CID	Laramie,SLT,ST	<b>22170</b>
2008	V6-3.7L	226 CID	SLT,Sport,ST,SXT,TRX,TRX4	<b>22170</b>
2009	V6-3.7L	226 CID	Big Horn,Lone Star,ST,TRX4	<b>22170</b>
2010	V6-3.7L	226 CID	Big Horn,Laramie,Lone Star,ST	<b>22170</b>
1987	V6-3.9L	239 CID	A/C (Max Cooling); Base,LE,SE	<b>22043</b>
1988-1989	V6-3.9L	239 CID	A/C; Base,LE,SE,Sport	<b>22043</b>
1990-1991	V6-3.9L	239 CID	Base,LE,S,SE,Sport	<b>22043</b>
1992-1993	V6-3.9L	239 CID	Max Cooling; Base,Base,LE,S,Sport	<b>22170</b>
1994-1996	V6-3.9L	239 CID	Max Cooling; Base,Base,SLT,Sport,WS	<b>22170</b>
2002	V6-3.9L	239 CID	Base,SLT,Sport,SXT	<b>22170</b>
2003	V6-3.9L	239 CID	Base,SLT,Sport	<b>22170</b>
1997-1999	V6-3.9L	239 CID	Max Cooling; Base,Base,SLT,Sport	<b>22171</b>
2000-2001	V6-3.9L	239 CID	Base,SLT,Sport	<b>22171</b>
2002	V8-4.7L	285 CID	Base,SLT,Sport,SXT	<b>22170</b>
2003	V8-4.7L	285 CID	Base,SLT,Sport	<b>22170</b>
2004	V8-4.7L	285 CID	SLT,SLT Plus,Sport,Sport Plus	<b>22170</b>
2005	V8-4.7L	285 CID	Heavy Duty Cooling; Laramie,Laramie,SLT,Sport,ST	<b>22170</b>
2006-2007	V8-4.7L	285 CID	Heavy Duty Cooling; Laramie,Laramie,SLT,ST	<b>22170</b>
2008	V8-4.7L	285 CID	Heavy Duty Cooling; Laramie,Laramie,SLT,Sport,SXT,TRX,TRX4	<b>22170</b>
2009-2010	V8-4.7L	285 CID	Heavy Duty Cooling; Big Horn,Big Horn,Laramie,Lone Star,TRX4	<b>22170</b>
2000-2001	V8-4.7L	287 CID	Base,SLT,Sport	<b>22171</b>
1991	V8-5.2L	318 CID	Max Cooling (To 04/16/91); Base,Base,LE,S,SE,Sport	<b>22146</b>
1992-1993	V8-5.2L	318 CID	Max Cooling; Base,Base,LE,S,Sport	<b>22170</b>
1994-1996	V8-5.2L	318 CID	Max Cooling; Base,Base,SLT,Sport,WS	<b>22170</b>
1997-1999	V8-5.2L	318 CID	Base,SLT,Sport	<b>22170</b>
1998-1999	V8-5.9L	360 CID	R/T	<b>22170</b>
2002	V8-5.9L	360 CID	SLT,Sport,SXT	<b>22170</b>
2003	V8-5.9L	360 CID	R/T,SLT,Sport	<b>22170</b>
2000-2001	V8-5.9L	360 CID	R/T,SLT,Sport	<b>22171</b>
<b>DAKOTA SLT (MEX)</b>				
2010	L6-3.7L	226 CID		<b>22170</b>
<b>DART</b>				
1961-1969	L6-2.8L	170 CID		<b>22026</b>
1970-1974	L6-3.2L	198 CID		<b>22043</b>
1971-1976	L6-3.7L	225 CID		<b>22026</b>
1960-1970	L6-3.7L	225 CID		<b>22043</b>
1964-1969	V8-4.5L	273 CID		<b>22043</b>
1974-1976	V8-5.2L	318 CID		<b>22026</b>
1962-1973	V8-5.2L	318 CID		<b>22054</b>
1968-1973	V8-5.6L	340 CID		<b>22054</b>
1974-1976	V8-5.9L	360 CID		<b>22026</b>
1960-1962	V8-5.9L	361 CID		<b>22054</b>
1961-1969	V8-6.3L	383 CID		<b>22054</b>
1961-1962	V8-6.7L	413 CID		<b>22043</b>
<b>DART (MEX)</b>				
1977-1981	L6-3.7L	225 CID		<b>22026</b>
1977-1982	V8-5.9L	360 CID		<b>22026</b>
<b>DART SWINGER</b>				
1969	L6-2.8L	170 CID		<b>22026</b>
1970-1974	L6-3.2L	198 CID		<b>22043</b>
1971-1976	L6-3.7L	225 CID		<b>22026</b>
1969-1970	L6-3.7L	225 CID		<b>22043</b>
1969	V8-4.5L	273 CID		<b>22043</b>
1974-1976	V8-5.2L	318 CID		<b>22026</b>
1969-1973	V8-5.2L	318 CID		<b>22054</b>
1969-1970	V8-5.6L	340 CID		<b>22054</b>
1976	V8-5.9L	360 CID		<b>22026</b>
<b>DEMON</b>				
1971-1972	L6-3.2L	198 CID		<b>22043</b>
1971-1972	L6-3.7L	225 CID		<b>22026</b>
1971-1972	V8-5.2L	318 CID		<b>22054</b>
1971-1972	V8-5.6L	340 CID		<b>22054</b>



Years	Engine	Disp.	Application Description	USMW
<b>DIPLOMAT</b>				
1978-1979	L6-3.7L	225 CID		22026
1980	L6-3.7L	225 CID	A/C; Base,Medallion,Salon	22043
1981	L6-3.7L	225 CID	A/C; Base,Base,Medallion,Salon,Sport	22043
1982-1983	L6-3.7L	225 CID	A/C; Medallion,Medallion,Salon	22043
1977-1979	V8-5.2L	318 CID		22026
1981	V8-5.2L	318 CID	A/C; Base,Base,Medallion,Salon	22045
1982	V8-5.2L	318 CID	A/C; Medallion,Medallion,Salon	22045
1983	V8-5.2L	318 CID	Medallion,Medallion,Salon	22045
1984-1989	V8-5.2L	318 CID	Max Cooling; Salon,Salon,SE	22045
1980	V8-5.2L	318 CID	Max Cooling; Base,Base,Medallion,Salon	22054
1978-1979	V8-5.9L	360 CID		22026
<b>DURANGO</b>				
2004-2005	V6-3.7L	226 CID	SLT,ST	22159
2006-2009	V6-3.7L	226 CID	SLT,SXT	22159
1998	V6-3.9L	239 CID	Max Cooling; Base,Base,SLT	22171
1999	V6-3.9L	239 CID	Max Cooling; Base,Base,SLT,SLT Plus	22171
2009	V8-4.7L	285 CID	Adventurer,Limited,SLT,SXT	22159
2004	V8-4.7L	285 CID	Heavy Duty Cooling; Limited,Limited,SLT,ST	22164
2005	V8-4.7L	285 CID	Heavy Duty Cooling; Limited,Limited,SLT,ST,SXT	22164
2006-2008	V8-4.7L	285 CID	Adventurer,Limited,SLT,SXT	22164
2002	V8-4.7L	285 CID	R/T,SLT,SLT Plus,Sport	22170
2003	V8-4.7L	285 CID	R/T,SLT,SLT Plus,Sport,SXT	22170
2001	V8-4.7L	287 CID	Base,R/T,SLT	22170
2000	V8-4.7L	287 CID	Base,R/T,SLT,SLT Plus,Sport	22171
1998	V8-5.2L	318 CID	Max Cooling; Base,Base,SLT	22170
1999	V8-5.2L	318 CID	Max Cooling; Base,Base,SLT,SLT Plus	22170
2000	V8-5.2L	318 CID	Exc.Max Cooling; Base,Base,R/T,SLT,SLT Plus,Sport	22171
2004	V8-5.7L	345 CID	Heavy Duty Cooling; Limited,Limited,SLT	22164
2005	V8-5.7L	345 CID	Heavy Duty Cooling; Limited,Limited,SLT,ST	22164
2006	V8-5.7L	345 CID	Heavy Duty Cooling; Adventurer,Adventurer,Limited,SLT	22164
2007	V8-5.7L	345 CID	Heavy Duty Cooling; Adventurer,Adventurer,Limited,SLT,SXT	22164
2008	V8-5.7L	345 CID	Heavy Duty Cooling; Adventurer,Adventurer,Limited,SLT	22164
1998	V8-5.9L	360 CID	Max Cooling; Base,Base,SLT	22170
1999	V8-5.9L	360 CID	Max Cooling; Base,Base,SLT,SLT Plus	22170
2001	V8-5.9L	360 CID	Max Cooling; Base,Base,R/T,SLT	22170
2002	V8-5.9L	360 CID	Exc.Drive Ratio 3.92 (Heavy Duty Cooling); R/T,R/T,SLT,SLT Plus,Sport	22170
2003	V8-5.9L	360 CID	Exc.Drive Ratio 3.92 (Heavy Duty Cooling); R/T,R/T,SLT,SLT Plus,Sport,SXT	22170
2000	V8-5.9L	360 CID	Exc.Max Cooling; Base,Base,R/T,SLT,SLT Plus,Sport	22171
<b>LANCER</b>				
1961-1962	L6-2.8L	170 CID		22026
1961-1962	L6-3.7L	225 CID		22026
<b>MAGNUM</b>				
1978-1979	V8-5.2L	318 CID		22026
1978-1979	V8-5.9L	360 CID		22026
1978	V8-6.6L	400 CID		22026
<b>MAGNUM (MEX)</b>				
1980-1982	V8-5.9L	360 CID		22026
<b>MIRADA</b>				
1980	L6-3.7L	225 CID	A/C; Special Coupe	22043
1981-1983	L6-3.7L	225 CID	A/C; Special Coupe,Special Coupe	22043
1982-1983	V8-5.2L	318 CID	A/C; Special Coupe,Special Coupe	22043
1981	V8-5.2L	318 CID	A/C; Special Coupe,Special Coupe	22045
1980	V8-5.2L	318 CID	Max Cooling; Special Coupe,Special Coupe	22054
1980	V8-5.9L	360 CID	Max Cooling; Special Coupe,Special Coupe	22054
<b>MONACO</b>				
1977-1978	L6-3.7L	225 CID		22026
1975-1978	V8-5.2L	318 CID		22026
1968-1970	V8-5.2L	318 CID		22054
1974-1978	V8-5.9L	360 CID		22026
1971-1973	V8-5.9L	360 CID		22054
1965-1971	V8-6.3L	383 CID		22054
1972-1978	V8-6.6L	400 CID		22026

Years	Engine	Disp.	Application Description	USMW
1965	V8-6.7L	413 CID		22043
1966-1978	V8-7.2L	440 CID		22054
<b>NITRO</b>				
2009	V6-3.7L	226 CID	SE,SLT	22151
2010	V6-3.7L	226 CID	SE,SXT	22151
2011	V6-3.7L	226 CID	Heat	22164
2009	V6-4.0L	3952cc	R/T	22151
2010	V6-4.0L	3952cc	Detonator,Heat,Shock,SXT	22151
2011	V6-4.0L	3952cc	Detonator,Heat,Shock	22164
<b>PHOENIX</b>				
1960-1961	L6-3.7L	225 CID		22043
1960-1961	V8-5.2L	318 CID		22054
1960	V8-5.9L	361 CID		22054
1960	V8-6.3L	383 CID		22054
<b>PIONEER</b>				
1960-1961	L6-3.7L	225 CID		22043
1960-1961	V8-5.2L	318 CID		22054
1961	V8-5.9L	361 CID		22054
1960	V8-6.3L	383 CID		22054
<b>POLARA</b>				
1963-1971	L6-3.7L	225 CID		22026
1963-1973	V8-5.2L	318 CID		22054
1971-1973	V8-5.9L	360 CID		22054
1960-1962	V8-5.9L	361 CID		22054
1960-1971	V8-6.3L	383 CID		22054
1972-1973	V8-6.6L	400 CID		22026
1962-1965	V8-6.7L	413 CID		22043
1966-1973	V8-7.2L	440 CID		22054
<b>POWER RAM 50</b>				
1984	L4-2.0L	1995cc	RWD; Custom,Custom	22086
1983	L4-2.0L	1997cc	RWD; Custom,Custom	22092
1983	L4-2.3L	2346cc	Diesel; Sport	22073
1984	L4-2.3L	2346cc	Diesel; Royal,Sport	22073
1985	L4-2.3L	2346cc	Diesel; Royal	22073
1985	L4-2.6L	156 CID	RWD; Custom,Custom,Royal,Sport	22092
1986	L4-2.6L	156 CID	RWD; Custom,Custom,Sport	22092
1983	L4-2.6L	2555cc	RWD; Sport,Sport	22092
1984	L4-2.6L	2555cc	RWD; Custom,Custom,Royal,Sport	22092
<b>RAIDER</b>				
1987-1989	L4-2.6L	156 CID	Base	22092
1989	V6-3.0L	2972cc	Base	22073
<b>RAM 1500</b>				
2002	V6-3.7L	226 CID	Manual Trans; SLT,SLT,ST	22621
2003	V6-3.7L	226 CID	Manual Trans; Laramie,Laramie,SLT,ST	22621
2004-2006	V6-3.7L	226 CID	Manual Trans; ST,ST	22621
2007	V6-3.7L	226 CID	ST	22621
2008	V6-3.7L	226 CID	ST,SXT	22621
1994-1996	V6-3.9L	239 CID	Base	22160
1997-2001	V6-3.9L	239 CID	Laramie,Sport,ST,WS	22160
2009-2010	V8-4.7L	285 CID	SLT,ST,TRX,TRX4	22150
2005	V8-4.7L	285 CID	SLT,ST	22621
2006	V8-4.7L	285 CID	Laramie,SLT,ST,TRX4	22621
2007	V8-4.7L	285 CID	Auto Trans; SLT,SLT,ST,TRX4	22621
2008	V8-4.7L	285 CID	SLT,ST,SXT	22621
2002	V8-4.7L	287 CID	Auto Trans (Heavy Duty Cooling); SLT,SLT,ST	22621
2003	V8-4.7L	287 CID	Auto Trans (Heavy Duty Cooling); Laramie,Laramie,SLT,ST	22621
2004	V8-4.7L	287 CID	Auto Trans (Heavy Duty Cooling); SLT,SLT,ST	22621
1994-1996	V8-5.2L	318 CID	Base	22160
1997-2001	V8-5.2L	318 CID	Laramie,Sport,ST	22160
2009-2010	V8-5.7L	345 CID	Laramie,SLT,Sport,ST,TRX,TRX4	22059
2003	V8-5.7L	345 CID	Heavy Duty Cooling; Laramie,Laramie,SLT,ST	22620
2004	V8-5.7L	345 CID	SLT,ST	22620
2005	V8-5.7L	345 CID	Exc.Max Cooling; Hemi Sport,Hemi Sport,Laramie,Rumble Bee,SLT,ST	22621
2006-2007	V8-5.7L	345 CID	Exc.Heavy Duty Cooling; Laramie,Laramie,SLT,Sport,ST,TRX4	22621
2008	V8-5.7L	345 CID	Exc.Heavy Duty Cooling; Laramie,Laramie,SLT,ST,SXT	22621

**FAN CLUTCHES**

Years	Engine	Disp.	Application Description	USMW
1994-1996	V8-5.9L	360 CID	Max Cooling; Base,Base	22170
1997	V8-5.9L	360 CID	Max Cooling; Laramie,Laramie,Sport,ST	22170
1998-1999	V8-5.9L	360 CID	Snow Plow Package; Laramie,Laramie,Sport,ST	22170
2000	V8-5.9L	360 CID	Max Cooling (To 05/01/00); Laramie,Laramie,Sport,ST	22170
2001	V8-5.9L	360 CID	Snow Plow Package; Laramie,Laramie,Sport,ST	22170
2002	V8-5.9L	360 CID	SLT,ST	22621
2003	V8-5.9L	360 CID	Auto Trans (Heavy Duty Cooling); Laramie,Laramie,SLT,ST	22621
<b>RAM 1500 VAN</b>				
1999-2003	V6-3.9L	239 CID	Base	22160
1999-2003	V8-5.2L	318 CID	Exc.Heavy Duty Cooling; Base,Base	22160
1999-2003	V8-5.9L	360 CID	Exc.Heavy Duty Cooling; Base,Base	22160
<b>RAM 2500</b>				
1994-1999	L6-5.9L	359 CID	Diesel; Base	22070
2003	L6-5.9L	359 CID	Diesel; Base	22331
2004	L6-5.9L	359 CID	Diesel; SLT,ST	22331
2005	L6-5.9L	359 CID	Diesel; Laramie	22331
2006-2007	L6-5.9L	359 CID	Diesel; Laramie,SLT,Sport,ST,TRX4	22331
2008-2009	L6-5.9L	359 CID	Diesel; ST	22331
2000-2002	L6-5.9L	359 CID	Diesel; Base	22616
2007	L6-6.7L	408 CID	Diesel; Laramie,SLT,ST	22331
2008-2009	L6-6.7L	408 CID	Diesel; Laramie,SLT,ST,SXT	22331
1994-2003	V10-8.0L	488 CID	Base	22159
1994-1996	V8-5.2L	318 CID	Base	22160
2009	V8-5.7L	345 CID	Snow Plow Package; Laramie,Laramie,Power Wagon,SLT,ST,SXT	22059
2010	V8-5.7L	345 CID	Laramie,Power Wagon,SLT,ST,SXT	22059
2003	V8-5.7L	345 CID	Manual Trans (Snow Plow Package); Base,Base	22620
2004	V8-5.7L	345 CID	Snow Plow Package; SLT,SLT,ST	22620
2005	V8-5.7L	345 CID	Snow Plow Package; Laramie,Laramie,SLT,ST	22620
2006	V8-5.7L	345 CID	Snow Plow Package; Laramie,Laramie,Power Wagon,SLT,Sport,ST,TRX4	22620
2007	V8-5.7L	345 CID	Snow Plow Package (Manual Trans); Laramie,Laramie,Power Wagon,SLT,Sport,ST,TRX4	22620
2008	V8-5.7L	345 CID	Snow Plow Package (Manual Trans); Laramie,Laramie,Power Wagon,SLT,ST,SXT	22620
2002	V8-5.9L	360 CID	Max Cooling; Base,Base	22160
1994-1997	V8-5.9L	360 CID	Max Cooling; Base,Base	22170
1998-1999	V8-5.9L	360 CID	Exc.Max Cooling; Base,Base	22170
2000	V8-5.9L	360 CID	Max Cooling (To 05/01/00); Base,Base	22170
2001	V8-5.9L	360 CID	Snow Plow Package; Base,Base	22170
<b>RAM 2500 (MEX)</b>				
2007-2009	V8-4.7L	287 CID		22151
<b>RAM 2500 VAN</b>				
2001	V6-3.9L	239 CID	Base	22160
1999-2000	V8-5.2L	318 CID	LPG; Exc.Heavy Duty Cooling; Base,Base	22160
2001-2003	V8-5.2L	318 CID	Exc.Heavy Duty Cooling; Base,Base	22160
1999-2003	V8-5.9L	360 CID	Exc.Heavy Duty Cooling; Base,Base	22160
<b>RAM 3500</b>				
1994-1999	L6-5.9L	359 CID	Diesel; Base	22070
2003	L6-5.9L	359 CID	Diesel; Base	22331
2004	L6-5.9L	359 CID	Diesel; SLT,ST	22331
2005	L6-5.9L	359 CID	Diesel; Laramie,SLT,ST	22331
2006	L6-5.9L	359 CID	Diesel; Laramie,SLT,Sport,ST	22331
2007	L6-5.9L	359 CID	Diesel; Laramie,SLT,Sport,ST,TRX4	22331
2008-2009	L6-5.9L	359 CID	Diesel; ST	22331
2000-2002	L6-5.9L	359 CID	Diesel; Base	22616
2007	L6-6.7L	408 CID	Diesel; Laramie,SLT,Sport,ST	22331
2008-2010	L6-6.7L	408 CID	Diesel; Laramie,SLT,ST,SXT	22331
1994-2003	V10-8.0L	488 CID	Base	22159
2009	V8-5.7L	345 CID	Snow Plow Package; Laramie,Laramie,SLT,ST,SXT	22059
2003	V8-5.7L	345 CID	Manual Trans (Snow Plow Package); Base,Base	22620
2004	V8-5.7L	345 CID	Snow Plow Package; SLT,SLT,ST	22620
2005	V8-5.7L	345 CID	Snow Plow Package; Laramie,Laramie,SLT,ST	22620
2006	V8-5.7L	345 CID	Snow Plow Package; Laramie,Laramie,SLT,Sport,ST	22620
2007	V8-5.7L	345 CID	Snow Plow Package (Manual Trans); Laramie,Laramie,SLT,Sport,ST	22620
2008	V8-5.7L	345 CID	Snow Plow Package (Manual Trans); Laramie,Laramie,SLT,ST,SXT	22620

Years	Engine	Disp.	Application Description	USMW
2002	V8-5.9L	360 CID	Exc.Max Cooling; Base,Base	22160
1994-1997	V8-5.9L	360 CID	Max Cooling; Base,Base	22170
1998-1999	V8-5.9L	360 CID	Snow Plow Package; Base,Base	22170
2000	V8-5.9L	360 CID	Max Cooling (To 05/01/00); Base,Base	22170
2001	V8-5.9L	360 CID	Snow Plow Package; Base,Base	22170
<b>RAM 3500 VAN</b>				
1999-2000	V8-5.2L	318 CID	LPG; Exc.Heavy Duty Cooling; Base,Base	22160
2001-2003	V8-5.2L	318 CID	Exc.Heavy Duty Cooling; Base,Base	22160
1999-2003	V8-5.9L	360 CID	Exc.Heavy Duty Cooling; Base,Base	22160
<b>RAM 4500</b>				
2008-2010	L6-6.7L	408 CID	Diesel; Laramie,SLT,ST	22331
<b>RAM 50</b>				
1984	L4-2.0L	122 CID	RWD; Custom,Custom,Royal	22086
1985-1986	L4-2.0L	122 CID	Custom	22086
1987	L4-2.0L	122 CID	Base,Custom	22086
1988-1989	L4-2.0L	122 CID	Base	22086
1983	L4-2.0L	122 CID	RWD; Custom,Custom	22092
1983-1984	L4-2.3L	143 CID	Diesel; Royal,Sport	22073
1985	L4-2.3L	143 CID	Diesel; Royal	22073
1990-1991	L4-2.4L	2351cc	RWD; Base,Base,LE,SE	22086
1992-1993	L4-2.4L	2351cc	RWD; Base,Base,SE	22086
1983	L4-2.6L	156 CID	RWD; Royal,Royal,Sport	22092
1984-1985	L4-2.6L	156 CID	RWD; Custom,Custom,Royal,Sport	22092
1986	L4-2.6L	156 CID	RWD; Custom,Custom,Sport	22092
1987-1989	L4-2.6L	156 CID	Base,Custom,Sport	22092
1990-1991	V6-3.0L	2972cc	RWD; Base,Base,LE,SE	22086
<b>RAM 5500</b>				
2008-2010	L6-6.7L	408 CID	Diesel; Laramie,SLT,ST	22331
<b>RAMCHARGER</b>				
1980	L6-3.7L	225 CID	A/C; Base,Base,SE	22043
1990	V8-5.2L	318 CID	Base,Royal SE	22026
1991	V8-5.2L	318 CID	Base,Canyon Sport,Royal SE	22026
1982-1983	V8-5.2L	318 CID	Max Cooling (A/C); Base,Base,Royal SE	22043
1984-1985	V8-5.2L	318 CID	A/C (Exc.Max Cooling); Base,Base,Royal SE	22043
1986-1989	V8-5.2L	318 CID	A/C; Base,Base,Royal SE	22043
1980	V8-5.2L	318 CID	A/C; Base,Base,SE	22045
1981	V8-5.2L	318 CID	A/C; Base,Base,Royal SE	22045
1992-1993	V8-5.2L	318 CID	Max Cooling; Base,Base,Canyon Sport,Royal SE	22170
1991	V8-5.9L	360 CID	Base,Canyon Sport,Royal SE	22026
1984-1985	V8-5.9L	360 CID	A/C (Exc.Max Cooling); Base,Base,Royal SE	22043
1986-1987	V8-5.9L	360 CID	A/C; Base,Base,Royal SE	22043
1988-1989	V8-5.9L	360 CID	A/C; Base,Base,Royal SE	22043
1990	V8-5.9L	360 CID	Base	22043
1980	V8-5.9L	360 CID	A/C; Base,Base,SE	22045
1981	V8-5.9L	360 CID	A/C; Base,Base,Royal SE	22045
1992	V8-5.9L	360 CID	Base,Canyon Sport,Royal SE	22045
1993	V8-5.9L	360 CID	Max Cooling; Base,Base,Canyon Sport,Royal SE	22170
<b>RAMCHARGER (MEX)</b>				
1999-2001	V8-5.2L	318 CID		22160
1994-2000	V8-5.9L	360 CID		22151
<b>RAMCHARGER 2WD</b>				
1975-1979	L6-3.7L	225 CID		22026
1975-1979	V8-5.2L	318 CID		22026
1975-1979	V8-5.9L	360 CID		22026
1976-1978	V8-6.6L	400 CID		22026
1975-1978	V8-7.2L	440 CID		22045
<b>RAMCHARGER 4WD</b>				
1974-1978	L6-3.7L	225 CID		22026
1974-1979	V8-5.2L	318 CID		22026
1974-1979	V8-5.9L	360 CID		22026
1974-1978	V8-6.6L	400 CID		22026
1974-1978	V8-7.2L	440 CID		22045
<b>RD200</b>				
1980	V8-5.2L	318 CID	A/C; Base,Base	22045
1980	V8-5.9L	360 CID	A/C; Base,Base	22045
<b>ROYAL MONACO</b>				
1975-1977	V8-5.2L	318 CID		22026
1975-1977	V8-5.9L	360 CID		22026

Years	Engine	Disp.	Application Description	USMW
1975-1977	V8-6.6L	400 CID		22026
1975-1977	V8-7.2L	440 CID		22026
<b>SENECA</b>				
1960-1961	L6-3.7L	225 CID		22043
1960	V8-5.2L	318 CID		22054
1961	V8-5.9L	361 CID		22054
<b>SPRINTER 2500</b>				
2003-2006	L5-2.7L	165 CID	Diesel; Base	22328
2007-2009	V6-3.0L	2987cc	Diesel; Base	22333
2007-2008	V6-3.5L	3498cc	Base	22070
<b>SPRINTER 3500</b>				
2003-2006	L5-2.7L	165 CID	Diesel; Base	22328
2007-2009	V6-3.0L	2987cc	Diesel; Base	22333
2007-2008	V6-3.5L	3498cc	Base	22070
<b>ST REGIS</b>				
1979	L6-3.7L	225 CID		22026
1979	V8-5.2L	318 CID		22026
1979	V8-5.9L	360 CID		22026
<b>ST. REGIS</b>				
1980	L6-3.7L	225 CID	A/C; Base	22043
1981	L6-3.7L	225 CID	A/C; Base,Base	22043
1981	V8-5.2L	318 CID	A/C; Base,Base	22045
1980	V8-5.2L	318 CID	Max Cooling; Base,Base	22054
1980	V8-5.9L	360 CID	Max Cooling; Base,Base	22054
<b>W100</b>				
1986-1987	L6-3.7L	225 CID	Max Cooling (A/C); Custom,Custom	22043
1989	V6-3.9L	239 CID	A/C; Custom,Custom	22043
1986-1989	V8-5.2L	318 CID	A/C; Custom,Custom	22043
1986-1987	V8-5.9L	360 CID	A/C; Custom,Custom	22043
1988	V8-5.9L	360 CID	A/C; Custom,Custom	22043
<b>W100 1/2 TON</b>				
1961-1977	L6-3.7L	225 CID		22026
1960-1977	V8-5.2L	318 CID		22026
1972-1977	V8-5.9L	360 CID		22026
1964-1971	V8-6.3L	383 CID		22043
1971-1977	V8-6.6L	400 CID		22026
1974-1977	V8-7.2L	440 CID		22054
<b>W150</b>				
1982-1983	L6-3.7L	225 CID	Max Cooling; Base	22026
1980-1981	L6-3.7L	225 CID	A/C; Base,Base	22043
1984-1987	L6-3.7L	225 CID	Max Cooling (A/C); Base,Base	22043
1990-1991	V6-3.9L	239 CID	Base,S	22026
1989	V6-3.9L	239 CID	A/C; Base,Base	22043
1992-1993	V6-3.9L	239 CID	Base	22170
1990-1991	V8-5.2L	318 CID	Base,S	22026
1982-1983	V8-5.2L	318 CID	Max Cooling (A/C); Base,Base	22043
1984-1985	V8-5.2L	318 CID	A/C (Exc.Max Cooling); Base,Base	22043
1986-1989	V8-5.2L	318 CID	A/C; Base,Base	22043
1980-1981	V8-5.2L	318 CID	A/C; Base,Base	22045
1992-1993	V8-5.2L	318 CID	Max Cooling; Base,Base	22170
1990	V8-5.9L	360 CID	Base	22026
1991	V8-5.9L	360 CID	Base,S	22026
1984-1985	V8-5.9L	360 CID	A/C (Exc.Max Cooling); Base,Base	22043
1986-1987	V8-5.9L	360 CID	A/C; Base,Base	22043
1988-1989	V8-5.9L	360 CID	A/C; Base,Base	22043
1980-1981	V8-5.9L	360 CID	A/C; Base,Base	22045
1993	V8-5.9L	360 CID	Max Cooling; Base,Base	22170
<b>W150 1/2 TON</b>				
1978-1979	L6-3.7L	225 CID		22026
1977-1979	V8-5.2L	318 CID		22026
1977-1979	V8-5.9L	360 CID		22026
1977-1978	V8-6.6L	400 CID		22026
1978	V8-7.2L	440 CID		22026
<b>W200</b>				
1980	L6-3.7L	225 CID	A/C; Base,Base	22043
1980	V8-5.2L	318 CID	A/C; Base,Base	22045
1980	V8-5.9L	360 CID	A/C; Base,Base	22045

Years	Engine	Disp.	Application Description	USMW
<b>W200 3/4 TON</b>				
1961-1979	L6-3.7L	225 CID		22026
1960-1979	V8-5.2L	318 CID		22026
1971-1979	V8-5.9L	360 CID		22026
1968-1971	V8-6.3L	383 CID		22026
1964-1967	V8-6.3L	383 CID		22043
1971-1978	V8-6.6L	400 CID		22026
1975-1978	V8-7.2L	440 CID		22054
<b>W250</b>				
1989	L6-5.9L	359 CID	Diesel; Base	22070
1990-1993	L6-5.9L	359 CID	Diesel; Intercooler; Base,Base	22070
1990-1991	V8-5.2L	318 CID	Base	22026
1982-1983	V8-5.2L	318 CID	Max Cooling (A/C); Base,Base	22043
1984-1985	V8-5.2L	318 CID	A/C (Exc.Max Cooling); Base,Base	22043
1986-1989	V8-5.2L	318 CID	A/C; Base,Base	22043
1981	V8-5.2L	318 CID	A/C; Base,Base	22045
1992-1993	V8-5.2L	318 CID	Max Cooling; Base,Base	22170
1990-1991	V8-5.9L	360 CID	Base	22026
1982	V8-5.9L	360 CID	Max Cooling (A/C); Base,Base	22043
1984-1985	V8-5.9L	360 CID	A/C (Exc.Max Cooling); Base,Base	22043
1986-1987	V8-5.9L	360 CID	A/C; Base,Base	22043
1988-1989	V8-5.9L	360 CID	A/C; Base,Base	22043
1981	V8-5.9L	360 CID	A/C; Base,Base	22045
1992	V8-5.9L	360 CID	Base	22045
1993	V8-5.9L	360 CID	Max Cooling; Base,Base	22170
<b>W300</b>				
1980	V8-5.2L	318 CID	A/C; Base,Base	22045
1980	V8-5.9L	360 CID	A/C; Base,Base	22045
<b>W300 1 TON</b>				
1963-1978	L6-3.7L	225 CID		22026
1960-1978	V8-5.2L	318 CID		22026
1972-1979	V8-5.9L	360 CID		22026
1976-1978	V8-6.6L	400 CID		22026
1975-1978	V8-7.2L	440 CID		22054
<b>W350</b>				
1989	L6-5.9L	359 CID	Diesel; Base	22070
1990-1993	L6-5.9L	359 CID	Diesel; Intercooler; Base,Base	22070
1982-1983	V8-5.2L	318 CID	Max Cooling (A/C); Base,Base	22043
1990-1991	V8-5.9L	360 CID	Base	22026
1982-1983	V8-5.9L	360 CID	Max Cooling (A/C); Base,Base	22043
1984-1985	V8-5.9L	360 CID	A/C (Exc.Max Cooling); Base,Base	22043
1986-1987	V8-5.9L	360 CID	A/C; Base,Base	22043
1988-1989	V8-5.9L	360 CID	A/C; Base,Base	22043
1981	V8-5.9L	360 CID	A/C; Base,Base	22045
1992	V8-5.9L	360 CID	Base	22045
1993	V8-5.9L	360 CID	Max Cooling; Base,Base	22170
<b>WM300 1 TON</b>				
1960-1962	V8-5.2L	318 CID		22026
<b>FORD</b>				
<b>AEROSTAR</b>				
1986-1987	L4-2.3L	140 CID	A/C; Base,Base,XL,XLT	22044
1986	V6-2.8L	171 CID	Exc.A/C; Base,Base,XL,XLT	22065
1986-1987	V6-3.0L	182 CID	Exc.A/C; Base,Base,XL,XLT	22064
1988	V6-3.0L	182 CID	Exc.A/C; Base,Base,Eddie Bauer,XL,XLT	22064
1989	V6-3.0L	182 CID	Exc.A/C; Base,Base,Eddie Bauer,XL,XL Plus,XLT, XLT Plus	22064
1990	V6-3.0L	182 CID	Base,Eddie Bauer,XL,XL Plus,XLT,XLT Plus	22064
1991	V6-3.0L	182 CID	Base,Eddie Bauer,XL,XL Plus,XL Sport,XLT,XLT Plus, XLT Sport	22064
1992-1994	V6-3.0L	182 CID	Base,XL,XL Plus,XL Sport,XLT,XLT Plus,XLT Sport	22064
1995-1997	V6-3.0L	182 CID	Base,XLT,XLT Plus,XLT Sport	22064
1990	V6-4.0L	245 CID	Manual Trans; Base,Base,Base 4WD,Eddie Bauer, Eddie Bauer 4WD,Eddie Bauer E4WD,XL 4WD, XL E4WD,XL Plus,XL Plus 4WD,XL Plus E4WD,XLT 4WD,XLT E4WD,XLT Plus,XLT Plus 4WD, XLT Plus E4WD	22167

**FAN CLUTCHES**



Years	Engine	Disp.	Application Description	USMW
1991-1994	V6-4.0L	245 CID	Manual Trans; Base,Base,Base 4WD,Eddie Bauer, Eddie Bauer 4WD,Eddie Bauer E4WD,XL,XL 4WD, XL E4WD,XL Plus,XL Plus 4WD,XL Plus E4WD, XL Sport,XLT,XLT 4WD,XLT E4WD,XLT Plus, XLT Plus 4WD,XLT Plus E4WD,XLT Sport	22167
1995	V6-4.0L	245 CID	Manual Trans; Base,Base,Base 4WD,XLT,XLT 4WD, XLT E4WD,XLT Plus,XLT Plus 4WD,XLT Plus E4WD, XLT Sport	22167
1996-1997	V6-4.0L	245 CID	Manual Trans; Base,Base,XLT,XLT 4WD,XLT E4WD, XLT Plus,XLT Plus 4WD,XLT Plus E4WD,XLT Sport	22167
<b>BRONCO</b>				
1966-1972	L6-2.8L	170 CID		22012
1973-1974	L6-3.3L	200 CID		22012
1987-1991	L6-4.9L	300 CID		22011
1983	L6-4.9L	300 CID	Custom,XLS,XLT Lariat	22054
1980-1984	L6-4.9L	300 CID		22061
1984	L6-4.9L	300 CID	Exc.A/C; Custom,Custom,XLT	22061
1985	L6-4.9L	300 CID		22061
1985	L6-4.9L	300 CID	Exc.A/C; Custom,Custom,Eddie Bauer,XLT	22061
1986	L6-4.9L	300 CID		22061
1986	L6-4.9L	300 CID	Exc.A/C; Custom,Custom,Eddie Bauer,XLT	22061
1987-1989	L6-4.9L	300 CID	Exc.A/C; Custom,Custom,Eddie Bauer,XLT	22161
1990-1991	L6-4.9L	300 CID	Exc.A/C; Custom,Custom,Eddie Bauer,XL,XLT	22161
1992	L6-4.9L	300 CID	Exc.A/C; Custom,Custom,Eddie Bauer,XL,XLT,Nite	22161
1966-1968	V8-4.7L	289 CID		22011
1968-1991	V8-5.0L	302 CID		22011
1980-1981	V8-5.0L	302 CID	A/C; Custom,Ranger XLT	22054
1982-1983	V8-5.0L	302 CID	A/C; Custom,XLS,XLT Lariat	22054
1984	V8-5.0L	302 CID	A/C; Custom,Custom,XLT	22054
1985-1986	V8-5.0L	302 CID	A/C; Custom,Custom,Eddie Bauer,XLT	22054
1987-1989	V8-5.0L	302 CID	Exc.A/C; Custom,Custom,Eddie Bauer,XLT	22146
1990-1991	V8-5.0L	302 CID	Exc.A/C; Custom,Custom,Eddie Bauer,XL,XLT	22146
1992	V8-5.0L	302 CID	Exc.A/C; Custom,Custom,Eddie Bauer,XL,XLT,Nite	22146
1993	V8-5.0L	302 CID	Exc.A/C; Custom,Custom,Eddie Bauer,XL,XLT Lariat	22146
1994	V8-5.0L	302 CID	Exc.A/C; Eddie Bauer,Eddie Bauer,XL,XLT	22146
1995-1996	V8-5.0L	302 CID	Exc.A/C; Eddie Bauer,Eddie Bauer,XL,XLT,Sport	22146
1978-1991	V8-5.8L	351 CID		22011
1980-1981	V8-5.8L	351 CID	A/C; Custom,Ranger XLT	22054
1982-1983	V8-5.8L	351 CID	A/C; Custom,XLS,XLT Lariat	22054
1984	V8-5.8L	351 CID	A/C; Custom,Custom,XLT	22054
1985-1987	V8-5.8L	351 CID	A/C; Custom,Custom,Eddie Bauer,XLT	22054
1988	V8-5.8L	351 CID	Exc.A/C; Custom,Custom,Eddie Bauer,XLT	22146
1989	V8-5.8L	351 CID	Exc.A/C; Custom,Custom,Eddie Bauer,XLT	22146
1990-1991	V8-5.8L	351 CID	Exc.A/C; Custom,Custom,Eddie Bauer,XL,XLT	22146
1992	V8-5.8L	351 CID	Exc.A/C; Custom,Custom,Eddie Bauer,XL,XLT,Nite	22146
1993	V8-5.8L	351 CID	Exc.A/C; Custom,Custom,Eddie Bauer,XL,XLT Lariat	22146
1994	V8-5.8L	351 CID	Exc.A/C; Eddie Bauer,Eddie Bauer,XL,XLT	22146
1995-1996	V8-5.8L	351 CID	Exc.A/C; Eddie Bauer,Eddie Bauer,XL,XLT,Sport	22146
1978-1979	V8-6.6L	400 CID		22011
<b>BRONCO II</b>				
1984-1985	V6-2.8L	171 CID	Exc.A/C; Base,Base,Eddie Bauer,XLS,XLT	22060
1986	V6-2.9L	177 CID	Exc.A/C; Base,Base,Eddie Bauer,XLT	22060
1987	V6-2.9L	177 CID	Exc.A/C; Eddie Bauer,Eddie Bauer,XL,XLT	22060
1988	V6-2.9L	177 CID	Exc.A/C; Eddie Bauer,Eddie Bauer,XL,XL Sport,XLT	22060
1989-1990	V6-2.9L	177 CID	Exc.A/C; Eddie Bauer,Eddie Bauer,XL,XL Sport,XLT,XLT Plus	22060
<b>COUGAR (MEX)</b>				
1985-1996	L6-3.8L	232 CID		22126
1991-1994	V8-4.9L	299 CID		22163
<b>COUNTRY SQUIRE</b>				
1967	V8-4.7L	289 CID		22016
1979	V8-5.0L	302 CID		22011
1987-1989	V8-5.0L	302 CID	Exc.A/C; Base,Base,LX	22011
1990-1991	V8-5.0L	302 CID	Towing Package; Base,Base,LX	22011
1968-1972	V8-5.0L	302 CID		22016
1979	V8-5.8L	351 CID		22011
1969-1974	V8-5.8L	351 CID		22016
1968-1971	V8-6.4L	390 CID		22016
1975-1976	V8-6.6L	400 CID		22011

Years	Engine	Disp.	Application Description	USMW
1971-1974	V8-6.6L	400 CID		22016
1967-1968	V8-7.0L	427 CID		22016
1967-1969	V8-7.0L	428 CID		22016
1969-1973	V8-7.0L	429 CID		22016
1975-1976	V8-7.5L	460 CID		22012
1972-1974	V8-7.5L	460 CID		22038
<b>CROWN VICTORIA</b>				
1992	V8-4.6L	281 CID	Police (Towing Package) (To 03/92); Base,Base,LX,S, Touring Sedan	22169
1993	V8-4.6L	281 CID	Police (Towing Package); Base,Base,LX, Police Interceptor,S	22169
1994-2001	V8-4.6L	281 CID	Base,LX,Police Interceptor,S	22169
2002-2003	V8-4.6L	281 CID	Base,LWB,LX,Police Interceptor,S	22169
2004	V8-4.6L	281 CID	Base,LX,LX Sport,Police Interceptor	22169
2005	V8-4.6L	281 CID	Base,LX,LX Sport,Police Interceptor,S,Special Edition	22169
2006	V8-4.6L	281 CID	Base,LX,LX Sport,Police Interceptor	22169
<b>CUSTOM</b>				
1967-1972	L6-3.9L	240 CID		22011
1965-1966	L6-3.9L	240 CID		22012
1964-1968	V8-4.7L	289 CID		22011
1968-1972	V8-5.0L	302 CID		22011
1969-1972	V8-5.8L	351 CID		22011
1964-1966	V8-5.8L	352 CID		22011
1964-1971	V8-6.4L	390 CID		22011
1971-1972	V8-6.6L	400 CID		22011
1968	V8-7.0L	427 CID		22011
1964-1967	V8-7.0L	427 CID		22012
1968-1970	V8-7.0L	428 CID		22011
1966-1967	V8-7.0L	428 CID		22012
1969-1972	V8-7.0L	429 CID		22011
<b>CUSTOM 500</b>				
1973-1977	V8-5.8L	351 CID		22016
1973-1977	V8-6.6L	400 CID		22016
1973	V8-7.0L	429 CID		22016
1973-1976	V8-7.5L	460 CID		22038
<b>E100 1/2 TON VAN</b>				
1968-1971	L6-2.8L	170 CID		22012
1962-1966	L6-2.8L	170 CID		22038
1968-1974	L6-3.9L	240 CID		22012
1972-1979	L6-4.9L	300 CID		22016
1968-1979	V8-5.0L	302 CID		22016
1975-1979	V8-5.8L	351 CID		22016
<b>E-100 ECONOLINE</b>				
1983	L6-4.9L	300 CID	Exc.A/C; Custom,Custom,XL	22061
1980-1982	V8-5.0L	302 CID	A/C; Base,Chateau,Custom	22054
1983	V8-5.0L	302 CID	A/C; Custom,Custom,XL	22054
1980-1982	V8-5.8L	351 CID	A/C; Base,Chateau,Custom	22054
1983	V8-5.8L	351 CID	A/C; Custom,Custom,XL	22054
<b>E-100 ECONOLINE CLUB WAGON</b>				
1983	L6-4.9L	300 CID	Exc.A/C; Custom,Custom,XL	22061
1980-1982	V8-5.0L	302 CID	A/C; Base,Chateau,Custom	22054
1983	V8-5.0L	302 CID	A/C; Custom,Custom,XL	22054
1980-1982	V8-5.8L	351 CID	A/C; Base,Chateau,Custom	22054
1983	V8-5.8L	351 CID	A/C; Custom,Custom,XL	22054
<b>E-150</b>				
2003	V6-4.2L	256 CID	Exc.A/C; Base,Base	22168
2003-2005	V8-4.6L	281 CID	Exc.A/C; Base,Base	22168
2006	V8-4.6L	281 CID	Exc.A/C; Base,Base,Chateau,XL,XLT	22168
2007	V8-4.6L	281 CID	Exc.A/C (To 10/16/06); Base,Base,Chateau,XL,XLT	22168
2008-2014	V8-4.6L	281 CID	Exc.A/C; Base,Base,XL,XLT	22168
2003-2005	V8-5.4L	330 CID	Exc.A/C; Base,Base	22168
2006	V8-5.4L	330 CID	Exc.A/C; Base,Base,Chateau,XL,XLT	22168
2007	V8-5.4L	330 CID	Exc.A/C (To 10/16/06); Base,Base,Chateau,XL,XLT	22168
2008-2009	V8-5.4L	330 CID	Exc.A/C; Base,Base,XL,XLT	22168
2010-2014	V8-5.4L	330 CID	LPG; Exc.A/C; Base,Base,XL,XLT	22168
<b>E150 1/2 TON VAN</b>				
1975-1979	L6-4.9L	300 CID		22016
1979	V8-5.0L	302 CID		22016



Years	Engine	Disp.	Application Description	USMW
1975-1979	V8-5.8L	351 CID		<b>22016</b>
<b>E-150 CLUB WAGON</b>				
2003	V6-4.2L	256 CID	Exc.A/C; Chateau,Chateau,XL,XLT	<b>22168</b>
2003-2005	V8-4.6L	281 CID	Exc.A/C; Chateau,Chateau,XL,XLT	<b>22168</b>
2003-2005	V8-5.4L	330 CID	Exc.A/C; Chateau,Chateau,XL,XLT	<b>22168</b>
<b>E-150 ECONOLINE</b>				
1983	L6-4.9L	300 CID	LPG; Exc.A/C; Custom,Custom,XL	<b>22061</b>
1984-1985	L6-4.9L	300 CID	LPG; Exc.A/C; Base,Base,XL	<b>22061</b>
1986	L6-4.9L	300 CID	Exc.A/C; Base,Base,XL	<b>22061</b>
1992-1996	L6-4.9L	300 CID	Exc.A/C; Base,Base,XL	<b>22155</b>
1987-1991	L6-4.9L	300 CID	Exc.A/C; Custom,Custom,XL	<b>22161</b>
1997-2000	V6-4.2L	256 CID	Exc.A/C; Base,Base,XL	<b>22168</b>
2001-2002	V6-4.2L	256 CID	Exc.A/C; Base,Base	<b>22168</b>
1997-2000	V8-4.6L	281 CID	Exc.A/C; Base,Base,XL	<b>22168</b>
2001-2002	V8-4.6L	281 CID	Exc.A/C; Base,Base	<b>22168</b>
1980-1981	V8-5.0L	302 CID	Base,Chateau,Custom	<b>22054</b>
1982	V8-5.0L	302 CID	To 02/01/82; Base,Base,Chateau,Custom	<b>22054</b>
1983	V8-5.0L	302 CID	A/C; Custom,Custom,XL	<b>22054</b>
1984-1986	V8-5.0L	302 CID	A/C; Base,Base,XL	<b>22054</b>
1987-1991	V8-5.0L	302 CID	Exc.A/C; Custom,Custom,XL	<b>22146</b>
1992-1996	V8-5.0L	302 CID	Exc.A/C; Base,Base,XL	<b>22146</b>
1997-2000	V8-5.4L	330 CID	Exc.A/C; Base,Base,XL	<b>22168</b>
2001-2002	V8-5.4L	330 CID	Exc.A/C; Base,Base	<b>22168</b>
1980-1982	V8-5.8L	351 CID	Base,Chateau,Custom	<b>22054</b>
1983	V8-5.8L	351 CID	A/C; Custom,Custom,XL	<b>22054</b>
1984-1986	V8-5.8L	351 CID	A/C; Base,Base,XL	<b>22054</b>
1987	V8-5.8L	351 CID	A/C; Custom,Custom,XL	<b>22054</b>
1988	V8-5.8L	351 CID	Exc.A/C; Custom,Custom,XL	<b>22146</b>
1989	V8-5.8L	351 CID	Exc.A/C; Custom,Custom,XL	<b>22146</b>
1990-1991	V8-5.8L	351 CID	Exc.A/C; Custom,Custom,XL	<b>22146</b>
1992-1996	V8-5.8L	351 CID	Exc.A/C; Base,Base,XL	<b>22146</b>
<b>E-150 ECONOLINE CLUB WAGON</b>				
1983	L6-4.9L	300 CID	Exc.A/C; Custom,Custom,XL	<b>22061</b>
1984-1986	L6-4.9L	300 CID	Exc.A/C; Base,Base,XL,XLT	<b>22061</b>
1992-1996	L6-4.9L	300 CID	Exc.A/C; Chateau,Chateau,Custom,XLT	<b>22155</b>
1987-1991	L6-4.9L	300 CID	Exc.A/C; Custom,Custom,XL,XLT	<b>22161</b>
1997-2000	V6-4.2L	256 CID	Exc.A/C; Chateau,Chateau,Custom,XLT	<b>22168</b>
2001-2002	V6-4.2L	256 CID	Exc.A/C; Chateau,Chateau,XL,XLT	<b>22168</b>
1997-2000	V8-4.6L	281 CID	Exc.A/C; Chateau,Chateau,Custom,XLT	<b>22168</b>
2001-2002	V8-4.6L	281 CID	Exc.A/C; Chateau,Chateau,XL,XLT	<b>22168</b>
1980-1981	V8-5.0L	302 CID	Base,Chateau,Custom	<b>22054</b>
1982	V8-5.0L	302 CID	To 02/01/82; Base,Base,Chateau,Custom	<b>22054</b>
1983	V8-5.0L	302 CID	A/C; Custom,Custom,XL	<b>22054</b>
1984-1986	V8-5.0L	302 CID	A/C; Base,Base,XL,XLT	<b>22054</b>
1987-1991	V8-5.0L	302 CID	Exc.A/C; Custom,Custom,XL,XLT	<b>22146</b>
1992-1996	V8-5.0L	302 CID	Exc.A/C; Chateau,Chateau,Custom,XLT	<b>22146</b>
1997-2000	V8-5.4L	330 CID	Exc.A/C; Chateau,Chateau,Custom,XLT	<b>22168</b>
2001-2002	V8-5.4L	330 CID	Exc.A/C; Chateau,Chateau,XL,XLT	<b>22168</b>
1980-1982	V8-5.8L	351 CID	Base,Chateau,Custom	<b>22054</b>
1983	V8-5.8L	351 CID	A/C; Custom,Custom,XL	<b>22054</b>
1984-1986	V8-5.8L	351 CID	A/C; Base,Base,XL,XLT	<b>22054</b>
1987	V8-5.8L	351 CID	A/C; Custom,Custom,XL,XLT	<b>22054</b>
1988	V8-5.8L	351 CID	Exc.A/C; Custom,Custom,XL,XLT	<b>22146</b>
1989	V8-5.8L	351 CID	Exc.A/C; Custom,Custom,XL,XLT	<b>22146</b>
1990-1991	V8-5.8L	351 CID	Exc.A/C; Custom,Custom,XL,XLT	<b>22146</b>
1992-1996	V8-5.8L	351 CID	Exc.A/C; Chateau,Chateau,Custom,XLT	<b>22146</b>
<b>E200 3/4 TON VAN</b>				
1968-1971	L6-2.8L	170 CID		<b>22012</b>
1968-1974	L6-3.9L	240 CID		<b>22012</b>
1972-1974	L6-4.9L	300 CID		<b>22016</b>
1968-1974	V8-5.0L	302 CID		<b>22016</b>
<b>E-250</b>				
2003	V6-4.2L	256 CID	Exc.A/C; Base,Base	<b>22168</b>
2003-2006	V8-4.6L	281 CID	Exc.A/C; Base,Base	<b>22168</b>
2007	V8-4.6L	281 CID	Exc.A/C (To 10/16/06); Base,Base	<b>22168</b>
2008-2014	V8-4.6L	281 CID	Exc.A/C; Base,Base	<b>22168</b>
2003-2006	V8-5.4L	330 CID	Exc.A/C; Base,Base	<b>22168</b>
2007	V8-5.4L	330 CID	Exc.A/C (To 10/16/06); Base,Base	<b>22168</b>
2008-2009	V8-5.4L	330 CID	Exc.A/C; Base,Base	<b>22168</b>

Years	Engine	Disp.	Application Description	USMW
2010-2014	V8-5.4L	330 CID	LPG; Exc.A/C; Base,Base	<b>22168</b>
<b>E250 3/4 TON VAN</b>				
1975-1979	L6-4.9L	300 CID		<b>22016</b>
1979	V8-5.0L	302 CID		<b>22016</b>
1975-1979	V8-5.8L	351 CID		<b>22016</b>
1975-1979	V8-7.5L	460 CID		<b>22012</b>
<b>E-250 ECONOLINE</b>				
1983	L6-4.9L	300 CID	LPG; Exc.A/C; Custom,Custom,XL	<b>22061</b>
1984-1985	L6-4.9L	300 CID	LPG; Exc.A/C; Base,Base,XL	<b>22061</b>
1986	L6-4.9L	300 CID	Exc.A/C; Base,Base,XL	<b>22061</b>
1992-1996	L6-4.9L	300 CID	Exc.A/C; Base,Base,XL	<b>22155</b>
1987-1991	L6-4.9L	300 CID	Exc.A/C; Custom,Custom,XL	<b>22161</b>
1997-2000	V6-4.2L	256 CID	Exc.A/C; Base,Base,XL	<b>22168</b>
2001-2002	V6-4.2L	256 CID	Exc.A/C; Base,Base	<b>22168</b>
1997	V8-4.6L	281 CID	Base,XL	<b>22168</b>
1980-1981	V8-5.0L	302 CID	Base,Chateau,Custom	<b>22054</b>
1982	V8-5.0L	302 CID	To 02/01/82; Base,Base,Chateau,Custom	<b>22054</b>
1983	V8-5.0L	302 CID	A/C; Custom,Custom,XL	<b>22054</b>
1984-1986	V8-5.0L	302 CID	A/C; Base,Base,XL	<b>22054</b>
1987-1989	V8-5.0L	302 CID	Exc.A/C; Custom,Custom,XL	<b>22146</b>
1990-1991	V8-5.0L	302 CID	Exc.A/C; Custom,Custom,XL	<b>22146</b>
1997-2000	V8-5.4L	330 CID	Exc.A/C; Base,Base,XL	<b>22168</b>
2001-2002	V8-5.4L	330 CID	Exc.A/C; Base,Base	<b>22168</b>
1980-1982	V8-5.8L	351 CID	Base,Chateau,Custom	<b>22054</b>
1983	V8-5.8L	351 CID	A/C; Custom,Custom,XL	<b>22054</b>
1984-1986	V8-5.8L	351 CID	A/C; Base,Base,XL	<b>22054</b>
1987	V8-5.8L	351 CID	A/C; Custom,Custom,XL	<b>22054</b>
1988	V8-5.8L	351 CID	Exc.A/C; Custom,Custom,XL	<b>22146</b>
1989	V8-5.8L	351 CID	Exc.A/C; Custom,Custom,XL	<b>22146</b>
1990-1991	V8-5.8L	351 CID	Exc.A/C; Custom,Custom,XL	<b>22146</b>
1992-1996	V8-5.8L	351 CID	Exc.A/C; Base,Base,XL	<b>22146</b>
1980	V8-6.6L	400 CID	Base,Chateau,Custom	<b>22054</b>
1980	V8-7.5L	460 CID	Base,Chateau,Custom	<b>22052</b>
<b>E-250 ECONOLINE CLUB WAGON</b>				
1983	L6-4.9L	300 CID	Exc.A/C; Custom,Custom,XL	<b>22061</b>
1984	L6-4.9L	300 CID	Exc.A/C; Base,Base,XL,XLT	<b>22061</b>
1985	L6-4.9L	300 CID	LPG; Exc.A/C; Base,Base,XL,XLT	<b>22061</b>
1986	L6-4.9L	300 CID	Exc.A/C; Base,Base,XL,XLT	<b>22061</b>
1987-1991	L6-4.9L	300 CID	Exc.A/C; Custom,Custom,XL,XLT	<b>22161</b>
1980	V8-5.0L	302 CID	Base,Chateau,Custom	<b>22054</b>
1980-1982	V8-5.8L	351 CID	Base,Chateau,Custom	<b>22054</b>
1983	V8-5.8L	351 CID	A/C; Custom,Custom,XL	<b>22054</b>
1984-1986	V8-5.8L	351 CID	A/C; Base,Base,XL,XLT	<b>22054</b>
1987	V8-5.8L	351 CID	A/C; Custom,Custom,XL,XLT	<b>22054</b>
1988	V8-5.8L	351 CID	Exc.A/C; Custom,Custom,XL,XLT	<b>22146</b>
1989	V8-5.8L	351 CID	Exc.A/C; Custom,Custom,XL,XLT	<b>22146</b>
1990-1991	V8-5.8L	351 CID	Exc.A/C; Custom,Custom,XL,XLT	<b>22146</b>
1980-1982	V8-6.6L	400 CID	Base,Chateau,Custom	<b>22054</b>
1983	V8-6.9L	420 CID	Diesel; Custom,XL	<b>22601</b>
1984-1986	V8-6.9L	420 CID	Diesel; Base,XL,XLT	<b>22601</b>
1987	V8-6.9L	420 CID	Diesel; Custom,XL,XLT	<b>22601</b>
1988-1991	V8-7.3L	445 CID	Diesel; Custom,XL,XLT	<b>22601</b>
1980-1982	V8-7.5L	460 CID	Base,Chateau,Custom	<b>22052</b>
1983	V8-7.5L	460 CID	Custom,XL	<b>22052</b>
1984-1986	V8-7.5L	460 CID	Base,XL,XLT	<b>22052</b>
1987-1991	V8-7.5L	460 CID	Custom,XL,XLT	<b>22052</b>
<b>E-250 SUPER DUTY</b>				
2004-2005	V8-5.4L	330 CID	Exc.A/C; Base,Base	<b>22168</b>
<b>E300 1 TON VAN</b>				
1969	L6-2.8L	170 CID		<b>22012</b>
1968-1974	L6-3.9L	240 CID		<b>22012</b>
1972-1974	L6-4.9L	300 CID		<b>22016</b>
1968-1974	V8-5.0L	302 CID		<b>22016</b>
<b>E-350</b>				
2003	V10-6.8L	415 CID	Exc.A/C; Base,Base	<b>22610</b>
2003	V8-5.4L	330 CID	Exc.A/C; Base,Base	<b>22168</b>
2003	V8-7.3L	445 CID	Diesel; Base	<b>22612</b>

Years	Engine	Disp.	Application Description	USMW
<b>E350 1 TON VAN</b>				
1975-1979	L6-4.9L	300 CID		22016
1979	V8-5.0L	302 CID		22016
1975-1979	V8-5.8L	351 CID		22016
1975-1979	V8-7.5L	460 CID		22012
<b>E-350 CLUB WAGON</b>				
2003-2005	V10-6.8L	415 CID	Exc.A/C; Chateau,Chateau,XL,XLT	22610
2003-2005	V8-5.4L	330 CID	Exc.A/C; Chateau,Chateau,XL,XLT	22168
2004-2005	V8-6.0L	363 CID	Diesel; Chateau,XL,XLT	22332
2003	V8-7.3L	445 CID	Diesel; Chateau,XL,XLT	22612
<b>E-350 ECONOLINE</b>				
1983	L6-4.9L	300 CID	LPG; Exc.A/C; Custom,Custom,XL	22061
1984-1985	L6-4.9L	300 CID	LPG; Exc.A/C; Base,Base,XL	22061
1986	L6-4.9L	300 CID	Exc.A/C; Base,Base,XL	22061
1992-1996	L6-4.9L	300 CID	Exc.A/C; Base,Base,XL	22155
1987-1991	L6-4.9L	300 CID	Exc.A/C; Custom,Custom,XL	22161
1997-2000	V10-6.8L	415 CID	Exc.A/C; Base,Base,XL	22610
2001-2002	V10-6.8L	415 CID	Exc.A/C; Base,Base	22610
1980-1981	V8-5.0L	302 CID	Base,Chateau,Custom	22054
1982	V8-5.0L	302 CID	To 02/01/82; Base,Base,Chateau,Custom	22054
1997-2000	V8-5.4L	330 CID	Exc.A/C; Base,Base,XL	22168
2001-2002	V8-5.4L	330 CID	Exc.A/C; Base,Base	22168
1980-1982	V8-5.8L	351 CID	Base,Chateau,Custom	22054
1983	V8-5.8L	351 CID	A/C; Custom,Custom,XL	22054
1984-1986	V8-5.8L	351 CID	A/C; Base,Base,XL	22054
1987	V8-5.8L	351 CID	A/C; Custom,Custom,XL	22054
1988	V8-5.8L	351 CID	Exc.A/C; Custom,Custom,XL	22146
1989	V8-5.8L	351 CID	Exc.A/C; Custom,Custom,XL	22146
1990-1991	V8-5.8L	351 CID	Exc.A/C; Custom,Custom,XL	22146
1992-1996	V8-5.8L	351 CID	Exc.A/C; Base,Base,XL	22146
1980-1982	V8-6.6L	400 CID	Base,Chateau,Custom	22054
1983	V8-6.9L	420 CID	Diesel; Custom,XL	22601
1984-1986	V8-6.9L	420 CID	Diesel; Base,XL	22601
1987	V8-6.9L	420 CID	Diesel; Custom,XL	22601
1988-1991	V8-7.3L	445 CID	Diesel; Custom,XL	22601
1992	V8-7.3L	445 CID	Diesel; From 02/14/92; Base,Base,XL	22607
1993-1997	V8-7.3L	445 CID	Diesel; Base,XL	22609
1998-2000	V8-7.3L	445 CID	Diesel; Base,XL	22612
2001-2002	V8-7.3L	445 CID	Diesel; Base	22612
1980-1982	V8-7.5L	460 CID	Base,Chateau,Custom	22052
1983	V8-7.5L	460 CID	Custom,XL	22052
1984-1986	V8-7.5L	460 CID	Base,XL	22052
1987-1991	V8-7.5L	460 CID	Custom,XL	22052
1992-1996	V8-7.5L	460 CID	Base,XL	22052
<b>E-350 ECONOLINE CLUB WAGON</b>				
1983	L6-4.9L	300 CID	Exc.A/C; Custom,Custom,XL	22061
1984-1986	L6-4.9L	300 CID	Exc.A/C; Base,Base,XL,XLT	22061
1992-1993	L6-4.9L	300 CID	Exc.A/C; Chateau,Chateau,Chateau HD,Custom,Custom HD,XLT,XLT HD	22155
1994-1996	L6-4.9L	300 CID	Exc.A/C; Chateau,Chateau,Chateau HD,Custom,XL HD,XLT,XLT HD	22155
1987-1989	L6-4.9L	300 CID	Exc.A/C; Custom,Custom,XL,XLT	22161
1990	L6-4.9L	300 CID	Exc.A/C; Custom,Custom,XL	22161
1991	L6-4.9L	300 CID	Exc.A/C; Custom,Custom,XL,XLT	22161
1997-1998	V10-6.8L	415 CID	Exc.A/C; Chateau,Chateau,Custom,XL HD,XLT,XLT HD	22610
1999-2000	V10-6.8L	415 CID	Exc.A/C; Chateau,Chateau,Custom,XLT	22610
2001-2002	V10-6.8L	415 CID	Exc.A/C; Chateau,Chateau,XL,XLT	22610
1980	V8-5.0L	302 CID	Base,Chateau,Custom	22054
1997-1998	V8-5.4L	330 CID	Exc.A/C; Chateau,Chateau,Custom,XL HD,XLT,XLT HD	22168
1999-2000	V8-5.4L	330 CID	Exc.A/C; Chateau,Chateau,Custom,XLT	22168
2001-2002	V8-5.4L	330 CID	Exc.A/C; Chateau,Chateau,XL,XLT	22168
1980-1982	V8-5.8L	351 CID	Base,Chateau,Custom	22054
1983	V8-5.8L	351 CID	A/C; Custom,Custom,XL	22054
1984-1986	V8-5.8L	351 CID	A/C; Base,Base,XL,XLT	22054
1987	V8-5.8L	351 CID	A/C; Custom,Custom,XL,XLT	22054
1988	V8-5.8L	351 CID	Exc.A/C; Custom,Custom,XL,XLT	22146
1989	V8-5.8L	351 CID	Exc.A/C; Custom,Custom,XL,XLT	22146
1990	V8-5.8L	351 CID	Exc.A/C; Custom,Custom,XL	22146

Years	Engine	Disp.	Application Description	USMW
1991	V8-5.8L	351 CID	Exc.A/C; Custom,Custom,XL,XLT	22146
1992-1993	V8-5.8L	351 CID	Exc.A/C; Chateau,Chateau,Chateau HD,Custom,Custom HD,XLT,XLT HD	22146
1994-1996	V8-5.8L	351 CID	Exc.A/C; Chateau,Chateau,Chateau HD,Custom,XL HD,XLT,XLT HD	22146
1980-1982	V8-6.6L	400 CID	Base,Chateau,Custom	22054
1983	V8-6.9L	420 CID	Diesel; Custom,XL	22601
1984-1986	V8-6.9L	420 CID	Diesel; Base,XL,XLT	22601
1987	V8-6.9L	420 CID	Diesel; Custom,XL,XLT	22601
1988-1989	V8-7.3L	445 CID	Diesel; Custom,XL,XLT	22601
1990	V8-7.3L	445 CID	Diesel; Custom,XL	22601
1991	V8-7.3L	445 CID	Diesel; Custom,XL,XLT	22601
1992	V8-7.3L	445 CID	Diesel; From 02/14/92; Chateau,Chateau,Chateau HD,Custom,Custom HD,XLT,XLT HD	22607
1993	V8-7.3L	445 CID	Diesel; Chateau,Chateau HD,Custom,Custom HD,XLT,XLT HD	22609
1994-1996	V8-7.3L	445 CID	Diesel; Chateau,Chateau HD,Custom,XL HD,XLT,XLT HD	22609
1997	V8-7.3L	445 CID	Diesel; Chateau,Custom,XL HD,XLT,XLT HD	22609
1998	V8-7.3L	445 CID	Diesel; Chateau,Custom,XL HD,XLT,XLT HD	22612
1999-2000	V8-7.3L	445 CID	Diesel; Chateau,Custom,XLT	22612
2001-2002	V8-7.3L	445 CID	Diesel; Chateau,XL,XLT	22612
1980-1982	V8-7.5L	460 CID	Base,Chateau,Custom	22052
1983	V8-7.5L	460 CID	Custom,XL	22052
1984-1986	V8-7.5L	460 CID	Base,XL,XLT	22052
1987-1989	V8-7.5L	460 CID	Custom,XL,XLT	22052
1990	V8-7.5L	460 CID	Custom,XL	22052
1991	V8-7.5L	460 CID	Custom,XL,XLT	22052
1992-1993	V8-7.5L	460 CID	Chateau,Chateau HD,Custom,Custom HD,XLT,XLT HD	22052
1994-1996	V8-7.5L	460 CID	Chateau,Chateau HD,Custom,XL HD,XLT,XLT HD	22052
<b>E-350 SUPER DUTY</b>				
2004-200	V10-6.8L	415 CID	Exc.A/C; Base,Base	22610
2006	V10-6.8L	415 CID	Exc.A/C; Base,Base,XL,XLT	22610
2007	V10-6.8L	415 CID	Exc.A/C; Base,Base,XL,XLT	22610
2008	V10-6.8L	415 CID	Exc.A/C; Base,Base	22610
2009	V10-6.8L	415 CID	Exc.A/C; Base,Base,XL	22610
2010-2014	V10-6.8L	415 CID	LPG; Exc.A/C; Base,Base,XL,XLT	22610
2004-2005	V8-5.4L	330 CID	Exc.A/C; Base,Base	22168
2006	V8-5.4L	330 CID	Exc.A/C; Base,Base,XL,XLT	22168
2007	V8-5.4L	330 CID	Exc.A/C (To 10/16/06); Base,Base,XL,XLT	22168
2008-2009	V8-5.4L	330 CID	Exc.A/C; Base,Base,XL,XLT	22168
2010-2014	V8-5.4L	330 CID	LPG; Exc.A/C; Base,Base,XL,XLT	22168
2004-2005	V8-6.0L	363 CID	Diesel; Base	22332
2006-2010	V8-6.0L	363 CID	Diesel; Base,XL,XLT	22332
<b>E-450 ECONOLINE SUPER DUTY</b>				
2000-2002	V10-6.8L	415 CID	Exc.A/C; Custom,Custom	22610
2000-2002	V8-5.4L	330 CID	Exc.A/C; Custom,Custom	22168
2000-2002	V8-7.3L	445 CID	Diesel; Custom	22612
<b>E-450 ECONOLINE SUPER DUTY STRIPPED</b>				
2000-2002	V10-6.8L	415 CID	Exc.A/C; Custom,Custom	22610
2000-2002	V8-5.4L	330 CID	Exc.A/C; Custom,Custom	22168
2000-2002	V8-7.3L	445 CID	Diesel; Custom	22612
<b>E-450 SUPER DUTY</b>				
2003	V10-6.8L	415 CID	Exc.A/C; Custom,Custom	22610
2004-2006	V10-6.8L	415 CID	Exc.A/C; Base,Base	22610
2007	V10-6.8L	415 CID	Exc.A/C; Base,Base	22610
2008-2009	V10-6.8L	415 CID	Exc.A/C; Base,Base	22610
2010-2014	V10-6.8L	415 CID	LPG; Exc.A/C; Base,Base	22610
2003	V8-5.4L	330 CID	Exc.A/C; Custom,Custom	22168
2004-2009	V8-5.4L	330 CID	Exc.A/C; Base,Base	22168
2010-2014	V8-5.4L	330 CID	LPG; Exc.A/C; Base,Base	22168
2004-2010	V8-6.0L	363 CID	Diesel; Base	22332
2003	V8-7.3L	445 CID	Diesel; Custom	22612
<b>E-450 SUPER DUTY STRIPPED CHASSIS</b>				
2003	V10-6.8L	415 CID	Exc.A/C; Custom,Custom	22610
2003	V8-5.4L	330 CID	Exc.A/C; Custom,Custom	22168
2003	V8-7.3L	445 CID	Diesel; Custom	22612

Years	Engine	Disp.	Application Description	USMW
<b>E-550 ECONOLINE SUPER DUTY</b>				
2002	V10-6.8L	415 CID	Exc.A/C; Custom,Custom	22610
2002	V8-7.3L	445 CID	Diesel; Custom	22612
<b>E-550 SUPER DUTY</b>				
2003	V10-6.8L	415 CID	Exc.A/C; Custom,Custom	22610
2003	V8-7.3L	445 CID	Diesel; Custom	22612
<b>ECONOLINE SUPER DUTY</b>				
1997-1999	V10-6.8L	415 CID	Exc.A/C; Custom,Custom	22610
1997-1999	V8-5.4L	330 CID	Exc.A/C; Custom,Custom	22168
1996	V8-5.8L	351 CID	Custom	22609
1996-1997	V8-7.3L	445 CID	Diesel; Custom	22609
1998-1999	V8-7.3L	445 CID	Diesel; Custom	22612
1996	V8-7.5L	460 CID	Custom	22052
<b>ECONOLINE WAGON (MEX)</b>				
1999-2000	L6-4.2L	256 CID		22168
2001-2002	L6-4.2L	256 CID	Exc. A/C;	22168
<b>ELITE</b>				
1974	L6-4.1L	250 CID		22016
1974	V8-5.8L	351 CID		22016
1974	V8-6.6L	400 CID		22016
1974	V8-7.5L	460 CID		22038
1975-1976	V8-7.5L	460 CID		22052
<b>EXCURSION</b>				
2000-2001	V10-6.8L	415 CID	Exc.A/C; Limited,Limited,XLT	22610
2002-2003	V10-6.8L	415 CID	Exc.A/C; Eddie Bauer,Eddie Bauer,Limited,XLT	22610
2004-2005	V10-6.8L	415 CID	Exc.A/C; Eddie Bauer,Eddie Bauer,Limited,XLS,XLT	22610
2000-2001	V8-5.4L	330 CID	Limited,XLT	22159
2002-2003	V8-5.4L	330 CID	Eddie Bauer,Limited,XLT	22159
2004-2005	V8-5.4L	330 CID	Eddie Bauer,Limited,XLS,XLT	22159
2003	V8-6.0L	363 CID	Diesel; Eddie Bauer,Limited,XLT	22332
2004-2005	V8-6.0L	363 CID	Diesel; Eddie Bauer,Limited,XLS,XLT	22332
2000-2001	V8-7.3L	445 CID	Diesel; Limited,XLT	22611
2002-2003	V8-7.3L	445 CID	Diesel; Eddie Bauer,Limited,XLT	22611
<b>EXPEDITION</b>				
1997-2002	V8-4.6L	281 CID	Exc.A/C; Eddie Bauer,Eddie Bauer,XLT	22168
2003	V8-4.6L	281 CID	Eddie Bauer,XLT	22168
2004	V8-4.6L	281 CID	Eddie Bauer,NBX,XLS,XLT,XLT Sport	22168
1997-2002	V8-5.4L	330 CID	Exc.A/C; Eddie Bauer,Eddie Bauer,XLT	22168
2003	V8-5.4L	330 CID	Eddie Bauer,XLT	22168
2004	V8-5.4L	330 CID	Eddie Bauer,NBX,XLS,XLT,XLT Sport	22168
2005	V8-5.4L	330 CID	Eddie Bauer,Limited,XLS,XLT	22168
2006	V8-5.4L	330 CID	Eddie Bauer,King Ranch,Limited,XLS,XLT,XLT Sport	22168
2009	V8-5.4L	330 CID	Eddie Bauer,EL Eddie Bauer,EL King Ranch,EL Limited,EL XLT,King Ranch,Limited,XLT	22334
2007	V8-5.4L	330 CID	Eddie Bauer,EL Eddie Bauer,EL Limited,EL XLT,Limited XLT	22338
2008	V8-5.4L	330 CID	Eddie Bauer,EL Eddie Bauer,EL King Ranch,EL Limited,EL XLT,Funkmaster Flex Edition,King Ranch,Limited,XLT	22338
<b>EXPEDITION (MEX)</b>				
1996	V8-4.6L	281 CID		22168
<b>EXPLORER</b>				
2002	V6-4.0L	245 CID	Eddie Bauer,Limited,Postal,Sport,XLS,XLT	22139
2003	V6-4.0L	245 CID	Eddie Bauer,Limited,Postal,Sport XLS,Sport XLT,XLS, XLT	22139
2004	V6-4.0L	245 CID	Eddie Bauer,Limited,NBX,XLS,XLS Sport,XLT,XLT Sport	22139
2005	V6-4.0L	245 CID	Eddie Bauer,Limited,XLS,XLS Sport,XLT,XLT Sport	22139
1995	V6-4.0L	245 CID	Eddie Bauer,Expedition,Limited,Sport,XL,XLT	22166
1996-1998	V6-4.0L	245 CID	Eddie Bauer,Limited,Sport,XL,XLT	22166
1999	V6-4.0L	245 CID	Eddie Bauer,Sport,XL,XLS,XLT	22166
2000-2001	V6-4.0L	245 CID	Eddie Bauer,Limited,Postal,Sport,XL Fleet,XLS,XLT	22166
2006	V6-4.0L	245 CID	Eddie Bauer,Limited,XLS,XLT	22166
1991-1992	V6-4.0L	245 CID	Exc.A/C; Eddie Bauer,Eddie Bauer,Sport,XL,XLT	22167
1993-1994	V6-4.0L	245 CID	Exc.A/C; Eddie Bauer,Eddie Bauer,Limited,Sport,XL,XLT	22167
2007-2010	V6-4.0L	245 CID	Eddie Bauer,Limited,XLT	22337
2002-2003	V8-4.6L	281 CID	Eddie Bauer,Limited,XLT	22139
2004	V8-4.6L	281 CID	Eddie Bauer,Limited,NBX,XLT,XLT Sport	22139
2005	V8-4.6L	281 CID	Eddie Bauer,Limited,XLT,XLT Sport	22139
2006	V8-4.6L	281 CID	Eddie Bauer,Limited,XLT	22166

Years	Engine	Disp.	Application Description	USMW
2007-2010	V8-4.6L	281 CID	Eddie Bauer,Limited,XLT	22337
1996-1998	V8-5.0L	302 CID	Eddie Bauer,Limited,XLT	22615
1999	V8-5.0L	302 CID	Eddie Bauer,XLS,XLT	22615
2000-2001	V8-5.0L	302 CID	Eddie Bauer,Limited,XLS,XLT	22615
<b>EXPLORER (MEX)</b>				
1990	L6-4.0L	245 CID		22166
<b>EXPLORER SPORT TRAC</b>				
2001	V6-4.0L	245 CID	Base	22166
2002	V6-4.0L	245 CID	XL	22166
2003-2004	V6-4.0L	245 CID	XLS,XLT	22166
2005	V6-4.0L	245 CID	Adrenalin,XLS,XLT	22166
2007-2010	V6-4.0L	245 CID	Limited,XLT	22337
2007-2010	V8-4.6L	281 CID	Limited,XLT	22337
<b>F SUPER DUTY</b>				
1990-1991	V8-7.3L	445 CID	Diesel; Custom	22601
1992	V8-7.3L	445 CID	Diesel; From 02/14/92; Custom,Custom	22607
1993-1994	V8-7.3L	445 CID	Diesel; XL	22607
1995-1996	V8-7.3L	445 CID	Diesel; XL	22609
1997	V8-7.3L	445 CID	Diesel; Base,XL	22609
1990-1991	V8-7.5L	460 CID	Exc.A/C; Custom,Custom	22052
1992	V8-7.5L	460 CID	Exc.A/C (To 03/12/92); Custom,Custom	22052
1993-1996	V8-7.5L	460 CID	Exc.A/C; XL,XL	22052
1997	V8-7.5L	460 CID	Exc.A/C; Base,Base,XL	22052
<b>F-100</b>				
1983	L6-4.9L	300 CID	Exc.A/C; Base,Base,XL,XLS,XLT Lariat	22061
1982	L6-4.9L	300 CID	Custom,XL,XLS,XLT Lariat	22146
1982	V6-3.8L	232 CID	Custom,XL,XLS,XLT Lariat	22126
1983	V6-3.8L	232 CID	Base,XL,XLS,XLT Lariat	22126
1980-1981	V8-5.0L	302 CID	Custom,Ranger,Ranger Lariat,Ranger XLT	22054
1982	V8-5.0L	302 CID	Custom,XL,XLS,XLT Lariat	22054
1983	V8-5.0L	302 CID	A/C; Base,Base,XL,XLS,XLT Lariat	22054
1981	V8-5.8L	351 CID	Custom,Ranger,Ranger Lariat,Ranger XLT	22054
<b>F100 (MEX)</b>				
1977-1978	V8-4.7L	289 CID		22016
<b>F100 1/2 TON</b>				
1961-1964	L6-3.6L	223 CID		22016
1975	L6-3.9L	240 CID		22011
1965-1974	L6-3.9L	240 CID		22016
1975-1979	L6-4.9L	300 CID		22011
1965-1974	L6-4.9L	300 CID		22016
1969-1974	V8-5.0L	302 CID		22016
1975-1979	V8-5.0L	302 CID	With A/C;	22045
1977-1979	V8-5.8L	351 CID	With A/C;	22045
1965-1967	V8-5.8L	352 CID		22016
1975-1976	V8-5.9L	360 CID		22011
1968-1974	V8-5.9L	360 CID		22016
1975-1976	V8-6.4L	390 CID		22011
1968-1974	V8-6.4L	390 CID		22016
1977-1979	V8-6.6L	400 CID		22045
1973-1976	V8-7.5L	460 CID		22052
<b>F-150</b>				
1983	L6-4.9L	300 CID	Exc.A/C; Base,Base,XL,XLS,XLT	22061
1984	L6-4.9L	300 CID	LPG; Exc.A/C; Base,Base,XL,XLT	22061
1985	L6-4.9L	300 CID	LPG; Exc.A/C; Base,Base,XL,XLT Lariat	22061
1986	L6-4.9L	300 CID	Exc.A/C; Base,Base,XL,XLT Lariat	22061
1993-1994	L6-4.9L	300 CID	A/C; XL,XLT	22155
1995-1996	L6-4.9L	300 CID	A/C; Eddie Bauer,Special,XL,XLT	22155
1987-1992	L6-4.9L	300 CID	Exc.A/C; Custom,Custom,XL,XLT Lariat	22161
1997-2000	V6-4.2L	256 CID	Exc.A/C; Base,Base,XL,XLT	22159
2001-2003	V6-4.2L	256 CID	Exc.A/C; XL,XL,XLT	22159
2005-2008	V6-4.2L	256 CID	Exc.A/C; STX,STX,XL,XLT	22159
1997-2000	V8-4.6L	281 CID	Exc.A/C; Base,Base,Lariat,XL,XLT	22168
2001-2003	V8-4.6L	281 CID	Exc.A/C; King Ranch,King Ranch,Lariat,XL,XLT	22168
2004-2006	V8-4.6L	281 CID	STX,XL,XLT	22168
2009-2010	V8-4.6L	281 CID	STX,XL,XLT	22334
2007	V8-4.6L	281 CID	Electronic; STX,STX,XL,XLT	22338
2008	V8-4.6L	281 CID	Electronic; FX2,FX2,STX,XL,XLT	22338
1980-1981	V8-5.0L	302 CID	Custom,Ranger,Ranger Lariat,Ranger XLT	22054

**FAN CLUTCHES**



Years	Engine	Disp.	Application Description	USMW
1982	V8-5.0L	302 CID	Custom,XL,XLS,XLT Lariat	22054
1983	V8-5.0L	302 CID	A/C; Base,Base,XL,XLS,XLT	22054
1984	V8-5.0L	302 CID	A/C; Base,Base,XL,XLT	22054
1985-1986	V8-5.0L	302 CID	A/C; Base,Base,XL,XLT Lariat	22054
1987-1992	V8-5.0L	302 CID	Exc.A/C; Custom,Custom,XL,XLT Lariat	22146
1993-1994	V8-5.0L	302 CID	Exc.A/C; XL,XL,XLT	22146
1995-1996	V8-5.0L	302 CID	Exc.A/C; Eddie Bauer,Eddie Bauer,Special,XL,XLT	22146
1997-1998	V8-5.4L	330 CID	Exc.A/C; Base,Base,Lariat,XL,XLT	22168
1999	V8-5.4L	330 CID	Exc.A/C; Base,Base,Lariat,Lightning,XL,XLT	22168
2000	V8-5.4L	330 CID	Exc.A/C; Base,Base,Harley-Davidson Edition, Lariat,Lightning,XL,XLT	22168
2001	V8-5.4L	330 CID	Exc.A/C; Harley-Davidson Edition, Harley-Davidson Edition,King Ranch,Lariat, Lightning,XL,XLT	22168
2002-2003	V8-5.4L	330 CID	Exc.A/C; Harley-Davidson Edition,King Ranch,Lariat,Lightning,XL,XLT	22168
2004	V8-5.4L	330 CID	FX4,Lariat,XL,XLT	22168
2005	V8-5.4L	330 CID	FX4,King Ranch,Lariat,XL,XLT	22168
2006	V8-5.4L	330 CID	FX4,Harley-Davidson Edition,King Ranch,Lariat,XL,XLT	22168
2009	V8-5.4L	330 CID	FX4,King Ranch,Lariat,Platinum,XL,XLT	22334
2010	V8-5.4L	330 CID	FX2,FX4,Harley-Davidson Edition,King Ranch,Lariat, Platinum,SVT Raptor,XL,XLT	22334
2007	V8-5.4L	330 CID	Electronic; FX2,FX2,FX4,Harley-Davidson Edition, King Ranch,Lariat,XL,XLT	22338
2008	V8-5.4L	330 CID	Electronic; FX2,FX2,FX4,Harley-Davidson Edition, King Ranch,Lariat,Limited,XL,XLT	22338
1980-1981	V8-5.8L	351 CID	Custom,Ranger,Ranger Lariat,Ranger XLT	22054
1982	V8-5.8L	351 CID	Custom,XL,XLS,XLT Lariat	22054
1983	V8-5.8L	351 CID	A/C; Base,Base,XL,XLS,XLT	22054
1984	V8-5.8L	351 CID	A/C; Base,Base,XL,XLT	22054
1985-1986	V8-5.8L	351 CID	A/C; Base,Base,XL,XLT Lariat	22054
1987	V8-5.8L	351 CID	A/C; Custom,Custom,XL,XLT Lariat	22054
1988	V8-5.8L	351 CID	Exc.A/C; Custom,Custom,XL,XLT Lariat	22146
1989	V8-5.8L	351 CID	Exc.A/C; Custom,Custom,XL,XLT Lariat	22146
1990-1992	V8-5.8L	351 CID	Exc.A/C; Custom,Custom,XL,XLT Lariat	22146
1993-1994	V8-5.8L	351 CID	Exc.A/C; Lightning,Lightning,XL,XLT	22146
1995	V8-5.8L	351 CID	Exc.A/C; Eddie Bauer,Eddie Bauer,Lightning,Special, XL,XLT	22146
1996	V8-5.8L	351 CID	Exc.A/C; Eddie Bauer,Eddie Bauer,Special,XL,XLT	22146
<b>F150 (MEX)</b>				
2009	L6-4.2L	256 CID		22168
<b>F150 1/2 TON</b>				
1975-1976	L6-3.9L	240 CID		22011
1975-1979	L6-4.9L	300 CID		22011
1976-1977	V8-5.0L	302 CID	With A/C,;	22045
1978-1979	V8-5.0L	302 CID		22045
1977-1979	V8-5.8L	351 CID	With A/C,;	22045
1975-1976	V8-5.9L	360 CID		22011
1975-1976	V8-6.4L	390 CID		22011
1977-1979	V8-6.6L	400 CID		22054
1975-1979	V8-7.5L	460 CID		22052
<b>F-150 HERITAGE</b>				
2004	V6-4.2L	256 CID	Exc.A/C; XL,XL,XLT	22159
2004	V8-4.6L	281 CID	Exc.A/C; XL,XL,XLT	22168
2004	V8-5.4L	330 CID	Exc.A/C; SVT Lightning,SVT Lightning,XL,XLT	22168
<b>F200 (MEX)</b>				
1986	V8-5.0L	302 CID	A/C,;	22045
1987-1990	V8-5.0L	302 CID		22146
1986-1987	V8-5.8L	351 CID	A/C,;	22045
1988-1990	V8-5.8L	351 CID		22146
<b>F-250</b>				
1983	L6-4.9L	300 CID	Exc.A/C; Base,Base,XL,XLS,XLT	22061
1984	L6-4.9L	300 CID	LPG; Exc.A/C; Base,Base,XL,XLT	22061
1985	L6-4.9L	300 CID	LPG; Exc.A/C; Base,Base,XL,XLT Lariat	22061
1986	L6-4.9L	300 CID	Exc.A/C; Base,Base,XL,XLT Lariat	22061
1993-1994	L6-4.9L	300 CID	A/C; XL,XLT	22155
1995	L6-4.9L	300 CID	A/C; Eddie Bauer,Special,XL,XLT	22155
1996	L6-4.9L	300 CID	A/C; Eddie Bauer,Special,XL,XLT	22155
1987-1992	L6-4.9L	300 CID	Exc.A/C; Custom,Custom,XL,XLT Lariat	22161

Years	Engine	Disp.	Application Description	USMW
1997-1999	V8-4.6L	281 CID	Exc.A/C; Base,Base,Lariat,XL,XLT	22168
1980-1981	V8-5.0L	302 CID	Custom,Ranger,Ranger Lariat,Ranger XLT	22054
1982	V8-5.0L	302 CID	Custom,XL,XLS,XLT Lariat	22054
1983	V8-5.0L	302 CID	A/C; Base,Base,XL,XLS,XLT	22054
1984	V8-5.0L	302 CID	A/C; Base,Base,XL,XLT	22054
1985-1986	V8-5.0L	302 CID	A/C; Base,Base,XL,XLT Lariat	22054
1987-1992	V8-5.0L	302 CID	Exc.A/C; Custom,Custom,XL,XLT Lariat	22146
1993-1994	V8-5.0L	302 CID	Exc.A/C; XL,XL,XLT	22146
1995-1996	V8-5.0L	302 CID	Exc.A/C; Eddie Bauer,Eddie Bauer,Special,XL,XLT	22146
1997-1999	V8-5.4L	330 CID	Exc.A/C; Base,Base,Lariat,XL,XLT	22168
1980-1981	V8-5.8L	351 CID	Custom,Ranger,Ranger Lariat,Ranger XLT	22054
1982	V8-5.8L	351 CID	Custom,XL,XLS,XLT Lariat	22054
1983	V8-5.8L	351 CID	A/C; Base,Base,XL,XLS,XLT	22054
1984	V8-5.8L	351 CID	A/C; Base,Base,XL,XLT	22054
1985-1986	V8-5.8L	351 CID	A/C; Base,Base,XL,XLT Lariat	22054
1987	V8-5.8L	351 CID	A/C; Custom,Custom,XL,XLT Lariat	22054
1988	V8-5.8L	351 CID	Exc.A/C; Custom,Custom,XL,XLT Lariat	22146
1989	V8-5.8L	351 CID	Exc.A/C; Custom,Custom,XL,XLT Lariat	22146
1990-1992	V8-5.8L	351 CID	Exc.A/C; Custom,Custom,XL,XLT Lariat	22146
1993-1994	V8-5.8L	351 CID	Exc.A/C; XL,XL,XLT	22146
1995-1996	V8-5.8L	351 CID	Exc.A/C; Eddie Bauer,Eddie Bauer,Special,XL,XLT	22146
1997	V8-5.8L	351 CID	Exc.A/C; Base,Base,Lariat,XL,XLT	22146
1980-1981	V8-6.6L	400 CID	Custom,Ranger,Ranger Lariat,Ranger XLT	22054
1982	V8-6.6L	400 CID	Custom,XL,XLS,XLT Lariat	22054
1983	V8-6.9L	420 CID	Diesel; Base,XL,XLS,XLT	22601
1984	V8-6.9L	420 CID	Diesel; Base,XL,XLT	22601
1985-1986	V8-6.9L	420 CID	Diesel; Base,XL,XLT Lariat	22601
1987	V8-6.9L	420 CID	Diesel; Custom,XL,XLT Lariat	22601
1988-1991	V8-7.3L	445 CID	Diesel; Custom,XL,XLT Lariat	22601
1992	V8-7.3L	445 CID	Diesel; From 02/14/92; Custom,Custom,XL,XLT Lariat	22607
1993	V8-7.3L	445 CID	Diesel; XL,XLT	22607
1994	V8-7.3L	445 CID	Diesel; Direct Injection; XL,XL,XLT	22609
1995-1996	V8-7.3L	445 CID	Diesel; Eddie Bauer,Special,XL,XLT	22609
1997	V8-7.3L	445 CID	Diesel; Base,Lariat,XL,XLT	22609
1983	V8-7.5L	460 CID	Exc.A/C; Base,Base,XL,XLS,XLT	22052
1984	V8-7.5L	460 CID	Exc.A/C; Base,Base,XL,XLT	22052
1985-1986	V8-7.5L	460 CID	Exc.A/C; Base,Base,XL,XLT Lariat	22052
1987-1991	V8-7.5L	460 CID	Exc.A/C; Custom,Custom,XL,XLT Lariat	22052
1992	V8-7.5L	460 CID	Exc.A/C (To 03/12/92); Custom,Custom,XL,XLT Lariat	22052
1993-1994	V8-7.5L	460 CID	Exc.A/C; XL,XL,XLT	22052
1995-1996	V8-7.5L	460 CID	Exc.A/C; Eddie Bauer,Eddie Bauer,Special,XL,XLT	22052
1997	V8-7.5L	460 CID	Exc.A/C; Base,Base,Lariat,XL,XLT	22052
<b>F250 (MEX)</b>				
2000-2007	V8-4.6L	281 CID		22168
2002-2009	V8-4.6L	281 CID		22620
<b>F250 3/4 TON</b>				
1961-1964	L6-3.6L	223 CID		22016
1965-1972	L6-3.9L	240 CID		22016
1965-1979	L6-4.9L	300 CID		22016
1972-1977	V8-5.0L	302 CID		22016
1977-1979	V8-5.8L	351 CID		22016
1965-1967	V8-5.8L	352 CID		22016
1968-1976	V8-5.9L	360 CID		22016
1968-1976	V8-6.4L	390 CID		22016
1977-1979	V8-6.6L	400 CID		22054
1973-1979	V8-7.5L	460 CID		22052
<b>F-250 SUPER DUTY</b>				
1999-2003	V10-6.8L	415 CID	Exc.A/C; Lariat,Lariat,XL,XLT	22610
2004	V10-6.8L	415 CID	Exc.A/C; Harley-Davidson Edition, Harley-Davidson Edition,King Ranch,Lariat,XL,XLT	22610
2005	V10-6.8L	415 CID	Exc.A/C (To 11/19/04); FX4,FX4, Harley-Davidson Edition,King Ranch,Lariat,XL,XLT	22610
2006-2007	V10-6.8L	415 CID	Exc.A/C; King Ranch,King Ranch,Lariat,XL,XLT	22610
2008	V10-6.8L	415 CID	Exc.A/C; FX4,FX4,Harley-Davidson Edition,King Ranch,Lariat,XL,XLT	22610
2009	V10-6.8L	415 CID	Exc.A/C; Cabela's,Cabela's,FX4, Harley-Davidson Edition,King Ranch,Lariat,XL,XLT	22610
2010	V10-6.8L	415 CID	Exc.A/C; Cabela's,Cabela's,King Ranch,Lariat,XL,XLT	22610
1999-2003	V8-5.4L	330 CID	Exc.A/C; Lariat,Lariat,XL,XLT	22168



Years	Engine	Disp.	Application Description	USMW
2004	V8-5.4L	330 CID	Exc.A/C; King Ranch,King Ranch,Lariat,XL,XLT	22168
2008	V8-5.4L	330 CID	Exc.A/C; FX4,FX4,King Ranch,Lariat,XL,XLT	22168
2009	V8-5.4L	330 CID	Exc.A/C; Cabela's,Cabela's,FX4,King Ranch,Lariat,XL,XLT	22168
2010	V8-5.4L	330 CID	Exc.A/C; Cabela's,Cabela's,King Ranch,Lariat,XL,XLT	22168
2005	V8-5.4L	330 CID	Exc.A/C (From 11/23/04); FX4,FX4,King Ranch,Lariat,XL,XLT	22610
2006-2007	V8-5.4L	330 CID	Exc.A/C; King Ranch,King Ranch,Lariat,XL,XLT	22610
2003	V8-6.0L	363 CID	Diesel; Snow Plow Package; Lariat,Lariat,XL,XLT	22332
2004	V8-6.0L	363 CID	Diesel; Snow Plow Package; Harley-Davidson Edition,Harley-Davidson Edition,King Ranch,Lariat,XL,XLT	22332
2005	V8-6.0L	363 CID	Diesel; Snow Plow Package; FX4,FX4,Harley-Davidson Edition,King Ranch,Lariat,XL,XLT	22332
2006-2007	V8-6.0L	363 CID	Diesel; Snow Plow Package; Harley-Davidson Edition,Harley-Davidson Edition,King Ranch,Lariat,XL,XLT	22332
2011-2012	V8-6.2L	379 CID	King Ranch,Lariat,XL,XLT	22339
2013-2014	V8-6.2L	379 CID	King Ranch,Lariat,Platinum,XL,XLT	22339
2008	V8-6.4L	391 CID	Diesel; Exc.Snow Plow Package; FX4,FX4,Harley-Davidson Edition,King Ranch,Lariat,XL,XLT	22332
2009	V8-6.4L	391 CID	Diesel; Cabela's,FX4,Harley-Davidson Edition,King Ranch,Lariat,XL,XLT	22332
2010	V8-6.4L	391 CID	Diesel; Exc.Snow Plow Package; Cabela's,Cabela's,Harley-Davidson Edition,King Ranch,Lariat,XL,XLT	22332
2011-2012	V8-6.7L	406 CID	Diesel; King Ranch,Lariat,XL,XLT	22340
2013-2014	V8-6.7L	406 CID	Diesel; King Ranch,Lariat,Platinum,XL,XLT	22340
1999-2003	V8-7.3L	445 CID	Diesel; Lariat,XL,XLT	22611
<b>F-350</b>				
1983	L6-4.9L	300 CID	Exc.A/C; Base,Base,XL,XLS,XLT	22061
1984	L6-4.9L	300 CID	LPG; Exc.A/C; Base,Base,XL,XLT	22061
1985	L6-4.9L	300 CID	LPG; Exc.A/C; Base,Base,XL,XLT Lariat	22061
1986	L6-4.9L	300 CID	Exc.A/C; Base,Base,XL,XLT Lariat	22061
1993-1994	L6-4.9L	300 CID	A/C; XL,XLT	22155
1987-1991	L6-4.9L	300 CID	Exc.A/C; Custom,Custom,XL,XLT Lariat	22161
1980-1981	V8-5.8L	351 CID	Custom,Ranger,Ranger Lariat,Ranger XLT	22054
1982	V8-5.8L	351 CID	Custom,XL,XLS,XLT Lariat	22054
1983	V8-5.8L	351 CID	A/C; Base,Base,XL,XLS,XLT	22054
1984	V8-5.8L	351 CID	A/C; Base,Base,XL,XLT	22054
1985-1986	V8-5.8L	351 CID	A/C; Base,Base,XL,XLT Lariat	22054
1987	V8-5.8L	351 CID	A/C; Custom,Custom,XL,XLT Lariat	22054
1988	V8-5.8L	351 CID	Exc.A/C; Custom,Custom,XL,XLT Lariat	22146
1989	V8-5.8L	351 CID	Exc.A/C; Custom,Custom,XL,XLT Lariat	22146
1990-1992	V8-5.8L	351 CID	Exc.A/C; Custom,Custom,XL,XLT Lariat	22146
1993-1994	V8-5.8L	351 CID	Exc.A/C; XL,XL,XLT	22146
1995-1996	V8-5.8L	351 CID	Exc.A/C; Eddie Bauer,Eddie Bauer,Special,XL,XLT	22146
1997	V8-5.8L	351 CID	Exc.A/C; Base,Base,Lariat,XL,XLT	22146
1980-1981	V8-6.6L	400 CID	Custom,Ranger,Ranger Lariat,Ranger XLT	22054
1982	V8-6.6L	400 CID	Custom,XL,XLS,XLT Lariat	22054
1983	V8-6.9L	420 CID	Diesel; Base,XL,XLS,XLT	22601
1984	V8-6.9L	420 CID	Diesel; Base,XL,XLT	22601
1985-1986	V8-6.9L	420 CID	Diesel; Base,XL,XLT Lariat	22601
1987	V8-6.9L	420 CID	Diesel; Custom,XL,XLT Lariat	22601
1988-1991	V8-7.3L	445 CID	Diesel; Custom,XL,XLT Lariat	22601
1992	V8-7.3L	445 CID	Diesel; From 02/14/92; Custom,Custom,XL,XLT Lariat	22607
1993	V8-7.3L	445 CID	Diesel; XL,XLT	22607
1994	V8-7.3L	445 CID	Diesel; Direct Injection; XL,XL,XLT	22609
1995-1996	V8-7.3L	445 CID	Diesel; Eddie Bauer,Special,XL,XLT	22609
1997	V8-7.3L	445 CID	Diesel; Base,Lariat,XL,XLT	22609
1983	V8-7.5L	460 CID	Exc.A/C; Base,Base,XL,XLS,XLT	22052
1984	V8-7.5L	460 CID	Exc.A/C; Base,Base,XL,XLT	22052
1985-1986	V8-7.5L	460 CID	Exc.A/C; Base,Base,XL,XLT Lariat	22052
1987-1991	V8-7.5L	460 CID	Exc.A/C; Custom,Custom,XL,XLT Lariat	22052
1992	V8-7.5L	460 CID	Exc.A/C (To 03/12/92); Custom,Custom,XL,XLT Lariat	22052
1993-1994	V8-7.5L	460 CID	Exc.A/C; XL,XL,XLT	22052
1995-1996	V8-7.5L	460 CID	Exc.A/C; Eddie Bauer,Eddie Bauer,Special,XL,XLT	22052
1997	V8-7.5L	460 CID	Exc.A/C; Base,Base,Lariat,XL,XLT	22052
<b>F350 (MEX)</b>				
1999	V8-5.4L	330 CID		22166
2000	V8-5.4L	330 CID		22168

Years	Engine	Disp.	Application Description	USMW
<b>F350 1 TON</b>				
1961-1964	L6-3.6L	223 CID		22016
1965-1972	L6-3.9L	240 CID		22016
1965-1979	L6-4.9L	300 CID		22016
1972	V8-5.0L	302 CID		22016
1977	V8-5.0L	302 CID		22052
1977-1979	V8-5.8L	351 CID		22016
1965-1967	V8-5.8L	352 CID		22016
1968-1976	V8-5.9L	360 CID		22016
1968-1976	V8-6.4L	390 CID		22016
1977-1979	V8-6.6L	400 CID		22054
1973-1979	V8-7.5L	460 CID		22052
<b>F-350 SUPER DUTY</b>				
1999-2003	V10-6.8L	415 CID	Exc.A/C; Lariat,Lariat,XL,XLT	22610
2004	V10-6.8L	415 CID	Exc.A/C; Harley-Davidson Edition,Harley-Davidson Edition,King Ranch,Lariat,XL,XLT	22610
2005	V10-6.8L	415 CID	Exc.A/C (To 11/19/04); Harley-Davidson Edition,Harley-Davidson Edition,King Ranch,Lariat,XL,XLT	22610
2006-2007	V10-6.8L	415 CID	Exc.A/C; King Ranch,King Ranch,Lariat,XL,XLT	22610
2008	V10-6.8L	415 CID	Exc.A/C; FX4,FX4,Harley-Davidson Edition,King Ranch,Lariat,XL,XLT	22610
2009	V10-6.8L	415 CID	Exc.A/C; Cabela's,Cabela's,FX4,Harley-Davidson Edition,King Ranch,Lariat,XL,XLT	22610
2010	V10-6.8L	415 CID	Exc.A/C; Cabela's,Cabela's,King Ranch,Lariat,XL,XLT	22610
1999-2003	V8-5.4L	330 CID	Exc.A/C; Lariat,Lariat,XL,XLT	22168
2004	V8-5.4L	330 CID	Exc.A/C; King Ranch,King Ranch,Lariat,XL,XLT	22168
2008	V8-5.4L	330 CID	Exc.A/C; FX4,FX4,King Ranch,Lariat,XL,XLT	22168
2009	V8-5.4L	330 CID	Exc.A/C; Cabela's,Cabela's,FX4,King Ranch,Lariat,XL,XLT	22168
2010	V8-5.4L	330 CID	Exc.A/C; Cabela's,Cabela's,King Ranch,Lariat,XL,XLT	22168
2005	V8-5.4L	330 CID	Exc.A/C (From 11/23/04); King Ranch,King Ranch,Lariat,XL,XLT	22610
2006-2007	V8-5.4L	330 CID	Exc.A/C; King Ranch,King Ranch,Lariat,XL,XLT	22610
2003	V8-6.0L	363 CID	Diesel; Snow Plow Package; Lariat,Lariat,XL,XLT	22332
2004-2007	V8-6.0L	363 CID	Diesel; Snow Plow Package; Harley-Davidson Edition,Harley-Davidson Edition,King Ranch,Lariat,XL,XLT	22332
2011-2012	V8-6.2L	379 CID	King Ranch,Lariat,XL,XLT	22339
2013-2014	V8-6.2L	379 CID	King Ranch,Lariat,Platinum,XL,XLT	22339
2008	V8-6.4L	391 CID	Diesel; Exc.Snow Plow Package; FX4,FX4,Harley-Davidson Edition,King Ranch,Lariat,XL,XLT	22332
2009	V8-6.4L	391 CID	Diesel; Cabela's,FX4,Harley-Davidson Edition,King Ranch,Lariat,XL,XLT	22332
2010	V8-6.4L	391 CID	Diesel; Exc.Snow Plow Package; Cabela's,Cabela's,Harley-Davidson Edition,King Ranch,Lariat,XL,XLT	22332
2011-2012	V8-6.7L	406 CID	Diesel; King Ranch,Lariat,XL,XLT	22340
2013-2014	V8-6.7L	406 CID	Diesel; King Ranch,Lariat,Platinum,XL,XLT	22340
1999-2003	V8-7.3L	445 CID	Diesel; Lariat,XL,XLT	22611
<b>F-450 SUPER DUTY</b>				
1999-2004	V10-6.8L	415 CID	Exc.A/C; Lariat,Lariat,XL,XLT	22610
2005	V10-6.8L	415 CID	Exc.A/C (To 11/19/04); Lariat,Lariat,XL,XLT	22610
2006-2007	V10-6.8L	415 CID	Exc.A/C; Lariat,Lariat,XL,XLT	22610
2008	V10-6.8L	415 CID	Exc.A/C; King Ranch,King Ranch,Lariat,XL,XLT	22610
2010	V10-6.8L	415 CID	Exc.A/C; Lariat,Lariat,XL,XLT	22610
2011-2014	V10-6.8L	415 CID	Exc.A/C; XL,XL,XLT	22610
2003-2007	V8-6.0L	363 CID	Diesel; Snow Plow Package; Lariat,Lariat,XL,XLT	22332
2008	V8-6.4L	391 CID	Diesel; Exc.Snow Plow Package; King Ranch,King Ranch,Lariat,XL,XLT	22332
2009	V8-6.4L	391 CID	Diesel; Harley-Davidson Edition,King Ranch,Lariat,XL,XLT	22332
2010	V8-6.4L	391 CID	Diesel; Exc.Snow Plow Package; Harley-Davidson Edition,Harley-Davidson Edition,King Ranch,Lariat,XL,XLT	22332
2011-2012	V8-6.7L	406 CID	Diesel; King Ranch,Lariat,XL,XLT	22340
2013-2014	V8-6.7L	406 CID	Diesel; King Ranch,Lariat,Platinum,XL,XLT	22340
1999-2003	V8-7.3L	445 CID	Diesel; Lariat,XL,XLT	22611
<b>F500 P/U 2WD</b>				
1975-1976	V8-5.9L	360 CID		22011
1975-1976	V8-6.4L	390 CID		22011

**FAN CLUTCHES**

Years	Engine	Disp.	Application Description	USMW
<b>F53</b>				
2014	V10-6.8L	415 CID	LPG; Base,Base	22168
2009-2010	V10-6.8L	415 CID	Base	22610
2011-2013	V10-6.8L	415 CID	LPG; Base,Base	22610
1988-1989	V8-7.5L	460 CID	Exc.A/C; Custom,Custom,XL	22052
1990-1991	V8-7.5L	460 CID	Exc.A/C; Custom,Custom	22052
1992	V8-7.5L	460 CID	Exc.A/C (To 03/12/92); Custom,Custom	22052
1993-1996	V8-7.5L	460 CID	Exc.A/C; XL,XL	22052
1997	V8-7.5L	460 CID	Exc.A/C; Base,Base,XL	22052
<b>F-550 SUPER DUTY</b>				
1999-2004	V10-6.8L	415 CID	Exc.A/C; Lariat,Lariat,XL,XLT	22610
2005	V10-6.8L	415 CID	Exc.A/C (To 11/19/04); Lariat,Lariat,XL,XLT	22610
2006-2010	V10-6.8L	415 CID	Exc.A/C; Lariat,Lariat,XL,XLT	22610
2011-2014	V10-6.8L	415 CID	Exc.A/C; XL,XL,XLT	22610
2003-2007	V8-6.0L	363 CID	Diesel; Snow Plow Package; Lariat,Lariat,XL,XLT	22332
2008-2010	V8-6.4L	391 CID	Diesel; Exc.Snow Plow Package; Lariat,Lariat,XL,XLT	22332
2011-2014	V8-6.7L	406 CID	Diesel; Lariat,XL,XLT	22340
1999-2003	V8-7.3L	445 CID	Diesel; Lariat,XL,XLT	22611
<b>F59</b>				
1988-1989	V8-7.3L	445 CID	Diesel; Custom,XL	22601
1990-1991	V8-7.3L	445 CID	Diesel; Custom	22601
1992	V8-7.3L	445 CID	Diesel; From 02/14/92; Custom,Custom	22607
1993	V8-7.3L	445 CID	Diesel; XL	22607
1994	V8-7.3L	445 CID	Diesel; Direct Injection; XL,XL	22609
<b>FAIRLANE</b>				
1968	L6-3.3L	200 CID		22011
1963-1967	L6-3.3L	200 CID		22016
1962	L6-3.6L	223 CID		22016
1969-1970	L6-4.1L	250 CID		22011
1962-1963	V8-3.6L	221 CID		22016
1962-1964	V8-4.3L	260 CID		22016
1963-1968	V8-4.7L	289 CID		22011
1968-1970	V8-5.0L	302 CID		22011
1969-1970	V8-5.8L	351 CID		22011
1961	V8-5.8L	352 CID		22011
1961-1969	V8-6.4L	390 CID		22011
1964-1969	V8-7.0L	427 CID		22016
1968-1969	V8-7.0L	428 CID		22016
1970	V8-7.0L	429 CID		22016
<b>FAIRMONT</b>				
1983	L6-3.3L	200 CID	Police,Taxi & Trailer Tow; Futura,Futura,S	22012
1978-1979	L6-3.3L	200 CID		22038
1980	L6-3.3L	200 CID	Base,Futura	22038
1981	L6-3.3L	200 CID	Base,Futura,S	22038
1982	L6-3.3L	200 CID	Police,Taxi & Trailer Tow; Base,Base,Futura	22038
1980	V8-4.2L	255 CID	Base,Futura	22011
1981	V8-4.2L	255 CID	Base,Futura,S	22011
1982	V8-4.2L	255 CID	Base,Futura	22011
1978-1979	V8-5.0L	302 CID		22011
<b>FALCON</b>				
1961-1964	L6-2.4L	144 CID		22011
1961-1969	L6-2.8L	170 CID		22011
1964-1970	L6-3.3L	200 CID		22011
1970	L6-4.1L	250 CID		22011
1963	V8-3.6L	221 CID		22011
1963-1964	V8-4.3L	260 CID		22011
1965-1968	V8-4.7L	289 CID		22011
1968-1970	V8-5.0L	302 CID		22011
1970	V8-5.8L	351 CID		22011
1970	V8-7.0L	429 CID		22011
<b>FALCON RANCHERO</b>				
1961	L6-2.4L	144 CID		22011
1961	L6-2.8L	170 CID		22011
<b>FUTURA</b>				
1978	L6-3.3L	200 CID		22038
1978	V8-5.0L	302 CID		22011
<b>GALAXIE</b>				
1963	V8-4.3L	260 CID		22016

Years	Engine	Disp.	Application Description	USMW
1961-1963	V8-5.8L	352 CID		22011
1961-1963	V8-6.4L	390 CID		22011
1962-1963	V8-6.6L	406 CID		22011
<b>GALAXIE (MEX)</b>				
1975-1976	V8-5.8L	351 CID		22016
<b>GALAXIE 500</b>				
1965-1972	L6-3.9L	240 CID		22016
1964-1967	V8-4.7L	289 CID		22016
1968-1972	V8-5.0L	302 CID		22016
1969-1974	V8-5.8L	351 CID		22016
1964-1971	V8-6.4L	390 CID		22016
1971-1974	V8-6.6L	400 CID		22016
1964	V8-7.0L	427 CID		22011
1965-1968	V8-7.0L	427 CID		22016
1966-1970	V8-7.0L	428 CID		22016
1969-1973	V8-7.0L	429 CID		22016
1973-1974	V8-7.5L	460 CID		22038
<b>GRAN TORINO</b>				
1972-1974	L6-4.1L	250 CID		22016
1972-1974	V8-5.0L	302 CID		22016
1972-1976	V8-5.8L	351 CID		22016
1972-1976	V8-6.6L	400 CID		22016
1972-1973	V8-7.0L	429 CID		22016
1975	V8-7.5L	460 CID		22012
1974-1976	V8-7.5L	460 CID		22038
<b>GRAN TORINO WAGON</b>				
1976	V8-5.8L	351 CID		22016
1976	V8-6.6L	400 CID		22016
1976	V8-7.5L	460 CID		22038
<b>GRANADA</b>				
1975-1982	L6-3.3L	200 CID		22011
1981-1982	L6-3.3L	200 CID	Exc.A/C; GL,GL,GLX,L	22038
1975-1979	L6-4.1L	250 CID		22011
1982	V6-3.8L	232 CID	Exc.A/C; GL,GL,GLX,L	22126
1980	V8-4.2L	255 CID	Base,ESS,Ghia	22011
1981	V8-4.2L	255 CID	GL,GLX,L	22011
1975-1979	V8-5.0L	302 CID		22011
1980	V8-5.0L	302 CID	Base,ESS,Ghia	22011
1975-1977	V8-5.8L	351 CID		22011
<b>GRAND MARQUIS (MEX)</b>				
1993-2004	V8-4.6L	281 CID		22169
1991-1992	V8-5.0L	302 CID		22169
<b>GT40</b>				
1966-1969	V8-4.7L	289 CID		22016
<b>LOBO 2WD (MEX)</b>				
2000-2005	V8-4.6L	281 CID		22168
1997-2009	V8-4.6L	281 CID		22620
1999-2008	V8-5.4L	330 CID		22168
2003-2009	V8-5.4L	330 CID		22620
<b>LOBO 4WD (MEX)</b>				
1998-2007	V8-4.6L	281 CID		22168
2002-2009	V8-4.6L	281 CID		22620
1999-2008	V8-5.4L	330 CID		22168
2001-2009	V8-5.4L	330 CID		22620
<b>LTD</b>				
1983	L6-3.3L	200 CID	Exc.A/C; Base,Base,Brougham	22012
1983-1986	V6-3.8L	232 CID	Exc.A/C; Base,Base,Brougham	22126
1981-1982	V8-4.2L	255 CID	Base,Crown Victoria,S	22011
1965-1968	V8-4.7L	289 CID		22011
1968-1979	V8-5.0L	302 CID		22011
1980-1982	V8-5.0L	302 CID	Base,Country Squire,Crown Victoria,S	22011
1983	V8-5.0L	302 CID	Country Squire,Crown Victoria	22011
1986	V8-5.0L	302 CID	Police (Towing Package); Country Squire, Country Squire,Country Squire LX,Crown Victoria, Crown Victoria LX	22011
1984	V8-5.0L	302 CID	Exc.A/C (From 02/84); Base,Base,Brougham, Country Squire,Crown Victoria	22146

Years	Engine	Disp.	Application Description	USMW
1985	V8-5.0L	302 CID	Exc.A/C (Police); Base,Base,Brougham, Country Squire,Crown Victoria,LX Brougham	22146
1969-1979	V8-5.8L	351 CID		22011
1980-1981	V8-5.8L	351 CID	Towing Package; Base,Base,Country Squire, Crown Victoria,S	22011
1982	V8-5.8L	351 CID	Towing Package; Base,Base,Crown Victoria,S	22011
1983-1984	V8-5.8L	351 CID	Towing Package; Country Squire,Country Squire, Crown Victoria	22011
1985	V8-5.8L	351 CID	Police; Country Squire,Country Squire,Crown Victoria	22011
1986	V8-5.8L	351 CID	Police; Country Squire,Country Squire, Country Squire LX,Crown Victoria,Crown Victoria LX	22011
1965-1966	V8-5.8L	352 CID		22011
1965-1971	V8-6.4L	390 CID		22011
1971-1978	V8-6.6L	400 CID		22011
1965-1968	V8-7.0L	427 CID		22016
1966-1969	V8-7.0L	428 CID		22016
1969-1973	V8-7.0L	429 CID		22016
1972-1978	V8-7.5L	460 CID		22012
<b>LTD CROWN VICTORIA</b>				
1987-1989	V8-5.0L	302 CID	Exc.A/C; Base,Base,LX,S	22011
1990-1991	V8-5.0L	302 CID	Police (Towing Package); Base,Base,LX,S	22011
1987-1991	V8-5.8L	351 CID	Police; Base,Base	22011
<b>LTD II</b>				
1977-1979	V8-5.0L	302 CID		22016
1977-1979	V8-5.8L	351 CID		22016
1977-1978	V8-6.6L	400 CID		22016
<b>LTD II WAGON</b>				
1977	V8-5.8L	351 CID		22016
1977	V8-6.6L	400 CID		22016
<b>MAVERICK</b>				
1970-1972	L6-2.8L	170 CID		22011
1970-1977	L6-3.3L	200 CID		22011
1970-1977	L6-4.1L	250 CID		22011
1971-1977	V8-5.0L	302 CID		22011
<b>MUSTANG</b>				
1980-1981	L6-3.3L	200 CID	A/C; Base,Ghia	22012
1982	L6-3.3L	200 CID	A/C; GL,GLX,L	22012
1965-1970	L6-3.3L	200 CID		22016
1979	L6-3.3L	200 CID		22038
1969-1973	L6-4.1L	250 CID		22011
1983	V6-3.8L	232 CID	Exc.A/C; GL,GL,GLX,L	22126
1984	V6-3.8L	232 CID	Exc.A/C; L,L,LX	22126
1985	V6-3.8L	232 CID	A/C (From 04/85); LX,LX	22146
1986	V6-3.8L	232 CID	A/C; LX,LX	22146
1980	V8-4.2L	255 CID	A/C; Base,Ghia	22126
1981	V8-4.2L	255 CID	A/C; Base,Cobra,Ghia	22126
1982	V8-4.2L	255 CID	A/C; GL,GLX,L	22126
1964-1965	V8-4.3L	260 CID		22016
1964-1968	V8-4.7L	289 CID		22011
1968-1979	V8-5.0L	302 CID		22011
1982	V8-5.0L	302 CID	Exc.A/C; GL,GL,GLX,GT,L	22126
1983	V8-5.0L	302 CID	Exc.A/C; GT,GT	22126
1984	V8-5.0L	302 CID	Exc.A/C; GT,GT,GT-350 20th Anniversary,L,LX	22126
1985	V8-5.0L	302 CID	Exc.A/C; GT,GT,LX	22126
1986-1992	V8-5.0L	302 CID	A/C; GT,GT,LX	22146
1993	V8-5.0L	302 CID	A/C; GT,GT,LX,SVT Cobra	22146
1969-1973	V8-5.8L	351 CID		22011
1967-1969	V8-6.4L	390 CID		22011
1968	V8-7.0L	427 CID		22016
1968-1970	V8-7.0L	428 CID		22016
1969-1971	V8-7.0L	429 CID		22016
<b>P100</b>				
1965-1967	L6-2.8L	170 CID		22038
<b>P350</b>				
1968-1974	L6-3.9L	240 CID		22016
1968-1976	L6-4.9L	300 CID		22016
1972-1976	V8-5.0L	302 CID		22016
1973	V8-5.9L	360 CID		22016

Years	Engine	Disp.	Application Description	USMW
1972-1973	V8-6.4L	390 CID		22016
1976	V8-6.6L	400 CID		22016
<b>RANCHERO</b>				
1966-1968	L6-3.3L	200 CID		22012
1969-1973	L6-4.1L	250 CID		22016
1969	V8-4.1L	250 CID		22016
1966-1968	V8-4.7L	289 CID		22016
1968-1979	V8-5.0L	302 CID		22016
1969-1979	V8-5.8L	351 CID		22016
1967-1969	V8-6.4L	390 CID		22016
1972-1978	V8-6.6L	400 CID		22016
1968-1969	V8-7.0L	428 CID		22012
1970-1973	V8-7.0L	429 CID		22012
1974-1977	V8-7.5L	460 CID		22012
<b>RANCHWAGON</b>				
1967-1969	L6-3.9L	240 CID		22016
1967-1968	V8-4.7L	289 CID		22016
1968-1972	V8-5.0L	302 CID		22016
1969-1974	V8-5.8L	351 CID		22016
1967-1971	V8-6.4L	390 CID		22016
1971-1976	V8-6.6L	400 CID		22016
1967	V8-7.0L	427 CID		22016
1967-1970	V8-7.0L	428 CID		22016
1969-1973	V8-7.0L	429 CID		22016
1973-1975	V8-7.5L	460 CID		22038
<b>RANGER</b>				
1983	L4-2.0L	122 CID	Exc.A/C; Base,Base,XL,XLS,XLT	22010
1984	L4-2.0L	122 CID	Exc.A/C; S,S,XL,XLS,XLT	22010
1985	L4-2.0L	122 CID	Exc.A/C; Base,Base,XL,XLS,XLT	22010
1986	L4-2.0L	122 CID	Exc.A/C; Base,Base,S,STX,XL,XLT	22010
1987-1988	L4-2.0L	122 CID	Exc.A/C; Custom,Custom,S,STX,XLT	22010
1983	L4-2.3L	140 CID	Exc.A/C; Base,Base,XL,XLS,XLT	22010
1984	L4-2.3L	140 CID	Exc.A/C; S,S,XL,XLS,XLT	22010
1988	L4-2.3L	140 CID	Exc.A/C; Custom,Custom,S,STX,XLT	22010
1989	L4-2.3L	140 CID	Custom,GT,S,STX,XLT	22010
1990	L4-2.3L	140 CID	Custom,S,S Plus,STX,XLT	22010
1991-1992	L4-2.3L	140 CID	Custom,S,Sport,STX,XLT	22010
1993	L4-2.3L	140 CID	Splash,Sport,STX,XL,XLT	22010
1994	L4-2.3L	140 CID	Splash,STX,XL,XLT	22010
1995	L4-2.3L	140 CID	Splash,STX,XL,XL Sport,XLT	22010
1996	L4-2.3L	140 CID	Splash,STX,XL,XLT	22010
1997	L4-2.3L	140 CID	Splash,Sport,STX,XL,XLT	22010
1985	L4-2.3L	140 CID	Diesel; Exc.A/C; Base,Base,XL,XLS,XLT	22065
1986	L4-2.3L	140 CID	Diesel; Exc.A/C; Base,Base,S,STX,XL,XLT	22065
1987	L4-2.3L	140 CID	Diesel; Exc.A/C; Custom,Custom,S,STX,XLT	22065
2001-2005	L4-2.3L	140 CID	XL,XLT	22135
2006	L4-2.3L	140 CID	XL,XLT	22166
2007	L4-2.3L	140 CID	STX,XL,XLT	22166
2008-2011	L4-2.3L	140 CID	XL,XLT	22166
1998	L4-2.5L	153 CID	A/C; Splash,Splash,XL,XLT	22015
1999-2001	L4-2.5L	153 CID	A/C; XL,XL,XLT	22015
1983	V6-2.8L	171 CID	Exc.A/C; Base,Base,XL,XLS,XLT	22060
1984	V6-2.8L	171 CID	Exc.A/C; S,S,XL,XLS,XLT	22060
1985	V6-2.8L	171 CID	Exc.A/C; Base,Base,XL,XLS,XLT	22060
1986	V6-2.9L	177 CID	Exc.A/C; Base,Base,S,STX,XL,XLT	22060
1987	V6-2.9L	177 CID	Exc.A/C; Custom,Custom,S,STX,XLT	22060
1988	V6-2.9L	177 CID	Exc.A/C (To 04/22/88); Custom,Custom,S,STX,XLT	22060
1989	V6-2.9L	177 CID	Exc.A/C; Custom,Custom,GT,S,STX,XLT	22060
1990	V6-2.9L	177 CID	Exc.A/C; Custom,Custom,S,S Plus,STX,XLT	22060
1991-1992	V6-2.9L	177 CID	Exc.A/C; Custom,Custom,S,Sport,STX,XLT	22060
1991-1992	V6-3.0L	182 CID	Exc.A/C; Custom,Custom,S,Sport,STX,XLT	22064
1993	V6-3.0L	182 CID	Exc.A/C; Splash,Splash,Sport,STX,XL,XLT	22064
1994	V6-3.0L	182 CID	Exc.A/C; Splash,Splash,STX,XL,XLT	22064
1998	V6-3.0L	182 CID	Splash,XL,XLT	22078
1999-2000	V6-3.0L	182 CID	XL,XLT	22078
2001-2003	V6-3.0L	182 CID	Edge,XL,XLT	22078
2004	V6-3.0L	182 CID	Edge,Tremor,XL,XLT	22078
2005	V6-3.0L	182 CID	Edge,STX,XL,XLT	22078
2006-2007	V6-3.0L	182 CID	Sport,STX,XL,XLT	22078

**FAN CLUTCHES**



Years	Engine	Disp.	Application Description	USMW
2008	V6-3.0L	182 CID	Sport,XL,XLT	<b>22078</b>
1995	V6-3.0L	182 CID	Exc.Max Cooling; Splash,Splash,STX,XL,XL Sport,XLT	<b>22166</b>
1996	V6-3.0L	182 CID	Exc.Max Cooling; Splash,Splash,STX,XL,XLT	<b>22166</b>
1997	V6-3.0L	182 CID	Exc.Max Cooling; Splash,Splash,Sport,STX,XL,XLT	<b>22166</b>
1995	V6-4.0L	245 CID	Max Cooling; Splash,Splash,STX,XL,XL Sport,XLT	<b>22166</b>
1996	V6-4.0L	245 CID	Exc.Max Cooling; Splash,Splash,STX,XL,XLT	<b>22166</b>
1998	V6-4.0L	245 CID	Splash,XL,XLT	<b>22166</b>
1999-2000	V6-4.0L	245 CID	XL,XLT	<b>22166</b>
2001-2003	V6-4.0L	245 CID	Edge,XL,XLT	<b>22166</b>
2004	V6-4.0L	245 CID	Edge,Tremor,XLT	<b>22166</b>
2005	V6-4.0L	245 CID	Edge,FX4,XL,XLT	<b>22166</b>
2006-2007	V6-4.0L	245 CID	FX4,Sport,STX,XL,XLT	<b>22166</b>
2008-2009	V6-4.0L	245 CID	FX4,Sport,XL,XLT	<b>22166</b>
2010-2011	V6-4.0L	245 CID	Sport,XL,XLT	<b>22166</b>
1990	V6-4.0L	245 CID	Auto Trans; Custom,Custom,S,S Plus,STX,XLT	<b>22167</b>
1991-1992	V6-4.0L	245 CID	Exc.Max Cooling; Custom,Custom,S,Sport,STX,XLT	<b>22167</b>
1993	V6-4.0L	245 CID	Exc.Max Cooling; Splash,Splash,Sport,STX,XL,XLT	<b>22167</b>
1994	V6-4.0L	245 CID	Exc.Max Cooling; Splash,Splash,STX,XL,XLT	<b>22167</b>
1997	V6-4.0L	245 CID	Exc.Max Cooling; Splash,Splash,Sport,STX,XL,XLT	<b>22167</b>
<b>THUNDERBIRD</b>				
1980	L6-3.3L	200 CID	Exc.A/C; Base,Base,Silver Anniversary,Town Landau	<b>22038</b>
1981-1982	L6-3.3L	200 CID	Exc.A/C; Base,Base,Heritage,Town Landau	<b>22038</b>
1982	V6-3.8L	232 CID	Exc.A/C; Base,Base,Heritage,Town Landau	<b>22126</b>
1983	V6-3.8L	232 CID	Exc.A/C; Base,Base,Heritage,LX,Sport	<b>22126</b>
1984-1985	V6-3.8L	232 CID	Exc.A/C; Base,Base,Elan,File,LX,Sport	<b>22126</b>
1986	V6-3.8L	232 CID	Exc.A/C; Base,Base,Elan,LX,Sport	<b>22126</b>
1987-1988	V6-3.8L	232 CID	Exc.A/C; Base,Base,LX	<b>22126</b>
1989-1992	V6-3.8L	232 CID	Base,LX	<b>22126</b>
1993	V6-3.8L	232 CID	LX	<b>22126</b>
1980	V8-4.2L	255 CID	A/C; Base,Base,Town Landau	<b>22011</b>
1981-1982	V8-4.2L	255 CID	A/C; Base,Base,Heritage,Town Landau	<b>22011</b>
1977-1979	V8-5.0L	302 CID		<b>22011</b>
1983	V8-5.0L	302 CID	Exc.A/C; Base,Base,Heritage,LX,Sport	<b>22011</b>
1984	V8-5.0L	302 CID	Exc.A/C; Base,Base,Elan,File,LX,Sport	<b>22011</b>
1985	V8-5.0L	302 CID	Exc.A/C; Base,Base,Elan,File,LX,Sport	<b>22126</b>
1986	V8-5.0L	302 CID	Exc.A/C; Base,Base,Elan,LX,Sport	<b>22126</b>
1987-1988	V8-5.0L	302 CID	Exc.A/C; Base,Base,LX,Sport	<b>22126</b>
1991-1992	V8-5.0L	302 CID	Base,LX	<b>22163</b>
1993	V8-5.0L	302 CID	LX	<b>22163</b>
1977-1979	V8-5.8L	351 CID		<b>22011</b>
1961-1968	V8-6.4L	390 CID		<b>22011</b>
1972-1978	V8-6.6L	400 CID		<b>22011</b>
1966-1967	V8-7.0L	428 CID		<b>22016</b>
1968-1973	V8-7.0L	429 CID		<b>22016</b>
1972-1976	V8-7.5L	460 CID		<b>22012</b>
<b>TORINO</b>				
1968	L6-3.3L	200 CID		<b>22016</b>
1969-1974	L6-4.1L	250 CID		<b>22011</b>
1968	V8-4.7L	289 CID		<b>22011</b>
1968-1974	V8-5.0L	302 CID		<b>22011</b>
1969-1976	V8-5.8L	351 CID		<b>22011</b>
1968-1969	V8-6.4L	390 CID		<b>22011</b>
1972-1976	V8-6.6L	400 CID		<b>22011</b>
1968	V8-7.0L	427 CID		<b>22016</b>
1968-1969	V8-7.0L	428 CID		<b>22016</b>
1970-1973	V8-7.0L	429 CID		<b>22016</b>
1973-1976	V8-7.5L	460 CID		<b>22012</b>
<b>GEO</b>				
<b>TRACKER</b>				
1989-1997	L4-1.6L	98 CID	Base,LSi	<b>22068</b>
<b>GMC</b>				
<b>1000 1/2 TON</b>				
1966	L6-4.1L	250 CID		<b>22049</b>
<b>1001 1/2 TON</b>				
1966	L6-4.1L	250 CID		<b>22049</b>
<b>1002 1/2 TON</b>				
1966	V6-5.0L	305 CID		<b>22049</b>

Years	Engine	Disp.	Application Description	USMW
<b>1500 3/4 TON</b>				
1966	L6-4.1L	250 CID		<b>22049</b>
<b>1501 3/4 TON</b>				
1966	L6-4.1L	250 CID		<b>22049</b>
<b>2500 1 TON</b>				
1966	L6-4.1L	250 CID		<b>22049</b>
<b>C1000 1/2 TON</b>				
1963-1966	L6-3.8L	230 CID		<b>22049</b>
1966	L6-4.1L	250 CID		<b>22049</b>
1964-1966	L6-4.8L	292 CID		<b>22049</b>
1961-1966	V6-5.0L	305 CID		<b>22049</b>
<b>C1500</b>				
1980	L6-4.1L	250 CID	Exc.A/C; Base,Base,Heavy Half,High Sierra, Sierra Classic,Sierra Grande,Street Coupe	<b>22043</b>
1981-1982	L6-4.1L	250 CID	Exc.A/C; Base,Base,High Sierra,Sierra Classic, Sierra Grande,Street Coupe	<b>22043</b>
1983-1984	L6-4.1L	250 CID	Exc.A/C; Base,Base,High Sierra,Sierra Classic	<b>22043</b>
1980	L6-4.8L	292 CID	Exc.A/C; Base,Base,Heavy Half,High Sierra, Sierra Classic,Sierra Grande,Street Coupe	<b>22043</b>
1985-1986	V6-4.3L	262 CID	Base,High Sierra,Sierra Classic	<b>22049</b>
1988-1993	V6-4.3L	262 CID	Sierra,Sierra SLE,Sierra SLX	<b>22140</b>
1994-1995	V6-4.3L	262 CID	Sierra SL,Sierra SLE,Sierra SLT,Sierra Special	<b>22140</b>
1996	V6-4.3L	262 CID	Exc.A/C; Sierra SL,Sierra SL,Sierra SLE,Sierra SLT, Sierra Special	<b>22162</b>
1997	V6-4.3L	262 CID	Exc.A/C; Sierra GT,Sierra GT,Sierra SL,Sierra SLE, Sierra SLT,Sierra Special	<b>22162</b>
1998	V6-4.3L	262 CID	Exc.A/C; Sierra SL,Sierra SL,Sierra SLE,Sierra SLT, Sierra Special	<b>22162</b>
1983-1984	V8-5.0L	305 CID	Base,High Sierra,Sierra Classic	<b>22045</b>
1980	V8-5.0L	305 CID	Base,Heavy Half,High Sierra,Sierra Classic, Sierra Grande,Street Coupe	<b>22049</b>
1981-1982	V8-5.0L	305 CID	Base,High Sierra,Sierra Classic,Sierra Grande, Street Coupe	<b>22049</b>
1985-1986	V8-5.0L	305 CID	Base,High Sierra,Sierra Classic	<b>22049</b>
1988-1993	V8-5.0L	305 CID	Sierra,Sierra SLE,Sierra SLX	<b>22140</b>
1994-1995	V8-5.0L	305 CID	Sierra SL,Sierra SLE,Sierra SLT,Sierra Special	<b>22140</b>
1999	V8-5.0L	305 CID	A/C (Towing Package); Sierra SL,Sierra SL,Sierra SLE, Sierra SLT	<b>22158</b>
1996	V8-5.0L	305 CID	Exc.A/C; Sierra SL,Sierra SL,Sierra SLE,Sierra SLT, Sierra Special	<b>22162</b>
1997	V8-5.0L	305 CID	Exc.A/C; Sierra GT,Sierra GT,Sierra SL,Sierra SLE, Sierra SLT,Sierra Special	<b>22162</b>
1998	V8-5.0L	305 CID	Exc.A/C; Sierra SL,Sierra SL,Sierra SLE,Sierra SLT, Sierra Special	<b>22162</b>
1980	V8-5.7L	350 CID	Diesel; Exc.A/C; Base,Base,Heavy Half,High Sierra, Sierra Classic,Sierra Grande,Street Coupe	<b>22045</b>
1981	V8-5.7L	350 CID	Diesel; Exc.A/C; Base,Base,High Sierra,Sierra Classic, Sierra Grande,Street Coupe	<b>22045</b>
1982	V8-5.7L	350 CID	Exc.A/C; Base,Base,High Sierra,Sierra Classic, Sierra Grande,Street Coupe	<b>22045</b>
1983	V8-5.7L	350 CID	Exc.A/C; Base,Base,High Sierra,Sierra Classic	<b>22045</b>
1984	V8-5.7L	350 CID	A/C; Base,Base,High Sierra,Sierra Classic	<b>22045</b>
1985-1986	V8-5.7L	350 CID	Base,High Sierra,Sierra Classic	<b>22049</b>
1988-1993	V8-5.7L	350 CID	Sierra,Sierra SLE,Sierra SLX	<b>22140</b>
1994-1995	V8-5.7L	350 CID	Sierra SL,Sierra SLE,Sierra SLT,Sierra Special	<b>22140</b>
1999	V8-5.7L	350 CID	A/C (Towing Package); Sierra SL,Sierra SL,Sierra SLE, Sierra SLT	<b>22158</b>
1996	V8-5.7L	350 CID	Exc.A/C; Sierra SL,Sierra SL,Sierra SLE,Sierra SLT, Sierra Special	<b>22162</b>
1997	V8-5.7L	350 CID	Exc.A/C; Sierra GT,Sierra GT,Sierra SL,Sierra SLE, Sierra SLT,Sierra Special	<b>22162</b>
1998	V8-5.7L	350 CID	Exc.A/C; Sierra SL,Sierra SL,Sierra SLE,Sierra SLT, Sierra Special	<b>22162</b>
1983-1986	V8-6.2L	379 CID	Diesel; Base,High Sierra,Sierra Classic	<b>22052</b>
1988-1993	V8-6.2L	379 CID	Diesel; Sierra,Sierra SLE,Sierra SLX	<b>22154</b>
1982	V8-6.2L	379 CID	Diesel; Base,Base,High Sierra,Sierra Classic, Sierra Grande,Street Coupe	<b>22602</b>
1994-1996	V8-6.5L	395 CID	Diesel; Sierra SL,Sierra SLE,Sierra SLT,Sierra Special	<b>22605</b>



Years	Engine	Disp.	Application Description	USMW
1997	V8-6.5L	395 CID	Diesel; Sierra GT, Sierra SL, Sierra SLE, Sierra SLT, Sierra Special	22613
1980	V8-7.4L	454 CID	Base, Heavy Half, High Sierra, Sierra Classic, Sierra Grande, Street Coupe	22045
<b>C1500 (MEX)</b>				
1987	V8-5.7L	350 CID	With 3.42 or lower rear axle ratio,,	22054
<b>C1500 1/2 TON</b>				
1978-1979	L6-4.1L	250 CID		22043
1967-1977	L6-4.1L	250 CID		22049
1978-1979	L6-4.8L	292 CID		22043
1967-1977	L6-4.8L	292 CID		22049
1968-1969	V6-5.0L	305 CID		22045
1967	V6-5.0L	305 CID		22049
1976-1979	V8-5.0L	305 CID		22045
1977-1978	V8-5.0L	305 CID		22049
1969-1973	V8-5.0L	307 CID		22045
1968	V8-5.3L	327 CID		22049
1969-1979	V8-5.7L	350 CID		22045
1975-1978	V8-5.7L	350 CID		22049
1968-1969	V8-6.5L	396 CID		22045
1976-1978	V8-6.6L	400 CID		22051
1970-1972	V8-6.6L	402 CID		22045
1973-1979	V8-7.4L	454 CID		22045
1975-1978	V8-7.4L	454 CID		22051
<b>C1500 3/4 TON</b>				
1964-1965	L6-3.8L	230 CID		22049
1961-1965	V6-5.0L	305 CID		22049
<b>C1500 SUBURBAN</b>				
1980	L6-4.1L	250 CID	Exc.A/C; Base, Base, High Sierra, Sierra Classic, Sierra Grande	22043
1980-1981	V8-5.0L	305 CID	Base, High Sierra, Sierra Classic, Sierra Grande	22045
1983-1984	V8-5.0L	305 CID	Base, High Sierra, Sierra Classic	22045
1982	V8-5.0L	305 CID	Base, High Sierra, Sierra Classic, Sierra Grande	22049
1985-1986	V8-5.0L	305 CID	Base, High Sierra, Sierra Classic	22049
1980-1981	V8-5.7L	350 CID	Diesel; Base, Base, High Sierra, Sierra Classic, Sierra Grande	22045
1982	V8-5.7L	350 CID	Exc.A/C; Base, Base, High Sierra, Sierra Classic, Sierra Grande	22045
1983	V8-5.7L	350 CID	Exc.A/C; Base, Base, High Sierra, Sierra Classic	22045
1984	V8-5.7L	350 CID	A/C; Base, Base, High Sierra, Sierra Classic	22045
1985-1986	V8-5.7L	350 CID	Base, High Sierra, Sierra Classic	22049
1992-1994	V8-5.7L	350 CID	Base, SLE	22140
1995	V8-5.7L	350 CID	Base, SLE, SLT	22140
1996	V8-5.7L	350 CID	Exc.A/C; Base, Base, SLE, SLT	22162
1997	V8-5.7L	350 CID	Exc.A/C; Base, Base, SLE, SLT	22162
1998-1999	V8-5.7L	350 CID	Exc.A/C; Base, Base, SLE, SLT	22162
1983-1986	V8-6.2L	379 CID	Diesel; Base, High Sierra, Sierra Classic	22052
1982	V8-6.2L	379 CID	Diesel; Towing Package; Base, Base, High Sierra, Sierra Classic, Sierra Grande	22602
1995-1996	V8-6.5L	395 CID	Diesel; Base, SLE, SLT	22605
1997-1998	V8-6.5L	395 CID	Diesel; Base, SLE, SLT	22613
1999	V8-6.5L	395 CID	Diesel; Base, Base, SLE, SLT	22614
1980	V8-7.4L	454 CID	Base, High Sierra, Sierra Classic, Sierra Grande	22045
<b>C2500</b>				
1980-1982	L6-4.1L	250 CID	Exc.A/C; Base, Base, High Sierra, Sierra Classic, Sierra Grande	22043
1983-1984	L6-4.1L	250 CID	Exc.A/C; Base, Base, High Sierra, Sierra Classic	22043
1980-1981	L6-4.8L	292 CID	Exc.A/C; Base, Base, High Sierra, Sierra Classic, Sierra Grande	22043
1982	L6-4.8L	292 CID	Base, High Sierra, Sierra Classic, Sierra Grande	22043
1983	L6-4.8L	292 CID	Base, High Sierra, Sierra Classic	22043
1984	L6-4.8L	292 CID	A/C; Base, Base, High Sierra, Sierra Classic	22045
1985-1986	L6-4.8L	292 CID	Base, High Sierra, Sierra Classic	22045
1985-1986	V6-4.3L	262 CID	Base, High Sierra, Sierra Classic	22049
1988-1993	V6-4.3L	262 CID	Sierra, Sierra SLE, Sierra SLX	22140
1994-1995	V6-4.3L	262 CID	Sierra SL, Sierra SLE	22140
1980-1981	V8-5.0L	305 CID	Base, High Sierra, Sierra Classic, Sierra Grande	22045
1983-1984	V8-5.0L	305 CID	Base, High Sierra, Sierra Classic	22045
1982	V8-5.0L	305 CID	Base, High Sierra, Sierra Classic, Sierra Grande	22049

Years	Engine	Disp.	Application Description	USMW
1985-1986	V8-5.0L	305 CID	Base, High Sierra, Sierra Classic	22049
1988-1993	V8-5.0L	305 CID	Sierra, Sierra SLE, Sierra SLX	22140
1994-1995	V8-5.0L	305 CID	Sierra SL, Sierra SLE, Sierra SLT	22140
1996	V8-5.0L	305 CID	Exc.A/C; Sierra SL, Sierra SL, Sierra SLE, Sierra SLT	22162
1997	V8-5.0L	305 CID	Exc.A/C; Sierra SL, Sierra SL, Sierra SLE, Sierra SLT	22162
1998	V8-5.0L	305 CID	Exc.A/C; Sierra SL, Sierra SL, Sierra SLE, Sierra SLT	22162
1980-1981	V8-5.7L	350 CID	Base, High Sierra, Sierra Classic, Sierra Grande	22045
1982	V8-5.7L	350 CID	Exc.A/C; Base, Base, High Sierra, Sierra Classic, Sierra Grande	22045
1983	V8-5.7L	350 CID	Exc.A/C; Base, Base, High Sierra, Sierra Classic	22045
1984	V8-5.7L	350 CID	A/C; Base, Base, High Sierra, Sierra Classic	22045
1985-1986	V8-5.7L	350 CID	Base, High Sierra, Sierra Classic	22049
1988-1993	V8-5.7L	350 CID	Sierra, Sierra SLE, Sierra SLX	22140
1994-1995	V8-5.7L	350 CID	Sierra SL, Sierra SLE, Sierra SLT	22140
1996	V8-5.7L	350 CID	Exc.A/C; Sierra SL, Sierra SL, Sierra SLE, Sierra SLT	22162
1997	V8-5.7L	350 CID	Exc.A/C; Sierra SL, Sierra SL, Sierra SLE, Sierra SLT	22162
1998-2000	V8-5.7L	350 CID	Exc.A/C; Sierra SL, Sierra SL, Sierra SLE, Sierra SLT	22162
1983-1986	V8-6.2L	379 CID	Diesel; Base, High Sierra, Sierra Classic	22052
1988-1993	V8-6.2L	379 CID	Diesel; Sierra, Sierra SLE, Sierra SLX	22154
1982	V8-6.2L	379 CID	Diesel; Base, Base, High Sierra, Sierra Classic, Sierra Grande	22602
1994-1996	V8-6.5L	395 CID	Diesel; Sierra SL, Sierra SLE, Sierra SLT	22605
1992-1993	V8-6.5L	395 CID	Diesel; Sierra, Sierra SLE, Sierra SLX	22606
1997-1998	V8-6.5L	395 CID	Diesel; Sierra SL, Sierra SLE, Sierra SLT	22613
1999	V8-6.5L	395 CID	Diesel; Sierra SL, Sierra SL, Sierra SLE, Sierra SLT	22614
2000	V8-6.5L	395 CID	Diesel; Sierra SL, Sierra SLE, Sierra SLT	22614
1980-1982	V8-7.4L	454 CID	Base, High Sierra, Sierra Classic, Sierra Grande	22045
1983-1986	V8-7.4L	454 CID	Base, High Sierra, Sierra Classic	22045
1991-1993	V8-7.4L	454 CID	Sierra, Sierra SLE, Sierra SLX	22145
1994-2000	V8-7.4L	454 CID	Sierra SL, Sierra SLE, Sierra SLT	22145
<b>C2500 (MEX)</b>				
1987	V8-5.7L	350 CID	With 3.42 or lower rear axle ratio,,	22054
1988-1991	V8-5.7L	350 CID	A/C,,	22145
<b>C2500 1 TON</b>				
1964-1965	L6-3.8L	230 CID		22049
1961-1965	V6-5.0L	305 CID		22049
<b>C2500 3/4 TON</b>				
1978	L6-4.1L	250 CID		22043
1968-1979	L6-4.1L	250 CID		22045
1967-1977	L6-4.1L	250 CID		22049
1978	L6-4.8L	292 CID		22043
1968-1979	L6-4.8L	292 CID		22045
1967-1977	L6-4.8L	292 CID		22049
1968-1969	V6-5.0L	305 CID		22045
1967	V6-5.0L	305 CID		22049
1967	V8-4.6L	283 CID		22049
1979	V8-5.0L	305 CID		22045
1977-1978	V8-5.0L	305 CID		22049
1969-1973	V8-5.0L	307 CID		22045
1968	V8-5.3L	327 CID		22049
1969-1979	V8-5.7L	350 CID		22045
1968-1969	V8-6.5L	396 CID		22045
1976-1978	V8-6.6L	400 CID		22045
1970-1972	V8-6.6L	402 CID		22045
1973-1979	V8-7.4L	454 CID		22045
<b>C2500 SUBURBAN</b>				
1980-1981	L6-4.8L	292 CID	Exc.A/C; Base, Base, High Sierra, Sierra Classic, Sierra Grande	22043
1982	L6-4.8L	292 CID	Base, High Sierra, Sierra Classic, Sierra Grande	22043
1984	L6-4.8L	292 CID	A/C; Base, Base, High Sierra, Sierra Classic	22045
1982	V8-5.0L	305 CID	Base, High Sierra, Sierra Classic, Sierra Grande	22045
1983-1984	V8-5.0L	305 CID	Base, High Sierra, Sierra Classic	22045
1985-1986	V8-5.0L	305 CID	Base, High Sierra, Sierra Classic	22049
1980	V8-5.7L	350 CID	Diesel; Base, Base, High Sierra, Sierra Classic, Sierra Grande	22045
1981	V8-5.7L	350 CID	Base, High Sierra, Sierra Classic, Sierra Grande	22045
1982	V8-5.7L	350 CID	Exc.A/C; Base, Base, High Sierra, Sierra Classic, Sierra Grande	22045
1983	V8-5.7L	350 CID	Exc.A/C; Base, Base, High Sierra, Sierra Classic	22045

Years	Engine	Disp.	Application Description	USMW
1984	V8-5.7L	350 CID	A/C; Base,Base,High Sierra,Sierra Classic	22045
1985-1986	V8-5.7L	350 CID	Base,High Sierra,Sierra Classic	22049
1992-1994	V8-5.7L	350 CID	Base,SLE	22140
1995	V8-5.7L	350 CID	Base,SLE,SLT	22140
1996	V8-5.7L	350 CID	Exc.A/C; Base,Base,SLE,SLT	22162
1997	V8-5.7L	350 CID	Exc.A/C; Base,Base,SLE,SLT	22162
1998-1999	V8-5.7L	350 CID	Exc.A/C; Base,Base,SLE,SLT	22162
1983-1986	V8-6.2L	379 CID	Diesel; Base,High Sierra,Sierra Classic	22052
1982	V8-6.2L	379 CID	Diesel; Base,Base,High Sierra,Sierra Classic, Sierra Grande	22602
1994	V8-6.5L	395 CID	Diesel; Base,SLE	22605
1995-1996	V8-6.5L	395 CID	Diesel; Base,SLE,SLT	22605
1997-1998	V8-6.5L	395 CID	Diesel; Base,SLE,SLT	22613
1999	V8-6.5L	395 CID	Diesel; Base,Base,SLE,SLT	22614
1980-1982	V8-7.4L	454 CID	Base,High Sierra,Sierra Classic,Sierra Grande	22045
1983-1986	V8-7.4L	454 CID	Base,High Sierra,Sierra Classic	22045
1992-1994	V8-7.4L	454 CID	Base,SLE	22145
1995-1999	V8-7.4L	454 CID	Base,SLE,SLT	22145
<b>C3500</b>				
1980	L6-4.1L	250 CID	Exc.A/C; Base,Base,High Sierra,Sierra Classic, Sierra Grande	22043
1980-1981	L6-4.8L	292 CID	Exc.A/C; Base,Base,High Sierra,Sierra Classic, Sierra Grande	22043
1982	L6-4.8L	292 CID	Base,High Sierra,Sierra Classic,Sierra Grande	22043
1983	L6-4.8L	292 CID	Base,High Sierra,Sierra Classic	22043
1984	L6-4.8L	292 CID	A/C; Base,Base,High Sierra,Sierra Classic	22045
1985-1986	L6-4.8L	292 CID	Base,High Sierra,Sierra Classic	22045
1986	V8-5.0L	305 CID	Base,High Sierra,Sierra Classic	22049
1980-1982	V8-5.7L	350 CID	Base,High Sierra,Sierra Classic,Sierra Grande	22045
1983-1984	V8-5.7L	350 CID	Base,High Sierra,Sierra Classic	22045
1985-1986	V8-5.7L	350 CID	Base,High Sierra,Sierra Classic	22049
1988-1993	V8-5.7L	350 CID	Sierra,Sierra SLE,Sierra SLX	22145
1994-1995	V8-5.7L	350 CID	Sierra SL,Sierra SLE,Sierra SLT	22145
1996	V8-5.7L	350 CID	Exc.A/C; Sierra SL,Sierra SL,Sierra SLE,Sierra SLT	22162
1997	V8-5.7L	350 CID	Exc.A/C; Sierra SL,Sierra SL,Sierra SLE,Sierra SLT	22162
1998-2000	V8-5.7L	350 CID	Exc.A/C; Sierra SL,Sierra SL,Sierra SLE,Sierra SLT	22162
1983-1986	V8-6.2L	379 CID	Diesel; Base,High Sierra,Sierra Classic	22052
1988-1993	V8-6.2L	379 CID	Diesel; Sierra,Sierra SLE,Sierra SLX	22154
1982	V8-6.2L	379 CID	Diesel; Base,High Sierra,Sierra Classic,Sierra Grande	22602
1994-1996	V8-6.5L	395 CID	Diesel; Sierra SL,Sierra SLE,Sierra SLT	22605
1992-1993	V8-6.5L	395 CID	Diesel; Sierra,Sierra SLE,Sierra SLX	22606
1997-1998	V8-6.5L	395 CID	Diesel; Sierra SL,Sierra SLE,Sierra SLT	22613
1999	V8-6.5L	395 CID	Diesel; Sierra SL,Sierra SL,Sierra SLE,Sierra SLT	22614
2000	V8-6.5L	395 CID	Diesel; Sierra SL,Sierra SLE,Sierra SLT	22614
1980-1982	V8-7.4L	454 CID	Base,High Sierra,Sierra Classic,Sierra Grande	22045
1983-1986	V8-7.4L	454 CID	Base,High Sierra,Sierra Classic	22045
1988-1993	V8-7.4L	454 CID	Sierra,Sierra SLE,Sierra SLX	22145
1994-2000	V8-7.4L	454 CID	Sierra SL,Sierra SLE,Sierra SLT	22145
<b>C3500 (MEX)</b>				
1987	V8-5.7L	350 CID	With 3.42 or lower rear axle ratio,;	22054
<b>C3500 1 TON</b>				
1978	L6-4.1L	250 CID		22043
1968-1974	L6-4.1L	250 CID		22045
1967-1975	L6-4.1L	250 CID		22049
1978	L6-4.8L	292 CID		22043
1968-1979	L6-4.8L	292 CID		22045
1967-1977	L6-4.8L	292 CID		22049
1968-1969	V6-5.0L	305 CID		22045
1978	V8-5.0L	305 CID		22049
1968-1973	V8-5.0L	307 CID		22045
1968	V8-5.3L	327 CID		22049
1969-1979	V8-5.7L	350 CID		22045
1975-1978	V8-5.7L	350 CID		22049
1968-1969	V8-6.5L	396 CID		22045
1976-1978	V8-6.6L	400 CID		22051
1970-1972	V8-6.6L	402 CID		22045
1973-1979	V8-7.4L	454 CID		22045
1975-1978	V8-7.4L	454 CID		22051

Years	Engine	Disp.	Application Description	USMW
<b>CABALLERO</b>				
1978-1979	V6-3.3L	200 CID		22043
1980	V6-3.8L	229 CID	Base,Diablo,Laredo	22049
1981	V6-3.8L	229 CID	Amarillo,Base,Conquista,Diablo,Royal Knight	22049
1982-1983	V6-3.8L	229 CID	Amarillo,Base,Diablo	22049
1984	V6-3.8L	229 CID	Base,Diablo	22049
1978-1979	V6-3.8L	231 CID		22043
1980	V6-3.8L	231 CID	Base,Diablo,Laredo	22049
1981	V6-3.8L	231 CID	Amarillo,Base,Conquista,Diablo,Royal Knight	22049
1982-1984	V6-3.8L	231 CID	Amarillo,Base,Diablo	22049
1985-1986	V6-4.3L	262 CID	Amarillo,Base,Diablo	22049
1987	V6-4.3L	262 CID	Base,Diablo	22049
1979	V8-4.4L	267 CID		22043
1980	V8-4.4L	267 CID	Base,Diablo,Laredo	22049
1981	V8-4.4L	267 CID	Amarillo,Base,Conquista,Diablo,Royal Knight	22049
1982	V8-4.4L	267 CID	Amarillo,Base,Diablo	22049
1978-1979	V8-5.0L	305 CID		22043
1980	V8-5.0L	305 CID	Base,Diablo,Laredo	22049
1981	V8-5.0L	305 CID	Amarillo,Base,Conquista,Diablo,Royal Knight	22049
1982-1984	V8-5.0L	305 CID	Exc.A/C; Amarillo,Amarillo,Base,Diablo	22049
1985-1986	V8-5.0L	305 CID	Federal; Amarillo,Amarillo,Base,Diablo	22049
1987	V8-5.0L	305 CID	Federal; Base,Base,Diablo	22049
1978-1979	V8-5.7L	350 CID		22043
1983-1984	V8-5.7L	350 CID	Diesel; Exc.Heavy Duty Cooling; Amarillo,Amarillo, Base,Diablo	22049
<b>CANYON</b>				
2004	L4-2.8L	169 CID	SL,SLE,Z71 Fleet,Z71 SL,Z71 SLE,Z85 SL,Z85 SLE	22023
2005	L4-2.8L	169 CID	Z71 Fleet,Z71 SL,Z71 SLE,Z85 SL,Z85 SLE	22023
2006	L4-2.8L	169 CID	SL,SLE,WT	22023
2007	L4-2.9L	178 CID	SL,SLE,WT	22023
2008	L4-2.9L	178 CID	SL,SLE,SLT,WT	22023
2009	L4-2.9L	178 CID	SLE,SLT,WT	22023
2010-2012	L4-2.9L	178 CID	SLE,WT	22023
2004	L5-3.5L	211 CID	SL,SLE,Z71 Fleet,Z71 SL,Z71 SLE,Z85 SL,Z85 SLE	22173
2005	L5-3.5L	211 CID	Z71 Fleet,Z71 SL,Z71 SLE,Z85 SL,Z85 SLE	22173
2006	L5-3.5L	211 CID	SLE,SLT,WT	22173
2007-2012	L5-3.7L	223 CID	SLE,SLT,WT	22173
2009	V8-5.3L	325 CID	SLT	22615
2010-2012	V8-5.3L	325 CID	SLE,SLT	22615
<b>ENVOY</b>				
2002-2006	L6-4.2L	256 CID	SLE,SLT	22310
2007	L6-4.2L	256 CID	SLE,SLT	22330
2008-2009	L6-4.2L	256 CID	SLE,SLE,SLT	22627
2005	V8-5.3L	323 CID	Denali	22310
2006	V8-5.3L	323 CID	Denali	22310
2007	V8-5.3L	325 CID	Electronic; Denali	22330
2008-2009	V8-5.3L	325 CID	Denali,Denali	22627
<b>ENVOY XL</b>				
2002-2006	L6-4.2L	256 CID	SLE,SLT	22310
2003-2004	V8-5.3L	323 CID	SLE,SLT	22310
2005	V8-5.3L	323 CID	Denali,SLE,SLT	22310
2006	V8-5.3L	325 CID	Denali	22310
<b>ENVOY XUV</b>				
2004-2005	L6-4.2L	256 CID	SLE,SLT	22310
2004-2005	V8-5.3L	323 CID	SLE,SLT	22310
<b>G1000 1/2 TON VAN</b>				
1964	L4-2.5L	153 CID		22049
1965	L6-3.2L	194 CID		22049
<b>G1000 VAN</b>				
1966	L6-3.8L	230 CID		22049
<b>G1500</b>				
1980-1981	L6-4.1L	250 CID	Rally,Rally STX,Vandura	22049
1982	L6-4.1L	250 CID	Exc.A/C; Rally,Rally,Rally STX,Vandura	22049
1983-1984	L6-4.1L	250 CID	Exc.A/C; Rally,Rally,Rally Custom,Rally STX,Vandura	22049
1985-1986	V6-4.3L	262 CID	Rally,Rally STX,Vandura	22049
1987-1993	V6-4.3L	262 CID	Rally,Rally STX,Vandura	22145
1994-1995	V6-4.3L	262 CID	Vandura	22145
1981	V8-5.0L	305 CID	Rally,Rally STX,Vandura	22043

Years	Engine	Disp.	Application Description	USMW
1980	V8-5.0L	305 CID	Rally,Rally STX,Vandura	22045
1982	V8-5.0L	305 CID	Rally,Rally STX,Vandura	22049
1983-1984	V8-5.0L	305 CID	Rally,Rally Custom,Rally STX,Vandura	22049
1985-1986	V8-5.0L	305 CID	Rally,Rally STX,Vandura	22049
1987-1995	V8-5.0L	305 CID	Rally,Rally STX,Vandura	22145
1982	V8-5.7L	350 CID	Rally,Rally STX	22026
1983	V8-5.7L	350 CID	Rally	22026
1980-1981	V8-5.7L	350 CID	Rally,Rally STX,Vandura	22045
1984	V8-5.7L	350 CID	Rally,Rally Custom,Rally STX	22049
1985-1986	V8-5.7L	350 CID	Rally,Rally STX	22049
1987-1993	V8-5.7L	350 CID	Rally,Rally STX	22145
<b>G1500 1/2 TON VAN</b>				
1967-1969	L6-3.8L	230 CID		22049
1967-1979	L6-4.1L	250 CID		22049
1967	V8-4.6L	283 CID		22049
1979	V8-5.0L	305 CID		22045
1977-1978	V8-5.0L	305 CID		22049
1968-1973	V8-5.0L	307 CID		22049
1971-1979	V8-5.7L	350 CID		22049
1976-1979	V8-6.6L	400 CID		22045
<b>G2500</b>				
1980-1981	L6-4.1L	250 CID	Rally,Rally STX,Vandura	22049
1982	L6-4.1L	250 CID	A/C (Heavy Duty Cooling); Rally,Rally,Rally STX, Vandura	22049
1983-1984	L6-4.1L	250 CID	A/C (Heavy Duty Cooling); Rally,Rally,Rally Custom, Rally STX,Vandura	22049
1985-1986	V6-4.3L	262 CID	Rally,Rally STX,Vandura	22049
1987-1995	V6-4.3L	262 CID	Rally,Rally STX,Vandura	22142
1981	V8-5.0L	305 CID	Rally,Rally STX,Vandura	22043
1980	V8-5.0L	305 CID	Rally,Rally STX	22045
1982	V8-5.0L	305 CID	Rally,Rally STX,Vandura	22049
1983-1984	V8-5.0L	305 CID	Rally,Rally Custom,Rally STX,Vandura	22049
1985-1986	V8-5.0L	305 CID	Rally,Rally STX,Vandura	22049
1989-1995	V8-5.0L	305 CID	Rally,Rally STX,Vandura	22142
1987-1988	V8-5.0L	305 CID	Rally,Rally STX,Vandura	22145
1980-1981	V8-5.7L	350 CID	Rally,Rally STX,Vandura	22026
1982	V8-5.7L	350 CID	Rally,Rally STX	22026
1983	V8-5.7L	350 CID	Rally,Rally Custom,Rally STX,Vandura	22026
1985	V8-5.7L	350 CID	Rally,Rally STX,Vandura	22026
1984	V8-5.7L	350 CID	Rally,Rally Custom,Rally STX	22049
1986	V8-5.7L	350 CID	Rally,Rally STX,Vandura	22049
1987-1995	V8-5.7L	350 CID	Rally,Rally STX,Vandura	22142
1983-1984	V8-6.2L	379 CID	Diesel; Rally,Rally Custom,Rally STX,Vandura	22052
1985-1993	V8-6.2L	379 CID	Diesel; Rally,Rally STX,Vandura	22052
1994-1995	V8-6.5L	395 CID	Diesel; Rally,Rally STX,Vandura	22154
1980	V8-6.6L	400 CID	Rally,Rally STX,Vandura	22045
<b>G2500 3/4 TON VAN</b>				
1967-1969	L6-3.8L	230 CID		22049
1968-1979	L6-4.1L	250 CID		22049
1974-1978	L6-4.8L	292 CID		22043
1967	V8-4.6L	283 CID		22049
1968-1973	V8-5.0L	307 CID		22049
1974-1979	V8-5.7L	350 CID		22045
1970-1978	V8-5.7L	350 CID		22049
1975-1979	V8-6.6L	400 CID		22045
1975-1976	V8-7.4L	454 CID		22051
<b>G3500</b>				
1982-1984	L6-4.1L	250 CID	A/C (Heavy Duty Cooling); Vandura,Vandura, Vandura Special	22049
1985-1986	V6-4.3L	262 CID	Vandura,Vandura Special	22045
1987-1995	V6-4.3L	262 CID	Vandura,Vandura Special	22145
1981	V8-5.0L	305 CID	Vandura,Vandura Special	22045
1980-1982	V8-5.7L	350 CID	Magnavan,Rally,Rally Camper Special,Rally STX, Vandura,Vandura Special	22045
1983-1984	V8-5.7L	350 CID	Magnavan,Rally,Rally Camper Special,Rally Custom, Rally STX,Vandura,Vandura Special	22045
1985-1986	V8-5.7L	350 CID	Magnavan,Rally,Rally Camper Special,Rally STX, Vandura,Vandura Special	22045

Years	Engine	Disp.	Application Description	USMW
1987-1988	V8-5.7L	350 CID	Magnavan,Magnavan,Rally,Rally Camper Special, Rally STX,Vandura,Vandura Special	22145
1989-1992	V8-5.7L	350 CID	Magnavan,Rally,Rally Camper Special,Rally STX, Vandura,Vandura Special	22145
1993-1996	V8-5.7L	350 CID	Magnavan,Rally,Rally Camper Special,Rally STX, Vandura,Vandura Special	22153
1983	V8-6.2L	379 CID	Diesel; Magnavan,Rally,Rally Camper Special, Rally Custom,Rally STX,Vandura,Vandura Special	22052
1984	V8-6.2L	379 CID	Diesel; Exc.A/C; Magnavan,Magnavan,Rally, Rally Camper Special,Rally Custom,Rally STX, Vandura,Vandura Special	22052
1985-1993	V8-6.2L	379 CID	Diesel; Magnavan,Rally,Rally Camper Special, Rally STX,Vandura,Vandura Special	22052
1994	V8-6.5L	395 CID	Diesel; Rally,Rally Camper Special,Rally STX, Vandura,Vandura Special	22154
1995-1996	V8-6.5L	395 CID	Diesel; Magnavan,Rally,Rally Camper Special, Rally STX,Vandura,Vandura Special	22154
1980	V8-6.6L	400 CID	Magnavan,Rally,Rally Camper Special,Rally STX, Vandura,Vandura Special	22045
1988	V8-7.4L	454 CID	Magnavan	22145
1989-1996	V8-7.4L	454 CID	Magnavan,Rally,Rally Camper Special,Rally STX, Vandura,Vandura Special	22145
<b>G3500 1 TON VAN</b>				
1971-1979	L6-4.1L	250 CID		22049
1974-1978	L6-4.8L	292 CID		22043
1971-1979	V8-5.7L	350 CID		22049
1975-1979	V8-6.6L	400 CID		22045
1976	V8-7.4L	454 CID		22045
<b>JIMMY</b>				
1980-1982	L6-4.1L	250 CID	Exc.A/C; Base,Base,High Sierra,Sierra Classic, Sierra Grande,Street Coupe	22043
1992	V6-4.3L	262 CID	Base,SLE,SLT	22145
1993-1994	V6-4.3L	262 CID	Base,SLE,SLS,SLT	22145
1995	V6-4.3L	262 CID	Heavy Duty Heater; Base,Base,SL,SLE,SLS,SLT	22153
1996	V6-4.3L	262 CID	Exc.A/C; Base,Base,SL,SLE,SLS,SLT	22158
1997	V6-4.3L	262 CID	Heavy Duty Heater; SL,SL,SLE,SLS,SLT	22162
1998-1999	V6-4.3L	262 CID	Heavy Duty Heater; Envoy,Envoy,SL,SLE,SLS,SLT	22162
2000	V6-4.3L	262 CID	Heavy Duty Heater; Diamond Edition, Diamond Edition,Envoy,SLE,SLS,SLT	22162
2001	V6-4.3L	262 CID	Heavy Duty Heater; Diamond Edition, Diamond Edition,SLE,SLS,SLT	22162
1983-1984	V8-5.0L	305 CID	Base,High Sierra,Sierra Classic	22045
1980-1982	V8-5.0L	305 CID	Base,High Sierra,Sierra Classic,Sierra Grande, Street Coupe	22049
1985	V8-5.0L	305 CID	Base,High Sierra,Sierra Classic	22049
1986	V8-5.0L	305 CID	Base,Silverado	22049
1987	V8-5.0L	305 CID	Base,Sierra Classic	22049
1980-1981	V8-5.7L	350 CID	Base,High Sierra,Sierra Classic,Sierra Grande, Street Coupe	22045
1982	V8-5.7L	350 CID	Exc.A/C; Base,Base,High Sierra,Sierra Classic, Sierra Grande,Street Coupe	22045
1983	V8-5.7L	350 CID	Exc.A/C; Base,Base,High Sierra,Sierra Classic	22045
1984	V8-5.7L	350 CID	A/C; Base,Base,High Sierra,Sierra Classic	22045
1985	V8-5.7L	350 CID	Base,High Sierra,Sierra Classic	22049
1986	V8-5.7L	350 CID	Base,Silverado	22049
1987	V8-5.7L	350 CID	Base,Sierra Classic	22049
1988	V8-5.7L	350 CID	Sierra Classic	22049
1989	V8-5.7L	350 CID	Base,Base,Sierra Classic	22145
1990	V8-5.7L	350 CID	Base,Sierra Classic	22145
1991	V8-5.7L	350 CID	Base	22145
1983-1985	V8-6.2L	379 CID	Diesel; Base,High Sierra,Sierra Classic	22052
1986	V8-6.2L	379 CID	Diesel; Base,Silverado	22052
1987-1990	V8-6.2L	379 CID	Diesel; Base,Sierra Classic	22052
1991	V8-6.2L	379 CID	Diesel; Base	22052
1982	V8-6.2L	379 CID	Diesel; Towing Package; Base,Base,High Sierra, Sierra Classic,Sierra Grande,Street Coupe	22602
<b>JIMMY 2WD</b>				
1978-1979	L6-4.1L	250 CID		22043
1970-1977	L6-4.1L	250 CID		22049

**FAN CLUTCHES**



Years	Engine	Disp.	Application Description	USMW
1977-1979	V8-5.0L	305 CID		<b>22045</b>
1970-1972	V8-5.0L	307 CID		<b>22045</b>
1973	V8-5.0L	307 CID		<b>22054</b>
1970-1979	V8-5.7L	350 CID		<b>22045</b>
1976	V8-6.6L	400 CID		<b>22045</b>
<b>JIMMY 4WD</b>				
1978-1979	L6-4.1L	250 CID		<b>22043</b>
1970-1977	L6-4.1L	250 CID		<b>22049</b>
1973	L6-4.8L	292 CID		<b>22049</b>
1977-1979	V8-5.0L	305 CID		<b>22045</b>
1970-1972	V8-5.0L	307 CID		<b>22045</b>
1973	V8-5.0L	307 CID		<b>22054</b>
1970-1979	V8-5.7L	350 CID		<b>22045</b>
1975-1979	V8-6.6L	400 CID		<b>22045</b>
1973-1976	V8-7.4L	454 CID		<b>22045</b>
<b>K1000 1/2 TON</b>				
1963-1965	L6-3.8L	230 CID		<b>22049</b>
1966	L6-4.1L	250 CID		<b>22049</b>
1964-1966	L6-4.8L	292 CID		<b>22049</b>
1966	L6-5.0L	305 CID		<b>22049</b>
1961-1966	V6-5.0L	305 CID		<b>22049</b>
<b>K1500</b>				
1980-1982	L6-4.1L	250 CID	Exc.A/C; Base,Base,High Sierra,Sierra Classic, Sierra Grande	<b>22043</b>
1983-1984	L6-4.1L	250 CID	Exc.A/C; Base,Base,High Sierra,Sierra Classic	<b>22043</b>
1980	L6-4.8L	292 CID	Exc.A/C; Base,Base,High Sierra,Sierra Classic, Sierra Grande	<b>22043</b>
1985-1986	V6-4.3L	262 CID	Base,High Sierra,Sierra Classic	<b>22049</b>
1988-1992	V6-4.3L	262 CID	Sierra,Sierra SLE,Sierra SLX	<b>22145</b>
1993	V6-4.3L	262 CID	Sierra,Sierra SLE,Sierra SLX,Sierra Sport	<b>22145</b>
1994	V6-4.3L	262 CID	Sierra SL,Sierra SLE,Sierra SLT,Sierra Special	<b>22145</b>
1995	V6-4.3L	262 CID	Sierra SL,Sierra SLE,Sierra SLS,Sierra SLT, Sierra Special	<b>22145</b>
1996	V6-4.3L	262 CID	Exc.A/C; Sierra SL,Sierra SL,Sierra SLE,Sierra SLT, Sierra Special	<b>22162</b>
1997	V6-4.3L	262 CID	Exc.A/C; Sierra SL,Sierra SL,Sierra SLE,Sierra SLT, Sierra Special	<b>22162</b>
1998	V6-4.3L	262 CID	Exc.A/C; Sierra SL,Sierra SL,Sierra SLE,Sierra SLT, Sierra Special	<b>22162</b>
1981	V8-5.0L	305 CID	Base,High Sierra,Sierra Classic,Sierra Grande	<b>22045</b>
1984	V8-5.0L	305 CID	Base,High Sierra,Sierra Classic	<b>22045</b>
1982	V8-5.0L	305 CID	Base,High Sierra,Sierra Classic,Sierra Grande	<b>22049</b>
1983-1986	V8-5.0L	305 CID	Base,High Sierra,Sierra Classic	<b>22049</b>
1988-1992	V8-5.0L	305 CID	Sierra,Sierra SLE,Sierra SLX	<b>22145</b>
1993	V8-5.0L	305 CID	Sierra,Sierra SLE,Sierra SLX,Sierra Sport	<b>22145</b>
1994	V8-5.0L	305 CID	Sierra SL,Sierra SLE,Sierra SLT,Sierra Special	<b>22145</b>
1995	V8-5.0L	305 CID	Sierra SL,Sierra SLE,Sierra SLS,Sierra SLT, Sierra Special	<b>22145</b>
1996	V8-5.0L	305 CID	Exc.A/C; Sierra SL,Sierra SL,Sierra SLE,Sierra SLT, Sierra Special	<b>22162</b>
1997	V8-5.0L	305 CID	Exc.A/C; Sierra SL,Sierra SL,Sierra SLE,Sierra SLT, Sierra Special	<b>22162</b>
1998	V8-5.0L	305 CID	Exc.A/C; Sierra SL,Sierra SL,Sierra SLE,Sierra SLT, Sierra Special	<b>22162</b>
1999	V8-5.0L	305 CID	Exc.A/C; Sierra SL,Sierra SL,Sierra SLE,Sierra SLT	<b>22162</b>
1980-1981	V8-5.7L	350 CID	Base,High Sierra,Sierra Classic,Sierra Grande	<b>22045</b>
1982	V8-5.7L	350 CID	Exc.A/C; Base,Base,High Sierra,Sierra Classic, Sierra Grande	<b>22045</b>
1983	V8-5.7L	350 CID	Exc.A/C; Base,Base,High Sierra,Sierra Classic	<b>22045</b>
1984	V8-5.7L	350 CID	A/C; Base,Base,High Sierra,Sierra Classic	<b>22045</b>
1985-1986	V8-5.7L	350 CID	Base,High Sierra,Sierra Classic	<b>22049</b>
1988-1992	V8-5.7L	350 CID	Sierra,Sierra SLE,Sierra SLX	<b>22145</b>
1993	V8-5.7L	350 CID	Sierra,Sierra SLE,Sierra SLX,Sierra Sport	<b>22145</b>
1994	V8-5.7L	350 CID	Sierra SL,Sierra SLE,Sierra SLT,Sierra Special	<b>22145</b>
1995	V8-5.7L	350 CID	Sierra SL,Sierra SLE,Sierra SLS,Sierra SLT,Sierra Special	<b>22145</b>
1996	V8-5.7L	350 CID	Exc.A/C; Sierra SL,Sierra SL,Sierra SLE,Sierra SLT, Sierra Special	<b>22162</b>
1997	V8-5.7L	350 CID	Exc.A/C; Sierra SL,Sierra SL,Sierra SLE,Sierra SLT, Sierra Special	<b>22162</b>

Years	Engine	Disp.	Application Description	USMW
1998	V8-5.7L	350 CID	Exc.A/C; Sierra SL,Sierra SL,Sierra SLE,Sierra SLT, Sierra Special	<b>22162</b>
1999	V8-5.7L	350 CID	Exc.A/C; Sierra SL,Sierra SL,Sierra SLE,Sierra SLT	<b>22162</b>
1983-1986	V8-6.2L	379 CID	Diesel; Base,High Sierra,Sierra Classic	<b>22052</b>
1988-1992	V8-6.2L	379 CID	Diesel; Sierra,Sierra SLE,Sierra SLX	<b>22154</b>
1993	V8-6.2L	379 CID	Diesel; Sierra,Sierra SLE,Sierra SLX,Sierra Sport	<b>22154</b>
1982	V8-6.2L	379 CID	Diesel; Towing Package; Base,Base,High Sierra, Sierra Classic,Sierra Grande	<b>22602</b>
1994	V8-6.5L	395 CID	Diesel; Sierra SL,Sierra SLE,Sierra SLT,Sierra Special	<b>22605</b>
1995	V8-6.5L	395 CID	Diesel; Sierra SL,Sierra SLE,Sierra SLS,Sierra SLT, Sierra Special	<b>22605</b>
1996	V8-6.5L	395 CID	Diesel; Sierra SL,Sierra SLE,Sierra SLT,Sierra Special	<b>22605</b>
1997	V8-6.5L	395 CID	Diesel; Sierra SL,Sierra SLE,Sierra SLT	<b>22613</b>
1998	V8-6.5L	395 CID	Diesel; Sierra SL,Sierra SLE,Sierra SLT,Sierra Special	<b>22613</b>
1980	V8-6.6L	400 CID	Base,High Sierra,Sierra Classic,Sierra Grande	<b>22045</b>
1980	V8-7.4L	454 CID	Base,High Sierra,Sierra Classic,Sierra Grande	<b>22045</b>
<b>K1500 1/2 TON</b>				
1968-1969	L6-3.8L	230 CID		<b>22049</b>
1978-1979	L6-4.1L	250 CID		<b>22043</b>
1967-1977	L6-4.1L	250 CID		<b>22049</b>
1979	L6-4.8L	292 CID		<b>22043</b>
1967-1976	L6-4.8L	292 CID		<b>22049</b>
1968-1969	V6-5.0L	305 CID		<b>22045</b>
1967	V6-5.0L	305 CID		<b>22049</b>
1976-1979	V8-5.0L	305 CID		<b>22045</b>
1977-1978	V8-5.0L	305 CID		<b>22049</b>
1969-1973	V8-5.0L	307 CID		<b>22045</b>
1968	V8-5.3L	327 CID		<b>22049</b>
1969-1979	V8-5.7L	350 CID		<b>22045</b>
1975-1978	V8-5.7L	350 CID		<b>22049</b>
1968-1969	V8-6.5L	396 CID		<b>22045</b>
1979	V8-6.6L	400 CID		<b>22045</b>
1975-1978	V8-6.6L	400 CID		<b>22051</b>
1970-1972	V8-6.6L	402 CID		<b>22045</b>
1974-1979	V8-7.4L	454 CID		<b>22045</b>
1976	V8-7.4L	454 CID		<b>22051</b>
<b>K1500 3/4 TON</b>				
1964-1965	L6-3.8L	230 CID		<b>22049</b>
1966	L6-4.1L	250 CID		<b>22049</b>
1966	L6-4.8L	292 CID		<b>22049</b>
1961-1966	V6-5.0L	305 CID		<b>22049</b>
<b>K1500 SUBURBAN</b>				
1980	L6-4.1L	250 CID	Exc.A/C; Base,Base,High Sierra,Sierra Classic,Sierra Grande	<b>22043</b>
1983-1984	V8-5.0L	305 CID	Base,High Sierra,Sierra Classic	<b>22045</b>
1982	V8-5.0L	305 CID	Base,High Sierra,Sierra Classic,Sierra Grande	<b>22049</b>
1985	V8-5.0L	305 CID	Base,High Sierra,Sierra Classic	<b>22049</b>
1980-1981	V8-5.7L	350 CID	Base,High Sierra,Sierra Classic,Sierra Grande	<b>22045</b>
1982	V8-5.7L	350 CID	Exc.A/C; Base,Base,High Sierra,Sierra Classic, Sierra Grande	<b>22045</b>
1983	V8-5.7L	350 CID	Exc.A/C; Base,Base,High Sierra,Sierra Classic	<b>22045</b>
1984	V8-5.7L	350 CID	A/C; Base,Base,High Sierra,Sierra Classic	<b>22045</b>
1985-1986	V8-5.7L	350 CID	Base,High Sierra,Sierra Classic	<b>22049</b>
1992-1994	V8-5.7L	350 CID	Base,SLE	<b>22145</b>
1995	V8-5.7L	350 CID	Base,SLE,SLT	<b>22145</b>
1996	V8-5.7L	350 CID	Exc.A/C; Base,Base,SLE,SLT	<b>22162</b>
1997	V8-5.7L	350 CID	Exc.A/C; Base,Base,SLE,SLT	<b>22162</b>
1998-1999	V8-5.7L	350 CID	Exc.A/C; Base,Base,SLE,SLT	<b>22162</b>
1983-1986	V8-6.2L	379 CID	Diesel; Base,High Sierra,Sierra Classic	<b>22052</b>
1982	V8-6.2L	379 CID	Diesel; Towing Package; Base,Base,High Sierra, Sierra Classic,Sierra Grande	<b>22602</b>
1995-1996	V8-6.5L	395 CID	Diesel; Base,SLE,SLT	<b>22605</b>
1997-1998	V8-6.5L	395 CID	Diesel; Base,SLE,SLT	<b>22613</b>
1999	V8-6.5L	395 CID	Diesel; Base,Base,SLE,SLT	<b>22614</b>
<b>K2500</b>				
1980	L6-4.1L	250 CID	Exc.A/C; Base,Base,High Sierra,Sierra Classic, Sierra Grande	<b>22043</b>
1980-1981	L6-4.8L	292 CID	Exc.A/C; Base,Base,High Sierra,Sierra Classic, Sierra Grande	<b>22043</b>



Years	Engine	Disp.	Application Description	USMW
1982	L6-4.8L	292 CID	Base,High Sierra,Sierra Classic,Sierra Grande	22043
1983	L6-4.8L	292 CID	Base,High Sierra,Sierra Classic	22043
1984	L6-4.8L	292 CID	A/C; Base,Base,High Sierra,Sierra Classic	22045
1985-1986	L6-4.8L	292 CID	Base,High Sierra,Sierra Classic	22045
1985	V6-4.3L	262 CID	Base,High Sierra,Sierra Classic	22049
1988-1993	V6-4.3L	262 CID	Sierra,Sierra SLE,Sierra SLX	22145
1994-1995	V6-4.3L	262 CID	Sierra SL,Sierra SLE	22145
1988-1993	V8-5.0L	305 CID	Sierra,Sierra SLE,Sierra SLX	22145
1994-1995	V8-5.0L	305 CID	Sierra SL,Sierra SLE,Sierra SLT	22145
1998	V8-5.0L	305 CID	Exc.A/C; Sierra SL,Sierra SL,Sierra SLE,Sierra SLT	22162
1980-1981	V8-5.7L	350 CID	Base,High Sierra,Sierra Classic,Sierra Grande	22045
1982	V8-5.7L	350 CID	Exc.A/C; Base,Base,High Sierra,Sierra Classic, Sierra Grande	22045
1983-1984	V8-5.7L	350 CID	Base,Base,High Sierra,Sierra Classic	22049
1985-1986	V8-5.7L	350 CID	Base,High Sierra,Sierra Classic	22049
1988-1993	V8-5.7L	350 CID	Sierra,Sierra SLE,Sierra SLX	22145
1994-1995	V8-5.7L	350 CID	Sierra SL,Sierra SLE,Sierra SLT	22145
1996	V8-5.7L	350 CID	Exc.A/C; Sierra SL,Sierra SL,Sierra SLE,Sierra SLT	22162
1997	V8-5.7L	350 CID	Exc.A/C; Sierra SL,Sierra SL,Sierra SLE,Sierra SLT	22162
1998-2000	V8-5.7L	350 CID	Exc.A/C; Sierra SL,Sierra SL,Sierra SLE,Sierra SLT	22162
1983-1986	V8-6.2L	379 CID	Diesel; Base,High Sierra,Sierra Classic	22052
1988-1993	V8-6.2L	379 CID	Diesel; Sierra,Sierra SLE,Sierra SLX	22154
1982	V8-6.2L	379 CID	Diesel; Base,Base,High Sierra,Sierra Classic, Sierra Grande	22602
1994-1996	V8-6.5L	395 CID	Diesel; Sierra SL,Sierra SLE,Sierra SLT	22605
1992-1993	V8-6.5L	395 CID	Diesel; Sierra,Sierra SLE,Sierra SLX	22606
1997-1998	V8-6.5L	395 CID	Diesel; Sierra SL,Sierra SLE,Sierra SLT	22613
1999	V8-6.5L	395 CID	Diesel; Sierra SL,Sierra SL,Sierra SLE,Sierra SLT	22614
2000	V8-6.5L	395 CID	Diesel; Sierra SL,Sierra SLE,Sierra SLT	22614
1980	V8-6.6L	400 CID	Base,High Sierra,Sierra Classic,Sierra Grande	22045
1991-1993	V8-7.4L	454 CID	Sierra,Sierra SLE,Sierra SLX	22145
1994-2000	V8-7.4L	454 CID	Sierra SL,Sierra SLE,Sierra SLT	22145
<b>K2500 3/4 TON</b>				
1978	L6-4.1L	250 CID		22043
1967-1976	L6-4.1L	250 CID		22049
1978-1979	L6-4.8L	292 CID		22043
1967-1977	L6-4.8L	292 CID		22049
1968-1969	V6-5.0L	305 CID		22045
1967	V6-5.0L	305 CID		22049
1967	V8-4.6L	283 CID		22049
1977-1978	V8-5.0L	305 CID		22049
1969-1973	V8-5.0L	307 CID		22045
1968	V8-5.0L	307 CID		22049
1968	V8-5.3L	327 CID		22049
1969-1979	V8-5.7L	350 CID		22045
1975-1978	V8-5.7L	350 CID		22049
1968-1969	V8-6.5L	396 CID		22045
1979	V8-6.6L	400 CID		22045
1975-1978	V8-6.6L	400 CID		22051
1971	V8-6.6L	402 CID		22045
1973-1974	V8-7.4L	454 CID		22045
1976-1978	V8-7.4L	454 CID		22051
<b>K2500 3/4 TON SUBURBAN</b>				
1968-1974	L6-4.1L	250 CID		22049
1978-1979	L6-4.8L	292 CID		22043
1967-1977	L6-4.8L	292 CID		22049
1968-1969	V6-5.0L	305 CID		22045
1967	V6-5.0L	305 CID		22049
1967	V8-4.6L	283 CID		22049
1977-1978	V8-5.0L	305 CID		22049
1969-1973	V8-5.0L	307 CID		22045
1968	V8-5.3L	327 CID		22049
1969-1979	V8-5.7L	350 CID		22045
1975-1978	V8-5.7L	350 CID		22049
1968	V8-6.5L	396 CID		22045
1979	V8-6.6L	400 CID		22045
1975-1978	V8-6.6L	400 CID		22051
1971	V8-6.6L	402 CID		22045
1974	V8-7.4L	454 CID		22045

Years	Engine	Disp.	Application Description	USMW
1976-1977	V8-7.4L	454 CID		22051
<b>K2500 SUBURBAN</b>				
1980-1981	L6-4.8L	292 CID	Exc.A/C; Base,Base,High Sierra,Sierra Classic, Sierra Grande	22043
1982	L6-4.8L	292 CID	Base,High Sierra,Sierra Classic,Sierra Grande	22043
1984	L6-4.8L	292 CID	A/C; Base,Base,High Sierra,Sierra Classic	22045
1980-1982	V8-5.7L	350 CID	Base,High Sierra,Sierra Classic,Sierra Grande	22045
1983-1986	V8-5.7L	350 CID	Base,High Sierra,Sierra Classic	22049
1992-1994	V8-5.7L	350 CID	Base,SLE	22145
1995	V8-5.7L	350 CID	Base,SLE,SLT	22145
1996	V8-5.7L	350 CID	Exc.A/C; Base,Base,SLE,SLT	22162
1997	V8-5.7L	350 CID	Exc.A/C; Base,Base,SLE,SLT	22162
1998-1999	V8-5.7L	350 CID	Exc.A/C; Base,Base,SLE,SLT	22162
1983-1986	V8-6.2L	379 CID	Diesel; Base,High Sierra,Sierra Classic	22052
1982	V8-6.2L	379 CID	Diesel; Base,High Sierra,Sierra Classic,Sierra Grande	22602
1994	V8-6.5L	395 CID	Diesel; Base,SLE	22605
1995-1996	V8-6.5L	395 CID	Diesel; Base,SLE,SLT	22605
1997-1998	V8-6.5L	395 CID	Diesel; Base,SLE,SLT	22613
1999	V8-6.5L	395 CID	Diesel; Base,Base,SLE,SLT	22614
1980	V8-6.6L	400 CID	Base,High Sierra,Sierra Classic,Sierra Grande	22045
1992-1994	V8-7.4L	454 CID	Base,SLE	22145
1995-1999	V8-7.4L	454 CID	Base,SLE,SLT	22145
<b>K3500</b>				
1980-1981	L6-4.8L	292 CID	Exc.A/C; Base,Base,High Sierra,Sierra Classic, Sierra Grande	22043
1982	L6-4.8L	292 CID	Base,High Sierra,Sierra Classic,Sierra Grande	22043
1983	L6-4.8L	292 CID	Base,High Sierra,Sierra Classic	22043
1984	L6-4.8L	292 CID	A/C; Base,Base,High Sierra,Sierra Classic	22045
1985-1986	L6-4.8L	292 CID	Base,High Sierra,Sierra Classic	22045
1980-1982	V8-5.7L	350 CID	Base,High Sierra,Sierra Classic,Sierra Grande	22045
1983-1986	V8-5.7L	350 CID	Base,High Sierra,Sierra Classic	22049
1988-1993	V8-5.7L	350 CID	Sierra,Sierra SLE,Sierra SLX	22145
1994-1995	V8-5.7L	350 CID	Sierra SL,Sierra SLE,Sierra SLT	22145
1996	V8-5.7L	350 CID	Exc.A/C; Sierra SL,Sierra SL,Sierra SLE,Sierra SLT	22162
1997	V8-5.7L	350 CID	Exc.A/C; Sierra SL,Sierra SL,Sierra SLE,Sierra SLT	22162
1998-2000	V8-5.7L	350 CID	Exc.A/C; Sierra SL,Sierra SL,Sierra SLE,Sierra SLT	22162
1983-1986	V8-6.2L	379 CID	Diesel; Base,High Sierra,Sierra Classic	22052
1988-1993	V8-6.2L	379 CID	Diesel; Sierra,Sierra SLE,Sierra SLX	22154
1982	V8-6.2L	379 CID	Diesel; Base,High Sierra,Sierra Classic,Sierra Grande	22602
1994-1996	V8-6.5L	395 CID	Diesel; Sierra SL,Sierra SLE,Sierra SLT	22605
1992-1993	V8-6.5L	395 CID	Diesel; Sierra,Sierra SLE,Sierra SLX	22606
1997-1998	V8-6.5L	395 CID	Diesel; Sierra SL,Sierra SLE,Sierra SLT	22613
2000	V8-6.5L	395 CID	Diesel; Sierra SL,Sierra SLE,Sierra SLT	22614
1980	V8-6.6L	400 CID	Base,High Sierra,Sierra Classic,Sierra Grande	22045
1980-1982	V8-7.4L	454 CID	Base,High Sierra,Sierra Classic,Sierra Grande	22045
1983-1986	V8-7.4L	454 CID	Base,High Sierra,Sierra Classic	22045
1988-1993	V8-7.4L	454 CID	Sierra,Sierra SLE,Sierra SLX	22145
1994-2000	V8-7.4L	454 CID	Sierra SL,Sierra SLE,Sierra SLT	22145
<b>K3500 1 TON</b>				
1970-1974	L6-4.1L	250 CID		22049
1978-1979	L6-4.8L	292 CID		22043
1974-1977	L6-4.8L	292 CID		22049
1970	V8-5.0L	307 CID		22045
1970-1979	V8-5.7L	350 CID		22045
1977-1979	V8-6.6L	400 CID		22045
1974-1979	V8-7.4L	454 CID		22045
<b>P1500 VAN</b>				
1967-1969	L6-3.8L	230 CID		22049
1968-1974	L6-4.1L	250 CID		22049
1967	L6-4.8L	292 CID		22043
1975-1979	L6-4.8L	292 CID		22045
1967	V8-4.6L	283 CID		22049
1979	V8-7.4L	454 CID		22045
<b>P2500 VAN</b>				
1967-1974	L6-4.1L	250 CID		22049
1967-1969	L6-4.8L	292 CID		22043
1970-1979	L6-4.8L	292 CID		22045
1968-1972	V8-5.0L	307 CID		22049

Years	Engine	Disp.	Application Description	USMW
1970-1979	V8-5.7L	350 CID		<b>22045</b>
1971	V8-7.4L	454 CID		<b>22045</b>
<b>P3500</b>				
1985-1989	L6-4.8L	292 CID	Base, Value Van	<b>22049</b>
1990	V6-4.3L	262 CID	Base, Value Van	<b>22051</b>
1991-1995	V6-4.3L	262 CID	Base	<b>22051</b>
1996-1999	V6-4.3L	262 CID	Base	<b>22158</b>
1994-1995	V8-5.7L	350 CID	Base	<b>22045</b>
1985-1990	V8-5.7L	350 CID	Base, Value Van	<b>22049</b>
1991-1993	V8-5.7L	350 CID	Base	<b>22049</b>
1996	V8-5.7L	350 CID	CCW; Base, Base	<b>22173</b>
1997-1999	V8-5.7L	350 CID	Base	<b>22173</b>
1985-1990	V8-6.2L	379 CID	Diesel; Base, Value Van	<b>22052</b>
1991-1993	V8-6.2L	379 CID	Diesel; Base	<b>22052</b>
1994-1996	V8-6.5L	395 CID	Diesel; Base	<b>22154</b>
1997-1999	V8-6.5L	395 CID	Diesel; Base	<b>22613</b>
1986-1990	V8-7.4L	454 CID	Base, Value Van	<b>22045</b>
1991-1995	V8-7.4L	454 CID	Base	<b>22045</b>
1985	V8-7.4L	454 CID	Base, Value Van	<b>22049</b>
1996-1997	V8-7.4L	454 CID	CCW; Base, Base	<b>22145</b>
1998-1999	V8-7.4L	454 CID	Base	<b>22145</b>
<b>P3500 VAN</b>				
1967-1974	L6-4.1L	250 CID		<b>22049</b>
1967-1969	L6-4.8L	292 CID		<b>22043</b>
1970-1979	L6-4.8L	292 CID		<b>22045</b>
1968-1972	V8-5.0L	307 CID		<b>22049</b>
1970-1979	V8-5.7L	350 CID		<b>22045</b>
1971-1979	V8-7.4L	454 CID		<b>22045</b>
1975-1978	V8-7.4L	454 CID		<b>22051</b>
<b>PB1000 VAN</b>				
1963-1966	L6-3.8L	230 CID		<b>22049</b>
<b>PB1500 VAN</b>				
1963-1965	L6-3.8L	230 CID		<b>22049</b>
1966	L6-4.1L	250 CID		<b>22049</b>
1966	L6-4.8L	292 CID		<b>22043</b>
<b>PB2500 VAN</b>				
1963-1965	L6-3.8L	230 CID		<b>22049</b>
1966	L6-4.1L	250 CID		<b>22049</b>
1966	L6-4.8L	292 CID		<b>22043</b>
<b>R1500</b>				
1987	V6-4.3L	262 CID	Base, High Sierra, Sierra Classic	<b>22049</b>
1987	V8-5.0L	305 CID	Base, High Sierra, Sierra Classic	<b>22049</b>
1987	V8-5.7L	350 CID	Base, High Sierra, Sierra Classic	<b>22049</b>
1987	V8-6.2L	379 CID	Diesel; Base, High Sierra, Sierra Classic	<b>22052</b>
<b>R1500 SUBURBAN</b>				
1987	V8-5.0L	305 CID	Base, High Sierra, Sierra Classic	<b>22049</b>
1987	V8-5.7L	350 CID	Base, High Sierra, Sierra Classic	<b>22049</b>
1988	V8-5.7L	350 CID	Base, Sierra Classic	<b>22049</b>
1989	V8-5.7L	350 CID	Base, Sierra Classic	<b>22145</b>
1990	V8-5.7L	350 CID	Base, SLE	<b>22145</b>
1991	V8-5.7L	350 CID	Base	<b>22145</b>
1987	V8-6.2L	379 CID	Diesel; Base, High Sierra, Sierra Classic	<b>22052</b>
1988-1989	V8-6.2L	379 CID	Diesel; Base, Sierra Classic	<b>22052</b>
1990	V8-6.2L	379 CID	Diesel; Base, SLE	<b>22052</b>
1991	V8-6.2L	379 CID	Diesel; Base	<b>22052</b>
<b>R2500</b>				
1987-1988	L6-4.8L	292 CID	Base, High Sierra, Sierra Classic	<b>22045</b>
1987	V6-4.3L	262 CID	Base, High Sierra, Sierra Classic	<b>22049</b>
1987	V8-5.0L	305 CID	Base, High Sierra, Sierra Classic	<b>22049</b>
1987-1988	V8-5.7L	350 CID	Base, High Sierra, Sierra Classic	<b>22049</b>
1989	V8-5.7L	350 CID	CCW; Base, Base, High Sierra, Sierra Classic	<b>22145</b>
1987-1989	V8-6.2L	379 CID	Diesel; Base, High Sierra, Sierra Classic	<b>22052</b>
1987	V8-7.4L	454 CID	Base, High Sierra, Sierra Classic	<b>22045</b>
1988-1989	V8-7.4L	454 CID	CCW; Base, Base, High Sierra, Sierra Classic	<b>22145</b>
<b>R2500 SUBURBAN</b>				
1987	V8-5.7L	350 CID	Base, High Sierra, Sierra Classic	<b>22049</b>
1988	V8-5.7L	350 CID	Base, Sierra Classic	<b>22049</b>
1989	V8-5.7L	350 CID	CCW; Base, Base, Sierra Classic	<b>22145</b>

Years	Engine	Disp.	Application Description	USMW
1990	V8-5.7L	350 CID	CCW; Base, Base, SLE	<b>22145</b>
1991	V8-5.7L	350 CID	Base	<b>22145</b>
1987	V8-6.2L	379 CID	Diesel; Base, High Sierra, Sierra Classic	<b>22052</b>
1988-1989	V8-6.2L	379 CID	Diesel; Base, Sierra Classic	<b>22052</b>
1990	V8-6.2L	379 CID	Diesel; Base, SLE	<b>22052</b>
1991	V8-6.2L	379 CID	Diesel; Base	<b>22052</b>
1987	V8-7.4L	454 CID	Base, High Sierra, Sierra Classic	<b>22045</b>
1988-1989	V8-7.4L	454 CID	CCW; Base, Base, Sierra Classic	<b>22145</b>
1990	V8-7.4L	454 CID	CCW; Base, Base, SLE	<b>22145</b>
1991	V8-7.4L	454 CID	CCW; Base, Base	<b>22145</b>
<b>R3500</b>				
1987-1988	L6-4.8L	292 CID	Base, High Sierra, Sierra Classic	<b>22045</b>
1987-1989	V8-5.7L	350 CID	Base, High Sierra, Sierra Classic	<b>22049</b>
1990-1991	V8-5.7L	350 CID	Base, SLE	<b>22049</b>
1987-1989	V8-6.2L	379 CID	Diesel; Base, High Sierra, Sierra Classic	<b>22052</b>
1990-1991	V8-6.2L	379 CID	Diesel; Base, SLE	<b>22052</b>
1987-1989	V8-7.4L	454 CID	Base, High Sierra, Sierra Classic	<b>22045</b>
1988	V8-7.4L	454 CID	CCW; Base, Base, High Sierra, Sierra Classic	<b>22145</b>
1990-1991	V8-7.4L	454 CID	CCW; Base, Base, SLE	<b>22145</b>
<b>S15</b>				
1985	L4-1.9L	119 CID	Base, High Sierra, Sierra Classic	<b>22013</b>
1982	L4-1.9L	119 CID	Base, High Sierra, Sierra Classic, Sierra Grande	<b>22048</b>
1983	L4-1.9L	119 CID	Base, High Sierra, Sierra Classic	<b>22048</b>
1984	L4-1.9L	119 CID	Base, High Sierra, Sierra Classic	<b>22048</b>
1983	L4-2.0L	122 CID	Base, High Sierra, Sierra Classic	<b>22048</b>
1984	L4-2.0L	122 CID	Base, Base, High Sierra, Sierra Classic	<b>22048</b>
1984-1985	L4-2.2L	134 CID	Diesel; Base, High Sierra, Sierra Classic	<b>22013</b>
1986	L4-2.5L	151 CID	Base, Gypsy, High Sierra, Sierra Classic	<b>22026</b>
1985	L4-2.5L	151 CID	Base, High Sierra, Sierra Classic	<b>22048</b>
1987	L4-2.5L	151 CID	Base, EL, Gypsy, High Sierra, Sierra Classic	<b>22147</b>
1988	L4-2.5L	151 CID	Base, Gypsy, High Sierra, Sierra Classic	<b>22147</b>
1989-1990	L4-2.5L	151 CID	Front mount fan; Base, Base, High Sierra, Sierra Classic	<b>22179</b>
1984	V6-2.8L	173 CID	Base, High Sierra, Sierra Classic	<b>22026</b>
1986	V6-2.8L	173 CID	A/C; Base, Base, Gypsy, High Sierra, Sierra Classic	<b>22045</b>
1982	V6-2.8L	173 CID	Base, High Sierra, Sierra Classic, Sierra Grande	<b>22048</b>
1983	V6-2.8L	173 CID	Base, High Sierra, Sierra Classic	<b>22048</b>
1985	V6-2.8L	173 CID	A/C; Base, Base, High Sierra, Sierra Classic	<b>22048</b>
1987	V6-2.8L	173 CID	Exc. A/C; Base, Base, EL, Gypsy, High Sierra, Sierra Classic	<b>22179</b>
1988	V6-2.8L	173 CID	Exc. A/C; Base, Base, Gypsy, High Sierra, Sierra Classic	<b>22179</b>
1989-1990	V6-2.8L	173 CID	Exc. A/C; Base, Base, High Sierra, Sierra Classic	<b>22179</b>
1988	V6-4.3L	262 CID	A/C; Base, Base, Gypsy, High Sierra, Sierra Classic	<b>22145</b>
1989-1990	V6-4.3L	262 CID	A/C; Base, Base, High Sierra, Sierra Classic	<b>22145</b>
<b>S15 JIMMY</b>				
1983-1984	L4-1.9L	119 CID	Base, Gypsy, Sierra Classic	<b>22048</b>
1983-1984	L4-2.0L	122 CID	Base, Gypsy, Sierra Classic	<b>22048</b>
1986	L4-2.5L	151 CID	Base, Gypsy, Sierra Classic	<b>22026</b>
1985	L4-2.5L	151 CID	Base, Gypsy, High Sierra, Sierra Classic	<b>22048</b>
1987	L4-2.5L	151 CID	Base, Gypsy, High Country, Sierra Classic	<b>22147</b>
1988	L4-2.5L	151 CID	Base, Gypsy, Sierra Classic, Timberline	<b>22147</b>
1984	V6-2.8L	173 CID	Base, Gypsy, Sierra Classic	<b>22026</b>
1986	V6-2.8L	173 CID	A/C; Base, Base, Gypsy, Sierra Classic	<b>22045</b>
1983	V6-2.8L	173 CID	Base, Gypsy, Sierra Classic	<b>22048</b>
1985	V6-2.8L	173 CID	A/C; Base, Base, Gypsy, High Sierra, Sierra Classic	<b>22048</b>
1987	V6-2.8L	173 CID	Exc. A/C; Base, Base, Gypsy, High Country, Sierra Classic	<b>22179</b>
1988-1989	V6-2.8L	173 CID	Exc. A/C; Base, Base, Gypsy, Sierra Classic, Timberline	<b>22179</b>
1991	V6-4.3L	262 CID	Base, SLE, SLS, SLT	<b>22143</b>
1988-1989	V6-4.3L	262 CID	A/C; Base, Base, Gypsy, Sierra Classic, Timberline	<b>22145</b>
1990	V6-4.3L	262 CID	A/C; Base, Base, Gypsy, Sierra Classic	<b>22145</b>
<b>SAFARI</b>				
1985-1986	L4-2.5L	151 CID	Base, SL, SLE, SLX	<b>22013</b>
1988-1990	L4-2.5L	151 CID	Base, SLE, SLT, SLX	<b>22147</b>
1987	L4-2.5L	151 CID	Base, SL, SLE, SLT, SLX	<b>22179</b>
1985-1986	V6-4.3L	262 CID	Base, SL, SLE, SLX	<b>22026</b>
1995	V6-4.3L	262 CID	Base, SL, SLE, SLT, SLX	<b>22145</b>
1987	V6-4.3L	262 CID	Base, SL, SLE, SLT, SLX	<b>22153</b>
1988-1990	V6-4.3L	262 CID	Base, SLE, SLT, SLX	<b>22153</b>
1991-1992	V6-4.3L	262 CID	Base, SLE, SLT	<b>22153</b>
1993	V6-4.3L	262 CID	Base, GT, SLE, SLT	<b>22153</b>
1994	V6-4.3L	262 CID	Base, SLE, SLT, SLX	<b>22153</b>

Years	Engine	Disp.	Application Description	USMW
1996-1997	V6-4.3L	262 CID	Base,SL,SLE,SLT,SLX	22158
1998	V6-4.3L	262 CID	SL,SLE,SLT,SLX	22158
1999-2002	V6-4.3L	262 CID	SL,SLE,SLT	22158
2003-2005	V6-4.3L	262 CID	Base,SLE,SLT	22158
<b>SAVANA 1500</b>				
2003-2005	V6-4.3L	262 CID	Exc.A/C; Base,Base,SLE	22158
2006	V6-4.3L	262 CID	Exc.A/C; Base,Base,LS,LT	22158
2007-2012	V6-4.3L	262 CID	Exc.A/C; Base,Base	22158
1996-2000	V6-4.3L	262 CID	Exc.A/C; Base,Base,SLE	22162
2001-2002	V6-4.3L	262 CID	Exc.A/C; Base,Base,SLT	22162
1996-2000	V8-5.0L	305 CID	Exc.A/C; Base,Base,SLE	22162
2001-2002	V8-5.0L	305 CID	Exc.A/C; Base,Base,SLT	22162
2003-2005	V8-5.3L	323 CID	Exc.A/C; Base,Base,SLE	22158
2006-2012	V8-5.3L	325 CID	Exc.A/C; Base,Base,LS,LT	22158
1996-2000	V8-5.7L	350 CID	Exc.A/C; Base,Base,SLE	22162
2001-2002	V8-5.7L	350 CID	Exc.A/C; Base,Base,SLT	22162
<b>SAVANA 2500</b>				
2003-2005	V6-4.3L	262 CID	Exc.A/C; Base,Base,SLE	22158
1996-1997	V6-4.3L	262 CID	Exc.A/C; Base,Base	22162
1998-2000	V6-4.3L	262 CID	Exc.A/C; Base,Base,SLE	22162
2001-2002	V6-4.3L	262 CID	Exc.A/C; Base,Base,SLT	22162
2003-2005	V8-4.8L	294 CID	Exc.A/C; Base,Base,SLE	22158
2006-2012	V8-4.8L	294 CID	Exc.A/C; Base,Base	22158
1996-2000	V8-5.0L	305 CID	Exc.A/C; Base,Base,SLE	22162
2001-2002	V8-5.0L	305 CID	Exc.A/C; Base,Base,SLT	22162
2003-2005	V8-5.3L	323 CID	Exc.A/C; Base,Base,SLE	22158
1996-2000	V8-5.7L	350 CID	Exc.A/C; Base,Base,SLE	22162
2001-2002	V8-5.7L	350 CID	Exc.A/C; Base,Base,SLT	22162
2003-2005	V8-6.0L	364 CID	Exc.A/C; Base,Base,SLE	22158
2006	V8-6.0L	364 CID	Exc.A/C; Base,Base	22158
2007-2012	V8-6.0L	364 CID	Exc.A/C; Base,Base,LS,LT	22158
1996	V8-6.5L	395 CID	Diesel; Base,SLE	22605
1997-1998	V8-6.5L	395 CID	Diesel; Base,SLE	22613
1999-2000	V8-6.5L	395 CID	Diesel; Base,SLE	22614
2001-2002	V8-6.5L	395 CID	Diesel; Base,SLT	22614
2010-2012	V8-6.6L	400 CID	Diesel; Base	22341
2006-2008	V8-6.6L	400 CID	Diesel; Base	22617
2009	V8-6.6L	400 CID	Diesel; Base,Base	22617
<b>SAVANA 3500</b>				
2004	V8-4.8L	294 CID	Exc.A/C; Base,Base	22158
2005	V8-4.8L	294 CID	Exc.A/C; Base,Base,SLE	22158
2006-2012	V8-4.8L	294 CID	Exc.A/C; Base,Base	22158
1996-2000	V8-5.7L	350 CID	Exc.A/C; Base,Base,SLE	22162
2001-2002	V8-5.7L	350 CID	Exc.A/C; Base,Base,SLT	22162
2003-2005	V8-6.0L	364 CID	Exc.A/C; Base,Base,SLE	22158
2006-2012	V8-6.0L	364 CID	Exc.A/C; Base,Base,LS,LT	22158
1996	V8-6.5L	395 CID	Diesel; Base,SLE	22605
1997-1998	V8-6.5L	395 CID	Diesel; Base,SLE	22613
1999-2000	V8-6.5L	395 CID	Diesel; Base,SLE	22614
2001-2002	V8-6.5L	395 CID	Diesel; Base,SLT	22614
2010-2012	V8-6.6L	400 CID	Diesel; Base	22341
2006-2008	V8-6.6L	400 CID	Diesel; Base	22617
2009	V8-6.6L	400 CID	Diesel; Base,Base	22617
1996-2000	V8-7.4L	454 CID	Base,SLE	22145
2001-2002	V8-8.1L	496 CID	Base,SLT	22158
<b>SAVANA 4500</b>				
2009-2012	V8-6.0L	364 CID	Exc.A/C; Base,Base	22158
2009-2012	V8-6.6L	400 CID	Diesel; Base	22341
<b>SIERRA 1500</b>				
1999-2001	V6-4.3L	262 CID	Exc.A/C; SL,SL,SLE,SLT	22158
2002	V6-4.3L	262 CID	Exc.A/C; Base,Base,HT,SL,SLE,SLT,WT	22158
2003	V6-4.3L	262 CID	Exc.A/C; Base,Base,SL,SLE,SLT,WT	22158
2004	V6-4.3L	262 CID	Exc.A/C; Base,Base,SLE,SLT,WT	22158
1999-2001	V8-4.8L	294 CID	Exc.A/C; SL,SL,SLE,SLT	22158
2002	V8-4.8L	294 CID	Exc.A/C; Base,Base,HT,SL,SLE,SLT,WT	22158
2003	V8-4.8L	294 CID	Exc.A/C; Base,Base,SL,SLE,SLT,WT	22158
2004	V8-4.8L	294 CID	Exc.A/C; Base,Base,SLE,SLT,WT	22158
2005	V8-4.8L	294 CID	Base,SLE,WT	22158
2006	V8-4.8L	294 CID	SL,SLE,WT	22158

Years	Engine	Disp.	Application Description	USMW
2007	V8-4.8L	294 CID	Classic SL,Classic SLE,Classic WT	22158
1999-2001	V8-5.3L	323 CID	Exc.A/C; SL,SL,SLE,SLT	22158
2002	V8-5.3L	323 CID	Exc.A/C; Base,Base,HT,SL,SLE,SLT,WT	22158
2003	V8-5.3L	323 CID	Exc.A/C; Base,Base,SL,SLE,SLT,WT	22158
2004	V8-5.3L	323 CID	Exc.A/C; Base,Base,SLE,SLT,WT	22158
2005	V8-5.3L	323 CID	Base,Hybrid,SLE,SLT,WT	22158
2006	V8-5.3L	325 CID	Hybrid,SL,SLE,SLT,WT	22158
2007	V8-5.3L	325 CID	Classic Hybrid,Classic SL,Classic SLE,Classic SLT,Classic WT	22158
2002-2005	V8-6.0L	364 CID	Exc.A/C; Denali,Denali	22158
2006	V8-6.0L	364 CID	Denali,SLE,SLT	22158
2007	V8-6.0L	364 CID	Classic Denali,Classic SLE,Classic SLT	22158
<b>SIERRA 1500 HD</b>				
2001-2003	V8-6.0L	364 CID	Exc.A/C; SLE,SLE,SLT	22158
2005-2006	V8-6.0L	364 CID	SLE,SLT	22158
2007	V8-6.0L	364 CID	Classic SLE,Classic SLT	22158
<b>SIERRA 2500</b>				
1999-2000	V8-5.3L	323 CID	Exc.A/C; SL,SL,SLE,SLT	22158
1999-2001	V8-6.0L	364 CID	Exc.A/C; SL,SL,SLE,SLT	22158
2002	V8-6.0L	364 CID	Exc.A/C; Base,Base,SL,SLE,SLT	22158
2003-2004	V8-6.0L	364 CID	Exc.A/C; Base,Base,SLE,SLT,WT	22158
<b>SIERRA 2500 HD</b>				
2011-2012	V8-6.0L	364 CID	Denali,SLE,SLT,WT	22123
2001	V8-6.0L	364 CID	Exc.A/C; SL,SL,SLE,SLT	22158
2002	V8-6.0L	364 CID	Exc.A/C; Base,Base,SL,SLE,SLT	22158
2003-2005	V8-6.0L	364 CID	Exc.A/C; Base,Base,SLE,SLT,WT	22158
2006	V8-6.0L	364 CID	Exc.A/C; SL,SL,SLE,SLT,WT	22158
2007	V8-6.0L	364 CID	Classic SL,Classic SLE,Classic SLT,Classic WT,SLE,SLT,WT	22158
2008-2010	V8-6.0L	364 CID	SLE,SLT,WT	22158
2011-2012	V8-6.6L	400 CID	Diesel; Denali,SLE,SLT,WT	22342
2001	V8-6.6L	400 CID	Diesel; SL,SLE,SLT	22617
2002	V8-6.6L	400 CID	Diesel; Base,SL,SLE,SLT	22617
2003-2005	V8-6.6L	400 CID	Diesel; Base,SLE,SLT,WT	22617
2006	V8-6.6L	400 CID	Diesel; SL,SLE,SLT,WT	22625
2007	V8-6.6L	400 CID	Diesel; Classic SL,Classic SLE,Classic SLT,Classic WT,SLE,SLT,WT	22625
2008-2010	V8-6.6L	400 CID	Diesel; SLE,SLT,WT	22625
2004	V8-6.6L	403 CID	Diesel; Base,SLE,SLT,WT	22617
2001	V8-8.1L	496 CID	SL,SLE,SLT	22158
2002	V8-8.1L	496 CID	Base,SL,SLE,SLT	22158
2003-2005	V8-8.1L	496 CID	Base,SLE,SLT,WT	22158
2006	V8-8.1L	496 CID	SL,SLE,SLT,WT	22158
2007	V8-8.1L	496 CID	Classic SL,Classic SLE,Classic SLT,Classic WT	22158
<b>SIERRA 3500</b>				
2001	V8-6.0L	364 CID	Exc.A/C; SL,SL,SLE,SLT	22158
2002	V8-6.0L	364 CID	Exc.A/C; Base,Base,SL,SLE,SLT	22158
2003	V8-6.0L	364 CID	Exc.A/C; Base,Base,SLE,SLT	22158
2004-2005	V8-6.0L	364 CID	Exc.A/C; Base,Base,SLE,SLT,WT	22158
2006	V8-6.0L	364 CID	Exc.A/C; SL,SL,SLE,SLT,WT	22158
2007	V8-6.0L	364 CID	Classic SL,Classic SLE,Classic SLT,Classic WT	22158
2001	V8-6.6L	400 CID	Diesel; SL,SLE,SLT	22617
2002	V8-6.6L	400 CID	Diesel; Base,SL,SLE,SLT	22617
2003	V8-6.6L	400 CID	Diesel; Base,SLE,SLT	22617
2004-2005	V8-6.6L	400 CID	Diesel; Base,SLE,SLT,WT	22617
2006	V8-6.6L	400 CID	Diesel; SL,SLE,SLT,WT	22625
2007	V8-6.6L	400 CID	Diesel; Classic SL,Classic SLE,Classic SLT,Classic WT	22625
2004	V8-6.6L	403 CID	Diesel; Base,SLE,SLT,WT	22617
2001	V8-8.1L	496 CID	SL,SLE,SLT	22158
2002	V8-8.1L	496 CID	Base,SL,SLE,SLT	22158
2003	V8-8.1L	496 CID	Base,SLE,SLT	22158
2004-2005	V8-8.1L	496 CID	Base,SLE,SLT,WT	22158
2006	V8-8.1L	496 CID	SL,SLE,SLT,WT	22158
2007	V8-8.1L	496 CID	Classic SL,Classic SLE,Classic SLT,Classic WT	22158
<b>SIERRA 3500 HD</b>				
2011-2012	V8-6.0L	364 CID	Denali,SLE,SLT,WT	22123
2007-2010	V8-6.0L	364 CID	SLE,SLT,WT	22158
2011-2012	V8-6.6L	400 CID	Diesel; Denali,SLE,SLT,WT	22342
2007-2010	V8-6.6L	400 CID	Diesel; SLE,SLT,WT	22625

**FAN CLUTCHES**



Years	Engine	Disp.	Application Description	USMW
<b>SIERRA C3</b>				
2001	V8-6.0L	364 CID	Exc.A/C; Base,Base	22158
<b>SONOMA</b>				
1997-2000	L4-2.2L	134 CID	Exc.A/C; SL,SL,SLE,SLS	22136
2001-2003	L4-2.2L	134 CID	Exc.A/C; SL,SL,SLS	22136
1994-1996	L4-2.2L	134 CID	Exc.A/C; SL,SL,SLE,SLS	22156
1992	L4-2.5L	151 CID	Base,SLE	22147
1993	L4-2.5L	151 CID	Base,SLE,SLS	22147
1991	L4-2.5L	151 CID	Exc.A/C; Base,Base,SLE	22179
1992	V6-2.8L	173 CID	Base,GT,SLE	22142
1993	V6-2.8L	173 CID	Base,SLE,SLS	22142
1991	V6-2.8L	173 CID	Exc.A/C; Base,Base,SLE	22179
1991	V6-4.3L	262 CID	Exc.A/C; Base,Base,SLE	22153
1992	V6-4.3L	262 CID	Exc.A/C; Base,Base,GT,SLE	22153
1993	V6-4.3L	262 CID	Exc.A/C; Base,Base,SLE,SLS	22153
1994-1995	V6-4.3L	262 CID	Exc.A/C; SL,SL,SLE,SLS	22153
2004	V6-4.3L	262 CID	SL,SLS	22158
1996-2000	V6-4.3L	262 CID	Exc.A/C; SL,SL,SLE,SLS	22162
2001-2003	V6-4.3L	262 CID	Exc.A/C; SL,SL,SLS	22162
<b>SPRINT</b>				
1971-1977	L6-4.1L	250 CID		22049
1971-1973	V8-5.0L	307 CID		22049
1971-1977	V8-5.7L	350 CID		22049
1974-1975	V8-6.6L	400 CID		22045
1976	V8-6.6L	400 CID		22049
1971-1972	V8-6.6L	402 CID		22045
1971-1975	V8-7.4L	454 CID		22045
<b>SYCLONE</b>				
1991	V6-4.3L	262 CID	Base	22145
<b>TYPHOON</b>				
1992-1993	V6-4.3L	262 CID	Base	22145
<b>V1500</b>				
1987	V6-4.3L	262 CID	Base,High Sierra,Sierra Classic	22049
1987	V8-5.0L	305 CID	Base,High Sierra,Sierra Classic	22049
1987	V8-5.7L	350 CID	Base,High Sierra,Sierra Classic	22049
1987	V8-6.2L	379 CID	Diesel; Base,High Sierra,Sierra Classic	22052
<b>V1500 SUBURBAN</b>				
1987	V8-5.7L	350 CID	Base,High Sierra,Sierra Classic	22049
1988	V8-5.7L	350 CID	Base,Sierra Classic	22049
1989	V8-5.7L	350 CID	Base,Sierra Classic	22145
1990	V8-5.7L	350 CID	Base,SLE	22145
1991	V8-5.7L	350 CID	Base	22145
1987	V8-6.2L	379 CID	Diesel; Base,High Sierra,Sierra Classic	22052
1988-1989	V8-6.2L	379 CID	Diesel; Base,Sierra Classic	22052
1990	V8-6.2L	379 CID	Diesel; Base,SLE	22052
1991	V8-6.2L	379 CID	Diesel; Base	22052
<b>V2500</b>				
1987	L6-4.8L	292 CID	Base,High Sierra,Sierra Classic	22045
1987	V8-5.7L	350 CID	Base,High Sierra,Sierra Classic	22049
1987	V8-6.2L	379 CID	Diesel; Base,High Sierra,Sierra Classic	22052
<b>V2500 SUBURBAN</b>				
1987	V8-5.7L	350 CID	Base,High Sierra,Sierra Classic	22049
1988	V8-5.7L	350 CID	Base,Sierra Classic	22049
1989	V8-5.7L	350 CID	CCW; Base,Base,Sierra Classic	22145
1990	V8-5.7L	350 CID	CCW; Base,Base,SLE	22145
1991	V8-5.7L	350 CID	Base	22145
1987	V8-6.2L	379 CID	Diesel; Base,High Sierra,Sierra Classic	22052
1988-1989	V8-6.2L	379 CID	Diesel; Base,Sierra Classic	22052
1990	V8-6.2L	379 CID	Diesel; Base,SLE	22052
1991	V8-6.2L	379 CID	Diesel; Base	22052
<b>V3500</b>				
1987-1988	L6-4.8L	292 CID	Base,High Sierra,Sierra Classic	22045
1987	V8-5.7L	350 CID	Base,Base,High Sierra,Sierra Classic	22049
1988-1989	V8-5.7L	350 CID	Base,High Sierra,Sierra Classic	22049
1990-1991	V8-5.7L	350 CID	Base,SLE	22049
1987-1989	V8-6.2L	379 CID	Diesel; Base,High Sierra,Sierra Classic	22052
1990-1991	V8-6.2L	379 CID	Diesel; Base,SLE	22052
1987-1989	V8-7.4L	454 CID	Base,High Sierra,Sierra Classic	22045

Years	Engine	Disp.	Application Description	USMW
1988	V8-7.4L	454 CID	CCW; Base,High Sierra,Sierra Classic	22145
1990-1991	V8-7.4L	454 CID	CCW; Base,Base,SLE	22145
<b>YUKON</b>				
2000-2004	V8-4.8L	294 CID	Exc.A/C; SLE,SLE,SLT	22158
2005	V8-4.8L	294 CID	SLE,SLT	22158
2006	V8-4.8L	294 CID	SL,SLE	22158
2000-2004	V8-5.3L	323 CID	Exc.A/C; SLE,SLE,SLT	22158
2005	V8-5.3L	323 CID	SLE,SLT	22158
2005	V8-5.3L	325 CID	SLE,SLT	22158
2006	V8-5.3L	325 CID	SL,SLE,SLT	22158
1992	V8-5.7L	350 CID	Base,SLE,Sport	22145
1993	V8-5.7L	350 CID	Base,GT,SLE	22145
1994	V8-5.7L	350 CID	Base,SLE,Sport	22145
1995	V8-5.7L	350 CID	Base,SLE,SLT	22145
1996	V8-5.7L	350 CID	Exc.A/C; SL,SL,SLE,SLT	22162
1997	V8-5.7L	350 CID	Exc.A/C; SL,SL,SLE,SLT	22162
1998	V8-5.7L	350 CID	Exc.A/C; SLE,SLE,SLT	22162
1999	V8-5.7L	350 CID	Exc.A/C; Denali,Denali,SLE,SLT	22162
2000	V8-5.7L	350 CID	Exc.A/C; Denali,Denali	22162
2001-2005	V8-6.0L	364 CID	Exc.A/C; Denali,Denali	22158
2006	V8-6.0L	364 CID	Denali	22158
1994	V8-6.5L	395 CID	Diesel; Base,SLE,Sport	22605
1995	V8-6.5L	395 CID	Diesel; Base,SLE,SLT	22605
1996	V8-6.5L	395 CID	Diesel; SL,SLE,SLT	22605
1997	V8-6.5L	395 CID	Diesel; SL,SLE,SLT	22613
<b>YUKON XL 1500</b>				
2000-2004	V8-5.3L	323 CID	Exc.A/C; SLE,SLE,SLT	22158
2005	V8-5.3L	323 CID	SLE,SLT	22158
2006	V8-5.3L	325 CID	SL,SLE,SLT	22158
2001-2005	V8-6.0L	364 CID	Exc.A/C; Denali,Denali	22158
2006	V8-6.0L	364 CID	Denali	22158
<b>YUKON XL 2500</b>				
2012	V8-6.0L	364 CID	SLE,SLT	22157
2000-2005	V8-6.0L	364 CID	Exc.A/C; SLE,SLE,SLT	22158
2006-2011	V8-6.0L	364 CID	SLE,SLT	22158
2001-2006	V8-8.1L	496 CID	SLE,SLT	22158
<b>HONDA</b>				
<b>PASSPORT</b>				
1994-1996	L4-2.6L	2559cc	DX	22072
1994-1995	V6-3.2L	3165cc	EX,LX	22021
1996	V6-3.2L	3165cc	To 12/95; EX,EX,LX	22021
1997	V6-3.2L	3165cc	EX,LX	22021
1998-2002	V6-3.2L	3165cc	EX,LX	22176
<b>HUMMER</b>				
<b>H1</b>				
2002-2004	V8-6.5L	395 CID	Diesel; Base	22618
<b>H2</b>				
2003-2007	V8-6.0L	364 CID	Base	22158
<b>H3</b>				
2006	L5-3.5L	211 CID	Base	22173
2007-2009	L5-3.7L	223 CID	Base,X	22173
2010	L5-3.7L	223 CID	Base	22173
2008	V8-5.3L	325 CID	Alpha	22615
2009	V8-5.3L	325 CID	Alpha,Championship Series	22615
2010	V8-5.3L	325 CID	Alpha	22615
<b>H3T</b>				
2009-2010	L5-3.7L	223 CID	Base	22173
2009-2010	V8-5.3L	325 CID	Alpha	22615
<b>INFINITI</b>				
<b>FX45</b>				
2006-2008	V8-4.5L	4494cc	Base	22032
2003-2005	V8-4.5L	4500cc	Base	22032
<b>G35</b>				
2003	V6-3.5L	3498cc	Base	22032
2004	V6-3.5L	3498cc	Base,X	22032



Years	Engine	Disp.	Application Description	USMW
<b>J30</b>				
1993-1997	V6-3.0L	2960cc	Base,T	22027
<b>M30</b>				
1990-1992	V6-3.0L	2960cc	Base	22082
<b>Q45</b>				
1997-1999	V8-4.1L	4130cc	Base,T	22032
2000	V8-4.1L	4130cc	Anniversary Edition,Base,T	22032
2001	V8-4.1L	4130cc	Base,T	22032
1994-1996	V8-4.5L	4494cc	A,Base,T	22025
1990	V8-4.5L	4494cc	Base	22082
1991-1992	V8-4.5L	4494cc	A,Base	22082
1993	V8-4.5L	4494cc	To 02/93; A,A,Base	22082
<b>QX4</b>				
1997-2000	V6-3.3L	3275cc	Base	22025
2001-2003	V6-3.5L	3498cc	Base	22032
<b>QX56</b>				
2004-2010	V8-5.6L	5552cc	Base	22181
<b>INTERNATIONAL</b>				
<b>METRO</b>				
1971	L6-3.8L	232 CID		22049
1968	L6-3.9L	241 CID		22049
1972-1974	L6-4.2L	258 CID		22049
1968	V8-4.3L	266 CID		22049
1971-1974	V8-5.0L	304 CID		22049
1975	V8-5.6L	345 CID		22049
<b>PICKUP</b>				
1969-1971	L6-3.8L	232 CID		22049
1968-1970	L6-3.9L	241 CID		22049
1972-1974	L6-4.2L	258 CID		22049
1968-1969	V8-4.3L	266 CID		22049
1964-1975	V8-5.0L	304 CID		22049
1971-1975	V8-5.6L	345 CID		22049
1975	V8-6.4L	392 CID		22049
<b>SCOUT</b>				
1971	L6-3.8L	232 CID		22049
1969-1970	L6-4.3L	265 CID		22049
1968	V8-4.3L	266 CID		22049
1969-1975	V8-5.0L	304 CID		22049
1971-1975	V8-5.6L	345 CID		22049
1975	V8-6.4L	392 CID		22049
<b>SCOUT II</b>				
1974-1979	V8-5.0L	304 CID		22049
1974-1979	V8-5.6L	345 CID		22049
<b>TERRA PICKUP</b>				
1976-1980	V8-5.0L	304 CID		22049
1976-1980	V8-5.6L	345 CID		22049
<b>TRAVELALL</b>				
1969-1971	L6-3.8L	232 CID		22049
1968-1970	L6-3.9L	241 CID		22049
1972-1974	L6-4.2L	258 CID		22049
1968-1970	V8-4.3L	266 CID		22049
1966-1975	V8-5.0L	304 CID		22049
1971-1975	V8-5.6L	345 CID		22049
1972-1975	V8-6.4L	392 CID		22049
<b>TRAVELER</b>				
1976-1980	V8-5.0L	304 CID		22049
1976-1980	V8-5.6L	345 CID		22049
<b>ISUZU</b>				
<b>AMIGO</b>				
1989-1993	L4-2.3L	2254cc	A/C; S,XS	22087
1989	L4-2.6L	2559cc	From 01/89; S,S,XS	22087
1990-1994	L4-2.6L	2559cc	S,XS	22087
1998-2000	V6-3.2L	3165cc	S	22176
<b>ASCENDER</b>				
2004	L6-4.2L	256 CID	Limited,LS,S	22310
2005	L6-4.2L	256 CID	LS,S	22310

Years	Engine	Disp.	Application Description	USMW
2006	L6-4.2L	256 CID	Base,LS	22310
2003	L6-4.2L	256 CID	Base,Limited,LS	22330
2007-2008	L6-4.2L	256 CID	S	22330
2004	V8-5.3L	323 CID	Limited,LS	22310
2005	V8-5.3L	323 CID	Limited,LS,S	22310
2003	V8-5.3L	323 CID	Base,Limited,LS	22330
2006	V8-5.3L	325 CID	LS	22310
<b>AXIOM</b>				
2002	V6-3.5L	3475cc	Base,XS	22176
2003	V6-3.5L	3491cc	Base,XS	22176
2004	V6-3.5L	3494cc	S,XS	22176
<b>HOMBRE</b>				
1996-2000	L4-2.2L	2180cc	A/C; S,S,XS	22162
2000	V6-4.3L	262 CID	Exc.A/C; S,S,XS	22162
1997-1999	V6-4.3L	4294cc	Exc.A/C; S,S,XS	22162
<b>I-280</b>				
2006	L4-2.8L	2770cc	Base	22023
<b>I-290</b>				
2007	L4-2.9L	2921cc	LS,S	22023
2008	L4-2.9L	2921cc	S	22023
<b>I-350</b>				
2006	L5-3.5L	3460cc	Base	22173
<b>I-370</b>				
2007-2008	L5-3.7L	3654cc	LS	22173
<b>IMPULSE</b>				
1983	L4-1.9L	1949cc	Base	22093
1984	L4-1.9L	1949cc	Base,SE	22093
1985-1987	L4-1.9L	1949cc	Base	22093
1985-1989	L4-2.0L	1994cc	Base	22093
1988-1989	L4-2.3L	2254cc	Base	22087
<b>PICKUP</b>				
1981-1982	L4-1.8L	1817cc	A/C; Base,DLX	22094
1983	L4-1.9L	1949cc	A/C; Base,DLX,LS	22094
1984-1985	L4-1.9L	1949cc	A/C; Base,DLX,LX	22094
1986-1987	L4-1.9L	1949cc	A/C; Base,DLX,LS	22094
1981-1982	L4-2.2L	2238cc	Diesel; Base,DLX	22094
1983	L4-2.2L	2238cc	Diesel; Base,DLX,LS	22094
1984-1985	L4-2.2L	2238cc	Diesel; Base,DLX,LX	22094
1986-1987	L4-2.2L	2238cc	Diesel; Base,DLX,LS	22094
1986-1987	L4-2.3L	2254cc	A/C; Base,DLX,LS	22087
1988	L4-2.3L	2254cc	A/C; LS	22087
1989	L4-2.3L	2254cc	A/C; LS,S,XS	22087
1990-1991	L4-2.3L	2254cc	A/C; LS,S	22087
1992-1995	L4-2.3L	2254cc	A/C; S	22087
1988	L4-2.6L	2559cc	Exc.A/C; 1 Ton,1 Ton,LS,S	22087
1989-1990	L4-2.6L	2559cc	1 Ton,LS,S,XS	22087
1991-1992	L4-2.6L	2559cc	1 Ton,LS,S	22087
1993-1995	L4-2.6L	2559cc	S	22087
1991	V6-3.1L	3137cc	LS,S	22175
1992-1994	V6-3.1L	3137cc	S	22175
<b>RODEO</b>				
1994-1997	L4-2.6L	2559cc	LS,S	22072
1991-1992	L4-2.6L	2559cc	LS,S,XS	22087
1993	L4-2.6L	2559cc	LS,S	22087
1991-1992	V6-3.1L	3137cc	LS,S,XS	22175
1994-1995	V6-3.2L	3165cc	LS,S	22021
1996	V6-3.2L	3165cc	To 12/95; LS,LS,S	22021
1997	V6-3.2L	3165cc	LS,S	22021
1993	V6-3.2L	3165cc	LS,S	22076
1998	V6-3.2L	3165cc	LS,S	22176
1999-2000	V6-3.2L	3165cc	LS,LSE,S	22176
2001-2003	V6-3.2L	3165cc	LS,LSE,S V6	22176
2004	V6-3.2L	3165cc	S	22176
2004	V6-3.5L	3494cc	S	22176
<b>RODEO SPORT</b>				
2001-2003	V6-3.2L	3165cc	S V6	22176
<b>TROOPER</b>				
1984-1985	L4-1.9L	1949cc	A/C; Base	22094

Years	Engine	Disp.	Application Description	USMW
1984	L4-2.2L	2238cc	Diesel; Base	22094
1986	L4-2.2L	2238cc	Diesel; DLX,LS,LX	22094
1987	L4-2.2L	2238cc	Diesel; DLX,LS	22094
1986	L4-2.3L	2254cc	A/C; DLX,LS,LX	22087
1987	L4-2.3L	2254cc	A/C; DLX,LS	22087
1988	L4-2.6L	2559cc	Exc.A/C; LS,LS,S,XS	22087
1989	L4-2.6L	2559cc	From 02/89; LS,LS,RS,S,XS	22087
1990	L4-2.6L	2559cc	LS,RS,S,XS	22087
1991	L4-2.6L	2559cc	LS,S,SE,XS	22087
1989-1990	V6-2.8L	2827cc	LS,RS,S,XS	22175
1991	V6-2.8L	2827cc	LS,S,SE,XS	22175
1995	V6-3.2L	3165cc	RS,S	22021
1996	V6-3.2L	3165cc	To 11/95; LS,LS,S,SE	22021
1997	V6-3.2L	3165cc	LS,Ltd,S	22021
1992	V6-3.2L	3165cc	LS,S	22076
1993	V6-3.2L	3165cc	LS,RS,S	22076
1994	V6-3.2L	3165cc	To 11/93; LS,LS,RS,S	22076
1998-1999	V6-3.5L	3475cc	S	22022
2000-2002	V6-3.5L	3475cc	Limited,LS,S	22022
<b>VEHICROSS</b>				
1999-2001	V6-3.5L	3475cc	Base	22176
<b>JAGUAR</b>				
<b>VANDEN PLAS</b>				
1988	L6-3.6L	3590cc	Base	22018
1989	L6-3.6L	3590cc	Base,Majestic	22018
1990	L6-4.0L	3980cc	Base,Majestic	22018
1991	L6-4.0L	3980cc	Base	22018
1992	L6-4.0L	3980cc	Base,Majestic	22018
1985-1987	L6-4.2L	4235cc	Base	22017
<b>XJ12</b>				
1994-1996	V12-6.0L	5994cc		Base
<b>22018</b>				
<b>XJ6</b>				
1988-1989	L6-3.6L	3590cc	Base	22018
1990-1992	L6-4.0L	3980cc	Base,Sovereign	22018
1972-1973	L6-4.2L	258 CID		22049
1985-1987	L6-4.2L	4235cc	Base	22017
<b>XJRS</b>				
1993	V12-6.0L	5994cc		Base
<b>22018</b>				
<b>XJS</b>				
1993	L6-4.0L	3980cc	Base	22018
1994-1995	L6-4.0L	3980cc	2+2,Base	22018
1996	L6-4.0L	3980cc	2+2	22018
1980-1986	V12-5.3L	5343cc	Base	22018
1987-1988	V12-5.3L	5343cc	Base,C	22018
1989	V12-5.3L	5343cc	Base,Collection Rouge	22018
1990	V12-5.3L	5343cc	Base,Classic Collection,Collection Rouge	22018
1991	V12-5.3L	5343cc	Classic Collection	22018
1992	V12-5.3L	5343cc	Base	22018
1994-1995	V12-6.0L	5994cc	2+2,Base	22018
<b>JEEP</b>				
<b>CHEROKEE</b>				
1985-1987	L4-2.1L	126 CID	Diesel; Base,Chief,Laredo,Pioneer	22148
1984	L4-2.5L	150 CID	CCW; Base,Base	22148
1985-1986	L4-2.5L	150 CID	CCW; Base,Base,Chief,Laredo,Pioneer	22148
1987-1988	L4-2.5L	150 CID	CCW; Base,Base,Chief,Laredo,Pioneer	22148
1989	L4-2.5L	150 CID	CCW; Base,Base,Laredo,Pioneer,Sport	22148
1990-1993	L4-2.5L	150 CID	CCW; Base,Base	22148
1994-1997	L4-2.5L	150 CID	SE	22149
1998-2000	L4-2.5L	150 CID	Exc.A/C; Classic,Classic,Limited,SE,Sport	22149
1987-1988	L6-4.0L	242 CID	Base,Chief,Laredo,Limited,Pioneer	22148
1989-1990	L6-4.0L	242 CID	Base,Laredo,Limited,Pioneer,Sport	22148
1991-1992	L6-4.0L	242 CID	Base,Briarwood,Laredo,Limited,Sport	22148
1993	L6-4.0L	242 CID	Base,Country,Sport	22148
1994-1995	L6-4.0L	242 CID	Country,SE,Sport	22148
1996	L6-4.0L	242 CID	Classic,Country,SE,Sport	22148

Years	Engine	Disp.	Application Description	USMW
1997	L6-4.0L	242 CID	Country,SE,Sport	22148
1998-2001	L6-4.0L	242 CID	Classic,Limited,SE,Sport	22148
1976-1979	L6-4.2L	258 CID		22049
1980	L6-4.2L	258 CID	Serpentine Belt Drive; Base,Base,Wide Track	22126
1981-1982	L6-4.2L	258 CID	Serpentine Belt Drive; Base,Base,Chief	22126
1983	L6-4.2L	258 CID	Serpentine Belt Drive; Base,Base,Chief,Pioneer	22126
1984	V6-2.8L	173 CID	Base	22048
1985-1986	V6-2.8L	173 CID	Base,Chief,Laredo,Pioneer	22048
1976-1979	V8-5.9L	360 CID		22049
1980	V8-5.9L	360 CID	Base,Wide Track	22049
1981-1982	V8-5.9L	360 CID	Base,Chief	22049
1983	V8-5.9L	360 CID	Base,Chief,Pioneer	22049
1976-1978	V8-6.6L	401 CID		22049
<b>CHEROKEE 2WD</b>				
1974	L6-4.2L	258 CID		22049
1974	V8-5.9L	360 CID		22049
1974	V8-6.6L	401 CID		22049
<b>CHEROKEE 4WD</b>				
1974-1975	L6-4.2L	258 CID		22049
1974-1975	V8-5.9L	360 CID		22049
1974-1975	V8-6.6L	401 CID		22049
<b>CJ5</b>				
1980	L4-2.5L	151 CID	Base,Golden Eagle,Laredo,Renegade	22048
1981	L4-2.5L	151 CID	Base,Laredo,Renegade	22048
1982-1983	L4-2.5L	151 CID	Base,Laredo,Limited,Renegade	22048
1972-1978	L6-3.8L	232 CID		22049
1972-1979	L6-4.2L	258 CID		22049
1980	L6-4.2L	258 CID	Serpentine Belt Drive; Base,Base,Golden Eagle, Laredo,Renegade	22126
1981	L6-4.2L	258 CID	Serpentine Belt Drive; Base,Base,Laredo,Renegade	22126
1982-1983	L6-4.2L	258 CID	Serpentine Belt Drive; Base,Base,Laredo,Limited, Renegade	22126
1972-1979	V8-5.0L	304 CID		22049
1980	V8-5.0L	304 CID	Base,Golden Eagle,Laredo,Renegade	22049
1981	V8-5.0L	304 CID	Base,Laredo,Renegade	22049
<b>CJ6</b>				
1972-1975	L6-3.8L	232 CID		22049
1972-1975	L6-4.2L	258 CID		22049
1972-1975	V8-5.0L	304 CID		22049
<b>CJ7</b>				
1983	L4-2.5L	150 CID	Base,Laredo,Limited,Renegade	22048
1984	L4-2.5L	150 CID	Base,Renegade	22048
1985-1986	L4-2.5L	150 CID	Base,Laredo,Renegade	22048
1980	L4-2.5L	151 CID	Base,Golden Hawk,Laredo,Renegade	22048
1981	L4-2.5L	151 CID	Base,Laredo,Renegade	22048
1982-1983	L4-2.5L	151 CID	Base,Laredo,Limited,Renegade	22048
1976-1978	L6-3.8L	232 CID		22049
1976-1979	L6-4.2L	258 CID		22049
1980	L6-4.2L	258 CID	Serpentine Belt Drive; Base,Base,Golden Hawk, Laredo,Renegade	22126
1981	L6-4.2L	258 CID	Serpentine Belt Drive; Base,Base,Laredo,Renegade	22126
1982-1983	L6-4.2L	258 CID	Serpentine Belt Drive; Base,Base,Laredo,Limited, Renegade	22126
1984	L6-4.2L	258 CID	Serpentine Belt Drive; Base,Base,Renegade	22126
1985-1986	L6-4.2L	258 CID	Serpentine Belt Drive; Base,Base,Laredo,Renegade	22126
1976-1979	V8-5.0L	304 CID		22049
1980	V8-5.0L	304 CID	Base,Golden Hawk,Laredo,Renegade	22049
1981	V8-5.0L	304 CID	Base,Laredo,Renegade	22049
<b>CJ7 (MEX)</b>				
1965-1975	L6-4.2L	258 CID		22026
<b>COMANCHE</b>				
1986	L4-2.1L	126 CID	Diesel; Custom,X,XLS	22148
1987	L4-2.1L	126 CID	Diesel; Base,Laredo,Pioneer	22148
1986	L4-2.5L	150 CID	CCW; Custom,Custom,X,XLS	22148
1987-1988	L4-2.5L	150 CID	CCW; Base,Base,Chief,Laredo,Pioneer	22148
1989-1991	L4-2.5L	150 CID	CCW; Base,Base,Pioneer	22148
1992	L4-2.5L	150 CID	CCW; Base,Base	22148
1987	L6-4.0L	242 CID	Base,Chief,Laredo,Pioneer	22148

Years	Engine	Disp.	Application Description	USMW
1988	L6-4.0L	242 CID	Base,Chief,Eliminator,Laredo,Pioneer	22148
1989-1992	L6-4.0L	242 CID	Base,Eliminator,Pioneer	22148
1986	V6-2.8L	173 CID	Custom,X,XLS	22048
<b>COMMANDER</b>				
2010	V6-3.7L	226 CID	Sport	22151
2009	V8-4.7L	285 CID	Limited,Sport	22151
2006	V8-4.7L	285 CID	65th Anniversary Edition,Base,Limited	22152
2007	V8-4.7L	285 CID	Base,Limited,Sport	22152
2008	V8-4.7L	285 CID	Limited,Sport	22152
<b>COMMANDO</b>				
1972-1973	V8-5.0L	304 CID		22049
<b>DJ5</b>				
1972-1974	L6-3.8L	232 CID		22049
1973-1974	L6-4.2L	258 CID		22049
1974	V8-5.0L	304 CID		22049
<b>GRAND CHEROKEE</b>				
1999-2001	L6-4.0L	242 CID	Laredo,Limited	22151
2002	L6-4.0L	242 CID	Laredo,Limited,Sport	22151
2003	L6-4.0L	242 CID	Laredo,Limited	22151
2004	L6-4.0L	242 CID	Laredo,Limited,Special Edition	22151
1993	L6-4.0L	242 CID	Max Cooling; Base,Base,Laredo,Limited	22174
1994	L6-4.0L	242 CID	Max Cooling; Laredo,Laredo,Limited,SE	22174
1995	L6-4.0L	242 CID	Max Cooling; Laredo,Laredo,Limited,Orvis,SE	22174
1996	L6-4.0L	242 CID	Max Cooling; Laredo,Laredo,Limited	22174
1997	L6-4.0L	242 CID	Max Cooling; Laredo,Laredo,Limited,Orvis,TSi	22174
1998	L6-4.0L	242 CID	Max Cooling; Laredo,Laredo,Limited,TSi	22174
2010	V6-3.7L	226 CID	Laredo,Limited	22151
2005	V8-4.7L	285 CID	Laredo,Limited	22152
2006	V8-4.7L	285 CID	65th Anniversary Edition,Laredo,Limited	22152
2007-2009	V8-4.7L	285 CID	Laredo,Limited	22152
1999-2000	V8-4.7L	287 CID	Laredo,Limited	22151
1994	V8-5.2L	318 CID	Max Cooling; Laredo,Laredo,Limited,SE	22159
1995	V8-5.2L	318 CID	Max Cooling; Laredo,Laredo,Limited,Orvis,SE	22159
1996	V8-5.2L	318 CID	Max Cooling; Laredo,Laredo,Limited	22159
1997	V8-5.2L	318 CID	Max Cooling; Laredo,Laredo,Limited,Orvis,TSi	22159
1998	V8-5.2L	318 CID	Max Cooling; Laredo,Laredo,Limited,TSi	22159
1993	V8-5.2L	318 CID	Max Cooling; Base,Base,Laredo,Limited	22170
<b>GRAND CHEROKEE (MEX)</b>				
1992	L6-4.0L	242 CID		22174
1992	V8-5.2L	318 CID		22151
<b>GRAND WAGONER</b>				
1984-1985	L6-4.2L	258 CID	Serpentine Belt Drive; Base,Base,Limited	22126
1986	L6-4.2L	258 CID	Serpentine Belt Drive; Base,Base	22126
1993	V8-5.2L	318 CID	Max Cooling; Base,Base	22170
1984-1985	V8-5.9L	360 CID	Base,Limited	22049
1986-1991	V8-5.9L	360 CID	Base	22049
<b>J10</b>				
1974-1979	L6-4.2L	258 CID		22049
1980-1987	L6-4.2L	258 CID	Serpentine Belt Drive; Base,Base	22126
1974-1979	V8-5.9L	360 CID		22049
1980-1988	V8-5.9L	360 CID	Base	22049
1974-1978	V8-6.6L	401 CID		22049
<b>J20</b>				
1974-1976	L6-4.2L	258 CID		22049
1974-1979	V8-5.9L	360 CID		22049
1980-1988	V8-5.9L	360 CID	Base	22049
1974-1978	V8-6.6L	401 CID		22049
<b>J-PICKUP</b>				
1972	V8-5.0L	304 CID		22049
1972-1973	V8-5.9L	360 CID		22045
<b>LIBERTY</b>				
2005-2006	L4-2.8L	171 CID	Diesel; Limited,Sport	22170
2002	V6-3.7L	226 CID	Heavy Duty Cooling; Limited,Sport	22151
2003-2004	V6-3.7L	226 CID	Limited,Regenade,Sport	22151
2005	V6-3.7L	226 CID	Limited,Regenade,Rocky Mountain Edition,Sport	22151
2006	V6-3.7L	226 CID	65th Anniversary Edition,Limited,Regenade,Sport	22151
2007-2009	V6-3.7L	226 CID	Limited,Sport	22151
2010	V6-3.7L	226 CID	Limited,Regenade,Sport	22151

Years	Engine	Disp.	Application Description	USMW
2011	V6-3.7L	226 CID	Limited,Regenade,Sport	22164
2012	V6-3.7L	226 CID	Jet,Limited,Sport	22164
<b>SCRAMBLER</b>				
1983	L4-2.5L	150 CID	Base,SL,SR	22048
1984	L4-2.5L	150 CID	Base,SR	22048
1985	L4-2.5L	150 CID	Base,Laredo,Regenade	22048
1981	L4-2.5L	151 CID	Base	22048
1982-1983	L4-2.5L	151 CID	Base,SL,SR	22048
1981	L6-4.2L	258 CID	Serpentine Belt Drive; Base,Base	22126
1982-1983	L6-4.2L	258 CID	Serpentine Belt Drive; Base,Base,SL,SR	22126
1984	L6-4.2L	258 CID	Serpentine Belt Drive; Base,Base,SR	22126
1985	L6-4.2L	258 CID	Serpentine Belt Drive; Base,Base,Laredo,Regenade	22126
<b>WAGONER</b>				
1985	L4-2.1L	126 CID	Diesel; Base,Limited	22148
1984-1986	L4-2.5L	150 CID	CCW; Base,Base,Limited	22148
1987	L4-2.5L	150 CID	CCW; Base,Base,Limited	22148
1987	L6-4.0L	242 CID	Base,Limited	22148
1988-1990	L6-4.0L	242 CID	Limited	22148
1980-1981	L6-4.2L	258 CID	Serpentine Belt Drive; Base,Base,Limited	22126
1982	L6-4.2L	258 CID	Serpentine Belt Drive; Base,Base,Brougham,Limited	22126
1983	L6-4.2L	258 CID	Serpentine Belt Drive; Brougham,Brougham,Limited	22126
1984-1986	V6-2.8L	173 CID	Base,Limited	22048
1972-1979	V8-5.9L	360 CID		22049
1980-1981	V8-5.9L	360 CID	Base,Limited	22049
1982	V8-5.9L	360 CID	Base,Brougham,Limited	22049
1983	V8-5.9L	360 CID	Brougham,Limited	22049
1974-1978	V8-6.6L	401 CID		22049
<b>WRANGLER</b>				
2003-2006	L4-2.4L	148 CID	SE	22148
1987	L4-2.5L	150 CID	Base,Laredo,Sport	22048
1988	L4-2.5L	150 CID	Base,Laredo,S,Sahara,Sport	22048
1989-1990	L4-2.5L	150 CID	Base,Islander,Sahara	22048
1991	L4-2.5L	150 CID	CCW; Base,Base,Islander,Laredo,Limited,S,Sahara	22148
1992	L4-2.5L	150 CID	CCW; Base,Base,S	22148
1993	L4-2.5L	150 CID	CCW; Base,Base,Islander,S	22148
1994	L4-2.5L	150 CID	CCW; S,S	22148
1995	L4-2.5L	150 CID	CCW; Rio Grande,Rio Grande,SE	22148
1997-2002	L4-2.5L	150 CID	SE	22148
1997-1999	L6-4.0L	242 CID	Sahara,Sport	22148
1991	L6-4.0L	242 CID	Base,Islander,Laredo,Limited,Regenade,Sahara	22149
1992-1993	L6-4.0L	242 CID	Base,Islander,Regenade,Sahara	22149
1994	L6-4.0L	242 CID	Regenade,Sahara,SE	22149
1995	L6-4.0L	242 CID	Sahara,SE	22149
2000-2001	L6-4.0L	242 CID	Sahara,Sport	22160
2002	L6-4.0L	242 CID	Sahara,Sport,X	22160
2003	L6-4.0L	242 CID	Rubicon,Sahara,Sport,X	22160
2004	L6-4.0L	242 CID	Rubicon,Sahara,Sport,Unlimited,X	22160
2005	L6-4.0L	242 CID	Rubicon,Sport,Unlimited,Unlimited Rubicon,X	22160
2006	L6-4.0L	242 CID	65th Anniversary Edition,Rubicon,SE,Sport,Unlimited,Unlimited Rubicon,X	22160
1987	L6-4.2L	258 CID	CCW; Base,Base,Laredo,Sport	22148
1988	L6-4.2L	258 CID	CCW; Base,Base,Islander,Laredo,S,Sahara,Sport	22148
1989-1990	L6-4.2L	258 CID	CCW; Base,Base,Islander,Laredo,Sahara	22148
2010	V6-3.8L	231 CID	Islander,Mountain,Rubicon,Sahara,Sport,Unlimited Islander,Unlimited Mountain,Unlimited Rubicon,Unlimited Sahara,Unlimited Sport,Unlimited X,X	22152
2011	V6-3.8L	231 CID	70th Anniversary,Rubicon,Sahara,Sport,Unlimited 70th Anniversary,Unlimited Rubicon,Unlimited Sahara,Unlimited Sport	22152
2007-2009	V6-3.8L	231 CID	Rubicon,Sahara,Unlimited Rubicon,Unlimited Sahara,Unlimited X,X	22626
<b>KIA</b>				
<b>SPORTAGE</b>				
1995-2000	L4-2.0L	1998cc	Base,EX	22373
2001	L4-2.0L	1998cc	To 06/21/01; Base,Base,EX	22373
2002	L4-2.0L	1998cc	Base	22373

**FAN CLUTCHES**



Years	Engine	Disp.	Application Description	USMW
<b>LAND ROVER</b>				
<b>DEFENDER 110</b>				
1993	V8-3.9L	3950cc	Base	22305
<b>DEFENDER 90</b>				
1994-1995	V8-3.9L	3950cc	Base	22305
1997	V8-4.0L	3950cc	Base,LE	22063EX
<b>DISCOVERY</b>				
1994-1995	V8-3.9L	3950cc	Base	22063EX
1999	V8-4.0L	3950cc	SD, Series II	22170
2000	V8-4.0L	3950cc	Series II	22170
2001	V8-4.0L	3950cc	Series II LE, Series II SD, Series II SE	22170
2002	V8-4.0L	3950cc	Series II SD, Series II SE	22170
1996	V8-4.0L	3950cc	SD, SE, SE7	22063EX
1997	V8-4.0L	3950cc	LSE, SD, SE, SE7, XD	22063EX
1998	V8-4.0L	3950cc	50th Anniversary Edition, LE, LSE	22063EX
<b>RANGE ROVER</b>				
1987	V8-3.5L	3532cc	Base	22063
1988	V8-3.5L	3532cc	40th Anniversary Edition, Base	22063
1989	V8-3.9L	3947cc	Base, County, Hunter	22063
1990	V8-3.9L	3947cc	Base, County	22063
1991	V8-3.9L	3947cc	Base, County SE, Great Divide, Hunter	22063
1992	V8-3.9L	3947cc	From Engine 40D09582B; Base, Base, County, LSE	22063EX
1993	V8-3.9L	3950cc	From Engine 40D09582B; County, County, Sport	22063EX
1994	V8-3.9L	3950cc	From Engine 40D09582B; County, County	22063EX
1995	V8-3.9L	3950cc	From Engine 40D09582B; County Classic, County Classic	22063EX
1995-1997	V8-4.0L	3950cc	SE	22170
1998	V8-4.0L	3950cc	50th Anniversary Edition, SE	22170
1999	V8-4.0L	3950cc	Base, S, SE	22170
2000	V8-4.0L	3950cc	Base, County, SE	22170
1993-1994	V8-4.2L	4200cc	From Engine 40D09582B; County LWB, County LWB	22063EX
1995	V8-4.2L	4200cc	From Engine 40D09582B; 25th Anniversary Edition, 25th Anniversary Edition, County LWB	22063EX
2003-2005	V8-4.4L	4398cc	HSE	22399
1996	V8-4.6L	4554cc	HSE	22170
1997	V8-4.6L	4554cc	HSE, Kensington, Vitesse	22170
1998	V8-4.6L	4554cc	HSE	22170
1999	V8-4.6L	4554cc	Callaway, HSE	22170
2000	V8-4.6L	4554cc	HSE, HSK, Vitesse	22170
2001	V8-4.6L	4554cc	HSE, SE	22170
2002	V8-4.6L	4554cc	HSE	22170
<b>LEXUS</b>				
<b>GS300</b>				
1993-1997	L6-3.0L	2997cc	Base	22402
<b>GX460</b>				
2010-2013	V8-4.6L	4608cc	Base, Premium	22408
<b>GX470</b>				
2003-2004	V8-4.7L	4663cc	Base	22184
2005	V8-4.7L	4663cc	From 11/04; Base, Base	22185
2006-2009	V8-4.7L	4663cc	Base	22185
<b>LS400</b>				
1990-1995	V8-4.0L	3967cc	Base	22178
1996	V8-4.0L	3969cc	Base	22178
1997-2000	V8-4.0L	3969cc	Towing Package; Base, Base	22178
<b>LX450</b>				
1996-1997	L6-4.5L	4477cc	Base	22074
<b>LX470</b>				
1998-2004	V8-4.7L	4663cc	Base	22183
2005	V8-4.7L	4663cc	From 05/05; Base, Base	22185
2006-2007	V8-4.7L	4663cc	Base	22185
<b>LX570</b>				
2008-2013	V8-5.7L	CID	Base	22408
<b>SC300</b>				
1992-2000	L6-3.0L	2997cc	Base	22402

Years	Engine	Disp.	Application Description	USMW
<b>LINCOLN</b>				
<b>AVIATOR</b>				
2003-2005	V8-4.6L	281 CID	Base	22139
<b>BLACKWOOD</b>				
2002	V8-5.4L	330 CID	Base	22168
<b>CONTINENTAL</b>				
1982	V6-3.8L	232 CID	Base, Givenchy, Signature	22126
1983	V8-5.0L	302 CID	Base, Givenchy, Valentino	22011
1984	V8-5.0L	302 CID	To 03/26/84; Base, Base, Givenchy, Valentino	22011
1982	V8-5.0L	302 CID		22016
1985	V8-5.0L	302 CID	Base, Givenchy, Valentino	22126
1986-1987	V8-5.0L	302 CID	Base, Givenchy	22126
1980	V8-5.8L	351 CID	Base	22011
1977-1979	V8-6.6L	400 CID		22011
1968	V8-7.0L	429 CID		22016
1968-1978	V8-7.5L	460 CID		22011
<b>MARK III</b>				
1968-1971	V8-7.5L	460 CID		22011
<b>MARK IV</b>				
1972-1976	V8-7.5L	460 CID		22011
<b>MARK LT</b>				
2006	V8-5.4L	330 CID	Base	22168
2007	V8-5.4L	330 CID	Base	22338
2008	V8-5.4L	330 CID	Electronic; Base, Base	22338
<b>MARK V</b>				
1977-1979	V8-6.6L	400 CID		22011
1977-1978	V8-7.5L	460 CID		22011
<b>MARK VI</b>				
1980-1981	V8-5.0L	302 CID	Base	22011
1982	V8-5.0L	302 CID	Base, Bill Blass, Givenchy, Pucci, Signature	22011
1983	V8-5.0L	302 CID	Base, Bill Blass, Pucci, Signature	22011
1980	V8-5.8L	351 CID	Base	22011
<b>MARK VII</b>				
1984	V8-5.0L	302 CID	To 03/26/84; Base, Base, Bill Blass, LSC, Versace	22011
1985	V8-5.0L	302 CID	Base, Bill Blass, LSC, Versace	22126
1986-1987	V8-5.0L	302 CID	Base, Bill Blass, LSC	22126
1988-1991	V8-5.0L	302 CID	Bill Blass, LSC	22126
1992	V8-5.0L	302 CID	To 06/92; Bill Blass, Bill Blass, LSC	22126
<b>NAVIGATOR</b>				
1998-2002	V8-5.4L	330 CID	Exc. A/C; Base, Base	22168
2003-2005	V8-5.4L	330 CID	Base	22168
2006	V8-5.4L	330 CID	Luxury, Ultimate	22168
2009	V8-5.4L	330 CID	Base, L	22334
2007	V8-5.4L	330 CID	L Luxury, L Ultimate, Luxury, Ultimate	22338
2008	V8-5.4L	330 CID	Base, L	22338
<b>TOWN CAR</b>				
1991-1992	V8-4.6L	281 CID	Towing Package; Base, Base, Cartier, Cypress, Executive, Signature, Touring Edition	22165
1993	V8-4.6L	281 CID	Base, Cartier, Cypress, Executive, Jack Nicklaus, Signature, Touring Edition	22169
1994	V8-4.6L	281 CID	Base, Cartier, Cypress, Executive, Signature, Touring Edition, Tournament Edition	22169
1995	V8-4.6L	281 CID	Base, Cartier, Cypress, Executive, Signature, Touring Edition	22169
1996	V8-4.6L	281 CID	Anniversary, Base, Cartier, Executive, Signature	22169
1997	V8-4.6L	281 CID	Base, Cartier, Executive, Signature, Touring Edition	22169
1998-2000	V8-4.6L	281 CID	Base, Cartier, Executive, Signature	22169
2001-2002	V8-4.6L	281 CID	Base, Cartier, Cartier L, Executive, Executive L, Signature	22169
2003	V8-4.6L	281 CID	Base, Cartier, Cartier L, Executive, Executive L, Executive Protection Series, Signature	22169
1981	V8-5.0L	302 CID	Base	22011
1982-1988	V8-5.0L	302 CID	Base, Cartier, Signature	22011
1989	V8-5.0L	302 CID	Base, Cartier, Signature, Signature SE	22011
1990	V8-5.0L	302 CID	Base, Cartier, Cypress, Executive, Signature, Touring Edition	22011
<b>VERSAILLES</b>				
1977-1979	V8-5.0L	302 CID		22011



Years	Engine	Disp.	Application Description	USMW
1980	V8-5.0L	302 CID	Base	22011
1977	V8-5.8L	351 CID		22011
<b>MAZDA</b>				
<b>929</b>				
1988-1989	V6-3.0L	2954cc	Base	22396
1990-1991	V6-3.0L	2954cc	Base,S	22396
1992-1995	V6-3.0L	2954cc	Base	22496
<b>B2000</b>				
1986-1987	L4-2.0L	1998cc	Base,LX,SE-5	22096
<b>B2200</b>				
1987-1989	L4-2.2L	2184cc	Auto Trans; Base,Base,LX,SE-5	22296
1990-1993	L4-2.2L	2184cc	Auto Trans; Base,Base,LE-5,SE-5	22296
<b>B2300</b>				
2001	L4-2.3L	2294cc	SE,SX	22135
1994-1997	L4-2.3L	2295cc	Base,SE	22015
2002	L4-2.3L	2300cc	Base	22135
2003-2004	L4-2.3L	2300cc	Base,SE	22135
2005-2009	L4-2.3L	2300cc	Base	22135
<b>B2500</b>				
1998	L4-2.5L	2492cc	A/C; SE,SE,SX	22015
1999	L4-2.5L	2492cc	A/C; SE,SE,SX,Troy Lee	22015
2000-2001	L4-2.5L	2492cc	A/C; SE,SE,SX	22015
<b>B2600</b>				
1987-1988	L4-2.6L	2555cc	Base,LX,SE-5	22092
1989	L4-2.6L	2606cc	Base,LX,SE-5	22090
1990-1993	L4-2.6L	2606cc	Base,LE-5,SE-5	22090
<b>B3000</b>				
1999	V6-3.0L	182 CID	SE,Troy Lee	22078
2000	V6-3.0L	182 CID	SE,SX,Troy Lee	22078
2001	V6-3.0L	182 CID	DS,SE	22078
2002	V6-3.0L	182 CID	Base,DS	22078
2003	V6-3.0L	182 CID	DS,SE	22078
1998	V6-3.0L	2954cc	SE,SX	22078
2001	V6-3.0L	2954cc	DS,SE	22078
2002	V6-3.0L	2954cc	Base,DS	22078
2003-2004	V6-3.0L	2954cc	DS,SE	22078
2005	V6-3.0L	2954cc	Base,DS	22078
2006	V6-3.0L	2954cc	From 08/22/05; Base,Base,DS	22078
2007	V6-3.0L	2954cc	Base,DS	22078
1994	V6-3.0L	2983cc	Exc.A/C; Base,Base,SE	22064
1995-1996	V6-3.0L	2983cc	Super Cooling; Base,Base,SE	22078
<b>B4000</b>				
1998-1999	V6-4.0L	4016cc	SE	22166
2000	V6-4.0L	4016cc	SE,Troy Lee	22166
2001	V6-4.0L	4016cc	DS,SE	22166
2002	V6-4.0L	4016cc	Base,DS	22166
2003-2004	V6-4.0L	4016cc	Base,DS,SE	22166
2005	V6-4.0L	4016cc	Base,SE	22166
2006	V6-4.0L	4016cc	From 08/22/05; Base,Base,SE	22166
2007-2008	V6-4.0L	4016cc	Base,SE	22166
2009	V6-4.0L	4016cc	Base	22166
1994-1996	V6-4.0L	4016cc	Exc.Super Cooling; LE,LE,SE	22167
1997	V6-4.0L	4016cc	Exc.Super Cooling; Base,Base,SE	22167
<b>MPV</b>				
1989-1992	L4-2.6L	2606cc	Cargo,Passenger	22090
1993-1994	L4-2.6L	2606cc	Passenger	22090
1989	V6-3.0L	2954cc	Manual Trans; Cargo,Cargo,Passenger	22098
1990	V6-3.0L	2954cc	Manual Trans; Cargo,Cargo,Passenger	22098
1991	V6-3.0L	2954cc	Manual Trans (To 05/01/91); Cargo,Cargo,Passenger	22098
1992	V6-3.0L	2954cc	RWD (Towing Package); Cargo,Cargo,Passenger	22098
1993-1994	V6-3.0L	2954cc	RWD (Towing Package); Passenger,Passenger	22098
1995	V6-3.0L	2954cc	RWD (Towing Package); L,L,LX,LXE	22098
1996	V6-3.0L	2954cc	Towing Package; DX,DX,ES,LX	22496
1997-1998	V6-3.0L	2954cc	Towing Package; ES,ES,LX	22496
<b>NAVAJO</b>				
1993-1994	V6-4.0L	4016cc	DX,LX	22166
1991	V6-4.0L	4016cc	Manual Trans; LX,LX	22167
1992	V6-4.0L	4016cc	Manual Trans; DX,DX,LX	22167

Years	Engine	Disp.	Application Description	USMW
<b>MERCEDES-BENZ</b>				
<b>300</b>				
1961-1966	L6-3.0L	2996cc		22314
<b>190D</b>				
1986	L5-2.5L	2497cc	Diesel; 2.5	22301
1987	L5-2.5L	2497cc	Diesel; 2.5,2.5 Turbo	22301
1988-1989	L5-2.5L	2497cc	Diesel; 2.5	22301
<b>190DT (MEX)</b>				
1990	L5-2.5L	2497cc		22307
<b>190E</b>				
1987-1993	L6-2.6L	2599cc	2.6	22320
<b>260E</b>				
1987-1989	L6-2.6L	2599cc	Base	22307
<b>260E (MEX)</b>				
1992	L6-2.6L	2599cc		22307
<b>260SE (MEX)</b>				
1987-1989	L6-2.6L	2599cc		22307
<b>280CE</b>				
1980	L6-2.8L	2746cc	Base	22319
1981	L6-2.8L	2778cc	Base	22319
<b>280E</b>				
1980	L6-2.8L	2746cc	Base	22319
1981	L6-2.8L	2778cc	Base	22319
<b>280SE</b>				
1980	L6-2.8L	2746cc	Base	22319
<b>300C</b>				
1957	L6-3.0L	2980cc		22314
<b>300CD</b>				
1983-1984	L5-3.0L	2998cc	Diesel; To Chassis/VIN 003977; Base,Base	22319
1985	L5-3.0L	2998cc	Diesel; Base	22319
1980-1981	L5-3.0L	3005cc	Diesel; Base	22319
1982	L5-3.0L	3005cc	Diesel; To Chassis/VIN 003977; Base,Base	22319
<b>300CE</b>				
1988-1992	L6-3.0L	2962cc	Base	22307
1993	L6-3.2L	3199cc	Base	22307
<b>300D</b>				
1990-1993	L5-2.5L	2497cc	Diesel; 2.5	22301
1983-1984	L5-3.0L	2998cc	Diesel; To Chassis/VIN 036024; Base,Base	22319
1985	L5-3.0L	2998cc	Diesel; Base	22319
1980-1981	L5-3.0L	3005cc	Diesel; Base	22319
1982	L5-3.0L	3005cc	Diesel; To Chassis/VIN 036024; Base,Base	22319
1987	L6-3.0L	2998cc	Diesel; Base	22301
<b>300D (MEX)</b>				
1989	L6-3.0L	2985cc		22307
<b>300E</b>				
1990-1992	L6-2.6L	2599cc	2.6	22307
1993	L6-2.8L	2799cc	2.8	22307
1986-1989	L6-3.0L	2962cc	Base	22307
1990-1992	L6-3.0L	2962cc	4Matic,Base	22307
1993	L6-3.0L	2962cc	4Matic	22307
1993	L6-3.2L	3199cc	Base	22307
<b>300SC</b>				
1957	L6-3.0L	2996cc		22314
<b>300SD</b>				
1983-1984	L5-3.0L	2998cc	Diesel; To Chassis/VIN 039510; Base,Base	22319
1985	L5-3.0L	2998cc	Diesel; Base	22319
1980	L5-3.0L	3005cc	Diesel; Base	22319
1981-1982	L5-3.0L	3005cc	Diesel; To Chassis/VIN 039510; Base,Base	22319
1992-1993	L6-3.4L	3449cc	Diesel; Base	22301
<b>300SDL</b>				
1986-1987	L6-3.0L	2998cc	Diesel; Base	22301
<b>300SE</b>				
1988-1991	L6-3.0L	2962cc	Base	22307
1992-1993	L6-3.2L	3199cc	Base	22322
<b>300SEL</b>				
1988-1991	L6-3.0L	2962cc	Base	22307

**FAN CLUTCHES**

Years	Engine	Disp.	Application Description	USMW
<b>300SL</b>				
1990-1993	L6-3.0L	2962cc	Base	22322
<b>300SL (MEX)</b>				
1986	L6-3.0L	2962cc		22307
<b>300TD</b>				
1983-1984	L5-3.0L	2998cc	Diesel; To Chassis/VIN 000008; Base,Base	22319
1985	L5-3.0L	2998cc	Diesel; Base	22319
1981	L5-3.0L	3005cc	Diesel; Base	22319
1982	L5-3.0L	3005cc	Diesel; To Chassis/VIN 000008; Base,Base	22319
1987	L6-3.0L	2998cc	Diesel; Base	22301
<b>300TE</b>				
1988-1989	L6-3.0L	2962cc	Base	22307
1990-1992	L6-3.0L	2962cc	4Matic,Base	22307
1993	L6-3.0L	2962cc	4Matic	22307
1993	L6-3.2L	3199cc	Base	22307
<b>300TE (MEX)</b>				
1986-1987	L6-3.0L	2962cc		22307
<b>350SD</b>				
1991	L6-3.4L	3449cc	Diesel; Base	22301
<b>350SDL</b>				
1990-1991	L6-3.4L	3449cc	Diesel; Base	22301
<b>380SE</b>				
1984-1985	V8-3.8L	3839cc	Base	22320
<b>380SEC</b>				
1982-1983	V8-3.8L	3839cc	Base	22320
<b>380SEL</b>				
1981-1983	V8-3.8L	3839cc	Base	22320
<b>380SL</b>				
1981-1985	V8-3.8L	3839cc	Base	22320
<b>380SLC</b>				
1981	V8-3.8L	3839cc	Base	22320
<b>400E</b>				
1992-1993	V8-4.2L	4196cc	Base	22313
<b>400E (MEX)</b>				
1994	V8-4.2L	4196cc		22099
<b>400SE</b>				
1992	V8-4.2L	4196cc	Base	22335
<b>400SE (MEX)</b>				
1996-1997	V8-4.2L	4196cc		22099
<b>400SEL</b>				
1993	V8-4.2L	4196cc	Base	22335
<b>400SEL (MEX)</b>				
1995-1997	V8-4.2L	4196cc		22099
<b>420SE (MEX)</b>				
1986	V8-4.2L	4196cc		22320
<b>420SEL</b>				
1986-1991	V8-4.2L	4196cc	Base	22320
<b>420SL (MEX)</b>				
1996-1997	V8-4.2L	4196cc		22099
1986	V8-4.2L	4196cc		22320
<b>500CL (MEX)</b>				
1996-1997	V8-5.0L	4973cc		22099
<b>500E</b>				
1992-1993	V8-5.0L	4973cc	Base	22313
<b>500E (MEX)</b>				
1991	V8-5.0L	4973cc		22099
<b>500SE (MEX)</b>				
1986	V8-5.0L	4973cc		22320
<b>500SEC</b>				
1984-1985	V8-5.0L	4973cc	Base	22320
1993	V8-5.0L	4973cc	Base	22335
<b>500SEC (MEX)</b>				
1987-1997	V8-5.0L	4973cc		22099
<b>500SEL</b>				
1984-1985	V8-5.0L	4973cc	Base	22320
1992-1993	V8-5.0L	4973cc	Base	22335

Years	Engine	Disp.	Application Description	USMW
<b>500SEL (MEX)</b>				
1991-1997	V8-5.0L	4973cc		22099
<b>500SL</b>				
1990-1993	V8-5.0L	4973cc	Base	22335
<b>500SL (MEX)</b>				
1989	V8-5.0L	4973cc		22099
1986	V8-5.0L	4973cc		22320
<b>560SE (MEX)</b>				
1986	V8-5.6L	5547cc		22320
<b>560SEC</b>				
1986-1991	V8-5.6L	5547cc	Base	22320
<b>560SEL</b>				
1986-1991	V8-5.6L	5547cc	Base	22320
<b>560SEL (MEX)</b>				
1994-1996	V8-5.6L	5547cc		22320
<b>560SL</b>				
1986-1989	V8-5.6L	5547cc	Base	22320
<b>600CL (MEX)</b>				
1996-1997	V12-6.0L	5987cc		22323
<b>600SEC</b>				
1993	V12-6.0L	5987cc	Base	22323
<b>600SEC (MEX)</b>				
1994-1997	V12-6.0L	5987cc		22323
<b>600SEL</b>				
1992-1993	V12-6.0L	5987cc	Base	22323
<b>600SEL (MEX)</b>				
1991-1997	V12-6.0L	5987cc		22323
<b>600SL</b>				
1993	V12-6.0L	5987cc	Base	22323
<b>C220</b>				
1994-1996	L4-2.2L	2199cc	Base	22308
<b>C230</b>				
1997-1998	L4-2.3L	2295cc	Base	22308
1999-2000	L4-2.3L	2295cc	Kompressor	22308
<b>C280</b>				
1994-1997	L6-2.8L	2799cc	Base	22307
1998-2000	V6-2.8L	2799cc	Base	22324
<b>C36 AMG</b>				
1995-1997	L6-3.6L	3606cc	Base	22307
<b>C43 AMG</b>				
1998-2000	V8-4.3L	4266cc	Base	22324
<b>CL500</b>				
1998-1999	V8-5.0L	4973cc	Base	22335
<b>CL600</b>				
1998-1999	V12-6.0L	5987cc	Base	22323
<b>CLK430</b>				
1999-2003	V8-4.3L	4266cc	Base	22324
<b>CLK55 AMG</b>				
2001-2002	V8-5.5L	5439cc	Base	22324
<b>E300</b>				
1995-1997	L6-3.0L	2996cc	Diesel; Base	22306
1998-1999	L6-3.0L	2996cc	Diesel; Base	22327
<b>E320</b>				
1994-1995	L6-3.2L	3199cc	Base	22307
1996-1997	L6-3.2L	3199cc	Base	22322
1998-2003	V6-3.2L	3199cc	4Matic,Base	22324
<b>E420</b>				
1994-1995	V8-4.2L	4196cc	Base	22313
<b>E430</b>				
1998-1999	V8-4.3L	4266cc	Base	22321
2000-2002	V8-4.3L	4266cc	4Matic,Base	22321
<b>E500</b>				
1994	V8-5.0L	4973cc	Base	22313
<b>ML320</b>				
1998-2003	V6-3.2L	3199cc	Base	22325

Years	Engine	Disp.	Application Description	USMW
<b>ML350</b>				
2003-2005	V6-3.7L	3699cc	Base	22325
<b>ML430</b>				
1999-2001	V8-4.3L	4266cc	Base	22321
<b>ML55 AMG</b>				
2000-2003	V8-5.5L	5439cc	Base	22321
<b>S320</b>				
1994-1999	L6-3.2L	3199cc	LWB,SWB	22322
<b>S350</b>				
1994-1995	L6-3.4L	3449cc	Diesel; Base	22301
<b>S420</b>				
1994-1999	V8-4.2L	4196cc	Base	22335
<b>S500</b>				
1994-1999	V8-5.0L	4973cc	Base	22335
<b>S600</b>				
1994-1999	V12-6.0L	5987cc	Base	22323
<b>SL320</b>				
1994-1997	L6-3.2L	3199cc	Base	22322
<b>SL500</b>				
1999-2002	V8-5.0L	4973cc	Base	22321
1994-1998	V8-5.0L	4973cc	Base	22335
<b>SL600</b>				
1994-2002	V12-6.0L	5987cc	Base	22323
<b>SLK (MEX)</b>				
1996-1997	L4-2.3L	2295cc		22308
<b>SPRINTER (MEX)</b>				
2004-2006	L5-2.7L	2685cc		22328
<b>MERCURY</b>				
<b>CAPRI</b>				
1979	L6-3.3L	200 CID		22011
1980	L6-3.3L	200 CID	A/C; Base,Ghia	22012
1981	L6-3.3L	200 CID	A/C; Base,GS	22012
1982	L6-3.3L	200 CID	A/C; Base,Black Magic,GS,L	22012
1984	V6-3.8L	232 CID	Exc.A/C; GS,GS	22126
1985	V6-3.8L	232 CID	A/C (From 04/85); GS,GS	22146
1986	V6-3.8L	232 CID	A/C; GS,GS	22146
1981-1982	V8-4.2L	255 CID		22011
1981	V8-4.2L	255 CID	Exc.A/C; Base,Base,GS	22126
1982	V8-4.2L	255 CID	Exc.A/C; Base,Base,Black Magic,GS,L,RS	22126
1979-1985	V8-5.0L	302 CID		22011
1982-1984	V8-5.0L	302 CID	Exc.A/C; RS,RS	22126
1985	V8-5.0L	302 CID	A/C; RS,RS	22146
1986	V8-5.0L	302 CID	A/C; 5.0,5.0	22146
<b>COLONY PARK</b>				
1981-1985	V8-5.0L	302 CID		22011
1987-1991	V8-5.0L	302 CID	Towing Package (Police); GS,GS,LS	22011
1979-1991	V8-5.0L	302 CID		22016
1981	V8-5.8L	351 CID		22011
1971-1979	V8-5.8L	351 CID		22016
1964-1970	V8-6.4L	390 CID		22016
1975-1976	V8-6.6L	400 CID		22011
1971-1974	V8-6.6L	400 CID		22016
1967	V8-6.7L	410 CID		22016
1967-1968	V8-7.0L	428 CID		22016
1969-1973	V8-7.0L	429 CID		22016
1972-1976	V8-7.5L	460 CID		22038
<b>COMET</b>				
1964-1977	L6-3.3L	200 CID		22011
1969-1977	L6-4.1L	250 CID		22011
1964-1967	V8-4.7L	289 CID		22011
1968-1977	V8-5.0L	302 CID		22011
1969	V8-5.8L	351 CID		22011
1966-1969	V8-6.4L	390 CID		22011
1967	V8-7.0L	427 CID		22011
<b>COMMUTER</b>				
1968	V8-6.4L	390 CID		22016

Years	Engine	Disp.	Application Description	USMW
<b>COUGAR</b>				
1980-1981	L6-3.3L	200 CID		22011
1980	L6-3.3L	200 CID	Exc.A/C; XR-7,XR-7	22038
1981	L6-3.3L	200 CID	Exc.A/C; Base,Base,XR-7	22038
1982	L6-3.3L	200 CID	Exc.A/C; Base,Base,GS,LS,XR-7	22038
1982	V6-3.8L	232 CID	Exc.A/C; Base,Base,GS,LS,XR-7	22126
1983-1986	V6-3.8L	232 CID	Exc.A/C; Base,Base,LS	22126
1987-1988	V6-3.8L	232 CID	Exc.A/C; LS,LS	22126
1989-1992	V6-3.8L	232 CID	LS	22126
1993	V6-3.8L	232 CID	XR-7	22126
1980	V8-4.2L	255 CID	XR-7	22011
1981	V8-4.2L	255 CID	Base,XR-7	22011
1982	V8-4.2L	255 CID	XR-7	22011
1967-1968	V8-4.7L	289 CID		22011
1968-1979	V8-5.0L	302 CID		22011
1983-1985	V8-5.0L	302 CID	Exc.A/C; Base,Base,LS	22011
1987-1991	V8-5.0L	302 CID		22011
1986	V8-5.0L	302 CID	Exc.A/C; Base,Base,LS	22126
1987-1988	V8-5.0L	302 CID	Exc.A/C; LS,LS,XR-7	22126
1991-1992	V8-5.0L	302 CID	LS,XR-7	22163
1993	V8-5.0L	302 CID	XR-7	22163
1969-1979	V8-5.8L	351 CID		22011
1967-1969	V8-6.4L	390 CID		22011
1973-1978	V8-6.6L	400 CID		22011
1968	V8-7.0L	427 CID		22011
1968-1970	V8-7.0L	428 CID		22011
1970-1971	V8-7.0L	429 CID		22011
1973-1976	V8-7.5L	460 CID		22308
<b>CYCLONE</b>				
1965-1966	V8-4.7L	289 CID		22011
1968-1969	V8-5.0L	302 CID		22011
1969-1971	V8-5.8L	351 CID		22011
1966-1969	V8-6.4L	390 CID		22011
1968	V8-7.0L	427 CID		22011
1968-1969	V8-7.0L	428 CID		22011
1970-1971	V8-7.0L	429 CID		22011
<b>GRAND MARQUIS</b>				
1981-1982	V8-4.2L	255 CID	Base	22011
1992	V8-4.6L	281 CID	Towing Package (To 03/92) (Police); GS,GS,LS	22169
1993	V8-4.6L	281 CID	Towing Package (Police); GS,LS	22169
1994-2002	V8-4.6L	281 CID	GS,LS	22169
2003	V8-4.6L	281 CID	GS,LS,LSE	22169
2004	V8-4.6L	281 CID	GS,LS	22169
2005	V8-4.6L	281 CID	GS,GSL,Limited Edition,LS,Ultimate Edition	22169
2006	V8-4.6L	281 CID	GS,LS	22169
1980	V8-5.0L	302 CID		22011
1980	V8-5.0L	302 CID	Towing Package; Base,Colony Park	22011
1981	V8-5.0L	302 CID		22011
1981	V8-5.0L	302 CID	Base,Colony Park	22011
1982	V8-5.0L	302 CID		22011
1982	V8-5.0L	302 CID	Base,Colony Park	22011
1983	V8-5.0L	302 CID		22011
1983	V8-5.0L	302 CID	Base,LS	22011
1984	V8-5.0L	302 CID		22011
1984	V8-5.0L	302 CID	Base,Colony Park,LS	22011
1985	V8-5.0L	302 CID		22011
1985	V8-5.0L	302 CID	Towing Package (Police); Base,Base,Colony Park,LS	22011
1986	V8-5.0L	302 CID	Towing Package (Police); Base,Base,Colony Park,LS	22011
1987	V8-5.0L	302 CID		22011
1987	V8-5.0L	302 CID	Towing Package (Police); GS,GS,LS	22011
1988	V8-5.0L	302 CID		22011
1988	V8-5.0L	302 CID	Towing Package (Police); GS,GS,LS	22011
1989	V8-5.0L	302 CID		22011
1989-1991	V8-5.0L	302 CID	Towing Package (Police); GS,GS,LS	22011
1979-1991	V8-5.0L	302 CID		22016
1980	V8-5.8L	351 CID	Towing Package; Base,Base,Colony Park	22011
1981	V8-5.8L	351 CID		22011
1981	V8-5.8L	351 CID	Towing Package; Base,Base,Colony Park	22011
1986	V8-5.8L	351 CID	Except Police package	22011

Years	Engine	Disp.	Application Description	USMW
1986	V8-5.8L	351 CID	Police; Base,Base,LS	<b>22011</b>
1978-1989	V8-5.8L	351 CID		<b>22016</b>
1975-1978	V8-6.6L	400 CID		<b>22016</b>
1975-1978	V8-7.5L	460 CID		<b>22038</b>
<b>MARAUDER</b>				
2003-2004	V8-4.6L	281 CID	Base	<b>22169</b>
1963-1970	V8-6.4L	390 CID		<b>22011</b>
1963-1964	V8-7.0L	427 CID		<b>22011</b>
1969-1970	V8-7.0L	429 CID		<b>22011</b>
<b>MARQUIS</b>				
1983	L6-3.3L	200 CID	Exc.A/C; Base,Brougham	<b>22012</b>
1983-1986	V6-3.8L	232 CID	Exc.A/C; Base,Base,Brougham	<b>22126</b>
1981-1982	V8-4.2L	255 CID	Base,Brougham	<b>22011</b>
1979	V8-5.0L	302 CID		<b>22011</b>
1980-1982	V8-5.0L	302 CID	Base,Brougham	<b>22011</b>
1985	V8-5.0L	302 CID		<b>22011</b>
1985	V8-5.0L	302 CID	Exc.A/C; Base,Base	<b>22146</b>
1971-1979	V8-5.8L	351 CID		<b>22011</b>
1980-1981	V8-5.8L	351 CID	Base,Brougham	<b>22011</b>
1968-1970	V8-6.4L	390 CID		<b>22011</b>
1971-1978	V8-6.6L	400 CID		<b>22011</b>
1967	V8-6.7L	410 CID		<b>22016</b>
1967-1969	V8-7.0L	428 CID		<b>22011</b>
1969-1973	V8-7.0L	429 CID		<b>22011</b>
1972-1978	V8-7.5L	460 CID		<b>22038</b>
<b>METEOR</b>				
1962-1963	V8-3.6L	221 CID		<b>22016</b>
1961	V8-6.4L	390 CID		<b>22016</b>
<b>MONARCH</b>				
1975-1977	L6-3.3L	200 CID		<b>22011</b>
1975-1979	L6-4.1L	250 CID		<b>22011</b>
1980	V8-4.2L	255 CID	Base	<b>22011</b>
1975-1979	V8-5.0L	302 CID		<b>22011</b>
1980	V8-5.0L	302 CID	Base	<b>22011</b>
1975-1977	V8-5.8L	351 CID		<b>22011</b>
<b>MONTCLAIR</b>				
1964-1968	V8-6.4L	390 CID		<b>22011</b>
1966-1967	V8-6.7L	410 CID		<b>22016</b>
1964-1966	V8-7.0L	427 CID		<b>22011</b>
1966-1968	V8-7.0L	428 CID		<b>22011</b>
<b>MONTEGO</b>				
1968	L6-3.3L	200 CID		<b>22011</b>
1969-1974	L6-4.1L	250 CID		<b>22011</b>
1968-1974	V8-5.0L	302 CID		<b>22011</b>
1969-1976	V8-5.8L	351 CID		<b>22011</b>
1968-1969	V8-6.4L	390 CID		<b>22011</b>
1972-1976	V8-6.6L	400 CID		<b>22011</b>
1968	V8-7.0L	427 CID		<b>22011</b>
1968-1969	V8-7.0L	428 CID		<b>22011</b>
1970-1973	V8-7.0L	429 CID		<b>22011</b>
1973-1976	V8-7.5L	460 CID		<b>22038</b>
<b>MONTEREY</b>				
1971-1973	V8-5.8L	351 CID		<b>22011</b>
1961-1962	V8-5.8L	352 CID		<b>22011</b>
1961-1970	V8-6.4L	390 CID		<b>22011</b>
1971-1974	V8-6.6L	400 CID		<b>22011</b>
1962-1963	V8-6.6L	406 CID		<b>22011</b>
1966-1967	V8-6.7L	410 CID		<b>22016</b>
1963-1966	V8-7.0L	427 CID		<b>22011</b>
1966-1970	V8-7.0L	428 CID		<b>22011</b>
1969-1973	V8-7.0L	429 CID		<b>22011</b>
1972-1974	V8-7.5L	460 CID		<b>22038</b>
<b>MOUNTAINEER</b>				
2002-2003	V6-4.0L	245 CID	Base	<b>22139</b>
2004-2005	V6-4.0L	245 CID	Base,Premier	<b>22139</b>
1998-2001	V6-4.0L	245 CID	Base	<b>22166</b>
2006	V6-4.0L	245 CID	Convenience,Luxury	<b>22166</b>
2007-2010	V6-4.0L	245 CID	Base,Premier	<b>22337</b>

Years	Engine	Disp.	Application Description	USMW
2002-2003	V8-4.6L	281 CID	Base	<b>22139</b>
2004-2005	V8-4.6L	281 CID	Base,Premier	<b>22139</b>
2006	V8-4.6L	281 CID	Luxury,Premier	<b>22166</b>
2007-2010	V8-4.6L	281 CID	Premier	<b>22337</b>
1997-2001	V8-5.0L	302 CID	Base	<b>22615</b>
<b>PARK LANE</b>				
1964-1968	V8-6.4L	390 CID		<b>22011</b>
1966-1967	V8-6.7L	410 CID		<b>22016</b>
1964-1966	V8-7.0L	427 CID		<b>22011</b>
1966-1968	V8-7.0L	428 CID		<b>22011</b>
<b>S-55</b>				
1966	V8-7.0L	428 CID		<b>22016</b>
<b>ZEPHYR</b>				
1978-1979	L6-3.3L	200 CID		<b>22011</b>
1983	L6-3.3L	200 CID	Exc.A/C; Base,Base,GS,Z7,Z7 GS	<b>22012</b>
1980-1981	L6-3.3L	200 CID	A/C (Exc.Heavy Duty Cooling); Base,Base,Z7	<b>22038</b>
1982	L6-3.3L	200 CID	Exc.A/C; Base,Base,GS,Z7	<b>22038</b>
1980	V8-4.2L	255 CID	Base,Z7	<b>22011</b>
1981	V8-4.2L	255 CID	Exc.A/C; Base,Base,Z7	<b>22011</b>
1982	V8-4.2L	255 CID	Base,GS	<b>22011</b>
1978-1979	V8-5.0L	302 CID		<b>22011</b>
<b>MERKUR</b>				
<b>SCORPIO</b>				
1988-1989	V6-2.9L	177 CID	Base	<b>22067</b>
<b>MITSUBISHI</b>				
<b>MIGHTY MAX</b>				
1983-1984	L4-2.0L	1997cc	RWD; Base,S	<b>22086</b>
1985-1989	L4-2.0L	1997cc	Base	<b>22086</b>
1983	L4-2.3L	2346cc	Diesel; SP	<b>22073</b>
1984-1985	L4-2.3L	2346cc	Diesel; SP,SPX	<b>22073</b>
1990-1992	L4-2.4L	2351cc	1 Ton,Base	<b>22086</b>
1993-1996	L4-2.4L	2351cc	Base	<b>22086</b>
1983-1984	L4-2.6L	2555cc	RWD; SP,SP,SPX	<b>22092</b>
1985	L4-2.6L	2555cc	SP,SPX	<b>22092</b>
1986	L4-2.6L	2555cc	Base,Sport,SPX	<b>22092</b>
1987	L4-2.6L	2555cc	1 Ton,Base,Sport,SPX	<b>22092</b>
1988	L4-2.6L	2555cc	1 Ton,Sport,SPX	<b>22092</b>
1989	L4-2.6L	2555cc	1 Ton,Base,Sport,SPX	<b>22092</b>
1990-1991	V6-3.0L	2972cc	1 Ton,Base	<b>22073</b>
1992-1994	V6-3.0L	2972cc	Base	<b>22073</b>
<b>MONTERO</b>				
1983	L4-2.6L	2555cc	Base	<b>22092</b>
1984	L4-2.6L	2555cc	Base,Sport	<b>22092</b>
1985-1986	L4-2.6L	2555cc	Base	<b>22092</b>
1987-1988	L4-2.6L	2555cc	Base,Sport	<b>22092</b>
1989	L4-2.6L	2555cc	Base,SP	<b>22092</b>
1989	V6-3.0L	2972cc	Base,LS,SP,Sport	<b>22073</b>
1990	V6-3.0L	2972cc	Base,LS,RS,SP,Sport	<b>22073</b>
1991	V6-3.0L	2972cc	Base,LS,RS	<b>22073</b>
1992-1993	V6-3.0L	2972cc	Base,LS,RS,SR	<b>22073</b>
1994	V6-3.0L	2972cc	To 05/94; LS,LS	<b>22073</b>
1995-1996	V6-3.0L	2972cc	LS	<b>22073</b>
1994-1996	V6-3.5L	3497cc	SR	<b>22073</b>
1997	V6-3.5L	3497cc	LS,SR	<b>22073</b>
1998-2000	V6-3.5L	3497cc	Base	<b>22073</b>
2001-2002	V6-3.5L	3497cc	Limited,XLS	<b>22409</b>
2003	V6-3.8L	3497cc	To 07/03; Limited,XLS	<b>22409</b>
2003	V6-3.8L	3797cc	From 08/03; Limited,XLS	<b>22410</b>
2004	V6-3.8L	3797cc	Limited,XLS	<b>22410</b>
2005	V6-3.8L	3797cc	Limited	<b>22410</b>
2006	V6-3.8L	3828cc	Limited	<b>22410</b>
<b>MONTERO 2WD (MEX)</b>				
2005-2009	L6-3.5L	3497cc		<b>22073</b>
<b>MONTERO SPORT</b>				
1997-1999	L4-2.4L	2351cc	ES	<b>22019</b>
1997-1999	V6-3.0L	2972cc	LS,XLS	<b>22029</b>
2000-2001	V6-3.0L	2972cc	ES,LS,XLS	<b>22029</b>



Years	Engine	Disp.	Application Description	USMW
2002-2003	V6-3.0L	2972cc	ES,LS	22029
2003	V6-3.5L	3497cc	Limited,XLS	22029
2004	V6-3.5L	3497cc	LS,XLS	22029
1999-2000	V6-3.5L	3497cc	Limited	22073
2001	V6-3.5L	3497cc	Limited,XS	22073
2002	V6-3.5L	3497cc	To 12/01; Limited,Limited,XLS	22073
<b>RAIDER</b>				
2006	V6-3.7L	226 CID	Heavy Duty Cooling; DuroCross,DuroCross,LS	22170
2007	V6-3.7L	226 CID	DuroCross,LS	22170
2008-2009	V6-3.7L	226 CID	LS	22170
2006	V8-4.7L	285 CID	Heavy Duty Cooling; DuroCross,DuroCross,XLS	22170
2007	V8-4.7L	285 CID	Heavy Duty Cooling; LS,LS,SE	22170
<b>STARION</b>				
1983	L4-2.6L	2555cc	Base,LS	22092
1984	L4-2.6L	2555cc	ES,LE,LS	22092
1985	L4-2.6L	2555cc	ES,LS	22092
1986-1987	L4-2.6L	2555cc	LE	22092
<b>VAN</b>				
1987-1990	L4-2.4L	2351cc	Base,LS	22086
<b>NISSAN</b>				
<b>510</b>				
1978-1979	L4-2.0L	1952cc		22089
<b>610</b>				
1974-1976	L4-2.0L	1952cc		22089
<b>620</b>				
1975-1979	L4-2.0L	1952cc		22089
<b>710</b>				
1975-1977	L4-2.0L	1952cc		22089
<b>720</b>				
1981-1983	L4-2.2L	2164cc	Diesel; Deluxe	22082
1983-1986	L4-2.5L	2488cc	Diesel; Deluxe	22082
<b>810</b>				
1977-1979	L6-2.4L	2393cc		22082
1980	L6-2.4L	2393cc	Base	22082
1981	L6-2.4L	2393cc	DX	22082
1981	L6-2.8L	2793cc	Diesel; DX	22082
<b>200SX</b>				
1984-1986	L4-1.8L	1809cc	Turbo	22088
1977-1979	L4-2.0L	1952cc		22089
1984-1986	L4-2.0L	1974cc	Base,XE	22088
1987-1988	L4-2.0L	1974cc	SE,XE	22088
1987-1988	V6-3.0L	2960cc	SE	22082
<b>240SX</b>				
1989-1990	L4-2.4L	2389cc	SE,XE	22082
1991-1992	L4-2.4L	2389cc	Base,LE,SE	22082
1993	L4-2.4L	2389cc	Base,SE	22082
1994	L4-2.4L	2389cc	SE	22082
1995-1996	L4-2.4L	2389cc	Base,SE	22082
1997-1998	L4-2.4L	2389cc	Base,LE,SE	22082
<b>240Z</b>				
1970-1973	L6-2.4L	2393cc		22082
<b>260Z</b>				
1974-1975	L6-2.6L	2600cc		22082
<b>280Z</b>				
1975-1978	L6-2.8L	2753cc		22082
<b>280ZX</b>				
1979	L6-2.8L	2753cc		22082
1980	L6-2.8L	2753cc	2+2 GL,Base,GL	22082
1981	L6-2.8L	2753cc	2+2 GL,Base,GL,GL Turbo	22082
1982-1983	L6-2.8L	2753cc	2+2,2+2 Turbo,Base,Turbo	22082
<b>300ZX</b>				
1984-1989	V6-3.0L	2960cc	2+2,Base,Turbo	22082
1990-1996	V6-3.0L	2960cc	2+2,Base,Turbo	22091
<b>ARMADA</b>				
2005-2006	V8-5.6L	5552cc	LE,SE,SE Off-Road	22181
2007-2009	V8-5.6L	5552cc	LE,SE	22181
2010	V8-5.6L	5552cc	Platinum,SE,Titanium	22181

Years	Engine	Disp.	Application Description	USMW
2011-2013	V8-5.6L	5552cc	Platinum,SL,SV	22181
<b>D21</b>				
1990-1993	L4-2.4L	2389cc	Base	22082
1994	L4-2.4L	2389cc	Base,XE	22082
1986-1987	V6-3.0L	2960cc	E,SE	22082
1988-1989	V6-3.0L	2960cc	RWD; E,E,SE	22082
1990-1993	V6-3.0L	2960cc	Base,SE	22091
1994	V6-3.0L	2960cc	Base,SE,XE	22091
<b>FRONTIER</b>				
1998	L4-2.4L	2389cc	Base,SE,XE	22082
1999	L4-2.4L	2389cc	SE,XE	22082
2000-2001	L4-2.4L	2389cc	XE	22082
2002-2003	L4-2.4L	2389cc	Base,XE	22082
2004	L4-2.4L	2389cc	XE	22082
2005-2007	L4-2.5L	2500cc	XE	22182
2008-2009	L4-2.5L	2500cc	SE,XE	22182
2010	L4-2.5L	2500cc	To 08/2009; SE,SE,XE	22182
2011-2013	L4-2.5L	2500cc	S,SV	22182
1999-2000	V6-3.3L	3275cc	SE,XE	22025
2001	V6-3.3L	3275cc	SC,SE,XE	22025
2002-2003	V6-3.3L	3275cc	SC,SE,SVE,XE	22025
2004	V6-3.3L	3275cc	SC,SVE,XE	22025
2005-2008	V6-4.0L	3954cc	LE,Nismo Off-Road,SE	22182
2009-2010	V6-4.0L	3954cc	LE,PRO-4X,SE	22182
2011-2012	V6-4.0L	3954cc	PRO-4X,S,SL,SV	22182
2013	V6-4.0L	3954cc	Desert Runner,PRO-4X,SL,SV	22182
<b>FRONTIER PICKUP (MEX)</b>				
2006-2008	L4-2.4L	2389cc		22091
<b>MAXIMA</b>				
1981	L6-2.4L	2393cc	SL	22082
1982-1984	L6-2.4L	2393cc	GL	22082
1981	L6-2.8L	2793cc	Diesel; SL	22082
1982-1983	L6-2.8L	2793cc	Diesel; GL	22082
<b>NV1500</b>				
2012-2013	V6-4.0L	3954cc	S,SV	22182
<b>NV2500</b>				
2012-2013	V6-4.0L	3954cc	S,SV	22182
2012-2013	V8-5.6L	5552cc	S,SV	22181
<b>NV3500</b>				
2012-2013	V6-4.0L	3954cc	S,SV	22182
2012-2013	V8-5.6L	5552cc	S,SL,SV	22181
<b>PATHFINDER</b>				
1987-1989	V6-3.0L	2960cc	Manual Trans; SE,SE,XE	22082
1990-1993	V6-3.0L	2960cc	SE,XE	22091
1994-1995	V6-3.0L	2960cc	LE,SE,XE	22091
1996-2000	V6-3.5L	3275cc	LE,SE,XE	22025
2001	V6-3.5L	3498cc	LE,SE,XE	22032
2002-2004	V6-3.5L	3498cc	LE,SE	22032
2005	V6-4.0L	3954cc	LE,SE,SE Off-Road,XE	22182
2006-2009	V6-4.0L	3954cc	LE,S,SE,SE Off-Road	22182
2010	V6-4.0L	3954cc	LE,S,SE	22182
2011	V6-4.0L	3954cc	LE,S,Silver Edition,SV	22182
2012	V6-4.0L	3954cc	LE,S,SV	22182
2004	V8-5.6L	5552cc	Armada LE,Armada SE	22181
2008-2009	V8-5.6L	5552cc	LE,SE	22181
2010-2012	V8-5.6L	5552cc	LE	22181
<b>PICKUP</b>				
1995	L4-2.4L	2389cc	Base,XE	22082
1996-1997	L4-2.4L	2389cc	Base,SE,XE	22082
1995	V6-3.0L	2960cc	SE,XE	22091
<b>PICKUP (MEX)</b>				
1991-2009	L4-2.4L	2389cc		22082
<b>TITAN</b>				
2004-2007	V8-5.6L	5552cc	LE,SE,XE	22181
2008-2010	V8-5.6L	5552cc	LE,PRO-4X,SE,XE	22181
2011-2013	V8-5.6L	5552cc	PRO-4X,S,SL,SV	22181
<b>URVAN (MEX)</b>				
2000-2005	L4-2.4L	2389cc		22083

**FAN CLUTCHES**

Years	Engine	Disp.	Application Description	USMW
<b>XTERRA</b>				
2000-2002	L4-2.4L	2389cc	SE,XE	22082
2003-2004	L4-2.4L	2389cc	XE	22082
2000-2004	V6-3.3L	3275cc	SE,XE	22025
2005	V6-4.0L	3954cc	Off-Road,S,SE	22182
2006-2010	V6-4.0L	3954cc	Off-Road,S,SE,X	22182
2011-2013	V6-4.0L	3954cc	PRO-4X,S,X	22182
<b>OLDSMOBILE</b>				
<b>88</b>				
1977-1979	V6-3.8L	231 CID		22043
1977-1979	V8-4.3L	260 CID		22045
1979	V8-4.9L	301 CID		22045
1969-1979	V8-5.7L	350 CID		22045
1977-1978	V8-5.7L	350 CID		22049
1975	V8-6.6L	400 CID		22045
1977-1979	V8-6.6L	403 CID		22045
1969-1976	V8-7.5L	455 CID		22045
<b>98</b>				
1981	V6-4.1L	252 CID	Luxury,Regency	22043
1982-1983	V6-4.1L	252 CID	Regency,Regency Brougham	22049
1980-1981	V8-5.0L	307 CID	Luxury,Regency	22049
1982-1984	V8-5.0L	307 CID	Regency,Regency Brougham	22049
1977-1979	V8-5.7L	350 CID		22045
1978	V8-5.7L	350 CID		22049
1980	V8-5.7L	350 CID	Diesel; Exc.Heavy Duty Cooling; Luxury,Luxury, Regency	22049
1981	V8-5.7L	350 CID	Diesel; Exc.Heavy Duty Cooling; Luxury,Luxury, Regency	22049
1982-1984	V8-5.7L	350 CID	Diesel; Exc.Heavy Duty Cooling; Regency,Regency, Regency Brougham	22049
1961-1964	V8-6.5L	394 CID		22049
1975	V8-6.6L	400 CID		22045
1977-1979	V8-6.6L	403 CID		22045
1965-1967	V8-7.0L	425 CID		22045
1968-1976	V8-7.5L	455 CID		22045
<b>442</b>				
1965-1969	V8-6.6L	400 CID		22049
1968-1971	V8-7.5L	455 CID		22045
<b>88 CUSTOM CRUISER</b>				
1986-1989	V8-5.0L	307 CID		22049
<b>BRAVADA</b>				
2002-2004	L6-4.2L	256 CID	Base	22310
1991-1994	V6-4.3L	262 CID	A/C; Base,Base	22145
1996-2001	V6-4.3L	262 CID	Exc.A/C; Base,Base	22162
<b>CUSTOM CRUISER</b>				
1991-1992	V8-5.0L	305 CID	Heavy Duty Cooling; Base,Base	22145
1980-1990	V8-5.0L	307 CID	Base	22049
1973-1979	V8-5.7L	350 CID		22045
1978	V8-5.7L	350 CID		22049
1980	V8-5.7L	350 CID	Diesel; Exc.Heavy Duty Cooling; Base,Base	22049
1981-1984	V8-5.7L	350 CID	Diesel; Exc.Heavy Duty Cooling; Base,Base	22049
1985	V8-5.7L	350 CID	Diesel; Base	22049
1992	V8-5.7L	350 CID	Heavy Duty Cooling; Base,Base	22145
1975	V8-6.6L	400 CID		22045
1977-1979	V8-6.6L	403 CID		22045
1971-1976	V8-7.5L	455 CID		22045
<b>CUTLASS</b>				
1967-1976	L6-4.1L	250 CID		22049
1977-1979	V6-3.8L	231 CID		22043
1980	V6-3.8L	231 CID	Base,Brougham,LS	22049
1981	V6-3.8L	231 CID	Brougham,LS	22049
1975-1979	V8-4.3L	260 CID		22049
1980	V8-4.3L	260 CID	Base,Brougham,LS	22049
1981	V8-4.3L	260 CID	Brougham,LS	22049
1980	V8-5.0L	305 CID	A/C (Heavy Duty Cooling); Base,Base,Brougham,LS	22045
1978-1979	V8-5.0L	305 CID		22049
1964-1967	V8-5.4L	330 CID		22049
1968-1979	V8-5.7L	350 CID		22045

Years	Engine	Disp.	Application Description	USMW
1980	V8-5.7L	350 CID	Diesel; Exc.Heavy Duty Cooling; Base,Base, Brougham,LS	22049
1981	V8-5.7L	350 CID	Diesel; Exc.Heavy Duty Cooling; Brougham, Brougham,LS	22049
1965-1968	V8-6.6L	400 CID		22049
1977	V8-6.6L	403 CID		22045
1970-1976	V8-7.5L	455 CID		22045
<b>CUTLASS CALAIS</b>				
1980-1981	V6-3.8L	231 CID	Base	22049
1982	V6-3.8L	231 CID	Exc.A/C; Base,Base	22049
1983	V6-3.8L	231 CID	Exc.A/C; Base,Base,Hurst	22049
1984	V6-3.8L	231 CID	Exc.A/C; Base,Base	22049
1982	V6-4.3L	260 CID	Diesel; Base	22049
1983	V6-4.3L	260 CID	Diesel; Base,Hurst	22049
1984	V6-4.3L	260 CID	Diesel; Base	22049
1980-1982	V8-4.3L	260 CID	Base	22049
1980	V8-5.0L	305 CID	A/C (Heavy Duty Cooling); Base,Base	22045
1982	V8-5.0L	307 CID	Base	22049
1983-1984	V8-5.0L	307 CID	Base,Hurst	22049
1980	V8-5.7L	350 CID	Diesel; Exc.Heavy Duty Cooling; Base,Base	22049
1981-1982	V8-5.7L	350 CID	Diesel; Exc.Heavy Duty Cooling; Base,Base	22049
1983	V8-5.7L	350 CID	Diesel; Exc.Heavy Duty Cooling; Base,Base,Hurst	22049
1984	V8-5.7L	350 CID	Diesel; Exc.Heavy Duty Cooling; Base,Base	22049
<b>CUTLASS CRUISER</b>				
1978	V6-3.8L	231 CID		22043
1979	V6-3.8L	231 CID	Vista Cruiser	22043
1980-1981	V6-3.8L	231 CID	Base,Brougham	22049
1982	V6-3.8L	231 CID	Exc.A/C; Base,Base	22049
1978	V8-4.3L	260 CID		22049
1979	V8-4.3L	260 CID	Vista Cruiser	22049
1980-1981	V8-4.3L	260 CID	Base,Brougham	22049
1982	V8-4.3L	260 CID	Base	22049
1980	V8-5.0L	305 CID	A/C (Heavy Duty Cooling); Base,Base,Brougham	22045
1978	V8-5.0L	305 CID		22049
1979	V8-5.0L	305 CID	Vista Cruiser	22049
1982	V8-5.0L	305 CID	Base	22049
1981	V8-5.0L	307 CID	Exc.A/C; Base,Base,Brougham	22049
1982-1983	V8-5.0L	307 CID	Base	22049
1978-1979	V8-5.7L	350 CID		22045
1980	V8-5.7L	350 CID	Diesel; Exc.Heavy Duty Cooling; Base,Base,Brougham	22049
1981	V8-5.7L	350 CID	Diesel; Exc.Heavy Duty Cooling; Base,Base,Brougham	22049
1982-1983	V8-5.7L	350 CID	Diesel; Exc.Heavy Duty Cooling; Base,Base	22049
<b>CUTLASS SALON</b>				
1980	V6-3.8L	231 CID	Base,Brougham	22049
1981	V6-3.8L	231 CID	LS	22049
1985-1987	V6-3.8L	231 CID	Base	22049
1980	V8-4.3L	260 CID	Base,Brougham	22049
1981	V8-4.3L	260 CID	LS	22049
1980	V8-5.0L	305 CID	A/C (Heavy Duty Cooling); Base,Base,Brougham	22045
1985-1986	V8-5.0L	307 CID	442,Base	22049
1987	V8-5.0L	307 CID	Base	22049
1980	V8-5.7L	350 CID	Diesel; Exc.Heavy Duty Cooling; Base,Base,Brougham	22049
1981	V8-5.7L	350 CID	Diesel; Exc.Heavy Duty Cooling; LS,LS	22049
1985	V8-5.7L	350 CID	Diesel; Exc.Heavy Duty Cooling; Base,Base	22049
<b>CUTLASS SUPREME</b>				
1980	V6-3.8L	231 CID	Base,Brougham	22049
1981	V6-3.8L	231 CID	Base,Brougham,LS	22049
1982	V6-3.8L	231 CID	Exc.A/C; Base,Base,Brougham	22049
1983	V6-3.8L	231 CID	Exc.A/C; Brougham,Brougham	22049
1984	V6-3.8L	231 CID	Exc.A/C; Base,Base,Brougham	22049
1985	V6-3.8L	231 CID	Base,Brougham,LS	22049
1986	V6-3.8L	231 CID	Base,Brougham	22049
1987	V6-3.8L	231 CID	442,Base,Brougham	22049
1982-1984	V6-4.3L	260 CID	Diesel; Base,Brougham	22049
1980	V8-4.3L	260 CID	Base,Brougham	22049
1981	V8-4.3L	260 CID	Base,Brougham,LS	22049
1982	V8-4.3L	260 CID	Base,Brougham	22049
1980	V8-5.0L	305 CID	A/C (Heavy Duty Cooling); Base,Base,Brougham	22045
1982-1984	V8-5.0L	307 CID	Base,Brougham	22049

Years	Engine	Disp.	Application Description	USMW
1985	V8-5.0L	307 CID	Base,Brougham,LS	22049
1986	V8-5.0L	307 CID	Base,Brougham	22049
1987	V8-5.0L	307 CID	442,Base,Brougham	22049
1988	V8-5.0L	307 CID	Classic,Classic Brougham	22049
1980	V8-5.7L	350 CID	Diesel; Exc.Heavy Duty Cooling; Base,Base, Brougham	22049
1981	V8-5.7L	350 CID	Diesel; Exc.Heavy Duty Cooling; Base,Base, Brougham,LS	22049
1982-1984	V8-5.7L	350 CID	Diesel; Exc.Heavy Duty Cooling; Base,Base,Brougham	22049
1985	V8-5.7L	350 CID	Diesel; Base,Brougham,LS	22049
<b>DELMONT 88</b>				
1967	V8-5.4L	330 CID		22049
1968	V8-5.7L	350 CID		22049
1967	V8-7.0L	425 CID		22045
1968	V8-7.5L	455 CID		22045
<b>DELTA 88</b>				
1980-1981	V6-3.8L	231 CID	Base,Holiday,Royale,Royale Brougham	22049
1982-1983	V6-3.8L	231 CID	Base,Royale,Royale Brougham	22049
1984	V6-3.8L	231 CID	Royale,Royale Brougham,Royale Brougham LS	22049
1985	V6-3.8L	231 CID	Royale,Royale Brougham	22049
1980-1981	V8-4.3L	260 CID	Base,Holiday,Royale,Royale Brougham	22045
1982	V8-4.3L	260 CID	Base,Royale,Royale Brougham	22049
1980-1981	V8-5.0L	307 CID	Base,Holiday,Royale,Royale Brougham	22049
1982-1983	V8-5.0L	307 CID	Base,Royale,Royale Brougham	22049
1984-1985	V8-5.0L	307 CID	Royale,Royale Brougham,Royale Brougham LS	22049
1985	V8-5.7L	350 CID	Diesel; Royale,Royale Brougham,Royale Brougham LS	22045
1980	V8-5.7L	350 CID	Diesel; Exc.Heavy Duty Cooling; Base,Base,Holiday, Royale,Royale Brougham	22049
1981	V8-5.7L	350 CID	Diesel; Exc.Heavy Duty Cooling; Base,Base,Holiday, Royale,Royale Brougham	22049
1982-1983	V8-5.7L	350 CID	Diesel; Exc.Heavy Duty Cooling; Base,Base,Royale, Royale Brougham	22049
1984	V8-5.7L	350 CID	Diesel; Exc.Heavy Duty Cooling; Royale,Royale, Royale Brougham,Royale Brougham LS	22049
1965-1967	V8-7.0L	425 CID		22045
1968	V8-7.5L	455 CID		22045
<b>DYNAMIC 88</b>				
1961-1964	V8-6.5L	394 CID		22049
1965-1966	V8-7.0L	425 CID		22045
<b>F85</b>				
1966-1971	L6-4.1L	250 CID		22049
1964-1967	V8-5.4L	330 CID		22049
1968-1972	V8-5.7L	350 CID		22049
1970-1972	V8-7.5L	455 CID		22045
<b>JETSTAR</b>				
1964-1966	V8-5.4L	330 CID		22049
1964	V8-6.5L	394 CID		22049
1965	V8-7.0L	425 CID		22045
<b>OMEGA</b>				
1973-1976	L6-4.1L	250 CID		22049
1977-1979	V6-3.8L	231 CID		22043
1975-1977	V8-4.3L	260 CID		22049
1977-1979	V8-5.0L	305 CID		22049
1973-1976	V8-5.7L	350 CID		22045
1977	V8-5.7L	350 CID		22045
1978-1979	V8-5.7L	350 CID		22045
<b>STARFIRE</b>				
1978-1979	L4-2.5L	151 CID		22049
1980	L4-2.5L	151 CID	A/C; Base,Firenza,GT,SX	22049
1975	L6-3.8L	231 CID		22043
1976-1979	V6-3.8L	231 CID		22043
1980	V6-3.8L	231 CID	Exc.Heavy Duty Cooling; Base,Base,Firenza,GT,SX	22043
1977-1979	V8-5.0L	305 CID		22049
1961-1964	V8-6.5L	394 CID		22049
1965-1966	V8-7.0L	425 CID		22045
<b>SUPER 88</b>				
1960-1964	V8-6.5L	394 CID		22049

Years	Engine	Disp.	Application Description	USMW
<b>TORONADO</b>				
1981	V6-4.1L	252 CID	Brougham	22043
1982-1984	V6-4.1L	252 CID	Brougham	22049
1980-1981	V8-5.0L	307 CID	Brougham,XSC	22049
1982-1984	V8-5.0L	307 CID	Brougham	22049
1985	V8-5.0L	307 CID	Brougham,Caliente	22049
1979	V8-5.7L	350 CID		22045
1980	V8-5.7L	350 CID	Exc.Heavy Duty Cooling; Brougham,Brougham,XSC	22049
1981	V8-5.7L	350 CID	Diesel; Exc.Heavy Duty Cooling; Brougham, Brougham,XSC	22049
1982-1984	V8-5.7L	350 CID	Diesel; Exc.Heavy Duty Cooling; Brougham,Brougham	22049
1985	V8-5.7L	350 CID	Diesel; Exc.Heavy Duty Cooling; Brougham, Brougham,Caliente	22049
1977-1978	V8-6.6L	403 CID		22045
1966-1967	V8-7.0L	425 CID		22045
1968-1976	V8-7.5L	455 CID		22045
<b>VISTA CRUISER</b>				
1964-1967	V8-5.4L	330 CID		22049
1968-1977	V8-5.7L	350 CID		22045
1968-1969	V8-6.6L	400 CID		22049
1977	V8-6.6L	403 CID		22045
1970-1976	V8-7.5L	455 CID		22045
<b>PLYMOUTH</b>				
<b>ARROW</b>				
1979	L4-2.6L	156 CID		22092
1980	L4-2.6L	156 CID	Base,GS,GT	22092
<b>ARROW PICKUP</b>				
1980-1982	L4-2.0L	122 CID	Base,Sport	22092
1980-1982	L4-2.6L	156 CID	Base,Sport	22092
<b>ARROW-IMPORT</b>				
1979	L4-2.6L	155 CID		22092
<b>BARRACUDA</b>				
1970-1971	L6-3.2L	198 CID		22043
1964-1972	L6-3.7L	225 CID		22043
1968-1974	V8-5.2L	318 CID		22043
1968-1973	V8-5.6L	340 CID		22043
1974	V8-5.9L	360 CID		22043
1967-1971	V8-6.3L	383 CID		22043
1970-1971	V8-7.2L	440 CID		22043
<b>BELVEDERE</b>				
1960-1970	L6-3.7L	225 CID		22043
1958-1970	V8-5.2L	318 CID		22043
1959-1966	V8-5.9L	361 CID		22043
1960-1970	V8-6.3L	383 CID		22043
1965-1966	V8-6.3L	383 CID		22045
1967	V8-7.2L	440 CID		22043
<b>CARAVELLE (CAN)</b>				
1978-1979	L6-3.7L	225 CID		22026
1978-1979	V8-5.2L	318 CID		22026
1978-1979	V8-5.9L	360 CID		22043
<b>CONQUEST</b>				
1984-1986	L4-2.6L	156 CID	Base	22092
<b>DUSTER</b>				
1970-1974	L6-3.2L	198 CID		22043
1970-1976	L6-3.7L	225 CID		22043
1970-1976	V8-5.2L	318 CID		22043
1970-1973	V8-5.6L	340 CID		22043
1974-1976	V8-5.9L	360 CID		22043
<b>FURY</b>				
1960-1967	L6-3.7L	225 CID		22043
1968	L6-3.7L	225 CID	Suburban model	22043
1969-1978	L6-3.7L	225 CID		22043
1958-1968	V8-5.2L	318 CID		22043
1975-1978	V8-5.2L	318 CID	Sport model	22043
1960-1977	V8-5.2L	318 CID		22045
1971	V8-5.9L	360 CID	Sport model	22043
1977	V8-5.9L	360 CID		22043

**FAN CLUTCHES**

Years	Engine	Disp.	Application Description	USMW
1972-1978	V8-5.9L	360 CID		<b>22045</b>
1959-1963	V8-5.9L	361 CID		<b>22043</b>
1963-1967	V8-6.3L	383 CID		<b>22043</b>
1968	V8-6.3L	383 CID	VIP or Sport model	<b>22043</b>
1970	V8-6.3L	383 CID		<b>22043</b>
1960-1971	V8-6.3L	383 CID		<b>22045</b>
1972-1978	V8-6.6L	400 CID		<b>22026</b>
1967	V8-7.2L	440 CID		<b>22043</b>
1966-1978	V8-7.2L	440 CID		<b>22045</b>
<b>GRAN FURY</b>				
1980	L6-3.7L	225 CID	A/C; Base,Salon	<b>22043</b>
1981-1983	L6-3.7L	225 CID	A/C; Base,Base	<b>22043</b>
1972	V8-5.2L	318 CID	Suburban model	<b>22043</b>
1973	V8-5.2L	318 CID	Sport suburban model	<b>22043</b>
1975-1977	V8-5.2L	318 CID		<b>22043</b>
1982-1983	V8-5.2L	318 CID	A/C; Base,Base	<b>22043</b>
1981	V8-5.2L	318 CID	A/C; Base,Base	<b>22045</b>
1984-1987	V8-5.2L	318 CID	Max Cooling; Salon,Salon	<b>22045</b>
1988	V8-5.2L	318 CID	Max Cooling; Base,Base,Salon	<b>22045</b>
1989	V8-5.2L	318 CID	Max Cooling; Salon,Salon	<b>22045</b>
1980	V8-5.2L	318 CID	Max Cooling; Base,Base,Salon	<b>22054</b>
1973-1977	V8-5.9L	360 CID		<b>22043</b>
1972	V8-5.9L	360 CID		<b>22045</b>
1980	V8-5.9L	360 CID	Max Cooling; Base,Base,Salon	<b>22054</b>
1972-1977	V8-6.6L	400 CID		<b>22026</b>
1972-1977	V8-7.2L	440 CID		<b>22045</b>
<b>GTX</b>				
1967-1970	V8-7.2L	440 CID		<b>22043</b>
<b>PB100</b>				
1976-1979	L6-3.7L	225 CID		<b>22043</b>
1980	L6-3.7L	225 CID	A/C; Voyager,Voyager	<b>22043</b>
1976-1979	V8-5.2L	318 CID		<b>22043</b>
1980	V8-5.2L	318 CID	A/C; Voyager,Voyager	<b>22045</b>
1976-1978	V8-5.9L	360 CID		<b>22043</b>
<b>PB150</b>				
1982-1983	L6-3.7L	225 CID	Max Cooling; Voyager	<b>22026</b>
1981	L6-3.7L	225 CID	A/C; Voyager,Voyager	<b>22043</b>
1983	V8-5.2L	318 CID	Max Cooling (A/C); Voyager,Voyager	<b>22043</b>
1981	V8-5.2L	318 CID	A/C; Voyager,Voyager	<b>22045</b>
<b>PB200</b>				
1976-1978	L6-3.7L	225 CID		<b>22043</b>
1980	L6-3.7L	225 CID	A/C; Voyager,Voyager	<b>22043</b>
1976-1979	V8-5.2L	318 CID		<b>22043</b>
1980	V8-5.2L	318 CID	A/C; Voyager,Voyager	<b>22045</b>
1976-1979	V8-5.9L	360 CID		<b>22043</b>
1980	V8-5.9L	360 CID	A/C; Voyager,Voyager	<b>22045</b>
1976-1978	V8-6.6L	400 CID		<b>22043</b>
1976-1978	V8-7.2L	440 CID		<b>22045</b>
<b>PB250</b>				
1982-1983	L6-3.7L	225 CID	Max Cooling; Voyager	<b>22026</b>
1981	L6-3.7L	225 CID	A/C; Voyager,Voyager	<b>22043</b>
1982-1983	V8-5.2L	318 CID	Max Cooling (A/C); Voyager,Voyager	<b>22043</b>
1981	V8-5.2L	318 CID	A/C; Voyager,Voyager	<b>22045</b>
1981	V8-5.9L	360 CID	A/C; Voyager,Voyager	<b>22045</b>
<b>PB300</b>				
1976-1979	V8-5.2L	318 CID		<b>22043</b>
1980	V8-5.2L	318 CID	A/C; Voyager,Voyager	<b>22045</b>
1976-1979	V8-5.9L	360 CID		<b>22043</b>
1980	V8-5.9L	360 CID	A/C; Voyager,Voyager	<b>22045</b>
1976-1978	V8-6.6L	400 CID		<b>22043</b>
1976-1978	V8-7.2L	440 CID		<b>22045</b>
<b>PB350</b>				
1982-1983	V8-5.2L	318 CID	Max Cooling (A/C); Voyager,Voyager	<b>22043</b>
1981	V8-5.2L	318 CID	A/C; Voyager,Voyager	<b>22045</b>
1982-1983	V8-5.9L	360 CID	Max Cooling (A/C); Voyager,Voyager	<b>22043</b>
1981	V8-5.9L	360 CID	A/C; Voyager,Voyager	<b>22045</b>
<b>PLAZA</b>				
1958	V8-5.2L	318 CID		<b>22043</b>

Years	Engine	Disp.	Application Description	USMW
<b>ROADRUNNER</b>				
1968-1975	V8-5.2L	318 CID		<b>22043</b>
1971-1973	V8-5.6L	340 CID		<b>22043</b>
1974-1975	V8-5.9L	360 CID		<b>22043</b>
1968-1971	V8-6.3L	383 CID		<b>22043</b>
1972-1975	V8-6.6L	400 CID		<b>22026</b>
1969-1974	V8-7.2L	440 CID		<b>22043</b>
<b>SAPPORO</b>				
1980-1983	L4-2.6L	156 CID	Base	<b>22092</b>
<b>SAPPORO-IMPORT</b>				
1978-1979	L4-2.6L	155 CID		<b>22092</b>
<b>SATELLITE</b>				
1966-1974	L6-3.7L	225 CID		<b>22043</b>
1965-1974	V8-5.2L	318 CID		<b>22043</b>
1972	V8-5.6L	340 CID		<b>22043</b>
1974	V8-5.9L	360 CID		<b>22043</b>
1965-1966	V8-5.9L	361 CID		<b>22043</b>
1965-1971	V8-6.3L	383 CID		<b>22043</b>
1972-1974	V8-6.6L	400 CID		<b>22026</b>
1968-1974	V8-7.2L	440 CID		<b>22043</b>
<b>SAVOY</b>				
1960-1964	L6-3.7L	225 CID		<b>22043</b>
1958-1964	V8-5.2L	318 CID		<b>22043</b>
1959-1964	V8-5.9L	361 CID		<b>22043</b>
1960-1964	V8-6.3L	383 CID		<b>22043</b>
<b>SCAMP</b>				
1971-1974	L6-3.2L	198 CID		<b>22043</b>
1971-1976	L6-3.7L	225 CID		<b>22043</b>
1971-1976	V8-5.2L	318 CID		<b>22043</b>
<b>TRAILDUSTER</b>				
1980	L6-3.7L	225 CID	A/C; Base,Base	<b>22043</b>
1980-1981	V8-5.2L	318 CID	A/C; Base,Base	<b>22045</b>
1980-1981	V8-5.9L	360 CID	A/C; Base,Base	<b>22045</b>
<b>TRAILDUSTER 2WD</b>				
1975-1979	L6-3.7L	225 CID		<b>22043</b>
1974-1979	V8-5.2L	318 CID		<b>22043</b>
1974-1978	V8-5.9L	360 CID		<b>22043</b>
1976-1978	V8-6.6L	400 CID		<b>22043</b>
1974-1978	V8-7.2L	440 CID		<b>22054</b>
<b>TRAILDUSTER 4WD</b>				
1975-1978	L6-3.7L	225 CID		<b>22043</b>
1974-1979	V8-5.2L	318 CID		<b>22043</b>
1974-1979	V8-5.9L	360 CID		<b>22043</b>
1976-1978	V8-6.6L	400 CID		<b>22043</b>
1974-1978	V8-7.2L	440 CID		<b>22054</b>
<b>VALIANT</b>				
1970-1974	L6-3.2L	198 CID		<b>22043</b>
1962-1976	L6-3.7L	225 CID		<b>22043</b>
1968-1976	V8-5.2L	318 CID		<b>22043</b>
1976	V8-5.9L	360 CID		<b>22043</b>
<b>VALIANT (MEX)</b>				
1981	L6-3.7L	225 CID		<b>22043</b>
<b>VALIANT DUSTER (MEX)</b>				
1974-1976	L6-3.7L	225 CID		<b>22043</b>
<b>VALIANT SUPER BEE (MEX)</b>				
1969-1975	V8-5.2L	318 CID		<b>22043</b>
1974-1979	V8-5.9L	360 CID		<b>22043</b>
<b>VOLARE</b>				
1976-1979	L6-3.7L	225 CID		<b>22026</b>
1980	L6-3.7L	225 CID	A/C; Base	<b>22043</b>
1976-1979	V8-5.2L	318 CID		<b>22026</b>
1980	V8-5.2L	318 CID	Max Cooling; Base,Base	<b>22054</b>
1976-1979	V8-5.9L	360 CID		<b>22026</b>
1980	V8-5.9L	360 CID	Max Cooling; Base,Base	<b>22054</b>
<b>VOLARE (MEX)</b>				
1981-1982	L6-3.7L	225 CID		<b>22026</b>



Years	Engine	Disp.	Application Description	USMW
<b>VOYAGER</b>				
1974-1975	L6-3.7L	225 CID		22043
1974-1975	V8-5.2L	318 CID		22043
1974-1975	V8-5.9L	360 CID		22043
<b>PONTIAC</b>				
<b>ACADIAN (CAN)</b>				
1976-1979	L4-1.6L	98 CID		22013
<b>ASTRE</b>				
1977	L4-2.5L	151 CID		22049
<b>BONNEVILLE</b>				
1980	V6-3.8L	231 CID	Base	22043
1981	V6-3.8L	231 CID	Base,Brougham	22043
1982-1983	V6-3.8L	231 CID	Base,Brougham	22049
1984-1986	V6-3.8L	231 CID	Base,Brougham,LE	22049
1982	V6-4.1L	252 CID	Base,Brougham	22049
1986	V6-4.3L	262 CID	Base,Brougham,LE	22049
1980-1981	V8-4.3L	265 CID	Base,Brougham	22045
1977-1979	V8-4.9L	301 CID		22045
1980	V8-4.9L	301 CID	Base,Brougham,Safari	22045
1983	V8-5.0L	305 CID	Exc.A/C; Base,Base,Brougham	22049
1984	V8-5.0L	305 CID	Exc.A/C; Base,Base,Brougham,LE	22049
1985-1986	V8-5.0L	305 CID	Exc.A/C; Base,Base,Brougham,LE	22049
1981	V8-5.0L	307 CID	Base,Brougham,Safari	22049
1970-1979	V8-5.7L	350 CID		22045
1982-1983	V8-5.7L	350 CID	Diesel; Base,Brougham	22045
1984	V8-5.7L	350 CID	Diesel; Base,Brougham,LE	22045
1980	V8-5.7L	350 CID	Diesel; Exc.Heavy Duty Cooling; Base,Base, Brougham,Safari	22049
1981	V8-5.7L	350 CID	Diesel; Exc.Heavy Duty Cooling; Base,Base, Brougham,Safari	22049
1959-1966	V8-6.4L	389 CID		22045
1967-1978	V8-6.6L	400 CID		22045
1977-1979	V8-6.6L	403 CID		22045
1963-1966	V8-6.9L	421 CID		22045
1967-1969	V8-7.0L	428 CID		22045
1970-1976	V8-7.5L	455 CID		22045
<b>CATALINA</b>				
1977-1979	V6-3.8L	231 CID		22043
1980-1981	V6-3.8L	231 CID	Base	22043
1980-1981	V8-4.3L	265 CID	Base	22045
1977-1979	V8-4.9L	301 CID		22045
1980	V8-4.9L	301 CID	Base,Safari	22045
1981	V8-5.0L	307 CID	Base,Safari	22049
1970-1979	V8-5.7L	350 CID		22045
1980	V8-5.7L	350 CID	Diesel; Exc.Heavy Duty Cooling; Base,Base,Safari	22049
1981	V8-5.7L	350 CID	Diesel; Exc.Heavy Duty Cooling; Base,Base,Safari	22049
1959-1966	V8-6.4L	389 CID		22045
1967-1978	V8-6.6L	400 CID		22045
1977-1979	V8-6.6L	403 CID		22045
1963-1966	V8-6.9L	421 CID		22045
1967-1969	V8-7.0L	428 CID		22045
1970-1976	V8-7.5L	455 CID		22045
<b>EXECUTIVE</b>				
1966	V8-6.9L	421 CID		22045
1967-1969	V8-7.0L	428 CID		22045
1970	V8-7.5L	455 CID		22045
<b>FIREBIRD</b>				
1982-1984	L4-2.5L	151 CID	A/C; Base,S/E	22049
1985-1986	L4-2.5L	151 CID	A/C; Base	22049
1968-1976	L6-4.1L	250 CID		22049
1982-1984	V6-2.8L	173 CID	Base,S/E	22049
1977-1979	V6-3.8L	231 CID		22043
1980	V6-3.8L	231 CID	Exc.A/C; Base,Base,Esprit	22043
1981	V6-3.8L	231 CID	Exc.A/C; Base,Base,Esprit,Formula	22043
1981	V8-4.3L	265 CID	Base,Esprit,Formula	22045
1980-1981	V8-4.9L	301 CID	Base,Esprit,Formula,Trans Am	22043
1977-1979	V8-4.9L	301 CID		22045
1977-1979	V8-5.0L	305 CID		22045

Years	Engine	Disp.	Application Description	USMW
1980	V8-5.0L	305 CID	Base,Esprit,Formula,Trans Am	22045
1981	V8-5.0L	305 CID	Formula,Trans Am	22049
1982-1983	V8-5.0L	305 CID	Exc.Heavy Duty Cooling; Base,Base,S/E,Trans Am	22049
1984	V8-5.0L	305 CID	Exc.Heavy Duty Cooling; Base,Base,S/E,Trans Am	22049
1985	V8-5.0L	305 CID	Exc.Heavy Duty Cooling; Base,Base,S/E,Trans Am	22049
1967	V8-5.3L	326 CID		22049
1968-1979	V8-5.7L	350 CID		22045
1967-1979	V8-6.6L	400 CID		22045
1977-1979	V8-6.6L	403 CID		22045
1971-1974	V8-7.5L	455 CID		22045
<b>GRAND AM</b>				
1979	V6-3.8L	231 CID		22043
1978-1979	V8-4.9L	301 CID		22045
1980	V8-4.9L	301 CID	Base	22045
1978-1979	V8-5.0L	305 CID		22045
1980	V8-5.0L	305 CID	Heavy Duty Cooling; Base,Base	22045
1973-1975	V8-5.7L	350 CID		22045
1973-1975	V8-6.6L	400 CID		22045
1973-1975	V8-7.5L	455 CID		22045
<b>GRAND LEMANS</b>				
1975-1976	L6-4.1L	250 CID		22049
1980	V6-3.8L	229 CID	A/C; Base,Safari	22049
1977-1979	V6-3.8L	231 CID		22043
1980	V6-3.8L	231 CID	Base,Safari	22043
1981	V6-3.8L	231 CID	Base,Safari	22043
1976	V8-4.3L	260 CID		22043
1980	V8-4.3L	265 CID	Base,Safari	22045
1981	V8-4.3L	265 CID	Base,Safari	22045
1977-1979	V8-4.9L	301 CID		22043
1980	V8-4.9L	301 CID	Base,Safari	22045
1981	V8-4.9L	301 CID	Safari	22045
1977-1979	V8-5.0L	305 CID		22043
1980	V8-5.0L	305 CID	Heavy Duty Cooling; Base,Safari	22045
1975-1978	V8-5.7L	350 CID		22043
1975-1977	V8-6.6L	400 CID		22045
1977	V8-6.6L	403 CID		22045
1975-1976	V8-7.5L	455 CID		22045
<b>GRAND LEMANS (CAN)</b>				
1977	L6-4.1L	250 CID		22049
1978-1979	V6-3.3L	200 CID		22049
1979	V8-4.4L	267 CID		22045
1976	V8-5.0L	305 CID		22043
1976-1977	V8-5.7L	350 CID		22043
<b>GRAND PRIX</b>				
1978-1979	V6-3.8L	231 CID		22043
1980	V6-3.8L	231 CID	Base,LJ	22043
1981	V6-3.8L	231 CID	Base,Brougham,LJ	22043
1982-1983	V6-3.8L	231 CID	Base,Brougham,LJ	22049
1984-1987	V6-3.8L	231 CID	Base,Brougham,LE	22049
1982	V6-4.1L	252 CID	Base,Brougham,LJ	22049
1986-1987	V6-4.3L	262 CID	Base,Brougham,LE	22049
1980	V8-4.3L	265 CID	Base,LJ	22045
1981	V8-4.3L	265 CID	Base,Brougham,LJ	22045
1977-1979	V8-4.9L	301 CID		22045
1980	V8-4.9L	301 CID	Base,LJ,SJ	22045
1978-1979	V8-5.0L	305 CID		22045
1980	V8-5.0L	305 CID	Heavy Duty Cooling; Base,Base,LJ,SJ	22045
1983	V8-5.0L	305 CID	Base,Brougham,LJ	22045
1984	V8-5.0L	305 CID	Base,Brougham,LE	22045
1985-1987	V8-5.0L	305 CID	Exc.A/C; Base,Base,Brougham,LE	22049
1976-1977	V8-5.7L	350 CID		22045
1981-1983	V8-5.7L	350 CID	Diesel; Exc.Heavy Duty Cooling; Base,Base, Brougham,LJ	22049
1984	V8-5.7L	350 CID	Diesel; Exc.Heavy Duty Cooling; Base,Base, Brougham,LE	22049
1962-1966	V8-6.4L	389 CID		22045
1967-1977	V8-6.6L	400 CID		22045
1977	V8-6.6L	403 CID		22045
1963-1966	V8-6.9L	421 CID		22045

Years	Engine	Disp.	Application Description	USMW
1967-1969	V8-7.0L	428 CID		22045
1970-1976	V8-7.5L	455 CID		22045
<b>GRAND SAFARI S/W</b>				
1979	V6-3.8L	231 CID		22043
1977-1979	V8-4.9L	301 CID		22043
1979	V8-5.0L	305 CID		22043
1977	V8-5.7L	350 CID		22043
1976-1978	V8-6.6L	400 CID		22045
1973-1975	V8-6.6L	400 CID		22049
1977-1978	V8-6.6L	403 CID		22045
1972-1976	V8-7.5L	455 CID		22045
<b>GRANDVILLE</b>				
1973-1975	V8-6.6L	400 CID		22049
1971-1975	V8-7.5L	455 CID		22045
<b>GTO</b>				
1964-1966	V8-6.4L	389 CID		22045
1967-1972	V8-6.6L	400 CID		22045
1970-1972	V8-7.5L	455 CID		22045
<b>LAURENTIAN (CAN)</b>				
1977-1979	L6-4.1L	250 CID		22049
1977-1979	V8-5.0L	305 CID		22049
1976-1979	V8-5.7L	350 CID		22043
1976	V8-6.6L	400 CID		22045
1976	V8-7.5L	455 CID		22045
<b>LEMANS</b>				
1968-1976	L6-4.1L	250 CID		22045
1970	L6-4.1L	250 CID		22049
1980	V6-3.8L	229 CID	A/C, Base, Safari	22049
1977-1979	V6-3.8L	231 CID		22043
1980	V6-3.8L	231 CID	Base, Safari	22043
1981	V6-3.8L	231 CID	Base, Safari	22043
1976	V8-4.3L	260 CID		22043
1980-1981	V8-4.3L	265 CID	Base, Safari	22045
1977-1979	V8-4.9L	301 CID		22045
1980	V8-4.9L	301 CID	Base, Safari	22045
1981	V8-4.9L	301 CID	Safari	22045
1977-1979	V8-5.0L	305 CID		22045
1980	V8-5.0L	305 CID	Heavy Duty Cooling; Base, Base, Safari	22045
1968-1979	V8-5.7L	350 CID		22045
1964-1965	V8-6.4L	389 CID		22045
1970-1977	V8-6.6L	400 CID		22045
1977	V8-6.6L	403 CID		22045
1970-1976	V8-7.5L	455 CID		22045
<b>LEMANS (CAN)</b>				
1979	V8-4.4L	267 CID		22049
1976-1977	V8-5.7L	350 CID		22045
<b>PARISIENNE</b>				
1984	V6-3.8L	231 CID	Base, Brougham	22049
1985	V6-4.3L	262 CID	Exc. A/C; Base, Base, Brougham	22049
1986	V6-4.3L	262 CID	Exc. A/C; Base, Base, Brougham	22049
1983-1984	V8-5.0L	305 CID	Exc. A/C; Base, Base, Brougham	22049
1985	V8-5.0L	305 CID	Exc. A/C; Base, Base, Brougham	22049
1986	V8-5.0L	305 CID	Exc. A/C; Base, Base, Brougham	22049
1986	V8-5.0L	307 CID	Base, Brougham	22049
1983-1985	V8-5.7L	350 CID	Diesel; Exc. Heavy Duty Cooling; Base, Base, Brougham	22049
<b>PARISIENNE (CAN)</b>				
1977-1979	L6-4.1L	250 CID		22049
1977-1979	V8-5.0L	305 CID		22049
1976-1979	V8-5.7L	350 CID		22043
1976	V8-6.6L	400 CID		22045
1976	V8-7.5L	455 CID		22045
<b>PHOENIX</b>				
1977-1978	L4-2.5L	151 CID		22049
1977-1979	V6-3.8L	231 CID		22043
1977-1979	V8-5.0L	305 CID		22049
1977-1979	V8-5.7L	350 CID		22049
<b>SAFARI</b>				
1987-1989	V8-5.0L	307 CID	Base	22049

Years	Engine	Disp.	Application Description	USMW
<b>SAFARI S/W</b>				
1980	V8-4.3L	265 CID		22043
1980	V8-4.9L	301 CID		22043
1980	V8-5.0L	305 CID		22043
<b>SAFARI WAGON</b>				
1960-1965	V8-6.4L	389 CID		22045
1963-1965	V8-6.9L	421 CID		22045
<b>STAR CHIEF</b>				
1959-1966	V8-6.4L	389 CID		22045
1963-1966	V8-6.9L	421 CID		22045
<b>SUNBIRD</b>				
1977-1979	L4-2.5L	151 CID		22049
1980	L4-2.5L	151 CID	A/C; Base	22049
1980	V6-3.8L	231 CID	Exc. Heavy Duty Cooling; Base, Base	22043
1978-1979	V8-5.0L	305 CID		22049
<b>T1000</b>				
1981-1987	L4-1.6L	98 CID	A/C; Base	22013
<b>TEMPEST</b>				
1968-1970	L6-4.1L	250 CID		22049
1968-1970	V8-5.7L	350 CID		22045
1970	V8-6.6L	400 CID		22045
<b>TRANS AM</b>				
1979	V8-4.9L	301 CID		22045
1972-1974	V8-5.7L	350 CID		22045
1972-1979	V8-6.6L	400 CID		22045
1977-1979	V8-6.6L	403 CID		22045
1972-1976	V8-7.5L	455 CID		22045
<b>VENTURA</b>				
1977	L4-2.5L	151 CID		22049
1971-1976	L6-4.1L	250 CID		22049
1977	V6-3.8L	231 CID		22043
1975-1976	V8-4.3L	260 CID		22045
1977	V8-4.9L	301 CID		22045
1977	V8-5.0L	305 CID		22045
1971-1972	V8-5.0L	307 CID		22045
1972-1977	V8-5.7L	350 CID		22045
1960-1961	V8-6.4L	389 CID		22045
<b>RAM</b>				
<b>1500</b>				
2011	V8-4.7L	285 CID	SLT, ST	22150
2011	V8-5.7L	345 CID	Laramie, Laramie Longhorn, SLT, Sport, ST, Tradesman	22059
<b>DAKOTA</b>				
2011	V6-3.7L	226 CID	Big Horn, Laramie, ST	22170
2011	V8-4.7L	285 CID	Heavy Duty Cooling; Big Horn, Big Horn, Laramie, TRX4	22170
<b>SAAB</b>				
<b>9-7X</b>				
2005	L6-4.2L	256 CID	Linear	22310
2006	L6-4.2L	256 CID	4.2i	22310
2007	L6-4.2L	256 CID	Electric; 4.2i	22330
2008-2009	L6-4.2L	256 CID	4.2i, 4.2i	22627
2005	V8-5.3L	323 CID	Arc	22310
2006	V8-5.3L	325 CID	5.3i	22310
2007	V8-5.3L	325 CID	Electric; 5.3i	22330
2008-2009	V8-5.3L	325 CID	5.3i, 5.3i	22627
2008-2009	V8-6.0L	364 CID	Aero	22627
2008-2009	V8-6.0L	5967cc	Aero	22330
<b>SUBARU</b>				
<b>DL</b>				
1985-1989	H4-1.8L	1781cc	Base	22405
<b>GL</b>				
1985-1986	H4-1.8L	1781cc	Base, Turbo	22405
1987	H4-1.8L	1781cc	Base	22405
1988-1989	H4-1.8L	1781cc	Base, Turbo	22405
<b>GL-10</b>				
1985	H4-1.8L	1781cc	Base	22405
1986-1989	H4-1.8L	1781cc	Base, Turbo	22405

Years	Engine	Disp.	Application Description	USMW
<b>LOYALE</b>				
1990	H4-1.8L	1781cc	RS Turbo,Turbo	22405
1991-1994	H4-1.8L	1781cc	Base	22405
<b>RX</b>				
1986-1989	H4-1.8L	1781cc	Turbo	22405
<b>STANDARD</b>				
1987	H4-1.8L	1781cc	Base	22405
<b>XT</b>				
1988	H4-1.8L	1781cc	DL,GL	22405
1989-1991	H4-1.8L	1781cc	GL	22405
1985	H4-1.8L	1781cc	DL,GL,GL-10 Turbo	22406
1986	H4-1.8L	1781cc	To 04/86; DL,DL,GL,GL-10 Turbo	22406
1987	H4-1.8L	1781cc	To 04/86; DL,DL,GL,GL-10,GL-10 Turbo	22406
1988	H6-2.7L	2672cc	XT6	22405
<b>SUZUKI</b>				
<b>EQUATOR</b>				
2009-2012	L4-2.5L	2500cc	Base,Premium	22182
2009	V6-4.0L	3954cc	Base,RMZ-4,Sport	22182
2010-2012	V6-4.0L	3954cc	RMZ-4,Sport	22182
<b>GRAND VITARA</b>				
1999	V6-2.5L	2500cc	JLX,JLX Plus,JS,JS Plus	22033
2000	V6-2.5L	2500cc	JLS,JLS Plus,JLX,JLX Plus,Limited	22033
2001	V6-2.5L	2500cc	JLS,JLS Plus,JLS Plus SE,JLX,JLX Plus,JLX Plus SE, Limited	22033
2002	V6-2.5L	2500cc	JLS,JLX,Limited	22033
2003	V6-2.5L	2500cc	Base	22033
2004-2005	V6-2.5L	2500cc	EX,LX	22033
2001	V6-2.7L	2737cc	XL-7,XL-7 Limited,XL-7 Plus,XL-7 Touring	22033
<b>SAMURAI</b>				
1990	L4-1.3L	1298cc	JL	22068
1991	L4-1.3L	1298cc	JA,JL,JS	22068
1992-1993	L4-1.3L	1298cc	JA,JL	22068
1994-1995	L4-1.3L	1298cc	JL	22068
1986-1987	L4-1.3L	1325cc	JA,JX,JX SE	22068
1988	L4-1.3L	1325cc	JA,JX	22068
1989	L4-1.3L	1325cc	Base	22068
<b>SIDEKICK</b>				
1989	L4-1.3L	1325cc	JA	22068
1989	L4-1.6L	1590cc	JLX,JX	22068
1990	L4-1.6L	1590cc	JLX,JS,JX	22068
1991	L4-1.6L	1590cc	JL,JLX,JS,JX	22068
1992-1995	L4-1.6L	1590cc	JLX,JS,JX	22068
1996-1998	L4-1.6L	1590cc	JS,JX	22068
1996	L4-1.8L	1840cc	JLX Sport,JX Sport	22033
1997-1998	L4-1.8L	1840cc	JLX Sport,JS Sport,JX Sport	22033
<b>VITARA</b>				
1999	L4-1.6L	1590cc	JS,JS Plus,JX,JX Plus	22068
2000-2001	L4-1.6L	1590cc	JLS,JLX,JS,JX	22068
1999	L4-2.0L	2000cc	JS,JS Plus,JX,JX Plus	22033
2000-2001	L4-2.0L	2000cc	JLS,JLX,JS,JX	22033
2002	L4-2.0L	2000cc	JLS,JLX	22033
2003	L4-2.0L	2000cc	Base	22033
2004	V6-2.5L	2500cc	LX	22033
<b>X-90</b>				
1996-1997	L4-1.6L	1590cc	Base	22068
1998	L4-1.6L	1590cc	Base,SE	22068
<b>XL-7</b>				
2002	V6-2.7L	2700cc	Base,Limited,Plus,Touring	22033
2003	V6-2.7L	2700cc	Limited,Touring	22033
2004	V6-2.7L	2700cc	EX,LX	22033
2005	V6-2.7L	2737cc	EX,LX	22033
2006	V6-2.7L	2737cc	Base,Premium	22033
<b>TOYOTA</b>				
<b>4RUNNER</b>				
1984	L4-2.4L	2366cc	RWD (Manual Trans); DLX,DLX,SR5	22081
1985-1989	L4-2.4L	2366cc	DLX,SR5	22081
1990-1995	L4-2.4L	2366cc	SR5	22081

Years	Engine	Disp.	Application Description	USMW
1996-1997	L4-2.7L	2694cc	Base	22020
1998-2000	L4-2.7L	2694cc	Base,Limited,SR5	22020
2010	L4-2.7L	2694cc	SR5	22020
1995	V6-3.0L	2959cc	SR5	22021
1988	V6-3.0L	2959cc	SR5	22076
1989	V6-3.0L	2959cc	DLX,SR5	22076
1990-1994	V6-3.0L	2959cc	SR5	22076
1996-2000	V6-3.4L	3378cc	Limited,SR5	22021
2001-2002	V6-3.4L	3378cc	Base,Limited,SR5	22021
2003-2009	V6-4.0L	3956cc	Limited,Sport,SR5	22407
2010-2013	V6-4.0L	3956cc	Limited,SR5,Trail	22407
2003-2004	V8-4.7L	4663cc	Limited,Sport,SR5	22184
2005	V8-4.7L	4663cc	From 11/04; Limited,Limited,Sport,SR5	22185
2006-2009	V8-4.7L	4663cc	Limited,Sport,SR5	22185
<b>CARINA</b>				
1972-1973	L4-1.6L	1588cc		22080
<b>CELICA</b>				
1975-1979	L4-2.2L	2189cc		22081
1980	L4-2.2L	2189cc	Manual Trans; GT,GT,ST	22081
1981-1982	L4-2.4L	2366cc	Manual Trans; GT,GT,ST	22081
1983-1985	L4-2.4L	2366cc	Manual Trans; GT,GT,GTS,ST	22081
1980	L6-2.6L	2563cc	Supra	22085
1982-1986	L6-2.8L	2754cc	Supra	22085
1981	L6-2.8L	2759cc	Supra	22085
<b>COROLLA</b>				
1979	L4-1.2L	1166cc		22080
1983	L4-1.6L	1587cc	Base,DLX,SR5	22080
1984	L4-1.6L	1587cc	Sport DLX,Sport SR5	22080
1985-1987	L4-1.6L	1587cc	Sport DLX,Sport GTS,Sport SR5	22080
1971-1979	L4-1.6L	1588cc		22080
1980-1982	L4-1.8L	1770cc	Base,DLX,SR5	22080
<b>CORONA</b>				
1976-1979	L4-2.2L	2189cc		22081
1980	L4-2.2L	2189cc	Manual Trans; DLX,DLX,LE	22081
1975	L4-2.2L	2200cc		22081
1981-1982	L4-2.4L	2366cc	Manual Trans; DLX,DLX,LE	22081
<b>CRESSIDA</b>				
1978-1979	L6-2.6L	2563cc		22085
1980	L6-2.6L	2563cc	Base	22085
1983-1988	L6-2.8L	2754cc	Luxury	22085
1981-1982	L6-2.8L	2759cc	Luxury	22085
1989-1992	L6-3.0L	2954cc	Towing Package; Luxury,Luxury	22085
<b>FJ CRUISER</b>				
2007	V6-4.0L	3956cc	Base,TRD Special Edition	22407
2008	V6-4.0L	3956cc	Base,Trail Teams Special Edition	22407
2009-2013	V6-4.0L	3956cc	Base	22407
<b>LAND CRUISER</b>				
1988-1989	L6-4.0L	3956cc	Base	22076
1990	L6-4.0L	3956cc	To 01/90; Base,Base	22076
1991-1992	L6-4.0L	3956cc	Base	22076
1976-1979	L6-4.2L	4227cc		22076
1980	L6-4.2L	4227cc	Base,Base	22076
1981-1987	L6-4.2L	4227cc	Base	22076
1993-1997	L6-4.5L	4477cc	Base	22074
1998-2004	V8-4.7L	4663cc	Base	22183
2005	V8-4.7L	4663cc	From 05/05; Base,Base	22185
2006-2007	V8-4.7L	4663cc	Base	22185
2008-2013	V8-5.7L	CID	Base	22408
<b>LAND CRUISER 4WD</b>				
1975	L6-4.2L	4230cc		22076
<b>PICKUP</b>				
1981-1982	L4-2.2L	2188cc	Diesel; DLX	22081
1983	L4-2.2L	2188cc	Diesel; DLX,SR5	22081
1980	L4-2.2L	2189cc	Base,DLX,SR5	22081
1981-1982	L4-2.4L	2366cc	Base,DLX,SR5	22081
1983-1984	L4-2.4L	2366cc	RWD (Manual Trans); Base,Base,DLX,SR5	22081
1985	L4-2.4L	2366cc	Base,Base,DLX,SR5,SR5 Turbo	22081
1986-1987	L4-2.4L	2366cc	Base,Base,Base Turbo,DLX,SR5,SR5 Turbo	22081

Years	Engine	Disp.	Application Description	USMW
1988	L4-2.4L	2366cc	Base,Base,DLX,SR5,SR5 Turbo	22081
1989-1990	L4-2.4L	2366cc	RWD (Manual Trans); Base,Base,DLX,SR5	22081
1991	L4-2.4L	2366cc	RWD (Manual Trans); Base,Base,DLX	22081
1992	L4-2.4L	2366cc	RWD (Manual Trans); Base,Base,DLX,SR5	22081
1993	L4-2.4L	2366cc	RWD (Manual Trans); Base,Base,DLX,SR5	22401
1994-1995	L4-2.4L	2366cc	RWD (Manual Trans); Base,Base,DLX	22401
1984	L4-2.4L	2446cc	Diesel; DLX	22081
1985	L4-2.4L	2446cc	Diesel; DLX,DLX Turbo	22404
1988-1993	V6-3.0L	2959cc	Base,DLX,SR5	22076
1994-1995	V6-3.0L	2959cc	DLX,SR5	22076
<b>PICKUP 2WD</b>				
1975-1979	L4-2.2L	2189cc		22081
<b>PICKUP 4WD</b>				
1979	L4-2.2L	2189cc		22081
<b>PREVIA</b>				
1991-1997	L4-2.4L	2438cc	DX,LE	22075
<b>SEQUOIA</b>				
2010-2011	V8-4.6L	4608cc	Limited,SR5	22408
2012	V8-4.6L	4608cc	SR5	22408
2001-2004	V8-4.7L	4663cc	Limited,SR5	22184
2005-2009	V8-4.7L	4663cc	Limited,SR5	22185
2008-2013	V8-5.7L	CID	Limited,Platinum,SR5	22408
<b>SUPRA</b>				
1979	L6-2.6L	2563cc		22085
1986	L6-3.0L	2954cc	Base	22085
1987	L6-3.0L	2954cc	To 03/87; Base,Turbo	22085
1988-1992	L6-3.0L	2954cc	Base,Turbo	22085
1993-1998	L6-3.0L	2997cc	Base,Twin Turbo	22402
<b>T100</b>				
1994-1998	L4-2.7L	2694cc	Base	22020
1993	V6-3.0L	2959cc	Base,One-Ton,SR5	22076
1994	V6-3.0L	2959cc	SR5	22076
1995	V6-3.4L	3378cc	Base,DX,One-Ton,DLX,SR5	22021
1996-1997	V6-3.4L	3378cc	DLX,SR5	22021
1998	V6-3.4L	3378cc	Base,SR5	22021
<b>TACOMA</b>				
1995-1997	L4-2.4L	2438cc	DLX	22020
1998-1999	L4-2.4L	2438cc	DLX,Pre Runner,SR5	22020
2000	L4-2.4L	2438cc	DLX,Limited,Pre Runner,SR5	22020
2001-2003	L4-2.4L	2438cc	DLX,Pre Runner	22020
2004	L4-2.4L	2438cc	Base	22020
1995-1997	L4-2.7L	2694cc	DLX	22020
1998-1999	L4-2.7L	2694cc	DLX,Pre Runner,SR5	22020
2000	L4-2.7L	2694cc	DLX,Limited,Pre Runner,SR5	22020
2001-2003	L4-2.7L	2694cc	DLX,Pre Runner	22020
2004-2013	L4-2.7L	2694cc	Base,Pre Runner	22020
1995-1997	V6-3.4L	3378cc	DLX,SR5	22021
1998-2000	V6-3.4L	3378cc	DLX,Limited,Pre Runner,SR5	22021
2001-2003	V6-3.4L	3378cc	Towing Package; DLX,DLX,Pre Runner,S-Runner	22021
2004	V6-3.4L	3378cc	Towing Package; Base,Base,Pre Runner,S-Runner	22021
2005-2013	V6-4.0L	3956cc	Base,Pre Runner,X-Runner	22407
<b>TUNDRA</b>				
2000-2004	V6-3.4L	3378cc	Base,SR5	22021
2005-2010	V6-4.0L	3956cc	Base,SR5	22407
2011	V6-4.0L	3956cc	To 10/2010; Base,Base,SR5	22407
2012-2013	V6-4.0L	3956cc	Base	22407
2010	V8-4.6L	4608cc	Base,Limited,SR5	22408
2011	V8-4.6L	4608cc	Base,SR5	22408
2012-2013	V8-4.6L	4608cc	Base	22408
2000-2002	V8-4.7L	4663cc	Limited,SR5	22177
2003-2004	V8-4.7L	4663cc	Limited,SR5	22184
2005-2009	V8-4.7L	4663cc	Base,Limited,SR5	22185
2007-2011	V8-5.7L	CID	Base,Limited,SR5	22408
2012	V8-5.7L	CID	Base,Limited	22408
2013	V8-5.7L	CID	Base,Limited,Platinum	22408
<b>VAN</b>				
1984-1985	L4-2.0L	1998cc	Wagon Crg,Wagon DX,Wagon LE	22086
1986-1987	L4-2.2L	2237cc	Wagon Crg,Wagon DX,Wagon LE	22086

Years	Engine	Disp.	Application Description	USMW
1988	L4-2.2L	2237cc	RWD; Wagon Crg,Wagon Crg,Wagon DX,Wagon LE	22086
1989	L4-2.2L	2237cc	RWD; Wagon Crg,Wagon Crg,Wagon DX,Wagon LE	22086
<b>VOLKSWAGEN</b>				
<b>PASSAT</b>				
1998	L4-1.8L	1781cc	GLS	22302
1999-2002	L4-1.8L	1781cc	GLS,GLX	22302
2003	L4-1.8L	1781cc	GL,GLS,GLX	22302
2004-2005	L4-1.8L	1781cc	GL,GLS,GLS 4 Motion	22302
2004	L4-2.0L	1967cc	Diesel; GL,GLS	22302
2005	L4-2.0L	1967cc	Diesel; GL TDI,GLS	22302
1998-1999	V6-2.8L	2771cc	GLS,GLX	22303
2000	V6-2.8L	2771cc	4 Motion,GLS,GLX	22303
2001-2002	V6-2.8L	2771cc	GLS,GLS 4 Motion,GLX,GLX 4 Motion	22303
2003-2004	V6-2.8L	2771cc	GL,GLS,GLX,GLX 4 Motion	22303
2005	V6-2.8L	2771cc	GLS,GLS 4 Motion,GLX,GLX 4 Motion	22303
<b>VOLVO</b>				
<b>142</b>				
1970-1973	L4-2.0L	1986cc		22030
1974	L4-2.0L	1986cc	S model	22030
<b>142GL</b>				
1974	L4-2.0L	1986cc		22030
<b>142S</b>				
1969	L4-2.0L	1986cc		22030
<b>144</b>				
1970-1974	L4-2.0L	1986cc		22030
<b>144GL</b>				
1974	L4-2.0L	1986cc		22030
<b>144S</b>				
1969	L4-2.0L	1986cc		22030
<b>145</b>				
1970-1974	L4-2.0L	1986cc		22030
<b>145S</b>				
1969	L4-2.0L	1986cc		22030
<b>164</b>				
1970-1975	L6-3.0L	2980cc		22030
<b>164E</b>				
1973-1974	L6-3.0L	2980cc		22030
<b>240</b>				
1990	L4-2.3L	2316cc	Base,DL	22030
1991	L4-2.3L	2316cc	Base,SE	22030
1992-1993	L4-2.3L	2316cc	Base	22030
<b>242</b>				
1976-1979	L4-2.1L	2127cc		22030
1980	L4-2.1L	2127cc	DL	22030
1981	L4-2.1L	2127cc	DL,GL,GLT,Turbo	22030
1982	L4-2.1L	2127cc	DL,GLT	22030
1983-1984	L4-2.1L	2127cc	GLT	22030
1983-1984	L4-2.3L	2316cc	DL	22030
<b>242GL</b>				
1975	L4-2.0L	1986cc		22030
<b>244</b>				
1976-1979	L4-2.1L	2127cc		22030
1980-1981	L4-2.1L	2127cc	DL	22030
1982	L4-2.1L	2127cc	DL,GL,GLT	22030
1983	L4-2.1L	2127cc	GLT	22030
1984	L4-2.1L	2127cc	Base	22030
1985	L4-2.1L	2127cc	Turbo	22030
1983	L4-2.3L	2316cc	DL	22030
1984-1989	L4-2.3L	2316cc	DL,GL	22030
1982	L6-2.4L	2383cc	Diesel; DL,GL	22030
1983	L6-2.4L	2383cc	Diesel; GL	22030
1984	L6-2.4L	2383cc	Diesel; DL,GL	22030
<b>245</b>				
1975	L4-2.0L	1986cc		22030
1976-1979	L4-2.1L	2127cc		22030
1980	L4-2.1L	2127cc	DL	22030





USMW	Years	Cyl.	Specifications
22010	1983-1988	L4-2.0L	FORD RANGER
	1983-1997	L4-2.3L	FORD RANGER
	1986-1987	L4-2.3L	FORD AEROSTAR
	1998-2001	L4-2.5L	FORD RANGER
	1998-2001	L4-2.5L	MAZDA B2500
22011	1961	L6-2.4L	FORD FALCON RANCHERO
	1961-1964	L6-2.4L	FORD FALCON
	1961	L6-2.8L	FORD FALCON RANCHERO
	1961-1969	L6-2.8L	FORD FALCON
	1970-1972	L6-2.8L	FORD MAVERICK
	1964-1970	L6-3.3L	FORD FALCON
	1964-1977	L6-3.3L	MERCURY COMET
	1968	L6-3.3L	FORD FAIRLANE
	1968	L6-3.3L	MERCURY MONTEGO
	1970-1977	L6-3.3L	FORD MAVERICK
	1975-1977	L6-3.3L	MERCURY MONARCH
	1975-1982	L6-3.3L	FORD GRANADA
	1978-1982	L6-3.3L	MERCURY ZEPHYR
	1979	L6-3.3L	MERCURY CAPRI
	1980-1981	L6-3.3L	MERCURY COUGAR
	1983	L6-3.3L	MERCURY MARQUIS
	1967-1972	L6-3.9L	FORD CUSTOM
	1975	L6-3.9L	FORD F100 1/2 TON
	1975-1976	L6-3.9L	FORD F150 1/2 TON
	1965	L6-4.1L	CHEVROLET IMPALA SS
	1966-1968	L6-4.1L	CHEVROLET IMPALA
	1967	L6-4.1L	CHEVROLET CHEVY II
	1967-1968	L6-4.1L	CHEVROLET CHEVELLE
	1967-1968	L6-4.1L	CHEVROLET NOVA
	1968	L6-4.1L	BUICK SPECIAL
	1968	L6-4.1L	CHEVROLET EL CAMINO
	1968	L6-4.1L	CHEVROLET MALIBU
	1969-1970	L6-4.1L	FORD FAIRLANE
	1969-1973	L6-4.1L	FORD MUSTANG
	1969-1974	L6-4.1L	FORD TORINO
	1969-1974	L6-4.1L	MERCURY MONTEGO
	1969-1977	L6-4.1L	MERCURY COMET
	1970	L6-4.1L	FORD FALCON
	1970-1977	L6-4.1L	FORD MAVERICK
	1975-1979	L6-4.1L	FORD GRANADA
	1975-1979	L6-4.1L	MERCURY MONARCH
	1975-1979	L6-4.9L	FORD F100 1/2 TON
	1975-1979	L6-4.9L	FORD F150 1/2 TON
	1987-1991	L6-4.9L	FORD BRONCO
	1963	V8-3.6L	FORD FALCON
	1967	V8-4.1L	CHEVROLET CHEVELLE
	1980	V8-4.2L	MERCURY MONARCH
	1980-1981	V8-4.2L	FORD GRANADA
	1980-1982	V8-4.2L	FORD FAIRMONT
	1980-1982	V8-4.2L	FORD THUNDERBIRD
	1980-1982	V8-4.2L	MERCURY COUGAR
	1980-1982	V8-4.2L	MERCURY ZEPHYR
	1981-1982	V8-4.2L	FORD LTD
	1981-1982	V8-4.2L	MERCURY CAPRI
	1981-1982	V8-4.2L	MERCURY GRAND MARQUIS
	1981-1982	V8-4.2L	MERCURY MARQUIS
	1963-1964	V8-4.3L	FORD FALCON
	1959-1967	V8-4.6L	CHEVROLET EL CAMINO
	1959-1967	V8-4.6L	CHEVROLET IMPALA
	1964-1966	V8-4.6L	CHEVROLET MALIBU
1964-1967	V8-4.6L	CHEVROLET CHEVELLE	
1964-1967	V8-4.6L	CHEVROLET CHEVY II	
1964-1967	V8-4.6L	CHEVROLET NOVA	
1966-1967	V8-4.6L	CHEVROLET CAPRICE	
1963-1968	V8-4.7L	FORD FAIRLANE	
1964-1967	V8-4.7L	MERCURY COMET	
1964-1968	V8-4.7L	FORD CUSTOM	
1964-1968	V8-4.7L	FORD MUSTANG	
1965-1966	V8-4.7L	MERCURY CYCLONE	

USMW	Years	Cyl.	Specifications
	1965-1968	V8-4.7L	FORD FALCON
	1965-1968	V8-4.7L	FORD LTD
	1966-1968	V8-4.7L	FORD BRONCO
	1967-1968	V8-4.7L	MERCURY COUGAR
	1968	V8-4.7L	FORD TORINO
	1968	V8-5.0L	CHEVROLET NOVA
	1968-1969	V8-5.0L	MERCURY CYCLONE
	1968-1970	V8-5.0L	FORD FAIRLANE
	1968-1970	V8-5.0L	FORD FALCON
	1968-1972	V8-5.0L	FORD CUSTOM
	1968-1974	V8-5.0L	FORD TORINO
	1968-1974	V8-5.0L	MERCURY MONTEGO
	1968-1977	V8-5.0L	MERCURY COMET
	1968-1979	V8-5.0L	FORD MUSTANG
	1968-1985	V8-5.0L	MERCURY COUGAR
	1968-1986	V8-5.0L	FORD LTD
	1968-1991	V8-5.0L	FORD BRONCO
	1971-1977	V8-5.0L	FORD MAVERICK
	1975-1979	V8-5.0L	FORD F100 1/2 TON
	1975-1980	V8-5.0L	FORD GRANADA
	1975-1980	V8-5.0L	MERCURY MONARCH
	1976-1977	V8-5.0L	FORD F150 1/2 TON
	1977-1980	V8-5.0L	LINCOLN VERSAILLES
	1977-1984	V8-5.0L	FORD THUNDERBIRD
	1978	V8-5.0L	FORD FUTURA
	1978-1979	V8-5.0L	FORD FAIRMONT
	1978-1979	V8-5.0L	MERCURY ZEPHYR
	1979-1982	V8-5.0L	MERCURY MARQUIS
	1979-1985	V8-5.0L	MERCURY CAPRI
	1979-1991	V8-5.0L	FORD COUNTRY SQUIRE
	1980-1983	V8-5.0L	LINCOLN MARK VI
	1980-1991	V8-5.0L	MERCURY GRAND MARQUIS
	1981-1990	V8-5.0L	LINCOLN TOWN CAR
	1981-1991	V8-5.0L	MERCURY COLONY PARK
	1983-1984	V8-5.0L	LINCOLN CONTINENTAL
	1984	V8-5.0L	LINCOLN MARK VII
	1987-1991	V8-5.0L	FORD LTD CROWN VICTORIA
	1964-1967	V8-5.3L	CHEVROLET IMPALA
	1965-1967	V8-5.3L	CHEVROLET CHEVELLE
	1968	V8-5.3L	CHEVROLET EL CAMINO
	1959-1960	V8-5.7L	CHEVROLET EL CAMINO
	1959-1961	V8-5.7L	CHEVROLET IMPALA
	1968	V8-5.7L	CHEVROLET NOVA
	1961-1963	V8-5.8L	FORD GALAXIE
	1961-1970	V8-5.8L	FORD FAIRLANE
	1961-1973	V8-5.8L	MERCURY MONTEREY
	1964-1972	V8-5.8L	FORD CUSTOM
	1965-1986	V8-5.8L	FORD LTD
	1969	V8-5.8L	MERCURY COMET
	1969-1971	V8-5.8L	MERCURY CYCLONE
	1969-1973	V8-5.8L	FORD MUSTANG
	1969-1976	V8-5.8L	FORD TORINO
	1969-1976	V8-5.8L	MERCURY MONTEGO
	1969-1979	V8-5.8L	MERCURY COUGAR
	1970	V8-5.8L	FORD FALCON
	1971-1981	V8-5.8L	MERCURY MARQUIS
	1975-1977	V8-5.8L	FORD GRANADA
	1975-1977	V8-5.8L	MERCURY MONARCH
	1977	V8-5.8L	LINCOLN VERSAILLES
	1977-1979	V8-5.8L	FORD F100 1/2 TON
	1977-1979	V8-5.8L	FORD F150 1/2 TON
	1977-1979	V8-5.8L	FORD THUNDERBIRD
	1978-1991	V8-5.8L	FORD BRONCO
	1979	V8-5.8L	FORD COUNTRY SQUIRE
	1980	V8-5.8L	LINCOLN CONTINENTAL
	1980	V8-5.8L	LINCOLN MARK VI
	1980-1986	V8-5.8L	MERCURY GRAND MARQUIS
	1981	V8-5.8L	MERCURY COLONY PARK
	1987-1991	V8-5.8L	FORD LTD CROWN VICTORIA

USMW	Years	Cyl.	Specifications
	1975-1976	V8-5.9L	FORD F100 1/2 TON
	1975-1976	V8-5.9L	FORD F150 1/2 TON
	1975-1976	V8-5.9L	FORD F500 P/U 2WD
	1961-1963	V8-6.4L	FORD GALAXIE
	1961-1968	V8-6.4L	FORD THUNDERBIRD
	1961-1969	V8-6.4L	FORD FAIRLANE
	1961-1970	V8-6.4L	MERCURY MONTEREY
	1963-1970	V8-6.4L	MERCURY MARAUDER
	1964-1968	V8-6.4L	MERCURY MONTCLAIR
	1964-1968	V8-6.4L	MERCURY PARK LANE
	1964-1971	V8-6.4L	FORD CUSTOM
	1965-1971	V8-6.4L	FORD LTD
	1966-1969	V8-6.4L	MERCURY COMET
	1966-1969	V8-6.4L	MERCURY CYCLONE
	1967-1969	V8-6.4L	FORD MUSTANG
	1967-1969	V8-6.4L	MERCURY COUGAR
	1968-1969	V8-6.4L	FORD TORINO
	1968-1969	V8-6.4L	MERCURY MONTEGO
	1968-1970	V8-6.4L	MERCURY MARQUIS
	1975-1976	V8-6.4L	FORD F100 1/2 TON
	1975-1976	V8-6.4L	FORD F150 1/2 TON
	1975-1976	V8-6.4L	FORD F500 P/U 2WD
	1965-1968	V8-6.5L	CHEVROLET CHEVELLE
	1965-1968	V8-6.5L	CHEVROLET IMPALA
	1966	V8-6.5L	CHEVROLET MALIBU
	1966-1968	V8-6.5L	CHEVROLET CAPRICE
	1966-1968	V8-6.5L	CHEVROLET EL CAMINO
	1968	V8-6.5L	CHEVROLET NOVA
	1962-1963	V8-6.6L	FORD GALAXIE
	1962-1974	V8-6.6L	MERCURY MONTEREY
	1971-1972	V8-6.6L	FORD CUSTOM
	1971-1978	V8-6.6L	FORD LTD
	1971-1978	V8-6.6L	MERCURY MARQUIS
	1972-1976	V8-6.6L	FORD TORINO
	1972-1976	V8-6.6L	MERCURY MONTEGO
	1972-1978	V8-6.6L	FORD THUNDERBIRD
	1973-1978	V8-6.6L	MERCURY COUGAR
	1975-1976	V8-6.6L	FORD COUNTRY SQUIRE
	1975-1976	V8-6.6L	MERCURY COLONY PARK
	1977-1979	V8-6.6L	LINCOLN CONTINENTAL
	1977-1979	V8-6.6L	LINCOLN MARK V
	1978-1979	V8-6.6L	FORD BRONCO
	1961-1965	V8-6.7L	CHEVROLET IMPALA
	1963-1970	V8-7.0L	MERCURY MARAUDER
	1963-1973	V8-7.0L	MERCURY MONTEREY
	1964	V8-7.0L	FORD GALAXIE 500
	1964-1968	V8-7.0L	MERCURY MONTCLAIR
	1964-1968	V8-7.0L	MERCURY PARK LANE
	1966-1968	V8-7.0L	CHEVROLET CAPRICE
	1966-1968	V8-7.0L	CHEVROLET IMPALA
	1967	V8-7.0L	MERCURY COMET
	1967-1973	V8-7.0L	MERCURY MARQUIS
	1968-1971	V8-7.0L	MERCURY COUGAR
	1968-1971	V8-7.0L	MERCURY CYCLONE
	1968-1972	V8-7.0L	FORD CUSTOM
	1968-1973	V8-7.0L	MERCURY MONTEGO
	1970	V8-7.0L	FORD FALCON
	1968-1971	V8-7.5L	LINCOLN MARK III
	1968-1978	V8-7.5L	LINCOLN CONTINENTAL
	1972-1976	V8-7.5L	LINCOLN MARK IV
	1977-1978	V8-7.5L	LINCOLN MARK V
<b>22012</b>	1966-1972	L6-2.8L	FORD BRONCO
	1968-1971	L6-2.8L	FORD E100 1/2 TON VAN
	1968-1971	L6-2.8L	FORD E200 3/4 TON VAN
	1969	L6-2.8L	FORD E300 1 TON VAN
	1966-1968	L6-3.3L	FORD RANCHERO
	1973-1974	L6-3.3L	FORD BRONCO
	1980-1982	L6-3.3L	FORD MUSTANG
	1980-1982	L6-3.3L	MERCURY CAPRI

USMW	Years	Cyl.	Specifications
	1983	L6-3.3L	FORD FAIRMONT
	1983	L6-3.3L	FORD LTD
	1983	L6-3.3L	MERCURY MARQUIS
	1983	L6-3.3L	MERCURY ZEPHYR
	1965-1966	L6-3.9L	FORD CUSTOM
	1968-1974	L6-3.9L	FORD E100 1/2 TON VAN
	1968-1974	L6-3.9L	FORD E200 3/4 TON VAN
	1968-1974	L6-3.9L	FORD E300 1 TON VAN
	1956	V8-4.3L	CHEVROLET CORVETTE
	1960-1961	V8-4.6L	CHEVROLET CORVETTE
	1969-1979	V8-5.7L	CHEVROLET CORVETTE
	1964-1967	V8-7.0L	FORD CUSTOM
	1966-1969	V8-7.0L	CHEVROLET CORVETTE
	1968-1973	V8-7.0L	FORD RANCHERO
	1972-1976	V8-7.5L	FORD THUNDERBIRD
	1972-1978	V8-7.5L	FORD LTD
	1973-1976	V8-7.5L	FORD TORINO
	1974-1977	V8-7.5L	FORD RANCHERO
	1975	V8-7.5L	FORD GRAN TORINO
	1975-1976	V8-7.5L	FORD COUNTRY SQUIRE
	1975-1979	V8-7.5L	FORD E250 3/4 TON VAN
	1975-1979	V8-7.5L	FORD E350 1 TON VAN
<b>22013</b>	1976-1977	L4-1.4L	CHEVROLET CHEVETTE
	1976-1979	L4-1.6L	PONTIAC ACADIAN (CAN)
	1976-1987	L4-1.6L	CHEVROLET CHEVETTE
	1981-1987	L4-1.6L	PONTIAC T1000
	1984-1985	L4-1.9L	GMC S15
	1985	L4-1.9L	CHEVROLET S10
	1984	L4-2.0L	GMC S15
	1983-1985	L4-2.2L	CHEVROLET S10
	1984	L4-2.2L	CHEVROLET S10 BLAZER
	1984-1985	L4-2.2L	GMC S15
	1985-1986	L4-2.5L	CHEVROLET ASTRO
	1985-1986	L4-2.5L	GMC SAFARI
<b>22015</b>	1994-1997	L4-2.3L	MAZDA B2300
	1998-2001	L4-2.5L	FORD RANGER
	1998-2001	L4-2.5L	MAZDA B2500
<b>22016</b>	1963-1967	L6-3.3L	FORD FAIRLANE
	1965-1970	L6-3.3L	FORD MUSTANG
	1968	L6-3.3L	FORD TORINO
	1961-1964	L6-3.6L	FORD F100 1/2 TON
	1961-1964	L6-3.6L	FORD F250 3/4 TON
	1961-1964	L6-3.6L	FORD F350 1 TON
	1962	L6-3.6L	FORD FAIRLANE
	1955-1965	L6-3.8L	CHEVROLET BELAIR
	1958-1965	L6-3.8L	CHEVROLET BISCAYNE
	1963-1964	L6-3.8L	CHEVROLET IMPALA
	1964-1966	L6-3.8L	CHEVROLET CHEVY II
	1964-1966	L6-3.8L	CHEVROLET NOVA
	1965-1972	L6-3.9L	FORD F250 3/4 TON
	1965-1972	L6-3.9L	FORD F350 1 TON
	1965-1972	L6-3.9L	FORD GALAXIE 500
	1965-1974	L6-3.9L	FORD F100 1/2 TON
	1967-1969	L6-3.9L	FORD RANCHWAGON
	1968-1974	L6-3.9L	FORD P350
	1966-1968	L6-4.1L	CHEVROLET BISCAYNE
	1966-1969	L6-4.1L	CHEVROLET BELAIR
	1969-1973	L6-4.1L	FORD RANCHERO
	1972-1974	L6-4.1L	FORD GRAN TORINO
	1974	L6-4.1L	FORD ELITE
	1965-1974	L6-4.9L	FORD F100 1/2 TON
	1965-1979	L6-4.9L	FORD F250 3/4 TON
	1965-1979	L6-4.9L	FORD F350 1 TON
	1968-1976	L6-4.9L	FORD P350
	1972-1974	L6-4.9L	FORD E200 3/4 TON VAN
	1972-1974	L6-4.9L	FORD E300 1 TON VAN
	1972-1979	L6-4.9L	FORD E100 1/2 TON VAN
	1975-1979	L6-4.9L	FORD E150 1/2 TON VAN
	1975-1979	L6-4.9L	FORD E250 3/4 TON VAN

USMW	Years	Cyl.	Specifications
1975-1979	L6-4.9L	FORD E350 1 TON VAN	
1962-1963	V8-3.6L	FORD FAIRLANE	
1962-1963	V8-3.6L	MERCURY METEOR	
1969	V8-4.1L	FORD RANCHERO	
1955-1957	V8-4.3L	CHEVROLET BELAIR	
1962-1964	V8-4.3L	FORD FAIRLANE	
1963	V8-4.3L	FORD GALAXIE	
1964-1965	V8-4.3L	FORD MUSTANG	
1957-1967	V8-4.6L	CHEVROLET BELAIR	
1958-1967	V8-4.6L	CHEVROLET BISCAYNE	
1964-1967	V8-4.7L	FORD GALAXIE 500	
1966-1968	V8-4.7L	FORD RANCHERO	
1966-1969	V8-4.7L	FORD GT40	
1967	V8-4.7L	FORD COUNTRY SQUIRE	
1967-1968	V8-4.7L	FORD RANCHWAGON	
1977-1978	V8-4.7L	FORD F100 (MEX)	
1968-1972	V8-5.0L	FORD COUNTRY SQUIRE	
1968-1972	V8-5.0L	FORD GALAXIE 500	
1968-1972	V8-5.0L	FORD RANCHWAGON	
1968-1974	V8-5.0L	FORD E200 3/4 TON VAN	
1968-1974	V8-5.0L	FORD E300 1 TON VAN	
1968-1979	V8-5.0L	FORD E100 1/2 TON VAN	
1968-1979	V8-5.0L	FORD RANCHERO	
1969-1974	V8-5.0L	FORD F100 1/2 TON	
1972	V8-5.0L	FORD F350 1 TON	
1972-1974	V8-5.0L	FORD GRAN TORINO	
1972-1976	V8-5.0L	FORD P350	
1972-1977	V8-5.0L	FORD F250 3/4 TON	
1977-1979	V8-5.0L	FORD LTD II	
1979	V8-5.0L	FORD E150 1/2 TON VAN	
1979	V8-5.0L	FORD E250 3/4 TON VAN	
1979	V8-5.0L	FORD E350 1 TON VAN	
1979-1991	V8-5.0L	MERCURY COLONY PARK	
1979-1991	V8-5.0L	MERCURY GRAND MARQUIS	
1982	V8-5.0L	LINCOLN CONTINENTAL	
1983	V8-5.0L	FORD E-100 ECONOLINE	
1983	V8-5.0L	FORD E-100 ECONOLINE CLUB WAGON	
1983	V8-5.0L	FORD F-100	
1983-1986	V8-5.0L	FORD E-150 ECONOLINE	
1983-1986	V8-5.0L	FORD E-150 ECONOLINE CLUB WAGON	
1983-1986	V8-5.0L	FORD E-250 ECONOLINE	
1983-1986	V8-5.0L	FORD F-150	
1983-1986	V8-5.0L	FORD F-250	
1984-1986	V8-5.0L	FORD BRONCO	
1986	V8-5.0L	FORD F200 (MEX)	
1962-1969	V8-5.3L	CHEVROLET BELAIR	
1962-1969	V8-5.3L	CHEVROLET BISCAYNE	
1962-1969	V8-5.3L	CHEVROLET IMPALA	
1964-1966	V8-5.3L	CHEVROLET CHEVELLE	
1964-1966	V8-5.3L	CHEVROLET MALIBU	
1964-1967	V8-5.3L	CHEVROLET EL CAMINO	
1965-1967	V8-5.3L	CHECKER MARATHON SEDAN	
1965-1967	V8-5.3L	CHECKER MARATHON WAGON	
1965-1967	V8-5.3L	CHEVROLET CHEVY II	
1965-1968	V8-5.3L	CHEVROLET NOVA	
1966	V8-5.3L	CHECKER MARATHON LIMO	
1966	V8-5.3L	CHEVROLET CAPRICE	
1969	V8-5.3L	CHECKER DELUXE LIMO	
1969	V8-5.3L	CHECKER DELUXE SEDAN	
1958	V8-5.7L	CHEVROLET DELRAY	
1958-1961	V8-5.7L	CHEVROLET BISCAYNE	
1958-1969	V8-5.7L	CHEVROLET BELAIR	
1965-1967	V8-5.8L	FORD F100 1/2 TON	
1965-1979	V8-5.8L	FORD F250 3/4 TON	
1965-1979	V8-5.8L	FORD F350 1 TON	
1969-1974	V8-5.8L	FORD COUNTRY SQUIRE	
1969-1974	V8-5.8L	FORD GALAXIE 500	
1969-1974	V8-5.8L	FORD RANCHWAGON	
1969-1979	V8-5.8L	FORD RANCHERO	

USMW	Years	Cyl.	Specifications
1971-1979	V8-5.8L	MERCURY COLONY PARK	
1972-1976	V8-5.8L	FORD GRAN TORINO	
1973-1977	V8-5.8L	FORD CUSTOM 500	
1974	V8-5.8L	FORD ELITE	
1975-1976	V8-5.8L	FORD GALAXIE (MEX)	
1975-1979	V8-5.8L	FORD E100 1/2 TON VAN	
1975-1979	V8-5.8L	FORD E150 1/2 TON VAN	
1975-1979	V8-5.8L	FORD E250 3/4 TON VAN	
1975-1979	V8-5.8L	FORD E350 1 TON VAN	
1976	V8-5.8L	FORD GRAN TORINO WAGON	
1977	V8-5.8L	FORD LTD II WAGON	
1977-1979	V8-5.8L	FORD LTD II	
1978-1989	V8-5.8L	MERCURY GRAND MARQUIS	
1983	V8-5.8L	FORD E-100 ECONOLINE	
1983	V8-5.8L	FORD E-100 ECONOLINE CLUB WAGON	
1983-1987	V8-5.8L	FORD E-150 ECONOLINE	
1983-1987	V8-5.8L	FORD E-150 ECONOLINE CLUB WAGON	
1983-1987	V8-5.8L	FORD E-250 ECONOLINE	
1983-1987	V8-5.8L	FORD E-250 ECONOLINE CLUB WAGON	
1983-1987	V8-5.8L	FORD E-350 ECONOLINE	
1983-1987	V8-5.8L	FORD E-350 ECONOLINE CLUB WAGON	
1983-1987	V8-5.8L	FORD F-150	
1983-1987	V8-5.8L	FORD F-250	
1983-1987	V8-5.8L	FORD F-350	
1984-1987	V8-5.8L	FORD BRONCO	
1986-1987	V8-5.8L	FORD F200 (MEX)	
1968-1974	V8-5.9L	FORD F100 1/2 TON	
1968-1976	V8-5.9L	FORD F250 3/4 TON	
1968-1976	V8-5.9L	FORD F350 1 TON	
1973	V8-5.9L	FORD P350	
1961	V8-6.4L	MERCURY METEOR	
1964-1970	V8-6.4L	MERCURY COLONY PARK	
1964-1971	V8-6.4L	FORD GALAXIE 500	
1967-1969	V8-6.4L	FORD RANCHERO	
1967-1971	V8-6.4L	FORD RANCHWAGON	
1968	V8-6.4L	MERCURY COMMUTER	
1968-1971	V8-6.4L	FORD COUNTRY SQUIRE	
1968-1974	V8-6.4L	FORD F100 1/2 TON	
1968-1976	V8-6.4L	FORD F250 3/4 TON	
1968-1976	V8-6.4L	FORD F350 1 TON	
1972-1973	V8-6.4L	FORD P350	
1965	V8-6.5L	CHEVROLET CORVETTE	
1965-1969	V8-6.5L	CHEVROLET BELAIR	
1965-1969	V8-6.5L	CHEVROLET BISCAYNE	
1971-1974	V8-6.6L	FORD COUNTRY SQUIRE	
1971-1974	V8-6.6L	FORD GALAXIE 500	
1971-1974	V8-6.6L	MERCURY COLONY PARK	
1971-1976	V8-6.6L	FORD RANCHWAGON	
1972-1976	V8-6.6L	FORD GRAN TORINO	
1972-1978	V8-6.6L	FORD RANCHERO	
1973-1977	V8-6.6L	FORD CUSTOM 500	
1974	V8-6.6L	FORD ELITE	
1975-1978	V8-6.6L	MERCURY GRAND MARQUIS	
1976	V8-6.6L	FORD GRAN TORINO WAGON	
1976	V8-6.6L	FORD P350	
1977	V8-6.6L	FORD LTD II WAGON	
1977-1978	V8-6.6L	FORD LTD II	
1962-1965	V8-6.7L	CHEVROLET BELAIR	
1962-1965	V8-6.7L	CHEVROLET BISCAYNE	
1966-1967	V8-6.7L	MERCURY MONTCLAIR	
1966-1967	V8-6.7L	MERCURY MONTEREY	
1966-1967	V8-6.7L	MERCURY PARK LANE	
1967	V8-6.7L	MERCURY COLONY PARK	
1967	V8-6.7L	MERCURY MARQUIS	
1964	V8-7.0L	CADILLAC SIXTY SPECIAL	
1964-1970	V8-7.0L	FORD FAIRLANE	
1965-1973	V8-7.0L	FORD GALAXIE 500	
1965-1973	V8-7.0L	FORD LTD	
1966	V8-7.0L	MERCURY S-55	



USMW	Years	Cyl.	Specifications
	1966-1969	V8-7.0L	CHEVROLET BELAIR
	1966-1969	V8-7.0L	CHEVROLET BISCAYNE
	1966-1973	V8-7.0L	FORD THUNDERBIRD
	1967-1973	V8-7.0L	FORD COUNTRY SQUIRE
	1967-1973	V8-7.0L	FORD RANCHWAGON
	1967-1973	V8-7.0L	MERCURY COLONY PARK
	1968	V8-7.0L	LINCOLN CONTINENTAL
	1968-1971	V8-7.0L	FORD MUSTANG
	1968-1973	V8-7.0L	FORD TORINO
	1972-1973	V8-7.0L	FORD GRAN TORINO
	1973	V8-7.0L	FORD CUSTOM 500
<b>22017</b>	1985-1987	L6-4.2L	JAGUAR VANDEN PLAS
	1985-1987	L6-4.2L	JAGUAR XJ6
<b>22018</b>	1988-1989	L6-3.6L	JAGUAR VANDEN PLAS
	1988-1989	L6-3.6L	JAGUAR XJ6
	1990-1992	L6-4.0L	JAGUAR VANDEN PLAS
	1990-1992	L6-4.0L	JAGUAR XJ6
	1993-1996	L6-4.0L	JAGUAR XJS
	1980-1992	V12-5.3L	JAGUAR XJS
	1993	V12-6.0L	JAGUAR XJRS
	1994-1995	V12-6.0L	JAGUAR XJS
	1994-1996	V12-6.0L	JAGUAR XJ12
<b>22019</b>	1997-1999	L4-2.4L	MINI MONTERO SPORT
<b>22020</b>	1995-2004	L4-2.4L	TOYOTA TACOMA
	1994-1998	L4-2.7L	TOYOTA T100
	1995-2013	L4-2.7L	TOYOTA TACOMA
	1996-2010	L4-2.7L	TOYOTA 4RUNNER
<b>22021</b>	1995	V6-3.0L	TOYOTA 4RUNNER
	1994-1997	V6-3.2L	HONDA PASSPORT
	1994-1997	V6-3.2L	ISUZU RODEO
	1994-1997	V6-3.2L	ISUZU TROOPER
	1996-1997	V6-3.2L	ACURA SLX
	1995-1998	V6-3.4L	TOYOTA T100
	1995-2004	V6-3.4L	TOYOTA TACOMA
	1996-2002	V6-3.4L	TOYOTA 4RUNNER
	2000-2004	V6-3.4L	TOYOTA TUNDRA
<b>22022</b>	1998-1999	V6-3.5L	ACURA SLX
	1998-2002	V6-3.5L	ISUZU TROOPER
<b>22023</b>	2004-2006	L4-2.8L	CHEVROLET COLORADO
	2004-2006	L4-2.8L	GMC CANYON
	2006	L4-2.8L	ISUZU I-280
	2007-2008	L4-2.9L	ISUZU I-290
	2007-2012	L4-2.9L	CHEVROLET COLORADO
	2007-2012	L4-2.9L	GMC CANYON
<b>22025</b>	1996-2000	V6-3.3L	NISSAN PATHFINDER
	1997-2000	V6-3.3L	INFINITI QX4
	1999-2004	V6-3.3L	NISSAN FRONTIER
	2000-2004	V6-3.3L	NISSAN XTERRA
	1993-1996	V8-4.5L	INFINITI Q45
<b>22026</b>	1986	L4-2.5L	CHEVROLET S10
	1986	L4-2.5L	CHEVROLET S10 BLAZER
	1986	L4-2.5L	GMC S15
	1986	L4-2.5L	GMC S15 JIMMY
	1961-1962	L6-2.8L	DODGE LANCER
	1961-1965	L6-2.8L	DODGE D100 1/2 TON
	1961-1969	L6-2.8L	DODGE DART
	1964-1969	L6-2.8L	DODGE A100 1/2 TON
	1964-1969	L6-2.8L	DODGE A100 1/2 TON VAN
	1969	L6-2.8L	DODGE DART SWINGER
	1961-1962	L6-3.7L	DODGE LANCER
	1961-1977	L6-3.7L	DODGE W100 1/2 TON
	1961-1978	L6-3.7L	DODGE D300 1 TON
	1961-1979	L6-3.7L	DODGE D100 1/2 TON
	1961-1979	L6-3.7L	DODGE D200 3/4 TON
	1961-1979	L6-3.7L	DODGE W200 3/4 TON
	1963-1964	L6-3.7L	DODGE 330
	1963-1964	L6-3.7L	DODGE 440
	1963-1971	L6-3.7L	DODGE POLARA
	1963-1978	L6-3.7L	DODGE W300 1 TON

USMW	Years	Cyl.	Specifications
	1964-1970	L6-3.7L	DODGE A100 1/2 TON
	1964-1970	L6-3.7L	DODGE A100 1/2 TON VAN
	1965-1976	L6-3.7L	DODGE CORONET
	1968-1976	L6-3.7L	DODGE CHARGER
	1970-1972	L6-3.7L	DODGE CHALLENGER
	1971-1972	L6-3.7L	DODGE DEMON
	1971-1976	L6-3.7L	DODGE DART
	1971-1976	L6-3.7L	DODGE DART SWINGER
	1971-1978	L6-3.7L	DODGE B200 3/4 TON VAN
	1971-1979	L6-3.7L	DODGE B100 1/2 TON VAN
	1971-1979	L6-3.7L	DODGE B300 1 TON VAN
	1974-1978	L6-3.7L	DODGE CB300
	1974-1978	L6-3.7L	DODGE RAMCHARGER 4WD
	1975-1979	L6-3.7L	DODGE RAMCHARGER 2WD
	1976-1979	L6-3.7L	DODGE ASPEN
	1976-1979	L6-3.7L	PLYMOUTH VOLARE
	1977-1978	L6-3.7L	DODGE MONACO
	1977-1979	L6-3.7L	DODGE D150 1/2 TON
	1977-1981	L6-3.7L	DODGE DART (MEX)
	1978-1979	L6-3.7L	DODGE W150 1/2 TON
	1978-1979	L6-3.7L	PLYMOUTH CARAVELLE (CAN)
	1978-1981	L6-3.7L	CHRYSLER LEBARON
	1978-1981	L6-3.7L	CHRYSLER TOWN & COUNTRY
	1978-1983	L6-3.7L	DODGE DIPLOMAT
	1979	L6-3.7L	DODGE ST REGIS
	1979-1981	L6-3.7L	CHRYSLER NEWPORT
	1980	L6-3.7L	DODGE B100
	1980	L6-3.7L	DODGE B200
	1980	L6-3.7L	DODGE B300
	1980	L6-3.7L	DODGE D200
	1980	L6-3.7L	DODGE D350 (MEX)
	1980	L6-3.7L	DODGE RAMCHARGER
	1980	L6-3.7L	DODGE W200
	1980	L6-3.7L	PLYMOUTH PB100
	1980	L6-3.7L	PLYMOUTH PB200
	1980	L6-3.7L	PLYMOUTH TRAILDUSTER
	1980-1987	L6-3.7L	DODGE D150
	1980-1987	L6-3.7L	DODGE W150
	1981	L6-3.7L	DODGE ST. REGIS
	1981-1982	L6-3.7L	PLYMOUTH VOLARE (MEX)
	1981-1983	L6-3.7L	CHRYSLER CORDOBA
	1981-1983	L6-3.7L	DODGE MIRADA
	1981-1983	L6-3.7L	PLYMOUTH GRAN FURY
	1981-1983	L6-3.7L	PLYMOUTH PB150
	1981-1983	L6-3.7L	PLYMOUTH PB250
	1981-1987	L6-3.7L	DODGE B150
	1981-1987	L6-3.7L	DODGE B250
	1981-1987	L6-3.7L	DODGE D250
	1982	L6-3.7L	CHRYSLER NEW YORKER
	1983	L6-3.7L	CHRYSLER FIFTH AVENUE
	1986-1987	L6-3.7L	DODGE D100
	1986-1987	L6-3.7L	DODGE W100
	1980	L6-4.0L	DODGE D150
	1980	L6-4.0L	DODGE D200
	1982-1984	L6-4.1L	CHEVROLET G10
	1982-1984	L6-4.1L	CHEVROLET G20
	1982-1984	L6-4.1L	CHEVROLET G30
	1982-1984	L6-4.1L	GMC G2500
	1982-1984	L6-4.1L	GMC G3500
	1965-1975	L6-4.2L	JEEP CJ7 (MEX)
	1980-1983	L6-4.2L	JEEP CHEROKEE
	1980-1983	L6-4.2L	JEEP CJ5
	1980-1983	L6-4.2L	JEEP WAGONEER
	1980-1986	L6-4.2L	JEEP CJ7
	1980-1987	L6-4.2L	JEEP J10
	1981-1985	L6-4.2L	JEEP SCRAMBLER
	1984-1986	L6-4.2L	JEEP GRAND WAGONEER
	1980	L6-4.8L	CHEVROLET K10
	1980	L6-4.8L	GMC K1500

USMW	Years	Cyl.	Specifications
1980-1981	L6-4.8L	CHEVROLET	C20
1980-1981	L6-4.8L	CHEVROLET	C20 SUBURBAN
1980-1981	L6-4.8L	CHEVROLET	C30
1980-1981	L6-4.8L	CHEVROLET	K20
1980-1981	L6-4.8L	CHEVROLET	K20 SUBURBAN
1980-1981	L6-4.8L	CHEVROLET	K30
1980-1981	L6-4.8L	GMC	C2500
1980-1981	L6-4.8L	GMC	C2500 SUBURBAN
1980-1981	L6-4.8L	GMC	C3500
1980-1981	L6-4.8L	GMC	K2500
1980-1981	L6-4.8L	GMC	K2500 SUBURBAN
1980-1981	L6-4.8L	GMC	K3500
1984-1986	V6-2.8L	CHEVROLET	S10
1984-1986	V6-2.8L	CHEVROLET	S10 BLAZER
1984-1986	V6-2.8L	GMC	S15
1984-1986	V6-2.8L	GMC	S15 JIMMY
1988-1989	V6-3.9L	DODGE	D100
1988-1991	V6-3.9L	DODGE	D150
1988-1991	V6-3.9L	DODGE	D250
1989	V6-3.9L	DODGE	W100
1989-1991	V6-3.9L	DODGE	W150
1985-1986	V6-4.3L	CHEVROLET	ASTRO
1985-1986	V6-4.3L	CHEVROLET	G10
1985-1986	V6-4.3L	CHEVROLET	G20
1985-1986	V6-4.3L	CHEVROLET	G30
1985-1986	V6-4.3L	GMC	SAFARI
1967	V8-3.7L	DODGE	CORONET
1984	V8-4.1L	CADILLAC	DEVILLE
1984-1985	V8-4.1L	CADILLAC	FLEETWOOD
1981-1986	V8-5.0L	CHEVROLET	G20
1982-1985	V8-5.0L	CHEVROLET	G30
1982-1986	V8-5.0L	CHEVROLET	G10
1960-1962	V8-5.2L	DODGE	WM300 1 TON
1960-1977	V8-5.2L	DODGE	W100 1/2 TON
1960-1978	V8-5.2L	DODGE	W300 1 TON
1960-1979	V8-5.2L	DODGE	D100 1/2 TON
1960-1979	V8-5.2L	DODGE	D200 3/4 TON
1960-1979	V8-5.2L	DODGE	D300 1 TON
1960-1979	V8-5.2L	DODGE	W200 3/4 TON
1963-1964	V8-5.2L	DODGE	330
1963-1964	V8-5.2L	DODGE	440
1967-1970	V8-5.2L	DODGE	A100 1/2 TON
1967-1970	V8-5.2L	DODGE	A100 1/2 TON VAN
1971-1979	V8-5.2L	DODGE	B100 1/2 TON VAN
1971-1979	V8-5.2L	DODGE	B200 3/4 TON VAN
1971-1979	V8-5.2L	DODGE	B300 1 TON VAN
1974	V8-5.2L	DODGE	CHALLENGER
1974-1976	V8-5.2L	DODGE	CORONET
1974-1976	V8-5.2L	DODGE	DART
1974-1976	V8-5.2L	DODGE	DART SWINGER
1974-1978	V8-5.2L	DODGE	CHARGER
1974-1979	V8-5.2L	DODGE	RAMCHARGER 4WD
1974-1980	V8-5.2L	DODGE	CB300
1975-1977	V8-5.2L	DODGE	ROYAL MONACO
1975-1978	V8-5.2L	DODGE	MONACO
1975-1979	V8-5.2L	DODGE	RAMCHARGER 2WD
1975-1983	V8-5.2L	CHRYSLER	CORDOBA
1976-1979	V8-5.2L	PLYMOUTH	VOLARE
1976-1980	V8-5.2L	DODGE	ASPEN
1977-1979	V8-5.2L	DODGE	D150 1/2 TON
1977-1979	V8-5.2L	DODGE	W150 1/2 TON
1977-1981	V8-5.2L	CHRYSLER	LEBARON
1977-1983	V8-5.2L	DODGE	DIPLOMAT
1978-1979	V8-5.2L	DODGE	MAGNUM
1978-1979	V8-5.2L	PLYMOUTH	CARAVELLE (CAN)
1978-1981	V8-5.2L	CHRYSLER	TOWN & COUNTRY
1979	V8-5.2L	DODGE	ST REGIS
1979-1981	V8-5.2L	CHRYSLER	NEWPORT
1979-1982	V8-5.2L	CHRYSLER	NEW YORKER

USMW	Years	Cyl.	Specifications
1980	V8-5.2L	DODGE	B100
1980	V8-5.2L	DODGE	B200
1980	V8-5.2L	DODGE	B300
1980	V8-5.2L	DODGE	D200
1980	V8-5.2L	DODGE	D300
1980	V8-5.2L	DODGE	D350 (MEX)
1980	V8-5.2L	DODGE	RD200
1980	V8-5.2L	DODGE	W200
1980	V8-5.2L	DODGE	W300
1980	V8-5.2L	PLYMOUTH	PB100
1980	V8-5.2L	PLYMOUTH	PB200
1980	V8-5.2L	PLYMOUTH	PB300
1980-1981	V8-5.2L	DODGE	ST. REGIS
1980-1981	V8-5.2L	PLYMOUTH	TRAILDUSTER
1980-1983	V8-5.2L	DODGE	MIRADA
1980-1991	V8-5.2L	DODGE	D150
1980-1991	V8-5.2L	DODGE	RAMCHARGER
1980-1991	V8-5.2L	DODGE	W150
1981-1982	V8-5.2L	CHRYSLER	IMPERIAL
1981-1983	V8-5.2L	DODGE	D350
1981-1983	V8-5.2L	PLYMOUTH	GRAN FURY
1981-1983	V8-5.2L	PLYMOUTH	PB150
1981-1983	V8-5.2L	PLYMOUTH	PB250
1981-1983	V8-5.2L	PLYMOUTH	PB350
1981-1991	V8-5.2L	DODGE	B150
1981-1991	V8-5.2L	DODGE	B250
1981-1991	V8-5.2L	DODGE	B350
1981-1991	V8-5.2L	DODGE	D250
1981-1991	V8-5.2L	DODGE	W250
1982-1983	V8-5.2L	DODGE	W350
1983	V8-5.2L	CHRYSLER	FIFTH AVENUE
1986-1989	V8-5.2L	DODGE	D100
1986-1989	V8-5.2L	DODGE	W100
1980-1985	V8-5.7L	GMC	G2500
1980-1986	V8-5.7L	CHEVROLET	G10
1980-1986	V8-5.7L	CHEVROLET	G20
1980-1987	V8-5.7L	CHEVROLET	G30
1982-1983	V8-5.7L	GMC	G1500
1971-1978	V8-5.9L	DODGE	B100 1/2 TON VAN
1971-1979	V8-5.9L	DODGE	B200 3/4 TON VAN
1971-1979	V8-5.9L	DODGE	B300 1 TON VAN
1971-1979	V8-5.9L	DODGE	D100 1/2 TON
1971-1979	V8-5.9L	DODGE	D200 3/4 TON
1971-1979	V8-5.9L	DODGE	W200 3/4 TON
1971-1980	V8-5.9L	CHRYSLER	NEWPORT
1972-1977	V8-5.9L	DODGE	W100 1/2 TON
1972-1979	V8-5.9L	DODGE	D300 1 TON
1972-1979	V8-5.9L	DODGE	W300 1 TON
1974	V8-5.9L	DODGE	CHALLENGER
1974-1976	V8-5.9L	DODGE	CORONET
1974-1976	V8-5.9L	DODGE	DART
1974-1978	V8-5.9L	DODGE	CHARGER
1974-1978	V8-5.9L	DODGE	MONACO
1974-1979	V8-5.9L	DODGE	RAMCHARGER 4WD
1974-1980	V8-5.9L	DODGE	CB300
1975-1977	V8-5.9L	DODGE	ROYAL MONACO
1975-1979	V8-5.9L	CHRYSLER	CORDOBA
1975-1979	V8-5.9L	DODGE	RAMCHARGER 2WD
1976	V8-5.9L	DODGE	DART SWINGER
1976-1979	V8-5.9L	PLYMOUTH	VOLARE
1976-1980	V8-5.9L	DODGE	ASPEN
1977-1979	V8-5.9L	DODGE	D150 1/2 TON
1977-1979	V8-5.9L	DODGE	W150 1/2 TON
1977-1980	V8-5.9L	CHRYSLER	NEW YORKER
1977-1982	V8-5.9L	DODGE	DART (MEX)
1978-1979	V8-5.9L	CHRYSLER	LEBARON
1978-1979	V8-5.9L	CHRYSLER	TOWN & COUNTRY
1978-1979	V8-5.9L	DODGE	DIPLOMAT
1978-1979	V8-5.9L	DODGE	MAGNUM

USMW	Years	Cyl.	Specifications
	1979	V8-5.9L	<b>DODGE</b> ST REGIS
	1980	V8-5.9L	<b>DODGE</b> B200
	1980	V8-5.9L	<b>DODGE</b> B300
	1980	V8-5.9L	<b>DODGE</b> D200
	1980	V8-5.9L	<b>DODGE</b> D300
	1980	V8-5.9L	<b>DODGE</b> D350 (MEX)
	1980	V8-5.9L	<b>DODGE</b> MIRADA
	1980	V8-5.9L	<b>DODGE</b> RD200
	1980	V8-5.9L	<b>DODGE</b> ST. REGIS
	1980	V8-5.9L	<b>DODGE</b> W200
	1980	V8-5.9L	<b>DODGE</b> W300
	1980	V8-5.9L	<b>PLYMOUTH</b> PB200
	1980	V8-5.9L	<b>PLYMOUTH</b> PB300
	1980-1981	V8-5.9L	<b>DODGE</b> D400
	1980-1981	V8-5.9L	<b>DODGE</b> D450
	1980-1981	V8-5.9L	<b>PLYMOUTH</b> TRAILDUSTER
	1980-1982	V8-5.9L	<b>DODGE</b> MAGNUM (MEX)
	1980-1991	V8-5.9L	<b>DODGE</b> D150
	1980-1991	V8-5.9L	<b>DODGE</b> RAMCHARGER
	1980-1991	V8-5.9L	<b>DODGE</b> W150
	1981	V8-5.9L	<b>PLYMOUTH</b> PB250
	1981-1983	V8-5.9L	<b>PLYMOUTH</b> PB350
	1981-1991	V8-5.9L	<b>DODGE</b> D250
	1981-1991	V8-5.9L	<b>DODGE</b> D350
	1981-1991	V8-5.9L	<b>DODGE</b> W250
	1981-1991	V8-5.9L	<b>DODGE</b> W350
	1981-1992	V8-5.9L	<b>DODGE</b> B250
	1981-1992	V8-5.9L	<b>DODGE</b> B350
	1986-1988	V8-5.9L	<b>DODGE</b> D100
	1986-1988	V8-5.9L	<b>DODGE</b> W100
	1968-1971	V8-6.3L	<b>DODGE</b> D200 3/4 TON
	1968-1971	V8-6.3L	<b>DODGE</b> D300 1 TON
	1968-1971	V8-6.3L	<b>DODGE</b> W200 3/4 TON
	1971-1977	V8-6.6L	<b>DODGE</b> W100 1/2 TON
	1971-1978	V8-6.6L	<b>DODGE</b> B200 3/4 TON VAN
	1971-1978	V8-6.6L	<b>DODGE</b> D100 1/2 TON
	1971-1978	V8-6.6L	<b>DODGE</b> D200 3/4 TON
	1971-1978	V8-6.6L	<b>DODGE</b> D300 1 TON
	1971-1978	V8-6.6L	<b>DODGE</b> W200 3/4 TON
	1972-1973	V8-6.6L	<b>DODGE</b> POLARA
	1972-1974	V8-6.6L	<b>PLYMOUTH</b> SATELLITE
	1972-1975	V8-6.6L	<b>PLYMOUTH</b> ROADRUNNER
	1972-1976	V8-6.6L	<b>DODGE</b> CORONET
	1972-1977	V8-6.6L	<b>CHRYSLER</b> TOWN & COUNTRY
	1972-1977	V8-6.6L	<b>PLYMOUTH</b> GRAN FURY
	1972-1978	V8-6.6L	<b>CHRYSLER</b> NEWPORT
	1972-1978	V8-6.6L	<b>DODGE</b> CHARGER
	1972-1978	V8-6.6L	<b>DODGE</b> MONACO
	1972-1978	V8-6.6L	<b>PLYMOUTH</b> FURY
	1974-1978	V8-6.6L	<b>DODGE</b> RAMCHARGER 4WD
	1975-1977	V8-6.6L	<b>DODGE</b> ROYAL MONACO
	1975-1978	V8-6.6L	<b>CHRYSLER</b> CORDOBA
	1975-1978	V8-6.6L	<b>CHRYSLER</b> NEW YORKER
	1976-1978	V8-6.6L	<b>DODGE</b> B300 1 TON VAN
	1976-1978	V8-6.6L	<b>DODGE</b> CB300
	1976-1978	V8-6.6L	<b>DODGE</b> RAMCHARGER 2WD
	1976-1978	V8-6.6L	<b>DODGE</b> W300 1 TON
	1977-1978	V8-6.6L	<b>DODGE</b> D150 1/2 TON
	1977-1978	V8-6.6L	<b>DODGE</b> W150 1/2 TON
	1978	V8-6.6L	<b>DODGE</b> MAGNUM
	1965-1967	V8-7.0L	<b>CADILLAC</b> SEVENTY-FIVE
	1965-1967	V8-7.0L	<b>CADILLAC</b> SIXTY SPECIAL
	1966-1971	V8-7.2L	<b>CHRYSLER</b> 300
	1966-1975	V8-7.2L	<b>CHRYSLER</b> IMPERIAL
	1966-1978	V8-7.2L	<b>CHRYSLER</b> NEW YORKER
	1966-1978	V8-7.2L	<b>CHRYSLER</b> NEWPORT
	1967-1977	V8-7.2L	<b>CHRYSLER</b> TOWN & COUNTRY
	1973-1974	V8-7.2L	<b>DODGE</b> D200 3/4 TON
	1973-1974	V8-7.2L	<b>DODGE</b> D300 1 TON

USMW	Years	Cyl.	Specifications
	1975-1977	V8-7.2L	<b>DODGE</b> ROYAL MONACO
	1978	V8-7.2L	<b>DODGE</b> D150 1/2 TON
	1978	V8-7.2L	<b>DODGE</b> W150 1/2 TON
<b>22027</b>	1993-1997	V6-3.0L	<b>INFINITI</b> J30
<b>22029</b>	1997-2003	V6-3.0L	<b>MITSUBISHI</b> MONTERO SPORT
	2002-2004	V6-3.5L	<b>MITSUBISHI</b> MONTERO SPORT
<b>22030</b>	1969	L4-2.0L	<b>VOLVO</b> 142S
	1969	L4-2.0L	<b>VOLVO</b> 144S
	1969	L4-2.0L	<b>VOLVO</b> 145S
	1970-1974	L4-2.0L	<b>VOLVO</b> 142
	1970-1974	L4-2.0L	<b>VOLVO</b> 144
	1970-1974	L4-2.0L	<b>VOLVO</b> 145
	1974	L4-2.0L	<b>VOLVO</b> 142GL
	1974	L4-2.0L	<b>VOLVO</b> 144GL
	1975	L4-2.0L	<b>VOLVO</b> 245
	1975	L4-2.0L	<b>VOLVO</b> 242GL
	1975	L4-2.0L	<b>VOLVO</b> 244GL
	1976-1984	L4-2.1L	<b>VOLVO</b> 242
	1976-1985	L4-2.1L	<b>VOLVO</b> 244
	1976-1985	L4-2.1L	<b>VOLVO</b> 245
	1980	L4-2.1L	<b>VOLVO</b> 264
	1983-1984	L4-2.3L	<b>VOLVO</b> 242
	1983-1989	L4-2.3L	<b>VOLVO</b> 244
	1983-1989	L4-2.3L	<b>VOLVO</b> 245
	1984-1990	L4-2.3L	<b>VOLVO</b> 760
	1985	L4-2.3L	<b>VOLVO</b> 745
	1985-1991	L4-2.3L	<b>VOLVO</b> 740
	1989-1991	L4-2.3L	<b>VOLVO</b> 780
	1990-1993	L4-2.3L	<b>VOLVO</b> 240
	1991	L4-2.3L	<b>VOLVO</b> 940
	1980	L6-2.4L	<b>VOLVO</b> 265
	1980-1981	L6-2.4L	<b>VOLVO</b> 264
	1982-1984	L6-2.4L	<b>VOLVO</b> 244
	1982-1984	L6-2.4L	<b>VOLVO</b> 245
	1983-1985	L6-2.4L	<b>VOLVO</b> 760
	1985	L6-2.4L	<b>VOLVO</b> 745
	1986	L6-2.4L	<b>VOLVO</b> 740
	1976-1979	L6-2.7L	<b>VOLVO</b> 262
	1976-1979	L6-2.7L	<b>VOLVO</b> 264
	1976-1979	L6-2.7L	<b>VOLVO</b> 265
	1970-1975	L6-3.0L	<b>VOLVO</b> 164
	1973-1974	L6-3.0L	<b>VOLVO</b> 164E
	1980-1981	V6-2.8L	<b>VOLVO</b> 262
	1980-1981	V6-2.8L	<b>VOLVO</b> 265
	1980-1982	V6-2.8L	<b>VOLVO</b> 264
	1983-1986	V6-2.8L	<b>VOLVO</b> 760
<b>22031</b>	1987-1990	V6-2.8L	<b>VOLVO</b> 760
	1987-1990	V6-2.8L	<b>VOLVO</b> 780
<b>22032</b>	2001-2003	V6-3.5L	<b>INFINITI</b> QX4
	2001-2004	V6-3.5L	<b>NISSAN</b> PATHFINDER
	2003-2004	V6-3.5L	<b>INFINITI</b> G35
	1997-2001	V8-4.1L	<b>INFINITI</b> Q45
	2003-2008	V8-4.5L	<b>INFINITI</b> FX45
<b>22033</b>	1996-1998	L4-1.8L	<b>SUZUKI</b> SIDEKICK
	1999-2003	L4-2.0L	<b>CHEVROLET</b> TRACKER
	1999-2003	L4-2.0L	<b>SUZUKI</b> VITARA
	1999-2005	V6-2.5L	<b>SUZUKI</b> GRAND VITARA
	2001-2004	V6-2.5L	<b>CHEVROLET</b> TRACKER
	2004	V6-2.5L	<b>SUZUKI</b> VITARA
	2001	V6-2.7L	<b>SUZUKI</b> GRAND VITARA
	2002-2006	V6-2.7L	<b>SUZUKI</b> XL-7
<b>22037</b>	1980	V8-5.0L	<b>CHEVROLET</b> CORVETTE
	1980-1982	V8-5.7L	<b>CHEVROLET</b> CORVETTE
<b>22038</b>	1962-1966	L6-2.8L	<b>FORD</b> E100 1/2 TON VAN
	1965-1967	L6-2.8L	<b>FORD</b> P100
	1978	L6-3.3L	<b>FORD</b> FUTURA
	1978-1982	L6-3.3L	<b>FORD</b> FAIRMONT
	1979	L6-3.3L	<b>FORD</b> MUSTANG
	1980-1982	L6-3.3L	<b>FORD</b> THUNDERBIRD

**FAN CLUTCHES**

USMW	Years	Cyl.	Specifications
	1980-1982	L6-3.3L	MERCURY COUGAR
	1980-1982	L6-3.3L	MERCURY ZEPHYR
	1981-1982	L6-3.3L	FORD GRANADA
	1965	L6-3.8L	CHEVROLET IMPALA
	1957-1959	V8-4.6L	CHEVROLET CORVETTE
	1962-1968	V8-5.3L	CHEVROLET CORVETTE
	1972-1974	V8-7.5L	FORD COUNTRY SQUIRE
	1972-1974	V8-7.5L	MERCURY MONTEREY
	1972-1976	V8-7.5L	MERCURY COLONY PARK
	1972-1978	V8-7.5L	MERCURY MARQUIS
	1973-1974	V8-7.5L	FORD GALAXIE 500
	1973-1975	V8-7.5L	FORD RANCHWAGON
	1973-1976	V8-7.5L	FORD CUSTOM 500
	1973-1976	V8-7.5L	MERCURY MONTEGO
	1974	V8-7.5L	FORD ELITE
	1974-1976	V8-7.5L	FORD GRAN TORINO
	1975-1978	V8-7.5L	MERCURY GRAND MARQUIS
	1976	V8-7.5L	FORD GRAN TORINO WAGON
<b>22041</b>	1980-1981	V6-4.1L	CADILLAC DEVILLE
	1980-1982	V6-4.1L	CADILLAC FLEETWOOD
	1977-1981	V8-5.7L	CADILLAC SEVILLE
	1979-1981	V8-5.7L	CADILLAC DEVILLE
	1979-1981	V8-5.7L	CADILLAC ELDORADO
	1979-1981	V8-5.7L	CADILLAC FLEETWOOD
	1980	V8-5.7L	BUICK ELECTRA
	1980	V8-5.7L	BUICK ESTATE WAGON
	1980	V8-5.7L	BUICK LESABRE
	1980	V8-5.7L	BUICK RIVIERA
	1980-1981	V8-6.0L	CADILLAC DEVILLE
	1980-1981	V8-6.0L	CADILLAC ELDORADO
	1980-1981	V8-6.0L	CADILLAC SEVILLE
	1980-1984	V8-6.0L	CADILLAC COMMERCIAL CHASSIS
	1980-1984	V8-6.0L	CADILLAC FLEETWOOD
	1977-1978	V8-7.0L	CADILLAC ELDORADO
	1977-1979	V8-7.0L	CADILLAC DEVILLE
	1977-1979	V8-7.0L	CADILLAC FLEETWOOD
<b>22042</b>	1980	V6-3.8L	OLDSMOBILE STARFIRE
	1980	V6-3.8L	PONTIAC SUNBIRD
<b>22043</b>	1982	L4-2.5L	AMERICAN MOTORS CONCORD
	1982	L4-2.5L	AMERICAN MOTORS SPIRIT
	1982-1983	L4-2.5L	AMERICAN MOTORS EAGLE
	1970	L6-3.2L	DODGE A100 1/2 TON
	1970	L6-3.2L	DODGE A100 1/2 TON VAN
	1970-1971	L6-3.2L	DODGE CHALLENGER
	1970-1971	L6-3.2L	DODGE D100 1/2 TON
	1970-1971	L6-3.2L	PLYMOUTH BARRACUDA
	1970-1974	L6-3.2L	DODGE DART
	1970-1974	L6-3.2L	DODGE DART SWINGER
	1970-1974	L6-3.2L	PLYMOUTH DUSTER
	1970-1974	L6-3.2L	PLYMOUTH VALIANT
	1971	L6-3.2L	DODGE B100 1/2 TON VAN
	1971	L6-3.2L	DODGE B200 3/4 TON VAN
	1971-1972	L6-3.2L	DODGE DEMON
	1971-1974	L6-3.2L	PLYMOUTH SCAMP
	1960-1961	L6-3.7L	DODGE PHOENIX
	1960-1961	L6-3.7L	DODGE PIONEER
	1960-1961	L6-3.7L	DODGE SENECA
	1960-1964	L6-3.7L	PLYMOUTH SAVOY
	1960-1970	L6-3.7L	DODGE DART
	1960-1970	L6-3.7L	PLYMOUTH BELVEDERE
	1960-1978	L6-3.7L	PLYMOUTH FURY
	1962-1976	L6-3.7L	PLYMOUTH VALIANT
	1964-1972	L6-3.7L	PLYMOUTH BARRACUDA
	1966-1974	L6-3.7L	PLYMOUTH SATELLITE
	1969-1970	L6-3.7L	DODGE DART SWINGER
	1970-1976	L6-3.7L	PLYMOUTH DUSTER
	1971-1976	L6-3.7L	PLYMOUTH SCAMP
	1974-1975	L6-3.7L	PLYMOUTH VOYAGER
	1974-1976	L6-3.7L	PLYMOUTH VALIANT DUSTER (MEX)

USMW	Years	Cyl.	Specifications
	1975-1978	L6-3.7L	PLYMOUTH TRAILDUSTER 4WD
	1975-1979	L6-3.7L	PLYMOUTH TRAILDUSTER 2WD
	1976-1980	L6-3.7L	PLYMOUTH PB100
	1976-1980	L6-3.7L	PLYMOUTH PB200
	1980	L6-3.7L	DODGE ASPEN
	1980	L6-3.7L	DODGE B100
	1980	L6-3.7L	DODGE B200
	1980	L6-3.7L	DODGE B300
	1980	L6-3.7L	DODGE D200
	1980	L6-3.7L	DODGE RAMCHARGER
	1980	L6-3.7L	DODGE W200
	1980	L6-3.7L	PLYMOUTH TRAILDUSTER
	1980	L6-3.7L	PLYMOUTH VOLARE
	1980-1981	L6-3.7L	CHRYSLER LEBARON
	1980-1981	L6-3.7L	CHRYSLER NEWPORT
	1980-1981	L6-3.7L	CHRYSLER TOWN & COUNTRY
	1980-1981	L6-3.7L	DODGE ST. REGIS
	1980-1983	L6-3.7L	CHRYSLER CORDOBA
	1980-1983	L6-3.7L	DODGE DIPLOMAT
	1980-1983	L6-3.7L	DODGE MIRADA
	1980-1983	L6-3.7L	PLYMOUTH GRAN FURY
	1980-1987	L6-3.7L	DODGE D150
	1980-1987	L6-3.7L	DODGE W150
	1981	L6-3.7L	PLYMOUTH PB150
	1981	L6-3.7L	PLYMOUTH PB250
	1981	L6-3.7L	PLYMOUTH VALIANT (MEX)
	1981-1987	L6-3.7L	DODGE B150
	1981-1987	L6-3.7L	DODGE B250
	1981-1987	L6-3.7L	DODGE D250
	1982	L6-3.7L	CHRYSLER NEW YORKER
	1983	L6-3.7L	CHRYSLER FIFTH AVENUE
	1986-1987	L6-3.7L	DODGE D100
	1986-1987	L6-3.7L	DODGE W100
	1975	L6-3.8L	OLDSMOBILE STARFIRE
	1980	L6-4.0L	DODGE D150
	1980	L6-4.0L	DODGE D200
	1968-1971	L6-4.1L	BUICK SKYLARK
	1969	L6-4.1L	BUICK SPECIAL
	1978	L6-4.1L	GMC C2500 3/4 TON
	1978	L6-4.1L	GMC C3500 1 TON
	1978	L6-4.1L	GMC K2500 3/4 TON
	1978-1979	L6-4.1L	CHEVROLET BLAZER 2WD
	1978-1979	L6-4.1L	CHEVROLET BLAZER 4WD
	1978-1979	L6-4.1L	CHEVROLET C10 1/2 TON
	1978-1979	L6-4.1L	CHEVROLET C10 1/2 TON SUBURBAN
	1978-1979	L6-4.1L	CHEVROLET C20 3/4 TON
	1978-1979	L6-4.1L	CHEVROLET K10 1/2 TON
	1978-1979	L6-4.1L	CHEVROLET K20 3/4 TON
	1978-1979	L6-4.1L	GMC C1500 1/2 TON
	1978-1979	L6-4.1L	GMC JIMMY 2WD
	1978-1979	L6-4.1L	GMC JIMMY 4WD
	1978-1979	L6-4.1L	GMC K1500 1/2 TON
	1980	L6-4.1L	CHEVROLET C10 SUBURBAN
	1980	L6-4.1L	CHEVROLET C30
	1980	L6-4.1L	CHEVROLET K10 SUBURBAN
	1980	L6-4.1L	CHEVROLET K20
	1980	L6-4.1L	GMC C1500 SUBURBAN
	1980	L6-4.1L	GMC C3500
	1980	L6-4.1L	GMC K1500 SUBURBAN
	1980	L6-4.1L	GMC K2500
	1980-1982	L6-4.1L	CHEVROLET K5 BLAZER
	1980-1982	L6-4.1L	GMC JIMMY
	1980-1984	L6-4.1L	CHEVROLET C10
	1980-1984	L6-4.1L	CHEVROLET C20
	1980-1984	L6-4.1L	CHEVROLET K10
	1980-1984	L6-4.1L	GMC C1500
	1980-1984	L6-4.1L	GMC C2500
	1980-1984	L6-4.1L	GMC K1500
	1966	L6-4.8L	GMC PB1500 VAN



USMW	Years	Cyl.	Specifications	USMW	Years	Cyl.	Specifications
1966	L6-4.8L	GMC	PB2500 VAN	1980	V6-3.8L	PONTIAC	SUNBIRD
1967	L6-4.8L	GMC	P1500 VAN	1980-1981	V6-3.8L	CHEVROLET	CAMARO
1967-1969	L6-4.8L	GMC	P2500 VAN	1980-1981	V6-3.8L	PONTIAC	BONNEVILLE
1967-1969	L6-4.8L	GMC	P3500 VAN	1980-1984	V6-3.8L	CHEVROLET	CAPRICE
1974-1978	L6-4.8L	GMC	G2500 3/4 TON VAN	1982-1984	V6-3.8L	OLDSMOBILE	CUTLASS CALAIS
1974-1978	L6-4.8L	GMC	G3500 1 TON VAN	1982-1984	V6-3.8L	OLDSMOBILE	CUTLASS SUPREME
1974-1979	L6-4.8L	CHEVROLET	G30 1 TON VAN	1987-1991	V6-3.9L	DODGE	DAKOTA
1974-1980	L6-4.8L	CHEVROLET	G20 3/4 TON VAN	1988-1989	V6-3.9L	DODGE	D100
1978	L6-4.8L	GMC	C2500 3/4 TON	1988-1989	V6-3.9L	DODGE	D150
1978	L6-4.8L	GMC	C3500 1 TON	1988-1989	V6-3.9L	DODGE	D250
1978-1979	L6-4.8L	CHEVROLET	C10 1/2 TON	1988-1991	V6-3.9L	DODGE	B150
1978-1979	L6-4.8L	CHEVROLET	C20 3/4 TON	1988-1991	V6-3.9L	DODGE	B250
1978-1979	L6-4.8L	CHEVROLET	K20 3/4 TON	1989	V6-3.9L	DODGE	W100
1978-1979	L6-4.8L	CHEVROLET	K30 1 TON	1989	V6-3.9L	DODGE	W150
1978-1979	L6-4.8L	GMC	C1500 1/2 TON	1980-1981	V6-4.1L	BUICK	LESABRE
1978-1979	L6-4.8L	GMC	K2500 3/4 TON	1981	V6-4.1L	BUICK	RIVIERA
1978-1979	L6-4.8L	GMC	K2500 3/4 TON SUBURBAN	1981	V6-4.1L	CADILLAC	SEVILLE
1978-1979	L6-4.8L	GMC	K3500 1 TON	1981	V6-4.1L	OLDSMOBILE	98
1979	L6-4.8L	CHEVROLET	K10 1/2 TON	1981	V6-4.1L	OLDSMOBILE	TORONADO
1979	L6-4.8L	GMC	K1500 1/2 TON	1982	V6-4.1L	CADILLAC	DEVILLE
1980	L6-4.8L	CHEVROLET	C10	1976	V8-4.3L	PONTIAC	LEMANS
1980	L6-4.8L	CHEVROLET	K10	1976-1980	V8-4.3L	PONTIAC	GRAND LEMANS
1980	L6-4.8L	GMC	C1500	1980	V8-4.3L	PONTIAC	SAFARI S/W
1980	L6-4.8L	GMC	K1500	1981	V8-4.3L	BUICK	CENTURY
1980-1982	L6-4.8L	CHEVROLET	C20 SUBURBAN	1981	V8-4.3L	BUICK	REGAL
1980-1982	L6-4.8L	CHEVROLET	K20 SUBURBAN	1979	V8-4.4L	CHEVROLET	EL CAMINO
1980-1984	L6-4.8L	CHEVROLET	C20	1979	V8-4.4L	CHEVROLET	MONTE CARLO
1980-1984	L6-4.8L	CHEVROLET	C30	1979	V8-4.4L	GMC	CABALLERO
1980-1984	L6-4.8L	CHEVROLET	K20	1979-1980	V8-4.4L	CHEVROLET	MALIBU
1980-1984	L6-4.8L	CHEVROLET	K30	1980-1981	V8-4.4L	CHEVROLET	CAPRICE
1980-1984	L6-4.8L	GMC	C2500	1980-1981	V8-4.4L	CHEVROLET	IMPALA
1980-1984	L6-4.8L	GMC	C2500 SUBURBAN	1964-1966	V8-4.5L	DODGE	A100 1/2 TON
1980-1984	L6-4.8L	GMC	C3500	1964-1966	V8-4.5L	DODGE	A100 1/2 TON VAN
1980-1984	L6-4.8L	GMC	K2500	1964-1969	V8-4.5L	DODGE	DART
1980-1984	L6-4.8L	GMC	K2500 SUBURBAN	1965-1968	V8-4.5L	DODGE	CORONET
1980-1984	L6-4.8L	GMC	K3500	1969	V8-4.5L	DODGE	DART SWINGER
1978-1979	V6-3.2L	BUICK	CENTURY	1964-1967	V8-4.9L	BUICK	SPECIAL
1978-1979	V6-3.2L	BUICK	REGAL	1964-1977	V8-4.9L	BUICK	SKYLARK
1978-1979	V6-3.3L	CHEVROLET	EL CAMINO	1964-1980	V8-4.9L	BUICK	LESABRE
1978-1979	V6-3.3L	CHEVROLET	MALIBU	1977-1979	V8-4.9L	PONTIAC	GRAND SAFARI S/W
1978-1979	V6-3.3L	CHEVROLET	MONTE CARLO	1977-1980	V8-4.9L	PONTIAC	GRAND LEMANS
1978-1979	V6-3.3L	GMC	CABALLERO	1979-1980	V8-4.9L	BUICK	CENTURY
1964-1967	V6-3.7L	BUICK	SKYLARK	1979-1980	V8-4.9L	BUICK	REGAL
1965-1967	V6-3.7L	BUICK	SPECIAL	1980	V8-4.9L	BUICK	ELECTRA
1975-1979	V6-3.8L	BUICK	SKYLARK	1980	V8-4.9L	BUICK	ESTATE WAGON
1975-1981	V6-3.8L	BUICK	CENTURY	1980	V8-4.9L	PONTIAC	SAFARI S/W
1975-1981	V6-3.8L	BUICK	REGAL	1980-1981	V8-4.9L	PONTIAC	FIREBIRD
1976-1980	V6-3.8L	OLDSMOBILE	STARFIRE	1976	V8-5.0L	PONTIAC	GRAND LEMANS (CAN)
1976-1981	V6-3.8L	BUICK	LESABRE	1976-1979	V8-5.0L	CHEVROLET	MONTE CARLO
1977	V6-3.8L	PONTIAC	VENTURA	1977-1979	V8-5.0L	BUICK	SKYLARK
1977-1979	V6-3.8L	OLDSMOBILE	88	1977-1980	V8-5.0L	BUICK	CENTURY
1977-1979	V6-3.8L	OLDSMOBILE	CUTLASS	1977-1980	V8-5.0L	PONTIAC	GRAND LEMANS
1977-1979	V6-3.8L	OLDSMOBILE	OMEGA	1978	V8-5.0L	BUICK	LESABRE
1977-1979	V6-3.8L	PONTIAC	PHOENIX	1978-1979	V8-5.0L	CHEVROLET	CAPRICE
1977-1981	V6-3.8L	PONTIAC	CATALINA	1978-1979	V8-5.0L	CHEVROLET	EL CAMINO
1977-1981	V6-3.8L	PONTIAC	FIREBIRD	1978-1979	V8-5.0L	CHEVROLET	IMPALA
1977-1981	V6-3.8L	PONTIAC	GRAND LEMANS	1978-1979	V8-5.0L	GMC	CABALLERO
1977-1981	V6-3.8L	PONTIAC	LEMANS	1978-1980	V8-5.0L	BUICK	REGAL
1978-1979	V6-3.8L	CHEVROLET	EL CAMINO	1979	V8-5.0L	CHEVROLET	MALIBU
1978-1979	V6-3.8L	GMC	CABALLERO	1979	V8-5.0L	PONTIAC	GRAND SAFARI S/W
1978-1981	V6-3.8L	CHEVROLET	MONTE CARLO	1980	V8-5.0L	OLDSMOBILE	CUTLASS
1978-1981	V6-3.8L	PONTIAC	GRAND PRIX	1980	V8-5.0L	OLDSMOBILE	CUTLASS CALAIS
1978-1982	V6-3.8L	OLDSMOBILE	CUTLASS CRUISER	1980	V8-5.0L	OLDSMOBILE	CUTLASS CRUISER
1978-1983	V6-3.8L	CHEVROLET	MALIBU	1980	V8-5.0L	OLDSMOBILE	CUTLASS SALON
1979	V6-3.8L	PONTIAC	GRAND AM	1980	V8-5.0L	OLDSMOBILE	CUTLASS SUPREME
1979	V6-3.8L	PONTIAC	GRAND SAFARI S/W	1980	V8-5.0L	PONTIAC	SAFARI S/W
1979-1981	V6-3.8L	BUICK	RIVIERA	1981	V8-5.0L	CHEVROLET	G10
1980	V6-3.8L	BUICK	SKYHAWK	1981	V8-5.0L	GMC	G1500
1980	V6-3.8L	CHEVROLET	IMPALA	1981	V8-5.0L	GMC	G2500

**FAN CLUTCHES**

USMW	Years	Cyl.	Specifications
1986	V8-5.0L	CADILLAC	FLEETWOOD
1987-1990	V8-5.0L	CADILLAC	BROUGHAM
1958	V8-5.2L	PLYMOUTH	PLAZA
1958-1964	V8-5.2L	PLYMOUTH	SAVOY
1958-1970	V8-5.2L	PLYMOUTH	BELVEDERE
1958-1978	V8-5.2L	PLYMOUTH	FURY
1965-1974	V8-5.2L	PLYMOUTH	SATELLITE
1968-1974	V8-5.2L	PLYMOUTH	BARRACUDA
1968-1975	V8-5.2L	PLYMOUTH	ROADRUNNER
1968-1976	V8-5.2L	PLYMOUTH	VALIANT
1969-1975	V8-5.2L	PLYMOUTH	VALIANT SUPER BEE (MEX)
1970-1976	V8-5.2L	PLYMOUTH	DUSTER
1971-1976	V8-5.2L	PLYMOUTH	SCAMP
1972-1989	V8-5.2L	PLYMOUTH	GRAN FURY
1974-1975	V8-5.2L	PLYMOUTH	VOYAGER
1974-1979	V8-5.2L	PLYMOUTH	TRAILDUSTER 2WD
1974-1979	V8-5.2L	PLYMOUTH	TRAILDUSTER 4WD
1976-1980	V8-5.2L	PLYMOUTH	PB100
1976-1980	V8-5.2L	PLYMOUTH	PB200
1976-1980	V8-5.2L	PLYMOUTH	PB300
1980	V8-5.2L	DODGE	ASPEN
1980	V8-5.2L	DODGE	B100
1980	V8-5.2L	DODGE	B200
1980	V8-5.2L	DODGE	B300
1980	V8-5.2L	DODGE	CB300
1980	V8-5.2L	DODGE	D200
1980	V8-5.2L	DODGE	D300
1980	V8-5.2L	DODGE	RD200
1980	V8-5.2L	DODGE	W200
1980	V8-5.2L	DODGE	W300
1980	V8-5.2L	PLYMOUTH	VOLARE
1980-1981	V8-5.2L	CHRYSLER	LEBARON
1980-1981	V8-5.2L	CHRYSLER	NEW YORKER
1980-1981	V8-5.2L	CHRYSLER	NEWPORT
1980-1981	V8-5.2L	CHRYSLER	TOWN & COUNTRY
1980-1981	V8-5.2L	DODGE	ST. REGIS
1980-1981	V8-5.2L	PLYMOUTH	TRAILDUSTER
1980-1983	V8-5.2L	CHRYSLER	CORDOBA
1980-1983	V8-5.2L	DODGE	MIRADA
1980-1989	V8-5.2L	DODGE	D150
1980-1989	V8-5.2L	DODGE	DIPLOMAT
1980-1989	V8-5.2L	DODGE	W150
1980-1991	V8-5.2L	DODGE	RAMCHARGER
1981-1982	V8-5.2L	CHRYSLER	IMPERIAL
1981-1983	V8-5.2L	DODGE	D350
1981-1983	V8-5.2L	PLYMOUTH	PB150
1981-1983	V8-5.2L	PLYMOUTH	PB250
1981-1983	V8-5.2L	PLYMOUTH	PB350
1981-1989	V8-5.2L	DODGE	B150
1981-1989	V8-5.2L	DODGE	B250
1981-1989	V8-5.2L	DODGE	B350
1981-1989	V8-5.2L	DODGE	D250
1981-1989	V8-5.2L	DODGE	W250
1982-1983	V8-5.2L	DODGE	W350
1983-1989	V8-5.2L	CHRYSLER	FIFTH AVENUE
1986-1989	V8-5.2L	DODGE	D100
1986-1989	V8-5.2L	DODGE	W100
1966-1967	V8-5.6L	BUICK	SKYLARK
1967	V8-5.6L	BUICK	LESABRE
1968-1973	V8-5.6L	PLYMOUTH	BARRACUDA
1970-1973	V8-5.6L	PLYMOUTH	DUSTER
1971-1973	V8-5.6L	PLYMOUTH	ROADRUNNER
1972	V8-5.6L	PLYMOUTH	SATELLITE
1968-1969	V8-5.7L	BUICK	SPECIAL
1968-1979	V8-5.7L	BUICK	SKYLARK
1968-1980	V8-5.7L	BUICK	LESABRE
1973-1977	V8-5.7L	BUICK	REGAL
1973-1979	V8-5.7L	BUICK	CENTURY
1975-1978	V8-5.7L	PONTIAC	GRAND LEMANS

USMW	Years	Cyl.	Specifications
1976-1977	V8-5.7L	PONTIAC	GRAND LEMANS (CAN)
1976-1979	V8-5.7L	PONTIAC	LAURENTIAN (CAN)
1976-1979	V8-5.7L	PONTIAC	PARISIENNE (CAN)
1977	V8-5.7L	PONTIAC	GRAND SAFARI S/W
1977-1979	V8-5.7L	BUICK	RIVIERA
1977-1980	V8-5.7L	BUICK	ELECTRA
1977-1980	V8-5.7L	BUICK	ESTATE WAGON
1978-1979	V8-5.7L	BUICK	ELECTRA PARK AVENUE
1978-1979	V8-5.7L	CHEVROLET	CAPRICE
1978-1979	V8-5.7L	CHEVROLET	EL CAMINO
1978-1979	V8-5.7L	CHEVROLET	IMPALA
1978-1979	V8-5.7L	GMC	CABALLERO
1979-1980	V8-5.7L	CHEVROLET	MALIBU
1980	V8-5.7L	PONTIAC	BONNEVILLE
1980	V8-5.7L	PONTIAC	CATALINA
1982-1985	V8-5.7L	CADILLAC	FLEETWOOD
1983	V8-5.7L	CADILLAC	ELDORADO
1983-1984	V8-5.7L	CADILLAC	DEVILLE
1959-1964	V8-5.9L	PLYMOUTH	SAVOY
1959-1966	V8-5.9L	PLYMOUTH	BELVEDERE
1959-1977	V8-5.9L	PLYMOUTH	FURY
1965-1974	V8-5.9L	PLYMOUTH	SATELLITE
1973-1980	V8-5.9L	PLYMOUTH	GRAN FURY
1974	V8-5.9L	PLYMOUTH	BARRACUDA
1974-1975	V8-5.9L	PLYMOUTH	ROADRUNNER
1974-1975	V8-5.9L	PLYMOUTH	VOYAGER
1974-1976	V8-5.9L	PLYMOUTH	DUSTER
1974-1978	V8-5.9L	PLYMOUTH	TRAILDUSTER 2WD
1974-1979	V8-5.9L	PLYMOUTH	TRAILDUSTER 4WD
1974-1979	V8-5.9L	PLYMOUTH	VALIANT SUPER BEE (MEX)
1976	V8-5.9L	PLYMOUTH	VALIANT
1976-1978	V8-5.9L	PLYMOUTH	PB100
1976-1980	V8-5.9L	PLYMOUTH	PB200
1976-1980	V8-5.9L	PLYMOUTH	PB300
1978-1979	V8-5.9L	PLYMOUTH	CARAVELLE (CAN)
1980	V8-5.9L	CHRYSLER	NEW YORKER
1980	V8-5.9L	CHRYSLER	NEWPORT
1980	V8-5.9L	DODGE	ASPEN
1980	V8-5.9L	DODGE	B200
1980	V8-5.9L	DODGE	B300
1980	V8-5.9L	DODGE	CB300
1980	V8-5.9L	DODGE	D200
1980	V8-5.9L	DODGE	D300
1980	V8-5.9L	DODGE	MIRADA
1980	V8-5.9L	DODGE	RD200
1980	V8-5.9L	DODGE	ST. REGIS
1980	V8-5.9L	DODGE	W200
1980	V8-5.9L	DODGE	W300
1980	V8-5.9L	PLYMOUTH	VOLARE
1980-1981	V8-5.9L	DODGE	D400
1980-1981	V8-5.9L	DODGE	D450
1980-1981	V8-5.9L	PLYMOUTH	TRAILDUSTER
1980-1989	V8-5.9L	DODGE	D150
1980-1989	V8-5.9L	DODGE	W150
1980-1991	V8-5.9L	DODGE	RAMCHARGER
1981	V8-5.9L	PLYMOUTH	PB250
1981-1983	V8-5.9L	PLYMOUTH	PB350
1981-1989	V8-5.9L	DODGE	B250
1981-1989	V8-5.9L	DODGE	B350
1981-1989	V8-5.9L	DODGE	D250
1981-1989	V8-5.9L	DODGE	D350
1981-1989	V8-5.9L	DODGE	W250
1981-1989	V8-5.9L	DODGE	W350
1986-1988	V8-5.9L	DODGE	D100
1986-1988	V8-5.9L	DODGE	W100
1959	V8-6.3L	DODGE	CORONET
1960-1964	V8-6.3L	PLYMOUTH	SAVOY
1960-1970	V8-6.3L	PLYMOUTH	BELVEDERE
1962-1966	V8-6.3L	CHRYSLER	300

USMW	Years	Cyl.	Specifications	USMW	Years	Cyl.	Specifications
	1963-1964	V8-6.3L	DODGE 880		1987-1988	L6-4.8L	CHEVROLET R30
	1963-1965	V8-6.3L	DODGE CUSTOM		1987-1988	L6-4.8L	CHEVROLET V30
	1963-1970	V8-6.3L	PLYMOUTH FURY		1987-1988	L6-4.8L	GMC R2500
	1964	V8-6.3L	DODGE 330		1987-1988	L6-4.8L	GMC R3500
	1964	V8-6.3L	DODGE 440		1987-1988	L6-4.8L	GMC V3500
	1964-1967	V8-6.3L	DODGE D200 3/4 TON		1986	V6-2.8L	CHEVROLET S10
	1964-1967	V8-6.3L	DODGE D300 1 TON		1986	V6-2.8L	CHEVROLET S10 BLAZER
	1964-1967	V8-6.3L	DODGE W200 3/4 TON		1986	V6-2.8L	GMC S15
	1964-1971	V8-6.3L	DODGE D100 1/2 TON		1986	V6-2.8L	GMC S15 JIMMY
	1964-1971	V8-6.3L	DODGE W100 1/2 TON		1980-1981	V6-3.8L	CHEVROLET CAMARO
	1965-1971	V8-6.3L	CHRYSLER NEWPORT		1985	V6-4.3L	CHEVROLET IMPALA
	1965-1971	V8-6.3L	PLYMOUTH SATELLITE		1985-1986	V6-4.3L	CHEVROLET CAPRICE
	1966-1971	V8-6.3L	CHRYSLER TOWN & COUNTRY		1985-1986	V6-4.3L	GMC G3500
	1967-1971	V8-6.3L	PLYMOUTH BARRACUDA		1985-1986	V6-4.3L	GMC SAFARI
	1968-1971	V8-6.3L	PLYMOUTH ROADRUNNER		1985-1986	V6-4.3L	PONTIAC PARISIENNE
	1976-1978	V8-6.6L	PLYMOUTH PB200		1968-1969	V6-5.0L	GMC C1500 1/2 TON
	1976-1978	V8-6.6L	PLYMOUTH PB300		1968-1969	V6-5.0L	GMC C2500 3/4 TON
	1976-1978	V8-6.6L	PLYMOUTH TRAILDUSTER 2WD		1968-1969	V6-5.0L	GMC C3500 1 TON
	1976-1978	V8-6.6L	PLYMOUTH TRAILDUSTER 4WD		1968-1969	V6-5.0L	GMC K1500 1/2 TON
	1959	V8-6.7L	CHRYSLER 300E		1968-1969	V6-5.0L	GMC K2500 3/4 TON
	1959-1965	V8-6.7L	CHRYSLER IMPERIAL		1968-1969	V6-5.0L	GMC K2500 3/4 TON SUBURBAN
	1959-1965	V8-6.7L	CHRYSLER NEW YORKER		1975	V8-4.3L	BUICK APOLLO
	1960-1965	V8-6.7L	CHRYSLER 300		1975-1976	V8-4.3L	BUICK SKYLARK
	1961-1962	V8-6.7L	DODGE DART		1975-1976	V8-4.3L	PONTIAC VENTURA
	1962-1965	V8-6.7L	DODGE POLARA		1977-1979	V8-4.3L	OLDSMOBILE 88
	1963	V8-6.7L	DODGE 880		1980-1981	V8-4.3L	BUICK CENTURY
	1965	V8-6.7L	DODGE MONACO		1980-1981	V8-4.3L	BUICK REGAL
	1967	V8-7.2L	PLYMOUTH BELVEDERE		1980-1981	V8-4.3L	OLDSMOBILE DELTA 88
	1967	V8-7.2L	PLYMOUTH FURY		1980-1981	V8-4.3L	PONTIAC BONNEVILLE
	1967-1970	V8-7.2L	PLYMOUTH GTX		1980-1981	V8-4.3L	PONTIAC CATALINA
	1968-1974	V8-7.2L	PLYMOUTH SATELLITE		1980-1981	V8-4.3L	PONTIAC GRAND LEMANS
	1969-1974	V8-7.2L	PLYMOUTH ROADRUNNER		1980-1981	V8-4.3L	PONTIAC GRAND PRIX
	1970-1971	V8-7.2L	PLYMOUTH BARRACUDA		1980-1981	V8-4.3L	PONTIAC LEMANS
	1970-1976	V8-7.5L	BUICK ELECTRA		1981	V8-4.3L	PONTIAC FIREBIRD
	1970-1976	V8-7.5L	BUICK ESTATE WAGON		1994-1996	V8-4.3L	CHEVROLET CAPRICE
	1970-1976	V8-7.5L	BUICK LESABRE		1979	V8-4.4L	PONTIAC GRAND LEMANS (CAN)
	1970-1976	V8-7.5L	BUICK RIVIERA		1980-1981	V8-4.4L	CHEVROLET CAMARO
	1971-1972	V8-7.5L	BUICK SKYLARK		1981	V8-4.4L	CHEVROLET MONTE CARLO
	1973-1974	V8-7.5L	BUICK CENTURY		1981-1982	V8-4.4L	CHEVROLET MALIBU
	1973-1974	V8-7.5L	BUICK REGAL		1982	V8-4.4L	CHEVROLET CAPRICE
<b>22044</b>	1986-1987	L4-2.3L	FORD AEROSTAR		1982	V8-4.4L	CHEVROLET IMPALA
<b>22045</b>	1982	L4-2.5L	CHEVROLET CAMARO		1977	V8-4.9L	PONTIAC VENTURA
	1968-1974	L6-4.1L	GMC C3500 1 TON		1977-1979	V8-4.9L	PONTIAC FIREBIRD
	1968-1976	L6-4.1L	PONTIAC LEMANS		1977-1980	V8-4.9L	PONTIAC BONNEVILLE
	1968-1979	L6-4.1L	CHEVROLET C30 1 TON		1977-1980	V8-4.9L	PONTIAC CATALINA
	1968-1979	L6-4.1L	GMC C2500 3/4 TON		1977-1980	V8-4.9L	PONTIAC GRAND PRIX
	1973-1975	L6-4.1L	BUICK APOLLO		1977-1981	V8-4.9L	PONTIAC LEMANS
	1964-1979	L6-4.8L	CHEVROLET P30 VAN		1978-1980	V8-4.9L	PONTIAC GRAND AM
	1968-1979	L6-4.8L	CHEVROLET C30 1 TON		1979	V8-4.9L	OLDSMOBILE 88
	1968-1979	L6-4.8L	CHEVROLET P20 VAN		1979	V8-4.9L	PONTIAC TRANS AM
	1968-1979	L6-4.8L	GMC C2500 3/4 TON		1980-1981	V8-4.9L	PONTIAC GRAND LEMANS
	1968-1979	L6-4.8L	GMC C3500 1 TON		1968-1973	V8-5.0L	CHEVROLET P20 VAN
	1970-1979	L6-4.8L	GMC P2500 VAN		1968-1973	V8-5.0L	CHEVROLET P30 VAN
	1970-1979	L6-4.8L	GMC P3500 VAN		1968-1973	V8-5.0L	GMC C3500 1 TON
	1975-1979	L6-4.8L	CHEVROLET P10 VAN		1968-1978	V8-5.0L	CHEVROLET K20 3/4 TON
	1975-1979	L6-4.8L	GMC P1500 VAN		1968-1979	V8-5.0L	CHEVROLET C10 1/2 TON
	1984	L6-4.8L	GMC C2500 SUBURBAN		1968-1979	V8-5.0L	CHEVROLET C10 1/2 TON SUBURBAN
	1984	L6-4.8L	GMC K2500 SUBURBAN		1968-1979	V8-5.0L	CHEVROLET C20 3/4 TON
	1984-1986	L6-4.8L	CHEVROLET C20		1968-1979	V8-5.0L	CHEVROLET C30 1 TON
	1984-1986	L6-4.8L	CHEVROLET C30		1968-1979	V8-5.0L	CHEVROLET K10 1/2 TON
	1984-1986	L6-4.8L	CHEVROLET K20		1969-1973	V8-5.0L	GMC K2500 3/4 TON
	1984-1986	L6-4.8L	CHEVROLET K30		1969-1973	V8-5.0L	GMC K2500 3/4 TON SUBURBAN
	1984-1986	L6-4.8L	GMC C2500		1969-1979	V8-5.0L	CHEVROLET BLAZER 4WD
	1984-1986	L6-4.8L	GMC C3500		1969-1979	V8-5.0L	GMC C1500 1/2 TON
	1984-1986	L6-4.8L	GMC K2500		1969-1979	V8-5.0L	GMC C2500 3/4 TON
	1984-1986	L6-4.8L	GMC K3500		1969-1979	V8-5.0L	GMC K1500 1/2 TON
	1987	L6-4.8L	CHEVROLET V20		1970	V8-5.0L	GMC K3500 1 TON
	1987	L6-4.8L	GMC V2500		1970-1979	V8-5.0L	CHEVROLET BLAZER 2WD
	1987-1988	L6-4.8L	CHEVROLET R20		1970-1979	V8-5.0L	GMC JIMMY 2WD

USMW	Years	Cyl.	Specifications
1970-1979	V8-5.0L	GMC JIMMY 4WD	
1971-1977	V8-5.0L	PONTIAC VENTURA	
1973	V8-5.0L	CHEVROLET G10 1/2 TON VAN	
1975-1979	V8-5.0L	FORD F100 1/2 TON	
1976-1979	V8-5.0L	FORD F150 1/2 TON	
1977-1978	V8-5.0L	CHEVROLET G20 3/4 TON VAN	
1977-1980	V8-5.0L	PONTIAC LEMANS	
1977-1985	V8-5.0L	PONTIAC FIREBIRD	
1978-1979	V8-5.0L	CHEVROLET G30 1 TON VAN	
1978-1980	V8-5.0L	PONTIAC GRAND AM	
1978-1984	V8-5.0L	PONTIAC GRAND PRIX	
1979	V8-5.0L	GMC G1500 1/2 TON VAN	
1980	V8-5.0L	BUICK CENTURY	
1980	V8-5.0L	BUICK REGAL	
1980	V8-5.0L	BUICK RIVIERA	
1980	V8-5.0L	CHEVROLET G10	
1980	V8-5.0L	CHEVROLET G20	
1980	V8-5.0L	CHEVROLET K20	
1980	V8-5.0L	GMC G1500	
1980	V8-5.0L	GMC G2500	
1980	V8-5.0L	OLDSMOBILE CUTLASS	
1980	V8-5.0L	OLDSMOBILE CUTLASS CALAIS	
1980	V8-5.0L	OLDSMOBILE CUTLASS SALON	
1980	V8-5.0L	OLDSMOBILE CUTLASS SUPREME	
1980	V8-5.0L	PONTIAC GRAND LEMANS	
1980-1981	V8-5.0L	OLDSMOBILE CUTLASS CRUISER	
1980-1982	V8-5.0L	CHEVROLET CAMARO	
1980-1984	V8-5.0L	CHEVROLET C10 SUBURBAN	
1980-1984	V8-5.0L	CHEVROLET C20	
1980-1984	V8-5.0L	CHEVROLET K10 SUBURBAN	
1980-1984	V8-5.0L	GMC C1500 SUBURBAN	
1980-1984	V8-5.0L	GMC C2500	
1980-1985	V8-5.0L	CHEVROLET IMPALA	
1980-1988	V8-5.0L	CHEVROLET CAPRICE	
1981	V8-5.0L	GMC G3500	
1981-1984	V8-5.0L	CHEVROLET K10	
1981-1984	V8-5.0L	GMC K1500	
1982-1983	V8-5.0L	BUICK ESTATE WAGON	
1982-1983	V8-5.0L	CHEVROLET MALIBU	
1982-1984	V8-5.0L	BUICK ELECTRA	
1982-1984	V8-5.0L	GMC C2500 SUBURBAN	
1982-1987	V8-5.0L	GMC CABALLERO	
1982-1990	V8-5.0L	BUICK LESABRE	
1983-1984	V8-5.0L	CHEVROLET C10	
1983-1984	V8-5.0L	CHEVROLET C20 SUBURBAN	
1983-1984	V8-5.0L	CHEVROLET K5 BLAZER	
1983-1984	V8-5.0L	GMC C1500	
1983-1984	V8-5.0L	GMC JIMMY	
1983-1984	V8-5.0L	GMC K1500 SUBURBAN	
1983-1984	V8-5.0L	PONTIAC BONNEVILLE	
1983-1986	V8-5.0L	PONTIAC PARISIENNE	
1984-1988	V8-5.0L	CHEVROLET MONTE CARLO	
1986	V8-5.0L	FORD F200 (MEX)	
1960-1977	V8-5.2L	PLYMOUTH FURY	
1980	V8-5.2L	DODGE B100	
1980	V8-5.2L	DODGE B200	
1980	V8-5.2L	DODGE B300	
1980	V8-5.2L	DODGE CB300	
1980	V8-5.2L	DODGE D200	
1980	V8-5.2L	DODGE D300	
1980	V8-5.2L	DODGE RD200	
1980	V8-5.2L	DODGE W200	
1980	V8-5.2L	DODGE W300	
1980	V8-5.2L	PLYMOUTH PB100	
1980	V8-5.2L	PLYMOUTH PB200	
1980	V8-5.2L	PLYMOUTH PB300	
1980-1981	V8-5.2L	DODGE D150	
1980-1981	V8-5.2L	DODGE RAMCHARGER	
1980-1981	V8-5.2L	DODGE W150	

USMW	Years	Cyl.	Specifications
1980-1981	V8-5.2L	PLYMOUTH TRAILDUSTER	
1981	V8-5.2L	CHRYSLER CORDOBA	
1981	V8-5.2L	CHRYSLER IMPERIAL	
1981	V8-5.2L	CHRYSLER LEBARON	
1981	V8-5.2L	CHRYSLER NEWPORT	
1981	V8-5.2L	CHRYSLER TOWN & COUNTRY	
1981	V8-5.2L	DODGE B150	
1981	V8-5.2L	DODGE B250	
1981	V8-5.2L	DODGE B350	
1981	V8-5.2L	DODGE D250	
1981	V8-5.2L	DODGE D350	
1981	V8-5.2L	DODGE MIRADA	
1981	V8-5.2L	DODGE ST. REGIS	
1981	V8-5.2L	DODGE W250	
1981	V8-5.2L	PLYMOUTH PB150	
1981	V8-5.2L	PLYMOUTH PB250	
1981	V8-5.2L	PLYMOUTH PB350	
1981-1982	V8-5.2L	CHRYSLER NEW YORKER	
1981-1989	V8-5.2L	DODGE DIPLOMAT	
1981-1989	V8-5.2L	PLYMOUTH GRAN FURY	
1984-1989	V8-5.2L	CHRYSLER FIFTH AVENUE	
1968-1970	V8-5.7L	PONTIAC TEMPEST	
1968-1977	V8-5.7L	OLDSMOBILE VISTA CRUISER	
1968-1979	V8-5.7L	PONTIAC FIREBIRD	
1968-1979	V8-5.7L	PONTIAC LEMANS	
1968-1981	V8-5.7L	OLDSMOBILE CUTLASS	
1969-1979	V8-5.7L	CHEVROLET BLAZER 4WD	
1969-1979	V8-5.7L	CHEVROLET C10 1/2 TON	
1969-1979	V8-5.7L	CHEVROLET C10 1/2 TON SUBURBAN	
1969-1979	V8-5.7L	CHEVROLET C20 3/4 TON	
1969-1979	V8-5.7L	CHEVROLET C30 1 TON	
1969-1979	V8-5.7L	CHEVROLET K10 1/2 TON	
1969-1979	V8-5.7L	CHEVROLET K20 3/4 TON	
1969-1979	V8-5.7L	GMC C1500 1/2 TON	
1969-1979	V8-5.7L	GMC C2500 3/4 TON	
1969-1979	V8-5.7L	GMC C3500 1 TON	
1969-1979	V8-5.7L	GMC K1500 1/2 TON	
1969-1979	V8-5.7L	GMC K2500 3/4 TON	
1969-1979	V8-5.7L	GMC K2500 3/4 TON SUBURBAN	
1969-1979	V8-5.7L	OLDSMOBILE 88	
1970-1979	V8-5.7L	CHEVROLET BLAZER 2WD	
1970-1979	V8-5.7L	CHEVROLET P20 VAN	
1970-1979	V8-5.7L	CHEVROLET P30 VAN	
1970-1979	V8-5.7L	GMC JIMMY 2WD	
1970-1979	V8-5.7L	GMC JIMMY 4WD	
1970-1979	V8-5.7L	GMC K3500 1 TON	
1970-1979	V8-5.7L	GMC P2500 VAN	
1970-1979	V8-5.7L	GMC P3500 VAN	
1970-1981	V8-5.7L	PONTIAC CATALINA	
1970-1984	V8-5.7L	PONTIAC BONNEVILLE	
1970-1996	V8-5.7L	CHEVROLET IMPALA	
1972-1974	V8-5.7L	PONTIAC TRANS AM	
1972-1977	V8-5.7L	PONTIAC VENTURA	
1973	V8-5.7L	BUICK CENTURION	
1973-1975	V8-5.7L	BUICK APOLLO	
1973-1975	V8-5.7L	PONTIAC GRAND AM	
1973-1978	V8-5.7L	CHEVROLET P10 VAN	
1973-1979	V8-5.7L	OLDSMOBILE OMEGA	
1973-1984	V8-5.7L	OLDSMOBILE CUSTOM CRUISER	
1974-1979	V8-5.7L	GMC G2500 3/4 TON VAN	
1976-1977	V8-5.7L	PONTIAC LEMANS (CAN)	
1976-1984	V8-5.7L	PONTIAC GRAND PRIX	
1977-1979	V8-5.7L	CHEVROLET K30 1 TON	
1977-1984	V8-5.7L	OLDSMOBILE 98	
1978-1983	V8-5.7L	OLDSMOBILE CUTLASS CRUISER	
1979-1985	V8-5.7L	OLDSMOBILE TORONADO	
1980-1981	V8-5.7L	CHEVROLET CAMARO	
1980-1981	V8-5.7L	GMC G1500	
1980-1982	V8-5.7L	CHEVROLET K30	



USMW	Years	Cyl.	Specifications
1980-1982	V8-5.7L	GMC K2500	SUBURBAN
1980-1982	V8-5.7L	GMC K3500	
1980-1983	V8-5.7L	BUICK	ESTATE WAGON
1980-1983	V8-5.7L	CHEVROLET	MALIBU
1980-1984	V8-5.7L	CHEVROLET	C10
1980-1984	V8-5.7L	CHEVROLET	C10 SUBURBAN
1980-1984	V8-5.7L	CHEVROLET	C20 SUBURBAN
1980-1984	V8-5.7L	CHEVROLET	C30
1980-1984	V8-5.7L	CHEVROLET	K10
1980-1984	V8-5.7L	CHEVROLET	K10 SUBURBAN
1980-1984	V8-5.7L	CHEVROLET	K20
1980-1984	V8-5.7L	CHEVROLET	K20 SUBURBAN
1980-1984	V8-5.7L	CHEVROLET	K5 BLAZER
1980-1984	V8-5.7L	GMC	C1500
1980-1984	V8-5.7L	GMC	C1500 SUBURBAN
1980-1984	V8-5.7L	GMC	C2500
1980-1984	V8-5.7L	GMC	C2500 SUBURBAN
1980-1984	V8-5.7L	GMC	C3500
1980-1984	V8-5.7L	GMC	K1500
1980-1984	V8-5.7L	GMC	K1500 SUBURBAN
1980-1984	V8-5.7L	GMC	K2500
1980-1984	V8-5.7L	OLDSMOBILE	CUTLASS CALAIS
1980-1984	V8-5.7L	OLDSMOBILE	CUTLASS SUPREME
1980-1985	V8-5.7L	BUICK	ELECTRA
1980-1985	V8-5.7L	BUICK	LESABRE
1980-1985	V8-5.7L	OLDSMOBILE	CUTLASS SALON
1980-1985	V8-5.7L	OLDSMOBILE	DELTA 88
1980-1986	V8-5.7L	CHEVROLET	C20
1980-1988	V8-5.7L	GMC	G3500
1980-1989	V8-5.7L	GMC	JIMMY
1980-1996	V8-5.7L	CHEVROLET	CAPRICE
1981	V8-5.7L	BUICK	CENTURY
1981-1985	V8-5.7L	BUICK	RIVIERA
1982-1984	V8-5.7L	CHEVROLET	MONTE CARLO
1982-1985	V8-5.7L	BUICK	REGAL
1983-1984	V8-5.7L	CHEVROLET	EL CAMINO
1983-1984	V8-5.7L	GMC	CABALLERO
1983-1985	V8-5.7L	PONTIAC	PARISIENNE
1987	V8-5.7L	GMC	C1500 (MEX)
1987	V8-5.7L	GMC	C2500 (MEX)
1987	V8-5.7L	GMC	C3500 (MEX)
1987	V8-5.7L	GMC	R2500 SUBURBAN
1987	V8-5.7L	GMC	V3500
1987-1988	V8-5.7L	CHEVROLET	R30
1987-1988	V8-5.7L	CHEVROLET	V30
1989	V8-5.7L	CHEVROLET	R2500
1989-1990	V8-5.7L	CHEVROLET	R2500 SUBURBAN
1989-1990	V8-5.7L	CHEVROLET	V2500 SUBURBAN
1989-1990	V8-5.7L	GMC	V2500 SUBURBAN
1989-1991	V8-5.7L	CHEVROLET	R3500
1989-1991	V8-5.7L	CHEVROLET	V3500
1994-1995	V8-5.7L	CHEVROLET	P30
1994-1996	V8-5.7L	BUICK	COMMERCIAL CHASSIS
1994-1996	V8-5.7L	BUICK	ROADMASTER
1994-1996	V8-5.7L	CADILLAC	COMMERCIAL CHASSIS
1994-1996	V8-5.7L	CADILLAC	FLEETWOOD
1994-1996	V8-5.7L	GMC	P3500
1977-1979	V8-5.8L	FORD	F100 1/2 TON
1977-1979	V8-5.8L	FORD	F150 1/2 TON
1986-1987	V8-5.8L	FORD	F200 (MEX)
1972	V8-5.9L	PLYMOUTH	GRAN FURY
1972-1973	V8-5.9L	JEEP	J-PICKUP
1972-1978	V8-5.9L	PLYMOUTH	FURY
1980	V8-5.9L	DODGE	B200
1980	V8-5.9L	DODGE	B300
1980	V8-5.9L	DODGE	CB300
1980	V8-5.9L	DODGE	D200
1980	V8-5.9L	DODGE	D300
1980	V8-5.9L	DODGE	RD200

USMW	Years	Cyl.	Specifications
1980	V8-5.9L	DODGE	W200
1980	V8-5.9L	DODGE	W300
1980	V8-5.9L	PLYMOUTH	PB200
1980	V8-5.9L	PLYMOUTH	PB300
1980-1981	V8-5.9L	DODGE	D150
1980-1981	V8-5.9L	DODGE	D400
1980-1981	V8-5.9L	DODGE	D450
1980-1981	V8-5.9L	DODGE	W150
1980-1981	V8-5.9L	PLYMOUTH	TRAILDUSTER
1980-1992	V8-5.9L	DODGE	RAMCHARGER
1981	V8-5.9L	DODGE	B250
1981	V8-5.9L	DODGE	B350
1981	V8-5.9L	PLYMOUTH	PB250
1981	V8-5.9L	PLYMOUTH	PB350
1981-1992	V8-5.9L	DODGE	D250
1981-1992	V8-5.9L	DODGE	D350
1981-1992	V8-5.9L	DODGE	W250
1981-1992	V8-5.9L	DODGE	W350
1960-1971	V8-6.3L	PLYMOUTH	FURY
1965-1966	V8-6.3L	PLYMOUTH	BELVEDERE
1959-1966	V8-6.4L	PONTIAC	BONNEVILLE
1959-1966	V8-6.4L	PONTIAC	CATALINA
1959-1966	V8-6.4L	PONTIAC	STAR CHIEF
1960-1961	V8-6.4L	PONTIAC	VENTURA
1960-1965	V8-6.4L	PONTIAC	SAFARI WAGON
1962-1966	V8-6.4L	PONTIAC	GRAND PRIX
1964-1965	V8-6.4L	PONTIAC	LEMANS
1964-1966	V8-6.4L	PONTIAC	GTO
1968	V8-6.5L	GMC	K2500 3/4 TON SUBURBAN
1968-1969	V8-6.5L	GMC	C1500 1/2 TON
1968-1969	V8-6.5L	GMC	C2500 3/4 TON
1968-1969	V8-6.5L	GMC	C3500 1 TON
1968-1969	V8-6.5L	GMC	K1500 1/2 TON
1968-1969	V8-6.5L	GMC	K2500 3/4 TON
1969	V8-6.5L	CHEVROLET	C20 3/4 TON
1969	V8-6.5L	CHEVROLET	C30 1 TON
1969	V8-6.5L	CHEVROLET	CAPRICE
1969	V8-6.5L	CHEVROLET	IMPALA
1969	V8-6.5L	CHEVROLET	K10 1/2 TON
1969	V8-6.5L	CHEVROLET	K20 3/4 TON
1959-1963	V8-6.6L	BUICK	INVICTA
1959-1979	V8-6.6L	BUICK	ELECTRA
1962-1978	V8-6.6L	BUICK	LESABRE
1963-1966	V8-6.6L	BUICK	WILDCAT
1963-1978	V8-6.6L	BUICK	RIVIERA
1965-1966	V8-6.6L	BUICK	SKYLARK
1965-1969	V8-6.6L	BUICK	GRAN SPORT
1967-1972	V8-6.6L	PONTIAC	GTO
1967-1977	V8-6.6L	PONTIAC	GRAND PRIX
1967-1979	V8-6.6L	PONTIAC	BONNEVILLE
1967-1979	V8-6.6L	PONTIAC	CATALINA
1967-1979	V8-6.6L	PONTIAC	FIREBIRD
1970	V8-6.6L	PONTIAC	TEMPEST
1970-1972	V8-6.6L	CHEVROLET	BISCAYNE
1970-1972	V8-6.6L	CHEVROLET	C10 1/2 TON SUBURBAN
1970-1972	V8-6.6L	GMC	C1500 1/2 TON
1970-1972	V8-6.6L	GMC	C3500 1 TON
1970-1975	V8-6.6L	CHEVROLET	BELAIR
1970-1975	V8-6.6L	CHEVROLET	MONTE CARLO
1970-1976	V8-6.6L	CHEVROLET	IMPALA
1970-1977	V8-6.6L	PONTIAC	LEMANS
1970-1978	V8-6.6L	GMC	C2500 3/4 TON
1970-1979	V8-6.6L	CHEVROLET	C10 1/2 TON
1970-1979	V8-6.6L	CHEVROLET	C20 3/4 TON
1970-1979	V8-6.6L	CHEVROLET	C30 1 TON
1970-1979	V8-6.6L	GMC	K1500 1/2 TON
1971-1975	V8-6.6L	GMC	SPRINT
1971-1979	V8-6.6L	CHEVROLET	K10 1/2 TON
1971-1979	V8-6.6L	CHEVROLET	K20 3/4 TON

USMW	Years	Cyl.	Specifications
1971-1979	V8-6.6L	GMC	K2500 3/4 TON
1971-1979	V8-6.6L	GMC	K2500 3/4 TON SUBURBAN
1972-1979	V8-6.6L	PONTIAC	TRANS AM
1973-1975	V8-6.6L	PONTIAC	GRAND AM
1974-1976	V8-6.6L	CHEVROLET	LAGUNA
1975-1977	V8-6.6L	PONTIAC	GRAND LEMANS
1975-1979	V8-6.6L	CHEVROLET	BLAZER 4WD
1975-1979	V8-6.6L	CHEVROLET	G20 3/4 TON VAN
1975-1979	V8-6.6L	CHEVROLET	G30 1 TON VAN
1975-1979	V8-6.6L	GMC	G2500 3/4 TON VAN
1975-1979	V8-6.6L	GMC	G3500 1 TON VAN
1975-1979	V8-6.6L	GMC	JIMMY 4WD
1975-1979	V8-6.6L	OLDSMOBILE	88
1975-1979	V8-6.6L	OLDSMOBILE	98
1975-1979	V8-6.6L	OLDSMOBILE	CUSTOM CRUISER
1976	V8-6.6L	GMC	JIMMY 2WD
1976	V8-6.6L	PONTIAC	LAURENTIAN (CAN)
1976	V8-6.6L	PONTIAC	PARISIENNE (CAN)
1976-1978	V8-6.6L	PONTIAC	GRAND SAFARI S/W
1976-1979	V8-6.6L	GMC	G1500 1/2 TON VAN
1977	V8-6.6L	CHEVROLET	P10 VAN
1977	V8-6.6L	OLDSMOBILE	CUTLASS
1977	V8-6.6L	OLDSMOBILE	VISTA CRUISER
1977-1978	V8-6.6L	OLDSMOBILE	TORONADO
1977-1979	V8-6.6L	BUICK	ESTATE WAGON
1977-1979	V8-6.6L	CHEVROLET	K30 1 TON
1977-1979	V8-6.6L	FORD	F100 1/2 TON
1977-1979	V8-6.6L	GMC	K3500 1 TON
1978-1979	V8-6.6L	BUICK	ELECTRA PARK AVENUE
1980	V8-6.6L	CHEVROLET	G20
1980	V8-6.6L	CHEVROLET	G30
1980	V8-6.6L	CHEVROLET	K10
1980	V8-6.6L	CHEVROLET	K20
1980	V8-6.6L	CHEVROLET	K20 SUBURBAN
1980	V8-6.6L	CHEVROLET	K30
1980	V8-6.6L	GMC	G2500
1980	V8-6.6L	GMC	G3500
1980	V8-6.6L	GMC	K1500
1980	V8-6.6L	GMC	K2500
1980	V8-6.6L	GMC	K2500 SUBURBAN
1980	V8-6.6L	GMC	K3500
1963-1965	V8-6.9L	PONTIAC	SAFARI WAGON
1963-1966	V8-6.9L	PONTIAC	BONNEVILLE
1963-1966	V8-6.9L	PONTIAC	CATALINA
1963-1966	V8-6.9L	PONTIAC	GRAND PRIX
1963-1966	V8-6.9L	PONTIAC	STAR CHIEF
1966	V8-6.9L	PONTIAC	EXECUTIVE
1963-1969	V8-7.0L	BUICK	RIVIERA
1964	V8-7.0L	BUICK	LESABRE
1964-1967	V8-7.0L	CADILLAC	DEVILLE
1964-1967	V8-7.0L	CADILLAC	ELDORADO
1964-1969	V8-7.0L	BUICK	ELECTRA
1964-1969	V8-7.0L	BUICK	WILDCAT
1965	V8-7.0L	OLDSMOBILE	JETSTAR
1965-1966	V8-7.0L	OLDSMOBILE	DYNAMIC 88
1965-1966	V8-7.0L	OLDSMOBILE	STARFIRE
1965-1967	V8-7.0L	CADILLAC	CALAIS
1965-1967	V8-7.0L	OLDSMOBILE	98
1965-1967	V8-7.0L	OLDSMOBILE	DELTA 88
1966-1967	V8-7.0L	OLDSMOBILE	TORONADO
1967	V8-7.0L	OLDSMOBILE	DELMONT 88
1967-1969	V8-7.0L	PONTIAC	BONNEVILLE
1967-1969	V8-7.0L	PONTIAC	CATALINA
1967-1969	V8-7.0L	PONTIAC	EXECUTIVE
1967-1969	V8-7.0L	PONTIAC	GRAND PRIX
1969	V8-7.0L	CHEVROLET	IMPALA
1966-1978	V8-7.2L	PLYMOUTH	FURY
1972-1977	V8-7.2L	PLYMOUTH	GRAN FURY
1973-1978	V8-7.2L	DODGE	D100 1/2 TON

USMW	Years	Cyl.	Specifications
1974-1978	V8-7.2L	DODGE	RAMCHARGER 4WD
1975-1978	V8-7.2L	DODGE	D200 3/4 TON
1975-1978	V8-7.2L	DODGE	D300 1 TON
1975-1978	V8-7.2L	DODGE	RAMCHARGER 2WD
1976-1978	V8-7.2L	PLYMOUTH	PB200
1976-1978	V8-7.2L	PLYMOUTH	PB300
1977-1979	V8-7.2L	DODGE	CB300
1970-1972	V8-7.4L	CHEVROLET	BISCAYNE
1970-1975	V8-7.4L	CHEVROLET	BELAIR
1970-1975	V8-7.4L	CHEVROLET	MONTE CARLO
1970-1976	V8-7.4L	CHEVROLET	IMPALA
1971	V8-7.4L	GMC	P2500 VAN
1971-1975	V8-7.4L	GMC	SPRINT
1971-1979	V8-7.4L	GMC	P3500 VAN
1973	V8-7.4L	CHEVROLET	P10 VAN
1973-1974	V8-7.4L	CHEVROLET	G10 1/2 TON VAN
1973-1974	V8-7.4L	CHEVROLET	G20 3/4 TON VAN
1973-1974	V8-7.4L	GMC	K2500 3/4 TON
1973-1975	V8-7.4L	CHEVROLET	LAGUNA
1973-1976	V8-7.4L	GMC	JIMMY 4WD
1973-1978	V8-7.4L	CHEVROLET	K20 3/4 TON
1973-1979	V8-7.4L	CHEVROLET	C10 1/2 TON
1973-1979	V8-7.4L	CHEVROLET	C10 1/2 TON SUBURBAN
1973-1979	V8-7.4L	CHEVROLET	C20 3/4 TON
1973-1979	V8-7.4L	CHEVROLET	C30 1 TON
1973-1979	V8-7.4L	CHEVROLET	P20 VAN
1973-1979	V8-7.4L	CHEVROLET	P30 VAN
1973-1979	V8-7.4L	GMC	C1500 1/2 TON
1973-1979	V8-7.4L	GMC	C2500 3/4 TON
1973-1979	V8-7.4L	GMC	C3500 1 TON
1974	V8-7.4L	CHEVROLET	G30 1 TON VAN
1974	V8-7.4L	GMC	K2500 3/4 TON SUBURBAN
1974-1979	V8-7.4L	CHEVROLET	K10 1/2 TON
1974-1979	V8-7.4L	GMC	K1500 1/2 TON
1974-1979	V8-7.4L	GMC	K3500 1 TON
1976	V8-7.4L	GMC	G3500 1 TON VAN
1977	V8-7.4L	CHEVROLET	BLAZER 4WD
1977	V8-7.4L	CHEVROLET	K30 1 TON
1978	V8-7.4L	CHEVROLET	BLAZER 2WD
1979	V8-7.4L	GMC	P1500 VAN
1980	V8-7.4L	CHEVROLET	C10
1980	V8-7.4L	CHEVROLET	C10 SUBURBAN
1980	V8-7.4L	CHEVROLET	K10
1980	V8-7.4L	CHEVROLET	K20
1980	V8-7.4L	GMC	C1500
1980	V8-7.4L	GMC	C1500 SUBURBAN
1980	V8-7.4L	GMC	K1500
1980-1986	V8-7.4L	CHEVROLET	C20
1980-1986	V8-7.4L	CHEVROLET	C20 SUBURBAN
1980-1986	V8-7.4L	CHEVROLET	C30
1980-1986	V8-7.4L	CHEVROLET	K30
1980-1986	V8-7.4L	GMC	C2500
1980-1986	V8-7.4L	GMC	C2500 SUBURBAN
1980-1986	V8-7.4L	GMC	C3500
1980-1986	V8-7.4L	GMC	K3500
1985	V8-7.4L	CHEVROLET	K20 SUBURBAN
1986-1997	V8-7.4L	CHEVROLET	P30
1986-1997	V8-7.4L	GMC	P3500
1987-1988	V8-7.4L	CHEVROLET	R20
1987-1988	V8-7.4L	CHEVROLET	R20 SUBURBAN
1987-1988	V8-7.4L	CHEVROLET	R30
1987-1988	V8-7.4L	CHEVROLET	V20 SUBURBAN
1987-1988	V8-7.4L	CHEVROLET	V30
1987-1989	V8-7.4L	GMC	R2500
1987-1991	V8-7.4L	GMC	R2500 SUBURBAN
1987-1991	V8-7.4L	GMC	R3500
1987-1991	V8-7.4L	GMC	V3500
1989	V8-7.4L	CHEVROLET	R2500
1989-1991	V8-7.4L	CHEVROLET	R2500 SUBURBAN

USMW	Years	Cyl.	Specifications
	1989-1991	V8-7.4L	CHEVROLET R3500
	1989-1991	V8-7.4L	CHEVROLET V3500
	1990	V8-7.4L	CHEVROLET V2500 SUBURBAN
	1968	V8-7.5L	OLDSMOBILE DELMONT 88
	1968	V8-7.5L	OLDSMOBILE DELTA 88
	1968-1971	V8-7.5L	OLDSMOBILE 442
	1968-1976	V8-7.5L	OLDSMOBILE 98
	1968-1976	V8-7.5L	OLDSMOBILE TORONADO
	1969-1976	V8-7.5L	OLDSMOBILE 88
	1970	V8-7.5L	BUICK WILDCAT
	1970	V8-7.5L	PONTIAC EXECUTIVE
	1970-1972	V8-7.5L	BUICK GRAN SPORT
	1970-1972	V8-7.5L	OLDSMOBILE F85
	1970-1972	V8-7.5L	PONTIAC GTO
	1970-1976	V8-7.5L	OLDSMOBILE CUTLASS
	1970-1976	V8-7.5L	OLDSMOBILE VISTA CRUISER
	1970-1976	V8-7.5L	PONTIAC BONNEVILLE
	1970-1976	V8-7.5L	PONTIAC CATALINA
	1970-1976	V8-7.5L	PONTIAC GRAND PRIX
	1970-1976	V8-7.5L	PONTIAC LEMANS
	1971-1973	V8-7.5L	BUICK CENTURION
	1971-1974	V8-7.5L	PONTIAC FIREBIRD
	1971-1975	V8-7.5L	PONTIAC GRANDVILLE
	1971-1976	V8-7.5L	OLDSMOBILE CUSTOM CRUISER
	1972-1976	V8-7.5L	PONTIAC GRAND SAFARI S/W
	1972-1976	V8-7.5L	PONTIAC TRANS AM
	1973-1975	V8-7.5L	PONTIAC GRAND AM
	1975-1976	V8-7.5L	PONTIAC GRAND LEMANS
	1976	V8-7.5L	PONTIAC LAURENTIAN (CAN)
	1976	V8-7.5L	PONTIAC PARISIENNE (CAN)
	1968-1970	V8-7.7L	CADILLAC 60 SPECIAL
	1968-1974	V8-7.7L	CADILLAC CALAIS
	1968-1974	V8-7.7L	CADILLAC DEVILLE
	1968-1974	V8-7.7L	CADILLAC FLEETWOOD 75
	1970-1976	V8-8.2L	CADILLAC ELDORADO
	1975-1976	V8-8.2L	CADILLAC CALAIS
	1975-1976	V8-8.2L	CADILLAC DEVILLE
	1975-1976	V8-8.2L	CADILLAC FLEETWOOD 75
	1976	V8-8.2L	CADILLAC FLEETWOOD BROUGHAM
<b>22048</b>	1982-1984	L4-1.9L	CHEVROLET S10
	1982-1984	L4-1.9L	GMC S15
	1983-1984	L4-1.9L	CHEVROLET S10 BLAZER
	1983-1984	L4-1.9L	GMC S15 JIMMY
	1983-1984	L4-2.0L	CHEVROLET S10
	1983-1984	L4-2.0L	CHEVROLET S10 BLAZER
	1983-1984	L4-2.0L	GMC S15
	1983-1984	L4-2.0L	GMC S15 JIMMY
	1980-1981	L4-2.5L	AMERICAN MOTORS CONCORD
	1980-1981	L4-2.5L	AMERICAN MOTORS SPIRIT
	1980-1983	L4-2.5L	JEEP CJ5
	1980-1986	L4-2.5L	JEEP CJ7
	1981-1984	L4-2.5L	AMERICAN MOTORS EAGLE
	1981-1985	L4-2.5L	JEEP SCRAMBLER
	1984-1987	L4-2.5L	JEEP WAGONEER
	1984-1993	L4-2.5L	JEEP CHEROKEE
	1985	L4-2.5L	CHEVROLET S10
	1985	L4-2.5L	CHEVROLET S10 BLAZER
	1985	L4-2.5L	GMC S15
	1985	L4-2.5L	GMC S15 JIMMY
	1986-1992	L4-2.5L	JEEP COMANCHE
	1987-1995	L4-2.5L	JEEP WRANGLER
	1980	L6-4.2L	AMERICAN MOTORS AMX
	1980	L6-4.2L	AMERICAN MOTORS PACER
	1980-1983	L6-4.2L	AMERICAN MOTORS CONCORD
	1980-1983	L6-4.2L	AMERICAN MOTORS SPIRIT
	1980-1988	L6-4.2L	AMERICAN MOTORS EAGLE
	1987-1990	L6-4.2L	JEEP WRANGLER
	1982-1983	V6-2.8L	CHEVROLET S10
	1982-1985	V6-2.8L	GMC S15

USMW	Years	Cyl.	Specifications
	1983	V6-2.8L	CHEVROLET S10 BLAZER
	1983-1985	V6-2.8L	GMC S15 JIMMY
	1984-1986	V6-2.8L	JEEP CHEROKEE
	1984-1986	V6-2.8L	JEEP WAGONEER
	1986	V6-2.8L	JEEP COMANCHE
<b>22049</b>	1981-1986	L4-1.8L	CHEVROLET CHEVETTE
	1977-1978	L4-2.0L	AMERICAN MOTORS GREMLIN
	1978-1979	L4-2.0L	AMERICAN MOTORS CONCORD
	1979	L4-2.0L	AMERICAN MOTORS SPIRIT
	1971-1977	L4-2.3L	CHEVROLET VEGA
	1975-1977	L4-2.3L	CHEVROLET MONZA
	1964	L4-2.5L	GMC G1000 1/2 TON VAN
	1969-1970	L4-2.5L	CHEVROLET NOVA
	1977	L4-2.5L	PONTIAC ASTRE
	1977	L4-2.5L	PONTIAC VENTURA
	1977-1978	L4-2.5L	PONTIAC PHOENIX
	1977-1980	L4-2.5L	PONTIAC SUNBIRD
	1978-1980	L4-2.5L	CHEVROLET MONZA
	1978-1980	L4-2.5L	OLDSMOBILE STARFIRE
	1982-1986	L4-2.5L	CHEVROLET CAMARO
	1982-1986	L4-2.5L	PONTIAC FIREBIRD
	1965	L6-3.2L	GMC G1000 1/2 TON VAN
	1966-1970	L6-3.3L	AMERICAN MOTORS CLASSIC (MEX)
	1969-1970	L6-3.3L	AMERICAN MOTORS AMERICAN (MEX)
	1961-1965	L6-3.8L	CHEVROLET C20 3/4 TON
	1961-1965	L6-3.8L	CHEVROLET C30 1 TON
	1961-1965	L6-3.8L	CHEVROLET K10 1/2 TON
	1961-1965	L6-3.8L	CHEVROLET K20 3/4 TON
	1961-1966	L6-3.8L	CHEVROLET C10 1/2 TON
	1961-1966	L6-3.8L	CHEVROLET C10 1/2 TON SUBURBAN
	1963-1965	L6-3.8L	CHEVROLET P20 VAN
	1963-1965	L6-3.8L	CHEVROLET P30 VAN
	1963-1965	L6-3.8L	GMC K1000 1/2 TON
	1963-1965	L6-3.8L	GMC PB1500 VAN
	1963-1965	L6-3.8L	GMC PB2500 VAN
	1963-1966	L6-3.8L	GMC C1000 1/2 TON
	1963-1966	L6-3.8L	GMC PB1000 VAN
	1963-1969	L6-3.8L	CHEVROLET P10 VAN
	1964-1965	L6-3.8L	GMC C1500 3/4 TON
	1964-1965	L6-3.8L	GMC C2500 1 TON
	1964-1965	L6-3.8L	GMC K1500 3/4 TON
	1964-1969	L6-3.8L	CHEVROLET CHEVELLE
	1964-1969	L6-3.8L	CHEVROLET EL CAMINO
	1964-1969	L6-3.8L	CHEVROLET MALIBU
	1965	L6-3.8L	CHECKER MARATHON
	1965	L6-3.8L	CHECKER TOWN CUSTOM
	1965-1967	L6-3.8L	AMERICAN MOTORS MARLIN
	1965-1970	L6-3.8L	AMERICAN MOTORS AMBASSADOR
	1966	L6-3.8L	CHECKER MARATHON LIMO
	1966	L6-3.8L	GMC G1000 VAN
	1966-1968	L6-3.8L	CHECKER MARATHON SEDAN
	1966-1969	L6-3.8L	CHEVROLET G10 1/2 TON VAN
	1967-1968	L6-3.8L	CHECKER MARATHON WAGON
	1967-1969	L6-3.8L	CHEVROLET CAMARO
	1967-1969	L6-3.8L	CHEVROLET G20 3/4 TON VAN
	1967-1969	L6-3.8L	GMC G1500 1/2 TON VAN
	1967-1969	L6-3.8L	GMC G2500 3/4 TON VAN
	1967-1969	L6-3.8L	GMC P1500 VAN
	1967-1970	L6-3.8L	AMERICAN MOTORS REBEL
	1967-1974	L6-3.8L	AMERICAN MOTORS CLASSIC (MEX)
	1968-1969	L6-3.8L	GMC K1500 1/2 TON
	1968-1970	L6-3.8L	CHEVROLET NOVA
	1968-1974	L6-3.8L	AMERICAN MOTORS JAVELIN
	1969-1971	L6-3.8L	INTERNATIONAL PICKUP
	1969-1971	L6-3.8L	INTERNATIONAL TRAVELLALL
	1969-1974	L6-3.8L	AMERICAN MOTORS AMERICAN (MEX)
	1970-1977	L6-3.8L	AMERICAN MOTORS HORNET
	1970-1978	L6-3.8L	AMERICAN MOTORS GREMLIN
	1971	L6-3.8L	INTERNATIONAL METRO

**FAN CLUTCHES**

USMW	Years	Cyl.	Specifications
1971	L6-3.8L	INTERNATIONAL SCOUT	
1971-1974	L6-3.8L	AMERICAN MOTORS MATADOR	
1972-1974	L6-3.8L	JEEP DJ5	
1972-1975	L6-3.8L	JEEP CJ6	
1972-1978	L6-3.8L	JEEP CJ5	
1975-1978	L6-3.8L	AMERICAN MOTORS PACER	
1976-1978	L6-3.8L	JEEP CJ7	
1978-1979	L6-3.8L	AMERICAN MOTORS CONCORD	
1979	L6-3.8L	AMERICAN MOTORS SPIRIT	
1968	L6-3.9L	INTERNATIONAL METRO	
1968-1970	L6-3.9L	INTERNATIONAL PICKUP	
1968-1970	L6-3.9L	INTERNATIONAL TRAVELALL	
1966	L6-4.1L	GMC 1000 1/2 TON	
1966	L6-4.1L	GMC 1001 1/2 TON	
1966	L6-4.1L	GMC 1500 3/4 TON	
1966	L6-4.1L	GMC 1501 3/4 TON	
1966	L6-4.1L	GMC 2500 1 TON	
1966	L6-4.1L	GMC C1000 1/2 TON	
1966	L6-4.1L	GMC K1000 1/2 TON	
1966	L6-4.1L	GMC K1500 3/4 TON	
1966	L6-4.1L	GMC PB1500 VAN	
1966	L6-4.1L	GMC PB2500 VAN	
1966-1967	L6-4.1L	CHEVROLET C30 1 TON	
1966-1971	L6-4.1L	OLDSMOBILE F85	
1966-1974	L6-4.1L	CHEVROLET P20 VAN	
1966-1976	L6-4.1L	CHEVROLET K20 3/4 TON	
1966-1977	L6-4.1L	CHEVROLET C10 1/2 TON	
1966-1977	L6-4.1L	CHEVROLET C10 1/2 TON SUBURBAN	
1966-1977	L6-4.1L	CHEVROLET C20 3/4 TON	
1966-1977	L6-4.1L	CHEVROLET K10 1/2 TON	
1966-1979	L6-4.1L	CHEVROLET P30 VAN	
1967-1974	L6-4.1L	CHEVROLET P10 VAN	
1967-1974	L6-4.1L	GMC P2500 VAN	
1967-1974	L6-4.1L	GMC P3500 VAN	
1967-1975	L6-4.1L	GMC C3500 1 TON	
1967-1976	L6-4.1L	GMC K2500 3/4 TON	
1967-1976	L6-4.1L	OLDSMOBILE CUTLASS	
1967-1977	L6-4.1L	CHEVROLET EL CAMINO	
1967-1977	L6-4.1L	GMC C1500 1/2 TON	
1967-1977	L6-4.1L	GMC C2500 3/4 TON	
1967-1977	L6-4.1L	GMC K1500 1/2 TON	
1967-1979	L6-4.1L	CHEVROLET CAMARO	
1967-1979	L6-4.1L	CHEVROLET G10 1/2 TON VAN	
1967-1979	L6-4.1L	GMC G1500 1/2 TON VAN	
1968-1970	L6-4.1L	PONTIAC TEMPEST	
1968-1974	L6-4.1L	GMC K2500 3/4 TON SUBURBAN	
1968-1974	L6-4.1L	GMC P1500 VAN	
1968-1976	L6-4.1L	PONTIAC FIREBIRD	
1968-1979	L6-4.1L	CHEVROLET G20 3/4 TON VAN	
1968-1979	L6-4.1L	GMC G2500 3/4 TON VAN	
1969-1972	L6-4.1L	CHEVROLET BISCAYNE	
1969-1973	L6-4.1L	CHEVROLET CHEVELLE	
1969-1977	L6-4.1L	CHEVROLET BLAZER 4WD	
1969-1977	L6-4.1L	CHEVROLET MALIBU	
1969-1979	L6-4.1L	CHEVROLET IMPALA	
1969-1979	L6-4.1L	CHEVROLET NOVA	
1970	L6-4.1L	PONTIAC LEMANS	
1970-1973	L6-4.1L	CHEVROLET BELAIR	
1970-1974	L6-4.1L	GMC K3500 1 TON	
1970-1977	L6-4.1L	CHEVROLET BLAZER 2WD	
1970-1977	L6-4.1L	GMC JIMMY 2WD	
1970-1977	L6-4.1L	GMC JIMMY 4WD	
1971	L6-4.1L	CHECKER MARATHON DELUX LIMO	
1971-1974	L6-4.1L	CHECKER MARATHON SEDAN	
1971-1974	L6-4.1L	CHECKER MARATHON WAGON	
1971-1976	L6-4.1L	PONTIAC VENTURA	
1971-1977	L6-4.1L	GMC SPRINT	
1971-1979	L6-4.1L	CHEVROLET G30 1 TON VAN	
1971-1979	L6-4.1L	GMC G3500 1 TON VAN	

USMW	Years	Cyl.	Specifications
1972-1974	L6-4.1L	CHECKER MARATHON DELUXE	
1973-1976	L6-4.1L	OLDSMOBILE OMEGA	
1974-1976	L6-4.1L	CHEVROLET CHEVELLE MALIBU	
1975-1976	L6-4.1L	PONTIAC GRAND LEMANS	
1975-1979	L6-4.1L	CHECKER MARATHON	
1977	L6-4.1L	PONTIAC GRAND LEMANS (CAN)	
1977-1979	L6-4.1L	CHEVROLET CAPRICE	
1977-1979	L6-4.1L	PONTIAC LAURENTIAN (CAN)	
1977-1979	L6-4.1L	PONTIAC PARISIENNE (CAN)	
1980-1984	L6-4.1L	CHEVROLET G10	
1980-1984	L6-4.1L	CHEVROLET G20	
1980-1984	L6-4.1L	GMC G1500	
1980-1984	L6-4.1L	GMC G2500	
1981-1984	L6-4.1L	CHEVROLET G30	
1982-1984	L6-4.1L	GMC G3500	
1971	L6-4.2L	AMERICAN MOTORS AMBASSADOR	
1971-1974	L6-4.2L	AMERICAN MOTORS JAVELIN	
1971-1977	L6-4.2L	AMERICAN MOTORS HORNET	
1971-1978	L6-4.2L	AMERICAN MOTORS GREMLIN	
1971-1978	L6-4.2L	AMERICAN MOTORS MATADOR	
1972-1973	L6-4.2L	JAGUAR XJ6	
1972-1974	L6-4.2L	AMERICAN MOTORS CLASSIC (MEX)	
1972-1974	L6-4.2L	INTERNATIONAL METRO	
1972-1974	L6-4.2L	INTERNATIONAL PICKUP	
1972-1974	L6-4.2L	INTERNATIONAL TRAVELALL	
1972-1975	L6-4.2L	JEEP CJ6	
1972-1979	L6-4.2L	JEEP CJ5	
1973-1974	L6-4.2L	JEEP DJ5	
1973-1980	L6-4.2L	AMERICAN MOTORS AMERICAN (MEX)	
1974	L6-4.2L	JEEP CHEROKEE 2WD	
1974-1975	L6-4.2L	JEEP CHEROKEE 4WD	
1974-1976	L6-4.2L	JEEP J20	
1974-1979	L6-4.2L	JEEP J10	
1975-1979	L6-4.2L	AMERICAN MOTORS PACER	
1976-1979	L6-4.2L	JEEP CHEROKEE	
1976-1979	L6-4.2L	JEEP CJ7	
1978-1979	L6-4.2L	AMERICAN MOTORS AMX	
1978-1979	L6-4.2L	AMERICAN MOTORS CONCORD	
1979	L6-4.2L	AMERICAN MOTORS SPIRIT	
1979-1980	L6-4.2L	AMERICAN MOTORS GREMLIN (MEX)	
1969-1970	L6-4.3L	INTERNATIONAL SCOUT	
1972-1976	L6-4.6L	AMERICAN MOTORS CLASSIC (MEX)	
1975-1980	L6-4.6L	AMERICAN MOTORS AMERICAN (MEX)	
1979-1980	L6-4.6L	AMERICAN MOTORS GREMLIN (MEX)	
1980	L6-4.6L	AMERICAN MOTORS LERMA (MEX)	
1963-1967	L6-4.8L	CHEVROLET C30 1 TON	
1963-1974	L6-4.8L	CHEVROLET C10 1/2 TON SUBURBAN	
1963-1977	L6-4.8L	CHEVROLET C10 1/2 TON	
1963-1977	L6-4.8L	CHEVROLET C20 3/4 TON	
1964-1966	L6-4.8L	GMC C1000 1/2 TON	
1964-1966	L6-4.8L	GMC K1000 1/2 TON	
1964-1967	L6-4.8L	CHEVROLET P20 VAN	
1964-1976	L6-4.8L	CHEVROLET K10 1/2 TON	
1964-1977	L6-4.8L	CHEVROLET K20 3/4 TON	
1966	L6-4.8L	GMC K1500 3/4 TON	
1967	L6-4.8L	CHEVROLET P10 VAN	
1967-1976	L6-4.8L	GMC K1500 1/2 TON	
1967-1977	L6-4.8L	GMC C1500 1/2 TON	
1967-1977	L6-4.8L	GMC C2500 3/4 TON	
1967-1977	L6-4.8L	GMC C3500 1 TON	
1967-1977	L6-4.8L	GMC K2500 3/4 TON	
1967-1977	L6-4.8L	GMC K2500 3/4 TON SUBURBAN	
1970-1971	L6-4.8L	CHEVROLET BLAZER 2WD	
1970-1973	L6-4.8L	CHEVROLET BLAZER 4WD	
1973	L6-4.8L	GMC JIMMY 4WD	
1973-1977	L6-4.8L	CHEVROLET K30 1 TON	
1974-1977	L6-4.8L	GMC K3500 1 TON	
1985-1989	L6-4.8L	CHEVROLET P30	
1985-1989	L6-4.8L	GMC P3500	



USMW	Years	Cyl.	Specifications	USMW	Years	Cyl.	Specifications
1966	L6-5.0L	GMC K1000 1/2 TON		1961-1966	V6-5.0L	GMC C1000 1/2 TON	
1982-1984	V6-2.8L	CHEVROLET CAMARO		1961-1966	V6-5.0L	GMC K1000 1/2 TON	
1982-1984	V6-2.8L	PONTIAC FIREBIRD		1961-1966	V6-5.0L	GMC K1500 3/4 TON	
1978-1979	V6-3.2L	CHEVROLET MONZA		1966	V6-5.0L	GMC 1002 1/2 TON	
1978-1979	V6-3.3L	PONTIAC GRAND LEMANS (CAN)		1967	V6-5.0L	GMC C1500 1/2 TON	
1966	V6-3.8L	CHEVROLET CHEVELLE		1967	V6-5.0L	GMC C2500 3/4 TON	
1978-1980	V6-3.8L	CHEVROLET MONZA		1967	V6-5.0L	GMC K1500 1/2 TON	
1980	V6-3.8L	PONTIAC GRAND LEMANS		1967	V6-5.0L	GMC K2500 3/4 TON	
1980	V6-3.8L	PONTIAC LEMANS		1967	V6-5.0L	GMC K2500 3/4 TON SUBURBAN	
1980-1981	V6-3.8L	OLDSMOBILE CUTLASS		1982-1983	V8-4.1L	CADILLAC DEVILLE	
1980-1982	V6-3.8L	CHEVROLET MALIBU		1982-1983	V8-4.1L	CADILLAC FLEETWOOD	
1980-1982	V6-3.8L	OLDSMOBILE CUTLASS CRUISER		1982-1985	V8-4.1L	CADILLAC ELDERADO	
1980-1984	V6-3.8L	CHEVROLET CAPRICE		1982-1985	V8-4.1L	CADILLAC SEVILLE	
1980-1984	V6-3.8L	CHEVROLET EL CAMINO		1968	V8-4.3L	INTERNATIONAL METRO	
1980-1984	V6-3.8L	CHEVROLET IMPALA		1968	V8-4.3L	INTERNATIONAL SCOUT	
1980-1984	V6-3.8L	CHEVROLET MONTE CARLO		1968-1969	V8-4.3L	INTERNATIONAL PICKUP	
1980-1984	V6-3.8L	GMC CABALLERO		1968-1970	V8-4.3L	INTERNATIONAL TRAVELALL	
1980-1984	V6-3.8L	OLDSMOBILE CUTLASS CALAIS		1975	V8-4.3L	CHEVROLET NOVA	
1980-1985	V6-3.8L	OLDSMOBILE DELTA 88		1975-1976	V8-4.3L	CHEVROLET MONZA	
1980-1987	V6-3.8L	OLDSMOBILE CUTLASS SALON		1975-1977	V8-4.3L	OLDSMOBILE OMEGA	
1980-1987	V6-3.8L	OLDSMOBILE CUTLASS SUPREME		1975-1981	V8-4.3L	OLDSMOBILE CUTLASS	
1981	V6-3.8L	BUICK CENTURY		1978-1982	V8-4.3L	OLDSMOBILE CUTLASS CRUISER	
1981	V6-3.8L	CHEVROLET CAMARO		1980-1981	V8-4.3L	OLDSMOBILE CUTLASS SALON	
1981-1985	V6-3.8L	BUICK LESABRE		1980-1982	V8-4.3L	OLDSMOBILE CUTLASS CALAIS	
1981-1985	V6-3.8L	BUICK RIVIERA		1980-1982	V8-4.3L	OLDSMOBILE CUTLASS SUPREME	
1981-1987	V6-3.8L	BUICK REGAL		1981	V8-4.3L	BUICK CENTURY	
1982-1986	V6-3.8L	PONTIAC BONNEVILLE		1981	V8-4.3L	BUICK REGAL	
1982-1987	V6-3.8L	PONTIAC GRAND PRIX		1982	V8-4.3L	OLDSMOBILE DELTA 88	
1984	V6-3.8L	PONTIAC PARISIENNE		1979	V8-4.4L	PONTIAC LEMANS (CAN)	
1980-1984	V6-4.1L	BUICK ELECTRA		1980-1981	V8-4.4L	CHECKER MARATHON DELUXE	
1981-1982	V6-4.1L	CADILLAC ELDERADO		1980-1982	V8-4.4L	CHECKER MARATHON	
1982	V6-4.1L	CADILLAC SEVILLE		1980-1982	V8-4.4L	CHEVROLET CAPRICE	
1982	V6-4.1L	PONTIAC BONNEVILLE		1980-1982	V8-4.4L	CHEVROLET EL CAMINO	
1982	V6-4.1L	PONTIAC GRAND PRIX		1980-1982	V8-4.4L	CHEVROLET MALIBU	
1982-1983	V6-4.1L	OLDSMOBILE 98		1980-1982	V8-4.4L	CHEVROLET MONTE CARLO	
1982-1984	V6-4.1L	BUICK LESABRE		1980-1982	V8-4.4L	GMC CABALLERO	
1982-1984	V6-4.1L	BUICK REGAL		1982	V8-4.4L	CHEVROLET IMPALA	
1982-1984	V6-4.1L	BUICK RIVIERA		1957	V8-4.6L	CHEVROLET ONE-FIFTY	
1982-1984	V6-4.1L	OLDSMOBILE TORONADO		1957	V8-4.6L	CHEVROLET TWO-TEN	
1982-1983	V6-4.3L	CHEVROLET MALIBU		1958	V8-4.6L	CHEVROLET 3100 1/2 TON	
1982-1984	V6-4.3L	BUICK REGAL		1958	V8-4.6L	CHEVROLET 3101 1/2 TON	
1982-1984	V6-4.3L	OLDSMOBILE CUTLASS CALAIS		1958	V8-4.6L	CHEVROLET 3102 1/2 TON	
1982-1984	V6-4.3L	OLDSMOBILE CUTLASS SUPREME		1958	V8-4.6L	CHEVROLET 3200 1/2 TON	
1982-1988	V6-4.3L	CHEVROLET MONTE CARLO		1958	V8-4.6L	CHEVROLET 3201 1/2 TON	
1985	V6-4.3L	CHEVROLET IMPALA		1958	V8-4.6L	CHEVROLET 3600 3/4 TON	
1985	V6-4.3L	CHEVROLET K20		1958	V8-4.6L	CHEVROLET 3601 3/4 TON	
1985	V6-4.3L	GMC K2500		1958	V8-4.6L	CHEVROLET 3602 3/4 TON	
1985-1986	V6-4.3L	CHEVROLET C10		1958	V8-4.6L	CHEVROLET 3603 3/4 TON	
1985-1986	V6-4.3L	CHEVROLET C20		1958	V8-4.6L	CHEVROLET DELRAY	
1985-1986	V6-4.3L	CHEVROLET K10		1961-1967	V8-4.6L	CHEVROLET C10 1/2 TON	
1985-1986	V6-4.3L	GMC C1500		1961-1967	V8-4.6L	CHEVROLET C10 1/2 TON SUBURBAN	
1985-1986	V6-4.3L	GMC C2500		1961-1967	V8-4.6L	CHEVROLET C20 3/4 TON	
1985-1986	V6-4.3L	GMC G1500		1961-1967	V8-4.6L	CHEVROLET C30 1 TON	
1985-1986	V6-4.3L	GMC G2500		1961-1967	V8-4.6L	CHEVROLET K10 1/2 TON	
1985-1986	V6-4.3L	GMC K1500		1961-1967	V8-4.6L	CHEVROLET K20 3/4 TON	
1985-1986	V6-4.3L	PONTIAC PARISIENNE		1962	V8-4.6L	CHEVROLET P20 VAN	
1985-1987	V6-4.3L	CHEVROLET EL CAMINO		1962	V8-4.6L	CHEVROLET P30 VAN	
1985-1987	V6-4.3L	GMC CABALLERO		1967	V8-4.6L	GMC C2500 3/4 TON	
1985-1988	V6-4.3L	CHEVROLET CAPRICE		1967	V8-4.6L	GMC G1500 1/2 TON VAN	
1986	V6-4.3L	PONTIAC BONNEVILLE		1967	V8-4.6L	GMC G2500 3/4 TON VAN	
1986-1987	V6-4.3L	PONTIAC GRAND PRIX		1967	V8-4.6L	GMC K2500 3/4 TON	
1987	V6-4.3L	CHEVROLET R10		1967	V8-4.6L	GMC K2500 3/4 TON SUBURBAN	
1987	V6-4.3L	CHEVROLET R20		1967	V8-4.6L	GMC P1500 VAN	
1987	V6-4.3L	CHEVROLET V10		1965-1967	V8-4.7L	AMERICAN MOTORS MARLIN	
1987	V6-4.3L	GMC R1500		1967-1969	V8-4.7L	AMERICAN MOTORS REBEL	
1987	V6-4.3L	GMC R2500		1968-1969	V8-4.7L	AMERICAN MOTORS AMX	
1987	V6-4.3L	GMC V1500		1967-1969	V8-4.9L	CHEVROLET CAMARO	
1961-1965	V6-5.0L	GMC C1500 3/4 TON		1980	V8-4.9L	BUICK CENTURY	
1961-1965	V6-5.0L	GMC C2500 1 TON		1980	V8-4.9L	BUICK ELECTRA	

**FAN CLUTCHES**



# FAN CLUTCH BUYER'S GUIDE



USMW	Years	Cyl.	Specifications
	1980	V8-4.9L	<b>BUICK</b> ESTATE WAGON
	1980	V8-4.9L	<b>BUICK</b> LESABRE
	1980	V8-4.9L	<b>BUICK</b> REGAL
	1964-1975	V8-5.0L	<b>INTERNATIONAL</b> PICKUP
	1966-1975	V8-5.0L	<b>INTERNATIONAL</b> TRAVELALL
	1968	V8-5.0L	<b>CHECKER</b> MARATHON SEDAN
	1968	V8-5.0L	<b>CHECKER</b> MARATHON WAGON
	1968	V8-5.0L	<b>CHEVROLET</b> BELAIR
	1968	V8-5.0L	<b>CHEVROLET</b> BISCAYNE
	1968-1972	V8-5.0L	<b>GMC</b> P2500 VAN
	1968-1972	V8-5.0L	<b>GMC</b> P3500 VAN
	1968-1973	V8-5.0L	<b>CHEVROLET</b> CHEVELLE
	1968-1973	V8-5.0L	<b>GMC</b> G2500 3/4 TON VAN
	1968-1978	V8-5.0L	<b>GMC</b> G1500 1/2 TON VAN
	1968-1978	V8-5.0L	<b>GMC</b> K2500 3/4 TON
	1968-1979	V8-5.0L	<b>CHEVROLET</b> G10 1/2 TON VAN
	1968-1979	V8-5.0L	<b>CHEVROLET</b> G20 3/4 TON VAN
	1968-1983	V8-5.0L	<b>CHEVROLET</b> MALIBU
	1968-1985	V8-5.0L	<b>CHEVROLET</b> IMPALA
	1968-1987	V8-5.0L	<b>CHEVROLET</b> EL CAMINO
	1968-1990	V8-5.0L	<b>CHEVROLET</b> CAPRICE
	1969-1975	V8-5.0L	<b>INTERNATIONAL</b> SCOUT
	1969-1979	V8-5.0L	<b>CHEVROLET</b> NOVA
	1969-1985	V8-5.0L	<b>CHEVROLET</b> CAMARO
	1970	V8-5.0L	<b>AMERICAN MOTORS</b> REBEL
	1970-1974	V8-5.0L	<b>AMERICAN MOTORS</b> AMBASSADOR
	1970-1974	V8-5.0L	<b>AMERICAN MOTORS</b> JAVELIN
	1970-1977	V8-5.0L	<b>AMERICAN MOTORS</b> HORNET
	1971-1973	V8-5.0L	<b>GMC</b> SPRINT
	1971-1974	V8-5.0L	<b>INTERNATIONAL</b> METRO
	1971-1977	V8-5.0L	<b>AMERICAN MOTORS</b> MATADOR
	1971-1979	V8-5.0L	<b>AMERICAN MOTORS</b> AMX
	1972	V8-5.0L	<b>JEEP</b> J-PICKUP
	1972-1973	V8-5.0L	<b>JEEP</b> COMMANDO
	1972-1975	V8-5.0L	<b>JEEP</b> CJ6
	1972-1976	V8-5.0L	<b>AMERICAN MOTORS</b> GREMLIN
	1972-1981	V8-5.0L	<b>JEEP</b> CJ5
	1974	V8-5.0L	<b>JEEP</b> DJ5
	1974-1979	V8-5.0L	<b>INTERNATIONAL</b> SCOUT II
	1976	V8-5.0L	<b>CHEVROLET</b> CHEVELLE MALIBU
	1976	V8-5.0L	<b>CHEVROLET</b> LAGUNA
	1976-1979	V8-5.0L	<b>CHEVROLET</b> MONZA
	1976-1980	V8-5.0L	<b>INTERNATIONAL</b> TERRA PICKUP
	1976-1980	V8-5.0L	<b>INTERNATIONAL</b> TRAVELER
	1976-1981	V8-5.0L	<b>JEEP</b> C7
	1977	V8-5.0L	<b>CHEVROLET</b> CAPRICE ESTATE WAGON
	1977-1978	V8-5.0L	<b>GMC</b> C1500 1/2 TON
	1977-1978	V8-5.0L	<b>GMC</b> C2500 3/4 TON
	1977-1978	V8-5.0L	<b>GMC</b> K1500 1/2 TON
	1977-1978	V8-5.0L	<b>GMC</b> K2500 3/4 TON SUBURBAN
	1977-1979	V8-5.0L	<b>OLDSMOBILE</b> OMEGA
	1977-1979	V8-5.0L	<b>OLDSMOBILE</b> STARFIRE
	1977-1979	V8-5.0L	<b>PONTIAC</b> LAURENTIAN (CAN)
	1977-1979	V8-5.0L	<b>PONTIAC</b> PARISIENNE (CAN)
	1977-1979	V8-5.0L	<b>PONTIAC</b> PHOENIX
	1977-1981	V8-5.0L	<b>CHECKER</b> MARATHON DELUXE
	1977-1982	V8-5.0L	<b>CHECKER</b> MARATHON
	1978	V8-5.0L	<b>GMC</b> C3500 1 TON
	1978-1979	V8-5.0L	<b>AMERICAN MOTORS</b> CONCORD
	1978-1979	V8-5.0L	<b>AMERICAN MOTORS</b> PACER
	1978-1979	V8-5.0L	<b>OLDSMOBILE</b> CUTLASS
	1978-1979	V8-5.0L	<b>PONTIAC</b> SUNBIRD
	1978-1983	V8-5.0L	<b>OLDSMOBILE</b> CUTLASS CRUISER
	1979	V8-5.0L	<b>AMERICAN MOTORS</b> SPIRIT
	1980-1984	V8-5.0L	<b>OLDSMOBILE</b> 98
	1980-1985	V8-5.0L	<b>OLDSMOBILE</b> DELTA 88
	1980-1985	V8-5.0L	<b>OLDSMOBILE</b> TORONADO
	1980-1986	V8-5.0L	<b>CHEVROLET</b> C10
	1980-1986	V8-5.0L	<b>CHEVROLET</b> C20 SUBURBAN

USMW	Years	Cyl.	Specifications
	1980-1986	V8-5.0L	<b>CHEVROLET</b> K5 BLAZER
	1980-1986	V8-5.0L	<b>GMC</b> C1500
	1980-1987	V8-5.0L	<b>GMC</b> CABALLERO
	1980-1987	V8-5.0L	<b>GMC</b> JIMMY
	1980-1988	V8-5.0L	<b>CHEVROLET</b> MONTE CARLO
	1980-1990	V8-5.0L	<b>OLDSMOBILE</b> CUSTOM CRUISER
	1981	V8-5.0L	<b>PONTIAC</b> CATALINA
	1981-1983	V8-5.0L	<b>BUICK</b> ESTATE WAGON
	1981-1985	V8-5.0L	<b>BUICK</b> RIVIERA
	1981-1985	V8-5.0L	<b>PONTIAC</b> FIREBIRD
	1981-1986	V8-5.0L	<b>PONTIAC</b> BONNEVILLE
	1981-1989	V8-5.0L	<b>BUICK</b> ELECTRA
	1981-1990	V8-5.0L	<b>BUICK</b> LESABRE
	1982	V8-5.0L	<b>CHEVROLET</b> G10
	1982-1983	V8-5.0L	<b>CHEVROLET</b> G20
	1982-1984	V8-5.0L	<b>OLDSMOBILE</b> CUTLASS CALAIS
	1982-1985	V8-5.0L	<b>GMC</b> K1500 SUBURBAN
	1982-1986	V8-5.0L	<b>CHEVROLET</b> C10 SUBURBAN
	1982-1986	V8-5.0L	<b>CHEVROLET</b> C20
	1982-1986	V8-5.0L	<b>CHEVROLET</b> K10
	1982-1986	V8-5.0L	<b>CHEVROLET</b> K10 SUBURBAN
	1982-1986	V8-5.0L	<b>GMC</b> C1500 SUBURBAN
	1982-1986	V8-5.0L	<b>GMC</b> C2500
	1982-1986	V8-5.0L	<b>GMC</b> C2500 SUBURBAN
	1982-1986	V8-5.0L	<b>GMC</b> G1500
	1982-1986	V8-5.0L	<b>GMC</b> G2500
	1982-1986	V8-5.0L	<b>GMC</b> K1500
	1982-1988	V8-5.0L	<b>OLDSMOBILE</b> CUTLASS SUPREME
	1983-1986	V8-5.0L	<b>PONTIAC</b> PARISIENNE
	1985	V8-5.0L	<b>CHEVROLET</b> K20
	1985-1986	V8-5.0L	<b>CHEVROLET</b> K20 SUBURBAN
	1985-1987	V8-5.0L	<b>OLDSMOBILE</b> CUTLASS SALON
	1985-1987	V8-5.0L	<b>PONTIAC</b> GRAND PRIX
	1986	V8-5.0L	<b>CHEVROLET</b> C30
	1986	V8-5.0L	<b>GMC</b> C3500
	1986-1987	V8-5.0L	<b>BUICK</b> REGAL
	1986-1989	V8-5.0L	<b>OLDSMOBILE</b> 88 CUSTOM CRUISER
	1987	V8-5.0L	<b>BUICK</b> LESABRE ESTATE WAGON
	1987	V8-5.0L	<b>CHEVROLET</b> BLAZER
	1987	V8-5.0L	<b>CHEVROLET</b> R10
	1987	V8-5.0L	<b>CHEVROLET</b> R10 SUBURBAN
	1987	V8-5.0L	<b>CHEVROLET</b> R20
	1987	V8-5.0L	<b>CHEVROLET</b> V10
	1987	V8-5.0L	<b>GMC</b> R1500
	1987	V8-5.0L	<b>GMC</b> R1500 SUBURBAN
	1987	V8-5.0L	<b>GMC</b> R2500
	1987	V8-5.0L	<b>GMC</b> V1500
	1987-1989	V8-5.0L	<b>PONTIAC</b> SAFARI
	1965-1966	V8-5.3L	<b>AMERICAN MOTORS</b> MARLIN
	1966-1968	V8-5.3L	<b>CHEVROLET</b> C10 1/2 TON
	1966-1968	V8-5.3L	<b>CHEVROLET</b> C10 1/2 TON SUBURBAN
	1966-1968	V8-5.3L	<b>CHEVROLET</b> C20 3/4 TON
	1966-1968	V8-5.3L	<b>CHEVROLET</b> C30 1 TON
	1967	V8-5.3L	<b>PONTIAC</b> FIREBIRD
	1967-1968	V8-5.3L	<b>CHEVROLET</b> K10 1/2 TON
	1967-1968	V8-5.3L	<b>CHEVROLET</b> K20 3/4 TON
	1967-1969	V8-5.3L	<b>CHEVROLET</b> CAMARO
	1967-1969	V8-5.3L	<b>CHEVROLET</b> CAPRICE
	1968	V8-5.3L	<b>CHEVROLET</b> CHEVELLE
	1968	V8-5.3L	<b>CHEVROLET</b> MALIBU
	1968	V8-5.3L	<b>GMC</b> C1500 1/2 TON
	1968	V8-5.3L	<b>GMC</b> C2500 3/4 TON
	1968	V8-5.3L	<b>GMC</b> C3500 1 TON
	1968	V8-5.3L	<b>GMC</b> K1500 1/2 TON
	1968	V8-5.3L	<b>GMC</b> K2500 3/4 TON
	1968	V8-5.3L	<b>GMC</b> K2500 3/4 TON SUBURBAN
	1968-1969	V8-5.3L	<b>CHECKER</b> MARATHON SEDAN
	1968-1969	V8-5.3L	<b>CHECKER</b> MARATHON WAGON
	1964-1966	V8-5.4L	<b>OLDSMOBILE</b> JETSTAR

USMW	Years	Cyl.	Specifications	USMW	Years	Cyl.	Specifications
1964-1967	V8-5.4L	<b>OLDSMOBILE</b> CUTLASS	1980-1985	V8-5.7L	<b>BUICK</b> LESABRE		
1964-1967	V8-5.4L	<b>OLDSMOBILE</b> F85	1980-1985	V8-5.7L	<b>OLDSMOBILE</b> CUTLASS SALON		
1964-1967	V8-5.4L	<b>OLDSMOBILE</b> VISTA CRUISER	1980-1985	V8-5.7L	<b>OLDSMOBILE</b> CUTLASS SUPREME		
1967	V8-5.4L	<b>OLDSMOBILE</b> DELMONT 88	1980-1985	V8-5.7L	<b>OLDSMOBILE</b> TORONADO		
1966	V8-5.6L	<b>BUICK</b> LESABRE	1981	V8-5.7L	<b>BUICK</b> CENTURY		
1967	V8-5.6L	<b>AMERICAN MOTORS</b> MARLIN	1981-1984	V8-5.7L	<b>PONTIAC</b> GRAND PRIX		
1967-1969	V8-5.6L	<b>AMERICAN MOTORS</b> REBEL	1981-1985	V8-5.7L	<b>BUICK</b> RIVIERA		
1968-1969	V8-5.6L	<b>AMERICAN MOTORS</b> AMX	1982	V8-5.7L	<b>CADILLAC</b> DEVILLE		
1971-1975	V8-5.6L	<b>INTERNATIONAL</b> PICKUP	1982-1985	V8-5.7L	<b>BUICK</b> REGAL		
1971-1975	V8-5.6L	<b>INTERNATIONAL</b> SCOUT	1982-1985	V8-5.7L	<b>CADILLAC</b> ELDORADO		
1971-1975	V8-5.6L	<b>INTERNATIONAL</b> TRAVELALL	1983-1984	V8-5.7L	<b>GMC</b> CABALLERO		
1974-1979	V8-5.6L	<b>INTERNATIONAL</b> SCOUT II	1983-1985	V8-5.7L	<b>PONTIAC</b> PARISIENNE		
1975	V8-5.6L	<b>INTERNATIONAL</b> METRO	1983-1986	V8-5.7L	<b>CHEVROLET</b> K20		
1976-1980	V8-5.6L	<b>INTERNATIONAL</b> TERRA PICKUP	1983-1986	V8-5.7L	<b>CHEVROLET</b> K20 SUBURBAN		
1976-1980	V8-5.6L	<b>INTERNATIONAL</b> TRAVELER	1983-1986	V8-5.7L	<b>CHEVROLET</b> K30		
1967-1979	V8-5.7L	<b>CHEVROLET</b> CAMARO	1983-1986	V8-5.7L	<b>GMC</b> K2500		
1968	V8-5.7L	<b>OLDSMOBILE</b> DELMONT 88	1983-1986	V8-5.7L	<b>GMC</b> K2500 SUBURBAN		
1968-1972	V8-5.7L	<b>BUICK</b> GRAN SPORT	1983-1986	V8-5.7L	<b>GMC</b> K3500		
1968-1972	V8-5.7L	<b>OLDSMOBILE</b> F85	1984-1986	V8-5.7L	<b>GMC</b> G1500		
1969	V8-5.7L	<b>CHECKER</b> DELUXE LIMO	1984-1986	V8-5.7L	<b>GMC</b> G2500		
1969	V8-5.7L	<b>CHECKER</b> DELUXE SEDAN	1985-1986	V8-5.7L	<b>CHEVROLET</b> C10		
1969-1972	V8-5.7L	<b>CHEVROLET</b> BISCAYNE	1985-1986	V8-5.7L	<b>CHEVROLET</b> C10 SUBURBAN		
1969-1973	V8-5.7L	<b>CHEVROLET</b> CHEVELLE	1985-1986	V8-5.7L	<b>CHEVROLET</b> C20		
1969-1974	V8-5.7L	<b>CHECKER</b> MARATHON SEDAN	1985-1986	V8-5.7L	<b>CHEVROLET</b> C20 SUBURBAN		
1969-1974	V8-5.7L	<b>CHECKER</b> MARATHON WAGON	1985-1986	V8-5.7L	<b>CHEVROLET</b> C30		
1969-1979	V8-5.7L	<b>CHEVROLET</b> NOVA	1985-1986	V8-5.7L	<b>CHEVROLET</b> K10		
1969-1983	V8-5.7L	<b>CHEVROLET</b> MALIBU	1985-1986	V8-5.7L	<b>CHEVROLET</b> K10 SUBURBAN		
1969-1984	V8-5.7L	<b>CHEVROLET</b> EL CAMINO	1985-1986	V8-5.7L	<b>CHEVROLET</b> K5 BLAZER		
1969-1985	V8-5.7L	<b>CHEVROLET</b> CAPRICE	1985-1986	V8-5.7L	<b>GMC</b> C1500		
1969-1985	V8-5.7L	<b>CHEVROLET</b> IMPALA	1985-1986	V8-5.7L	<b>GMC</b> C1500 SUBURBAN		
1970	V8-5.7L	<b>CHECKER</b> MARATHON DELUX WAGON	1985-1986	V8-5.7L	<b>GMC</b> C2500		
1970-1971	V8-5.7L	<b>CHECKER</b> MARATHON DELUX LIMO	1985-1986	V8-5.7L	<b>GMC</b> C2500 SUBURBAN		
1970-1971	V8-5.7L	<b>CHECKER</b> MARATHON DELUX SEDAN	1985-1986	V8-5.7L	<b>GMC</b> C3500		
1970-1975	V8-5.7L	<b>CHEVROLET</b> BELAIR	1985-1986	V8-5.7L	<b>GMC</b> K1500		
1970-1978	V8-5.7L	<b>GMC</b> G2500 3/4 TON VAN	1985-1986	V8-5.7L	<b>GMC</b> K1500 SUBURBAN		
1970-1979	V8-5.7L	<b>CHEVROLET</b> G10 1/2 TON VAN	1985-1988	V8-5.7L	<b>GMC</b> JIMMY		
1970-1979	V8-5.7L	<b>CHEVROLET</b> G20 3/4 TON VAN	1985-1993	V8-5.7L	<b>CHEVROLET</b> P30		
1970-1984	V8-5.7L	<b>CHEVROLET</b> MONTE CARLO	1985-1993	V8-5.7L	<b>GMC</b> P3500		
1971-1977	V8-5.7L	<b>GMC</b> SPRINT	1987	V8-5.7L	<b>CHEVROLET</b> R10		
1971-1979	V8-5.7L	<b>CHEVROLET</b> G30 1 TON VAN	1987	V8-5.7L	<b>CHEVROLET</b> V10		
1971-1979	V8-5.7L	<b>GMC</b> G1500 1/2 TON VAN	1987	V8-5.7L	<b>CHEVROLET</b> V20		
1971-1979	V8-5.7L	<b>GMC</b> G3500 1 TON VAN	1987	V8-5.7L	<b>GMC</b> R1500		
1972-1981	V8-5.7L	<b>CHECKER</b> MARATHON DELUXE	1987	V8-5.7L	<b>GMC</b> V1500		
1973	V8-5.7L	<b>CHEVROLET</b> K30 1 TON	1987	V8-5.7L	<b>GMC</b> V2500		
1973-1976	V8-5.7L	<b>CHEVROLET</b> LAGUNA	1987-1988	V8-5.7L	<b>CHEVROLET</b> BLAZER		
1973-1977	V8-5.7L	<b>CHEVROLET</b> CAPRICE ESTATE WAGON	1987-1988	V8-5.7L	<b>CHEVROLET</b> R10 SUBURBAN		
1974-1976	V8-5.7L	<b>CHEVROLET</b> CHEVELLE MALIBU	1987-1988	V8-5.7L	<b>CHEVROLET</b> R20		
1975	V8-5.7L	<b>CHEVROLET</b> MONZA	1987-1988	V8-5.7L	<b>CHEVROLET</b> R20 SUBURBAN		
1975-1978	V8-5.7L	<b>GMC</b> C1500 1/2 TON	1987-1988	V8-5.7L	<b>CHEVROLET</b> V10 SUBURBAN		
1975-1978	V8-5.7L	<b>GMC</b> C3500 1 TON	1987-1988	V8-5.7L	<b>CHEVROLET</b> V20 SUBURBAN		
1975-1978	V8-5.7L	<b>GMC</b> K1500 1/2 TON	1987-1988	V8-5.7L	<b>GMC</b> R1500 SUBURBAN		
1975-1978	V8-5.7L	<b>GMC</b> K2500 3/4 TON	1987-1988	V8-5.7L	<b>GMC</b> V1500 SUBURBAN		
1975-1978	V8-5.7L	<b>GMC</b> K2500 3/4 TON SUBURBAN	1987-1989	V8-5.7L	<b>GMC</b> R2500		
1976	V8-5.7L	<b>CHEVROLET</b> CHEVELLE MALIBU ESTATE WAGON	1987-1989	V8-5.7L	<b>GMC</b> V2500 SUBURBAN		
1976-1985	V8-5.7L	<b>CADILLAC</b> SEVILLE	1987-1990	V8-5.7L	<b>GMC</b> R2500 SUBURBAN		
1977-1978	V8-5.7L	<b>OLDSMOBILE</b> 88	1987-1991	V8-5.7L	<b>GMC</b> R3500		
1977-1979	V8-5.7L	<b>PONTIAC</b> PHOENIX	1987-1991	V8-5.7L	<b>GMC</b> V3500		
1977-1982	V8-5.7L	<b>CHECKER</b> MARATHON	1961-1964	V8-5.9L	<b>CHRYSLER</b> NEWPORT		
1978	V8-5.7L	<b>CHEVROLET</b> C30 1 TON	1970	V8-5.9L	<b>AMERICAN MOTORS</b> REBEL		
1978-1984	V8-5.7L	<b>OLDSMOBILE</b> 98	1970-1974	V8-5.9L	<b>AMERICAN MOTORS</b> AMBASSADOR		
1978-1985	V8-5.7L	<b>OLDSMOBILE</b> CUSTOM CRUISER	1970-1974	V8-5.9L	<b>AMERICAN MOTORS</b> AMX		
1980-1981	V8-5.7L	<b>OLDSMOBILE</b> CUTLASS	1970-1974	V8-5.9L	<b>AMERICAN MOTORS</b> JAVELIN		
1980-1981	V8-5.7L	<b>PONTIAC</b> BONNEVILLE	1971-1974	V8-5.9L	<b>AMERICAN MOTORS</b> HORNET		
1980-1981	V8-5.7L	<b>PONTIAC</b> CATALINA	1971-1978	V8-5.9L	<b>AMERICAN MOTORS</b> MATADOR		
1980-1983	V8-5.7L	<b>BUICK</b> ESTATE WAGON	1972-1983	V8-5.9L	<b>JEEP</b> WAGONEER		
1980-1983	V8-5.7L	<b>OLDSMOBILE</b> CUTLASS CRUISER	1974	V8-5.9L	<b>JEEP</b> CHEROKEE 2WD		
1980-1984	V8-5.7L	<b>OLDSMOBILE</b> CUTLASS CALAIS	1974-1975	V8-5.9L	<b>JEEP</b> CHEROKEE 4WD		
1980-1984	V8-5.7L	<b>OLDSMOBILE</b> DELTA 88	1974-1988	V8-5.9L	<b>JEEP</b> J10		
1980-1985	V8-5.7L	<b>BUICK</b> ELECTRA	1974-1988	V8-5.9L	<b>JEEP</b> J20		



USMW	Years	Cyl.	Specifications
	1976-1983	V8-5.9L	JEEP CHEROKEE
	1984-1991	V8-5.9L	JEEP GRAND WAGONEER
	1968-1970	V8-6.4L	AMERICAN MOTORS AMBASSADOR
	1968-1970	V8-6.4L	AMERICAN MOTORS AMX
	1970	V8-6.4L	AMERICAN MOTORS REBEL
	1972-1975	V8-6.4L	INTERNATIONAL TRAVELALL
	1975	V8-6.4L	INTERNATIONAL PICKUP
	1975	V8-6.4L	INTERNATIONAL SCOUT
	1960-1964	V8-6.5L	OLDSMOBILE SUPER 88
	1961-1964	V8-6.5L	OLDSMOBILE 98
	1961-1964	V8-6.5L	OLDSMOBILE DYNAMIC 88
	1961-1964	V8-6.5L	OLDSMOBILE STARFIRE
	1964	V8-6.5L	OLDSMOBILE JETSTAR
	1967-1970	V8-6.5L	CHEVROLET CAMARO
	1969	V8-6.5L	CHEVROLET CHEVELLE
	1969-1970	V8-6.5L	CHEVROLET EL CAMINO
	1969-1970	V8-6.5L	CHEVROLET MALIBU
	1969-1970	V8-6.5L	CHEVROLET NOVA
	1965-1968	V8-6.6L	OLDSMOBILE CUTLASS
	1965-1969	V8-6.6L	OLDSMOBILE 442
	1968-1969	V8-6.6L	OLDSMOBILE VISTA CRUISER
	1970	V8-6.6L	CHEVROLET NOVA
	1970-1972	V8-6.6L	CHEVROLET CAMARO
	1970-1972	V8-6.6L	CHEVROLET CHEVELLE
	1970-1972	V8-6.6L	CHEVROLET MALIBU
	1970-1976	V8-6.6L	CHEVROLET CAPRICE
	1970-1976	V8-6.6L	CHEVROLET EL CAMINO
	1971-1974	V8-6.6L	AMERICAN MOTORS AMBASSADOR
	1971-1974	V8-6.6L	AMERICAN MOTORS AMX
	1971-1974	V8-6.6L	AMERICAN MOTORS JAVELIN
	1971-1976	V8-6.6L	AMERICAN MOTORS MATADOR
	1972-1976	V8-6.6L	CHEVROLET P30 VAN
	1973-1975	V8-6.6L	PONTIAC GRAND SAFARI S/W
	1973-1975	V8-6.6L	PONTIAC GRANDVILLE
	1973-1976	V8-6.6L	CHEVROLET CAPRICE ESTATE WAGON
	1974	V8-6.6L	JEEP CHEROKEE 2WD
	1974-1975	V8-6.6L	JEEP CHEROKEE 4WD
	1974-1976	V8-6.6L	CHEVROLET CHEVELLE MALIBU
	1974-1978	V8-6.6L	JEEP J10
	1974-1978	V8-6.6L	JEEP J20
	1974-1978	V8-6.6L	JEEP WAGONEER
	1976	V8-6.6L	CHEVROLET CHEVELLE MALIBU ESTATE WAGON
	1976	V8-6.6L	CHEVROLET MONTE CARLO
	1976	V8-6.6L	GMC SPRINT
	1976-1978	V8-6.6L	JEEP CHEROKEE
	1969	V8-7.0L	CHEVROLET CAMARO
	1969	V8-7.0L	CHEVROLET CAPRICE
	1970-1973	V8-7.4L	CHEVROLET CHEVELLE
	1970-1973	V8-7.4L	CHEVROLET MALIBU
	1970-1975	V8-7.4L	CHEVROLET EL CAMINO
	1970-1976	V8-7.4L	CHEVROLET CAPRICE
	1973-1976	V8-7.4L	CHEVROLET CAPRICE ESTATE WAGON
	1974-1975	V8-7.4L	CHEVROLET CHEVELLE MALIBU
	1985	V8-7.4L	CHEVROLET P30
	1985	V8-7.4L	GMC P3500
	1968-1969	V8-7.7L	CADILLAC ELDORADO
22051	1966-1978	L6-4.1L	CHEVROLET CS1073 (MEX)
	1964-1978	L6-4.8L	CHEVROLET CS1073 (MEX)
	1964-1978	L6-4.8L	CHEVROLET CS31003 (MEX)
	1965-1966	L6-4.8L	CHEVROLET C1405 PANEL (MEX)
	1965-1967	L6-4.8L	CHEVROLET C20905 (MEX)
	1967	L6-4.8L	CHEVROLET C3605 (MEX)
	1990-1995	V6-4.3L	CHEVROLET P30
	1990-1995	V6-4.3L	GMC P3500
	1964-1967	V8-4.7L	CHEVROLET CS1073 (MEX)
	1964-1967	V8-4.7L	CHEVROLET CS31003 (MEX)
	1965-1966	V8-4.7L	CHEVROLET C1405 PANEL (MEX)
	1965-1967	V8-4.7L	CHEVROLET C20905 (MEX)
	1967	V8-4.7L	CHEVROLET C3605 (MEX)

USMW	Years	Cyl.	Specifications
	1964-1969	V8-5.4L	CHEVROLET CS1073 (MEX)
	1964-1969	V8-5.4L	CHEVROLET CS31003 (MEX)
	1968-1978	V8-5.7L	CHEVROLET CS31003 (MEX)
	1987	V8-5.7L	CHEVROLET C10 (MEX)
	1987	V8-5.7L	CHEVROLET C20 (MEX)
	1987	V8-5.7L	CHEVROLET C30 (MEX)
	1969	V8-6.5L	CHEVROLET C10 1/2 TON
	1969	V8-6.5L	CHEVROLET C10 1/2 TON SUBURBAN
	1975-1978	V8-6.6L	GMC K1500 1/2 TON
	1975-1978	V8-6.6L	GMC K2500 3/4 TON
	1975-1978	V8-6.6L	GMC K2500 3/4 TON SUBURBAN
	1976-1978	V8-6.6L	GMC C1500 1/2 TON
	1976-1978	V8-6.6L	GMC C3500 1 TON
	1975-1976	V8-7.4L	GMC G2500 3/4 TON VAN
	1975-1978	V8-7.4L	GMC C1500 1/2 TON
	1975-1978	V8-7.4L	GMC C3500 1 TON
	1975-1978	V8-7.4L	GMC P3500 VAN
	1976	V8-7.4L	GMC K1500 1/2 TON
	1976-1977	V8-7.4L	GMC K2500 3/4 TON SUBURBAN
	1976-1978	V8-7.4L	GMC K2500 3/4 TON
	1971-1974	V8-7.7L	CADILLAC FLEETWOOD BROUGHAM
	1975	V8-8.2L	CADILLAC FLEETWOOD BROUGHAM
22052	1977	V8-5.0L	FORD F350 1 TON
	1982-1986	V8-6.2L	CHEVROLET C10
	1982-1986	V8-6.2L	CHEVROLET C10 SUBURBAN
	1982-1986	V8-6.2L	CHEVROLET C20
	1982-1986	V8-6.2L	CHEVROLET K10
	1982-1986	V8-6.2L	CHEVROLET K10 SUBURBAN
	1982-1986	V8-6.2L	CHEVROLET K20
	1982-1986	V8-6.2L	CHEVROLET K5 BLAZER
	1982-1986	V8-6.2L	GMC C1500
	1982-1986	V8-6.2L	GMC C1500 SUBURBAN
	1982-1986	V8-6.2L	GMC C2500
	1982-1986	V8-6.2L	GMC C2500 SUBURBAN
	1982-1986	V8-6.2L	GMC K1500
	1982-1986	V8-6.2L	GMC K1500 SUBURBAN
	1982-1986	V8-6.2L	GMC K2500
	1982-1991	V8-6.2L	GMC JIMMY
	1983-1986	V8-6.2L	CHEVROLET C20 SUBURBAN
	1983-1986	V8-6.2L	CHEVROLET C30
	1983-1986	V8-6.2L	CHEVROLET K20 SUBURBAN
	1983-1986	V8-6.2L	CHEVROLET K30
	1983-1986	V8-6.2L	GMC C3500
	1983-1986	V8-6.2L	GMC K2500 SUBURBAN
	1983-1986	V8-6.2L	GMC K3500
	1983-1993	V8-6.2L	CHEVROLET G20
	1983-1993	V8-6.2L	CHEVROLET G30
	1983-1993	V8-6.2L	GMC G2500
	1983-1993	V8-6.2L	GMC G3500
	1985-1993	V8-6.2L	CHEVROLET P30
	1985-1993	V8-6.2L	GMC P3500
	1987	V8-6.2L	CHEVROLET R10
	1987	V8-6.2L	CHEVROLET V10
	1987	V8-6.2L	CHEVROLET V20
	1987	V8-6.2L	GMC R1500
	1987	V8-6.2L	GMC V1500
	1987	V8-6.2L	GMC V2500
	1987-1988	V8-6.2L	CHEVROLET R10 SUBURBAN
	1987-1988	V8-6.2L	CHEVROLET R20
	1987-1988	V8-6.2L	CHEVROLET R20 SUBURBAN
	1987-1988	V8-6.2L	CHEVROLET R30
	1987-1988	V8-6.2L	CHEVROLET V10 SUBURBAN
	1987-1988	V8-6.2L	CHEVROLET V20 SUBURBAN
	1987-1988	V8-6.2L	CHEVROLET V30
	1987-1989	V8-6.2L	GMC R2500
	1987-1991	V8-6.2L	CHEVROLET BLAZER
	1987-1991	V8-6.2L	GMC R1500 SUBURBAN
	1987-1991	V8-6.2L	GMC R2500 SUBURBAN
	1987-1991	V8-6.2L	GMC R3500



USMW	Years	Cyl.	Specifications
	1987-1991	V8-6.2L	<b>GMC</b> V1500 SUBURBAN
	1987-1991	V8-6.2L	<b>GMC</b> V2500 SUBURBAN
	1987-1991	V8-6.2L	<b>GMC</b> V3500
	1989	V8-6.2L	<b>CHEVROLET</b> R2500
	1989-1991	V8-6.2L	<b>CHEVROLET</b> R1500 SUBURBAN
	1989-1991	V8-6.2L	<b>CHEVROLET</b> R2500 SUBURBAN
	1989-1991	V8-6.2L	<b>CHEVROLET</b> R3500
	1989-1991	V8-6.2L	<b>CHEVROLET</b> V1500 SUBURBAN
	1989-1991	V8-6.2L	<b>CHEVROLET</b> V2500 SUBURBAN
	1989-1991	V8-6.2L	<b>CHEVROLET</b> V3500
	1992-1993	V8-6.2L	<b>AM GENERAL</b> HUMMER
	1970-1974	V8-7.4L	<b>CHEVROLET</b> CORVETTE
	1973-1976	V8-7.5L	<b>FORD</b> F100 1/2 TON
	1973-1979	V8-7.5L	<b>FORD</b> F250 3/4 TON
	1973-1979	V8-7.5L	<b>FORD</b> F350 1 TON
	1975-1976	V8-7.5L	<b>FORD</b> ELITE
	1975-1979	V8-7.5L	<b>FORD</b> F150 1/2 TON
	1980	V8-7.5L	<b>FORD</b> E-250 ECONOLINE
	1980-1991	V8-7.5L	<b>FORD</b> E-250 ECONOLINE CLUB WAGON
	1980-1996	V8-7.5L	<b>FORD</b> E-350 ECONOLINE
	1980-1996	V8-7.5L	<b>FORD</b> E-350 ECONOLINE CLUB WAGON
	1983-1997	V8-7.5L	<b>FORD</b> F-250
	1983-1997	V8-7.5L	<b>FORD</b> F-350
	1988-1997	V8-7.5L	<b>FORD</b> F53
	1990-1997	V8-7.5L	<b>FORD</b> F SUPER DUTY
	1996	V8-7.5L	<b>FORD</b> ECONOLINE SUPER DUTY
<b>22054</b>	1983	L6-4.9L	<b>FORD</b> BRONCO
	1973	V8-5.0L	<b>GMC</b> JIMMY 2WD
	1973	V8-5.0L	<b>GMC</b> JIMMY 4WD
	1980	V8-5.0L	<b>FORD</b> E-250 ECONOLINE CLUB WAGON
	1980	V8-5.0L	<b>FORD</b> E-350 ECONOLINE CLUB WAGON
	1980-1982	V8-5.0L	<b>FORD</b> E-100 ECONOLINE
	1980-1983	V8-5.0L	<b>FORD</b> E-100 ECONOLINE CLUB WAGON
	1980-1983	V8-5.0L	<b>FORD</b> F-100
	1980-1986	V8-5.0L	<b>FORD</b> BRONCO
	1980-1986	V8-5.0L	<b>FORD</b> E-150 ECONOLINE
	1980-1986	V8-5.0L	<b>FORD</b> E-150 ECONOLINE CLUB WAGON
	1980-1986	V8-5.0L	<b>FORD</b> E-250 ECONOLINE
	1980-1986	V8-5.0L	<b>FORD</b> F-150
	1980-1986	V8-5.0L	<b>FORD</b> F-250
	1960	V8-5.2L	<b>DODGE</b> SENECA
	1960-1961	V8-5.2L	<b>DODGE</b> PHOENIX
	1960-1961	V8-5.2L	<b>DODGE</b> PIONEER
	1962-1973	V8-5.2L	<b>DODGE</b> DART
	1963-1973	V8-5.2L	<b>DODGE</b> POLARA
	1965-1973	V8-5.2L	<b>DODGE</b> CORONET
	1966-1973	V8-5.2L	<b>DODGE</b> CHARGER
	1968-1970	V8-5.2L	<b>DODGE</b> MONACO
	1969-1973	V8-5.2L	<b>DODGE</b> DART SWINGER
	1970-1973	V8-5.2L	<b>DODGE</b> CHALLENGER
	1971-1972	V8-5.2L	<b>DODGE</b> DEMON
	1980	V8-5.2L	<b>CHRYSLER</b> CORDOBA
	1980	V8-5.2L	<b>CHRYSLER</b> LEBARON
	1980	V8-5.2L	<b>CHRYSLER</b> NEW YORKER
	1980	V8-5.2L	<b>CHRYSLER</b> NEWPORT
	1980	V8-5.2L	<b>CHRYSLER</b> TOWN & COUNTRY
	1980	V8-5.2L	<b>DODGE</b> ASPEN
	1980	V8-5.2L	<b>DODGE</b> DIPLOMAT
	1980	V8-5.2L	<b>DODGE</b> MIRADA
	1980	V8-5.2L	<b>DODGE</b> ST. REGIS
	1980	V8-5.2L	<b>PLYMOUTH</b> GRAN FURY
	1980	V8-5.2L	<b>PLYMOUTH</b> VOLARE
	1968-1973	V8-5.6L	<b>DODGE</b> DART
	1969-1970	V8-5.6L	<b>DODGE</b> DART SWINGER
	1970-1973	V8-5.6L	<b>DODGE</b> CHALLENGER
	1971-1972	V8-5.6L	<b>DODGE</b> DEMON
	1971-1973	V8-5.6L	<b>DODGE</b> CHARGER
	1972-1973	V8-5.6L	<b>DODGE</b> CORONET

USMW	Years	Cyl.	Specifications
	1987	V8-5.7L	<b>GMC</b> C1500 (MEX)
	1987	V8-5.7L	<b>GMC</b> C2500 (MEX)
	1987	V8-5.7L	<b>GMC</b> C3500 (MEX)
	1980-1983	V8-5.8L	<b>FORD</b> E-100 ECONOLINE
	1980-1983	V8-5.8L	<b>FORD</b> E-100 ECONOLINE CLUB WAGON
	1980-1987	V8-5.8L	<b>FORD</b> BRONCO
	1980-1987	V8-5.8L	<b>FORD</b> E-150 ECONOLINE
	1980-1987	V8-5.8L	<b>FORD</b> E-150 ECONOLINE CLUB WAGON
	1980-1987	V8-5.8L	<b>FORD</b> E-250 ECONOLINE
	1980-1987	V8-5.8L	<b>FORD</b> E-250 ECONOLINE CLUB WAGON
	1980-1987	V8-5.8L	<b>FORD</b> E-350 ECONOLINE
	1980-1987	V8-5.8L	<b>FORD</b> E-350 ECONOLINE CLUB WAGON
	1980-1987	V8-5.8L	<b>FORD</b> F-150
	1980-1987	V8-5.8L	<b>FORD</b> F-250
	1980-1987	V8-5.8L	<b>FORD</b> F-350
	1981	V8-5.8L	<b>FORD</b> F-100
	1960	V8-5.9L	<b>DODGE</b> PHOENIX
	1960-1962	V8-5.9L	<b>DODGE</b> DART
	1960-1973	V8-5.9L	<b>DODGE</b> POLARA
	1961	V8-5.9L	<b>DODGE</b> PIONEER
	1961	V8-5.9L	<b>DODGE</b> SENECA
	1965-1973	V8-5.9L	<b>DODGE</b> CORONET
	1966	V8-5.9L	<b>DODGE</b> CHARGER
	1971-1973	V8-5.9L	<b>DODGE</b> MONACO
	1980	V8-5.9L	<b>CHRYSLER</b> NEW YORKER
	1980	V8-5.9L	<b>CHRYSLER</b> NEWPORT
	1980	V8-5.9L	<b>DODGE</b> ASPEN
	1980	V8-5.9L	<b>DODGE</b> MIRADA
	1980	V8-5.9L	<b>DODGE</b> ST. REGIS
	1980	V8-5.9L	<b>PLYMOUTH</b> GRAN FURY
	1980	V8-5.9L	<b>PLYMOUTH</b> VOLARE
	1960	V8-6.3L	<b>DODGE</b> PHOENIX
	1960	V8-6.3L	<b>DODGE</b> PIONEER
	1960-1971	V8-6.3L	<b>DODGE</b> POLARA
	1961-1969	V8-6.3L	<b>DODGE</b> DART
	1965-1971	V8-6.3L	<b>DODGE</b> CORONET
	1965-1971	V8-6.3L	<b>DODGE</b> MONACO
	1966-1971	V8-6.3L	<b>DODGE</b> CHARGER
	1970-1971	V8-6.3L	<b>DODGE</b> CHALLENGER
	1977	V8-6.6L	<b>BUICK</b> CENTURY
	1977-1979	V8-6.6L	<b>FORD</b> F150 1/2 TON
	1977-1979	V8-6.6L	<b>FORD</b> F250 3/4 TON
	1977-1979	V8-6.6L	<b>FORD</b> F350 1 TON
	1980	V8-6.6L	<b>FORD</b> E-250 ECONOLINE
	1980-1982	V8-6.6L	<b>FORD</b> E-250 ECONOLINE CLUB WAGON
	1980-1982	V8-6.6L	<b>FORD</b> E-350 ECONOLINE
	1980-1982	V8-6.6L	<b>FORD</b> E-350 ECONOLINE CLUB WAGON
	1980-1982	V8-6.6L	<b>FORD</b> F-250
	1980-1982	V8-6.6L	<b>FORD</b> F-350
	1966-1973	V8-7.2L	<b>DODGE</b> POLARA
	1966-1978	V8-7.2L	<b>DODGE</b> MONACO
	1967-1974	V8-7.2L	<b>DODGE</b> CHARGER
	1967-1976	V8-7.2L	<b>DODGE</b> CORONET
	1970-1971	V8-7.2L	<b>DODGE</b> CHALLENGER
	1974	V8-7.2L	<b>DODGE</b> B100 1/2 TON VAN
	1974-1977	V8-7.2L	<b>DODGE</b> W100 1/2 TON
	1974-1978	V8-7.2L	<b>DODGE</b> B200 3/4 TON VAN
	1974-1978	V8-7.2L	<b>PLYMOUTH</b> TRAILDUSTER 2WD
	1974-1978	V8-7.2L	<b>PLYMOUTH</b> TRAILDUSTER 4WD
	1975-1978	V8-7.2L	<b>DODGE</b> B300 1 TON VAN
	1975-1978	V8-7.2L	<b>DODGE</b> W200 3/4 TON
	1975-1978	V8-7.2L	<b>DODGE</b> W300 1 TON
<b>22056</b>	1985	V6-2.8L	<b>CHEVROLET</b> S10
	1985	V6-2.8L	<b>CHEVROLET</b> S10 BLAZER
<b>22059</b>	2009	V8-5.7L	<b>DODGE</b> RAM 3500
	2009-2010	V8-5.7L	<b>DODGE</b> RAM 1500
	2009-2010	V8-5.7L	<b>DODGE</b> RAM 2500
	2011	V8-5.7L	<b>RAM</b> 1500
<b>22060</b>	1983-1985	V6-2.8L	<b>FORD</b> RANGER

**FAN CLUTCHES**

USMW	Years	Cyl.	Specifications
	1984-1985	V6-2.8L	FORD BRONCO II
	1986-1990	V6-2.9L	FORD BRONCO II
	1986-1992	V6-2.9L	FORD RANGER
<b>22061</b>	1980-1986	L6-4.9L	FORD BRONCO
	1983	L6-4.9L	FORD E-100 ECONOLINE
	1983	L6-4.9L	FORD E-100 ECONOLINE CLUB WAGON
	1983	L6-4.9L	FORD F-100
	1983-1986	L6-4.9L	FORD E-150 ECONOLINE
	1983-1986	L6-4.9L	FORD E-150 ECONOLINE CLUB WAGON
	1983-1986	L6-4.9L	FORD E-250 ECONOLINE
	1983-1986	L6-4.9L	FORD E-250 ECONOLINE CLUB WAGON
	1983-1986	L6-4.9L	FORD E-350 ECONOLINE
	1983-1986	L6-4.9L	FORD E-350 ECONOLINE CLUB WAGON
	1983-1986	L6-4.9L	FORD F-150
	1983-1986	L6-4.9L	FORD F-250
	1983-1986	L6-4.9L	FORD F-350
<b>22063</b>	1987-1988	V8-3.5L	LAND ROVER RANGE ROVER
	1989-1995	V8-3.9L	LAND ROVER RANGE ROVER
	1993-1995	V8-4.2L	LAND ROVER RANGE ROVER
<b>22064</b>	1986-1997	V6-3.0L	FORD AEROSTAR
	1991-1994	V6-3.0L	FORD RANGER
	1994	V6-3.0L	MAZDA B3000
<b>22065</b>	1985-1987	L4-2.3L	FORD RANGER
	1986	V6-2.8L	FORD AEROSTAR
	1995-1997	V6-3.0L	FORD RANGER
<b>22067</b>	1988-1989	V6-2.9L	MERKUR SCORPIO
<b>22068</b>	1986-1995	L4-1.3L	SUZUKI SAMURAI
	1989	L4-1.3L	SUZUKI SIDEKICK
	1989-1997	L4-1.6L	GEO TRACKER
	1989-1998	L4-1.6L	SUZUKI SIDEKICK
	1996-1998	L4-1.6L	SUZUKI X-90
	1998-2000	L4-1.6L	CHEVROLET TRACKER
	1999-2001	L4-1.6L	SUZUKI VITARA
<b>22070</b>	1989-1993	L6-5.9L	DODGE D250
	1989-1993	L6-5.9L	DODGE D350
	1989-1993	L6-5.9L	DODGE W250
	1989-1993	L6-5.9L	DODGE W350
	1994-1999	L6-5.9L	DODGE RAM 2500
	1994-1999	L6-5.9L	DODGE RAM 3500
	2007-2008	V6-3.5L	DODGE SPRINTER 2500
	2007-2008	V6-3.5L	DODGE SPRINTER 3500
	2009	V8-5.7L	CHRYSLER ASPEN
<b>22071</b>	1984-1995	L4-1.8L	BMW 318I
	1986	L4-1.8L	BMW 318 (MEX)
	1991-1995	L4-1.8L	BMW 318IS
	1995	L4-1.8L	BMW 318TI
	1996-1997	L4-1.9L	BMW 318IS
	1996-1998	L4-1.9L	BMW 318I
	1996-1998	L4-1.9L	BMW Z3
	1996-1999	L4-1.9L	BMW 318TI
	1977-1979	L4-2.0L	BMW 320I
	1987	L6-2.4L	BMW 524TD (MEX)
	1986-2009	L6-2.5L	BMW 525I (MEX)
	1987-1991	L6-2.5L	BMW 325I
	1987-1991	L6-2.5L	BMW 325IS
	1988-1991	L6-2.5L	BMW 325IX
	1989-1990	L6-2.5L	BMW 525I
	1996-2012	L6-2.5L	BMW 325I (MEX)
	2010	L6-2.5L	BMW 525I LUJO (MEX)
	1982-1988	L6-2.7L	BMW 528E
	1984-1987	L6-2.7L	BMW 325E
	1986-1987	L6-2.7L	BMW 325ES
	1986-1988	L6-2.7L	BMW 325
	1979-1981	L6-2.8L	BMW 528I
	1975-1976	L6-3.0L	BMW 3.0SI
	1975-1978	L6-3.0L	BMW 530I
	1977	L6-3.0L	BMW 630CSI
	1978-1979	L6-3.2L	BMW 733I
	1978-1984	L6-3.2L	BMW 633CSI

USMW	Years	Cyl.	Specifications
	1983-1984	L6-3.2L	BMW 533I
	1985-1988	L6-3.5L	BMW 535I
	1985-1989	L6-3.5L	BMW 635CSI
	1987	L6-3.5L	BMW L6
	1987-1988	L6-3.5L	BMW M6
	1988	L6-3.5L	BMW 535IS
	1988	L6-3.5L	BMW M5
	1990	V12-5.0L	BMW 850I (MEX)
	1998	V12-5.4L	BMW 850CI (MEX)
	1996	V8-4.0L	BMW 540I (MEX)
<b>22072</b>	1994-1996	L4-2.6L	HONDA PASSPORT
	1994-1997	L4-2.6L	ISUZU RODEO
<b>22073</b>	1983-1985	L4-2.3L	DODGE POWER RAM 50
	1983-1985	L4-2.3L	DODGE RAM 50
	1983-1985	L4-2.3L	MITSUBISHI MIGHTY MAX
	2005-2009	L6-3.5L	MITSUBISHI MONTERO 2WD (MEX)
	1989	V6-3.0L	DODGE RAIDER
	1989-1996	V6-3.0L	MITSUBISHI MONTERO
	1990-1991	V6-3.0L	DODGE RAM 50
	1990-1994	V6-3.0L	MITSUBISHI MIGHTY MAX
	1994-2000	V6-3.5L	MITSUBISHI MONTERO
	1999-2002	V6-3.5L	MITSUBISHI MONTERO SPORT
<b>22074</b>	1993-1997	L6-4.5L	TOYOTA LAND CRUISER
	1996-1997	L6-4.5L	LEXUS LX450
<b>22075</b>	1991-1997	L4-2.4L	TOYOTA PREVIA
<b>22076</b>	1988-1992	L6-4.0L	TOYOTA LAND CRUISER
	1975	L6-4.2L	TOYOTA LAND CRUISER 4WD
	1976-1987	L6-4.2L	TOYOTA LAND CRUISER
	1988-1994	V6-3.0L	TOYOTA 4RUNNER
	1988-1995	V6-3.0L	TOYOTA PICKUP
	1993-1994	V6-3.0L	TOYOTA T100
	1992-1994	V6-3.2L	ISUZU TROOPER
	1993	V6-3.2L	ISUZU RODEO
<b>22078</b>	1995-2007	V6-3.0L	MAZDA B3000
	1998-2008	V6-3.0L	FORD RANGER
<b>22080</b>	1979	L4-1.2L	TOYOTA COROLLA
	1971-1987	L4-1.6L	TOYOTA COROLLA
	1972-1973	L4-1.6L	TOYOTA CARINA
	1980-1982	L4-1.8L	TOYOTA COROLLA
<b>22081</b>	1975-1979	L4-2.2L	TOYOTA PICKUP 2WD
	1975-1980	L4-2.2L	TOYOTA CELICA
	1975-1980	L4-2.2L	TOYOTA CORONA
	1979	L4-2.2L	TOYOTA PICKUP 4WD
	1980-1983	L4-2.2L	TOYOTA PICKUP
	1981-1982	L4-2.4L	TOYOTA CORONA
	1981-1985	L4-2.4L	TOYOTA CELICA
	1981-1995	L4-2.4L	TOYOTA PICKUP
	1984-1995	L4-2.4L	TOYOTA 4RUNNER
<b>22082</b>	1981-1983	L4-2.2L	NISSAN 720
	1989-1998	L4-2.4L	NISSAN 240SX
	1990-1994	L4-2.4L	NISSAN D21
	1991-2009	L4-2.4L	NISSAN PICKUP (MEX)
	1995-1997	L4-2.4L	NISSAN PICKUP
	1998-2004	L4-2.4L	NISSAN FRONTIER
	2000-2004	L4-2.4L	NISSAN XTERRA
	1983-1986	L4-2.5L	NISSAN 720
	1970-1973	L6-2.4L	NISSAN 240Z
	1977-1981	L6-2.4L	NISSAN 810
	1981-1984	L6-2.4L	NISSAN MAXIMA
	1974-1975	L6-2.6L	NISSAN 260Z
	1975-1978	L6-2.8L	NISSAN 280Z
	1979-1983	L6-2.8L	NISSAN 280ZX
	1981	L6-2.8L	NISSAN 810
	1981-1983	L6-2.8L	NISSAN MAXIMA
	1984-1989	V6-3.0L	NISSAN 300ZX
	1986-1989	V6-3.0L	NISSAN D21
	1987-1988	V6-3.0L	NISSAN 200SX
	1987-1989	V6-3.0L	NISSAN PATHFINDER
	1990-1992	V6-3.0L	INFINITI M30

USMW	Years	Cyl.	Specifications
	1990-1993	V8-4.5L	INFINITI Q45
<b>22083</b>	2000-2005	L4-2.4L	NISSAN URVAN (MEX)
<b>22085</b>	1978-1980	L6-2.6L	TOYOTA CRESSIDA
	1979	L6-2.6L	TOYOTA SUPRA
	1980	L6-2.6L	TOYOTA CELICA
	1981-1986	L6-2.8L	TOYOTA CELICA
	1981-1988	L6-2.8L	TOYOTA CRESSIDA
	1986-1992	L6-3.0L	TOYOTA SUPRA
	1989-1992	L6-3.0L	TOYOTA CRESSIDA
<b>22086</b>	1979	L4-2.0L	DODGE D50
	1983-1984	L4-2.0L	DODGE POWER RAM 50
	1983-1989	L4-2.0L	DODGE RAM 50
	1983-1989	L4-2.0L	MITSUBISHI MIGHTY MAX
	1984-1985	L4-2.0L	TOYOTA VAN
	1986-1989	L4-2.2L	TOYOTA VAN
	1987-1990	L4-2.4L	MITSUBISHI VAN
	1990-1993	L4-2.4L	DODGE RAM 50
	1990-1996	L4-2.4L	MITSUBISHI MIGHTY MAX
	1979	L4-2.6L	DODGE D50
	1990-1991	V6-3.0L	DODGE RAM 50
<b>22087</b>	1986-1987	L4-2.3L	ISUZU TROOPER
	1986-1995	L4-2.3L	ISUZU PICKUP
	1988-1989	L4-2.3L	ISUZU IMPULSE
	1989-1993	L4-2.3L	ISUZU AMIGO
	1988-1991	L4-2.6L	ISUZU TROOPER
	1988-1995	L4-2.6L	ISUZU PICKUP
	1989-1994	L4-2.6L	ISUZU AMIGO
	1991-1993	L4-2.6L	ISUZU RODEO
<b>22088</b>	1984-1986	L4-1.8L	NISSAN 200SX
	1984-1988	L4-2.0L	NISSAN 200SX
<b>22089</b>	1974-1976	L4-2.0L	NISSAN 610
	1975-1977	L4-2.0L	NISSAN 710
	1975-1979	L4-2.0L	NISSAN 620
	1977-1979	L4-2.0L	NISSAN 200SX
	1978-1979	L4-2.0L	NISSAN 510
<b>22090</b>	1989-1993	L4-2.6L	MAZDA B2600
	1989-1994	L4-2.6L	MAZDA MPV
<b>22091</b>	2006-2008	L4-2.4L	NISSAN FRONTIER PICKUP (MEX)
	1990-1994	V6-3.0L	NISSAN D21
	1990-1995	V6-3.0L	NISSAN PATHFINDER
	1990-1996	V6-3.0L	NISSAN 300ZX
	1995	V6-3.0L	NISSAN PICKUP
<b>22092</b>	1980-1982	L4-2.0L	DODGE D50
	1980-1982	L4-2.0L	PLYMOUTH ARROW PICKUP
	1983	L4-2.0L	DODGE POWER RAM 50
	1983	L4-2.0L	DODGE RAM 50
	1978-1979	L4-2.6L	DODGE CHALLENGER-IMPORT
	1978-1979	L4-2.6L	PLYMOUTH SAPPORO-IMPORT
	1979	L4-2.6L	PLYMOUTH ARROW-IMPORT
	1979-1980	L4-2.6L	PLYMOUTH ARROW
	1980	L4-2.6L	DODGE COLT
	1980-1982	L4-2.6L	DODGE D50
	1980-1982	L4-2.6L	PLYMOUTH ARROW PICKUP
	1980-1983	L4-2.6L	DODGE CHALLENGER
	1980-1983	L4-2.6L	PLYMOUTH SAPPORO
	1983-1986	L4-2.6L	DODGE POWER RAM 50
	1983-1987	L4-2.6L	MITSUBISHI STARION
	1983-1989	L4-2.6L	DODGE RAM 50
	1983-1989	L4-2.6L	MITSUBISHI MIGHTY MAX
	1983-1989	L4-2.6L	MITSUBISHI MONTERO
	1984-1986	L4-2.6L	DODGE CONQUEST
	1984-1986	L4-2.6L	PLYMOUTH CONQUEST
	1987	L4-2.6L	CHRYSLER CONQUEST
	1987-1988	L4-2.6L	MAZDA B2600
	1987-1989	L4-2.6L	DODGE RAIDER
<b>22093</b>	1983-1987	L4-1.9L	ISUZU IMPULSE
	1985-1989	L4-2.0L	ISUZU IMPULSE
<b>22094</b>	1972-1982	L4-1.8L	CHEVROLET LUV
	1979	L4-1.8L	CHEVROLET LUV 2WD

USMW	Years	Cyl.	Specifications
	1979	L4-1.8L	CHEVROLET LUV 4WD
	1981-1982	L4-1.8L	ISUZU PICKUP
	1983-1987	L4-1.9L	ISUZU PICKUP
	1984-1985	L4-1.9L	ISUZU TROOPER
	1981-1982	L4-2.2L	CHEVROLET LUV
	1981-1987	L4-2.2L	ISUZU PICKUP
	1984-1987	L4-2.2L	ISUZU TROOPER
<b>22096</b>	1986-1987	L4-2.0L	MAZDA B2000
	1987-1993	L4-2.2L	MAZDA B2200
<b>22098</b>	1989-1995	V6-3.0L	MAZDA MPV
<b>22099</b>	2001-2005	L6-2.2L	BMW 320I (MEX)
	1991-2003	L6-2.5L	BMW 525I
	1992-1995	L6-2.5L	BMW 325IS
	1992-2005	L6-2.5L	BMW 325I
	1997-2001	L6-2.5L	BMW 323I (MEX)
	1998-1999	L6-2.5L	BMW 323IS
	1998-2000	L6-2.5L	BMW 323I
	1999-2002	L6-2.5L	BMW Z3
	2000	L6-2.5L	BMW 323CI
	2001	L6-2.5L	BMW 323TI (MEX)
	2001-2005	L6-2.5L	BMW 325XI
	2001-2006	L6-2.5L	BMW 325CI
	2006-2009	L6-2.5L	BMW X3 AWD (MEX)
	2007	L6-2.5L	BMW 325CI (MEX)
	1995	L6-2.8L	BMW 328I (MEX)
	1996	L6-2.8L	BMW 528 (MEX)
	1996-1999	L6-2.8L	BMW 328IS
	1996-2000	L6-2.8L	BMW 328I
	1997-2000	L6-2.8L	BMW 528I
	1997-2000	L6-2.8L	BMW Z3
	2000	L6-2.8L	BMW 328CI
	1994	L6-3.0L	BMW M3 (MEX)
	1995	L6-3.0L	BMW M3
	2001-2002	L6-3.0L	BMW Z3
	2001-2003	L6-3.0L	BMW 530I
	2001-2005	L6-3.0L	BMW 330I
	2001-2005	L6-3.0L	BMW 330XI
	2001-2006	L6-3.0L	BMW 330CI
	2001-2006	L6-3.0L	BMW X5
	1980-1984	L6-3.2L	BMW 733I
	1996-2006	L6-3.2L	BMW M3
	1998-2002	L6-3.2L	BMW Z3
	1985-1992	L6-3.5L	BMW 735I
	1986-1987	L6-3.5L	BMW L7
	1988-1992	L6-3.5L	BMW 735IL
	1989-1993	L6-3.5L	BMW 535I
	1991-1993	L6-3.6L	BMW M5
	1988-1994	V12-5.0L	BMW 750IL
	1991-1992	V12-5.0L	BMW 850I
	1993-1994	V12-5.0L	BMW 850CI
	1995-1997	V12-5.4L	BMW 850CI
	1995-2001	V12-5.4L	BMW 750IL
	1994-1995	V12-5.6L	BMW 850CSI
	1994-1995	V8-3.0L	BMW 530I
	1993-1995	V8-4.0L	BMW 740I
	1993-1995	V8-4.0L	BMW 740IL
	1994-1995	V8-4.0L	BMW 540I
	1994-1995	V8-4.0L	BMW 840CI
	1994	V8-4.2L	MERCEDES-BENZ 400E (MEX)
	1995-1997	V8-4.2L	MERCEDES-BENZ 400SEL (MEX)
	1996-1997	V8-4.2L	MERCEDES-BENZ 400SE (MEX)
	1996-1997	V8-4.2L	MERCEDES-BENZ 420SL (MEX)
	1996-1997	V8-4.4L	BMW 840CI
	1996-2001	V8-4.4L	BMW 740IL
	1997-2001	V8-4.4L	BMW 740I
	1997-2003	V8-4.4L	BMW 540I
	1987-1997	V8-5.0L	MERCEDES-BENZ 500SEC (MEX)
	1989	V8-5.0L	MERCEDES-BENZ 500SL (MEX)
	1991	V8-5.0L	MERCEDES-BENZ 500E (MEX)

USMW	Years	Cyl.	Specifications
	1991-1997	V8-5.0L	MERCEDES-BENZ 500SEL (MEX)
	1996-1997	V8-5.0L	MERCEDES-BENZ 500CL (MEX)
<b>22123</b>	2011-2012	V8-6.0L	CHEVROLET SILVERADO 2500 HD
	2011-2012	V8-6.0L	CHEVROLET SILVERADO 3500 HD
	2011-2012	V8-6.0L	GMC SIERRA 2500 HD
	2011-2012	V8-6.0L	GMC SIERRA 3500 HD
<b>22126</b>	1985-1996	L6-3.8L	FORD COUGAR (MEX)
	1980-1983	L6-4.2L	JEEP CHEROKEE
	1980-1983	L6-4.2L	JEEP CJ5
	1980-1983	L6-4.2L	JEEP WAGONEER
	1980-1986	L6-4.2L	JEEP CJ7
	1980-1987	L6-4.2L	JEEP J10
	1981-1985	L6-4.2L	JEEP SCRAMBLER
	1984-1986	L6-4.2L	JEEP GRAND WAGONEER
	1982	V6-3.8L	FORD GRANADA
	1982	V6-3.8L	LINCOLN CONTINENTAL
	1982-1983	V6-3.8L	FORD F-100
	1982-1993	V6-3.8L	FORD THUNDERBIRD
	1982-1993	V6-3.8L	MERCURY COUGAR
	1983-1986	V6-3.8L	FORD LTD
	1983-1986	V6-3.8L	FORD MUSTANG
	1983-1986	V6-3.8L	MERCURY MARQUIS
	1984-1986	V6-3.8L	MERCURY CAPRI
	1980-1982	V8-4.2L	FORD MUSTANG
	1981-1982	V8-4.2L	MERCURY CAPRI
	1982-1986	V8-5.0L	MERCURY CAPRI
	1982-1993	V8-5.0L	FORD MUSTANG
	1984-1985	V8-5.0L	FORD LTD
	1985-1987	V8-5.0L	LINCOLN CONTINENTAL
	1985-1988	V8-5.0L	FORD THUNDERBIRD
	1985-1992	V8-5.0L	LINCOLN MARK VII
	1986-1988	V8-5.0L	MERCURY COUGAR
<b>22135</b>	2001-2005	L4-2.3L	FORD RANGER
	2001-2009	L4-2.3L	MAZDA B2300
<b>22136</b>	1997-2000	L4-2.2L	ISUZU HOMBRE
	1997-2003	L4-2.2L	CHEVROLET S10
	1997-2003	L4-2.2L	GMC SONOMA
<b>22139</b>	2002-2005	V6-4.0L	FORD EXPLORER
	2002-2005	V6-4.0L	MERCURY MOUNTAINEER
	2002-2005	V8-4.6L	FORD EXPLORER
	2002-2005	V8-4.6L	MERCURY MOUNTAINEER
	2003-2005	V8-4.6L	LINCOLN AVIATOR
<b>22140</b>	1988-1995	V6-4.3L	GMC C1500
	1988-1995	V6-4.3L	GMC C2500
	1995	V6-4.3L	CHEVROLET BLAZER
	1995	V6-4.3L	CHEVROLET S10
	1995	V6-4.3L	GMC JIMMY
	1995	V6-4.3L	GMC SONOMA
	1988-1995	V8-5.0L	GMC C1500
	1988-1995	V8-5.0L	GMC C2500
	1988-1995	V8-5.7L	GMC C1500
	1988-1995	V8-5.7L	GMC C2500
	1989	V8-5.7L	CHEVROLET V2500 SUBURBAN
	1989-1991	V8-5.7L	CHEVROLET BLAZER
	1989-1991	V8-5.7L	CHEVROLET V1500 SUBURBAN
	1991	V8-5.7L	CHEVROLET R2500 SUBURBAN
	1992-1995	V8-5.7L	GMC C1500 SUBURBAN
	1992-1995	V8-5.7L	GMC C2500 SUBURBAN
	1995-1996	V8-5.7L	AM GENERAL HUMMER
<b>22142</b>	1987-1989	V6-2.8L	CHEVROLET S10 BLAZER
	1987-1989	V6-2.8L	GMC S15 JIMMY
	1987-1990	V6-2.8L	GMC S15
	1987-1993	V6-2.8L	CHEVROLET S10
	1991-1993	V6-2.8L	GMC SONOMA
	1987-1994	V6-4.3L	CHEVROLET ASTRO
	1987-1995	V6-4.3L	GMC G2500
	1991	V6-4.3L	CHEVROLET S10
	1991-1993	V6-4.3L	CHEVROLET S10 BLAZER
	1987-1995	V8-5.0L	GMC G2500

USMW	Years	Cyl.	Specifications
	1987-1988	V8-5.7L	CHEVROLET G20
	1987-1995	V8-5.7L	GMC G2500
	1988-1991	V8-5.7L	CHEVROLET C2500 (MEX)
	1988-1991	V8-5.7L	GMC C2500 (MEX)
	1994-1995	V8-5.7L	GMC C3500
<b>22143</b>	1988-1990	V6-4.3L	CHEVROLET S10 BLAZER
	1988-1990	V6-4.3L	GMC S15
	1988-1991	V6-4.3L	GMC S15 JIMMY
	1988-1993	V6-4.3L	CHEVROLET S10
	1991-1994	V6-4.3L	OLDSMOBILE BRAVADA
	1992-1993	V6-4.3L	GMC JIMMY
<b>22145</b>	1987-1995	V6-4.3L	GMC G1500
	1987-1995	V6-4.3L	GMC G2500
	1987-1995	V6-4.3L	GMC G3500
	1988-1990	V6-4.3L	GMC S15
	1988-1990	V6-4.3L	GMC S15 JIMMY
	1988-1994	V6-4.3L	CHEVROLET S10
	1988-1994	V6-4.3L	CHEVROLET S10 BLAZER
	1988-1995	V6-4.3L	GMC K1500
	1988-1995	V6-4.3L	GMC K2500
	1989-1993	V6-4.3L	CHEVROLET CAPRICE
	1991	V6-4.3L	GMC SYCLONE
	1991-1994	V6-4.3L	GMC SONOMA
	1991-1994	V6-4.3L	OLDSMOBILE BRAVADA
	1992-1993	V6-4.3L	GMC TYPHOON
	1992-1994	V6-4.3L	GMC JIMMY
	1995	V6-4.3L	CHEVROLET ASTRO
	1995	V6-4.3L	GMC SAFARI
	1987-1995	V8-5.0L	GMC G1500
	1987-1995	V8-5.0L	GMC G2500
	1988-1995	V8-5.0L	GMC K1500
	1988-1995	V8-5.0L	GMC K2500
	1989-1993	V8-5.0L	CHEVROLET CAPRICE
	1991	V8-5.0L	BUICK COMMERCIAL CHASSIS
	1991	V8-5.0L	BUICK ROADMASTER
	1991-1992	V8-5.0L	CADILLAC BROUGHAM
	1991-1992	V8-5.0L	OLDSMOBILE CUSTOM CRUISER
	1987-1992	V8-5.7L	GMC G2500
	1987-1992	V8-5.7L	GMC G3500
	1987-1993	V8-5.7L	GMC G1500
	1988-1991	V8-5.7L	GMC C2500 (MEX)
	1988-1995	V8-5.7L	GMC C3500
	1988-1995	V8-5.7L	GMC K1500
	1988-1995	V8-5.7L	GMC K2500
	1988-1995	V8-5.7L	GMC K3500
	1988-1998	V8-5.7L	CHEVROLET C2500 (MEX)
	1989	V8-5.7L	CHEVROLET R2500
	1989	V8-5.7L	GMC R2500
	1989-1991	V8-5.7L	CHEVROLET R2500 SUBURBAN
	1989-1991	V8-5.7L	CHEVROLET V2500 SUBURBAN
	1989-1991	V8-5.7L	GMC JIMMY
	1989-1991	V8-5.7L	GMC R1500 SUBURBAN
	1989-1991	V8-5.7L	GMC R2500 SUBURBAN
	1989-1991	V8-5.7L	GMC V1500 SUBURBAN
	1989-1991	V8-5.7L	GMC V2500 SUBURBAN
	1989-1993	V8-5.7L	CHEVROLET CAPRICE
	1990-1992	V8-5.7L	CADILLAC BROUGHAM
	1992	V8-5.7L	OLDSMOBILE CUSTOM CRUISER
	1992-1993	V8-5.7L	BUICK COMMERCIAL CHASSIS
	1992-1993	V8-5.7L	BUICK ROADMASTER
	1992-1993	V8-5.7L	CADILLAC COMMERCIAL CHASSIS
	1992-1995	V8-5.7L	GMC K1500 SUBURBAN
	1992-1995	V8-5.7L	GMC K2500 SUBURBAN
	1992-1995	V8-5.7L	GMC YUKON
	1993	V8-5.7L	CADILLAC FLEETWOOD
	1994	V8-5.7L	CHEVROLET 400SS PICKUP (MEX)
	1995	V8-5.7L	CHEVROLET TAHOE
	1996	V8-5.7L	CHEVROLET BOSS TRUCK (MEX)
	1988	V8-7.4L	CHEVROLET R20



USMW	Years	Cyl.	Specifications
	1988	V8-7.4L	CHEVROLET R20 SUBURBAN
	1988	V8-7.4L	CHEVROLET R30
	1988	V8-7.4L	CHEVROLET V20 SUBURBAN
	1988	V8-7.4L	CHEVROLET V30
	1988-1989	V8-7.4L	GMC R2500
	1988-1991	V8-7.4L	GMC R2500 SUBURBAN
	1988-1991	V8-7.4L	GMC R3500
	1988-1991	V8-7.4L	GMC V3500
	1988-1996	V8-7.4L	CHEVROLET G30
	1988-1996	V8-7.4L	GMC G3500
	1988-2000	V8-7.4L	CHEVROLET C3500
	1988-2000	V8-7.4L	CHEVROLET K3500
	1988-2000	V8-7.4L	GMC C3500
	1988-2000	V8-7.4L	GMC K3500
	1989	V8-7.4L	CHEVROLET R2500
	1989-1991	V8-7.4L	CHEVROLET R2500 SUBURBAN
	1990	V8-7.4L	CHEVROLET V2500 SUBURBAN
	1990-1991	V8-7.4L	CHEVROLET R3500
	1990-1991	V8-7.4L	CHEVROLET V3500
	1990-1993	V8-7.4L	CHEVROLET C1500
	1991-2000	V8-7.4L	CHEVROLET C2500
	1991-2000	V8-7.4L	CHEVROLET K2500
	1991-2000	V8-7.4L	GMC C2500
	1991-2000	V8-7.4L	GMC K2500
	1992-1999	V8-7.4L	CHEVROLET C2500 SUBURBAN
	1992-1999	V8-7.4L	CHEVROLET K2500 SUBURBAN
	1992-1999	V8-7.4L	GMC C2500 SUBURBAN
	1992-1999	V8-7.4L	GMC K2500 SUBURBAN
	1996-1999	V8-7.4L	GMC P3500
	1996-2000	V8-7.4L	CHEVROLET EXPRESS 3500
	1996-2000	V8-7.4L	GMC SAVANA 3500
	1998-1999	V8-7.4L	CHEVROLET P30
<b>22146</b>	1982	L6-4.9L	FORD F-100
	1985-1986	V6-3.8L	FORD MUSTANG
	1985-1986	V6-3.8L	MERCURY CAPRI
	1984-1985	V8-5.0L	FORD LTD
	1985	V8-5.0L	MERCURY MARQUIS
	1985-1986	V8-5.0L	MERCURY CAPRI
	1986-1993	V8-5.0L	FORD MUSTANG
	1987-1990	V8-5.0L	FORD F200 (MEX)
	1987-1991	V8-5.0L	FORD E-250 ECONOLINE
	1987-1996	V8-5.0L	FORD BRONCO
	1987-1996	V8-5.0L	FORD E-150 ECONOLINE
	1987-1996	V8-5.0L	FORD E-150 ECONOLINE CLUB WAGON
	1987-1996	V8-5.0L	FORD F-150
	1987-1996	V8-5.0L	FORD F-250
	1991	V8-5.2L	DODGE DAKOTA
	1988-1990	V8-5.8L	FORD F200 (MEX)
	1988-1991	V8-5.8L	FORD E-250 ECONOLINE CLUB WAGON
	1988-1996	V8-5.8L	FORD BRONCO
	1988-1996	V8-5.8L	FORD E-150 ECONOLINE
	1988-1996	V8-5.8L	FORD E-150 ECONOLINE CLUB WAGON
	1988-1996	V8-5.8L	FORD E-250 ECONOLINE
	1988-1996	V8-5.8L	FORD E-350 ECONOLINE
	1988-1996	V8-5.8L	FORD E-350 ECONOLINE CLUB WAGON
	1988-1996	V8-5.8L	FORD F-150
	1988-1997	V8-5.8L	FORD F-250
	1988-1997	V8-5.8L	FORD F-350
<b>22147</b>	1987-1988	L4-2.5L	CHEVROLET S10 BLAZER
	1987-1988	L4-2.5L	GMC S15 JIMMY
	1987-1990	L4-2.5L	GMC S15
	1987-1993	L4-2.5L	CHEVROLET LLV
	1987-1993	L4-2.5L	CHEVROLET S10
	1988-1990	L4-2.5L	CHEVROLET ASTRO
	1988-1990	L4-2.5L	GMC SAFARI
	1991-1993	L4-2.5L	GMC SONOMA
<b>22148</b>	1985	L4-2.1L	JEEP WAGONEER
	1985-1987	L4-2.1L	JEEP CHEROKEE
	1986-1987	L4-2.1L	JEEP COMANCHE

USMW	Years	Cyl.	Specifications
	2003-2006	L4-2.4L	JEEP WRANGLER
	1984	L4-2.5L	AMERICAN MOTORS EAGLE
	1984-1987	L4-2.5L	JEEP WAGONEER
	1984-1993	L4-2.5L	JEEP CHEROKEE
	1986-1992	L4-2.5L	JEEP COMANCHE
	1991-2002	L4-2.5L	JEEP WRANGLER
	1987-1990	L6-4.0L	JEEP WAGONEER
	1987-1992	L6-4.0L	JEEP COMANCHE
	1987-2001	L6-4.0L	JEEP CHEROKEE
	1997-1999	L6-4.0L	JEEP WRANGLER
	1984-1988	L6-4.2L	AMERICAN MOTORS EAGLE
	1987-1990	L6-4.2L	JEEP WRANGLER
<b>22149</b>	1994-2000	L4-2.5L	JEEP CHEROKEE
	1991-1995	L6-4.0L	JEEP WRANGLER
<b>22150</b>	2004	V6-3.7L	DODGE DAKOTA
	2009-2010	V8-4.7L	DODGE RAM 1500
	2011	V8-4.7L	RAM 1500
<b>22151</b>	1999-2004	L6-4.0L	JEEP GRAND CHEROKEE
	2002-2010	V6-3.7L	JEEP LIBERTY
	2009-2010	V6-3.7L	DODGE NITRO
	2010	V6-3.7L	JEEP COMMANDER
	2010	V6-3.7L	JEEP GRAND CHEROKEE
	2009-2010	V6-4.0L	DODGE NITRO
	1999-2000	V8-4.7L	JEEP GRAND CHEROKEE
	2007-2009	V8-4.7L	DODGE RAM 2500 (MEX)
	2009	V8-4.7L	JEEP COMMANDER
	1992	V8-5.2L	JEEP GRAND CHEROKEE (MEX)
	1994-2000	V8-5.9L	DODGE RAMCHARGER (MEX)
<b>22152</b>	2010-2011	V6-3.8L	JEEP WRANGLER
	2005-2009	V8-4.7L	JEEP GRAND CHEROKEE
	2006-2008	V8-4.7L	JEEP COMMANDER
<b>22153</b>	1994-1995	L4-2.2L	CHEVROLET LLV
	1994-1996	L4-2.2L	CHEVROLET S10
	1994-1996	L4-2.2L	GMC SONOMA
	1987-1989	V6-4.3L	CHEVROLET ASTRO
	1987-1994	V6-4.3L	GMC SAFARI
	1987-1995	V6-4.3L	CHEVROLET G10
	1987-1995	V6-4.3L	CHEVROLET G20
	1987-1995	V6-4.3L	CHEVROLET G30
	1988-1995	V6-4.3L	CHEVROLET C1500
	1988-1995	V6-4.3L	CHEVROLET C2500
	1988-1995	V6-4.3L	CHEVROLET K1500
	1988-1995	V6-4.3L	CHEVROLET K2500
	1991-1995	V6-4.3L	GMC SONOMA
	1994-1995	V6-4.3L	CHEVROLET S10
	1995	V6-4.3L	CHEVROLET BLAZER
	1995	V6-4.3L	GMC JIMMY
	1987-1995	V8-5.0L	CHEVROLET G10
	1987-1995	V8-5.0L	CHEVROLET G20
	1988-1995	V8-5.0L	CHEVROLET C1500
	1988-1995	V8-5.0L	CHEVROLET C2500
	1988-1995	V8-5.0L	CHEVROLET K1500
	1988-1995	V8-5.0L	CHEVROLET K2500
	1987-1993	V8-5.7L	CHEVROLET G10
	1987-1996	V8-5.7L	CHEVROLET G30
	1988-1995	V8-5.7L	CHEVROLET C1500
	1988-1995	V8-5.7L	CHEVROLET C2500
	1988-1995	V8-5.7L	CHEVROLET C3500
	1988-1995	V8-5.7L	CHEVROLET G20
	1988-1995	V8-5.7L	CHEVROLET K1500
	1988-1995	V8-5.7L	CHEVROLET K2500
	1988-1995	V8-5.7L	CHEVROLET K3500
	1989-1991	V8-5.7L	CHEVROLET R1500 SUBURBAN
	1989-1991	V8-5.7L	CHEVROLET V1500 SUBURBAN
	1989-1994	V8-5.7L	CHEVROLET BLAZER
	1992-1995	V8-5.7L	CHEVROLET C1500 SUBURBAN
	1992-1995	V8-5.7L	CHEVROLET C2500 SUBURBAN
	1992-1995	V8-5.7L	CHEVROLET K1500 SUBURBAN
	1992-1995	V8-5.7L	CHEVROLET K2500 SUBURBAN

USMW	Years	Cyl.	Specifications
	1993-1996	V8-5.7L	GMC G3500
	1994-1995	V8-5.7L	CHEVROLET SILVERADO (MEX)
<b>22154</b>	1988-1993	V8-6.2L	CHEVROLET C1500
	1988-1993	V8-6.2L	CHEVROLET C2500
	1988-1993	V8-6.2L	CHEVROLET C3500
	1988-1993	V8-6.2L	CHEVROLET K1500
	1988-1993	V8-6.2L	CHEVROLET K2500
	1988-1993	V8-6.2L	CHEVROLET K3500
	1988-1993	V8-6.2L	GMC C1500
	1988-1993	V8-6.2L	GMC C2500
	1988-1993	V8-6.2L	GMC C3500
	1988-1993	V8-6.2L	GMC K1500
	1988-1993	V8-6.2L	GMC K2500
	1988-1993	V8-6.2L	GMC K3500
	1994-1995	V8-6.5L	CHEVROLET G20
	1994-1995	V8-6.5L	GMC G2500
	1994-1996	V8-6.5L	CHEVROLET G30
	1994-1996	V8-6.5L	GMC G3500
	1994-1996	V8-6.5L	GMC P3500
<b>22155</b>	1992-1996	L6-4.9L	FORD E-150 ECONOLINE
	1992-1996	L6-4.9L	FORD E-150 ECONOLINE CLUB WAGON
	1992-1996	L6-4.9L	FORD E-250 ECONOLINE
	1992-1996	L6-4.9L	FORD E-350 ECONOLINE
	1992-1996	L6-4.9L	FORD E-350 ECONOLINE CLUB WAGON
	1993-1994	L6-4.9L	FORD F-350
	1993-1996	L6-4.9L	FORD F-150
	1993-1996	L6-4.9L	FORD F-250
<b>22156</b>	1994-1996	L4-2.2L	CHEVROLET S10
	1994-1996	L4-2.2L	GMC SONOMA
	1996	L4-2.2L	ISUZU HOMBRE
<b>22157</b>	1996-2002	V6-4.3L	CHEVROLET EXPRESS 1500
	1996-2002	V6-4.3L	CHEVROLET EXPRESS 2500
	1996-2002	V6-4.3L	GMC SAVANA 1500
	1996-2002	V6-4.3L	GMC SAVANA 2500
	1996-2002	V8-5.0L	CHEVROLET EXPRESS 1500
	1996-2002	V8-5.0L	CHEVROLET EXPRESS 2500
	1996-2002	V8-5.0L	GMC SAVANA 1500
	1996-2002	V8-5.0L	GMC SAVANA 2500
	1996-2002	V8-5.7L	CHEVROLET EXPRESS 1500
	1996-2002	V8-5.7L	CHEVROLET EXPRESS 2500
	1996-2002	V8-5.7L	CHEVROLET EXPRESS 3500
	1996-2002	V8-5.7L	GMC SAVANA 1500
	1996-2002	V8-5.7L	GMC SAVANA 2500
	1996-2002	V8-5.7L	GMC SAVANA 3500
	2012	V8-6.0L	CHEVROLET SUBURBAN 2500
	2012	V8-6.0L	GMC YUKON XL 2500
<b>22158</b>	1996-1998	V6-4.3L	CHEVROLET C1500
	1996-1998	V6-4.3L	CHEVROLET K1500
	1996-1998	V6-4.3L	GMC C1500
	1996-1998	V6-4.3L	GMC K1500
	1996-1999	V6-4.3L	CHEVROLET P30
	1996-1999	V6-4.3L	GMC P3500
	1996-2001	V6-4.3L	GMC JIMMY
	1996-2001	V6-4.3L	OLDSMOBILE BRAVADA
	1996-2004	V6-4.3L	CHEVROLET S10
	1996-2004	V6-4.3L	GMC SONOMA
	1996-2005	V6-4.3L	CHEVROLET ASTRO
	1996-2005	V6-4.3L	CHEVROLET BLAZER
	1996-2005	V6-4.3L	GMC SAFARI
	1997-2000	V6-4.3L	ISUZU HOMBRE
	1999-2004	V6-4.3L	CHEVROLET SILVERADO 1500
	1999-2004	V6-4.3L	GMC SIERRA 1500
	2003-2005	V6-4.3L	CHEVROLET EXPRESS 2500
	2003-2005	V6-4.3L	GMC SAVANA 2500
	2003-2012	V6-4.3L	CHEVROLET EXPRESS 1500
	2003-2012	V6-4.3L	GMC SAVANA 1500
	1999-2007	V8-4.8L	CHEVROLET SILVERADO 1500
	1999-2007	V8-4.8L	GMC SIERRA 1500
	2000-2006	V8-4.8L	CHEVROLET TAHOE

USMW	Years	Cyl.	Specifications
	2000-2006	V8-4.8L	GMC YUKON
	2003-2012	V8-4.8L	CHEVROLET EXPRESS 2500
	2003-2012	V8-4.8L	GMC SAVANA 2500
	2004-2012	V8-4.8L	GMC SAVANA 3500
	2005-2012	V8-4.8L	CHEVROLET EXPRESS 3500
	1996-1998	V8-5.0L	CHEVROLET C2500
	1996-1998	V8-5.0L	GMC C2500
	1996-1999	V8-5.0L	CHEVROLET C1500
	1996-1999	V8-5.0L	CHEVROLET K1500
	1996-1999	V8-5.0L	GMC C1500
	1996-1999	V8-5.0L	GMC K1500
	1998	V8-5.0L	CHEVROLET K2500
	1998	V8-5.0L	GMC K2500
	1999-2000	V8-5.3L	CHEVROLET SILVERADO 2500
	1999-2000	V8-5.3L	GMC SIERRA 2500
	1999-2007	V8-5.3L	CHEVROLET SILVERADO 1500
	1999-2007	V8-5.3L	GMC SIERRA 1500
	2000-2006	V8-5.3L	CHEVROLET SUBURBAN 1500
	2000-2006	V8-5.3L	CHEVROLET TAHOE
	2000-2006	V8-5.3L	GMC YUKON
	2000-2006	V8-5.3L	GMC YUKON XL 1500
	2002-2005	V8-5.3L	CADILLAC ESCALADE
	2002-2006	V8-5.3L	CHEVROLET AVALANCHE 1500
	2003-2005	V8-5.3L	CHEVROLET EXPRESS 2500
	2003-2005	V8-5.3L	GMC SAVANA 2500
	2003-2012	V8-5.3L	CHEVROLET EXPRESS 1500
	2003-2012	V8-5.3L	GMC SAVANA 1500
	1996-1997	V8-5.7L	CHEVROLET SILVERADO (MEX)
	1996-1999	V8-5.7L	CHEVROLET C1500
	1996-1999	V8-5.7L	CHEVROLET C1500 SUBURBAN
	1996-1999	V8-5.7L	CHEVROLET C2500 SUBURBAN
	1996-1999	V8-5.7L	CHEVROLET K1500
	1996-1999	V8-5.7L	CHEVROLET K1500 SUBURBAN
	1996-1999	V8-5.7L	CHEVROLET K2500 SUBURBAN
	1996-1999	V8-5.7L	GMC C1500
	1996-1999	V8-5.7L	GMC C1500 SUBURBAN
	1996-1999	V8-5.7L	GMC C2500 SUBURBAN
	1996-1999	V8-5.7L	GMC K1500
	1996-1999	V8-5.7L	GMC K1500 SUBURBAN
	1996-1999	V8-5.7L	GMC K2500 SUBURBAN
	1996-2000	V8-5.7L	CHEVROLET C2500
	1996-2000	V8-5.7L	CHEVROLET C3500
	1996-2000	V8-5.7L	CHEVROLET K2500
	1996-2000	V8-5.7L	CHEVROLET K3500
	1996-2000	V8-5.7L	CHEVROLET TAHOE
	1996-2000	V8-5.7L	GMC C2500
	1996-2000	V8-5.7L	GMC C3500
	1996-2000	V8-5.7L	GMC K2500
	1996-2000	V8-5.7L	GMC K3500
	1996-2000	V8-5.7L	GMC YUKON
	1999-2000	V8-5.7L	CADILLAC ESCALADE
	2001-2003	V8-5.7L	CHEVROLET SILVERADO 3500 (MEX)
	1999-2004	V8-6.0L	CHEVROLET SILVERADO 2500
	1999-2004	V8-6.0L	GMC SIERRA 2500
	2000-2011	V8-6.0L	CHEVROLET SUBURBAN 2500
	2000-2011	V8-6.0L	GMC YUKON XL 2500
	2001	V8-6.0L	GMC SIERRA C3
	2001-2006	V8-6.0L	GMC YUKON
	2001-2006	V8-6.0L	GMC YUKON XL 1500
	2001-2007	V8-6.0L	CHEVROLET SILVERADO 1500 HD
	2001-2007	V8-6.0L	CHEVROLET SILVERADO 3500
	2001-2007	V8-6.0L	GMC SIERRA 1500 HD
	2001-2007	V8-6.0L	GMC SIERRA 3500
	2001-2010	V8-6.0L	CHEVROLET SILVERADO 2500 HD
	2001-2010	V8-6.0L	GMC SIERRA 2500 HD
	2002-2006	V8-6.0L	CADILLAC ESCALADE
	2002-2006	V8-6.0L	CADILLAC ESCALADE EXT
	2002-2007	V8-6.0L	GMC SIERRA 1500
	2003-2006	V8-6.0L	CADILLAC ESCALADE ESV

USMW	Years	Cyl.	Specifications	USMW	Years	Cyl.	Specifications
	2003-2007	V8-6.0L	CHEVROLET SILVERADO 1500		1999-2001	V8-5.2L	DODGE RAMCHARGER (MEX)
	2003-2007	V8-6.0L	HUMMER H2		1999-2003	V8-5.2L	DODGE RAM 1500 VAN
	2003-2012	V8-6.0L	CHEVROLET EXPRESS 2500		1999-2003	V8-5.2L	DODGE RAM 2500 VAN
	2003-2012	V8-6.0L	CHEVROLET EXPRESS 3500		1999-2003	V8-5.2L	DODGE RAM 3500 VAN
	2003-2012	V8-6.0L	GMC SAVANA 2500		1993-1994	V8-5.9L	DODGE B250
	2003-2012	V8-6.0L	GMC SAVANA 3500		1993-1994	V8-5.9L	DODGE B350
	2006	V8-6.0L	CHEVROLET SUBURBAN 1500		1995-1997	V8-5.9L	DODGE B2500
	2007-2010	V8-6.0L	CHEVROLET SILVERADO 3500 HD		1995-1997	V8-5.9L	DODGE B3500
	2007-2010	V8-6.0L	GMC SIERRA 3500 HD		1998-2001	V8-5.9L	DODGE RAM 1500
	2009-2012	V8-6.0L	CHEVROLET EXPRESS 4500		1998-2002	V8-5.9L	DODGE RAM 3500
	2009-2012	V8-6.0L	GMC SAVANA 4500		1999-2003	V8-5.9L	DODGE RAM 1500 VAN
	2001-2002	V8-8.1L	CHEVROLET EXPRESS 3500		1999-2003	V8-5.9L	DODGE RAM 2500 VAN
	2001-2002	V8-8.1L	GMC SAVANA 3500		1999-2003	V8-5.9L	DODGE RAM 3500 VAN
	2001-2006	V8-8.1L	CHEVROLET SUBURBAN 2500		2000-2002	V8-5.9L	DODGE RAM 2500
	2001-2006	V8-8.1L	GMC YUKON XL 2500	<b>22161</b>	1987-1991	L6-4.9L	FORD E-150 ECONOLINE
	2001-2007	V8-8.1L	CHEVROLET SILVERADO 2500 HD		1987-1991	L6-4.9L	FORD E-150 ECONOLINE CLUB WAGON
	2001-2007	V8-8.1L	CHEVROLET SILVERADO 3500		1987-1991	L6-4.9L	FORD E-250 ECONOLINE
	2001-2007	V8-8.1L	GMC SIERRA 2500 HD		1987-1991	L6-4.9L	FORD E-250 ECONOLINE CLUB WAGON
	2001-2007	V8-8.1L	GMC SIERRA 3500		1987-1991	L6-4.9L	FORD E-350 ECONOLINE
	2002-2006	V8-8.1L	CHEVROLET AVALANCHE 2500		1987-1991	L6-4.9L	FORD E-350 ECONOLINE CLUB WAGON
<b>22159</b>	1994-2003	V10-8.0L	DODGE RAM 2500		1987-1991	L6-4.9L	FORD F-350
	1994-2003	V10-8.0L	DODGE RAM 3500		1987-1992	L6-4.9L	FORD BRONCO
	2004-2009	V6-3.7L	DODGE DURANGO		1987-1992	L6-4.9L	FORD F-150
	1994	V6-3.9L	DODGE B150		1987-1992	L6-4.9L	FORD F-250
	1994	V6-3.9L	DODGE B250	<b>22162</b>	1996-2000	L4-2.2L	ISUZU HOMBRE
	1995-1997	V6-3.9L	DODGE B1500		1996-1998	V6-4.3L	CHEVROLET C1500
	1995-1997	V6-3.9L	DODGE B2500		1996-1998	V6-4.3L	CHEVROLET K1500
	1997-2008	V6-4.2L	FORD F-150		1996-1998	V6-4.3L	GMC C1500
	2004	V6-4.2L	FORD F-150 HERITAGE		1996-1998	V6-4.3L	GMC K1500
	2004-2009	V8-4.7L	DODGE DURANGO		1996-2001	V6-4.3L	OLDSMOBILE BRAVADA
	2007-2009	V8-4.7L	CHRYSLER ASPEN		1996-2002	V6-4.3L	CHEVROLET EXPRESS 1500
	1992-1994	V8-5.2L	DODGE B150		1996-2002	V6-4.3L	CHEVROLET EXPRESS 2500
	1992-1994	V8-5.2L	DODGE B250		1996-2002	V6-4.3L	GMC SAVANA 1500
	1992-1994	V8-5.2L	DODGE B350		1996-2002	V6-4.3L	GMC SAVANA 2500
	1994-1998	V8-5.2L	JEEP GRAND CHEROKEE		1996-2003	V6-4.3L	CHEVROLET BLAZER
	1995-1998	V8-5.2L	DODGE B1500		1996-2003	V6-4.3L	CHEVROLET S10
	1995-1998	V8-5.2L	DODGE B2500		1996-2003	V6-4.3L	GMC SONOMA
	1995-1998	V8-5.2L	DODGE B3500		1997-2000	V6-4.3L	ISUZU HOMBRE
	1999-2003	V8-5.2L	DODGE RAM 1500 VAN		1997-2001	V6-4.3L	GMC JIMMY
	1999-2003	V8-5.2L	DODGE RAM 2500 VAN		1996-1998	V8-5.0L	CHEVROLET C1500
	1999-2003	V8-5.2L	DODGE RAM 3500 VAN		1996-1998	V8-5.0L	CHEVROLET C2500
	1999-2005	V8-5.4L	FORD F-250 SUPER DUTY		1996-1998	V8-5.0L	GMC C1500
	1999-2005	V8-5.4L	FORD F-350 SUPER DUTY		1996-1998	V8-5.0L	GMC C2500
	2000-2005	V8-5.4L	FORD EXCURSION		1996-1999	V8-5.0L	CHEVROLET K1500
	1993-1994	V8-5.9L	DODGE B250		1996-1999	V8-5.0L	GMC K1500
	1993-1994	V8-5.9L	DODGE B350		1996-2002	V8-5.0L	CHEVROLET EXPRESS 1500
	1995-1998	V8-5.9L	DODGE B2500		1996-2002	V8-5.0L	CHEVROLET EXPRESS 2500
	1995-1998	V8-5.9L	DODGE B3500		1996-2002	V8-5.0L	GMC SAVANA 1500
	1998	V8-5.9L	DODGE B1500		1996-2002	V8-5.0L	GMC SAVANA 2500
	1999-2003	V8-5.9L	DODGE RAM 1500 VAN		1998	V8-5.0L	CHEVROLET K2500
	1999-2003	V8-5.9L	DODGE RAM 2500 VAN		1998	V8-5.0L	GMC K2500
	1999-2003	V8-5.9L	DODGE RAM 3500 VAN		1996-1998	V8-5.7L	CHEVROLET C1500
	2000-2002	V8-5.9L	DODGE RAM 2500		1996-1998	V8-5.7L	GMC C1500
<b>22160</b>	2000-2006	L6-4.0L	JEEP WRANGLER		1996-1999	V8-5.7L	CHEVROLET C1500 SUBURBAN
	1992-1994	V6-3.9L	DODGE B150		1996-1999	V8-5.7L	CHEVROLET C2500 SUBURBAN
	1992-1994	V6-3.9L	DODGE B250		1996-1999	V8-5.7L	CHEVROLET K1500
	1994-2001	V6-3.9L	DODGE RAM 1500		1996-1999	V8-5.7L	CHEVROLET K1500 SUBURBAN
	1995-1997	V6-3.9L	DODGE B2500		1996-1999	V8-5.7L	CHEVROLET K2500 SUBURBAN
	1995-1998	V6-3.9L	DODGE B1500		1996-1999	V8-5.7L	GMC C1500 SUBURBAN
	1999-2003	V6-3.9L	DODGE RAM 1500 VAN		1996-1999	V8-5.7L	GMC C2500 SUBURBAN
	2001	V6-3.9L	DODGE RAM 2500 VAN		1996-1999	V8-5.7L	GMC K1500
	1992-1994	V8-5.2L	DODGE B150		1996-1999	V8-5.7L	GMC K1500 SUBURBAN
	1992-1994	V8-5.2L	DODGE B250		1996-1999	V8-5.7L	GMC K2500 SUBURBAN
	1992-1994	V8-5.2L	DODGE B350		1996-2000	V8-5.7L	CHEVROLET C2500
	1994-1996	V8-5.2L	DODGE RAM 2500		1996-2000	V8-5.7L	CHEVROLET C3500
	1994-2001	V8-5.2L	DODGE RAM 1500		1996-2000	V8-5.7L	CHEVROLET K2500
	1995-1997	V8-5.2L	DODGE B1500		1996-2000	V8-5.7L	CHEVROLET K3500
	1995-1997	V8-5.2L	DODGE B2500		1996-2000	V8-5.7L	CHEVROLET TAHOE
	1995-1997	V8-5.2L	DODGE B3500		1996-2000	V8-5.7L	GMC C2500



USMW	Years	Cyl.	Specifications
	1996-2000	V8-5.7L	<b>GMC</b> C3500
	1996-2000	V8-5.7L	<b>GMC</b> K2500
	1996-2000	V8-5.7L	<b>GMC</b> K3500
	1996-2000	V8-5.7L	<b>GMC</b> YUKON
	1996-2002	V8-5.7L	<b>CHEVROLET</b> EXPRESS 1500
	1996-2002	V8-5.7L	<b>CHEVROLET</b> EXPRESS 2500
	1996-2002	V8-5.7L	<b>CHEVROLET</b> EXPRESS 3500
	1996-2002	V8-5.7L	<b>GMC</b> SAVANA 1500
	1996-2002	V8-5.7L	<b>GMC</b> SAVANA 2500
	1996-2002	V8-5.7L	<b>GMC</b> SAVANA 3500
	1999-2000	V8-5.7L	<b>CADILLAC</b> ESCALADE
<b>22163</b>	1991-1994	V8-4.9L	<b>FORD</b> COUGAR (MEX)
	1991-1993	V8-5.0L	<b>FORD</b> THUNDERBIRD
	1991-1993	V8-5.0L	<b>MERCURY</b> COUGAR
<b>22164</b>	2011	V6-3.7L	<b>DODGE</b> NITRO
	2011-2012	V6-3.7L	<b>JEEP</b> LIBERTY
	2011	V6-4.0L	<b>DODGE</b> NITRO
	2004-2008	V8-4.7L	<b>DODGE</b> DURANGO
	2007-2009	V8-4.7L	<b>CHRYSLER</b> ASPEN
	2004-2008	V8-5.7L	<b>DODGE</b> DURANGO
	2007-2008	V8-5.7L	<b>CHRYSLER</b> ASPEN
<b>22165</b>	1991-1992	V8-4.6L	<b>LINCOLN</b> TOWN CAR
	1992	V8-4.6L	<b>FORD</b> CROWN VICTORIA
	1992	V8-4.6L	<b>MERCURY</b> GRAND MARQUIS
<b>22166</b>	2006-2011	L4-2.3L	<b>FORD</b> RANGER
	1990	L6-4.0L	<b>FORD</b> EXPLORER (MEX)
	2001-2002	L6-4.2L	<b>FORD</b> ECONOLINE WAGON (MEX)
	1995-1997	V6-3.0L	<b>FORD</b> RANGER
	1990-2011	V6-4.0L	<b>FORD</b> RANGER
	1991-2006	V6-4.0L	<b>FORD</b> EXPLORER
	1993-1994	V6-4.0L	<b>MAZDA</b> NAVAJO
	1994-2009	V6-4.0L	<b>MAZDA</b> B4000
	1998-2006	V6-4.0L	<b>MERCURY</b> MOUNTAINEER
	2001-2005	V6-4.0L	<b>FORD</b> EXPLORER SPORT TRAC
	2006	V8-4.6L	<b>FORD</b> EXPLORER
	2006	V8-4.6L	<b>MERCURY</b> MOUNTAINEER
	1999	V8-5.4L	<b>FORD</b> F350 (MEX)
<b>22167</b>	1990-1997	V6-4.0L	<b>FORD</b> AEROSTAR
	1990-1997	V6-4.0L	<b>FORD</b> RANGER
	1991-1992	V6-4.0L	<b>MAZDA</b> NAVAJO
	1991-1994	V6-4.0L	<b>FORD</b> EXPLORER
	1994-1997	V6-4.0L	<b>MAZDA</b> B4000
<b>22168</b>	1999-2002	L6-4.2L	<b>FORD</b> ECONOLINE WAGON (MEX)
	2009	L6-4.2L	<b>FORD</b> F150 (MEX)
	2014	V10-6.8L	<b>FORD</b> E-350 SUPER DUTY
	2014	V10-6.8L	<b>FORD</b> E-450 SUPER DUTY
	2014	V10-6.8L	<b>FORD</b> F-450 SUPER DUTY
	2014	V10-6.8L	<b>FORD</b> F53
	2014	V10-6.8L	<b>FORD</b> F-550 SUPER DUTY
	1997-2002	V6-4.2L	<b>FORD</b> E-150 ECONOLINE
	1997-2002	V6-4.2L	<b>FORD</b> E-150 ECONOLINE CLUB WAGON
	1997-2002	V6-4.2L	<b>FORD</b> E-250 ECONOLINE
	2003	V6-4.2L	<b>FORD</b> E-150
	2003	V6-4.2L	<b>FORD</b> E-150 CLUB WAGON
	2003	V6-4.2L	<b>FORD</b> E-250
	1996	V8-4.6L	<b>FORD</b> EXPEDITION (MEX)
	1997	V8-4.6L	<b>FORD</b> E-250 ECONOLINE
	1997-1999	V8-4.6L	<b>FORD</b> F-250
	1997-2002	V8-4.6L	<b>FORD</b> E-150 ECONOLINE
	1997-2002	V8-4.6L	<b>FORD</b> E-150 ECONOLINE CLUB WAGON
	1997-2004	V8-4.6L	<b>FORD</b> EXPEDITION
	1997-2008	V8-4.6L	<b>FORD</b> F-150
	1998-2007	V8-4.6L	<b>FORD</b> LOBO 4WD (MEX)
	2000-2005	V8-4.6L	<b>FORD</b> LOBO 2WD (MEX)
	2000-2007	V8-4.6L	<b>FORD</b> F250 (MEX)
	2003-2005	V8-4.6L	<b>FORD</b> E-150 CLUB WAGON
	2003-2014	V8-4.6L	<b>FORD</b> E-150
	2003-2014	V8-4.6L	<b>FORD</b> E-250
	2004	V8-4.6L	<b>FORD</b> F-150 HERITAGE

USMW	Years	Cyl.	Specifications
	2002-2007	V8-4.7L	<b>DODGE</b> RAM 1500
	1997-1999	V8-5.4L	<b>FORD</b> ECONOLINE SUPER DUTY
	1997-1999	V8-5.4L	<b>FORD</b> F-250
	1997-2002	V8-5.4L	<b>FORD</b> E-150 ECONOLINE
	1997-2002	V8-5.4L	<b>FORD</b> E-150 ECONOLINE CLUB WAGON
	1997-2002	V8-5.4L	<b>FORD</b> E-250 ECONOLINE
	1997-2002	V8-5.4L	<b>FORD</b> E-350 ECONOLINE
	1997-2002	V8-5.4L	<b>FORD</b> E-350 ECONOLINE CLUB WAGON
	1997-2006	V8-5.4L	<b>FORD</b> EXPEDITION
	1997-2008	V8-5.4L	<b>FORD</b> F-150
	1998-2006	V8-5.4L	<b>LINCOLN</b> NAVIGATOR
	1999-2008	V8-5.4L	<b>FORD</b> LOBO 2WD (MEX)
	1999-2008	V8-5.4L	<b>FORD</b> LOBO 4WD (MEX)
	1999-2010	V8-5.4L	<b>FORD</b> F-250 SUPER DUTY
	1999-2010	V8-5.4L	<b>FORD</b> F-350 SUPER DUTY
	2000	V8-5.4L	<b>FORD</b> F350 (MEX)
	2000-2002	V8-5.4L	<b>FORD</b> E-450 ECONOLINE SUPER DUTY
	2000-2002	V8-5.4L	<b>FORD</b> E-450 ECONOLINE SUPER DUTY STRIPPED
	2002	V8-5.4L	<b>LINCOLN</b> BLACKWOOD
	2003	V8-5.4L	<b>FORD</b> E-350
	2003	V8-5.4L	<b>FORD</b> E-450 SUPER DUTY STRIPPED CHASSIS
	2003-2005	V8-5.4L	<b>FORD</b> E-150 CLUB WAGON
	2003-2005	V8-5.4L	<b>FORD</b> E-350 CLUB WAGON
	2003-2014	V8-5.4L	<b>FORD</b> E-150
	2003-2014	V8-5.4L	<b>FORD</b> E-250
	2003-2014	V8-5.4L	<b>FORD</b> E-450 SUPER DUTY
	2004	V8-5.4L	<b>FORD</b> F-150 HERITAGE
	2004-2005	V8-5.4L	<b>FORD</b> E-250 SUPER DUTY
	2004-2014	V8-5.4L	<b>FORD</b> E-350 SUPER DUTY
	2006-2008	V8-5.4L	<b>LINCOLN</b> MARK LT
<b>22169</b>	1992-2006	V8-4.6L	<b>FORD</b> CROWN VICTORIA
	1992-2006	V8-4.6L	<b>MERCURY</b> GRAND MARQUIS
	1993-2003	V8-4.6L	<b>LINCOLN</b> TOWN CAR
	1993-2004	V8-4.6L	<b>FORD</b> GRAND MARQUIS (MEX)
	2003-2004	V8-4.6L	<b>MERCURY</b> MARAUDER
	1991-1992	V8-5.0L	<b>FORD</b> GRAND MARQUIS (MEX)
<b>22170</b>	2005-2006	L4-2.8L	<b>JEEP</b> LIBERTY
	2010	L6-3.7L	<b>DODGE</b> DAKOTA SLT (MEX)
	2005-2010	V6-3.7L	<b>DODGE</b> DAKOTA
	2006-2009	V6-3.7L	<b>MITSUBISHI</b> RAIDER
	2011	V6-3.7L	<b>RAM</b> DAKOTA
	1992-1993	V6-3.9L	<b>DODGE</b> D150
	1992-1993	V6-3.9L	<b>DODGE</b> D250
	1992-1993	V6-3.9L	<b>DODGE</b> W150
	1992-2003	V6-3.9L	<b>DODGE</b> DAKOTA
	1995-2000	V8-4.0L	<b>LAND ROVER</b> RANGE ROVER
	1999-2002	V8-4.0L	<b>LAND ROVER</b> DISCOVERY
	1996-2002	V8-4.6L	<b>LAND ROVER</b> RANGE ROVER
	2001-2003	V8-4.7L	<b>DODGE</b> DURANGO
	2002-2010	V8-4.7L	<b>DODGE</b> DAKOTA
	2006-2007	V8-4.7L	<b>MITSUBISHI</b> RAIDER
	2011	V8-4.7L	<b>RAM</b> DAKOTA
	1992-1993	V8-5.2L	<b>DODGE</b> D150
	1992-1993	V8-5.2L	<b>DODGE</b> D250
	1992-1993	V8-5.2L	<b>DODGE</b> RAMCHARGER
	1992-1993	V8-5.2L	<b>DODGE</b> W150
	1992-1993	V8-5.2L	<b>DODGE</b> W250
	1992-1999	V8-5.2L	<b>DODGE</b> DAKOTA
	1993	V8-5.2L	<b>JEEP</b> GRAND CHEROKEE
	1993	V8-5.2L	<b>JEEP</b> GRAND WAGONEER
	1998-2000	V8-5.2L	<b>DODGE</b> DURANGO
	1993	V8-5.9L	<b>DODGE</b> D150
	1993	V8-5.9L	<b>DODGE</b> D250
	1993	V8-5.9L	<b>DODGE</b> D350
	1993	V8-5.9L	<b>DODGE</b> RAMCHARGER
	1993	V8-5.9L	<b>DODGE</b> W150
	1993	V8-5.9L	<b>DODGE</b> W250
	1993	V8-5.9L	<b>DODGE</b> W350
	1994-2001	V8-5.9L	<b>DODGE</b> RAM 1500



USMW	Years	Cyl.	Specifications
	1994-2001	V8-5.9L	<b>DODGE RAM 2500</b>
	1994-2001	V8-5.9L	<b>DODGE RAM 3500</b>
	1998-2003	V8-5.9L	<b>DODGE DAKOTA</b>
	1998-2003	V8-5.9L	<b>DODGE DURANGO</b>
<b>22171</b>	1997-2001	V6-3.9L	<b>DODGE DAKOTA</b>
	1998-1999	V6-3.9L	<b>DODGE DURANGO</b>
	2000	V8-4.7L	<b>DODGE DURANGO</b>
	2000-2001	V8-4.7L	<b>DODGE DAKOTA</b>
	2000	V8-5.2L	<b>DODGE DURANGO</b>
	2000	V8-5.9L	<b>DODGE DURANGO</b>
	2000-2001	V8-5.9L	<b>DODGE DAKOTA</b>
<b>22173</b>	2004-2006	L5-3.5L	<b>CHEVROLET COLORADO</b>
	2004-2006	L5-3.5L	<b>GMC CANYON</b>
	2006	L5-3.5L	<b>HUMMER H3</b>
	2006	L5-3.5L	<b>ISUZU I-350</b>
	2007-2008	L5-3.7L	<b>ISUZU I-370</b>
	2007-2010	L5-3.7L	<b>HUMMER H3</b>
	2007-2012	L5-3.7L	<b>CHEVROLET COLORADO</b>
	2007-2012	L5-3.7L	<b>GMC CANYON</b>
	2009-2010	L5-3.7L	<b>HUMMER H3T</b>
	1996-1999	V8-5.7L	<b>GMC P3500</b>
	1997-1999	V8-5.7L	<b>CHEVROLET P30</b>
<b>22174</b>	1992	L6-4.0L	<b>JEEP GRAND CHEROKEE (MEX)</b>
	1993-1998	L6-4.0L	<b>JEEP GRAND CHEROKEE</b>
<b>22175</b>	1989-1991	V6-2.8L	<b>ISUZU TROOPER</b>
	1991-1992	V6-3.1L	<b>ISUZU RODEO</b>
	1991-1994	V6-3.1L	<b>ISUZU PICKUP</b>
<b>22176</b>	1998-2000	V6-3.2L	<b>ISUZU AMIGO</b>
	1998-2002	V6-3.2L	<b>HONDA PASSPORT</b>
	1998-2004	V6-3.2L	<b>ISUZU RODEO</b>
	2001-2003	V6-3.2L	<b>ISUZU RODEO SPORT</b>
	1999-2001	V6-3.5L	<b>ISUZU VEHICROSS</b>
	2002-2004	V6-3.5L	<b>ISUZU AXIOM</b>
	2004	V6-3.5L	<b>ISUZU RODEO</b>
<b>22177</b>	2000-2002	V8-4.7L	<b>TOYOTA TUNDRA</b>
<b>22178</b>	1990-2000	V8-4.0L	<b>LEXUS LS400</b>
<b>22179</b>	1987	L4-2.5L	<b>CHEVROLET ASTRO</b>
	1987	L4-2.5L	<b>GMC SAFARI</b>
	1989-1990	L4-2.5L	<b>GMC S15</b>
	1989-1991	L4-2.5L	<b>CHEVROLET S10</b>
	1991	L4-2.5L	<b>GMC SONOMA</b>
	1987-1989	V6-2.8L	<b>CHEVROLET S10 BLAZER</b>
	1987-1989	V6-2.8L	<b>GMC S15 JIMMY</b>
	1987-1990	V6-2.8L	<b>GMC S15</b>
	1987-1991	V6-2.8L	<b>CHEVROLET S10</b>
	1991	V6-2.8L	<b>GMC SONOMA</b>
<b>22181</b>	2004-2010	V8-5.6L	<b>INFINITI QX56</b>
	2004-2012	V8-5.6L	<b>NISSAN PATHFINDER</b>
	2004-2013	V8-5.6L	<b>NISSAN TITAN</b>
	2005-2013	V8-5.6L	<b>NISSAN ARMADA</b>
	2012-2013	V8-5.6L	<b>NISSAN NV2500</b>
	2012-2013	V8-5.6L	<b>NISSAN NV3500</b>
<b>22182</b>	2005-2013	L4-2.5L	<b>NISSAN FRONTIER</b>
	2009-2012	L4-2.5L	<b>SUZUKI EQUATOR</b>
	2005-2012	V6-4.0L	<b>NISSAN PATHFINDER</b>
	2005-2013	V6-4.0L	<b>NISSAN FRONTIER</b>
	2005-2013	V6-4.0L	<b>NISSAN XTERRA</b>
	2009-2012	V6-4.0L	<b>SUZUKI EQUATOR</b>
	2012-2013	V6-4.0L	<b>NISSAN NV1500</b>
	2012-2013	V6-4.0L	<b>NISSAN NV2500</b>
	2012-2013	V6-4.0L	<b>NISSAN NV3500</b>
<b>22183</b>	1998-2005	V8-4.7L	<b>LEXUS LX470</b>
	1998-2005	V8-4.7L	<b>TOYOTA LAND CRUISER</b>
<b>22184</b>	2001-2004	V8-4.7L	<b>TOYOTA SEQUOIA</b>
	2003-2004	V8-4.7L	<b>TOYOTA TUNDRA</b>
	2003-2005	V8-4.7L	<b>LEXUS GX470</b>
	2003-2005	V8-4.7L	<b>TOYOTA 4RUNNER</b>
<b>22185</b>	2005-2007	V8-4.7L	<b>LEXUS LX470</b>
	2005-2007	V8-4.7L	<b>TOYOTA LAND CRUISER</b>

USMW	Years	Cyl.	Specifications
	2005-2009	V8-4.7L	<b>LEXUS GX470</b>
	2005-2009	V8-4.7L	<b>TOYOTA 4RUNNER</b>
	2005-2009	V8-4.7L	<b>TOYOTA SEQUOIA</b>
	2005-2009	V8-4.7L	<b>TOYOTA TUNDRA</b>
<b>22296</b>	1987-1993	L4-2.2L	<b>MAZDA B2200</b>
<b>22301</b>	1986-1989	L5-2.5L	<b>MERCEDES-BENZ 190D</b>
	1990-1993	L5-2.5L	<b>MERCEDES-BENZ 300D</b>
	1986-1987	L6-3.0L	<b>MERCEDES-BENZ 300SDL</b>
	1987	L6-3.0L	<b>MERCEDES-BENZ 300D</b>
	1987	L6-3.0L	<b>MERCEDES-BENZ 300TD</b>
	1990-1991	L6-3.4L	<b>MERCEDES-BENZ 350SDL</b>
	1991	L6-3.4L	<b>MERCEDES-BENZ 350SD</b>
	1992-1993	L6-3.4L	<b>MERCEDES-BENZ 300SD</b>
	1994-1995	L6-3.4L	<b>MERCEDES-BENZ S350</b>
<b>22302</b>	1997-2001	L4-1.8L	<b>AUDI A4</b>
	1997-2001	L4-1.8L	<b>AUDI A4 QUATTRO</b>
	1998-2005	L4-1.8L	<b>VOLKSWAGEN PASSAT</b>
	2007-2009	L4-1.8L	<b>AUDI A4 (MEX)</b>
	2004-2005	L4-2.0L	<b>VOLKSWAGEN PASSAT</b>
<b>22303</b>	2000-2002	V6-2.7L	<b>AUDI S4</b>
	2000-2004	V6-2.7L	<b>AUDI A6 QUATTRO</b>
	2001-2005	V6-2.7L	<b>AUDI ALLROAD QUATTRO</b>
	1996-2001	V6-2.8L	<b>AUDI A4</b>
	1996-2001	V6-2.8L	<b>AUDI A4 QUATTRO</b>
	1998-2001	V6-2.8L	<b>AUDI A6</b>
	1998-2001	V6-2.8L	<b>AUDI A6 QUATTRO</b>
	1998-2005	V6-2.8L	<b>VOLKSWAGEN PASSAT</b>
<b>22305</b>	1993	V8-3.9L	<b>LAND ROVER DEFENDER 110</b>
	1994-1995	V8-3.9L	<b>LAND ROVER DEFENDER 90</b>
<b>22306</b>	1995-1997	L6-3.0L	<b>MERCEDES-BENZ E300</b>
<b>22307</b>	1990	L5-2.5L	<b>MERCEDES-BENZ 190DT (MEX)</b>
	1987-1989	L6-2.6L	<b>MERCEDES-BENZ 260E</b>
	1987-1989	L6-2.6L	<b>MERCEDES-BENZ 260SE (MEX)</b>
	1990-1992	L6-2.6L	<b>MERCEDES-BENZ 300E</b>
	1992	L6-2.6L	<b>MERCEDES-BENZ 260E (MEX)</b>
	1993	L6-2.8L	<b>MERCEDES-BENZ 300E</b>
	1994-1997	L6-2.8L	<b>MERCEDES-BENZ C280</b>
	1986	L6-3.0L	<b>MERCEDES-BENZ 300SL (MEX)</b>
	1986-1987	L6-3.0L	<b>MERCEDES-BENZ 300TE (MEX)</b>
	1986-1993	L6-3.0L	<b>MERCEDES-BENZ 300E</b>
	1988-1991	L6-3.0L	<b>MERCEDES-BENZ 300SE</b>
	1988-1991	L6-3.0L	<b>MERCEDES-BENZ 300SEL</b>
	1988-1992	L6-3.0L	<b>MERCEDES-BENZ 300CE</b>
	1988-1993	L6-3.0L	<b>MERCEDES-BENZ 300TE</b>
	1989	L6-3.0L	<b>MERCEDES-BENZ 300D (MEX)</b>
	1993	L6-3.2L	<b>MERCEDES-BENZ 300CE</b>
	1993	L6-3.2L	<b>MERCEDES-BENZ 300E</b>
	1993	L6-3.2L	<b>MERCEDES-BENZ 300TE</b>
	1994-1995	L6-3.2L	<b>MERCEDES-BENZ E320</b>
	1995-1997	L6-3.6L	<b>MERCEDES-BENZ C36 AMG</b>
<b>22308</b>	1994-1996	L4-2.2L	<b>MERCEDES-BENZ C220</b>
	1996-1997	L4-2.3L	<b>MERCEDES-BENZ SLK (MEX)</b>
	1997-2000	L4-2.3L	<b>MERCEDES-BENZ C230</b>
	1973-1976	V8-7.5L	<b>MERCURY COUGAR</b>
<b>22310</b>	2002-2004	L6-4.2L	<b>OLDSMOBILE BRAVADA</b>
	2002-2006	L6-4.2L	<b>CHEVROLET TRAILBLAZER</b>
	2002-2006	L6-4.2L	<b>CHEVROLET TRAILBLAZER EXT</b>
	2002-2006	L6-4.2L	<b>GMC ENVOY</b>
	2002-2006	L6-4.2L	<b>GMC ENVOY XL</b>
	2004-2005	L6-4.2L	<b>GMC ENVOY XUV</b>
	2004-2006	L6-4.2L	<b>BUICK RAINIER</b>
	2004-2006	L6-4.2L	<b>ISUZU ASCENDER</b>
	2005-2006	L6-4.2L	<b>SAAB 9-7X</b>
	2003-2004	V8-5.3L	<b>CHEVROLET SSR</b>
	2003-2006	V8-5.3L	<b>CHEVROLET TRAILBLAZER EXT</b>
	2003-2006	V8-5.3L	<b>GMC ENVOY XL</b>
	2004-2005	V8-5.3L	<b>GMC ENVOY XUV</b>
	2004-2006	V8-5.3L	<b>BUICK RAINIER</b>
	2004-2006	V8-5.3L	<b>ISUZU ASCENDER</b>

**FAN CLUTCHES**

USMW	Years	Cyl.	Specifications
	2005-2006	V8-5.3L	GMC ENVOY
	2005-2006	V8-5.3L	SAAB 9-7X
	2006	V8-5.3L	CHEVROLET TRAILBLAZER
	2005-2006	V8-6.0L	CHEVROLET SSR
	2006	V8-6.0L	CHEVROLET TRAILBLAZER
<b>22311</b>	1992-1994	L5-2.2L	AUDI S4
	1995	L5-2.2L	AUDI S6
	1990-1991	V8-3.6L	AUDI V8 QUATTRO
	1992-1994	V8-4.2L	AUDI V8 QUATTRO
<b>22313</b>	1992-1993	V8-4.2L	MERCEDES-BENZ 400E
	1994-1995	V8-4.2L	MERCEDES-BENZ E420
	1992-1993	V8-5.0L	MERCEDES-BENZ 500E
	1994	V8-5.0L	MERCEDES-BENZ E500
<b>22314</b>	1957	L6-3.0L	MERCEDES-BENZ 300C
	1957	L6-3.0L	MERCEDES-BENZ 300SC
	1961-1966	L6-3.0L	MERCEDES-BENZ 300
<b>22316</b>	1997-1999	V8-3.7L	AUDI A8
	1996	V8-4.2L	AUDI A8 (MEX)
	1997-2003	V8-4.2L	AUDI A8 QUATTRO
	2000-2004	V8-4.2L	AUDI A6 QUATTRO
	2001-2003	V8-4.2L	AUDI S8
	2001-2004	V8-4.2L	AUDI S6 QUATTRO (MEX)
	2002-2003	V8-4.2L	AUDI S6
<b>22319</b>	1980-1985	L5-3.0L	MERCEDES-BENZ 300CD
	1980-1985	L5-3.0L	MERCEDES-BENZ 300D
	1980-1985	L5-3.0L	MERCEDES-BENZ 300SD
	1981-1985	L5-3.0L	MERCEDES-BENZ 300TD
	1980	L6-2.8L	MERCEDES-BENZ 280SE
	1980-1981	L6-2.8L	MERCEDES-BENZ 280CE
	1980-1981	L6-2.8L	MERCEDES-BENZ 280E
<b>22320</b>	1987-1993	L6-2.6L	MERCEDES-BENZ 190E
	1981	V8-3.8L	MERCEDES-BENZ 380SLC
	1981-1983	V8-3.8L	MERCEDES-BENZ 380SEL
	1981-1985	V8-3.8L	MERCEDES-BENZ 380SL
	1982-1983	V8-3.8L	MERCEDES-BENZ 380SEC
	1984-1985	V8-3.8L	MERCEDES-BENZ 380SE
	1986	V8-4.2L	MERCEDES-BENZ 420SE (MEX)
	1986	V8-4.2L	MERCEDES-BENZ 420SL (MEX)
	1986-1991	V8-4.2L	MERCEDES-BENZ 420SEL
	1984-1985	V8-5.0L	MERCEDES-BENZ 500SEC
	1984-1985	V8-5.0L	MERCEDES-BENZ 500SEL
	1986	V8-5.0L	MERCEDES-BENZ 500SE (MEX)
	1986	V8-5.0L	MERCEDES-BENZ 500SL (MEX)
	1986	V8-5.6L	MERCEDES-BENZ 560SE (MEX)
	1986-1989	V8-5.6L	MERCEDES-BENZ 560SL
	1986-1991	V8-5.6L	MERCEDES-BENZ 560SEC
	1986-1991	V8-5.6L	MERCEDES-BENZ 560SEL
	1994-1996	V8-5.6L	MERCEDES-BENZ 560SEL (MEX)
<b>22321</b>	1998-2002	V8-4.3L	MERCEDES-BENZ E430
	1999-2001	V8-4.3L	MERCEDES-BENZ ML430
	1999-2002	V8-5.0L	MERCEDES-BENZ SL500
	2000-2003	V8-5.5L	MERCEDES-BENZ ML55 AMG
<b>22322</b>	1990-1993	L6-3.0L	MERCEDES-BENZ 300SL
	1992-1993	L6-3.2L	MERCEDES-BENZ 300SE
	1994-1997	L6-3.2L	MERCEDES-BENZ SL320
	1994-1999	L6-3.2L	MERCEDES-BENZ S320
	1996-1997	L6-3.2L	MERCEDES-BENZ E320
<b>22323</b>	1991-1997	V12-6.0L	MERCEDES-BENZ 600SEL (MEX)
	1992-1993	V12-6.0L	MERCEDES-BENZ 600SEL
	1993	V12-6.0L	MERCEDES-BENZ 600SEC
	1993	V12-6.0L	MERCEDES-BENZ 600SL
	1994-1997	V12-6.0L	MERCEDES-BENZ 600SEC (MEX)
	1994-1999	V12-6.0L	MERCEDES-BENZ S600
	1994-2002	V12-6.0L	MERCEDES-BENZ SL600
	1996-1997	V12-6.0L	MERCEDES-BENZ 600CL (MEX)
	1998-1999	V12-6.0L	MERCEDES-BENZ CL600
<b>22324</b>	1998-2000	V6-2.8L	MERCEDES-BENZ C280
	1998-2003	V6-3.2L	MERCEDES-BENZ E320
	1998-2000	V8-4.3L	MERCEDES-BENZ C43 AMG

USMW	Years	Cyl.	Specifications
	1999-2003	V8-4.3L	MERCEDES-BENZ CLK430
	2001-2002	V8-5.5L	MERCEDES-BENZ CLK55 AMG
<b>22325</b>	1998-2003	V6-3.2L	MERCEDES-BENZ ML320
	2003-2005	V6-3.7L	MERCEDES-BENZ ML350
<b>22326</b>	2003	V8-4.8L	BMW Z8
	1999	V8-4.9L	BMW M5 (MEX)
	2000-2003	V8-5.0L	BMW M5
	2000-2003	V8-5.0L	BMW Z8
<b>22327</b>	1998-1999	L6-3.0L	MERCEDES-BENZ E300
<b>22328</b>	2003-2006	L5-2.7L	DODGE SPRINTER 2500
	2003-2006	L5-2.7L	DODGE SPRINTER 3500
	2004-2006	L5-2.7L	MERCEDES-BENZ SPRINTER (MEX)
<b>22329</b>	2008-2010	V8-6.4L	FORD F-250 SUPER DUTY
	2008-2010	V8-6.4L	FORD F-350 SUPER DUTY
	2008-2010	V8-6.4L	FORD F-450 SUPER DUTY
	2008-2010	V8-6.4L	FORD F-550 SUPER DUTY
<b>22330</b>	2003-2008	L6-4.2L	ISUZU ASCENDER
	2007	L6-4.2L	BUICK RAINIER
	2007-2009	L6-4.2L	CHEVROLET TRAILBLAZER
	2007-2009	L6-4.2L	GMC ENVOY
	2007-2009	L6-4.2L	SAAB 9-7X
	2003	V8-5.3L	ISUZU ASCENDER
	2007	V8-5.3L	BUICK RAINIER
	2007-2008	V8-5.3L	CHEVROLET TRAILBLAZER
	2007-2009	V8-5.3L	GMC ENVOY
	2007-2009	V8-5.3L	SAAB 9-7X
	2007-2009	V8-6.0L	CHEVROLET TRAILBLAZER
	2008-2009	V8-6.0L	SAAB 9-7X
<b>22331</b>	2003-2009	L6-5.9L	DODGE RAM 2500
	2003-2009	L6-5.9L	DODGE RAM 3500
	2007-2009	L6-6.7L	DODGE RAM 2500
	2007-2010	L6-6.7L	DODGE RAM 3500
	2008-2010	L6-6.7L	DODGE RAM 4500
	2008-2010	L6-6.7L	DODGE RAM 5500
<b>22332</b>	2003-2005	V8-6.0L	FORD EXCURSION
	2003-2007	V8-6.0L	FORD F-250 SUPER DUTY
	2003-2007	V8-6.0L	FORD F-350 SUPER DUTY
	2003-2007	V8-6.0L	FORD F-450 SUPER DUTY
	2003-2007	V8-6.0L	FORD F-550 SUPER DUTY
	2004-2005	V8-6.0L	FORD E-350 CLUB WAGON
	2004-2010	V8-6.0L	FORD E-350 SUPER DUTY
	2004-2010	V8-6.0L	FORD E-450 SUPER DUTY
	2008-2010	V8-6.4L	FORD F-250 SUPER DUTY
	2008-2010	V8-6.4L	FORD F-350 SUPER DUTY
	2008-2010	V8-6.4L	FORD F-450 SUPER DUTY
	2008-2010	V8-6.4L	FORD F-550 SUPER DUTY
<b>22333</b>	2007-2009	V6-3.0L	DODGE SPRINTER 2500
	2007-2009	V6-3.0L	DODGE SPRINTER 3500
<b>22334</b>	2009-2010	V8-4.6L	FORD F-150
	2009	V8-5.4L	FORD EXPEDITION
	2009	V8-5.4L	LINCOLN NAVIGATOR
	2009-2010	V8-5.4L	FORD F-150
<b>22335</b>	1992	V8-4.2L	MERCEDES-BENZ 400SE
	1993	V8-4.2L	MERCEDES-BENZ 400SEL
	1994-1999	V8-4.2L	MERCEDES-BENZ S420
	1990-1993	V8-5.0L	MERCEDES-BENZ 500SL
	1992-1993	V8-5.0L	MERCEDES-BENZ 500SEL
	1993	V8-5.0L	MERCEDES-BENZ 500SEC
	1994-1998	V8-5.0L	MERCEDES-BENZ SL500
	1994-1999	V8-5.0L	MERCEDES-BENZ S500
	1998-1999	V8-5.0L	MERCEDES-BENZ CL500
<b>22337</b>	2007-2010	V6-4.0L	FORD EXPLORER
	2007-2010	V6-4.0L	FORD EXPLORER SPORT TRAC
	2007-2010	V6-4.0L	MERCURY MOUNTAINEER
	2007-2010	V8-4.6L	FORD EXPLORER
	2007-2010	V8-4.6L	FORD EXPLORER SPORT TRAC
	2007-2010	V8-4.6L	MERCURY MOUNTAINEER
<b>22338</b>	2007-2008	V8-4.6L	FORD F-150
	2007-2008	V8-5.4L	FORD EXPEDITION

USMW	Years	Cyl.	Specifications
	2007-2008	V8-5.4L	FORD F-150
	2007-2008	V8-5.4L	LINCOLN MARK LT
	2007-2008	V8-5.4L	LINCOLN NAVIGATOR
<b>22339</b>	2011-2014	V8-6.2L	FORD F-250 SUPER DUTY
	2011-2014	V8-6.2L	FORD F-350 SUPER DUTY
<b>22340</b>	2011-2014	V8-6.7L	FORD F-250 SUPER DUTY
	2011-2014	V8-6.7L	FORD F-350 SUPER DUTY
	2011-2014	V8-6.7L	FORD F-450 SUPER DUTY
	2011-2014	V8-6.7L	FORD F-550 SUPER DUTY
<b>22341</b>	2009-2012	V8-6.6L	CHEVROLET EXPRESS 2500
	2009-2012	V8-6.6L	CHEVROLET EXPRESS 3500
	2009-2012	V8-6.6L	CHEVROLET EXPRESS 4500
	2009-2012	V8-6.6L	GMC SAVANA 2500
	2009-2012	V8-6.6L	GMC SAVANA 3500
	2009-2012	V8-6.6L	GMC SAVANA 4500
<b>22342</b>	2011-2012	V8-6.6L	CHEVROLET SILVERADO 2500 HD
	2011-2012	V8-6.6L	CHEVROLET SILVERADO 3500 HD
	2011-2012	V8-6.6L	GMC SIERRA 2500 HD
	2011-2012	V8-6.6L	GMC SIERRA 3500 HD
<b>22373</b>	1995-2002	L4-2.0L	KIA SPORTAGE
<b>22396</b>	1988-1991	V6-3.0L	MAZDA 929
<b>22399</b>	2003-2008	V12-6.0L	BMW 760LI
	2004-2006	V12-6.0L	BMW 760I
	2000-2003	V8-4.4L	BMW X5
	2002-2003	V8-4.4L	BMW 745I
	2002-2003	V8-4.4L	BMW 745LI
	2003-2005	V8-4.4L	LAND ROVER RANGE ROVER
	2002-2003	V8-4.6L	BMW X5
<b>22401</b>	1993-1995	L4-2.4L	TOYOTA PICKUP
<b>22402</b>	1992-2000	L6-3.0L	LEXUS SC300
	1993-1997	L6-3.0L	LEXUS GS300
	1993-1998	L6-3.0L	TOYOTA SUPRA
<b>22404</b>	1985	L4-2.4L	TOYOTA PICKUP
<b>22405</b>	1985-1989	H4-1.8L	SUBARU DL
	1985-1989	H4-1.8L	SUBARU GL
	1985-1989	H4-1.8L	SUBARU GL-10
	1986-1989	H4-1.8L	SUBARU RX
	1986-1991	H4-1.8L	SUBARU XT
	1987	H4-1.8L	SUBARU STANDARD
	1990-1994	H4-1.8L	SUBARU LOYALE
	1988	H6-2.7L	SUBARU XT
<b>22406</b>	1985-1987	H4-1.8L	SUBARU XT
	1990-1992	L4-1.6L	DAIHATSU ROCKY
<b>22407</b>	2003-2013	V6-4.0L	TOYOTA 4RUNNER
	2005-2013	V6-4.0L	TOYOTA TACOMA
	2005-2013	V6-4.0L	TOYOTA TUNDRA
	2007-2013	V6-4.0L	TOYOTA FJ CRUISER
<b>22408</b>	2010-2012	V8-4.6L	TOYOTA SEQUOIA
	2010-2013	V8-4.6L	LEXUS GX460
	2010-2013	V8-4.6L	TOYOTA TUNDRA
	2007-2013	V8-5.7L	TOYOTA TUNDRA
	2008-2013	V8-5.7L	LEXUS LX570
	2008-2013	V8-5.7L	TOYOTA LAND CRUISER
	2008-2013	V8-5.7L	TOYOTA SEQUOIA
<b>22409</b>	2001-2002	V6-3.5L	MITSUBISHI MONTERO
	2003	V6-3.8L	MITSUBISHI MONTERO
<b>22410</b>	2003-2006	V6-3.8L	MITSUBISHI MONTERO
<b>22496</b>	1992-1995	V6-3.0L	MAZDA 929
	1996-1998	V6-3.0L	MAZDA MPV
<b>22601</b>	1983-1987	V8-6.9L	FORD E-250 ECONOLINE CLUB WAGON
	1983-1987	V8-6.9L	FORD E-350 ECONOLINE
	1983-1987	V8-6.9L	FORD E-350 ECONOLINE CLUB WAGON
	1983-1987	V8-6.9L	FORD F-250
	1983-1987	V8-6.9L	FORD F-350
	1988-1991	V8-7.3L	FORD E-250 ECONOLINE CLUB WAGON
	1988-1992	V8-7.3L	FORD E-350 ECONOLINE
	1988-1992	V8-7.3L	FORD E-350 ECONOLINE CLUB WAGON
	1988-1992	V8-7.3L	FORD F-250
	1988-1992	V8-7.3L	FORD F-350

USMW	Years	Cyl.	Specifications
	1988-1992	V8-7.3L	FORD F59
	1990-1992	V8-7.3L	FORD F SUPER DUTY
<b>22602</b>	1982	V8-6.2L	CHEVROLET C10
	1982	V8-6.2L	CHEVROLET C10 SUBURBAN
	1982	V8-6.2L	CHEVROLET C20
	1982	V8-6.2L	CHEVROLET C20 SUBURBAN
	1982	V8-6.2L	CHEVROLET C30
	1982	V8-6.2L	CHEVROLET K10
	1982	V8-6.2L	CHEVROLET K10 SUBURBAN
	1982	V8-6.2L	CHEVROLET K20
	1982	V8-6.2L	CHEVROLET K20 SUBURBAN
	1982	V8-6.2L	CHEVROLET K30
	1982	V8-6.2L	CHEVROLET K5 BLAZER
	1982	V8-6.2L	GMC C1500
	1982	V8-6.2L	GMC C1500 SUBURBAN
	1982	V8-6.2L	GMC C2500
	1982	V8-6.2L	GMC C2500 SUBURBAN
	1982	V8-6.2L	GMC C3500
	1982	V8-6.2L	GMC JIMMY
	1982	V8-6.2L	GMC K1500
	1982	V8-6.2L	GMC K1500 SUBURBAN
	1982	V8-6.2L	GMC K2500
	1982	V8-6.2L	GMC K2500 SUBURBAN
	1982	V8-6.2L	GMC K3500
<b>22605</b>	1994	V8-6.5L	CHEVROLET BLAZER
	1994-1996	V8-6.5L	AM GENERAL HUMMER
	1994-1996	V8-6.5L	CHEVROLET C1500
	1994-1996	V8-6.5L	CHEVROLET C2500
	1994-1996	V8-6.5L	CHEVROLET C2500 SUBURBAN
	1994-1996	V8-6.5L	CHEVROLET C3500
	1994-1996	V8-6.5L	CHEVROLET K1500
	1994-1996	V8-6.5L	CHEVROLET K2500
	1994-1996	V8-6.5L	CHEVROLET K2500 SUBURBAN
	1994-1996	V8-6.5L	CHEVROLET K3500
	1994-1996	V8-6.5L	GMC C1500
	1994-1996	V8-6.5L	GMC C2500
	1994-1996	V8-6.5L	GMC C2500 SUBURBAN
	1994-1996	V8-6.5L	GMC C3500
	1994-1996	V8-6.5L	GMC K1500
	1994-1996	V8-6.5L	GMC K2500
	1994-1996	V8-6.5L	GMC K2500 SUBURBAN
	1994-1996	V8-6.5L	GMC K3500
	1994-1996	V8-6.5L	GMC YUKON
	1995-1996	V8-6.5L	CHEVROLET C1500 SUBURBAN
	1995-1996	V8-6.5L	CHEVROLET K1500 SUBURBAN
	1995-1996	V8-6.5L	CHEVROLET TAHOE
	1995-1996	V8-6.5L	GMC C1500 SUBURBAN
	1995-1996	V8-6.5L	GMC K1500 SUBURBAN
	1996	V8-6.5L	CHEVROLET EXPRESS 2500
	1996	V8-6.5L	CHEVROLET EXPRESS 3500
	1996	V8-6.5L	GMC SAVANA 2500
	1996	V8-6.5L	GMC SAVANA 3500
<b>22606</b>	1992-1993	V8-6.5L	CHEVROLET C2500
	1992-1993	V8-6.5L	CHEVROLET C3500
	1992-1993	V8-6.5L	CHEVROLET K2500
	1992-1993	V8-6.5L	CHEVROLET K3500
	1992-1993	V8-6.5L	GMC C2500
	1992-1993	V8-6.5L	GMC C3500
	1992-1993	V8-6.5L	GMC K2500
	1992-1993	V8-6.5L	GMC K3500
<b>22607</b>	1992	V8-7.3L	FORD E-350 ECONOLINE
	1992	V8-7.3L	FORD E-350 ECONOLINE CLUB WAGON
	1992-1994	V8-7.3L	FORD F SUPER DUTY
	1992-1994	V8-7.3L	FORD F-250
	1992-1994	V8-7.3L	FORD F-350
	1992-1994	V8-7.3L	FORD F59
<b>22609</b>	1996	V8-5.8L	FORD ECONOLINE SUPER DUTY
	1993-1997	V8-7.3L	FORD E-350 ECONOLINE
	1993-1997	V8-7.3L	FORD E-350 ECONOLINE CLUB WAGON



USMW	Years	Cyl.	Specifications
	1994	V8-7.3L	FORD F59
	1994-1997	V8-7.3L	FORD F-250
	1994-1997	V8-7.3L	FORD F-350
	1995-1997	V8-7.3L	FORD F SUPER DUTY
	1996-1997	V8-7.3L	FORD ECONOLINE SUPER DUTY
<b>22610</b>	1997-1999	V10-6.8L	FORD ECONOLINE SUPER DUTY
	1997-2002	V10-6.8L	FORD E-350 ECONOLINE
	1997-2002	V10-6.8L	FORD E-350 ECONOLINE CLUB WAGON
	1999-2010	V10-6.8L	FORD F-250 SUPER DUTY
	1999-2010	V10-6.8L	FORD F-350 SUPER DUTY
	1999-2014	V10-6.8L	FORD F-450 SUPER DUTY
	1999-2014	V10-6.8L	FORD F-550 SUPER DUTY
	2000-2002	V10-6.8L	FORD E-450 ECONOLINE SUPER DUTY
	2000-2002	V10-6.8L	FORD E-450 ECONOLINE SUPER DUTY STRIPPED
	2000-2005	V10-6.8L	FORD EXCURSION
	2002	V10-6.8L	FORD E-550 ECONOLINE SUPER DUTY
	2003	V10-6.8L	FORD E-350
	2003	V10-6.8L	FORD E-450 SUPER DUTY STRIPPED CHASSIS
	2003	V10-6.8L	FORD E-550 SUPER DUTY
	2003-2005	V10-6.8L	FORD E-350 CLUB WAGON
	2003-2014	V10-6.8L	FORD E-450 SUPER DUTY
	2004-2014	V10-6.8L	FORD E-350 SUPER DUTY
	2009-2013	V10-6.8L	FORD F53
	1999-2000	V8-5.4L	FORD F-150
	2005-2007	V8-5.4L	FORD F-250 SUPER DUTY
	2005-2007	V8-5.4L	FORD F-350 SUPER DUTY
<b>22611</b>	1999-2003	V8-7.3L	FORD F-250 SUPER DUTY
	1999-2003	V8-7.3L	FORD F-350 SUPER DUTY
	1999-2003	V8-7.3L	FORD F-450 SUPER DUTY
	1999-2003	V8-7.3L	FORD F-550 SUPER DUTY
	2000-2003	V8-7.3L	FORD EXCURSION
<b>22612</b>	1998-1999	V8-7.3L	FORD ECONOLINE SUPER DUTY
	1998-2002	V8-7.3L	FORD E-350 ECONOLINE
	1998-2002	V8-7.3L	FORD E-350 ECONOLINE CLUB WAGON
	2000-2002	V8-7.3L	FORD E-450 ECONOLINE SUPER DUTY
	2000-2002	V8-7.3L	FORD E-450 ECONOLINE SUPER DUTY STRIPPED
	2002	V8-7.3L	FORD E-550 ECONOLINE SUPER DUTY
	2003	V8-7.3L	FORD E-350
	2003	V8-7.3L	FORD E-350 CLUB WAGON
	2003	V8-7.3L	FORD E-450 SUPER DUTY
	2003	V8-7.3L	FORD E-450 SUPER DUTY STRIPPED CHASSIS
	2003	V8-7.3L	FORD E-550 SUPER DUTY
<b>22613</b>	1994-1999	V8-6.5L	CHEVROLET P30
	1997	V8-6.5L	GMC C1500
	1997	V8-6.5L	GMC YUKON
	1997-1998	V8-6.5L	AM GENERAL HUMMER
	1997-1998	V8-6.5L	CHEVROLET C1500
	1997-1998	V8-6.5L	CHEVROLET EXPRESS 2500
	1997-1998	V8-6.5L	CHEVROLET EXPRESS 3500
	1997-1998	V8-6.5L	CHEVROLET K1500
	1997-1998	V8-6.5L	GMC K1500
	1997-1998	V8-6.5L	GMC SAVANA 2500
	1997-1998	V8-6.5L	GMC SAVANA 3500
	1997-1999	V8-6.5L	CHEVROLET C1500 SUBURBAN
	1997-1999	V8-6.5L	CHEVROLET C2500
	1997-1999	V8-6.5L	CHEVROLET C2500 SUBURBAN
	1997-1999	V8-6.5L	CHEVROLET C3500
	1997-1999	V8-6.5L	CHEVROLET K1500 SUBURBAN
	1997-1999	V8-6.5L	CHEVROLET K2500
	1997-1999	V8-6.5L	CHEVROLET K2500 SUBURBAN
	1997-1999	V8-6.5L	CHEVROLET K3500
	1997-1999	V8-6.5L	CHEVROLET TAHOE
	1997-1999	V8-6.5L	GMC C1500 SUBURBAN
	1997-1999	V8-6.5L	GMC C2500
	1997-1999	V8-6.5L	GMC C2500 SUBURBAN
	1997-1999	V8-6.5L	GMC C3500
	1997-1999	V8-6.5L	GMC K1500 SUBURBAN
	1997-1999	V8-6.5L	GMC K2500
	1997-1999	V8-6.5L	GMC K2500 SUBURBAN

USMW	Years	Cyl.	Specifications
	1997-1999	V8-6.5L	GMC K3500
	1997-1999	V8-6.5L	GMC P3500
<b>22614</b>	1999	V8-6.5L	CHEVROLET C1500 SUBURBAN
	1999	V8-6.5L	CHEVROLET C2500 SUBURBAN
	1999	V8-6.5L	CHEVROLET K1500 SUBURBAN
	1999	V8-6.5L	CHEVROLET K2500 SUBURBAN
	1999	V8-6.5L	GMC C1500 SUBURBAN
	1999	V8-6.5L	GMC C2500 SUBURBAN
	1999	V8-6.5L	GMC K1500 SUBURBAN
	1999	V8-6.5L	GMC K2500 SUBURBAN
	1999-2000	V8-6.5L	CHEVROLET C2500
	1999-2000	V8-6.5L	CHEVROLET C3500
	1999-2000	V8-6.5L	CHEVROLET K2500
	1999-2000	V8-6.5L	CHEVROLET K3500
	1999-2000	V8-6.5L	GMC C2500
	1999-2000	V8-6.5L	GMC C3500
	1999-2000	V8-6.5L	GMC K2500
	1999-2000	V8-6.5L	GMC K3500
	1999-2002	V8-6.5L	CHEVROLET EXPRESS 2500
	1999-2002	V8-6.5L	CHEVROLET EXPRESS 3500
	1999-2002	V8-6.5L	GMC SAVANA 2500
	1999-2002	V8-6.5L	GMC SAVANA 3500
<b>22615</b>	1996-2001	V8-5.0L	FORD EXPLORER
	1997-2001	V8-5.0L	MERCURY MOUNTAINEER
	2008-2010	V8-5.3L	HUMMER H3
	2009-2010	V8-5.3L	HUMMER H3T
	2009-2012	V8-5.3L	CHEVROLET COLORADO
	2009-2012	V8-5.3L	GMC CANYON
<b>22616</b>	2000-2002	L6-5.9L	DODGE RAM 2500
	2000-2002	L6-5.9L	DODGE RAM 3500
<b>22617</b>	2001-2005	V8-6.6L	CHEVROLET SILVERADO 2500 HD
	2001-2005	V8-6.6L	CHEVROLET SILVERADO 3500
	2001-2005	V8-6.6L	GMC SIERRA 2500 HD
	2001-2005	V8-6.6L	GMC SIERRA 3500
	2006-2008	V8-6.6L	CHEVROLET EXPRESS 2500
	2006-2008	V8-6.6L	CHEVROLET EXPRESS 3500
	2006-2009	V8-6.6L	GMC SAVANA 2500
	2006-2009	V8-6.6L	GMC SAVANA 3500
<b>22618</b>	1998-2001	V8-6.5L	AM GENERAL HUMMER
	2002-2004	V8-6.5L	HUMMER H1
<b>22620</b>	1997-2009	V8-4.6L	FORD LOBO 2WD (MEX)
	2002-2009	V8-4.6L	FORD F250 (MEX)
	2002-2009	V8-4.6L	FORD LOBO 4WD (MEX)
	2001-2009	V8-5.4L	FORD LOBO 4WD (MEX)
	2003-2009	V8-5.4L	FORD LOBO 2WD (MEX)
	2003-2008	V8-5.7L	DODGE RAM 1500
	2003-2008	V8-5.7L	DODGE RAM 2500
	2003-2008	V8-5.7L	DODGE RAM 3500
<b>22621</b>	2002-2008	V6-3.7L	DODGE RAM 1500
	2002-2008	V8-4.7L	DODGE RAM 1500
	2005-2008	V8-5.7L	DODGE RAM 1500
	2002-2003	V8-5.9L	DODGE RAM 1500
<b>22625</b>	2006-2007	V8-6.6L	CHEVROLET SILVERADO 3500
	2006-2007	V8-6.6L	GMC SIERRA 3500
	2006-2010	V8-6.6L	CHEVROLET SILVERADO 2500 HD
	2006-2010	V8-6.6L	GMC SIERRA 2500 HD
	2007-2010	V8-6.6L	CHEVROLET SILVERADO 3500 HD
	2007-2010	V8-6.6L	GMC SIERRA 3500 HD
<b>22626</b>	2007-2009	V6-3.8L	JEEP WRANGLER
<b>22627</b>	2008-2009	L6-4.2L	CHEVROLET TRAILBLAZER
	2008-2009	L6-4.2L	GMC ENVOY
	2008-2009	L6-4.2L	SAAB 9-7X
	2007-2008	V8-5.3L	CHEVROLET TRAILBLAZER
	2008-2009	V8-5.3L	GMC ENVOY
	2008-2009	V8-5.3L	SAAB 9-7X
	2008-2009	V8-6.0L	SAAB 9-7X
<b>22628</b>	2004	V8-4.6L	CADILLAC SRX
<b>22063EX</b>	1992-1995	V8-3.9L	LAND ROVER RANGE ROVER
	1994-1995	V8-3.9L	LAND ROVER DISCOVERY



USMW	Years	Cyl.	Specifications	USMW	Years	Cyl.	Specifications
1996-1999	V8-4.0L	LAND ROVER DISCOVERY					
1997	V8-4.0L	LAND ROVER DEFENDER 90					

FAN CLUTCHES

## 22010

FORD	E3TZ 8A616-R
FORD	E3TZ 8A616-S
FORD	F57Z 8A616-C
FORD	F87Z 8A616-DA
MAZDA	ZZP3-15-150

## 22011

FORD	E0WY 8A616-A
FORD	E1AZ 8A616-A
FORD	E35Y 8A616-A
FORD	E45Y 8A616-B
FORD	E4SZ 8A616-A
FORD	E6AZ 8A616-A
FORD	E6AZ 8A616-B
FORD	EOMY 8A616-A

## 22012

FORD	E3DZ 8A616-A
FORD	E3DZ 8A616-B

## 22013

GENERAL MOTORS	14001193
GENERAL MOTORS	14066205
GENERAL MOTORS	14076309
GENERAL MOTORS	14076342
GENERAL MOTORS	14076343

## 22015

FORD	F87Z 8A616-BA
MAZDA	ZZM3-15-150
MAZDA	ZZP0-15-150

## 22016

FORD	E7TZ 8A616-G
------	--------------

## 22017

JAGUAR	EAC4751
--------	---------

## 22018

JAGUAR	EAC8948
JAGUAR	NAC2215AA
JAGUAR	NBC2215AA

## 22019

MINISUBISHI	MD317679
-------------	----------

## 22020

TOYOTA	16210-75060
TOYOTA	16210-75100
TOYOTA	16210-75111

## 22021

ACURA	8-97102-903-0
ACURA	8-97135-167-0
HONDA	8-97102-903-0
HONDA	8-97135-167-0
ISUZU	8-97102-903-0
ISUZU	8-97135-167-0
TOYOTA	08921-04950
TOYOTA	16210-62030

## 22022

ACURA	8-97130-362-1
ISUZU	8-97130-362-1

## 22023

GENERAL MOTORS	15106620
ISUZU	8-15106-620-0

## 22025

NISSAN	21082-0W000
NISSAN	21082-0W00A
NISSAN	21082-5S700

NISSAN	21082-67U00
--------	-------------

## 22026

CHRYSLER	4095 704
CHRYSLER	4167 771
CHRYSLER	J5362170
GENERAL MOTORS	12529774
GENERAL MOTORS	22008474
GENERAL MOTORS	22049787
GENERAL MOTORS	22050674
GENERAL MOTORS	22062566
GENERAL MOTORS	89000171

## 22027

NISSAN	21082-0P505
--------	-------------

## 22029

MITSUBISHI	MD335271
MITSUBISHI	MN119786

## 22030

VOLVO	1274938-0
VOLVO	1306259-0
VOLVO	1328622-0
VOLVO	1357433-0

## 22031

VOLVO	1274963-0
-------	-----------

## 22032

NISSAN	21082-6P003
NISSAN	21082-6P00A
NISSAN	21082-AG200
NISSAN	21082-AG20A

## 22033

GENERAL MOTORS	91176889
GENERAL MOTORS	91177535
SUZUKI	17120-52D03
SUZUKI	17120-52D10
SUZUKI	17120-77E07

## 22037

GENERAL MOTORS	343721
GENERAL MOTORS	372502

## 22038

FORD	E0SZ 8A616-B
FORD	E0SZ 8A616-C

## 22041

GENERAL MOTORS	19161344
GENERAL MOTORS	20506687
GENERAL MOTORS	22008498
GENERAL MOTORS	22008500
GENERAL MOTORS	22050665
GENERAL MOTORS	22050668
GENERAL MOTORS	22050669
GENERAL MOTORS	4974948

## 22042

GENERAL MOTORS	4993982
----------------	---------

## 22043

AMERICAN MOTORS	3241 856
CHRYSLER	4095 703
CHRYSLER	4095 853
CHRYSLER	4266 665
GENERAL MOTORS	19161465
GENERAL MOTORS	22007578
GENERAL MOTORS	22007586
GENERAL MOTORS	22008426
GENERAL MOTORS	22008438
GENERAL MOTORS	22008462
GENERAL MOTORS	22008490

GENERAL MOTORS	22049775
GENERAL MOTORS	22050660
GENERAL MOTORS	22050661
GENERAL MOTORS	22050663
GENERAL MOTORS	22050666
GENERAL MOTORS	22050678

## 22044

FORD	E69Z 8A616-A
------	--------------

## 22045

CHRYSLER	3769 617
CHRYSLER	5300 9020
GENERAL MOTORS	10014251
GENERAL MOTORS	10197605
GENERAL MOTORS	12383420
GENERAL MOTORS	12529772
GENERAL MOTORS	14006729
GENERAL MOTORS	14006730
GENERAL MOTORS	14006731
GENERAL MOTORS	14006732
GENERAL MOTORS	14007832
GENERAL MOTORS	14007833
GENERAL MOTORS	14010295
GENERAL MOTORS	14010296
GENERAL MOTORS	14015569
GENERAL MOTORS	14020668
GENERAL MOTORS	14044660
GENERAL MOTORS	15629474
GENERAL MOTORS	15665117
GENERAL MOTORS	15963247
GENERAL MOTORS	19149243
GENERAL MOTORS	19161464
GENERAL MOTORS	22050464
GENERAL MOTORS	22050651
GENERAL MOTORS	22050654
GENERAL MOTORS	22050657
GENERAL MOTORS	22050671
GENERAL MOTORS	22050672
GENERAL MOTORS	22136853
GENERAL MOTORS	22149527
GENERAL MOTORS	460798
GENERAL MOTORS	561826
GENERAL MOTORS	88961767

## 22048

AMERICAN MOTORS	3236 603
AMERICAN MOTORS	3236 738
AMERICAN MOTORS	3237 559
AMERICAN MOTORS	3237 560
AMERICAN MOTORS	3237 591
AMERICAN MOTORS	3239 377
AMERICAN MOTORS	3241 857
AMERICAN MOTORS	J3241857
CHRYSLER	5300 1693
CHRYSLER	8133 195
CHRYSLER	J3239377
CHRYSLER	J3241856
CHRYSLER	J3241857
GENERAL MOTORS	14046527
GENERAL MOTORS	88961755

## 22049

CHRYSLER	J5362722
GENERAL MOTORS	12306610
GENERAL MOTORS	14077971
GENERAL MOTORS	1625161
GENERAL MOTORS	22008464
GENERAL MOTORS	22008508
GENERAL MOTORS	22008524



ISUZU	8-94474-181-0
<b>22094</b>	
GENERAL MOTORS	94232346
GENERAL MOTORS	94244409
ISUZU	8-94115-358-0
ISUZU	8-94232-346-0
ISUZU	8-94244-409-0
ISUZU	8-94464-916-0
<b>22096</b>	
MAZDA	FE66-23-907
<b>22098</b>	
MAZDA	JE15-15-150
MAZDA	JE23-15-150
MAZDA	JE29-15-150
MAZDA	JE56-15-150
MAZDA	JE57-15-150A
MAZDA	JE59-15-150A
<b>22099</b>	
BMW	11 52 1 277 060
BMW	11 52 7 500 339
BMW	11 52 7 502 804
BMW	11 52 7 505 302
BMW	11 52 7 831 619
<b>22123</b>	
GENERAL MOTORS	20989849
<b>22126</b>	
CHRYSLER	J5362520
FORD	E1ZZ 8A616-A
FORD	E1ZZ 8A616-B
FORD	E2DZ 8A616-A
FORD	E2DZ 8A616-B
FORD	E2TZ 8A616-A
FORD	E2ZZ 8A616-A
FORD	E3SZ 8A616-A
FORD	E3SZ 8A616-B
FORD	E3ZZ 8A616-A
FORD	E3ZZ 8A616-B
FORD	E5LY 8A616-A
FORD	E5ZZ 8A616-A
FORD	E6SZ 8A616-A
FORD	E6SZ 8A616-B
FORD	E7SZ 8A616-A
FORD	E7SZ 8A616-B
FORD	E9SZ 8A616-A
FORD	F2LY 8A616-A
<b>22135</b>	
FORD	1L5Z 8A616-AC
FORD	2L5Z 8A616-AA
FORD	4L5Z 8A616-AA
FORD	5L5Z 8A616-AA
FORD	6L5Z 8A616-CA
MAZDA	1F80-15-150
<b>22136</b>	
GENERAL MOTORS	15073580
GENERAL MOTORS	15723124
GENERAL MOTORS	88961758
ISUZU	8-15723-124-0
<b>22139</b>	
FORD	2C5Z 8A616-BA
FORD	4L2Z 8A616-AA
FORD	AU2Z 8A616-F
<b>22140</b>	
AM GENERAL	06004284

AM GENERAL	06007274
GENERAL MOTORS	15718191
GENERAL MOTORS	22149569
<b>22142</b>	
GENERAL MOTORS	15981250
GENERAL MOTORS	22124526
GENERAL MOTORS	22149818
<b>22145</b>	
GENERAL MOTORS	10197798
GENERAL MOTORS	12529773
GENERAL MOTORS	15022301
GENERAL MOTORS	15590791
GENERAL MOTORS	15644606
GENERAL MOTORS	15671897
GENERAL MOTORS	15671898
GENERAL MOTORS	15674644
GENERAL MOTORS	15677100
GENERAL MOTORS	15699657
GENERAL MOTORS	15709933
GENERAL MOTORS	15969544
GENERAL MOTORS	15977563
GENERAL MOTORS	19150657
GENERAL MOTORS	19161463
GENERAL MOTORS	22088612
GENERAL MOTORS	22097578
GENERAL MOTORS	22103707
GENERAL MOTORS	22124529
<b>22146</b>	
CHRYSLER	5202 7734
CHRYSLER	5300 9874
FORD	AU2Z 8A616-M
FORD	E2TZ 8A616-B
FORD	E4DZ 8A616-A
FORD	E4DZ 8A616-B
FORD	E5ZZ 8A616-B
FORD	E7TZ 8A616-K
FORD	E7TZ 8A616-L
FORD	E8TZ 8A616-C
FORD	E9TZ 8A616-H
FORD	E9TZ 8A616-J
FORD	E9UZ 8A616-C
FORD	F4TZ 8A616-A
FORD	F4UZ 8A616-A
<b>22147</b>	
GENERAL MOTORS	22097066
<b>22148</b>	
AMERICAN MOTORS	J3241858
CHRYSLER	5200 3205
CHRYSLER	5202 7890
CHRYSLER	5202 7890AB
CHRYSLER	5202 7892
CHRYSLER	5202 8327
CHRYSLER	5207 9625
CHRYSLER	5300 1168
CHRYSLER	6806 4284AA
CHRYSLER	6806 4764AA
CHRYSLER	6806 5080AA
CHRYSLER	J3241858
<b>22149</b>	
CHRYSLER	4637 575
CHRYSLER	4637 575AB
CHRYSLER	5200 7226
CHRYSLER	5202 8428
CHRYSLER	5207 9684
CHRYSLER	6806 4285AA

<b>22150</b>	
CHRYSLER	5505 6508AA
CHRYSLER	5505 6860AB
CHRYSLER	5505 6860AC
<b>22151</b>	
CHRYSLER	5207 9438AB
CHRYSLER	5207 9443
CHRYSLER	5207 9718AC
CHRYSLER	5207 9718AD
CHRYSLER	5503 8106AA
CHRYSLER	5511 6813AA
<b>22152</b>	
CHRYSLER	5511 6882AA
<b>22153</b>	
GENERAL MOTORS	22073413
GENERAL MOTORS	22082085
GENERAL MOTORS	22120030
GENERAL MOTORS	22135391
GENERAL MOTORS	22135975
GENERAL MOTORS	22136248
GENERAL MOTORS	22149568
<b>22154</b>	
GENERAL MOTORS	15030175
GENERAL MOTORS	15671895
GENERAL MOTORS	15685941
GENERAL MOTORS	19150658
<b>22155</b>	
FORD	F2UZ 8A616-F
FORD	F2UZ 8A616-G
FORD	F3TZ 8A616-B
FORD	F3TZ 8A616-C
<b>22156</b>	
GENERAL MOTORS	88961757
ISUZU	8-88961-757-0
<b>22157</b>	
GENERAL MOTORS	20913877
GENERAL MOTORS	22136731
GENERAL MOTORS	88986801
<b>22158</b>	
AM GENERAL	15022300
GENERAL MOTORS	15022299
GENERAL MOTORS	15022300
GENERAL MOTORS	15073014
GENERAL MOTORS	15089746
GENERAL MOTORS	15091842
GENERAL MOTORS	15154901
GENERAL MOTORS	15710101
GENERAL MOTORS	15712914
GENERAL MOTORS	15717598
GENERAL MOTORS	15735394
GENERAL MOTORS	15911779
GENERAL MOTORS	15970727
GENERAL MOTORS	15977341
GENERAL MOTORS	15999126
GENERAL MOTORS	22149877
GENERAL MOTORS	22149894
GENERAL MOTORS	25744727
GENERAL MOTORS	25744728
ISUZU	8-15154-901-0
<b>22159</b>	
CHRYSLER	5202 7848
CHRYSLER	5202 7885
CHRYSLER	5202 8214



CHRYSLER	5202 8215
CHRYSLER	5202 8297
CHRYSLER	5202 8298
CHRYSLER	5202 8743
CHRYSLER	5202 8995AA
CHRYSLER	5202 9300AD
CHRYSLER	5202 9300AE
FORD	5L3Z 8A616-AB
FORD	5L3Z 8A616-BB
FORD	AU2Z 8A616-J
FORD	F65Z 8A616-AB
FORD	F65Z 8A616-BB
FORD	F81Z 8A616-AA
FORD	F85Z 8A616-AA
FORD	F85Z 8A616-BA

<b>22160</b>	
CHRYSLER	5202 7847
CHRYSLER	5202 7883
CHRYSLER	5202 7883AB
CHRYSLER	5202 7883AC
CHRYSLER	5202 7884
CHRYSLER	5202 8305
CHRYSLER	5202 9400AA
CHRYSLER	5207 9787AA
CHRYSLER	6806 4765AA

<b>22161</b>	
FORD	E7TZ 8A616-H
FORD	E7TZ 8A616-J

<b>22162</b>	
GENERAL MOTORS	19161341
GENERAL MOTORS	22136728
GENERAL MOTORS	22136729
GENERAL MOTORS	22149819
GENERAL MOTORS	22149834
ISUZU	8-15073-580-0
ISUZU	8-19161-341-0
ISUZU	8-22120-030-0
ISUZU	8-22149-819-0

<b>22163</b>	
FORD	F1SZ 8A616-A

<b>22164</b>	
CHRYSLER	5202 8992AA
CHRYSLER	5202 8992AC
CHRYSLER	5202 8994AA
CHRYSLER	5202 8994AB
CHRYSLER	5202 8994AC
CHRYSLER	6808 8545AA

<b>22165</b>	
FORD	F1VY 8A616-A
FORD	F1VY 8A616-B

<b>22166</b>	
FORD	6L2Z 8A616-BA
FORD	6L5Z 8A616-BA
FORD	F1TZ 8A616-G
FORD	F1TZ 8A616-K
FORD	F57Z 8A616-A
FORD	F57Z 8A616-D
FORD	F57Z 8A616-RA
FORD	F77Z 8A616-LB
FORD	F87Z 8A616-FA
MAZDA	1F82-15-150
MAZDA	ZZL4-15-150
MAZDA	ZZM2-15-150A
MAZDA	ZZM8-15-150
MAZDA	ZZP2-15-150

<b>22167</b>	
FORD	AU2Z 8A616-N
FORD	F1TZ 8A616-E
FORD	F1TZ 8A616-L
MAZDA	ZZL0-15-150C
MAZDA	ZZL3-15-150B
MAZDA	ZZM1-15-150
MAZDA	ZZM5-15-150

<b>22168</b>	
CHRYSLER	5202 9858AA
CHRYSLER	5202 9858AD
CHRYSLER	5202 9858AE
CHRYSLER	6806 4767AA
FORD	4L3Z 8A616-CA
FORD	5C2Z 8A616-CA
FORD	5C2Z 8A616-DA
FORD	5L3Z 8A616-CB
FORD	5L3Z 8A616-DB
FORD	7C2Z 8A616-A
FORD	7C2Z 8A616-B
FORD	7C3Z 8A616-A
FORD	7C3Z 8A616-C
FORD	F65Z 8A616-CA
FORD	F65Z 8A616-DA
FORD	F7UZ 8A616-CA
FORD	F7UZ 8A616-DA
FORD	F81Z 8A616-LA
FORD	F85Z 8A616-CA
FORD	F85Z 8A616-DA

<b>22169</b>	
FORD	F2AZ 8A616-D
FORD	F3VY 8A616-A
FORD	F4VY 8A616-B
FORD	F6AZ 8A616-AA

<b>22170</b>	
CHRYSLER	5202 7710
CHRYSLER	5202 7710AB
CHRYSLER	5202 7858
CHRYSLER	5202 7860
CHRYSLER	5202 7862
CHRYSLER	5202 7882
CHRYSLER	5202 7882AB
CHRYSLER	5202 8207
CHRYSLER	5202 8208
CHRYSLER	5202 8306
CHRYSLER	5202 8307
CHRYSLER	5202 8799AC
CHRYSLER	5202 8837AA
CHRYSLER	5202 8940AB
CHRYSLER	5202 9076AA
CHRYSLER	5202 9084AA
CHRYSLER	5202 9085AA
CHRYSLER	5202 9275AA
CHRYSLER	5202 9275AD
CHRYSLER	5202 9276AA
CHRYSLER	5202 9276AD
CHRYSLER	5202 9290AC
CHRYSLER	5202 9291AD
CHRYSLER	5202 9291AE
CHRYSLER	5202 9767AA
CHRYSLER	5503 7733AD
CHRYSLER	5505 6585AA
CHRYSLER	6806 4766AA
LAND ROVER	ERR 4996

<b>22171</b>	
CHRYSLER	5202 8799AA

CHRYSLER	5202 8799AB
CHRYSLER	5202 8944
CHRYSLER	5202 8944AB
CHRYSLER	5202 9152
CHRYSLER	5202 9152AB

<b>22173</b>	
AM GENERAL	15106619
AM GENERAL	25948772
GENERAL MOTORS	15106619
GENERAL MOTORS	15735393
GENERAL MOTORS	25948772
ISUZU	8-15106-619-0
ISUZU	8-25948-772-0

<b>22174</b>	
CHRYSLER	5202 7823
CHRYSLER	5202 7824
CHRYSLER	5207 9671AB

<b>22175</b>	
ISUZU	8-97014-597-0
ISUZU	8-97061-702-0

<b>22176</b>	
HONDA	8-97172-200-1
HONDA	8-97172-200-2
ISUZU	8-97172-200-2
ISUZU	8-97349-761-0

<b>22177</b>	
TOYOTA	16210-50080

<b>22178</b>	
TOYOTA	16210-50021
TOYOTA	16210-50061

<b>22179</b>	
GENERAL MOTORS	15549993
GENERAL MOTORS	15564860
GENERAL MOTORS	15642505
GENERAL MOTORS	19149906

<b>22181</b>	
NISSAN	21082-7S00A

<b>22182</b>	
NISSAN	21082-EA000
NISSAN	21082-EA00A
NISSAN	21082-EA01A
NISSAN	21082-EA200
SUZUKI	17120-82Z00
SUZUKI	17120-82Z10
SUZUKI	17120-82Z20

<b>22183</b>	
TOYOTA	16210-50051

<b>22184</b>	
TOYOTA	16210-50090

<b>22185</b>	
TOYOTA	16210-50101
TOYOTA	16210-50102

<b>22296</b>	
MAZDA	FE2H-15-150B

<b>22301</b>	
MERCEDES-BENZ	603 200 02 22
MERCEDES-BENZ	606 200 00 22

<b>22302</b>	
AUDI	058 121 350
VOLKSWAGEN	058 121 350

<b>22303</b>	
AUDI	078 121 350 A
AUDI	4Z7 121 350
VOLKSWAGEN	078 121 350 A
<b>22305</b>	
LAND ROVER	ERC 5708
<b>22306</b>	
MERCEDES-BENZ	603 200 00 22
<b>22307</b>	
MERCEDES-BENZ	103 200 04 22
MERCEDES-BENZ	104 200 01 22
<b>22308</b>	
MERCEDES-BENZ	111 200 04 22
<b>22310</b>	
GENERAL MOTORS	10383029
GENERAL MOTORS	15293048
GENERAL MOTORS	25790869
ISUZU	8-10383-029-0
SAAB	15 29 3048
SAAB	25 79 0869
<b>22311</b>	
AUDI	077 121 302 D
AUDI	4A0 121 350 B
<b>22313</b>	
MERCEDES-BENZ	119 200 01 22
<b>22316</b>	
AUDI	077 121 350 D
<b>22319</b>	
MERCEDES-BENZ	000 200 04 22
MERCEDES-BENZ	000 200 19 22
<b>22320</b>	
MERCEDES-BENZ	103 200 05 22
MERCEDES-BENZ	116 200 11 22
<b>22321</b>	
MERCEDES-BENZ	113 200 00 22
MERCEDES-BENZ	113 200 02 22
<b>22322</b>	
MERCEDES-BENZ	103 200 06 22
<b>22323</b>	
MERCEDES-BENZ	120 200 01 22
<b>22324</b>	
MERCEDES-BENZ	112 200 01 22
<b>22325</b>	
MERCEDES-BENZ	112 200 02 22
<b>22326</b>	
BMW	11 52 7 830 486
<b>22327</b>	
MERCEDES-BENZ	606 200 01 22
<b>22328</b>	
CHRYSLER	5103 623AA
CHRYSLER	6800 4915AA
<b>22329</b>	
FORD	8C3Z 8A616-A
FORD	8C3Z 8A616-S
<b>22330</b>	
GENERAL MOTORS	15802525
GENERAL MOTORS	25816289
ISUZU	8-15071-248-0

ISUZU	8-25790-869-0
ISUZU	8-25816-289-0
SAAB	25 81 6289
<b>22331</b>	
CHRYSLER	5202 8879AD
CHRYSLER	5202 8879AF
CHRYSLER	5505 6990AA
CHRYSLER	5505 6990AB
CHRYSLER	5505 6990AC
<b>22332</b>	
FORD	4C3Z 8A616-AA
FORD	4C3Z 8A616-SA
FORD	7C3Z 8A616-F
<b>22333</b>	
CHRYSLER	6801 2412AA
<b>22334</b>	
FORD	9L3Z 8A616-B
<b>22335</b>	
MERCEDES-BENZ	119 200 00 22
<b>22337</b>	
FORD	7L2Z 8A616-A
<b>22338</b>	
FORD	7L1Z 8A616-A
<b>22339</b>	
FORD	BC3Z 8A616-A
FORD	BC3Z 8A616-C
<b>22340</b>	
FORD	BC3Z 8A616-B
FORD	BC3Z 8A616-CC
<b>22341</b>	
GENERAL MOTORS	20788261
<b>22342</b>	
GENERAL MOTORS	25838900
<b>22373</b>	
KIA	0K011-15-140
KIA	0K028-15-140
KIA	0K048-15-140
<b>22396</b>	
MAZDA	JF04-15-150A
<b>22399</b>	
BMW	17 41 7 505 109
LAND ROVER	PGB 000040
<b>22401</b>	
TOYOTA	16210-35020
<b>22402</b>	
TOYOTA	16210-46030
TOYOTA	16210-46042
<b>22404</b>	
TOYOTA	16210-54070
<b>22405</b>	
SUBARU	73070 GA021
<b>22406</b>	
DAIHATSU	16210-87103-000
SUBARU	73070 GA020
SUBARU	SOA33 2A383
<b>22407</b>	
TOYOTA	16210-0P010
TOYOTA	16210-31030

TOYOTA	16210-31040
<b>22408</b>	
TOYOTA	16210-38070
TOYOTA	16210-38080
<b>22409</b>	
MITSUBISHI	MD356867
<b>22410</b>	
MITSUBISHI	MN176301
<b>22496</b>	
MAZDA	JE48-15-150C
MAZDA	JE53-15-150C
<b>22601</b>	
FORD	E5TZ 8A616-C
FORD	E5TZ 8A616-G
FORD	E8TZ 8A616-D
FORD	E9TZ 8A616-A
FORD	F2UZ 8A616-H
<b>22602</b>	
GENERAL MOTORS	14032392
<b>22605</b>	
AM GENERAL	06003082
GENERAL MOTORS	15969543
GENERAL MOTORS	15991496
<b>22606</b>	
GENERAL MOTORS	15671935
<b>22607</b>	
FORD	F2TZ 8A616-C
FORD	F4TZ 8A616-B
<b>22609</b>	
FORD	F5TZ 8A616-KB
<b>22610</b>	
FORD	5C3Z 8A616-A
FORD	5C3Z 8A616-B
FORD	5C3Z 8A616-BA
FORD	5C3Z 8A616-MA
FORD	7C3Z 8A616-B
FORD	7C3Z 8A616-D
FORD	F7UZ 8A616-JA
FORD	F7UZ 8A616-KA
FORD	F81Z 8A616-BA
FORD	F81Z 8A616-MA
<b>22611</b>	
FORD	AU2Z 8A616-L
FORD	F81Z 8A616-DA
<b>22612</b>	
FORD	AU2Z 8A616-TA
FORD	F8UZ 8A616-AA
<b>22613</b>	
AM GENERAL	06008664
GENERAL MOTORS	15022302
GENERAL MOTORS	15028400
GENERAL MOTORS	15030174
GENERAL MOTORS	15956343
<b>22614</b>	
GENERAL MOTORS	15029405
GENERAL MOTORS	15152298
<b>22615</b>	
AM GENERAL	25844696
FORD	F67Z 8A616-NA
GENERAL MOTORS	25844696

<b>22616</b>	
CHRYSLER	5202 8894AA
<b>22617</b>	
GENERAL MOTORS	15130067
<b>22618</b>	
AM GENERAL	06009791
AM GENERAL	06009991
<b>22620</b>	
CHRYSLER	5202 8877AC
CHRYSLER	5202 9860AC
CHRYSLER	5202 9876AC
CHRYSLER	5505 6963AA
CHRYSLER	5505 6963AB
CHRYSLER	5505 7111AA
<b>22621</b>	
CHRYSLER	5202 8789AB
CHRYSLER	5202 8789AC
CHRYSLER	5202 8789AE
CHRYSLER	5202 8789AF
CHRYSLER	5202 8790AC
CHRYSLER	5202 8790AE
CHRYSLER	5202 9977AB
CHRYSLER	5202 9977AD
<b>22625</b>	
GENERAL MOTORS	15102145
<b>22626</b>	
CHRYSLER	5505 6699AA
CHRYSLER	6808 5950AA
<b>22628</b>	
GENERAL MOTORS	21992573
<b>22063EX</b>	
LAND ROVER	ERR 3443
LAND ROVER	ETC 1260



# FAN CLUTCH OEM CROSS REFERENCE



ACURA	
8-97102-903-0	22021
8-97102-903-0	22076
8-97130-362-1	22022
8-97135-167-0	22021

AM GENERAL	
05939545	22052
06003082	22605
06004284	22140
06007274	22140
06008664	22613
06009791	22618
06009991	22618
06009991	22618
15022300	22158
15106619	22173
25844696	22615
25948772	22173

AMERICAN MOTORS	
3236 603	22048
3236 738	22048
3237 559	22048
3237 560	22048
3237 591	22048
3239 377	22048
3241 856	22043
3241 857	22048
J3241857	22048
J3241858	22048
J3241858	22148

AUDI	
058 121 350	22302
077 121 302 D	22311
077 121 350 D	22316
078 121 350 A	22303
4A0 121 350 B	22311
4Z7 121 350	22303

BMW	
11 52 1 277 060	22099
11 52 1 466 000	22071
11 52 1 723 918	22071
11 52 7 500 339	22099
11 52 7 502 804	22099
11 52 7 505 302	22099
11 52 7 830 486	22326
11 52 7 831 619	22099
17 41 7 505 109	22399

CHRYSLER	
3769 317	22054
3769 317	22054
3769 317	22054
3769 617	22045
3769 617	22045
3769 617	22045
3769 617	22045
4095 703	22043
4095 703	22043
4095 703	22043
4095 704	22026
4095 704	22026
4095 704	22026
4095 704	22043
4095 704	22043
4095 704	22043
4095 853	22043
4095 853	22043

4095 853	22043
4167 771	22026
4167 771	22026
4167 771	22026
4167 771	22026
4266 665	22043
4428 159	22070
4637 575	22149
4637 575AB	22149
5103 623AA	22328
5200 3205	22148
5200 4928	22070
5200 6096	22070
5200 7226	22149
5202 7710	22170
5202 7710AB	22170
5202 7734	22146
5202 7823	22174
5202 7824	22174
5202 7847	22159
5202 7847	22160
5202 7848	22159
5202 7858	22170
5202 7860	22170
5202 7862	22170
5202 7882	22170
5202 7882AB	22160
5202 7882AB	22170
5202 7883	22160
5202 7883AB	22159
5202 7883AB	22159
5202 7883AB	22160
5202 7883AB	22160
5202 7883AC	22160
5202 7884	22160
5202 7885	22159
5202 7890	22148
5202 7890AB	22148
5202 7892	22148
5202 8207	22170
5202 8208	22170
5202 8214	22159
5202 8215	22159
5202 8297	22159
5202 8298	22159
5202 8305	22160
5202 8306	22170
5202 8307	22170
5202 8327	22148
5202 8428	22149
5202 8615AB	22070
5202 8743	22159
5202 8760	22070
5202 8789AB	22621
5202 8789AC	22621
5202 8789AE	22621
5202 8789AF	22621
5202 8790AC	22621
5202 8790AE	22621
5202 8799AA	22171
5202 8799AB	22171
5202 8799AC	22170
5202 8837AA	22170
5202 8877AC	22620
5202 8879AD	22331
5202 8879AF	22331
5202 8894AA	22616
5202 8940AB	22170
5202 8944	22171
5202 8944AB	22171

5202 8992AA	22164
5202 8992AC	22164
5202 8992AC	22164
5202 8994AA	22164
5202 8994AB	22164
5202 8994AC	22164
5202 8994AC	22164
5202 8995AA	22159
5202 8995AA	22159
5202 9076AA	22170
5202 9084AA	22170
5202 9084AA	22171
5202 9085AA	22170
5202 9152	22171
5202 9152AB	22171
5202 9275AA	22170
5202 9275AD	22170
5202 9276AA	22170
5202 9276AD	22170
5202 9290AC	22170
5202 9290AC	22170
5202 9291AD	22170
5202 9291AD	22170
5202 9291AE	22170
5202 9291AE	22170
5202 9300AD	22159
5202 9300AE	22159
5202 9400AA	22160
5202 9767AA	22170
5202 9858AA	22168
5202 9858AD	22168
5202 9858AE	22168
5202 9860AC	22620
5202 9876AC	22620
5202 9876AC	22621
5202 9977AB	22621
5202 9977AD	22621
5207 9438AB	22151
5207 9443	22151
5207 9625	22148
5207 9671AB	22174
5207 9684	22149
5207 9718AC	22151
5207 9718AD	22151
5207 9718AD	22152
5207 9787AA	22160
5300 1168	22148
5300 1693	22048
5300 9020	22045
5300 9874	22146
5503 7733AD	22170
5503 8106AA	22151
5503 8106AA	22151
5503 8106AA	22152
5505 6508AA	22150
5505 6585AA	22170
5505 6585AA	22170
5505 6699AA	22626
5505 6840AB	22059
5505 6840AC	22059
5505 6860AB	22150
5505 6860AC	22150
5505 6946AA	22070
5505 6963AA	22620
5505 6963AB	22620
5505 6990AA	22331
5505 6990AB	22331
5505 6990AC	22331



5505 7087AA	22059	5C3Z 8A616-MA	22610	E2UZ 8A616-B	22054
5505 7111AA	22620	5L3Z 8A616-AB	22159	E2ZZ 8A616-A	22126
5505 7152AA	22059	5L3Z 8A616-AB	22168	E2ZZ 8A616-A	22126
5505 7153AA	22059	5L3Z 8A616-BB	22159	E35Y 8A616-A	22011
5511 6813AA	22151	5L3Z 8A616-BB	22168	E3DZ 8A616-A	22012
5511 6882AA	22152	5L3Z 8A616-CB	22168	E3DZ 8A616-A	22012
6800 4915AA	22328	5L3Z 8A616-CB	22168	E3DZ 8A616-B	22012
6801 2412AA	22333	5L3Z 8A616-DB	22168	E3DZ 8A616-B	22012
6801 2413AA	22070	5L3Z 8A616-DB	22168	E3SZ 8A616-A	22126
6806 4284AA	22148	5L5Z 8A616-AA	22135	E3SZ 8A616-A	22126
6806 4285AA	22149	6L2Z 8A616-BA	22166	E3SZ 8A616-A	22126
6806 4764AA	22148	6L2Z 8A616-BA	22166	E3SZ 8A616-B	22126
6806 4765AA	22159	6L5Z 8A616-AA	22078	E3SZ 8A616-B	22126
6806 4765AA	22159	6L5Z 8A616-BA	22166	E3TZ 8A616-L	22052
6806 4765AA	22160	6L5Z 8A616-BA	22166	E3TZ 8A616-P	22052
6806 4765AA	22160	6L5Z 8A616-CA	22135	E3TZ 8A616-R	22010
6806 4766AA	22151	6L5Z 8A616-CA	22166	E3TZ 8A616-S	22010
6806 4766AA	22170	7C2Z 8A616-A	22168	E3TZ 8A616-T	22061
6806 4767AA	22168	7C2Z 8A616-B	22168	E3TZ 8A616-U	22061
6806 5080AA	22148	7C3Z 8A616-A	22168	E3ZZ 8A616-A	22126
6808 5950AA	22152	7C3Z 8A616-B	22168	E3ZZ 8A616-A	22126
6808 5950AA	22626	7C3Z 8A616-B	22610	E3ZZ 8A616-B	22126
6808 8545AA	22164	7C3Z 8A616-C	22168	E3ZZ 8A616-B	22126
6808 8545AA	22164	7C3Z 8A616-D	22610	E45Y 8A616-B	22011
8133 195	22048	7C3Z 8A616-F	22332	E45Y 8A616-B	22011
J3239377	22048	7L1Z 8A616-A	22338	E45Y 8A616-B	22011
J3241856	22048	7L1Z 8A616-A	22338	E4DZ 8A616-A	22146
J3241857	22048	7L2Z 8A616-A	22166	E4DZ 8A616-A	22146
J3241858	22048	7L2Z 8A616-A	22166	E4DZ 8A616-B	22146
J3241858	22148	7L2Z 8A616-A	22337	E4DZ 8A616-B	22146
J5362170	22026	7L2Z 8A616-A	22337	E4SZ 8A616-A	22011
J5362520	22126	8C3Z 8A616-A	22329	E4SZ 8A616-A	22011
J5362722	22049	8C3Z 8A616-S	22329	E4TZ 8A616-A	22060
MD021502	22092	9L3Z 8A616-B	22334	E5LY 8A616-A	22126
MD021502	22092	9L3Z 8A616-B	22334	E5TZ 8A616-A	22065
MD023697	22092	AU2Z 8A616-F	22139	E5TZ 8A616-B	22065
MD023697	22092	AU2Z 8A616-F	22139	E5TZ 8A616-C	22601
MD023698	22086	AU2Z 8A616-F	22139	E5TZ 8A616-G	22601
MD041079	22086	AU2Z 8A616-J	22159	E5ZZ 8A616-A	22126
MD050472	22073	AU2Z 8A616-L	22611	E5ZZ 8A616-A	22126
MD063740	22092	AU2Z 8A616-L	22612	E5ZZ 8A616-B	22146
MD063740	22092	AU2Z 8A616-L	22146	E5ZZ 8A616-B	22146
MD104576	22092	AU2Z 8A616-M	22146	E69Z 8A616-A	22044
MD104576	22092	AU2Z 8A616-N	22167	E69Z 8A616-B	22065
MD104576	22092	AU2Z 8A616-P	22052	E69Z 8A616-B	22065
MD104576	22092	AU2Z 8A616-TA	22612	E69Z 8A616-D	22064
MD106546	22073	BC3Z 8A616-A	22339	E69Z 8A616-E	22064
MD142419	22073	BC3Z 8A616-B	22340	E69Z 8A616-F	22065
		BC3Z 8A616-C	22339	E6AZ 8A616-A	22011
		BC3Z 8A616-CC	22340	E6AZ 8A616-A	22011
		D3TZ 8A616-A	22052	E6AZ 8A616-B	22011
		E0SZ 8A616-B	22038	E6AZ 8A616-B	22011
		E0SZ 8A616-B	22038	E6AZ 8A616-B	22011
		E0SZ 8A616-C	22038	E6SZ 8A616-A	22126
		E0SZ 8A616-C	22038	E6SZ 8A616-A	22126
		E0WY 8A616-A	22011	E6SZ 8A616-B	22126
		E0WY 8A616-A	22011	E6SZ 8A616-B	22126
		E1AZ 8A616-A	22011	E7SZ 8A616-A	22126
		E1AZ 8A616-A	22011	E7SZ 8A616-A	22126
		E1AZ 8A616-A	22011	E7SZ 8A616-A	22126
		E1TZ 8A616-A	22052	E7SZ 8A616-B	22126
		E1TZ 8A616-B	22054	E7SZ 8A616-B	22126
		E1ZZ 8A616-A	22126	E7TZ 8A616-G	22016
		E1ZZ 8A616-A	22126	E7TZ 8A616-H	22161
		E1ZZ 8A616-B	22126	E7TZ 8A616-J	22161
		E1ZZ 8A616-B	22126	E7TZ 8A616-K	22146
		E2DZ 8A616-A	22126	E7TZ 8A616-L	22146
		E2DZ 8A616-B	22126	E8TZ 8A616-C	22146
		E2DZ 8A616-B	22126	E8TZ 8A616-D	22601
		E2TZ 8A616-A	22126		
		E2TZ 8A616-B	22146		

**DAIHATSU**

16210-87103-000 22406

**FORD**

1L5Z 8A616-AC 22135  
 2C5Z 8A616-BA 22139  
 2C5Z 8A616-BA 22139  
 2C5Z 8A616-BA 22139  
 2L5Z 8A616-AA 22135  
 4C3Z 8A616-AA 22332  
 4C3Z 8A616-SA 22332  
 4L2Z 8A616-AA 22139  
 4L2Z 8A616-AA 22139  
 4L3Z 8A616-CA 22168  
 4L3Z 8A616-CA 22168  
 4L5Z 8A616-AA 22135  
 5C2Z 8A616-CA 22168  
 5C2Z 8A616-DA 22168  
 5C3Z 8A616-A 22610  
 5C3Z 8A616-B 22610  
 5C3Z 8A616-BA 22610



1554993	22179	15977563	22145	22008490	22043
15564860	22179	15977563	22145	22008498	22041
15564860	22179	15981250	22142	22008500	22041
15590791	22145	15981250	22142	22008508	22049
15625460	22052	15991496	22605	22008508	22049
15625460	22052	15991496	22605	22008524	22049
15629474	22045	15999126	22158	22049771	22049
15629474	22045	15999126	22158	22049774	22045
15631899	22051	1625161	22049	22049774	22045
15631899	22051	19149243	22045	22049774	22045
15642505	22179	19149243	22045	22049774	22045
15642505	22179	19149243	22045	22049774	22045
15644606	22145	19149243	22045	22049774	22049
15644606	22145	19149243	22045	22049774	22049
15665117	22045	19149906	22179	22049774	22049
15665117	22045	19149906	22179	22049774	22049
15665117	22045	19150657	22142	22049774	22049
15671895	22154	19150657	22142	22049775	22043
15671895	22154	19150657	22145	22049775	22043
15671897	22145	19150657	22145	22049776	22045
15671897	22145	19150657	22145	22049776	22045
15671898	22145	19150657	22145	22049776	22045
15671898	22145	19150657	22145	22049776	22045
15671935	22606	19150658	22154	22049776	22045
15671935	22606	19150658	22154	22049776	22049
15674644	22145	19150977	22153	22049776	22049
15674644	22145	19150977	22153	22049776	22049
15677100	22145	19150977	22157	22049776	22049
15677100	22145	19150977	22157	22049776	22049
15677108	22052	19150977	22158	22049785	22049
15677108	22052	19150977	22158	22049785	22049
15685941	22154	19150977	22158	22049787	22026
15685941	22154	19161341	22158	22049787	22026
15699657	22145	19161341	22162	22049787	22026
15699657	22145	19161341	22162	22049787	22045
15709933	22145	19161341	22162	22049787	22045
15709933	22145	19161344	22041	22049787	22045
15709933	22145	19161463	22145	22050464	22045
15710101	22158	19161464	22045	22050648	22045
15710101	22158	19161464	22045	22050648	22045
15712914	22158	19161465	22043	22050648	22045
15712914	22158	20506687	22041	22050648	22049
15717598	22158	20788261	22341	22050648	22049
15718191	22140	20788261	22341	22050648	22049
15718191	22140	20913877	22157	22050649	22049
15723124	22136	20913877	22157	22050651	22045
15723124	22136	20913877	22158	22050651	22045
15735393	22173	20913877	22158	22050651	22045
15735393	22173	20913877	22158	22050651	22045
15735394	22158	20989849	22123	22050651	22045
15735394	22158	20989849	22123	22050654	22045
15802525	22330	21992573	22628	22050654	22045
15802525	22330	22007578	22043	22050654	22045
15802525	22330	22007586	22043	22050654	22045
15911779	22158	22008426	22043	22050656	22049
15911779	22158	22008426	22043	22050656	22049
15911779	22158	22008426	22043	22050656	22049
15956343	22613	22008426	22043	22050657	22045
15956343	22613	22008438	22043	22050657	22045
15963247	22045	22008462	22043	22050660	22043
15963247	22045	22008462	22043	22050660	22043
15969543	22605	22008464	22049	22050661	22043
15969543	22605	22008464	22049	22050661	22043
15969544	22145	22008464	22049	22050662	22049
15969544	22145	22008464	22049	22050662	22049
15970727	22158	22008464	22049	22050662	22049
15977341	22158	22008474	22026	22050662	22049
15977341	22158	22008474	22026	22050662	22049



# FAN CLUTCH OEM CROSS REFERENCE



22050662	22049	22136729	22162	88961755	22048
22050663	22043	22136731	22157	88961755	22056
22050663	22043	22136731	22157	88961755	22056
22050663	22043	22136853	22045	88961756	22056
22050663	22043	22136853	22045	88961756	22056
22050663	22043	22149527	22045	88961757	22156
22050665	22041	22149527	22045	88961757	22156
22050666	22043	22149527	22045	88961758	22136
22050666	22043	22149527	22045	88961758	22136
22050667	22049	22149568	22145	88961759	22045
22050667	22049	22149568	22145	88961759	22045
22050668	22041	22149568	22153	88961759	22045
22050668	22041	22149568	22153	88961759	22049
22050669	22041	22149569	22140	88961759	22049
22050671	22045	22149569	22140	88961759	22049
22050671	22045	22149818	22142	88961759	22049
22050672	22045	22149818	22142	88961761	22049
22050672	22045	22149819	22162	88961767	22045
22050672	22045	22149819	22162	88961767	22045
22050673	22049	22149819	22162	88961767	22045
22050674	22026	22149834	22162	88961767	22045
22050674	22026	22149834	22162	88961768	22052
22050676	22045	22149834	22162	88961768	22052
22050676	22045	22149877	22158	88986801	22157
22050676	22045	22149877	22158	88986801	22157
22050676	22049	22149877	22158	89000171	22026
22050676	22049	22149894	22158	89000171	22026
22050676	22049	22149894	22158	91173035	22068
22050678	22043	22149894	22158	91176889	22033
22050761	22049	22514197	22049	91177535	22033
22050761	22049	22514197	22049	94232346	22094
22062566	22026	22514197	22049	94232347	22049
22062566	22026	25744727	22158	94244409	22094
22073413	22153	25744727	22158		
22075085	22049	25744728	22158	<b>GEO</b>	
22075085	22049	25744728	22158	91173035	22068
22075085	22049	25790869	22310	<b>HONDA</b>	
22082085	22142	25790869	22310	8-97080-688-0	22072
22082085	22142	25790869	22310	8-97102-903-0	22021
22082085	22142	25790869	22310	8-97102-903-0	22076
22082085	22143	25790869	22330	8-97135-167-0	22021
22082085	22143	25790869	22330	8-97172-200-1	22176
22082085	22143	25790869	22330	8-97172-200-2	22176
22082085	22153	25816289	22330	<b>ISUZU</b>	
22082085	22153	25816289	22330	8-10383-029-0	22310
22082085	22153	25816289	22627	8-15071-248-0	22330
22088612	22145	25816289	22627	8-15073-580-0	22162
22097066	22147	25838900	22342	8-15106-619-0	22173
22097066	22147	25838900	22342	8-15106-620-0	22023
22097578	22145	25844696	22615	8-15154-901-0	22158
22097578	22145	25844696	22615	8-15723-124-0	22136
22097578	22145	25948772	22173	8-19161-341-0	22162
22097578	22145	25948772	22173	8-22120-030-0	22162
22103707	22145	342754	22049	8-22149-819-0	22162
22120030	22153	342754	22049	8-25790-869-0	22310
22120030	22153	343721	22037	8-25790-869-0	22330
22124526	22142	372502	22037	8-25816-289-0	22330
22124526	22142	460798	22045	8-25948-772-0	22173
22124529	22145	460798	22045	8-88961-757-0	22156
22124529	22145	472807	22049	8-94113-204-0	22093
22135391	22153	4974948	22041	8-94115-358-0	22094
22135391	22153	4993982	22042	8-94232-346-0	22094
22135975	22153	4993982	22042	8-94244-409-0	22094
22135975	22153	561826	22045	8-94310-518-0	22087
22136248	22153	561826	22045	8-94311-252-0	22087
22136728	22162	561826	22045	8-94412-030-0	22087
22136728	22162	561826	22045	8-94464-916-0	22094
22136729	22162	88961755	22048	8-94474-181-0	22093



8-97014-597-0	22175
8-97018-918-1	22076
8-97061-702-0	22175
8-97080-688-0	22072
8-97102-903-0	22021
8-97102-903-0	22076
8-97130-362-1	22022
8-97135-167-0	22021
8-97172-200-2	22176
8-97349-761-0	22176

**JAGUAR**

EAC4751	22017
EAC8948	22018
NAC2215AA	22018
NBC2215AA	22018

**KIA**

OK011-15-140	22373
OK028-15-140	22373
OK048-15-140	22373

**LAND ROVER**

ERC 2849	22063
ERC 5708	22305
ERR 3443	22063EX
ERR 4996	22170
ETC 1260	22063EX
PGB 000040	22399

**MAZDA**

1F80-15-150	22135
1F81-15-150	22078
1F81-15-150	22135
1F82-15-150	22135
1F82-15-150	22166
AM15-15-9X3	22092
FE2H-15-150B	22296
FE66-23-907	22096
G601-15-150A	22090
G607-15-150A	22090
JE15-15-150	22098
JE23-15-150	22098
JE29-15-150	22098
JE48-15-150C	22496
JE53-15-150C	22496
JE56-15-150	22098
JE57-15-150A	22098
JE59-15-150A	22098
JF04-15-150A	22396
ZZL0-15-150C	22167
ZZL3-15-150B	22167
ZZL4-15-150	22166
ZZM1-15-150	22167
ZZM2-15-150A	22166
ZZM3-15-150	22015
ZZM4-15-150	22064
ZZM5-15-150	22167
ZZM7-15-150	22064
ZZM8-15-150	22166
ZZMA-15-150	22078
ZZMD-15-150	22078
ZZP0-15-150	22015
ZZP1-15-150	22078
ZZP2-15-150	22166
ZZP3-15-150	22010

**MERCEDES-BENZ**

000 200 04 22	22319
000 200 19 22	22319
103 200 04 22	22307

103 200 05 22	22320
103 200 06 22	22322
104 200 01 22	22307
111 200 04 22	22308
112 200 01 22	22324
112 200 02 22	22318
112 200 02 22	22325
113 200 00 22	22321
113 200 02 22	22321
116 200 11 22	22320
119 200 00 22	22335
119 200 01 22	22313
120 200 01 22	22323
603 200 00 22	22306
603 200 02 22	22301
606 200 00 22	22301
606 200 01 22	22327

**MERKUR**

E7RY 8A616-A	22067
--------------	-------

**MITSUBISHI**

MD023697	22092
MD023698	22086
MD041079	22086
MD050472	22073
MD063740	22092
MD104576	22092
MD106546	22073
MD108270	22086
MD142419	22073
MD303502	22073
MD317679	22019
MD334660	22073
MD335271	22029
MD356867	22409
MN119786	22029
MN176301	22410

**NISSAN**

21082-01P04	22082
21082-0P505	22027
21082-0W000	22025
21082-0W000	22025
21082-0W00A	22025
21082-0W00A	22025
21082-10G21	22082
21082-12G10	22082
21082-16V00	22082
21082-36W00	22082
21082-40F00	22082
21082-40P00	22091
21082-40P10	22091
21082-5S700	22025
21082-60U00	22082
21082-67U00	22025
21082-6P003	22032
21082-6P003	22032
21082-6P00A	22032
21082-6P00A	22032
21082-7S00A	22181
21082-7S00A	22181
21082-86G00	22082
21082-86G0A	22082
21082-88G00	22091
21082-AG200	22032
21082-AG20A	22032
21082-EA000	22182
21082-EA00A	22182
21082-EA01A	22182

21082-EA200	22182
21082-W4404	22088
21082-W4405	22088
21082-Y4161	22082

**SAAB**

15 29 3048	22310
25 79 0869	22310
25 79 0869	22330
25 81 6289	22330
25 81 6289	22627

**SUBARU**

73070 GA020	22406
73070 GA021	22405
SOA33 2A383	22406

**SUZUKI**

17120-52D03	22033
17120-52D10	22033
17120-57B01	22068
17120-77E07	22033
17120-82Z00	22182
17120-82Z10	22182
17120-82Z20	22182

**TOYOTA**

08921-04950	22021
16210-0P010	22407
16210-16010	22080
16210-18010	22080
16210-28020	22080
16210-31010	22086
16210-31030	22407
16210-31040	22407
16210-35020	22401
16210-38050	22081
16210-38060	22081
16210-38070	22408
16210-38070	22408
16210-38080	22408
16210-42030	22085
16210-42040	22085
16210-42050	22085
16210-42060	22085
16210-42070	22085
16210-43021	22085
16210-45100	22085
16210-46030	22402
16210-46030	22402
16210-46042	22402
16210-50021	22178
16210-50051	22183
16210-50051	22183
16210-50061	22178
16210-50080	22177
16210-50090	22184
16210-50090	22184
16210-50101	22185
16210-50101	22185
16210-50102	22185
16210-50102	22185
16210-54040	22081
16210-54070	22404
16210-61072	22076
16210-61121	22076
16210-61160	22076
16210-62030	22021
16210-65020	22076
16210-65030	22076
16210-66020	22074



# FAN CLUTCH OEM CROSS REFERENCE

**USMW**  
*Professional Series*

16210-66020	22074
16210-73010	22086
16210-73041	22086
16210-75060	22020
16210-75100	22020
16210-75111	22020
16210-76010	22075

## **VOLKSWAGEN**

058 121 350	22302
078 121 350 A	22303

## **VOLVO**

1274938-0	22030
1274963-0	22031
1306259-0	22030
1328622-0	22030
1357433-0	22030

**21011**  
ROT: CW/CCW MOUNT: Bolt-On  
Regular Non-Thermal



**21012**  
ROT: CW/CCW MOUNT: Bolt-On  
Regular Non-Thermal



**21016**  
ROT: CW/CCW MOUNT: Bolt-On  
Regular Non-Thermal



**21034**  
ROT: CW/CCW MOUNT: Bolt-On  
Regular Non-Thermal



**21037**  
ROT: CW/CCW MOUNT: Bolt-On  
Regular Non-Thermal



**21038**  
ROT: CW/CCW MOUNT: Bolt-On  
Regular Non-Thermal



**21049**  
ROT: CW/CCW MOUNT: Bolt-On  
Regular Non-Thermal



**21060**  
ROT: CW/CCW MOUNT: Screw-On  
Regular Non-Thermal



**21061**  
ROT: CW/CCW MOUNT: Screw-On  
Regular Non-Thermal



**21064**  
ROT: CW/CCW MOUNT: Screw-On  
Regular Non-Thermal



**21161**  
ROT: CW/CCW MOUNT: Screw-On  
Regular Non-Thermal



**22010**  
ROT: CW MOUNT: Bolt-On  
Small Import Thermal



**22011**  
ROT: CW MOUNT: Bolt-On  
Regular Thermal



**22012**  
ROT: CW MOUNT: Bolt-On  
Regular Thermal



**22013**  
ROT: CW MOUNT: Bolt-On  
Small Import Thermal



**22015**  
ROT: CW MOUNT: Bolt-On  
Large Import Thermal



**22016**  
ROT: CW MOUNT: Bolt-On  
Regular Thermal



**22017**  
ROT: CW MOUNT: Bolt-On  
Regular Thermal



**22018**  
ROT: CW MOUNT: Bolt-On  
Regular Thermal



**22019**  
ROT: CW MOUNT: Bolt-On  
Large Import Thermal



**22020**  
ROT: CW MOUNT: Bolt-On  
Large Import Thermal



**22021**  
ROT: CW MOUNT: Bolt-On  
Large Import Thermal



**22022**  
ROT: CCW MOUNT: Bolt-On  
Large Import Thermal



**22023**  
ROT: CW MOUNT: Screw-On  
Heavy Duty Thermal



**22025**  
ROT: CW MOUNT: Bolt-On  
Large Import Thermal



**22026**  
ROT: CW MOUNT: Bolt-On  
Regular Thermal



**22027**

ROT: CW MOUNT: Bolt-On  
Large Import Thermal



**22029**

ROT: CW MOUNT: Bolt-On  
Large Import Thermal



**22030**

ROT: CW MOUNT: Bolt-On  
Small Import Thermal



**22031**

ROT: CW MOUNT: Bolt-On  
Large Import Thermal



**22032**

ROT: CW MOUNT: Bolt-On  
Large Import Thermal



**22033**

ROT: CW MOUNT: Bolt-On  
Large Import Thermal



**22037**

ROT: CW MOUNT: Bolt-On  
Regular Thermal

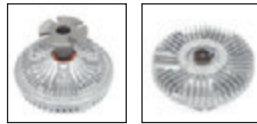

**22038**

ROT: CW MOUNT: Bolt-On  
Regular Thermal



**22041**

ROT: CW MOUNT: Bolt-On  
Heavy Duty Thermal



**22042**

ROT: CW MOUNT: Bolt-On  
Regular Thermal



**22043**

ROT: CW MOUNT: Bolt-On  
Regular Thermal



**22044**

ROT: CW MOUNT: Bolt-On  
Regular Thermal



**22045**

ROT: CW MOUNT: Bolt-On  
Heavy Duty Thermal



**22048**

ROT: CW MOUNT: Bolt-On  
Regular Thermal



**22049**

ROT: CW MOUNT: Bolt-On  
Regular Thermal



**22051**

ROT: CW MOUNT: Bolt-On  
Heavy Duty Thermal



**22052**

ROT: CW MOUNT: Bolt-On  
Heavy Duty Thermal



**22054**

ROT: CW MOUNT: Bolt-On  
Heavy Duty Thermal



**22056**

ROT: CW MOUNT: Bolt-On  
Regular Thermal



**22059**

ROT: CW MOUNT: Screw-On  
Heavy Duty Thermal



**22060**

ROT: CW MOUNT: Screw-On  
Regular Thermal



**22061**

ROT: CW MOUNT: Screw-On  
Regular Thermal



**22063**

ROT: CW MOUNT: Screw-On  
Regular Thermal



**22064**

ROT: CW MOUNT: Screw-On  
Regular Thermal



**22065**

ROT: CW MOUNT: Screw-On  
Regular Thermal



**22067**

ROT: CW MOUNT: Screw-On  
Small Import Thermal





**22068**

ROT: CW MOUNT: Bolt-On  
Small Import Thermal



**22086**

ROT: CW MOUNT: Bolt-On  
Small Import Thermal



**22070**

ROT: CW MOUNT: Screw-On  
Heavy Duty Thermal



**22087**

ROT: CW MOUNT: Bolt-On  
Small Import Thermal



**22071**

ROT: CW MOUNT: Screw-On  
Small Import Thermal



**22088**

ROT: CW MOUNT: Bolt-On  
Small Import Thermal



**22072**

ROT: CW MOUNT: Bolt-On  
Regular Thermal



**22090**

ROT: CW MOUNT: Bolt-On  
Large Import Thermal

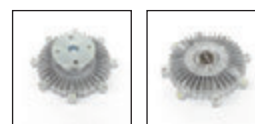

**22073**

ROT: CW MOUNT: Bolt-On  
Large Import Thermal



**22091**

ROT: CW MOUNT: Bolt-On  
Large Import Thermal



**22074**

ROT: CW MOUNT: Bolt-On  
Large Import Thermal



**22092**

ROT: CW MOUNT: Bolt-On  
Small Import Thermal



**22075**

ROT: CW MOUNT: Bolt-On  
Large Import Thermal



**22093**

ROT: CW MOUNT: Bolt-On  
Small Import Thermal



**22076**

ROT: CW MOUNT: Bolt-On  
Large Import Thermal



**22094**

ROT: CW MOUNT: Bolt-On  
Small Import Thermal



**22078**

ROT: CW MOUNT: Screw-On  
Heavy Duty Thermal



**22096**

ROT: CW MOUNT: Bolt-On  
Small Import Thermal



**22080**

ROT: CW MOUNT: Bolt-On  
Small Import Thermal



**22098**

ROT: CW MOUNT: Bolt-On  
Large Import Thermal

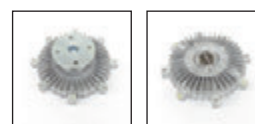

**22081**

ROT: CW MOUNT: Bolt-On  
Small Import Thermal



**22099**

ROT: CW MOUNT: Screw-On  
Large Import Thermal

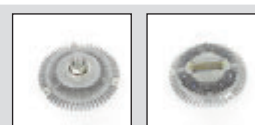

**22082**

ROT: CW MOUNT: Bolt-On  
Small Import Thermal



**22123**

ROT: CCW MOUNT: Screw-On  
Heavy Duty Thermal



**22085**

ROT: CW MOUNT: Bolt-On  
Large Import Thermal

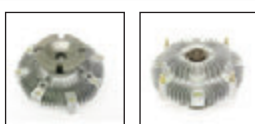

**22126**

ROT: CCW MOUNT: Bolt-On  
Regular Thermal



**22135**

ROT: CCW MOUNT: Screw-On  
Large Import Thermal



**22136**

ROT: CCW MOUNT: Screw-On  
Regular Thermal



**22139**

ROT: CCW MOUNT: Screw-On  
Heavy Duty Thermal



**22140**

ROT: CCW MOUNT: Bolt-On  
Heavy Duty Thermal



**22142**

ROT: CCW MOUNT: Bolt-On  
Regular Thermal



**22143**

ROT: CCW MOUNT: Bolt-On  
Regular Thermal



**22145**

ROT: CCW MOUNT: Bolt-On  
Heavy Duty Thermal



**22146**

ROT: CCW MOUNT: Bolt-On  
Heavy Duty Thermal



**22147**

ROT: CCW MOUNT: Bolt-On  
Regular Thermal



**22148**

ROT: CCW MOUNT: Bolt-On  
Regular Thermal



**22149**

ROT: CCW MOUNT: Bolt-On  
Regular Thermal



**22150**

ROT: CCW MOUNT: Screw-On  
Regular Thermal



**22151**

ROT: CCW MOUNT: Screw-On  
Regular Thermal



**22152**

ROT: CCW MOUNT: Screw-On  
Regular Thermal



**22153**

ROT: CCW MOUNT: Bolt-On  
Regular Thermal



**22154**

ROT: CCW MOUNT: Bolt-On  
Heavy Duty Thermal



**22155**

ROT: CCW MOUNT: Screw-On  
Regular Thermal

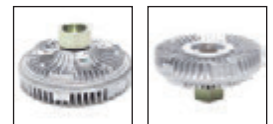

**22156**

ROT: CCW MOUNT: Bolt-On  
Regular Thermal



**22157**

ROT: CCW MOUNT: Screw-On  
Regular Thermal



**22158**

ROT: CCW MOUNT: Screw-On  
Heavy Duty Thermal



**22159**

ROT: CCW MOUNT: Screw-On  
Heavy Duty Thermal



**22160**

ROT: CCW MOUNT: Screw-On  
Regular Thermal



**22161**

ROT: CCW MOUNT: Screw-On  
Regular Thermal



**22162**

ROT: CCW MOUNT: Screw-On  
Regular Thermal



**22163**

ROT: CCW MOUNT: Screw-On  
Regular Thermal



**22164**

ROT: CCW MOUNT: Screw-On  
Regular Thermal



**22165**

ROT: CCW MOUNT: Screw-On  
Regular Thermal



**22166**

ROT: CCW MOUNT: Screw-On  
Regular Thermal



**22167**

ROT: CCW MOUNT: Screw-On  
Regular Thermal



**22168**

ROT: CCW MOUNT: Screw-On  
Heavy Duty Thermal



**22169**

ROT: CCW MOUNT: Screw-On  
Heavy Duty Thermal



**22170**

ROT: CCW MOUNT: Screw-On  
Heavy Duty Thermal



**22171**

ROT: CCW MOUNT: Screw-On  
Regular Thermal



**22173**

ROT: CCW MOUNT: Screw-On  
Heavy Duty Thermal



**22174**

ROT: CCW MOUNT: Bolt-On  
Heavy Duty Thermal



**22175**

ROT: CCW MOUNT: Bolt-On  
Large Import Thermal



**22176**

ROT: CCW MOUNT: Bolt-On  
Large Import Thermal



**22177**

ROT: CCW MOUNT: Bolt-On  
Large Import Thermal



**22178**

ROT: CCW MOUNT: Bolt-On  
Large Import Thermal

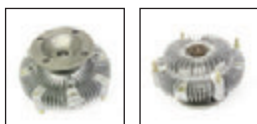

**22179**

ROT: CCW MOUNT: Bolt-On  
Small Import Thermal



**22181**

ROT: CCW MOUNT: Bolt-On  
Large Import Thermal

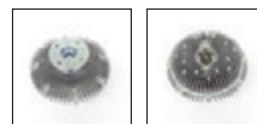

**22182**

ROT: CCW MOUNT: Bolt-On  
Large Import Thermal



**22183**

ROT: CCW MOUNT: Bolt-On  
Large Import Thermal



**22184**

ROT: CCW MOUNT: Bolt-On  
Large Import Thermal



**22185**

ROT: CCW MOUNT: Bolt-On  
Large Import Thermal



**22296**

ROT: CW MOUNT: Bolt-On  
Large Import Thermal



**22301**

ROT: CW MOUNT: Thru Hole  
Large Import Thermal



**22302**

ROT: CW MOUNT: Screw-On  
Small Import Thermal



**22303**

ROT: CW MOUNT: Screw-On  
Small Import Thermal

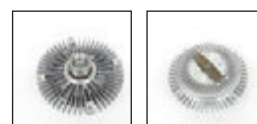

**22305**

ROT: CW MOUNT: Screw-On  
Large Import Thermal



**22306**

ROT: CW MOUNT: Thru Hole  
Large Import Thermal



**22307**

ROT: CCW MOUNT: Thru Hole  
Large Import Thermal





**22308**

ROT: CW MOUNT: Screw-On  
Large Import Thermal

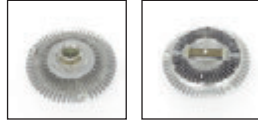
**22326**

ROT: CW MOUNT: Screw-On  
Large Import Thermal

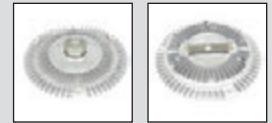
**22310**

ROT: CCW MOUNT: Screw-On  
Electric

**22327**

ROT: CW MOUNT: Thru Hole  
Large Import Thermal

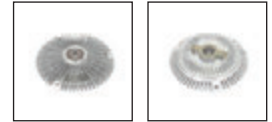
**22311**

ROT: CCW MOUNT: Screw-On  
Small Import Thermal

**22328**

ROT: CCW MOUNT: Thru Hole  
Large Import Thermal

**22313**

ROT: CW MOUNT: Thru Hole  
Large Import Thermal

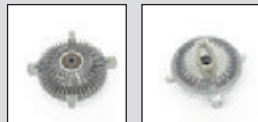
**22329**

ROT: CW MOUNT: Screw-On  
Electric

**22316**

ROT: CW MOUNT: Screw-On  
Large Import Thermal

**22330**

ROT: CCW MOUNT: Screw-On  
Electric

**22318**

ROT: CCW MOUNT: Thru Hole  
Large Import Thermal

**22331**

ROT: CCW MOUNT: Screw-On  
Electric

**22319**

ROT: CW MOUNT: Bolt-On  
Small Import Thermal

**22332**

ROT: CCW MOUNT: Screw-On  
Electric

**22320**

ROT: CCW MOUNT: Thru Hole  
Large Import Thermal

**22333**

ROT: CW MOUNT: Screw-On  
Large Import Thermal

**22321**

ROT: CCW MOUNT: Screw-On  
Large Import Thermal

**22334**

ROT: CCW MOUNT: Screw-On  
Large Import Thermal

**22322**

ROT: CCW MOUNT: Thru Hole  
Large Import Thermal

**22335**

ROT: CCW MOUNT: Thru Hole  
Large Import Thermal

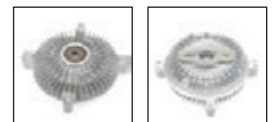
**22323**

ROT: CCW MOUNT: Thru Hole  
Large Import Thermal

**22337**

ROT: CCW MOUNT: Screw-On  
Large Import Thermal

**22324**

ROT: CCW MOUNT: Screw-On  
Large Import Thermal

**22338**

ROT: CCW MOUNT: Screw-On  
Electric

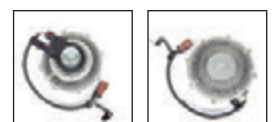
**22325**

ROT: CCW MOUNT: Screw-On  
Large Import Thermal

**22339**

ROT: CCW MOUNT: Screw-On  
Electric





<b>22340</b> ROT: CCW Electric	MOUNT: Screw-On		
<b>22341</b> ROT: CW Electric	MOUNT: Screw-On	<b>PHOTO NOT AVAILABLE</b>	<b>PHOTO NOT AVAILABLE</b>
<b>22342</b> ROT: CW Electric	MOUNT: Screw-On	<b>PHOTO NOT AVAILABLE</b>	<b>PHOTO NOT AVAILABLE</b>
<b>22373</b> ROT: CW Large Import Thermal	MOUNT: Bolt-On		
<b>22396</b> ROT: CW Large Import Thermal	MOUNT: Bolt-On		
<b>22399</b> ROT: CW Heavy Duty Thermal	MOUNT: Screw-On		
<b>22401</b> ROT: CW Small Import Thermal	MOUNT: Bolt-On		
<b>22402</b> ROT: CW Large Import Thermal	MOUNT: Bolt-On		
<b>22404</b> ROT: CW Small Import Thermal	MOUNT: Bolt-On		
<b>22405</b> ROT: CW Small Import Thermal	MOUNT: Bolt-On		
<b>22406</b> ROT: CW Small Import Thermal	MOUNT: Bolt-On		
<b>22407</b> ROT: CW Large Import Thermal	MOUNT: Bolt-On		
<b>22408</b> ROT: CW Large Import Thermal	MOUNT: Bolt-On		

<b>22496</b> ROT: CW Large Import Thermal	MOUNT: Bolt-On		
<b>22601</b> ROT: CW Truck Drive Thermal	MOUNT: Screw-On		
<b>22602</b> ROT: CW Truck Drive Thermal	MOUNT: Bolt-On		
<b>22605</b> ROT: CCW Truck Drive Thermal	MOUNT: Bolt-On		
<b>22606</b> ROT: CCW Truck Drive Thermal	MOUNT: Bolt-On		
<b>22607</b> ROT: CW Truck Drive Thermal	MOUNT: Screw-On		
<b>22609</b> ROT: CCW Truck Drive Thermal	MOUNT: Screw-On		
<b>22610</b> ROT: CCW Truck Drive Thermal	MOUNT: Screw-On		
<b>22611</b> ROT: CCW Truck Drive Thermal	MOUNT: Screw-On		
<b>22612</b> ROT: CCW Truck Drive Thermal	MOUNT: Screw-On		
<b>22613</b> ROT: CCW Truck Drive Thermal	MOUNT: Bolt-On		
<b>22614</b> ROT: CCW Truck Drive Thermal	MOUNT: Screw-On		
<b>22615</b> ROT: CCW Truck Drive Thermal	MOUNT: Screw-On		

**FAN CLUTCHES**

**22616**

ROT: CW MOUNT: Screw-On  
Truck Drive Thermal



**22617**

ROT: CCW MOUNT: Screw-On  
Truck Drive Thermal



**22618**

ROT: CCW MOUNT: Screw-On  
Truck Drive Thermal



**22620**

ROT: CCW MOUNT: Screw-On  
Truck Drive Thermal



**22621**

ROT: CCW MOUNT: Screw-On  
Truck Drive Thermal

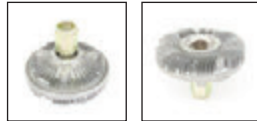

**22625**

ROT: CCW MOUNT: Screw-On  
Truck Drive Thermal



**22626**

ROT: CCW MOUNT: Screw-On  
Truck Drive Thermal



**22627**

ROT: CCW MOUNT: Screw-On  
Truck Drive Thermal



**22628**

ROT: CW MOUNT: Screw-On  
Truck Drive Thermal



**22063EX**

ROT: CW MOUNT: Screw-On  
Regular Thermal



**22409**

ROT: CCW MOUNT: Bolt-On  
Large Import Thermal



**22410**

ROT: CCW MOUNT: Bolt-On  
Large Import Thermal





---

# DNV BUSINESS ASSURANCE

---

# MANAGEMENT SYSTEM CERTIFICATE

---

Certificate No. 86529-2010-AQ-USA-ANAB

*This is to certify that*

**US Motor Works**

*at*

14722 Anson Avenue, Santa Fe Springs, CA 90670 USA

*has been found to conform to the Management System Standard:*

**ISO 9001:2008**

*This Certificate is valid for the following product or service ranges:*

**Manufacturing of Automotive Components for OEM and Aftermarket Products.**

*Initial Certification date:*

October 18, 2010

*This Certificate is valid until:*

October 18, 2016

*The audit has been performed under the supervision of*

Roy Celestino  
*Lead Auditor*



*Place and date:*

Houston, Texas, October 18, 2013

*for the Accredited Unit:*

DET NORSKE VERITAS  
CERTIFICATION INC., HOUSTON TEXAS

John Stefan  
*Management Representative*

Lack of fulfillment of conditions as set out in the Certification Agreement may render this Certificate invalid.

ACCREDITED UNIT: DET NORSKE VERITAS CERTIFICATION, INC 1400 RAVELLO DRIVE, 77449, KATY, TX, USA, TEL: 281-396-1000, [WWW.DNVCERT.COM](http://WWW.DNVCERT.COM)



**1995**

US Motor Works was founded in  
Commerce, CA

**1999**

Moved to Cerritos, CA and Began  
Making Fan Clutches

**2006**

Experiences 40% Annual Growth and  
Expanded Its Facilities

**2007**

Opened Engineering Facility  
in China

**2009**

Moved to Santa Fe Springs, CA

**2011**

Timing Kits with Water Pumps  
are Added

**1997**

Scaled Up Manufacturing of Water  
Pumps to 30,000/month

**2005**

Entered into Joint Venture with  
Manufacturers Abroad

**2007**

Production Reached One Million  
Water Pumps per Year

**2008**

Development and Distribution  
of Electric Fuel Pumps

**2010**

Became ISO 9001:2008 Certified

**2012**

Launched Domestic Ad Campaign

**2014**

Heavy Duty Line Expanded to Include Oil  
Pumps and Mechanical Transfer Pumps





US MOTOR WORKS, LLC  
14722 Anson Avenue  
Santa Fe Springs, CA 90670 USA  
Tel: 562-404-0488  
Fax: 562-404-8770  
INFO@USMOTORWORKS.COM  
WWW.USMOTORWORKS.COM

