

Heavy Duty

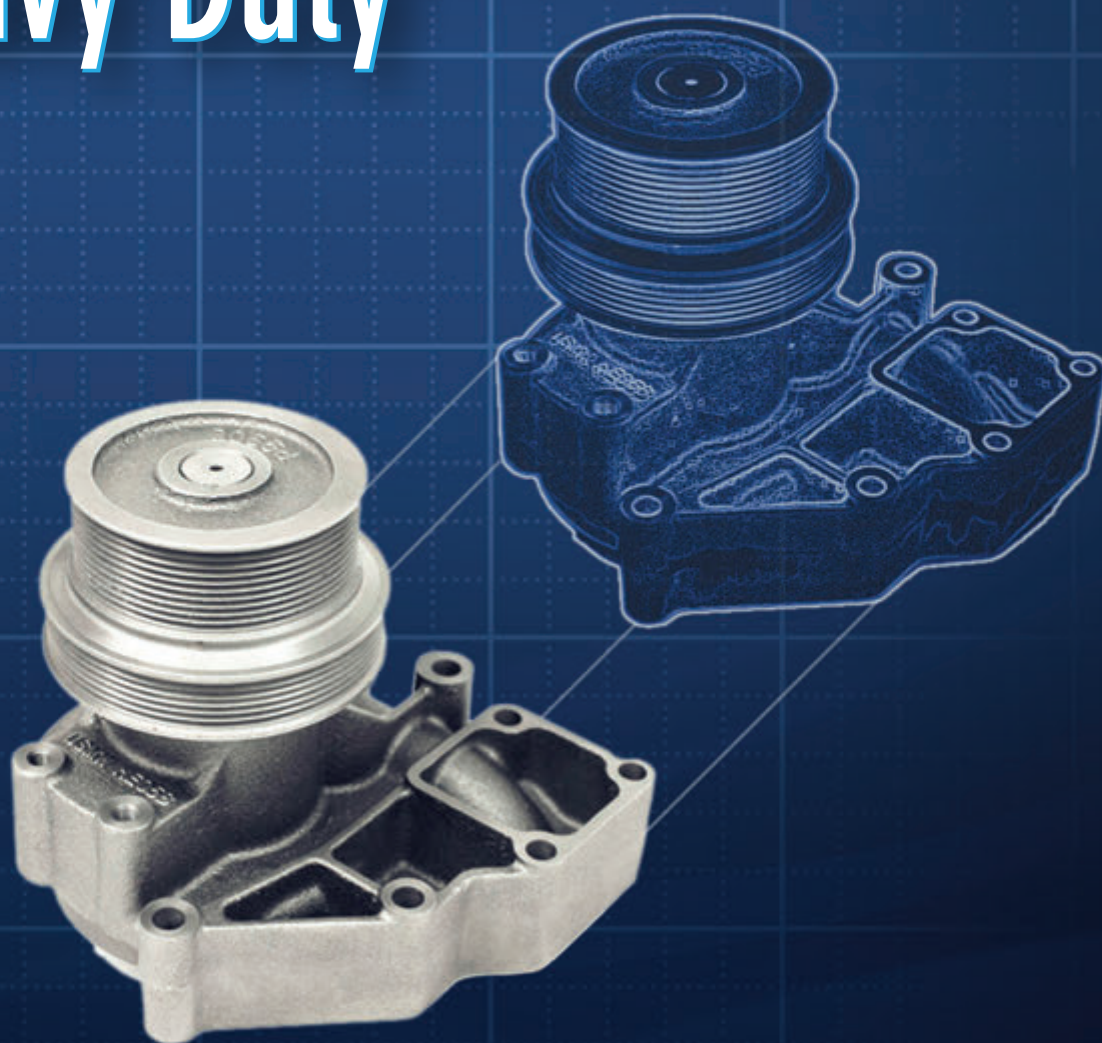

WATER PUMPS | OIL PUMPS | FUEL PUMPS | FAN CLUTCHES | IDLERS | SHUT DOWN VALVES

USMW

Professional Series



US Motor Works has combined the strengths of a technologically oriented manufacturer, superior sales and service organization with a sophisticated global distribution network to keep our company on the forefront of the automotive marketplace.

With the focus of providing Automotive and Heavy-Duty engine parts and components, US Motor Works is constantly looking for ways to support its customers by increasing the availability of quality parts and components. Currently, US Motor Works manufactures a complete line of Automotive Cooling parts, Fuel Pumps and Heavy-Duty parts.

Precision engineering and manufacturing are essential to creating quality products you can depend on. At US Motor Works, quality begins with highly skilled engineers utilizing materials that meet or exceed OEM specifications, highly complex computer assisted design tools and state of the art equipment to manufacture premium parts.

Our specially trained technician's apply stringent quality control standards utilizing sophisticated technology to make sure that all US Motor Works products meet the rigorous demands of our customers. When you buy US Motor Works manufactured items, you are investing in technology that has been meticulously engineered, manufactured from the highest quality materials and thoroughly tested to assure accuracy, reliability and workmanship.

With more than 100 years of combined experience, we are committed to providing an extensive line of high quality products, the finest customer service and the best support program available in the automotive and heavy-duty market.



TABLE OF CONTENTS

Heavy Duty

Application Guide	5
Quick Reference	32
Cross Reference	42

HEAVY DUTY

All Manufacturers names, numbers, symbols and descriptions are used for reference purposes only, and in no way does it imply that any parts listed in this catalog are the products of these manufacturers.

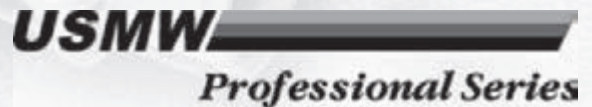



WARRANTY POLICY

US Motor Works, LLC

- USMW brand of US Motor Works, LLC products are warranted to be free from defects in material and manufacture, under normal use and service
- US Motor Works coverage will extend a full 12 months from the date of installation in an engine regardless of mileage or hours.
- US Motor Works will cover (replace free of charge or pay for) all labor and parts needed to repair the warrantable failure, including progressive damage to the engine concerned.

Conditions of the warranty are:

1. US Motor Works must be notified by the customer before filing a warranty claim.
2. All warranty claims must be in writing and US Motor Works reserves the right to examine every single engine or part subject to a claim under this warranty
3. Price of parts will be based on the US Motor Works current price list or other accepted suppliers at US Motor Work's option. Cost of labor will be of reasonable hourly flat rate (overtime or holiday rates are not accepted).

The warranty is also subject to the following limitations:

1. The provisions of this warranty shall not apply to any US Motor Works (USMW) brand part altered from its original specification (including but not limited to alterations in packaging and/or markings) or which has been misused, exposed to weather conditions, negligence or damage by accident.
2. The warranty shall be null and void, if the engine or vehicle is not maintained to the suggested OEM level. All receipts and records should be accounted for in the event it is requested for the warranty analysis.
3. This warranty is provided solely to direct customers of the US Motor Works and not any other party. It is the only agreement or obligation of US Motor Works. All other warranties, expressed or implied, including the warranties of merchantability and/or fitness for a particular purpose, are excluded.

US Motor Works, LLC

14722 Anson Ave.

Santa Fe Springs, CA 90670 USA

Tel (562) 404-0488 Fax (562) 404-8770

www.usmotorworks.com



DNV BUSINESS ASSURANCE MANAGEMENT SYSTEM CERTIFICATE

Certificate No. 86529-2010-AQ-USA-ANAB

This is to certify that

US Motor Works

at

14722 Anson Avenue, Santa Fe Springs, CA 90670 USA

has been found to conform to the Management System Standard:

ISO 9001:2008

This Certificate is valid for the following product or service ranges:

Manufacturing of Automotive Components for OEM and Aftermarket Products.

Initial Certification date:

October 18, 2010

This Certificate is valid until:

October 18, 2016

The audit has been performed under the supervision of

Roy Celestino
Lead Auditor

Place and date:

Houston, Texas, October 18, 2013

for the Accredited Unit:

**DET NORSKE VERITAS
CERTIFICATION INC., HOUSTON TEXAS**

John Stefan
Management Representative

Lack of fulfillment of conditions as set out in the Certification Agreement may render this Certificate invalid.

ACCREDITED UNIT: DET NORSKE VERITAS CERTIFICATION, INC 1400 RAVELLO DRIVE, 77449, KATY, TX, USA, TEL: 281-396-1000, www.dnvcert.com

HEAVY DUTY

HEAVY DUTY WATER PUMPS





USMW Heavy Duty Water Pumps are designed to the latest OE specifications. All product applications have been designed and tested to meet or exceed original equipment specifications. Our advanced research has implemented the use of the latest designed impellers, hubs, bearings and seals that will provide optimum cooling with performance and longevity. We use the highest quality material to create a stronger body design with less corrosion.



GENERAL FEATURES:

- * 100% Leak tested and hub-pull tested to our high quality standards.
- * Designed and manufactured with the best NEW unitized seals to ensure long, trouble-free performance.
- * Each unit uses bearings designed as specified by the original equipment manufacturer to meet specific radial torque and axial load requirements of each application to give long bearing life.
- * Every Water Pump is supplied with a quality mounting gasket and other accessories (seals/gaskets) necessary to properly complete the installation.
- * Manufactured to original casting specifications for proper fit, easy installation and proper water flow for maximum cooling.











ENGINE DESCRIPTION	USMW	REPLACES OEM	ILLUSTRATION
CASE			
WATER PUMP			
L4 3.1L, 188 3.4L 207, Forklift, Ag.	US2024	A146584	
CATERPILLAR			
BACK PLATE			
3406	BP2093	7C9222	
OIL PUMP			
3406	USOP0733	4N0733, 1614111 4N4295	PHOTO NOT AVAILABLE
3116 / 3126	USOP8777	189-8777	PHOTO NOT AVAILABLE
3304/3306	USOP2448	4W2448, 2P1785 6I1346, 4P4020	
3406E, C15	USOP8734	4N8734, 1614113	PHOTO NOT AVAILABLE
C12	USOP5220	233-5220	

HEAVY DUTY

ENGINE DESCRIPTION	USMW	REPLACES OEM	ILLUSTRATION
WATER PUMP			
3066	US68	1252989	
3176	US71	1025844, 9Y4361	
3204	US1223	2W1223	
3300	US7760	1727760, 1550061 4P9862, 0R0997	
3300	US7765	1727765, 1550066 1157560, 0R1002	
3114, 3116T	US4508	7C4508, 352-2160 1318238, 0R0104 1593137	
3116 4.37" Pulley	US74	4P3683, 4W0253 OR3007, 9V4879 OR1013, 4P3683	
3116, 3126	US6248	352-2149, 126-8277	

ENGINE DESCRIPTION	USMW	REPLACES OEM	ILLUSTRATION
3126 3.75" Pulley	US75	1208402	
3208 with pulley	US2041	2W1225	
3208 With threaded pulley	US2043	2W1227	
3208 Witout Pulley	US2041NP	9N6147	
3304/3306	US7766	1727766, 2W8002 1550067, 7C7967 7N5908, 9Y6435	
3304/3306	US7767	1727767, 2W8001 1W3058, 1W3060 7N5909, 1550068	
3304/3306	US7775	1727775, 2P0661	
3304/3306	US7776	1727776, 2P0662	

HEAVY DUTY







ENGINE DESCRIPTION	USMW	REPLACES OEM	ILLUSTRATION
3406 B/C	US2035	7C4957, 7W7019 OR8217, 1354926	
3406 E	US2093	6I3890, 10R0483 OR4120, OR8218 OR8330, 3520212	
C12	US70	1767000	
C15	US6150	1615719, 10R0484 OR9869	
C15, C18 ACERT	US6342	3362213, 2807374 3520211	
C7 On-highway	US92	352-2109, 10R5407 227-8843, 227-4299	
C7, 3126B	US91	352-2139, 236-4413 10R4429	
C9, 3126E	US90	325-2080, 10R5406 227-4298, 200-1212 260-1546, 227-4300	







ENGINE DESCRIPTION	USMW	REPLACES OEM	ILLUSTRATION
CUMMINS			
FAN CLUTCH			
B Series (00-02 Dodge Ram Truck)	22616	5202 8894AA	
FUEL PUMP			
Diaphragm Fuel Pump	USFP4374	3904374, 5012 376AA 4429374, 4983584 3970080, 3966154 3928143, 3901425	
Diaphragm Fuel Pump	USFP0266	2830266, 84268475	
Fuel Transfer Pump	USFP6316	3936316, 4988747 3925709, 3930134 3932224, 3933252 4944710	
Fuel Transfer Pump	USFP6318	3936318, 3917998 3917999, 4988749 4944712, 3933254 3632226, 3930201	
Fuel Transfer Pump	USFP6319	3936319, 4988750 4944713, 3933255 3932227, 3930202	
Fuel Transfer Pump	USFP6320	3936320, 4988751 4944714, 3933256 3932228, 3930349	
Fuel Transfer Pump	USFP4319	3918000, 3914319	

ENGINE DESCRIPTION	USMW	REPLACES OEM	ILLUSTRATION
FUEL SOLENOID			
B Series 12V	USFS1167	3991167	
IDLER			
Big Cam	US2045	3064919, AR45189	
L10	US2602	3062602	
N14	US2096	3066330	
NT88 (Ford)	US2064	3065000	
NT88 Big Cam IV	US2065	3062931, 3053537	
Small Cam	US2021	3064920, AR8851	
OIL PUMP			
4B	USOP0336	3930336, 3937027 3926202, 3924719	

ENGINE DESCRIPTION	USMW	REPLACES OEM	ILLUSTRATION
4B helical	USOP9585	4939585, 3937027 3926202, 3924719	
4B spur	USOP9586	4939586, 3976087 5313086, 5273937	
6B	USOP0337	3930337, 3937404 3636203	
6B helical	USOP9587	4939587, 3937028 3932449	
6B spur	USOP9588	4939588, 3971544	
855 BIG CAM DFC	USOP1572	3821572	
855 HIGH PRESSURE	USOP0172	AR10172	
B Series 6.7 Liter	USOP7481	4897481	

HEAVY DUTY

ENGINE DESCRIPTION	USMW	REPLACES OEM	ILLUSTRATION
C Series 8.3L	USOP0338	3930338, 3800828 3926201, 3924644	
ISC	USOP6840	3966840	
ISL vented	USOP1464	4941464, 3991123	
ISX (Aluminum)	USOP1757	2881757, 4309500 4026691	PHOTO NOT AVAILABLE
M11, L10	USOP3950	4003950, 3401186 3895756, 3883910	
MY 03	USOP8801	4988801, 3973398 3957266, 3947308	
N14 Helical gear	USOP3369	3803369	
N14 straight gear	USOP3698	3803698	







ENGINE DESCRIPTION	USMW	REPLACES OEM	ILLUSTRATION
REPAIR KIT			
ISX	KT6151	4090022	
SEAL KIT			
L10 Front gear cover - 5 Hole	USGK3894	3803894	
L10 Front gear cover - 6 Hole	USGK3573	3803573	
SHUTDOWN VALVE			
12 V	USSV5342	3035342, 143793	
24 V	USSV5344	3035344, 143795 3035362	
SOLENOID COIL			
12 V	USSC4808	4024808, 3054611 3054608, 3408421	
24 V	USSC4809	4024809, 134074 3054610, 3054609	

HEAVY DUTY

ENGINE DESCRIPTION	USMW	REPLACES OEM	ILLUSTRATION
WATER PUMP			
855 Small Cam FFC (2 Groove pulley)	US2000	3807784, 3000886 AR45080, 3801784 AR45090	
B Series New Style	US7145N	3286275	
B Series New Style Hardened Pulley	US7145HN	3286277, 3003749 3913432, 3802358 3802004, 3802970	
B Series New Style ISB Engine	US7123H	3286278, 3285410 3285414	
Big Cam 855 NTC 290, 350, 400 (Multi-Groove pulley)	US2001	3022474, 3801788 AR45184	
Big Cam III NTC300, 350, 400, FORMULA 300, 350, 400, 475	US2044	3004923	
Big Cam IV 855 (Multi-Groove pulley) Vented	US2032	3801708, 3049543 AR45217	
Big Can III	US2060	3027174	









ENGINE DESCRIPTION	USMW	REPLACES OEM	ILLUSTRATION
C Series	US740	3913430	
C Series Long Nose	US740N	3800974, 3926912 3923568, 3285323	
C Series Long Nose Hardened Pulley	US740HN	3800976, 3285324 3925540, 3926914	
C Series Long Nose Marine Engine	US740NM	3800975	
C Series Short Nose	US740H	3806180, 3802081 3804883, F3HZ 8501-B	
Dina 155/210 Rear	US2054	34079-B05	
ISB Series (Plastic Impeller)	US6222	3800984, 4891252 2881804	
ISC / ISL	US69NX	4089647	

HEAVY DUTY

ENGINE DESCRIPTION	USMW	REPLACES OEM	ILLUSTRATION
ISX (10 groove pulley)	US6151	4089908	
ISX (12 groove pulley)	US6344	4089910, 3684449	
ISX, ISZ (12 groove pulley) Pump only	US93	3684450, 3683651	
LTA10 Series (Before 1991, 4 hole mount)	US2202	3803402, 3801840 3925540	
M11 & L10 E Series (1991 and Later 3 hole mount)	US2203	3803403, 4955705 4003929, 3800737	
M11 & L10 Short shaft	US2204	3800745	
N14	US2090	3803605, 3803361	
NH220	US2018	BM76506, 4919811	

ENGINE DESCRIPTION	USMW	REPLACES OEM	ILLUSTRATION
NH230 Pancake 5-1/2" Bore with pulley)	US2042	AR4284, 4919813	
NH230 Pancake 5-1/2" Bore without pulley)	US2002	AR4283, 4919814 196845	
NH250	US2033	AR51360, 4919815	
NHC250 Military (with Pulley)	US2033P	AR51333	
NT88 Big Cam IV - NTC300, 315, 350, 365, 400	US2062	3803138, 3803030 3062928, 3052386	
NTC 230	US2029	3801713, 3022471 4919820	
V8-210	US2048	AR61788, 4919812	
DAF			
WATER PUMP			
Model 85 CF, 95 XF XF 250 280 315	US16015	683386	

HEAVY DUTY

ENGINE DESCRIPTION	USMW	REPLACES OEM	ILLUSTRATION
Model 86 WS 242 286 295	US16014	682968	
DETROIT DIESEL			
OIL PUMP			
Series 60	USOP5886	23505886	
Series 60 EGR	USOP7448	23527448	
WATER PUMP			
53 Series (left hand)	US2603	23506003, 5144685	
53 Series (right hand)	US2607	23506007, 5144686	
53 Series Military Aluminum body	US2611	23506011, 5104392	
6 & 8V92	US2037	8922335	
8.2L (With heater outlet)	US2034	8928672	









ENGINE DESCRIPTION	USMW	REPLACES OEM	ILLUSTRATION
IL 71 LH	US1074	5149706, 23506723	
IL 71 LH HI-CAP	US2027	5149710, 23506704	
IL 71 RH	US1058	5149707, 23506735	
IL 71 RH HI-CAP	US2026	5149708, 23506711	
SERIES 60 - Front Mount, Gear Driven 1987-1990	US2094	23509067, 23505019 23514989	
SERIES 60 - Late and Series 50	US60	23505895, 23520136 R3518216	
SERIES 60 - Late and Series 50 (Kangaroo Pouch)	US60P	23526039, 23522721 23526039, 23522707	
Series 60 12.0L EGR	US2129	23532542, 23531257 23535017	









HEAVY DUTY

ENGINE DESCRIPTION	USMW	REPLACES OEM	ILLUSTRATION
Series 60 14.0L EGR	US2130	23532543, 23531258 23503518	
FORD/ INTERNATIONAL			
FAN CLUTCH			
83-96 6.9-7.3 diesel	22601	F2UZ 8A616-H	
92-97 6.9-7.3 diesel NON D.I.	22607	F4TZ 8A616-B	
94-98 7.3L D.I. Van Apps.	22609	F5TZ 8A616-KB	
98-03 VAN 7.3L D.I.	22612	F8UZ 8A616-AA	
99-03 Excursion 7.3L D.I.	22611	F81Z 8A616-DA	
WATER PUMP			
02-07 F650 - F750 6.0L Diesel VT365	US85	5C4Z 8501-AA 1845002C91 4C4Z 8501-AARM	
11-12 F250, F350, F450, F550 6.7L Diesel	US77	BC3Z 8501-A	

ENGINE DESCRIPTION	USMW	REPLACES OEM	ILLUSTRATION
6.0L Turbo diesel. Power stroke	US61	3C3Z 8501-BA 3C3Z 8501-ABRM	
6.0L Turbo diesel. Power stroke	US67	4C3Z 8501-AB F81Z 8501-ABRM 4C3Z 8501-ABRM	
6.4 Diesel F350/F450 2008 and up	US76	8C3Z 8501-B	
6.6L & 7.8L Diesel	US4071	F1HZ 8501-C	
6.6L & 7.8L Diesel W/ Mounted fan.	US4072	F1HZ 8501-D	
6.6L Brazil	US4062	E8HZ 8501-B E7HN 8A513 AB	
6.9l, 7.3L Diesel 94-96	US4096	F5TZ 8501-B 1812313C93 F5TZ 8501-C	
6.9l, 7.3L Diesel Power Stroke Turbo D.I.	US4114	F7TZ 8501-C 1831005C92 F6TZ 8501-AA F7TZ 8501-BRM F81Z 8501-A F81Z 8501-B F81Z 8501-CRM F7TZ 8501-C	

HEAVY DUTY

ENGINE DESCRIPTION	USMW	REPLACES OEM	ILLUSTRATION
6.9L, 7.3L Diesel Power Stroke Turbo D.I. (No tube)	US4114TL		
6.9L, 7.3L With 3/4" outlet	US4018	E9TZ 850-B E4TZ 8501 C	
7.3 Power Stroke	US66	1823669C92, 1831676C92 YC3Z 8501-AARM YC3Z 8501-CA 1831676C91	
GENERAL MOTORS			
FAN CLUTCH			
6.2L Diesel 82-93	22602	12517624	
6.5L Diesel 00-03	22614	15029405	
6.5L Diesel 92-93	22606	15671935	
6.5L Diesel 94-96	22605	15991496	
6.5L Diesel 97-99	22613	15022302	

ENGINE DESCRIPTION	USMW	REPLACES OEM	ILLUSTRATION
6.6L Diesel Duramax	22617	15130067	
WATER PUMP			
366	US5084	14002440, 10074182	
6.0L School Bus 7.0L School Bus C5-7 50 60 70 Series	US5078	12551474, 12529192 12520263, 12512740 10140667	
6.2L	US5008	23500133, 12514269 15633465	
6.5L	US5062	12514574, 15633466 12534417, 23500138	
6.5L	US5074	88894036, 5744662 12530176, 12534772	
6.5L	US5086	88894035	
6.6L, (Duramax)	US63	97216136	

HEAVY DUTY

ENGINE DESCRIPTION	USMW	REPLACES OEM	ILLUSTRATION
6.6L, (Duramax)	US72	97372515, 98031233	
7.4L School Bus Kodiak C6 C7 Bypass tube	US5094	12456328	
8.1L School Bus Kodiak 03-04 B7 01-02 C6, C7 C4500-8500	US5090	88893907	
INTERNATIONAL / NAVISTAR			
OIL PUMP			
DT466 1" GEAR	USOP2666	1802666C92	
DT466 1.25" GEAR	USOP8832	1808832C92	
WATER PUMP			
3L Off-Highway 2.5L 155; 2.9 179	US2059	3136217R92	
5.6L GAS 78-94 1924, 1925, 1954, 2125	US1099	270918C93, 463365C91 861236R92	
6.9L, 7.3L	US3705	1809374, 1809374C91 1805952C91	

ENGINE DESCRIPTION	USMW	REPLACES OEM	ILLUSTRATION
6.9L, 7.3L	US4096	1812313C93 F5TZ 8501-C F5TZ 8501-B	
9.0L	US3702	1700594, 1700594C91 1700594C92	
DT-414, DT-436, DT-466 Agriculture	US3707	673162, 673162C92	
DT-466	US3709	680899C92	
DT-466	US3711	3136053	
DT-466 CONV	US3710	685155C92, 685155C91 685155C95, 735327C91	
DT-466 New Gen	US3713	1817687C95, 1817687C94, 1817687C96 1817687C92	
DT-466 New Gen 04 +	US2128	1842664C91 1830607C4 1841764C2 1842664C92	









HEAVY DUTY

ENGINE DESCRIPTION	USMW	REPLACES OEM	ILLUSTRATION
DTA-360A & DT466 (left hand thread)	US3712	1815538, 1815538C91	
VT365 Navistar V8 Diesel 02-07	US85	1845002C91 4C4Z-8501-AARM 5C4Z-8501-AA	
ISUZU NPR			
WATER PUMP			
3.9L Diesel	US9302	8-97021-171-0 2911463250	
96-99 5.7L Chevrolet engine	US5077	8-12532-528-0	
MACK			
WATER PUMP			
Econdyne	US2046	316GC1210A 316GC1219 316GC4541A	
END-T 675 / 676	US2004	316GC1211A 316GC1184BX 316GC1211AX	
END-T 675 / 677	US2006	316GCA184 C/D/E	







ENGINE DESCRIPTION	USMW	REPLACES OEM	ILLUSTRATION
MAN			
WATER PUMP			
Model ***** D2865 LF24	US16008	51.06500.6546	
Model ***** F200 D2866 D2865 D2876	US16009	51.06500.9479	
Model ***** M2000 D0826	US16010	51.06500.6554	
Model ***** D2866 D2840 D2066	US16006	51.06500.6408	
Model ***** D866	US16004	51.06500.6616	
Model ***** D876	US16001	51.06500.7036	
Model 18.320, 18.350, 18.390, 18.430, TGA D2066	US16005	51.06500.7049	
Model F2000 D2865 D2866	US16007	51.06500.6547	

HEAVY DUTY

ENGINE DESCRIPTION	USMW	REPLACES OEM	ILLUSTRATION
MERCEDES			
WATER PUMP			
2002-2003 Sprinter L5 2.7L	US6008	611 200 05 01 611 220 01 10 A611 200 11 01 5103 576AB 5103 576AA 611 200 11 01	
2004-2007 Sprinter L5 2.7L	US6007	A642 200 13 01 5138 057AA 647 200 01 01	
Actros 1831 1835 1840 1853 2035 OM541 OM542	US16011	541 200 01 01	
Actros 1843 1848 1853 1857 2035 OM541 OM542	US16012	542 200 17 01	
Atego OM904	US16013	904 200 04 01 904 200 49 01 904 200 0 01 904 200 08 01 904 200 2601 904 201 02 01	
Bus/Truck OM366 1992-1986 OM256 OM366 (Short)	US2058	A366 200 0601	
OM366 (Long) OM366 1991-1993 (No Back Plate)	US2067	A366 200 6801	
OM366 (Long) OM366 1991-1993 (With Back Plate)	US2067BP	A366 200 6801	

ENGINE DESCRIPTION	USMW	REPLACES OEM	ILLUSTRATION
OM366 1979-1992 D-1521 Bus Marco-Polo	US2124	A390 200 01 01	
OM906 LA, OM924 LA, OM926 LA	US16018	906 200 63 01 906 200 51 01 906 200 43 01 906 200 40 01	
U3000, U5000, OM900 OM906	US16000	A906 200 1401 906 200 1401, 906 200 2201 906 200 2911 906 200 5401 906 200 6101	
PERKINS			
OIL PUMP			
3.152	USOP4078	41314078, 41314178 41314187	
4.236	USOP4182	41314182, 41314054 41314061	
6.354	USOP4067	41314067, 41314131 736012M91	
4.40T	USOP056	4131 F056, 4222282M91 610912	
Phaser 1000 / 1006	USOP057	4131 F057, 4132 F023 4132 F029	

ENGINE DESCRIPTION	USMW	REPLACES OEM	ILLUSTRATION
WATER PUMP			
236 431L Low Pump	US2056	236-57-31	
3A-153	US2019	41312159, 41312487	
4-212, 4-236, 4-238	US2023	41312143, 41313201 12494050, 236-4-84 21312201	
6-354 & 6-354T	US2022	41212691, 41312479 41313018	
L4 3.5L 212, 3.9L 236, 4.1L 248 Veh-Pulley	US2053	41312201, 41312320	
L6 5.8L Phase I and II - 4 Bolt Pulley	US2049	41311707, 41312479	
Phase IV - No Pulley	US2055	41313047	
Phase IV, Turbo - No Pulley	US2057	41313048	

ENGINE DESCRIPTION	USMW	REPLACES OEM	ILLUSTRATION
Phaser 6 CYL. 6.60 6.60CC 180 DIESEL Dodge / Navistar	US2068	4131 E011, U5MW0092 U5MW0160	
SCANIA			
WATER PUMP			
Model 114 124 DSC 11 DCS 12	US16016	1 057 0951, 1508533 1353072	
Model 114 DCS 14	US16017	1 057 0952, 1508534 1365841	
THERMOKING			
WATER PUMP			
2.2L ISUZU - D.I.	US801	11-5252, 11-9356	
C201 Isuzu engine	US2039	11-4576	
VOLVO			
WATER PUMP			
Model FL 12 D12 C	US16003	814 99 41	
Model FL10 FL 12 D12A	US16002	20 734 268, 20 734 268	

USMW #	MAKE	OE INTERCHANGE	PRODUCT TYPE
22601	FORD/ INTERNATIONAL	F2UZ 8A616-H	FAN CLUTCH
22602	GENERAL MOTORS	12517624	FAN CLUTCH
22605	GENERAL MOTORS	15991496	FAN CLUTCH
22606	GENERAL MOTORS	15671935	FAN CLUTCH
22607	FORD/ INTERNATIONAL	F4TZ 8A616-B	FAN CLUTCH
22609	FORD/ INTERNATIONAL	F5TZ 8A616-KB	FAN CLUTCH
22611	FORD/ INTERNATIONAL	F81Z 8A616-DA	FAN CLUTCH
22612	FORD/ INTERNATIONAL	F8UZ 8A616-AA	FAN CLUTCH
22613	GENERAL MOTORS	15022302	FAN CLUTCH
22614	GENERAL MOTORS	15029405	FAN CLUTCH
22616	CUMMINS	5202 8894AA	FAN CLUTCH
22617	GENERAL MOTORS	15130067	FAN CLUTCH
BP2093	CATERPILLAR	7C9222	BACK PLATE
KT6151	CUMMINS	4090022	REPAIR KIT
US60	DETROIT DIESEL	23505895	WATER PUMP
US60	DETROIT DIESEL	23520136	WATER PUMP
US60	DETROIT DIESEL	R3518216	WATER PUMP
US60P	DETROIT DIESEL	23526039	WATER PUMP
US60P	DETROIT DIESEL	23522721	WATER PUMP
US60P	DETROIT DIESEL	23526039	WATER PUMP
US60P	DETROIT DIESEL	23522707	WATER PUMP
US61	FORD/ INTERNATIONAL	3C3Z 8501-BA	WATER PUMP
US61	FORD/ INTERNATIONAL	3C3Z 8501-ABRM	WATER PUMP
US63	GENERAL MOTORS	97216136	WATER PUMP
US66	FORD/ INTERNATIONAL	1823669C92	WATER PUMP
US66	FORD/ INTERNATIONAL	1831676C91	WATER PUMP
US66	FORD/ INTERNATIONAL	1831676C92	WATER PUMP
US66	FORD/ INTERNATIONAL	YC3Z 8501-AARM	WATER PUMP
US66	FORD/ INTERNATIONAL	YC3Z 8501-CA	WATER PUMP
US67	FORD/ INTERNATIONAL	4C3Z 8501-AB	WATER PUMP
US67	FORD/ INTERNATIONAL	4C3Z 8501-ABRM	WATER PUMP
US67	FORD/ INTERNATIONAL	F81Z 8501-ABRM	WATER PUMP
US68	CATERPILLAR	1252989	WATER PUMP
US69NX	CUMMINS	4089647	WATER PUMP
US70	CATERPILLAR	1767000	WATER PUMP
US71	CATERPILLAR	1025844	WATER PUMP
US71	CATERPILLAR	9Y4361	WATER PUMP
US72	GENERAL MOTORS	97372515	WATER PUMP
US72	GENERAL MOTORS	98031233	WATER PUMP
US74	CATERPILLAR	4P3683	WATER PUMP
US74	CATERPILLAR	4W0253	WATER PUMP
US74	CATERPILLAR	OR3007	WATER PUMP
US74	CATERPILLAR	9V4879	WATER PUMP
US74	CATERPILLAR	OR1013	WATER PUMP
US74	CATERPILLAR	4P3683	WATER PUMP
US75	CATERPILLAR	1208402	WATER PUMP
US76	FORD/ INTERNATIONAL	8C3Z 8501-B	WATER PUMP
US77	FORD/ INTERNATIONAL	BC3Z 8501-A	WATER PUMP
US85	FORD/ INTERNATIONAL	5C4Z 8501-AA	WATER PUMP
US85	FORD/ INTERNATIONAL	4C4Z 8501-AARM	WATER PUMP
US85	FORD/ INTERNATIONAL	1845002C91	WATER PUMP
US90	CATERPILLAR	325-2080	WATER PUMP
US90	CATERPILLAR	10R5406	WATER PUMP

USMW #	MAKE	OE INTERCHANGE	PRODUCT TYPE
US90	CATERPILLAR	227-4298	WATER PUMP
US90	CATERPILLAR	200-1212	WATER PUMP
US90	CATERPILLAR	260-1546	WATER PUMP
US90	CATERPILLAR	227-4300	WATER PUMP
US91	CATERPILLAR	352-2139	WATER PUMP
US91	CATERPILLAR	236-4413	WATER PUMP
US91	CATERPILLAR	10R4429	WATER PUMP
US92	CATERPILLAR	352-2109	WATER PUMP
US92	CATERPILLAR	10R5407	WATER PUMP
US92	CATERPILLAR	227-8843	WATER PUMP
US92	CATERPILLAR	227-4299	WATER PUMP
US93	CUMMINS	3684450	WATER PUMP
US93	CUMMINS	3683651	WATER PUMP
US740	CUMMINS	3913430	WATER PUMP
US740H	CUMMINS	3806180	WATER PUMP
US740H	CUMMINS	3802081	WATER PUMP
US740H	CUMMINS	3804883	WATER PUMP
US740H	CUMMINS	F3HZ 8501-B	WATER PUMP
US740HN	CUMMINS	3800976	WATER PUMP
US740HN	CUMMINS	3285324	WATER PUMP
US740HN	CUMMINS	3925540	WATER PUMP
US740HN	CUMMINS	3926914	WATER PUMP
US740N	CUMMINS	3800974	WATER PUMP
US740N	CUMMINS	3926912	WATER PUMP
US740N	CUMMINS	3923568	WATER PUMP
US740N	CUMMINS	3285323	WATER PUMP
US740NM	CUMMINS	3800975	WATER PUMP
US801	THERMOKING	11-5252	WATER PUMP
US801	THERMOKING	11-9356	WATER PUMP
US1058	DETROIT DIESEL	5149707	WATER PUMP
US1058	DETROIT DIESEL	23506735	WATER PUMP
US1074	DETROIT DIESEL	5149706	WATER PUMP
US1074	DETROIT DIESEL	23506723	WATER PUMP
US1099	INTERNATIONAL / NAVISTAR	270918C93	WATER PUMP
US1099	INTERNATIONAL / NAVISTAR	463365C91	WATER PUMP
US1099	INTERNATIONAL / NAVISTAR	861236R92	WATER PUMP
US1223	CATERPILLAR	2W1223	WATER PUMP
US2000	CUMMINS	3807784	WATER PUMP
US2000	CUMMINS	3000886	WATER PUMP
US2000	CUMMINS	AR45080	WATER PUMP
US2000	CUMMINS	3801784	WATER PUMP
US2000	CUMMINS	AR45090	WATER PUMP
US2001	CUMMINS	3022474	WATER PUMP
US2001	CUMMINS	3801788	WATER PUMP
US2001	CUMMINS	AR45184	WATER PUMP
US2002	CUMMINS	AR4283	WATER PUMP
US2002	CUMMINS	4919814	WATER PUMP
US2002	CUMMINS	196845	WATER PUMP
US2004	MACK	316GC1211A	WATER PUMP
US2004	MACK	316GC1211AX	WATER PUMP
US2004	MACK	316GC1184BX	WATER PUMP
US2006	MACK	316GCA184 C/D/E	WATER PUMP
US2018	CUMMINS	BM76506	WATER PUMP



HEAVY DUTY QUICK REFERENCE GUIDE

USMW
Professional Series

USMW #	MAKE	OE INTERCHANGE	PRODUCT TYPE
US2018	CUMMINS	4919811	WATER PUMP
US2019	PERKINS	41312159	WATER PUMP
US2019	PERKINS	41312487	WATER PUMP
US2021	CUMMINS	3064920	IDLER
US2021	CUMMINS	AR8851	IDLER
US2022	PERKINS	41212691	WATER PUMP
US2022	PERKINS	41312479	WATER PUMP
US2022	PERKINS	41313018	WATER PUMP
US2023	PERKINS	41312143	WATER PUMP
US2023	PERKINS	41313201	WATER PUMP
US2023	PERKINS	12494050	WATER PUMP
US2023	PERKINS	236-4-84	WATER PUMP
US2023	PERKINS	21312201	WATER PUMP
US2024	CASE	A146584	WATER PUMP
US2026	DETROIT DIESEL	5149708	WATER PUMP
US2026	DETROIT DIESEL	23506711	WATER PUMP
US2027	DETROIT DIESEL	5149710	WATER PUMP
US2027	DETROIT DIESEL	23506704	WATER PUMP
US2029	CUMMINS	3801713	WATER PUMP
US2029	CUMMINS	3022471	WATER PUMP
US2029	CUMMINS	4919820	WATER PUMP
US2032	CUMMINS	3801708	WATER PUMP
US2032	CUMMINS	3049543	WATER PUMP
US2032	CUMMINS	AR45217	WATER PUMP
US2033	CUMMINS	AR51360	WATER PUMP
US2033	CUMMINS	4919815	WATER PUMP
US2033P	CUMMINS	AR51333	WATER PUMP
US2034	DETROIT DIESEL	8928672	WATER PUMP
US2035	CATERPILLAR	7C4957	WATER PUMP
US2035	CATERPILLAR	7W7019	WATER PUMP
US2035	CATERPILLAR	OR8217	WATER PUMP
US2035	CATERPILLAR	1354926	WATER PUMP
US2037	DETROIT DIESEL	8922335	WATER PUMP
US2039	THERMOKING	11-4576	WATER PUMP
US2041	CATERPILLAR	2W1225	WATER PUMP
US2041NP	CATERPILLAR	9N6147	WATER PUMP
US2042	CUMMINS	AR4284	WATER PUMP
US2042	CUMMINS	4919813	WATER PUMP
US2043	CATERPILLAR	2W1227	WATER PUMP
US2044	CUMMINS	3004923	WATER PUMP
US2045	CUMMINS	3064919	IDLER
US2045	CUMMINS	AR45189	IDLER
US2046	MACK	316GC1210A	WATER PUMP
US2046	MACK	316GC4541A	WATER PUMP
US2046	MACK	316GC1219	WATER PUMP
US2048	CUMMINS	AR61788	WATER PUMP
US2048	CUMMINS	4919812	WATER PUMP
US2049	PERKINS	41311707	WATER PUMP
US2049	PERKINS	41312479	WATER PUMP
US2053	PERKINS	41312201	WATER PUMP
US2053	PERKINS	41312320	WATER PUMP
US2054	CUMMINS	34079-B05	WATER PUMP
US2055	PERKINS	41313047	WATER PUMP

USMW #	MAKE	OE INTERCHANGE	PRODUCT TYPE
US2056	PERKINS	236-57-31	WATER PUMP
US2057	PERKINS	41313048	WATER PUMP
US2058	MERCEDES	A366 200 0601	WATER PUMP
US2059	INTERNATIONAL / NAVISTAR	3136217R92	WATER PUMP
US2060	CUMMINS	3027174	WATER PUMP
US2062	CUMMINS	3803138	WATER PUMP
US2062	CUMMINS	3803030	WATER PUMP
US2062	CUMMINS	3062928	WATER PUMP
US2062	CUMMINS	3052386	WATER PUMP
US2064	CUMMINS	3065000	IDLER
US2065	CUMMINS	3062931	WATER PUMP
US2065	CUMMINS	3053537	WATER PUMP
US2067	MERCEDES	A366 200 6801	WATER PUMP
US2067BP	MERCEDES	A366 200 6801	WATER PUMP
US2068	PERKINS	4131 E011	WATER PUMP
US2068	PERKINS	U5MW0092	WATER PUMP
US2068	PERKINS	U5MW0160	WATER PUMP
US2090	CUMMINS	3803605	WATER PUMP
US2090	CUMMINS	3803361	WATER PUMP
US2093	CATERPILLAR	613890	WATER PUMP
US2093	CATERPILLAR	10R0483	WATER PUMP
US2093	CATERPILLAR	OR4120	WATER PUMP
US2093	CATERPILLAR	OR8218	WATER PUMP
US2093	CATERPILLAR	OR8330	WATER PUMP
US2093	CATERPILLAR	3520212	WATER PUMP
US2094	DETROIT DIESEL	23509067	WATER PUMP
US2094	DETROIT DIESEL	23505019	WATER PUMP
US2094	DETROIT DIESEL	23514989	WATER PUMP
US2096	CUMMINS	3066330	IDLER
US2124	MERCEDES	A390 200 01 01	WATER PUMP
US2128	INTERNATIONAL / NAVISTAR	1842664C91	WATER PUMP
US2128	INTERNATIONAL / NAVISTAR	1842664C92	WATER PUMP
US2128	INTERNATIONAL / NAVISTAR	1830607C4	WATER PUMP
US2128	INTERNATIONAL / NAVISTAR	1841764C2	WATER PUMP
US2129	DETROIT DIESEL	23532542	WATER PUMP
US2129	DETROIT DIESEL	23531257	WATER PUMP
US2129	DETROIT DIESEL	23535017	WATER PUMP
US2130	DETROIT DIESEL	23532543	WATER PUMP
US2130	DETROIT DIESEL	23531258	WATER PUMP
US2130	DETROIT DIESEL	23503518	WATER PUMP
US2202	CUMMINS	3803402	WATER PUMP
US2202	CUMMINS	3801840	WATER PUMP
US2203	CUMMINS	3803403	WATER PUMP
US2203	CUMMINS	4955705	WATER PUMP
US2203	CUMMINS	4003929	WATER PUMP
US2203	CUMMINS	3800737	WATER PUMP
US2204	CUMMINS	3800745	WATER PUMP
US2602	CUMMINS	3062602	IDLER
US2603	DETROIT DIESEL	23506003	WATER PUMP
US2603	DETROIT DIESEL	5144685	WATER PUMP
US2607	DETROIT DIESEL	23506007	WATER PUMP
US2607	DETROIT DIESEL	5144686	WATER PUMP
US2611	DETROIT DIESEL	23506011	WATER PUMP

USMW #	MAKE	OE INTERCHANGE	PRODUCT TYPE
US2611	DETROIT DIESEL	5104392	WATER PUMP
US3702	INTERNATIONAL / NAVISTAR	1700594	WATER PUMP
US3702	INTERNATIONAL / NAVISTAR	1700594C91	WATER PUMP
US3702	INTERNATIONAL / NAVISTAR	1700594C92	WATER PUMP
US3705	INTERNATIONAL / NAVISTAR	1809374	WATER PUMP
US3705	INTERNATIONAL / NAVISTAR	1809374C91	WATER PUMP
US3705	INTERNATIONAL / NAVISTAR	1805952C91	WATER PUMP
US3707	INTERNATIONAL / NAVISTAR	673162	WATER PUMP
US3707	INTERNATIONAL / NAVISTAR	673162C92	WATER PUMP
US3709	INTERNATIONAL / NAVISTAR	680899C92	WATER PUMP
US3710	INTERNATIONAL / NAVISTAR	685155C92	WATER PUMP
US3710	INTERNATIONAL / NAVISTAR	685155C91	WATER PUMP
US3710	INTERNATIONAL / NAVISTAR	685155C95	WATER PUMP
US3710	INTERNATIONAL / NAVISTAR	735327C91	WATER PUMP
US3711	INTERNATIONAL / NAVISTAR	3136053	WATER PUMP
US3712	INTERNATIONAL / NAVISTAR	1815538	WATER PUMP
US3712	INTERNATIONAL / NAVISTAR	1815538C91	WATER PUMP
US3713	INTERNATIONAL / NAVISTAR	1817687C95	WATER PUMP
US3713	INTERNATIONAL / NAVISTAR	1817687C92	WATER PUMP
US3713	INTERNATIONAL / NAVISTAR	1817687C94	WATER PUMP
US3713	INTERNATIONAL / NAVISTAR	1817687C96	WATER PUMP
US4018	FORD/ INTERNATIONAL	E9TZ 850-B	WATER PUMP
US4018	FORD/ INTERNATIONAL	E4TZ 8501 C	WATER PUMP
US4062	FORD/ INTERNATIONAL	E8HZ 8501-B	WATER PUMP
US4062	FORD/ INTERNATIONAL	E7HN 8A513 AB	WATER PUMP
US4071	FORD/ INTERNATIONAL	F1HZ 8501-C	WATER PUMP
US4072	FORD/ INTERNATIONAL	F1HZ 8501-D	WATER PUMP
US4096	FORD/ INTERNATIONAL	F5TZ 8501-B	WATER PUMP
US4096	FORD/ INTERNATIONAL	F5TZ 8501-C	WATER PUMP
US4096	FORD/ INTERNATIONAL	1812313C93	WATER PUMP
US4096	INTERNATIONAL / NAVISTAR	1812313C93	WATER PUMP
US4096	INTERNATIONAL / NAVISTAR	F5TZ 8501-B	WATER PUMP
US4096	INTERNATIONAL / NAVISTAR	F5TZ 8501-C	WATER PUMP
US4114	FORD/ INTERNATIONAL	F7TZ 8501-C	WATER PUMP
US4114	FORD/ INTERNATIONAL	F7TZ 8501-C	WATER PUMP
US4114	FORD/ INTERNATIONAL	1831005C92	WATER PUMP
US4114	FORD/ INTERNATIONAL	F6TZ 8501-AA	WATER PUMP
US4114	FORD/ INTERNATIONAL	F7TZ 8501-BRM	WATER PUMP
US4114	FORD/ INTERNATIONAL	F81Z 8501-A	WATER PUMP
US4114	FORD/ INTERNATIONAL	F81Z 8501-B	WATER PUMP
US4114	FORD/ INTERNATIONAL	F81Z 8501-CRM	WATER PUMP
US4114	FORD/ INTERNATIONAL	F81Z 8501F-A	WATER PUMP
US4114	FORD/ INTERNATIONAL	F81Z 8501-ARM	WATER PUMP
US4508	CATERPILLAR	7C4508	WATER PUMP
US4508	CATERPILLAR	352-2160	WATER PUMP
US4508	CATERPILLAR	1318238	WATER PUMP
US4508	CATERPILLAR	0R0104	WATER PUMP
US4508	CATERPILLAR	1593137	WATER PUMP
US5008	GENERAL MOTORS	23500133	WATER PUMP
US5008	GENERAL MOTORS	12514269	WATER PUMP
US5008	GENERAL MOTORS	15633465	WATER PUMP
US5062	GENERAL MOTORS	12514574	WATER PUMP
US5062	GENERAL MOTORS	15633466	WATER PUMP

USMW #	MAKE	OE INTERCHANGE	PRODUCT TYPE
US5062	GENERAL MOTORS	12534417	WATER PUMP
US5062	GENERAL MOTORS	23500138	WATER PUMP
US5074	GENERAL MOTORS	88894036	WATER PUMP
US5074	GENERAL MOTORS	5744662	WATER PUMP
US5074	GENERAL MOTORS	12530176	WATER PUMP
US5074	GENERAL MOTORS	12534772	WATER PUMP
US5077	ISUZU / NPR	8-12532-528-0	WATER PUMP
US5078	GENERAL MOTORS	12551474	WATER PUMP
US5078	GENERAL MOTORS	12529192	WATER PUMP
US5078	GENERAL MOTORS	12520263	WATER PUMP
US5078	GENERAL MOTORS	12512740	WATER PUMP
US5078	GENERAL MOTORS	10140667	WATER PUMP
US5084	GENERAL MOTORS	14002440	WATER PUMP
US5084	GENERAL MOTORS	10074182	WATER PUMP
US5086	GENERAL MOTORS	88894035	WATER PUMP
US5090	GENERAL MOTORS	88893907	WATER PUMP
US5094	GENERAL MOTORS	12456328	WATER PUMP
US6007	MERCEDES	A6422001301	WATER PUMP
US6007	MERCEDES	5138 057AA	WATER PUMP
US6007	MERCEDES	647 200 01 01	WATER PUMP
US6008	MERCEDES	611 200 05 01	WATER PUMP
US6008	MERCEDES	611 200 11 01	WATER PUMP
US6008	MERCEDES	611 220 01 10	WATER PUMP
US6008	MERCEDES	A611 200 11 01	WATER PUMP
US6008	MERCEDES	5103 576AB	WATER PUMP
US6008	MERCEDES	5103 576AA	WATER PUMP
US6150	CATERPILLAR	1615719	WATER PUMP
US6150	CATERPILLAR	10R0484	WATER PUMP
US6150	CATERPILLAR	0R9869	WATER PUMP
US6151	CUMMINS	4089908	WATER PUMP
US6222	CUMMINS	3800984	WATER PUMP
US6222	CUMMINS	4891252	WATER PUMP
US6222	CUMMINS	2881804	WATER PUMP
US6248	CATERPILLAR	352-2149	WATER PUMP
US6248	CATERPILLAR	126-8277	WATER PUMP
US6342	CATERPILLAR	3362213	WATER PUMP
US6342	CATERPILLAR	2807374	WATER PUMP
US6342	CATERPILLAR	3520211	WATER PUMP
US6344	CUMMINS	4089910	WATER PUMP
US6344	CUMMINS	3684449	WATER PUMP
US7123H	CUMMINS	3286278	WATER PUMP
US7123H	CUMMINS	3285410	WATER PUMP
US7123H	CUMMINS	3285414	WATER PUMP
US7145HN	CUMMINS	3286277	WATER PUMP
US7145HN	CUMMINS	3003749	WATER PUMP
US7145HN	CUMMINS	3913432	WATER PUMP
US7145HN	CUMMINS	3802358	WATER PUMP
US7145HN	CUMMINS	3802004	WATER PUMP
US7145HN	CUMMINS	3802970	WATER PUMP
US7145N	CUMMINS	3286275	WATER PUMP
US7760	CATERPILLAR	1727760	WATER PUMP
US7760	CATERPILLAR	1550061	WATER PUMP
US7760	CATERPILLAR	4P9862	WATER PUMP

USMW #	MAKE	OE INTERCHANGE	PRODUCT TYPE
US7760	CATERPILLAR	0R0997	WATER PUMP
US7765	CATERPILLAR	1727765	WATER PUMP
US7765	CATERPILLAR	1550066	WATER PUMP
US7765	CATERPILLAR	1157560	WATER PUMP
US7765	CATERPILLAR	0R1002	WATER PUMP
US7766	CATERPILLAR	1727766	WATER PUMP
US7766	CATERPILLAR	2W8002	WATER PUMP
US7766	CATERPILLAR	1550067	WATER PUMP
US7766	CATERPILLAR	7C7967	WATER PUMP
US7766	CATERPILLAR	7N5908	WATER PUMP
US7766	CATERPILLAR	9Y6435	WATER PUMP
US7767	CATERPILLAR	1727767	WATER PUMP
US7767	CATERPILLAR	2W8001	WATER PUMP
US7767	CATERPILLAR	1W3058	WATER PUMP
US7767	CATERPILLAR	1W3060	WATER PUMP
US7767	CATERPILLAR	7N5909	WATER PUMP
US7767	CATERPILLAR	1550068	WATER PUMP
US7775	CATERPILLAR	1727775	WATER PUMP
US7775	CATERPILLAR	2P0661	WATER PUMP
US7776	CATERPILLAR	1727776	WATER PUMP
US7776	CATERPILLAR	2P0662	WATER PUMP
US9302	ISUZU / NPR	8-97021-171-0	WATER PUMP
US9302	ISUZU / NPR	2911463250	WATER PUMP
US16000	MERCEDES	A906 200 1401	WATER PUMP
US16000	MERCEDES	906 200 6101	WATER PUMP
US16000	MERCEDES	906 200 1401	WATER PUMP
US16000	MERCEDES	906 200 2201	WATER PUMP
US16000	MERCEDES	906 200 2911	WATER PUMP
US16000	MERCEDES	906 200 5401	WATER PUMP
US16001	MAN	51.06500.7036	WATER PUMP
US16002	VOLVO	20 734 268	WATER PUMP
US16002	VOLVO	20 734 268	WATER PUMP
US16003	VOLVO	814 99 41	WATER PUMP
US16004	MAN	51.06500.6616	WATER PUMP
US16005	MAN	51.06500.7049	WATER PUMP
US16006	MAN	51.06500.6408	WATER PUMP
US16007	MAN	51.06500.6547	WATER PUMP
US16008	MAN	51.06500.6546	WATER PUMP
US16009	MAN	51.06500.9479	WATER PUMP
US16010	MAN	51.06500.6554	WATER PUMP
US16011	MERCEDES	541 200 01 01	WATER PUMP
US16012	MERCEDES	542 200 17 01	WATER PUMP
US16013	MERCEDES	904 201 02 01	WATER PUMP
US16013	MERCEDES	904 200 49 01	WATER PUMP
US16013	MERCEDES	904 200 0 01	WATER PUMP
US16013	MERCEDES	904 200 08 01	WATER PUMP
US16013	MERCEDES	904 200 2601	WATER PUMP
US16014	DAF	682968	WATER PUMP
US16015	DAF	683386	WATER PUMP
US16016	SCANIA	1 057 0951	WATER PUMP
US16016	SCANIA	1508533	WATER PUMP
US16016	SCANIA	1353072	WATER PUMP
US16017	SCANIA	1 057 0952	WATER PUMP

USMW #	MAKE	OE INTERCHANGE	PRODUCT TYPE
US16017	SCANIA	1508534	WATER PUMP
US16017	SCANIA	1365841	WATER PUMP
US16018	MERCEDES	906 200 63 01	WATER PUMP
US16018	MERCEDES	906 200 40 01	WATER PUMP
US16018	MERCEDES	906 200 51 01	WATER PUMP
US16018	MERCEDES	906 200 43 01	WATER PUMP
USFP0266	CUMMINS	2830266	FUEL PUMP
USFP0266	CUMMINS	84268475	FUEL PUMP
USFP4319	CUMMINS	3918000	FUEL PUMP
USFP4319	CUMMINS	3914319	FUEL PUMP
USFP4374	CUMMINS	3904374	FUEL PUMP
USFP4374	CUMMINS	5012 376AA	FUEL PUMP
USFP4374	CUMMINS	4429374	FUEL PUMP
USFP4374	CUMMINS	4983584	FUEL PUMP
USFP4374	CUMMINS	3970080	FUEL PUMP
USFP4374	CUMMINS	3966154	FUEL PUMP
USFP4374	CUMMINS	3928143	FUEL PUMP
USFP4374	CUMMINS	3901425	FUEL PUMP
USFP6316	CUMMINS	3936316	FUEL PUMP
USFP6316	CUMMINS	4988747	FUEL PUMP
USFP6316	CUMMINS	3925709	FUEL PUMP
USFP6316	CUMMINS	3930134	FUEL PUMP
USFP6316	CUMMINS	3932224	FUEL PUMP
USFP6316	CUMMINS	3933252	FUEL PUMP
USFP6316	CUMMINS	4944710	FUEL PUMP
USFP6318	CUMMINS	3936318	FUEL PUMP
USFP6318	CUMMINS	3917998	FUEL PUMP
USFP6318	CUMMINS	3917999	FUEL PUMP
USFP6318	CUMMINS	4988749	FUEL PUMP
USFP6318	CUMMINS	4944712	FUEL PUMP
USFP6318	CUMMINS	3933254	FUEL PUMP
USFP6318	CUMMINS	3632226	FUEL PUMP
USFP6318	CUMMINS	3930201	FUEL PUMP
USFP6319	CUMMINS	3936319	FUEL PUMP
USFP6319	CUMMINS	4988750	FUEL PUMP
USFP6319	CUMMINS	4944713	FUEL PUMP
USFP6319	CUMMINS	3933255	FUEL PUMP
USFP6319	CUMMINS	3932227	FUEL PUMP
USFP6319	CUMMINS	3930202	FUEL PUMP
USFP6320	CUMMINS	3936320	FUEL PUMP
USFP6320	CUMMINS	4988751	FUEL PUMP
USFP6320	CUMMINS	4944714	FUEL PUMP
USFP6320	CUMMINS	3933256	FUEL PUMP
USFP6320	CUMMINS	3932228	FUEL PUMP
USFP6320	CUMMINS	3930349	FUEL PUMP
USFS1167	CUMMINS	3991167	FUEL SOLENOID
USGK3573	CUMMINS	3803573	SEAL KIT
USGK3894	CUMMINS	3803894	SEAL KIT
USOP056	PERKINS	4131 F056	OIL PUMP
USOP056	PERKINS	4222282M91	OIL PUMP
USOP056	PERKINS	6I0912	OIL PUMP
USOP057	PERKINS	4131 F057	OIL PUMP
USOP057	PERKINS	4132 F023	OIL PUMP

HEAVY DUTY



HEAVY DUTY QUICK REFERENCE GUIDE

USMW
Professional Series

USMW #	MAKE	OE INTERCHANGE	PRODUCT TYPE
USOP057	PERKINS	4132 F029	OIL PUMP
USOP0172	CUMMINS	AR10172	OIL PUMP
USOP0336	CUMMINS	3930336	OIL PUMP
USOP0336	CUMMINS	3937027	OIL PUMP
USOP0336	CUMMINS	3926202	OIL PUMP
USOP0336	CUMMINS	3924719	OIL PUMP
USOP0337	CUMMINS	3930337	OIL PUMP
USOP0337	CUMMINS	3937404	OIL PUMP
USOP0337	CUMMINS	3636203	OIL PUMP
USOP0338	CUMMINS	3930338	OIL PUMP
USOP0338	CUMMINS	3800828	OIL PUMP
USOP0338	CUMMINS	3926201	OIL PUMP
USOP0338	CUMMINS	3924644	OIL PUMP
USOP0733	CATERPILLAR	4N0733	OIL PUMP
USOP0733	CATERPILLAR	1614111	OIL PUMP
USOP0733	CATERPILLAR	4N4295	OIL PUMP
USOP1464	CUMMINS	4941464	OIL PUMP
USOP1464	CUMMINS	3991123	OIL PUMP
USOP1572	CUMMINS	3821572	OIL PUMP
USOP1757	CUMMINS	2881757	OIL PUMP
USOP1757	CUMMINS	4309500	OIL PUMP
USOP1757	CUMMINS	4026691	OIL PUMP
USOP2448	CATERPILLAR	4W2448	OIL PUMP
USOP2448	CATERPILLAR	2P1785	OIL PUMP
USOP2448	CATERPILLAR	6I1346	OIL PUMP
USOP2448	CATERPILLAR	4P4020	OIL PUMP
USOP2666	INTERNATIONAL / NAVISTAR	1802666C92	OIL PUMP
USOP3369	CUMMINS	3903369	OIL PUMP
USOP3698	CUMMINS	3803698	OIL PUMP
USOP3950	CUMMINS	4003950	OIL PUMP
USOP3950	CUMMINS	3401186	OIL PUMP
USOP3950	CUMMINS	3895756	OIL PUMP
USOP3950	CUMMINS	3883910	OIL PUMP
USOP4067	PERKINS	41314067	OIL PUMP
USOP4067	PERKINS	41314131	OIL PUMP
USOP4067	PERKINS	736012M91	OIL PUMP
USOP4078	PERKINS	41314078	OIL PUMP
USOP4078	PERKINS	41314178	OIL PUMP
USOP4078	PERKINS	41314187	OIL PUMP
USOP4182	PERKINS	41314182	OIL PUMP
USOP4182	PERKINS	41314054	OIL PUMP
USOP4182	PERKINS	41314061	OIL PUMP
USOP5220	CATERPILLAR	233-5220	OIL PUMP
USOP5886	DETROIT DIESEL	23505886	OIL PUMP
USOP6840	CUMMINS	3966840	OIL PUMP
USOP7448	DETROIT DIESEL	23527448	OIL PUMP
USOP7481	CUMMINS	4897481	OIL PUMP
USOP8734	CATERPILLAR	4N8734	OIL PUMP
USOP8734	CATERPILLAR	1614113	OIL PUMP
USOP8777	CATERPILLAR	189-8777	OIL PUMP
USOP8801	CUMMINS	4988801	OIL PUMP
USOP8801	CUMMINS	3973398	OIL PUMP
USOP8801	CUMMINS	3957266	OIL PUMP

USMW #	MAKE	OE INTERCHANGE	PRODUCT TYPE
USOP8801	CUMMINS	3947308	OIL PUMP
USOP8832	INTERNATIONAL / NAVISTAR	1808832C92	OIL PUMP
USOP9585	CUMMINS	4939585	OIL PUMP
USOP9585	CUMMINS	3937027	OIL PUMP
USOP9585	CUMMINS	3926202	OIL PUMP
USOP9585	CUMMINS	3924719	OIL PUMP
USOP9586	CUMMINS	4939586	OIL PUMP
USOP9586	CUMMINS	3976087	OIL PUMP
USOP9586	CUMMINS	5313086	OIL PUMP
USOP9586	CUMMINS	5273937	OIL PUMP
USOP9587	CUMMINS	4939587	OIL PUMP
USOP9587	CUMMINS	3937028	OIL PUMP
USOP9587	CUMMINS	3932449	OIL PUMP
USOP9588	CUMMINS	4939588	OIL PUMP
USOP9588	CUMMINS	3971544	OIL PUMP
USSC4808	CUMMINS	4024808	SOLENOID COIL
USSC4808	CUMMINS	3054611	SOLENOID COIL
USSC4808	CUMMINS	3054608	SOLENOID COIL
USSC4808	CUMMINS	3408421	SOLENOID COIL
USSC4809	CUMMINS	4024809	SOLENOID COIL
USSC4809	CUMMINS	134074	SOLENOID COIL
USSC4809	CUMMINS	3054610	SOLENOID COIL
USSC4809	CUMMINS	3054609	SOLENOID COIL
USSV5342	CUMMINS	3035342	SHUTDOWN VALVE
USSV5342	CUMMINS	143793	SHUTDOWN VALVE
USSV5344	CUMMINS	3035344	SHUTDOWN VALVE
USSV5344	CUMMINS	143795	SHUTDOWN VALVE
USSV5344	CUMMINS	3035362	SHUTDOWN VALVE

HEAVY DUTY



HEAVY DUTY CROSS REFERENCE GUIDE

USMW
Professional Series

CASE					
WATER PUMP					
A146584	US2024	4P9862	US7760	3914319	USFP4319
CATERPILLAR		0R0997	US7760	2830266	USFP0266
BACK PLATE		1727765	US7765	84268475	USFP0266
7C9222	BP2093	1550066	US7765	FUEL SOLENOID	
OIL PUMP		1157560	US7765	3991167	USFS1167
4W2448	USOP2448	0R1002	US7765	IDLER	
2P1785	USOP2448	325-2080	US90	3064920	US2021
6I1346	USOP2448	10R5406	US90	3064919	US2045
4P4020	USOP2448	227-4298	US90	3065000	US2064
4N8734	USOP8734	200-1212	US90	3062931	US2065
1614113	USOP8734	260-1546	US90	3062602	US2602
233-5220	USOP5220	227-4300	US90	3066330	US2096
189-8777	USOP8777	352-2139	US91	OIL PUMP	
4N0733	USOP0733	236-4413	US91	4939587	USOP9587
1614111	USOP0733	10R4429	US91	3937028	USOP9587
4N4295	USOP0733	352-2109	US92	3932449	USOP9587
WATER PUMP		10R5407	US92	4939586	USOP9586
7C4957	US2035	227-8843	US92	3976087	USOP9586
7W7019	US2035	227-4299	US92	5313086	USOP9586
OR8217	US2035	352-2149	US6248	5273937	USOP9586
1354926	US2035	126-8277	US6248	4939588	USOP9588
2W1225	US2041	613890	US2093	3971544	USOP9588
9N6147	US2041NP	10R0483	US2093	4897481	USOP7481
2W1227	US2043	OR4120	US2093	3930338	USOP0338
1767000	US70	OR8218	US2093	3800828	USOP0338
1025844	US71	OR8330	US2093	3926201	USOP0338
9Y4361	US71	3520212	US2093	3924644	USOP0338
4P3683	US74	CUMMINS		3966840	USOP6840
4W0253	US74	FAN CLUTCH		4941464	USOP1464
OR3007	US74	5202 8894AA		3991123	USOP1464
9V4879	US74	22616		4003950	USOP3950
OR1013	US74	FUEL PUMP		3401186	USOP3950
4P3683	US74	3904374	USFP4374	3895756	USOP3950
1208402	US75	5012 376AA	USFP4374	3883910	USOP3950
3362213	US6342	4429374	USFP4374	3930337	USOP0337
2807374	US6342	4983584	USFP4374	3937404	USOP0337
3520211	US6342	3970080	USFP4374	3636203	USOP0337
1252989	US68	3966154	USFP4374	4988801	USOP8801
1615719	US6150	3928143	USFP4374	3973398	USOP8801
10R0484	US6150	3901425	USFP4374	3957266	USOP8801
OR9869	US6150	3936316	USFP6316	3947308	USOP8801
1727766	US7766	4988747	USFP6316	2881757	USOP1757
2W8002	US7766	3925709	USFP6316	4309500	USOP1757
1550067	US7766	3930134	USFP6316	4026691	USOP1757
7C7967	US7766	3932224	USFP6316	3821572	USOP1572
7N5908	US7766	3933252	USFP6316	3803698	USOP3698
9Y6435	US7766	4944710	USFP6316	3903369	USOP3369
1727767	US7767	3936318	USFP6318	AR10172	USOP0172
2W8001	US7767	3917998	USFP6318	3930336	USOP0336
1W3058	US7767	4988749	USFP6318	3937027	USOP0336
1W3060	US7767	4944712	USFP6318	3926202	USOP0336
7N5909	US7767	3933254	USFP6318	3924719	USOP0336
1550068	US7767	3632226	USFP6318	4939585	USOP9585
1727775	US7775	3930201	USFP6318	3937027	USOP9585
2P0661	US7775	3936319	USFP6319	3926202	USOP9585
1727776	US7776	4988750	USFP6319	3924719	USOP9585
2P0662	US7776	4944713	USFP6319	REPAIR KIT	
7C4508	US4508	3933255	USFP6319	4090022	KT6151
352-2160	US4508	3932227	USFP6319	SEAL KIT	
1318238	US4508	3930202	USFP6319	3803894	USGK3894
OR0104	US4508	3936320	USFP6320	3803573	USGK3573
1593137	US4508	4988751	USFP6320	SHUTDOWN VALVE	
2W1223	US1223	4944714	USFP6320	3035342	USSV5342
1727760	US7760	3933256	USFP6320	143793	USSV5342
1550061	US7760	3932228	USFP6320	3035344	USSV5344
		3930349	USFP6320	143795	USSV5344
		3918000	USFP4319	3035362	USSV5344
				SOLENOID COIL	

4024808	USSC4808	3806180	US740H	F8UZ 8A616-AA	22612
3054611	USSC4808	3802081	US740H	WATER PUMP	
3054608	USSC4808	3804883	US740H	1823669C92	US66
3408421	USSC4808	F3HZ 8501-B	US740H	1831676C91	US66
4024809	USSC4809	3800976	US740HN	1831676C92	US66
134074	USSC4809	3285324	US740HN	YC3Z 8501-AARM	US66
3054610	USSC4809	3925540	US740HN	YC3Z 8501-CA	US66
3054609	USSC4809	3926914	US740HN	3C3Z 8501-BA	US61
WATER PUMP		3800974	US740N	3C3Z 8501-ABRM	US61
3807784	US2000	3926912	US740N	4C3Z 8501-AB	US67
3000886	US2000	3923568	US740N	4C3Z 8501-ABRM	US67
AR45080	US2000	3285323	US740N	F81Z 8501-ABRM	US67
3801784	US2000	4089647	US69NX	8C3Z 8501-B	US76
AR45090	US2000	3800975	US740NM	BC3Z 8501-A	US77
3022474	US2001	4089908	US6151	5C4Z 8501-AA	US85
3801788	US2001	4089910	US6344	4C4Z 8501-AARM	US85
AR45184	US2001	3684449	US6344	1845002C91	US85
BM76506	US2018	3684450	US93	E9TZ 850-B	US4018
4919811	US2018	3683651	US93	E4TZ 8501 C	US4018
AR8851	US2021	DAF		E8HZ 8501-B	US4062
3801713	US2029	WATER PUMP		E7HN 8A513 AB	US4062
3022471	US2029	682968	US16014	F1HZ 8501-C	US4071
4919820	US2029	683386	US16015	F1HZ 8501-D	US4072
3801708	US2032	DETROIT DIESEL		F5TZ 8501-B	US4096
3049543	US2032	OIL PUMP		F5TZ 8501-C	US4096
AR45217	US2032	23527448	USOP7448	1812313C93	US4096
AR51360	US2033	23505886	USOP5886	F7TZ 8501-C	US4114
4919815	US2033	WATER PUMP		F7TZ 8501-C	US4114
AR51333	US2033P	23505895	US60	1831005C92	US4114
AR4284	US2042	23520136	US60	F6TZ 8501-AA	US4114
4919813	US2042	R3518216	US60	F7TZ 8501-BRM	US4114
AR4283	US2002	23526039	US60P	F81Z 8501-A	US4114
4919814	US2002	23522721	US60P	F81Z 8501-B	US4114
196845	US2002	23526039	US60P	F81Z 8501-CRM	US4114
3004923	US2044	23522707	US60P	F81Z 8501F-A	US4114
AR45189	US2045	23509067	US2094	F81Z 8501-ARM	US4114
AR61788	US2048	23505019	US2094	GENERAL MOTORS	
4919812	US2048	23514989	US2094	FAN CLUTCH	
34079-B05	US2054	23532542	US2129	12517624	22602
3027174	US2060	23531257	US2129	15991496	22605
3803138	US2062	23535017	US2129	15671935	22606
3803030	US2062	23532543	US2130	15022302	22613
3062928	US2062	23531258	US2130	15029405	22614
3052386	US2062	23503518	US2130	15130067	22617
3053537	US2065	5149707	US1058	WATER PUMP	
3803402	US2202	23506735	US1058	97216136	US63
3801840	US2202	5149706	US1074	88894035	US5086
3803403	US2203	23506723	US1074	88893907	US5090
4955705	US2203	5149708	US2026	12456328	US5094
4003929	US2203	23506711	US2026	23500133	US5008
3800737	US2203	5149710	US2027	12514269	US5008
3800745	US2204	5149710	US2027	15633465	US5008
3803605	US2090	8928672	US2034	12514574	US5062
3803361	US2090	8922335	US2037	15633466	US5062
3800984	US6222	23506003	US2603	12534417	US5062
4891252	US6222	5144685	US2603	23500138	US5062
2881804	US6222	23506007	US2607	88894036	US5074
3286278	US7123H	5144686	US2607	5744662	US5074
3285410	US7123H	23506011	US2611	12530176	US5074
3285414	US7123H	5104392	US2611	12534772	US5074
3286277	US7145HN	FORD/ INTERNATIONAL		12551474	US5078
3003749	US7145HN	FAN CLUTCH		12529192	US5078
3913432	US7145HN	F2UZ 8A616-H	22601	12520263	US5078
3802358	US7145HN	F4TZ 8A616-B	22607	12512740	US5078
3802004	US7145HN	F5TZ 8A616-KB	22609	10140667	US5078
3802970	US7145HN	F81Z 8A616-DA	22611	14002440	US5084
3286275	US7145N			10074182	US5084
3913430	US740				

HEAVY DUTY

97372515 US72
98031233 US72

INTERNATIONAL / NAVISTAR

OIL PUMP
1802666C92 USOP2666
1808832C92 USOP8832

WATER PUMP
270918C93 US1099
463365C91 US1099
861236R92 US1099
3136217R92 US2059
1842664C91 US2128
1842664C92 US2128
1830607C4 US2128
1841764C2 US2128
1700594 US3702
1700594C91 US3702
1700594C92 US3702
1809374 US3705
1809374C91 US3705
1805952C91 US3705
673162 US3707
673162C92 US3707
680899C92 US3709
685155C92 US3710
685155C91 US3710
685155C95 US3710
735327C91 US3710
3136053 US3711
1815538 US3712
1815538C91 US3712
1817687C95 US3713
1817687C92 US3713
1817687C94 US3713
1817687C96 US3713
1812313C93 US4096
F5TZ 8501-B US4096
F5TZ 8501-C US4096

ISUZU / NPR

WATER PUMP
8-97021-171-0 US9302
2911463250 US9302
8-12532-528-0 US5077

MACK

WATER PUMP
316GC1211A US2004
316GC1211AX US2004
316GC1184BX US2004
316GCA184 C/D/E US2006
316GC1210A US2046
316GC4541A US2046
316GC1219 US2046

MAN

WATER PUMP
51.06500.7036 US16001
51.06500.6616 US16004
51.06500.7049 US16005
51.06500.6408 US16006
51.06500.6547 US16007
51.06500.6546 US16008
51.06500.9479 US16009
51.06500.6554 US16010

MERCEDES

WATER PUMP
A906 200 1401 US16000

906 200 6101 US16000
906 200 1401 US16000
906 200 2201 US16000
906 200 2911 US16000
906 200 5401 US16000
541 200 01 01 US16011
542 200 17 01 US16012
904 201 02 01 US16013
904 200 49 01 US16013
904 200 0 01 US16013
904 200 08 01 US16013
904 200 2601 US16013
906 200 63 01 US16018
906 200 40 01 US16018
906 200 51 01 US16018
906 200 43 01 US16018
A366 200 0601 US2058
A366 200 6801 US2067BP
A366 200 6801 US2067
A6422001301 US6007
5138 057AA US6007
647 200 01 01 US6007
611 200 05 01 US6008
611 200 11 01 US6008
611 220 01 10 US6008
A611 200 11 01 US6008
5103 576AB US6008
5103 576AA US6008
A390 200 01 01 US2124

PERKINS

OIL PUMP
41314078 USOP4078
41314178 USOP4078
41314187 USOP4078
41314067 USOP4067
41314131 USOP4067
736012M91 USOP4067
41314182 USOP4182
41314054 USOP4182
41314061 USOP4182
4131 F057 USOP057
4132 F023 USOP057
4132 F029 USOP057
4131 F056 USOP056
4222282M91 USOP056
6I0912 USOP056

WATER PUMP

41312159 US2019
41312487 US2019
41212691 US2022
41312479 US2022
41313018 US2022
41312143 US2023
41313201 US2023
12494050 US2023
236-4-84 US2023
21312201 US2023
4131 E011 US2068
U5MW0092 US2068
U5MW0160 US2068
41311707 US2049
41312479 US2049
41312201 US2053
41312320 US2053
41313047 US2055
236-57-31 US2056
41313048 US2057

SCANIA

WATER PUMP
1 057 0951 US16016
1508533 US16016
1353072 US16016
1 057 0952 US16017
1508534 US16017
1365841 US16017

THERMOKING

WATER PUMP
11-4576 US2039
11-5252 US801
11-9356 US801

VOLVO

WATER PUMP
20 734 268 US16002
20 734 268 US16002
814 99 41 US16003

