



# Часто задаваемые нам вопросы (FAQ – Frequently Asked Questions)



№	ВОПРОС	ОТВЕТ
<b>О предприятии.</b>		
1	Расскажите немного о ДАФМИ.	Предприятие было создано в 1991 году. Располагается в Днепропетровске (Украина), на земельном участке площадью 10 000 кв.м. Имеет собственные производственный корпус площадью 4 000 кв.м. и административно-бытовой корпус площадью 2 000 кв.м. Все технологические операции осуществляются на современном европейском оборудовании, обеспечивающем высокий и стабильный уровень качества. Качество контролируется на собственных динамометрических инерционных стендах в условиях, максимально приближенных к реальным условиям эксплуатации. Система управления качеством сертифицирована на соответствие требованиям международного стандарта ISO 9001: 2000. Является поставщиком автомобильных заводов ЗАО «ЗАЗ» (г. Запорожье) и АМО «ЗИЛ» (г. Москва). Продукция поставляется на рынки России, Грузии, Казахстана, Молдовы, Болгарии.
2	Какие виды деятельности, кроме производства фрикционных изделий, осуществляет ДАФМИ?	С 1991 года «ДАФМИ» осуществляет только деятельность по производству элементов тормозных систем для различных видов наземного транспорта. Это позволило предприятию осуществить крупные инвестиции в развитие, стать передовым европейским предприятием и приобрести широкую известность.
<b>Как покупать?</b>		
3	На упаковке тормозных колодок имеются различные знаки. Что они означают?	Знаки на упаковке тормозных колодок информируют о том, что:  - тормозные колодки сертифицированы в Украине (цифры – государственный номер органа по сертификации);  - тормозные колодки сертифицированы в России;  - система управления качеством предприятия сертифицирована на соответствие международному стандарту ISO 9001. Мы не рекомендуем Вам приобретать тормозные колодки на упаковке которых отсутствуют эти три знака.
4	На полках магазинов и на автобазарах можно увидеть тормозные колодки 10-15 производителей. Как принять правильное решение о покупке?	1. Исключите из кандидатов тормозные колодки, не имеющие индивидуальной упаковки, или от производителей, о которых Вы ничего не знаете из средств массовой информации. 2. Оставшиеся тормозные колодки хорошо известных украинских и зарубежных брендов расположите в порядке убывания цены, исключите самые дешевые и самые дорогие. 3. Выберите из оставшихся те, на упаковке которых надписи выполнены на украинском (и/или русском) языке и есть знаки о сертификации колодок в Украине, России и знак - «Система управления качеством сертифицирована на соответствие требованиям ISO 9001». 4. Поздравляем с покупкой качественных, а значит надежных и безопасных тормозных колодок.
5	Где вы рекомендуете покупать тормозные колодки?	Там, где у Вас будет возможность следовать нашему совету по п.4.
6	Надо ли учитывать рекомендации продавца?	Да, если он вызывает у вас доверие. Наш совет - иметь собственное мнение, сформированное по методике как указано в п.3.
7	Зависит ли цена от качества тормозных колодок?	Конечно да. Качество всегда и везде стоит денег. Наш совет - не покупайте самые дешевые тормозные колодки. Выбирая между импортным и отечественным товаром, учтите что в цене импортного (при том же качестве) - значительную часть составляют пошлины, транспорт и более высокая зарплата.
8	Кого можно считать конкурентом ДАФМИ?	Известный российский производитель. Это предприятие, как и ДАФМИ, имеет все необходимые системы, создающие высокое и, что очень важно, стабильное качество. Благодаря этому и это предприятие и ДАФМИ сертифицированы на соответствие требованиям ISO 9001 и являются поставщиками автомобильных заводов.
9	Иногда от продавца можно услышать – «днепропетровские колодки». Что это значит?	Покупатель ассоциирует свои оценки изделия с конкретной торговой маркой, а не с регионом их изготовления. Поэтому добросовестный продавец обязательно назовет имя торговой марки, а не наименование региона.
10	Можно ли только внешним осмотром составить впечатление о качестве тормозных колодок?	Категорически - нет, ибо иногда красивая вещь на поверку оказывается совсем не отвечает нашим ожиданиям качества. Предпосылки хорошего качества, как мы уже говорили, - известная торговая марка, наличие 3-х знаков о сертификации (см. п. 3).
<b>Качество и безопасность.</b>		
11	Можно ли, опираясь на свои личные ощущения, объективно оценить характеристики тормозных колодок?	Можно оценить только часть из них - комфортность торможения, отсутствие писка. Характеристики же, гарантирующие надежное торможение с заданной эффективностью и при любом режиме езды, могут быть объективно оценены только путем специальных испытаний на транспортных средствах, оборудованных приборами для измерения давления в тормозной системе, длины тормозного пути, температуры пары трения и т.д. Обращаем Ваше внимание на то, что такие испытания относятся к категории разрушающих, поэтому будут ли все тормозные колодки иметь одинаковые характеристики, зависит от технического уровня производства, в частности от наличия на предприятии современной системы управления качеством.
12	Каков оптимальный ресурс тормозных колодок?	Ресурс тормозных колодок существенно зависит от стиля управления автомобилем, частоты и интенсивности торможений, технического состояния тормозной системы и автомобиля в целом, рельефа местности и условий, в которых эксплуатируется автомобиль. Накопленная нами статистика свидетельствует о том, что если Вы используете тормозные колодки известных торговых марок от профессиональных производителей, пробег на одном комплекте колодок может составить около 30 тыс. км. Ресурс тормозных колодок на маршрутном такси и автомобиле дачника может существенно отличаться.

## НОВИНКИ 2010 ГОДА

№	Код DAimi	Код OEM	Ось авто	Модель автомобиля	V двигателя	Год выпуска	i	Код WVA
<b>HYUNDAI</b>								
1	D114	581011GE00	перед	HYUNDAI - ACCENT (MC)	1.4 GL	11.05-	MANDO	24317
			перед	HYUNDAI - ACCENT (MC)	1.6 GLS	11.05-	MANDO	24318
			перед	HYUNDAI - ACCENT (MC)	1.5 CRDi GLS	11.05-	MANDO	24319
			перед	HYUNDAI - ACCENT седан (MC)	1.4 GL	11.05-	MANDO	
			перед	HYUNDAI - ACCENT седан (MC)	1.6 GLS	11.05-	MANDO	
			перед	HYUNDAI - ACCENT седан (MC)	1.5 CRDi GLS	11.05-	MANDO	
2	D274	583022EA31	зад	HYUNDAI - TUCSON (JM)	2.0	05.08-		
			зад	HYUNDAI - TUCSON (JM)	2.7 4x4	05.08-		
			зад	HYUNDAI - TUCSON (JM)	2.0 CRDi 4x4	05.08-		
			зад	HYUNDAI - TUCSON (JM)	2.0 CRDi	05.08-		
3	D241	581012BA10	перед	HYUNDAI - SANTA FE (SM)	2.7	10.05-	MANDO	24351
			перед	HYUNDAI - SANTA FE (SM)	2.7 4x4	10.05-	MANDO	24352
			перед	HYUNDAI - SANTA FE (SM)	2.2 CRDi	10.05-	MANDO	24353
			перед	HYUNDAI - SANTA FE (SM)	3.3 Dynamic 4x4	03.06-	MANDO	
			перед	HYUNDAI - SANTA FE (SM)	2.2 CRDi GLS 4x4	03.06-	MANDO	
<b>KIA</b>								
4	D114	581011GE00	перед	KIA - RIO II	1.4 16V	03.05-	MANDO	24317
			перед	KIA - RIO II	1.6 16V	03.05-	MANDO	24318
			перед	KIA - RIO II	1.5 CRDi	03.05-	MANDO	24319
			перед	KIA - RIO II седан	1.4 16V	03.05-	MANDO	
			перед	KIA - RIO II седан	1.6 16V	03.05-	MANDO	
			перед	KIA - RIO II седан	1.5 CRDi	03.05-	MANDO	
<b>TOYOTA</b>								
5	D115	446533440	перед	TOYOTA - CAMRY (_V30)	2.4 VVTi LE	01.06-	NBK	
		446533450	перед	TOYOTA - CAMRY (_V30)	3.5 VVTi XLE	01.06-	NBK	
		446506080	перед	TOYOTA - CAMRY седан (_V40)	2.4 VVTi Hybrid	01.06-	NBK	
			перед	TOYOTA - CAMRY седан (_V40)	2.4 VVTi LE	01.06-	NBK	
			перед	TOYOTA - CAMRY седан (_V40)	3.5 VVTi XLE	01.06-	NBK	
6	D116	446552010	перед	TOYOTA - ALLION	1.5	06.01-04.05	AKEBONO	23510
		446517101	перед	TOYOTA - ALLION	1.8	06.01-06.07	AKEBONO	23511
		446517140	перед	TOYOTA - ALLION	2.0	06.01-04.05	AKEBONO	23512
		446520480	перед	TOYOTA - ALTIS	1.3	11.01-05.04	AKEBONO	
		446552011	перед	TOYOTA - ALTIS	1.5	11.01-05.04	AKEBONO	
		446552120	перед	TOYOTA - ALTIS	1.8 VVTi	11.01-05.04	AKEBONO	
		446517100	перед	TOYOTA - CELICA (ZZT23_)	1.8 16V VT-i (ZZT230_)	11.99-	AKEBONO	
		446552022	перед	TOYOTA - COROLLA (_E12U_, _E12J_)	1.8	06.04-	AKEBONO	
		446552021	перед	TOYOTA - COROLLA универсал (_E12J_, _E12T_)	1.8	06.04-	AKEBONO	
		446512581	перед	TOYOTA - COROLLA седан (_E12J_, _E12T_)	1.5	06.04-	AKEBONO	
		446532230	перед	TOYOTA - COROLLA седан (_E12J_, _E12T_)	1.8	06.04-	AKEBONO	
		446552170	перед	TOYOTA - COROLLA ALTIS	1.3	11.01-05.04	AKEBONO	
		446547030	перед	TOYOTA - COROLLA ALTIS	1.5	11.01-05.04	AKEBONO	
		446512580	перед	TOYOTA - COROLLA ALTIS	1.5 G 4WD	11.01-05.04	AKEBONO	
		446547050	перед	TOYOTA - YARIS (_CP10)	1.0 16V (SCP10_)	04.99-	AKEBONO	
		044650W050	перед	TOYOTA - YARIS (_CP10)	1.5 TS (NCP13)	01.03-	AKEBONO	
446512590	перед	TOYOTA - YARIS (_CP10)	1.4 D-4D	12.01-	AKEBONO			

## НОВИНКИ 2010 ГОДА

№	Код DAfmi	Код OEM	Ось авто	Модель автомобиля	V двигателя	Год выпуска	i	Код WVA
7	D117	446652010	зад	TOYOTA - ALTIS	1.3	11.01-05.04	SUMITOMO	23521
		446652050	зад	TOYOTA - ALTIS	1.5	11.01-05.04	SUMITOMO	23522
		446652040	зад	TOYOTA - ALTIS	1.8 VVTi	11.01-05.04	SUMITOMO	23523
		446652030	зад	TOYOTA - CELICA (ZZT23_)	1.8 16V VT-i	11.99-	SUMITOMO	
		446652020	зад	TOYOTA - COROLLA Liftback (_E11_)	1.4	02.00-01.02	SUMITOMO	
		446620090	зад	TOYOTA - COROLLA Liftback (_E11_)	1.6	02.00-01.02	SUMITOMO	
		446652010	зад	TOYOTA - COROLLA (_E11_) - 1.5	1.5	09.99-10.01	SUMITOMO	
			зад	TOYOTA - COROLLA (_E12U_, _E12J_)	1.4 VVT-i	01.02-	SUMITOMO	
			зад	TOYOTA - COROLLA (_E12U_, _E12J_)	1.6 VVT-i	01.02-	SUMITOMO	
			зад	TOYOTA - COROLLA (_E12U_, _E12J_)	1.8	06.04-	SUMITOMO	
			зад	TOYOTA - COROLLA (_E12U_, _E12J_)	1.8 VVTL-i TS	01.02-	SUMITOMO	
			зад	TOYOTA - COROLLA универсал (_E12J_, _E12T_)	1.4 VVT-i	01.02-	SUMITOMO	
			зад	TOYOTA - COROLLA универсал (_E12J_, _E12T_)	1.6 VVT-i	01.02-	SUMITOMO	
			зад	TOYOTA - COROLLA универсал (_E12J_, _E12T_)	1.8 4X4	12.01-	SUMITOMO	
			зад	TOYOTA - COROLLA универсал (_E12J_, _E12T_)	2.0 D-4D	01.02-	SUMITOMO	
			зад	TOYOTA - COROLLA седан (_E12J_, _E12T_)	1.6 VVT-i	08.02-	SUMITOMO	
			зад	TOYOTA - COROLLA седан (_E12J_, _E12T_)	1.8	06.04-	SUMITOMO	
			зад	TOYOTA - COROLLA ALTIS	1.3	11.01-05.04	SUMITOMO	
			зад	TOYOTA - COROLLA ALTIS	1.5	11.01-05.04	SUMITOMO	
			зад	TOYOTA - COROLLA Verso (_E12J_)	1.4 VVT-i	01.02-05.04	SUMITOMO	
			зад	TOYOTA - COROLLA Verso (_E12J_)	1.6 VVT-i	01.02-05.04	SUMITOMO	
			зад	TOYOTA - COROLLA Verso (_E12J_)	1.8 VVT-i	01.02-05.04	SUMITOMO	
			зад	TOYOTA - COROLLA Verso (_E12J_)	2.0 D-4D	01.02-05.04	SUMITOMO	
			зад	TOYOTA - ECHO седан	1.5 VVTi	04.99-08.05	SUMITOMO	
			зад	TOYOTA - ECHO Наклонная задняя часть	1.5 VVTi	04.03-08.05	SUMITOMO	
			зад	TOYOTA - MATRIX	1.8 VVTi	09.01-02.04	SUMITOMO	
			зад	TOYOTA - PRIUS седан (NHW11_)	1.5	05.00-01.04	SUMITOMO	
			зад	TOYOTA - PRIUS Наклонная задняя часть	1.5	08.03-	SUMITOMO	
			зад	TOYOTA - VITZ	1.5	04.03-08.05	SUMITOMO	
			зад	TOYOTA - YARIS (_CP10)	1.0 16V	04.99-	SUMITOMO	
			зад	TOYOTA - YARIS (_CP10)	1.3 16V	11.99-	SUMITOMO	
			зад	TOYOTA - YARIS (_CP10)	1.5 VVT-i TS	04.01-	SUMITOMO	
	зад	TOYOTA - YARIS (_CP10)	1.4 D-4D	12.01-	SUMITOMO			
	зад	TOYOTA - YARIS VERSO (NC/LP2_)	1.3	11.99-	SUMITOMO			
	зад	TOYOTA - YARIS VERSO (NC/LP2_)	1.5	03.00-	SUMITOMO			
	зад	TOYOTA - YARIS VERSO (NC/LP2_)	1.4 D-4D	12.01-	SUMITOMO			
8	D136	446642060	зад	TOYOTA - CAMRY (_V30)	2.4 VVTi LE	01.06-	AKEBONO	24338
		446633160	зад	TOYOTA - CAMRY (_V30)	3.5 VVTi XLE	01.06-	AKEBONO	
		446606070	зад	TOYOTA - CAMRY седан (_V40)	2.4 VVTi LE	01.06-	AKEBONO	
			зад	TOYOTA - CAMRY седан (_V40)	3.5 VVTi LE	01.06-	AKEBONO	
			зад	TOYOTA - RAV 4 III (ACA_, ACE_)	2.0 VVT-i	03.06-	AKEBONO	
			зад	TOYOTA - RAV 4 III (ACA_, ACE_)	2.4 VVT-i	11.05-	AKEBONO	
			зад	TOYOTA - RAV 4 III (ACA_, ACE_)	3.5 VVT-i	11.05-	AKEBONO	
	зад	TOYOTA - RAV 4 III (ACA_, ACE_)	2.2 D-4D	03.06-	AKEBONO			
<b>GEELY</b>								
9	D116	1014003350	перед	GEELY MK	1.6	07-		23510/23511/23512
		1014003350	перед	GEELY MK-2	1.5	09-		
<b>BYD</b>								
10	D116	3501130	перед	BYD-F3	1.6	09.05-		23510/23511/23512
<b>CHERY</b>								
11	D220	A21-6GN3501080BA	перед	CHERY FORA	1.6	07-		
			перед	CHERY FORA	2.0	07-		
			перед	CHERY TIGGO	1.8	08-		
			перед	CHERY TIGGO	2.0	08-		
			перед	CHERY TIGGO	2.4	08-		
	перед	CHERY TIGGO	2.4 4x4	08-				
12	D223	S21-3501080	перед	CHERY Kimo (A1)	1.3	04.07-		23662
			перед	CHERY QQ6	1.1	10.07-		
			перед	CHERY QQ6	1.3	10.07-		
			перед	CHERY JAGGI	1.1	10.07-		
			перед	CHERY JAGGI	1.3	10.07-		

## НОВИНКИ 2010 ГОДА

№	Код DAfmi	Код OEM	Ось авто	Модель автомобиля	V двигателя	Год выпуска	i	Код WVA
<b>SUZUKI</b>								
13	D223	5581075F31	перед	SUZUKI - WAGON R+ (EM)	1.0	02.98-05.00		23662
		5581075F00	перед	SUZUKI - WAGON R+ (EM)	1.2	02.98-05.00		
		5581075F10	перед	SUZUKI - WAGON R+ (EM)	1.2 4WD	02.98-05.00		
		5581075F11	перед	SUZUKI - WAGON R+ (EM)	1.0	08.00-07.03		
		5581075F12	перед	SUZUKI - WAGON R+ (EM)	1.3	05.00-		
		5581075F31000						
		5581075F00000						
		5581075F12000						
		5581075F11000						
		5581075F10000						
5581075F30								
<b>CHEVROLET</b>								
14	D227	96800089		зад CHEVROLET - LACETTI	1.4 16V	07-		
				зад CHEVROLET - LACETTI	1.6	07-		
				зад CHEVROLET - LACETTI	1.8	07-		
				зад CHEVROLET - LACETTI	2.0 D	07-		
<b>HONDA</b>								
15	D250	45022SZ3G00	перед	HONDA - INSPIRE	3.2	09.98-08.03	NISSIN	23729
		45022S3N000	перед	HONDA - LEGEND III (KA9)	3.5 i 24V	02.96-	NISSIN	
			перед	HONDA - ODYSSEY (RA_)	2.3 4x4	10.97-06.02	NISSIN	
			перед	HONDA - ODYSSEY	2.3	07.02-09.03	NISSIN	
			перед	HONDA - ODYSSEY	2.4	10.05-	NISSIN	
			перед	HONDA - SHUTTLE (RA)	2.3 16V 4x4	10.97-06.02	NISSIN	
			перед	HONDA - SHUTTLE (RA)	3.0	10.97-06.02	NISSIN	
			перед	HONDA - SHUTTLE (RA)	3.0 4x4	10.97-06.02	NISSIN	
		45022SMA000	перед	HONDA - ACCORD VIII (CL_ CM_)	2.4	09.06-	SUMITOMO	
		45022SJFE00	перед	HONDA - ACCORD VIII (CL_ CM_)	2.4 Vtec E	02.03-09.05	SUMITOMO	
		45022S7AE00	перед	HONDA - ACCORD VIII (CL_ CM_)	3.0	09.06-	SUMITOMO	
		45022S7AE50	перед	HONDA - CIVIC VI	1.6	09.05-09.05	SUMITOMO	
		45022SJF305	перед	HONDA - CIVIC VI	1.8	09.05-09.05	SUMITOMO	
		45022SNBE00	перед	HONDA - CIVIC VII Hatchback (FD_)	1.6	09.05-	SUMITOMO	
			перед	HONDA - CIVIC VII (FD_)	1.6	09.05-	SUMITOMO	
			перед	HONDA - CIVIC VII (FD_)	1.8	09.05-	SUMITOMO	
			перед	HONDA - EDIX взн (BE_)	1.7	08.04-09.06	SUMITOMO	
			перед	HONDA - FR-V	1.7	02.05-	SUMITOMO	
			перед	HONDA - FR-V	1.8	01.07-	SUMITOMO	
			перед	HONDA - FR-V	2.0	02.05-	SUMITOMO	
			перед	HONDA - FR-V	2.2 i CTDi	07.05-	SUMITOMO	
			перед	HONDA - STEPWAGON	2.0	10.05-	SUMITOMO	
			перед	HONDA - STEPWAGON	2.4 Z FF	10.05-	SUMITOMO	
			перед	HONDA - STREAM (RN)	1.7 16V	05.01-	SUMITOMO	
			перед	HONDA - STREAM (RN)	2.0 16V	05.01-	SUMITOMO	
			перед	HONDA - STREAM	1.8 Vtec	10.05-	SUMITOMO	
			перед	HONDA - STREAM	2.0 Vtec	10.05-	SUMITOMO	
16	D512	45022SWWG01	перед	HONDA - CR-V III	2.2 i-CTDi	01.07-	BOSCH	24638 /24639/24640
			перед	HONDA - CR-V III	2.0 i-VTEC	01.07-	BOSCH	
17	D513	43022SWWG01		зад HONDA - CR-V III	2.2 i-CTDi	01.07-	BOSCH	
		43022SWWG02		зад HONDA - CR-V III	2.0 i-VTEC	01.07-	BOSCH	
<b>NISSAN</b>								
18	D514	D1060JD00A	перед	NISSAN - QASHQAI (J10, JJ10)	1.6	02.07-	AKEBONO	24632
		D1060JE00A	перед	NISSAN - QASHQAI (J10, JJ10)	2.0	02.07-	AKEBONO	
		D1080JE00A	перед	NISSAN - QASHQAI (J10, JJ10)	1.5 dCi	02.07-	AKEBONO	
			перед	NISSAN - QASHQAI (J10, JJ10)	2.0 dCi	02.07-	AKEBONO	
			перед	NISSAN - X-TRAIL (T31)	2.0 FWD	03.07-	AKEBONO	
			перед	NISSAN - X-TRAIL (T31)	2.0	06.07-	AKEBONO	
			перед	NISSAN - X-TRAIL (T31)	2.5	06.07-	AKEBONO	
			перед	NISSAN - X-TRAIL (T31)	2.0 dCi	06.07-	AKEBONO	

## НОВИНКИ 2010 ГОДА

№	Код DAfm1	Код OEM	Ось авто	Модель автомобиля	V двигателя	Год выпуска	i	Код WVA
<b>MAZDA</b>								
19	<b>Д515</b>	GSYD3328ZA	перед	MAZDA 6 II (GH)	1.8	04.07-		
			перед	MAZDA 6 II (GH)	2.0	04.07-		
			перед	MAZDA 6 II (GH)	2.0 D	04.07-		
			перед	MAZDA 6 II (GH)	2.5	04.07-		
			перед	MAZDA 6 II Hatchback (GH)	1.8	04.07-		
			перед	MAZDA 6 II Hatchback (GH)	2.0	04.07-		
			перед	MAZDA 6 II Hatchback (GH)	2.0 D	04.07-		
			перед	MAZDA 6 II Hatchback (GH)	2.5	04.07-		
			перед	MAZDA 6 II Estate (GH)	1.8	02.08-		
			перед	MAZDA 6 II Estate (GH)	2.0	02.08-		
			перед	MAZDA 6 II Estate (GH)	2.0 D	02.08-		
			перед	MAZDA 6 II Estate (GH)	2.5	02.08-		
<b>RENAULT</b>								
20	<b>Д516</b>	7701207673	перед	RENAULT - MEGANE II (BM0/1_, CM0/1_)	1.4 16V	10.03-	BOSCH	23934
				RENAULT - MEGANE II седан (LM0/1_)	1.4	09.03-	BOSCH	
21	<b>Д514</b>	410600023R	перед	RENAULT - KOLEOS	2.5	09.08-	AKEBONO	24632
			перед	RENAULT - KOLEOS	2.5 4x4	09.08-	AKEBONO	
			перед	RENAULT - KOLEOS	2.0 dCi	09.08-	AKEBONO	

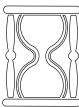
DAFMI	передняя / задняя			W.V.A
-------	----------------------	---	--	-------

Д126	п	TOYOTA	Avensis	03-	23480/ 23481/ 23768
			Corolla	04-	
Д161И	п	AUDI	A4	99-04	21945
Д188	з	MITSUBISHI	Galant	92-96, 99-03	21706/ 21707/ 21708
			Space runner	91-03	
			Space Wagon	91-98	
			Eclipse	89-99	
			Pajero Pinin	99-	
			RVR	91-99	
			Sapporo	87-90	
			Shogun Pinin	99-	
Д191	п	HYUNDAI	Coupe	02-	23891
			Sonata	01--04	
			Sonica	02-	
			Tiburon	04-	
			Tucson	04-	
			Tuscani	01-	
		KIA	Sportage	04-	
Д192	п	MITSUBISHI	Galant	00-03	23584
			Lancer	03-	
			Space runner	00-03	
Д193	п	KIA	Cerato	04-	
Д194	п	AUDI	A3	03-	23587/ 23588/ 23589
		SEAT	Toledo	04-	
		SKODA	Octavia	04-	
		VOLKSWAGEN	Caddy	04-	
			Golf	03-	
			Jetta	05-	
			Passat	05-	
			Touran	03-	
Д195	п	CITROEN	C4	04-	23589/ 24153
		PEUGEOT	307	03-	
Д196	п	KIA	Carens	99-02	
			Clarus	99-01	
			Credos	96-00	
			Rio	02--05	
Д197	п	NISSAN	Almera	00-	23093/ 23463
			Primera	98-01	
Д198	з	HYUNDAI	Santa Fe	00-	23543
			Lavita	00-	
			Matrix	01-	
			Sonata	98-	
			Sonica	98-	
			Tucson	04-	
			XG25	99-05	
			XG30	99-05	
XG350	02-				
Д199	п	MAZDA	6	02-	24046/ 24047/ 24048
			Atenza	02-	
Д200	п	NISSAN	Almera	00-03	23094/ 23095
			Primera	02-	
Д200И	п	HONDA	Accord	98-02	23094/ 23095
Д201	п	TOYOTA	Corolla	01-	
Д202	п	RENAULT	Kangoo	01-	23930
			Megane	02-	
			Scenic	03-	

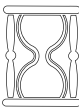
DAFMI	передняя / задняя			W.V.A
-------	-------------------	---	--	-------

Д203	з	AUDI	A3	04-	23914
			A6	04-	
		SKODA	Octavia	04-	
		VOLKSWAGEN	Caddy	04-	
			Jetta	05-	
			Passat	05-	
			Touran	03-	
Д204	п	NISSAN	Micra	03-	23973
			Micra CC	05-	
		RENAULT	Clio	05-	
			Modus	04-	
Д204И	п	SUZUKI	Swift	05-	
Д205	п	FORD	Mondeo	00-	23278/ 23279/ 23321
Д206	з	FORD	Focus	04-	24137
		MAZDA	5	05-	
Д209	п	HYUNDAI	Santa Fe	00-	23569
Д210	п	TOYOTA	4-Runner	89-91	21679/ 21680/ 21681/ 21785
			Hi-Lux	88-	
			Land cruiser	90-02	
Д211	з	HYUNDAI	Coupe	96-	21553/ 21554/ 21555
			Tiburon	99-	
			Tuscani	01-	
			Avante	95--03	
			Elantra/Lantra	90-03	
		KIA	Cerato	04-	
Д212	з	FORD	Transit	06-	
Д214	п	HYUNDAI	Avante	01--03	24031/ 24032/ 24033
			Elantra/Lantra	01--03	
			Lavita	02-	
			Matrix	02-	
Д215	п	TOYOTA	Rav 4	00-	23585
Д216	п	CHERY	Amulet		
Д217	п	FORD	Transit	06-	
Д218	п	MAZDA	6	02-	
Д219	п	CITROEN	C4	04-	24101/ 23599
			Xsara Picasso	01-	
			Berlingo	00-	
		PEUGEOT	Partner	01-	
			Ranch	01-	
Д221	п	УАЗ	Патриот		
Д222	з	MAZDA	626	97-02	20645/ 24045
			6	02-	
			Atenza	02-	
			323	98-03	

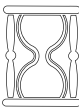
DAFMI	передняя / задняя			W.V.A
-------	----------------------	---	--	-------

Д225	п	BMW	300 500	05- 03-	23347/ 23794/ 23968	
Д231	п	RENAULT	Espace	02-	23245/ 23247/ 23248	
			Grand Espace	02-		
			Laguna	01-		
			Scenic RX4	02--04		
			Vel Satis	02-		
Д232	п	KIA	Sorento	02-	24068/ 24069/ 24070	
Д233	п	KIA	Carens II Ceed	02-		
Д234	з	KIA	Pride	05-		
			Rio New	05-		
			Ceed	05-		
Д235	з	KIA	Clarus	96-01	23455/ 23456/ 23457	
			Carens	99-		
			Credos	96-00		
			Mentor	99-		
			Sephia	01-		
			Shuma	98-		
			Speetra	01-		
Д343	п	HYUNDAI	Porter (TarA3) H-100			
Д344	з	MITSUBISHI	Outlander	03-	24014/24015	
			Lancer	03-		
Д345	з	KIA	Sorento	02-		
Д361	з	TOYOTA	Avensis	03-		
			Corolla	04-		
Д362	з	FORD	Mondeo	00-		
Д489	з	TOYOTA	Corolla	01-		
Д495	з	TOYOTA	RAV-4	05-		
Д503	п	GREAT WALL	Hoover	06-		
Д505	з	GREAT WALL	Hoover	06-		
Д507	п	MITSUBISHI	Colt	04-	21796	
Д613	п	FORD MAZDA	Focus	03-	23723/23724	
			3	03-		
			5	05-		
Д647	п	NISSAN	Almera	06-		
Д714	п	FORD	Fiesta	99-	23202/23203	
Д934	з	CITROEN	C4	04-	23600	
		PEUGEOT	307	03-		
Д957И3	п	AUDI	A4	97-	21938/21939	
			A6	97-04		
Д966	з	NISSAN	Primera	02-	23482/ 23483	
			RENAULT	Espace		02-
				Grand Espace		02-
				Laguna		01-
		MAZDA	3	03-		
			FORD	Focus		03-



## УСЛОВНЫЕ ОБОЗНАЧЕНИЯ, принятые в каталоге, в разделах:

«Тормозные колодки для автомобилей иностранного производства»

«Тормозные колодки для автомобилей производства стран СНГ»

<b>1</b>	<b>2</b>	<b>3</b>	<b>4</b>
		i	i
		DAFMI	DAFMI
		W.V.A	W.V.A
		5	7

**1** Марка, модель и модификация автомобиля.

**2** Даты начала и окончания выпуска модели автомобиля в данной модификации. Отсутствие даты окончания выпуска говорит о том, что автомобиль не снят с производства или же о том, что дата окончания выпуска неизвестна..

**3** Данные по передней оси.

**4** Данные по задней оси

**5** Разработчик тормозной системы:

AKE – Akebono                      LUC – Lucas / Girling

AP – Lockheed                      GM – General Motors

ATE – Continental – Teves      KH – Kelsey – Hayes

BOX – Bendix                      PER – Perrot

BRE – Brembo                      SUM – Sumitomo

CIT – Citroen

**6** Номер колодки **ДАФМИ** в базовой комплектации.

**7** Номер W.V.A.

## УСЛОВНЫЕ ОБОЗНАЧЕНИЯ, принятые в каталоге, в разделе:

«Графические изображения и размеры»

<b>1</b>	<b>2</b>	<b>3</b>	<b>4</b>
			W.V.A
<b>5</b>			

**1** Номер колодки **ДАФМИ** в базовой комплектации.



**2** Номер колодки **ДАФМИ** в дополнительных комплектациях:

И, И1, И2 – с индикатором износа.

**3** Марка автомобиля.

**4** Код W.V.A.

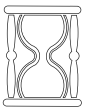
**5** Дополнительная информация по комплектации данной колодки.

							
		i	DAFMI	W.V.A	i	DAFMI	W.V.A

## ALFA ROMEO

<b>Alfa 33</b>							
1.4 IE L W/ABS	07.90-06.94				LUC	Д938	21103
1.5 IE W/ABS	07.90-06.94				LUC	Д938	21103
1.7 IE W/ABS	07.90-06.94				LUC	Д938	21103
<b>Alfa 145</b>							
1.4 IE	07.94-09.96	LUC	Д373	20838			
1.4 IE W/ABS	07.94-09.96	LUC	Д373	20838	LUC	Д938	21103
1.6 IE	07.94-11.96	LUC	Д373	20838			
1.6 IE W/ABS	07.94-11.96	LUC	Д373	20838	LUC	Д938	21103
1.7 IE	07.94-09.96	LUC	Д373	20838	LUC	Д938	21103
1.9 TD	07.94-11.96	LUC	Д373	20838			
1.9 TD W/ABS	07.94-11.96	LUC	Д373	20838	LUC	Д938	21103
2.0 TS 16V	09.95-02.99	LUC	Д373	20838	LUC	Д938	21103
<b>Alfa 146</b>							
1.4 IE	12.94-09.96	LUC	Д373	20838			
1.4 IE W/ABS	12.94-09.96	LUC	Д373	20838	LUC	Д938	21103
1.6 IE	12.94-1997	LUC	Д373	20838			
1.6 IE W/ABS	12.94-1997	LUC	Д373	20838	LUC	Д938	21103
1.7 IE	12.94-09.00	LUC	Д373	20838	LUC	Д938	21103
1.9 TD W /ABS	12.94-02.99	LUC	Д373	20838	LUC	Д938	21103
1.9 TD	12.94-02.99	LUC	Д373	20838			
2.0 TS 16V	09.95-02.99	LUC	Д373	20838	LUC	Д938	21103
<b>Alfa 155</b>							
1.6 All	05.96-12.97	LUC	Д373	20838	LUC	Д938	21103
1.7 TWIN SPARK	06.93-03.96	LUC	Д373	20838	LUC	Д938	21103
1.8 TWIN SPARK	02.92-03.95	LUC	Д373	20838	LUC	Д938	21103
1.9 TURBO D	06.93-03.95	LUC	Д373	20838	LUC	Д938	21103
2.0 Q4	09.92-03.95	LUC	Д373	20838	LUC	Д938	21103
2.0 TURBO 4 WD	02.92-03.96	LUC	Д711И2	21074	LUC	Д938	21103
2.0 TWIN SPARK	02.92-12.97	LUC	Д373	20838	LUC	Д938	21103
2.5 V6	02.92-03.95	LUC	Д711И2	21074	LUC	Д938	21103
2.5 TURBO D	06.93-12.97	LUC	Д711И2	21074	LUC	Д938	21103
<b>Alfa 164</b>							
2.0 TWIN SPARK	07.87-06.89	LUC	Д711И2	21074	LUC	Д369	20668
2.0 I TURBO	07.87-12.92	LUC	Д711И2	21074	LUC	Д369	20668
2.0 Twin Spark	07.89-12.98	LUC	Д792И	21182	LUC	Д369	20668
2.0 V6 TURBO	04.88-02.95	LUC	Д711И2	21074	LUC	Д369	20668
2.4 TURBO D	06.87-08.92	LUC	Д711И2	21074	LUC	Д369	20668
2.5 TURBO D	08.92-02.95	LUC	Д711И2	21074	LUC	Д369	20668
3.0 V6 QUADRO	06.87-08.92	LUC	Д711И2	21074	LUC	Д369	20668
3.0 V6 24V	08.92-02.95	LUC	Д711И2	21074	LUC	Д369	20668
<b>Alfa GTV</b>							
2.0	07.78-02.83	ATE	Д602	20034			
2.0 Twin Spark -/L	03.95-08.95	LUC	Д711И1	21074	LUC	Д938	21103
2.0 Turbo -/L	03.95-08.95	LUC	Д711И1	21074	LUC	Д938	21103
2.5	11.80-02.87	ATE	Д276	20588			
<b>Alfa GTV</b>							
2.0 Twin Spark	03.95-08.95	LUC LUC	Д711И1 или Д373	21074 20838	LUC	Д938	21103
3.0 All	03.95-07.95	LUC	Д373	20838	LUC	Д938	21103



# Тормозные колодки для автомобилей иностранного производства



		i	DAFMI	W.V.A	i	DAFMI	W.V.A

## AUDI

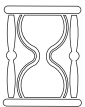

<b>50</b>							
1.1	09.74-08.75	ATE	Д608	20228	VAG	ДА366	
1.3 GL	09.75-07.77	ATE	Д608	20228	VAG	ДА366	
1.3 LS, GLS	09.75-07.78	ATE	Д608	20228	VAG	ДА366	
<b>80 1.3</b>							
1.3 C, CL	08.81-07.84	LUC	Д253	20574	ATE	ДА366	
1.3 GL	08.77-07.81	ATE	Д608	20228	ATE	ДА366	
1.3 GL	08.81-07.84	LUC	Д253	20574	ATE	ДА366	
1.3 L	07.72-07.81	ATE	Д608	20228	ATE	ДА366	
1.3 60 PS	08.84- 86	LUC	Д253	20574	ATE	ДА366	
<b>80 1.5</b>							
1.5 AUTOMATIC	-07.77	ATE	Д598	20228	ATE	ДА366	
1.5 AUTOMATIC	08.77-07.81	LUC	Д253	20574	ATE	ДА366	
<b>80 1.6</b>							
1.6	08.78-07.82	LUC	Д253	20574	ATE	ДА366	
			Д327	20669	ATE	ДА884	
1.6	09.86-09.91	LUC	или Д328	20901	ATE	или ДА885	
					LUC	Д369	20668
			Д327	20669	ATE	или ДА327	
1.6	09.91-12.94	LUC	или Д328	20901	ATE	или ДА884	
1.6 AUTOMATIC	-07.77	ATE	Д598	20228	ATE	ДА366	
1.6 AUTOMATIC	08.77-07.81	LUC	Д253	20574	ATE	ДА366	
1.6 C	09.90-12.94	LUC	Д328	20901	ATE	ДА884	
1.6 D	08.80-07.86	LUC	Д253	20574	ATE	ДА366	
					ATE	ДА884	
1.6 D	09.86-08.91	LUC	Д327	20669	ATE	или ДА885	
					LUC	Д369	20668
1.6 E	06.93-12.94	LUC	или Д328	20901	ATE	или ДА884	
			Д327	20669	LUC	Д369	20668
1.6 E AVANT	06.93-10.95	LUC	или Д328	20901	ATE	или ДА884	
1.6 GL	08.75-07.78	ATE	Д598	20228	ATE	ДА366	
					ATE	ДА366	
1.6 GL	08.81-07.84	LUC	Д253	20574	ATE	или ДА885	
					ATE	ДА366	
1.6 GLE	08.81-07.84	LUC	Д253	20574	ATE	или ДА885	
1.6 GLS, GT, LS	08.75-07.78	ATE	Д598	20228	ATE	ДА366	
1.6 GTE	09.75-08.78	ATE	Д608	20228	ATE	ДА366	
1.6 TD	08.80-07.86	LUC	Д253	20574	ATE	ДА885	
					ATE	ДА884	
1.6 TD	09.86-08.91	LUC	Д327	20669	ATE	или ДА885	
					ATE	ДА327	
1.6 TD	11.90-12.94	LUC	Д328	20901	ATE	или ДА884	



							
		i	DAFMI	W.V.A	i	DAFMI	W.V.A

1.6 70 PS	09.90-12.94	LUC	Д328	20901	ATE	ДА327 или ДА884	
<b>80 1.8</b>							
1.8	10.86-01.90	LUC	Д327 или Д328	20669 20901	ATE	ДА327 или ДА884	
1.8	09.90-12.94	LUC	Д328	20901	ATE	ДА884	
1.8 AUTOMATIC	08.81-07.84	LUC	Д253	20574	ATE	ДА885	
1.8 E	06.86-08.91	LUC	Д327 или Д328	20669 20901	ATE	ДА884 или ДА885	
1.8 QUATTRO E	09.86-12.94	LUC	Д327 или Д328	20669 20901	LUC	Д369	20668
1.8 QUATTRO (85)	01.83-05.87	LUC	Д332	20669	LUC	Д369	20668
1.8 S	09.86-01.90	LUC	Д327 или Д328	20669 20901	ATE	ДА884 или ДА885	
1.8 90 PS	09.90-12.94	LUC	Д328	20901	ATE	ДА327 или ДА884	
<b>80 1.9</b>							
1.9 D	08.89-08.91	LUC	Д327	20669	ATE	ДА884 или ДА885	
1.9 D COMFORT	09.90-12.94	LUC	Д328	20901	ATE	ДА327 или ДА884	
1.9 E	09.86-07.88	LUC	Д327 или Д328	20669 20901	ATE	ДА884	
1.9 E	86-08.89	LUC	Д327 или Д328	20669 20901	LUC	Д369	20668
1.9 QUATTRO E	04.88-12.94	LUC	Д327 или Д328	20669 20901	LUC	Д369	20668
1.9 TD, TDI	01.91-12.94	LUC	Д327 или Д328	20669 20901	LUC	Д369 или ДА884	20668
1.9 5 CYL	08.81-07.84	LUC	Д253	20574	ATE	ДА885	
<b>80 2.0-2.5</b>							
2.0	10.90-12.94	LUC	Д327 или Д328	20669 20901	LUC	Д369 или ДА327 или ДА884	20668
2.0 AVANT	07.92-10.95	LUC	Д327 или Д328	20669 20901	ATE	ДА327 или ДА884	
2.0 E	08.88-12.94	LUC	Д327 или Д328	20669 20901	LUC	Д369 или ДА884	20668

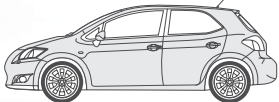
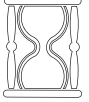
# Тормозные колодки для автомобилей иностранного производства

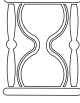

							
		i	DAFMI	W.V.A	i	DAFMI	W.V.A
2.0 E AVANT	07.92-10.95	LUC	Д327 или Д328	20669 20901	LUC ATE	Д369 или ДА884	20668
2.0 QUATTRO (85)	01.83-05.87	LUC	Д332 или Д714	20669 20901	LUC	Д369	20668
2.0 16V	09.89-12.94	LUC	Д327 или Д328	20669 20901	LUC	Д369	20668
2.0 I	09.89-12.94	LUC	Д327 или Д328	20669 20901	LUC ATE ATE	Д369 или ДА327 или ДА884	20668
2.0 I COMFORT EDITION	11.90-12.94	LUC	Д327 или Д328	20669 20901	LUC	Д369	20668
2.0 I QUATTRO	09.90-12.94				LUC	Д369	20668
2.0 I 16V QUATTRO SPORT	11.90-12.94				LUC	Д369	20668
2.0 I 16V, 20V, S2 COUPE	08.90-12.94				LUC	Д369	20668
2.1 QUATTRO (85)	01.83-05.87	LUC	Д332	20669	LUC	Д369	20668
2.2 QUATTRO (85)	01.83-05.87	LUC	Д332	20669	LUC	Д369	20668
2.2 QUATTRO TURBO GT	09.86-12.94	LUC	Д327 или Д328	20669 20901	LUC	Д369	20668
2.3 E	09.91-12.94	LUC	Д327 или Д328	20669 20901	LUC	Д369	20668
2.3 E AVANT	07.92-10.95	LUC	Д327 или Д328	20669 20901	LUC ATE	Д369 или ДА884	20668
2.5 25V	05.90-12.94				LUC ATE	Д369 или ДА884	20668
2.8 E AVANT	09.91-10.95				LUC	Д369	20668
<b><u>90 1.6-2.3</u></b>							
1.6 TURBO D	09.88-08.91	LUC	Д332	20669	LUC	Д369	20668
2.0	10.84-03.87	LUC	Д328	20901	LUC ATE	Д369 или ДА885	20668
2.0	09.87-07.91	LUC	Д327 или Д328	20669 20901	LUC	Д369	20668
2.2	10.84-03.87	LUC	Д328	20901	LUC	Д369	20668
2.2 E	04.87-07.91	LUC	Д327 или Д328	20669 20901	LUC	Д369	20668
2.2 E QUATTRO	04.87-09.91	LUC	Д328	20901	LUC	Д369	20668
2.2 QUATTRO	11.84-03.87	LUC	Д328	20901	LUC	Д369	20668
2.3 E	04.87-07.91	LUC	Д327 или Д328	20669 20901	LUC	Д369	20668
2.3 E QUATTRO	04.87-07.91	LUC	Д328	20901	LUC	Д369	20668
2.3 E 20V	08.88-07.91				LUC	Д369	20668
2.3 E 20V QUATTRO	06.88-09.91				LUC	Д369	20668



							
		i	DAFMI	W.V.A	i	DAFMI	W.V.A

<b>100 1.6</b>							
1.6	08.80-07.82	LUC	Д253	20574	VAG	ДА366	
1.6	08.82-07.84	LUC	Д328	20901	VAG	ДА366	
1.6 C, CL, GL, GLS	08.79-07.82	LUC	Д253	20574	VAG	ДА366	
1.6 GL COUPE	08.80-07.82	LUC	Д253	20574	VAG	ДА366	
1.6 L, LS, S	08.79-07.82	LUC	Д253	20574	VAG	ДА366	
<b>100 1.8</b>							
1.8	08.82-11.90	LUC	Д328	20901			
1.8 AVANT	08.82-11.90	LUC	Д328	20901			
1.8 CC	87- 90	LUC	Д328	20901	LUC	Д369	20668
1.8 CC	08.82-07.84	LUC	Д328	20901			
1.8 CD 4CYL	08.82-07.84	LUC	Д328	20901			
1.8 CS	08.82-07.84	LUC	Д328	20901			
1.8 GL COUPE	08.80-07.84	LUC	Д253	20574			
1.8 QUATTRO 14" WHEELS	87- 90	LUC	Д328	20901	LUC	Д369	20668
1.8 W/ABS	08.82-01.91	LUC	Д328	20901	LUC	Д369	20668
1.8 W/ABS AVANT	08.82-01.91	LUC	Д328	20901	LUC	Д369	20668
1.8 I	87-01.90	LUC	Д328	20901			
<b>100 1.9</b>							
1.9	08.82-07.84	LUC	Д328	20901			
1.9 AVANT	08.82-07.84	LUC	Д328	20901			
1.9 CS, CD	08.82-07.84	LUC	Д328	20901			
1.9 5 CYL CC	08.82-07.84	LUC	Д328	20901			
1.9 GT COUPE	10.80-07.84	LUC	Д253	20574			
<b>100 2.0</b>							
2.0	10.78-07.82	LUC	Д253	20574	VAG	ДА366	
2.0	08.82-11.90	LUC	Д328	20901	ATE	ДА327 (-ABS)	
2.0 AVANT	08.84-11.90	LUC	Д328	20901	ATE	ДА327 (-ABS)	
2.0 AVANT D, D	88- 90	LUC	Д328	20901	LUC	Д369	20668
2.0 AVANT W/ABS	08.84-11.90	LUC	Д328	20901	LUC	Д369	20668
2.0 D	10.78-07.82	LUC	Д253	20574	VAG	ДА366	
2.0 D	08.82-07.89	LUC	Д328	20901	ATE	ДА327 (-ABS)	
2.0 D AVANT	08.82-07.89	LUC	Д328	20901	ATE	ДА327 (-ABS)	
2.0 E	09.87- 90	LUC	Д328	20901	LUC	Д369	20668
2.0 E	03.91-06.94	ATE	Д957И	20676	LUC	Д369	20668
2.0 E AVANT	09.87- 90	LUC	Д328	20901	LUC	Д369	20668
2.0 E AVANT QUATTRO	12.90-07.92	ATE	Д957И	20676	LUC	Д369	20668
2.0 E QUATTRO	12.90-07.92	ATE	Д957И	20676	LUC	Д369	20668
2.0 TURBO D	08.82-11.90	LUC	Д328	20901	ATE	ДА327 (-ABS)	
2.0 TURBO D AVANT	08.82-11.90	LUC	Д328	20901	ATE	ДА327 (-ABS)	
2.0 W/ABS	08.84-11.90	LUC	Д328	20901	LUC	Д369	20668
2.0 E AVANT	03.91-06.94	ATE	Д957И	20676	LUC	Д369	20668
2.0 16V	12.90-06.94	ATE	Д957И	20676	LUC	Д369	20668
2.0 16V AVANT	12.90-06.94	ATE	Д957И	20676	LUC	Д369	20668
2.0 I AVANT	09.87- 90	LUC	Д328	20901	LUC	Д369	20668
2.0 I CD	88-01.91	LUC	Д328	20901	LUC	Д369	20668
2.0 I CD AVANT	04.88-01.91	LUC	Д328	20901	LUC	Д369	20668
<b>100 2.2</b>							
2.2	08.82-11.90	LUC	Д328	20901	ATE	ДА327 (-ABS)	
2.2 AVANT	08.82-11.90	LUC	Д328	20901	ATE	ДА327 (-ABS)	
2.2 AVANT W/ABS	08.82-11.90	LUC	Д328	20901	LUC	Д369	20668
2.2 CC, CD, CS	08.82-04.84	LUC	Д328	20901	LUC	Д369	20668

# Тормозные колодки для автомобилей иностранного производства

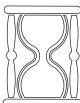

		i	DAFMI	W.V.A	i	DAFMI	W.V.A
2.2 CS	08.84-11.90				LUC	Д369	20668
2.2 CD5E	08.78-07.81	LUC	Д327	20669	VAG	ДА366	
2.2 CD5S	07.76-07.82	LUC	Д253	20574	VAG	ДА366	
2.2 CL5E	08.78-07.81	LUC	Д327	20669	VAG	ДА366	
2.2 CS AVANT	08.84-11.90				LUC	Д369	20668
2.2 GL5S	07.76-07.82	LUC	Д253	20574	VAG	ДА366	
2.2 C5E	08.78-07.81	LUC	Д327	20669	VAG	ДА366	
2.2 C5S	07.76-07.82	LUC	Д253	20574	VAG	ДА366	
2.2 GL5E	08.78-07.81	LUC	Д327	20669	VAG	ДА366	
2.2 L5E	08.78-07.81	LUC	Д327	20669	VAG	ДА366	
2.2 L5S	07.76-07.82	LUC	Д253	20574	VAG	ДА366	
2.2 TURBO	86- 90				LUC	Д369	20668
2.2 QUATTRO TURBO	88- 90				LUC	Д369	20668
2.2 W/ABS	08.82-11.90	LUC	Д328	20901	LUC	Д369	20668
2.2 5E	08.78-07.81	LUC	Д327	20669	VAG	ДА366	
2.2 5S	07.76-07.82	LUC	Д253	20574	VAG	ДА366	
2.2 I QUATTRO TURBO	88-01.91				LUC	Д369	20668
2.2 I TURBO	88-01.91				LUC	Д369	20668
<b><u>100 2.3</u></b>							
2.3 E	10.86-11.90	LUC	Д328	20901			
2.3 E	88-08.89	LUC	Д328	20901	LUC	Д369	20668
2.3 E	12.90-06.94	ATE	Д957И	20676	LUC	Д369	20668
2.3 E AVANT	10.86-11.90	LUC	Д328	20901			
2.3 E AVANT	12.90-06.94	ATE	Д957И	20676	LUC	Д369	20668
2.3 E AVANT QUATTRO	09.91-06.94	ATE	Д957И	20676	LUC	Д369	20668
2.3 E AVANT W/ABS	10.86-11.90	LUC	Д328	20901	LUC	Д369	20668
2.3 E CS	10.86-11.90				LUC	Д369	20668
2.3 E CS AVANT	10.86-11.90				LUC	Д369	20668
2.3 E QUATTRO	12.90-06.94	ATE	Д957И	20676	LUC	Д369	20668
2.3 E TURBO	08.86-11.90				LUC	Д369	20668
2.3 E TURBO AVANT	08.86-11.90				LUC	Д369	20668
2.3 W/ABS	10.86-11.90	LUC	Д328	20901	LUC	Д369	20668
2.3 I	88-01.91	LUC	Д328	20901	LUC	Д369	20668
<b><u>100 2.4-2.8</u></b>							
2.4 D	04.88-07.94	LUC	Д328	20901	LUC	Д369	20668
2.4 D	05.91-06.94	ATE	Д957И	20676	LUC	Д369	20668
2.4 D AVANT	05.91-06.94	ATE	Д957И	20676	LUC	Д369	20668
2.5 TURBO D	90-02.91	LUC	Д328	20901	LUC	Д369	20668
2.5 TDI	01.90-11.90				LUC	Д369	20668
2.5 TDI	07.91-06.94	ATE	Д957И	20676	LUC	Д369	20668
2.5 TDI AVANT	01.90-11.90				LUC	Д369	20668
2.5 TDI AVANT	07.91-06.94	ATE	Д957И	20676	LUC	Д369	20668
2.6 E	07.92-06.94	ATE	Д957И	20676	LUC	Д369	20668
2.6 E AVANT	07.92-06.94	ATE	Д957И	20676	LUC	Д369	20668
2.6 E AVANT QUATTRO	07.92-06.94	ATE	Д957И	20676	LUC	Д369	20668
2.6 E QUATTRO	04.92-06.94	ATE	Д957И	20676	LUC	Д369	20668
2.8 E	12.90-06.94	ATE	Д957И	20676	LUC	Д369	20668
2.8 E AVANT	12.90-06.94	ATE	Д957И	20676	LUC	Д369	20668
2.8 E AVANT QUATTRO	09.91-06.94	ATE	Д957И	20676	LUC	Д369	20668
2.8 E QUATTRO	12.90-06.94	ATE	Д957И	20676	LUC	Д369	20668
<b><u>200</u></b>							
2.2	08.84-07.85	LUC	Д328	20901	LUC	Д369	20668
2.2 TURBO	08.83-12.85	LUC	Д328	20901	LUC	Д369	20668
2.2 TURBO	02.88-12.91				LUC	Д369	20668
2.2 TURBO AVANT QUATTRO	09.83-12.85	LUC	Д328	20901	LUC	Д369	20668



							
		i	DAFMI	W.V.A	i	DAFMI	W.V.A

2.2 TURBO AVANT QUATTRO	01.86-12.91				LUC	Д369	20668
2.2 TURBO QUATTRO	08.83-11.90	LUC	Д328	20901	LUC	Д369	20668
2.2 TURBO QUATTRO	01.86-11.90				LUC	Д369	20668
2.2 5 E	10.79-08.83	LUC	Д327	20669	LUC	Д369	20668
2.2 5 E	08.82-07.84	LUC	Д328	20901	LUC	Д369	20668
2.2 5T TURBO	10.79-08.83	LUC	Д327	20669	LUC	Д369	20668
2.3	11.89-11.90	ATE	Д957	20676	LUC	Д369	20668
2.3 AVANT	11.89-11.90	ATE	Д957	20676	LUC	Д369	20668
2.3 AVANT QUATTRO	01.90-11.90	ATE	Д957	20676	LUC	Д369	20668
2.3 QUATTRO	01.90-11.90	ATE	Д957	20676	LUC	Д369	20668
2.3 TURBO	08.85-12.91				LUC	Д369	20668
2.3 TURBO AVANT QUATTRO	09.83-12.90				LUC	Д369	20668
2.3 TURBO QUATTRO	01.85-12.90				LUC	Д369	20668
2.3 TURBO QUATTRO	01.85-12.91	LUC	Д328	20901	LUC	Д369	20668
2.8 E	12.90-07.94	ATE	Д957И	20676	LUC	Д369	20668
2.8 E QUATTRO	12.90-07.94	ATE	Д957И	20676	LUC	Д369	20668
<b>A2</b>							
1.4 i 16V	02.00-07.05	KH	Д137И	21974			
1.4 Tdi	02.00-07.05	KH	Д137И	21974	ATE	ДА884	
1.6 FSI	05.02-07.05	KH	Д137И	21974	LUC	Д481	20961
<b>A3</b>							
1.6	12.96-	KH	Д137	21974	LUC	Д481	20961
1.6 O/FSI 17"SW	06.03-	ATE	Д194	23587/ 23588/ 23589			
1.8 20V	09.96-	KH	Д137	21974	LUC	Д481	20961
1.8 20V TURBO	12.96-	ATE	Д957	20676	LUC	Д481	20961
1.8i TURBO QUATTRO	01.96-	ATE	Д957И2	23392	LUC	Д481	20961
1.9 TDI	09.96-	KH	Д137	21974	LUC	Д481	20961
1.9 TDI 17"SW	06.03-	ATE	Д194				
2.0 O/FSI 17"SW	06.03-	ATE	Д194				
2.0 17"SW Alu wheels	06.04-	ATE	Д194	23587/ 23588/ 23589			
2.0 O/TDI 17"SW	06.03-	ATE	Д194				
2.0 Alu wheels QUATTRO	06.04-	ATE	Д194		LUC	Д203	23914
2.0 Steel wheels QUATTRO	06.04-	ATE	Д194		LUC	Д203	23914
3.2 QUATTRO	07.03-				LUC	Д203	23914
3.2	09.04-				LUC	Д203	23914
<b>A4</b>							
1.6	10.94-07.97	LUC	Д885 или Д957	20168	LUC	Д369	20668
		ATE	Д957	20676			
		LUC	Д161	20168			
1.6	08.97-		или Д957	20676	LUC	Д481	20961
		ATE	Д957	20676			
1.6	03.99-09.00	LUC	Д161И	21945	LUC	Д481	20961
1.6	06.00-10.04	LUC	Д161И	21945	LUC	Д481	20961
1.6 AVANT	10.94-07.97	LUC	Д885	20168	LUC	Д369	20668
1.6 AVANT	08.97-	LUC	Д161	20168	LUC	Д481	20961
		LUC	Д885	20168			
1.8	10.94-09.97		или Д957	20676	LUC	Д369	20668
		ATE	Д957	20676			
		LUC	Д161	20168			
1.8	10.97-02.99		или Д957	20676	LUC	Д481	20961
		ATE	Д957	20676			
1.8	03.99-09.00	LUC	Д161И	21945	LUC	Д481	20961



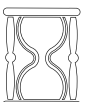

# Тормозные колодки для автомобилей иностранныго производства

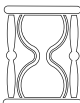

							
		i	DAFMI	W.V.A	i	DAFMI	W.V.A

1.8 O/TURBO	03.99-09.00	ATE	Д957ИЗ	21938	LUC	Д481	20961
1.8 TURBO	10.00-10.04	LUC	Д161И	21945	LUC	Д481	20961
		LUC	Д161	20168		Д369	20668
1.8 AVANT	10.94-		или		LUC	или	
		ATE	Д957	20676		Д481	20961
		LUC	Д161	20168		Д369	20668
1.8 QUATTRO	10.94-		или		LUC	или	
		ATE	Д957	20676		Д481	20961
1.8 QUATTRO	03.99-09.00	LUC	Д161И	21945			
1.8 QUATTRO TURBO	03.99-09.00	ATE	Д957ИЗ	21938			
1.8 QUATTRO TURBO	10.00-10.04	LUC	Д161И	21945	LUC	Д481	20961
		LUC	Д161	20168		Д369	20668
1.8 AVANT QUATTRO	10.94-		или		LUC	или	
		ATE	Д957	20676		Д481	20961
1.9	03.99-09.00	LUC	Д161И	21945	LUC	Д481	20961
1.9 TDI	10.94-07.97	LUC	Д885	20168	LUC	Д369	20668
		ATE	Д957	20676			
1.9 TDI	08.97-02.99		или		LUC	Д481	20961
		LUC	Д161	20168			
1.9 TDI	03.99-09.00	ATE	Д957ИЗ	21938	LUC	Д481	20961
1.9 TDI	10.00-03.01	LUC	Д161И	21945	LUC	Д481	20961
1.9 TDI	04.01-	ATE	Д957ИЗ	21938	LUC	Д481	20961
1.9 TDI AVANT	10.94-07.97	LUC	Д885	20168	LUC	Д369	20668
		ATE	Д957	20676			
1.9 TDI AVANT	08.97-		или		LUC	Д481	20961
		LUC	Д161	20168			
1.9 TDI QUATTRO	03.96-02.99	ATE	Д957	20676	LUC	Д369	20668
1.9 TDI QUATTRO	03.99-09.01	ATE	Д957ИЗ	21938			
1.9 DI/TDI	03.99-09.00	LUC	Д161И	21945	LUC	Д481	20961
2.00/FSI	10.00-10.04	LUC	Д161И	21945	LUC	Д481	20961
2.4	08.97-02.99	ATE	Д957	20676	LUC	Д481	20961
2.4	03.99-10.04	ATE	Д957ИЗ	21938	LUC	Д481	20961
2.4 QUATTRO	08.97-02.99	ATE	Д957	20676	LUC	Д481	20961
2.4 QUATTRO	03.99-09.00	ATE	Д957ИЗ	21938			
2.5 TDI	08.97-02.99	ATE	Д957	20676	LUC	Д481	20961
2.5 TDI	03.99-09.00	ATE	Д957ИЗ	21938	LUC	Д481	20961
2.5 TDI	10.00-05.03	ATE	Д957ИЗ	21938	LUC	Д653	20960
2.5 TDI QUATTRO	08.97-02.99	ATE	Д957	20676	LUC	Д481	20961
2.5 TDI QUATTRO	03.99-09.00	ATE	Д957ИЗ	21938			
2.5 TDI QUATTRO	10.00-09.01	ATE	Д957ИЗ	21938	LUC	Д653	20960
2.6	10.94-07.97	ATE	Д957	20676	LUC	Д369	20668
2.6	08.97-02.99	ATE	Д957	20676	LUC	Д481	20961
2.6 QUATTRO	11.94-02.99	ATE	Д957	20676	LUC	Д481	20961
2.8	10.94-07.97	ATE	Д957	20676	LUC	Д369	20668
2.8	08.97-02.99	ATE	Д957	20676	LUC	Д481	20961
2.8	03.99-09.00	ATE	Д957ИЗ	21938			
2.8 QUATTRO	11.94-02.99	ATE	Д957	20676	LUC	Д369	20668
2.8 QUATTRO	03.99-09.00	ATE	Д957ИЗ	21938			
3.0	10.00-10.04	ATE	Д957ИЗ	21938	LUC	Д653	20960
3.0 QUATTRO	10.00-	ATE	Д957ИЗ	21938	LUC	Д653	20960
<b>A6</b>							
1.8	08.95-01.98	ATE	Д957И	20676	LUC	Д369	20668
1.8	05.97-	ATE	Д957И	20676	LUC	Д481	20961
1.8 AVANT	08.95-01.98	ATE	Д957И	20676	LUC	Д369	20668
1.8 AVANT QUATTRO	08.95-01.98	ATE	Д957И	20676	LUC	Д369	20668

							
		i	DAFMI	W.V.A	i	DAFMI	W.V.A

1.8 AVANT	05.97-	ATE	Д957И	20676	LUC	Д481	20961
1.8 AVANT QUATTRO	05.97-	ATE	Д957И	20676	LUC	Д481	20961
1.8 0TURBO	05.97-10.00	ATE	Д957ИЗ	21938	LUC	Д481	20961
1.8 0TURBO	11.00-05.01	ATE	Д957ИЗ	21938	LUC	Д653	20960
1.8 QUATTRO	08.95-01.98	ATE	Д957И	20676	LUC	Д369	20668
1.8 QUATTRO	05.97-	ATE	Д957И	20676	LUC	Д481	20961
1.8 TURBO QUATTRO	05.97-07.04	ATE	Д957ИЗ	21938			
1.9	06.94-02.97	ATE	Д957И	20676	LUC	Д369	20668
1.9	03.97-	ATE	Д957И	20676	LUC	Д481	20961
1.9 AVANT	06.95-	ATE	Д957И	20676	LUC	Д369	20668
1.9 TDI	05.97-05.01	ATE	Д957ИЗ	21938	LUC	Д481	20961
1.9 TDI	06.01-07.04	ATE	Д957ИЗ	21938	LUC	Д653	20960
2.0 ALL	06.94-07.96	ATE	Д957И	20676	LUC	Д369	20668
2.0	06.01-07.04	ATE	Д957ИЗ	21938	LUC	Д653	20960
2.0 TDI	08.04-				LUC	Д203	23914
2.0 QUATTRO ALL	06.94-07.96	ATE	Д957И	20676	LUC	Д369	20668
2.3 ALL	06.94-07.96	ATE	Д957И	20676	LUC	Д369	20668
2.3 QUATTRO ALL	06.94-07.96	ATE	Д957И	20676	LUC	Д369	20668
						Д48	20961
2.4	05.97-07.04	ATE	Д957ИЗ	21938	LUC	или Д653	или 20960
2.4	08.04-				LUC	Д203	23914
2.4 QUATTRO ALL	05.97-	ATE	Д957И	20676	LUC	Д481	20961
2.4 QUATTRO	05.97-07.04	ATE	Д957ИЗ	21938	LUC	Д481	20961
2.4 QUATTRO	10.04-				LUC	Д203	23914
2.5 TDI	06.94-04.97	ATE	Д957И	20676	LUC	Д369	20668
2.5 TDI	05.97-05.01	ATE	Д957ИЗ	21938	LUC	Д481	20961
2.5 TDI	06.01-07.04	ATE	Д957ИЗ	21938	LUC	Д653	20960
2.5 TDI AVANT	06.94-	ATE	Д957И	20676	LUC	Д369	20668
2.5 TDI AVANT QUATTRO	06.94-	ATE	Д957И	20676	LUC	Д369	20668
2.5 TDI QUATTRO	08.95-01.98	ATE	Д957И	20676	LUC	Д369	20668
2.5 TDI QUATTRO	06.97-	ATE	Д957И	20676	LUC	Д481	20961
2.5 TDI QUATTRO	07.97-07.04	ATE	Д957ИЗ	21938	LUC	Д481	20961
2.6 ALL	06.94-	ATE	Д957И	20676	LUC	Д369	20668
2.6 AVANT ALL	06.94-	ATE	Д957И	20676	LUC	Д369	20668
2.6 QUATTRO ALL	06.94-01.98	ATE	Д957И	20676	LUC	Д369	20668
2.7 TDI	10.04-				LUC	Д203	23914
2.8	05.97-05.01	ATE	Д957ИЗ	21938	LUC	Д481	20961
2.8	06.00-05.01	ATE	Д957ИЗ	21938	LUC	Д653	20960
2.8 TDI	06.94-	ATE	Д957И	20676	LUC	Д369	20668
2.8 TDI AVANT	06.94-05.97	ATE	Д957И	20676	LUC	Д369	20668
2.8 TDI AVANT	06.97-	ATE	Д957И	20676	LUC	Д481	20961
2.8 TDI AVANT QUATTRO	06.94-05.97	ATE	Д957И	20676	LUC	Д369	20668
2.8 TDI AVANT QUATTRO	06.97-	ATE	Д957И	20676	LUC	Д481	20961
2.8 TDI QUATTRO	06.94-05.97	ATE	Д957И	20676	LUC	Д369	20668
2.8 TDI QUATTRO	06.97-	ATE	Д957И	20676	LUC	Д481	20961
2.8 QUATTRO	05.97-05.01	ATE	Д957ИЗ	21938	LUC	Д481	20961
3.0	08.04-				LUC	Д203	23914
3.0 QUATTRO	08.04-				LUC	Д203	23914
3.0 TDI QUATTRO	08.04-				LUC	Д203	23914
3.2 FSI QUATTRO	08.04-				LUC	Д203	23914
3.2 FSI	08.04-				LUC	Д203	23914
4.2 QUATTRO ALL	04.99-	ATE	Д957И	20676	LUC	Д653	20960
<b>A8</b>							
ALL MODELS	03.94-				LUC	Д369	20668

# Тормозные колодки для автомобилей иностранного производства





		i DAFMI W.V.A	i DAFMI W.V.A

<b>Coupe</b>							
2.0	05.89-07.92	LUC	Д327 или Д328	20669 20901	LUC	Д369	20668
2.0	08.92- 96				LUC	Д369	20668
2.2 20V	10.90-07.94	ATE	Д957И	20676	LUC	Д369	20668
2.3	02.87- 89	LUC	Д328	20901	LUC	Д369	20668
2.3 E	08.88-07.94	LUC	Д327	20669	LUC	Д369	20668
2.8 E	08.91-07.94	ATE	Д957И	20676	LUC	Д369	20668
<b>TT</b>							
1.8 ALL	10.98-	ATE	Д957И	20676	LUC	Д481	20961
1.8 QUATTRO ALL	10.98-	ATE	Д957И	20676	LUC	Д481	20961
<b>TT Coupe/Cabrio</b>							
1.8 TURBO	08.99-	ATE	Д957И2	23392	LUC	Д481	20961

## BMW

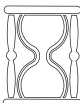

<b>300 series (E21)</b>							
315	(E21)	03.81-03.84	ATE	Д276	20588		
316	(E21)	07.75-08.82	ATE	Д276	20588		
318	(E21)	08.75-08.80	ATE	Д276	20588		
318 I	(E21)	11.79-08.82	ATE	Д276	20588		
320	(E21)	08.75-08.82	ATE	Д276	20588		
320 I	(E21)	10.75-08.77	ATE	Д276	20588		
323 I	(E21)	01.78-08.82	ATE	Д276	20588		
<b>300 series (E30)</b>							
316	(E30)	09.82-08.87	LUC	Д224 или Д342	20749 21173		
316 I	(E30)	09.87-06.91	LUC	Д342	21173		
316 I W/ABS	(E30)	09.87-06.91	LUC	Д342	21173	ATE	Д381 20675
316 W/ABS	(E30)	09.82-08.87	LUC	Д342	21173	ATE	Д381 20675
318	(E30)	82- 87	LUC	Д224	20749		
318 I	(E30)	82- 87	LUC	Д224	20749		
318 I	(E30)	87-06.91	LUC	Д342	21173		
318 I CABRIO	(E30)	09.90-10.93	LUC	Д342	21173		
318 I CABRIO W/ABS	(E30)	03.90-10.93	LUC	Д342	21173	ATE	Д381 20675
318 I TOURING	(E30)	04.89-09.93	LUC	Д342	21173		
318 I TOURING W/ABS	(E30)	04.89-09.93	LUC	Д342	21173	ATE	Д381 20675
318 I W/ABS	(E30)	87-06.91	LUC	Д342	21173	ATE	Д381 20675
320	(E30)	82- 87	LUC	Д224	20749		
320 I	(E30)	82- 87	LUC	Д224	20749		
320 I	(E30)	87-06.91	LUC	Д342	21173		
320 I CABRIO	(E30)	09.87-10.93	LUC	Д342	21173		
320 I CABRIO W/ABS	(E30)	09.87-10.93	LUC	Д342	21173	ATE	Д381 20675
320 I TOURING	(E30)	01.88-12.91	LUC	Д342	21173		
320 I TOURING W/ABS	(E30)	01.88-12.91	LUC	Д342	21173	ATE	Д381 20675
320 I W/ABS	(E30)	87-06.91	LUC	Д342	21173	ATE	Д381 20675
323	(E30)	82- 87	LUC	Д224	20749		
323 I	(E30)	11.82- 85	LUC	Д224	21173	ATE	Д381 20675
323 I	(E30)	86- 90	LUC	Д342	21173	ATE	Д381 20675
323 I CABRIO	(E30)	82- 87	LUC	Д224	20749		
324 D	(E30)	09.85- 86	LUC	Д224	21173		
324 D	(E30)	86-06.91	LUC	Д342	21173		
324 D W/ABS	(E30)	09.85-08.91	LUC	Д342	21173	ATE	Д381 20675
324 TD	(E30)	09.87-06.91	LUC	Д342	21173		
324 TD TOURING	(E30)	01.88-06.93	LUC	Д342	21173		



							
		i	DAFMI	W.V.A	i	DAFMI	W.V.A

324 TD TOURING W/ABS (E30)	01.88-06.93	LUC	Д342	21173	ATE	Д381	20675
324 TD W/ABS (E30)	09.87-08.91	LUC	Д342	21173	ATE	Д381	20675
325 E (E30)	85- 86	LUC	Д224	20749	ATE	Д381	20675
325 E (E30)	86-12.88	LUC	Д342	21173	ATE	Д381	20675
325 I (E30)	09.85- 86	LUC	Д224	21173	ATE	Д381	20675
325 I (E30)	86-06.91	LUC	Д342	21173	ATE	Д381	20675
325 I CABRIO (E30)	12.85-10.93	LUC	Д342	21173	ATE	Д381	20675
325 I TOURING (E30)	07.87-03.93	LUC	Д342	21173	ATE	Д381	20675
325 IX (E30)	03.86-08.91	LUC	Д342	21173	ATE	Д381	20675
325 IX TOURING (E30)	06.88-10.93	LUC	Д342	21173	ATE	Д381	20675
M3 (E30)	07.86-06.91	ATE	Д620	20629	ATE	Д765	20995
<b>300 series (E36)</b>							
316 I (E36)	09.90- .98	ATE	Д720	21292	ATE	Д698	20180
316 I COMPACT (E36)	03.94- 09.98	ATE	Д720	21292	ATE	Д698	20180
316 I W/REAR DISC (E36)	09.90-07.94	ATE	Д720	21292	ATE	Д698	20180
318 I (E36)	09.90-01.98	ATE	Д720	21292	ATE	Д698	20180
318 I TDS COMPACT (E36)	01.95-03.98	ATE	Д720	21292			
318 I TOURING (E36)	07.95-07.99	ATE	Д720	21292	ATE	Д698	20180
318 TDS (E36)	01.95-01.98	ATE	Д720	21292			
318 TDS TOURING (E36)	01.95-07.99	ATE	Д720	21292	ATE	Д698	20180
318 TDS W/REAR DISC (E36)	01.95-01.98	ATE	Д720	21292	ATE	Д698	20180
320 I (E36)	09.90-03.95	ATE	Д720	21292	ATE	Д698	20180
320 I CABRIO (E36)	12.93-	ATE	Д720	21292	ATE	Д698	20180
320 I TOURING (E36)	01.95-07.99	ATE	Д720	21292	ATE	Д698	20180
325 I (E36)	09.90-07.94	ATE	Д720	21292	ATE	Д698	20180
325 I CABRIO (E36)	03.93-03.95	ATE	Д720	21292	ATE	Д698	20180
325 TD (E36)	08.90-12.91	ATE	Д720	21292	ATE	Д698	20180
325 TDS (E36)	08.90-01.98	ATE	Д720	21292	ATE	Д698	20180
328 I (E36)	01.95-	ATE	Д720	21292	ATE	Д698	20180
328 I CABRIO (E36)	03.95-	ATE	Д720	21292	ATE	Д698	20180
M3 (E36)	09.90-	ATE	Д494	20968	ATE	Д765	20995
M3 CABRIO (E36)	01.94-	ATE	Д494	20968	ATE	Д765	20995
<b>300 series (E46) (98- )</b>							
316 I (E46)	08.98-	ATE	Д720	21292	ATE	Д698	20180
318 I (E46)	02.98-	ATE	Д720	21292	ATE	Д698	20180
320 I (E46)	02.98-	ATE	Д720	21292	ATE	Д698	20180
323 I (E46)	02.98-07.00	ATE	Д720	21292			
328 I (E46)	02.98-	ATE	Д720	21292	ATE	Д698	20180
328 I TOURING (E46)	08.99-07.00	ATE	Д720	21292	ATE	Д698	20180
<b>300 series (E90)</b>							
320 I (E90)	03.05-	ATE	Д225				
320 D (E90)	03.05-	ATE	Д225	23347/			
325 I (E90)	03.05-	ATE	Д225	23794/ 23968			
330 I (E90)	03.05-	ATE	Д225				
<b>500 series (E12)</b>							
518 (E12)	08.76-05.81	ATE	Д279	20437			
520 (E12)	08.76-05.81	ATE	Д279	20437			
525 (E12)	08.76-05.81	ATE	Д279	20437			
528 (E12)	08.76-08.77	ATE	Д279	20437			
528 I (E12)	04.77-05.81	ATE	Д279	20437			
<b>500 series (E28)</b>							
518 (E28)	06.81-08.84	ATE	Д620	20629			
518 I (E28)	09.83-12.87	ATE	Д620	20629			
518 I W/ABS (E28)	09.83-12.87	ATE	Д620	20629	ATE	Д381	20675

# Тормозные колодки для автомобилей иностранного производства

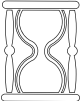

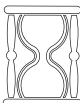
								
			i	DAFMI	W.V.A	i	DAFMI	W.V.A
								
520 I (E28)	06.81-12.87	ATE	Д620	20629				
520 I W/ABS (E28)	06.81-12.87	ATE	Д620	20629	ATE	Д381	20675	
524 D (E28)	03.86-12.87	ATE	Д620	20629				
524 D W/ABS (E28)	03.86-12.87	ATE	Д620	20629	ATE	Д381	20675	
524 TD (E28)	09.83-12.87	ATE	Д620	20629				
524 TD W/ABS (E28)	09.83-12.87	ATE	Д620	20629	ATE	Д381	20675	
525 E (E28)	09.81-12.87	ATE	Д620	20629	ATE	Д381	20675	
525 I (E28)	06.81-12.87	ATE	Д620	20629	ATE	Д381	20675	
528 I (E28)	06.81-12.87	ATE	Д620	20629	ATE	Д381	20675	
535 I (E28)	01.85-12.87	ATE	Д620	20629	ATE	Д381	20675	
M535 I (E28)	01.85-12.87	ATE	Д620	20629	ATE	Д381	20675	
<b>500 series (E34)</b>								
518 I (E34)	08.89-11.95	ATE	Д494	20968	ATE	Д765	20995	
520 I (E34)	01.88-08.91	ATE	Д494	20968	ATE	Д765	20995	
520 I 24V (E34)	09.89-11.95	ATE	Д494	20968	ATE	Д765	20995	
524 TD (E34)	03.88-11.95	ATE	Д494	20968	ATE	Д765	20995	
525 I (E34)	01.88-08.91	ATE	Д494	20968	ATE	Д765	20995	
525 I 24V (E34)	09.89-11.95	ATE	Д494	20968	ATE	Д765	20995	
525 IX 24V (E34)	10.92-11.95	ATE	Д494	20968	ATE	Д765	20995	
525 TD (E34)	03.88-11.95	ATE	Д494	20968	ATE	Д765	20995	
525 TDS (E34)	09.91-11.95	ATE	Д494	20968	ATE	Д765	20995	
530 I (E34)	01.88-08.91	ATE	Д494	20968	ATE	Д765	20995	
530 I V8 (E34)	09.92-11.95	ATE	Д494	20968	ATE	Д765	20995	
535 I (E34)	01.88-11.95	ATE	Д494	20968	ATE	Д765	20995	
540 I V8 (E34)	09.92-11.95	ATE	Д494	20968	ATE	Д765	20995	
M5 (E34)	10.88-05.94	ATE	Д494	20968	ATE	Д765	20995	
<b>500 series (E39)</b>								
520 I (E39)	01.96-	ATE	Д153	21676	ATE	Д154	21690	
520 I TOURING (E39)	02.97-	ATE	Д153	21676	ATE	Д154	21690	
520 D TOURING (E39)	02.97-	ATE	Д153	21676	ATE	Д154	21690	
523 I All (E39)	11.95-	ATE	Д153	21676	ATE	Д154	21690	
525 D (E39)	02.97-	ATE	Д153	21676	ATE	Д154	21690	
525 D TOURING / TDS / SE (E39)	02.97-	ATE	Д153	21676	ATE	Д154	21690	
528 I All (E39)	11.95-	ATE	Д153	21676	ATE	Д154	21690	
530 D (E39)	05.98-	ATE	Д153	21676	ATE	Д154	21690	
535 I (E39)	11.95-	ATE	Д153	21676	ATE	Д154	21690	
540 I (E39)	11.95-	ATE	Д153	21676	ATE	Д154	21690	
<b>500 series (E60)</b>								
520 I (E60)	06.03-05.05	ATE	Д225					
520 I TOURING MAN (E61)	05.04-05.05	ATE	Д225	23347/				
525 I TOURING MAN (E61)	06.04-05.05	ATE	Д225	23794/ 23968				
525 D (E60)	02.04-	ATE	Д225					
<b>600 series (E24)</b>								
628 CSI (E24)	09.79-04.82	ATE	Д279	20437				
628 CSI (E24)	05.82-08.87	ATE	Д620	20629	ATE	Д381	20675	
630 CS (E24)	09.76-08.79	ATE	Д279	20437				
633 CSI (E24)	09.76-04.82	ATE	Д279	20437				
635 CSI (E24)	05.82-05.89	ATE	Д620	20629	ATE	Д381	20675	
635 CSI (E24)	06.78-04.82	ATE	Д279	20437				
M 635 CSI (E24)	04.84-05.89	ATE	Д620	20629	ATE	Д381	20675	
M 6 (E24)	85-10.91	ATE	Д279	20629				
<b>700 series (E23)</b>								
728 (E23)	05.77-08.79	ATE	Д279	20437				
728 I (E23)	07.78-08.81	ATE	Д279	20437				
728 I (E23)	09.81-08.86	ATE	Д279	20437	ATE	Д381	20675	

							
		i	DAFMI	W.V.A	i	DAFMI	W.V.A

730	(E23)	05.77-08.79	ATE	Д279	20437			
732 I	(E23)	05.77-09.81	ATE	Д279	20437			
732 I	(E23)	10.81-08.86	ATE	Д279	20437	ATE	Д381	20675
733 I	(E23)	05.77-09.81	ATE	Д279	20437			
733 I	(E23)	10.81-08.86	ATE	Д279	20437	ATE	Д381	20675
735 I	(E23)	09.79-09.81	ATE	Д279	20437			
735 I	(E23)	10.81-08.86	ATE	Д279	20437	ATE	Д381	20675
745 I	(E23)	04.80-08.81	ATE	Д279	20437			
745 I	(E23)	09.81-06.86	ATE	Д279	20437	ATE	Д381	20675
<b>700 series (E32)</b>								
730 I	(E32)	09.87-09.94	ATE	Д494	20968	ATE	Д765	20995
730 I V8	(E32)	04.92-09.94	ATE	Д494	20968	ATE	Д765	20995
735 I	(E32)	09.86-09.92	ATE	Д494	20968	ATE	Д765	20995
740 I V8	(E32)	04.92-09.94	ATE	Д494	20968	ATE	Д765	20995
750 I V12	(E32)	09.87-09.94	ATE	Д494	20968	ATE	Д765	20995
<b>Z1</b>								
All	(E30)	88- 91	LUC	Д342	21173	ATE	Д698	20180
<b>Z3</b>								
1.8	(E36)	95- 97	ATE	Д494	20968	ATE	Д765	20995
1.9	(E36)	95- 97	ATE	Д494	20968	ATE	Д765	20995
2.8 Roadster	(E36)	95- 97	ATE	Д494	20968	ATE	Д765	20995

## CHERY

<b>Amulet</b>								
		06-		Д216				
		06-	LUC	Д885	20168			
<b>Tiggo</b>								
		06-	LUC	Д885	20168	AKE	Д495	

## CHEVROLET



<b>Aveo</b>								
AVEO ALL MODELS		03.05-	AKE	Д190	23974			
<b>Chevrolet-Niva</b>								
BA3 2123		02-		Д301	20660		ДА656	
<b>Lacetti</b>								
LACETTI ALL MODELS		12.97-		Д133И	23234		Д125	24071
<b>Lanos</b>								
LANOS ALL MODELS		98-		Д132	23241		ДА132	
<b>Tacuma</b>								
TACUMA ALL MODELS		01.05-		Д133	23234			
<b>Spark</b>								
SPARK ALL MODELS		04.98-		Д132	23241			



## CITROEN

<b>AX</b>								
1.1 4X4		06.91-07.92	BDX	Д294	20905			
1.4		06.91-05.95	BDX	Д294	20905			
<b>BX</b>								
14		09.82-02.93	CIT	Д352	20859	CIT	Д284	20575
15 RE		01.87-02.93	CIT	Д352	20859	CIT	Д284	20575
16		09.82-02.93	CIT	Д352	20859	CIT	Д284	20575
19 GT		09.82-02.93	CIT	Д352	20859	CIT	Д284	20575
19 GTI		09.82-02.93	CIT	Д352	20859	CIT	Д284	20575
19 GTI 16V		01.87-02.93	CIT	Д352	20859	CIT	Д284	20575
19 SPORT		09.82-02.93	CIT	Д352	20859	CIT	Д284	20575
<b>C4</b>								
1.4 O/ESP O/DSC		09.04-	BOSCH	Д219	24101/ 23599	LUC	Д481	20961

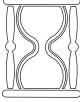
# Тормозные колодки для автомобилей иностранного производства

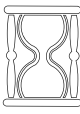

							
		i	DAFMI	W.V.A	i	DAFMI	W.V.A
1.4 W/ESP W/DSC	09.04-	BOSCH	Д934	23600	LUC	Д481	20961
1.6 O/ESP O/DSC	09.04-	BOSCH	Д219	24101/ 23599	LUC	Д481	20961
1.6 W/ESP W/DSC	09.04-	BOSCH	Д934	23600	LUC	Д481	20961
2.0 Cp	09.04-	ATE	Д195	23589/ 24153	LUC	Д481	20961
2.0	09.04-	ATE или BOSCH	Д195 или Д934	23589/ 24153 или 23600	LUC	Д481	20961
<b><u>CX</u></b>							
CX ALL MODELS	08.74-08.85				CIT	Д284	20575
<b><u>Dispatch</u></b>							
DISPATCH ALL MODELS	95-	LUC	Д711ИЗ	21074			
<b><u>Evasion</u></b>							
EVASION ALL MODELS	07.95-	LUC	Д711ИЗ	21074			
<b><u>Saxo</u></b>							
1.1	02.96-	BDX	Д294	20905	LUC	ДА339	
1.4 (Not GTi)	02.96-	BDX	Д294	20905	LUC	ДА339	
1.5	05.96-	BDX	Д294	20905	LUC	ДА339	
1.6	05.96-	BDX	Д294	20905	LUC	ДА339	
<b><u>Xsara</u></b>							
1.4 i Estate	09.97-	LUC	Д144	21124			
1.8 i Estate	05.98-	LUC	Д144	21124			
1.9 D Estate	98-	LUC	Д144	21124			
1.9 TD Estate	2.98-	LUC	Д144	21124			
2.0 HDi Estate	99-	LUC	Д144	21124			
<b><u>Xsara Picasso</u></b>							
XSARA PICASSO ALL MODELS	09.99-	LUC	Д144	21124			
1.6 MPV	10.01-	BOSCH	Д219	24101/ 23599			
1.6 HDI MPV	11.03-	BOSCH	Д219	24101/ 23599			
1.8 MPV	11.01-08.05	BOSCH	Д219	24101/ 23599			
2.0 MPV	05.01-	BOSCH	Д219	24101/ 23599			
2.0 HDI MPV	11.01-	BOSCH	Д219	24101/ 23599			
<b><u>ZX</u></b>							
ZX ALL MODELS	06.92-10.97	BDX	Д294	20905	LUC	ДА339	
<b><u>Berlingo (light commercial)</u></b>							
1.1 I	07.96-	LUC	Д144	21124			
1.1	11.01-	BOSCH	Д219	24101/ 23599			
1.1 MULTISPACE	11.02-	BOSCH	Д219	24101/ 23599			
1.4 I	07.96-	LUC	Д144	21124			
1.4	11.01-	BOSCH	Д219	24101/ 23599			
1.4 MULTISPACE	11.02-	BOSCH	Д219	24101/ 23599			
1.6	11.01-	BOSCH	Д219	24101/ 23599			

							
		i	DAFMI	W.V.A	i	DAFMI	W.V.A

1.6 MULTISPACE	11.01-	BOSCH	Д219	24101/ 23599			
1.7 D	09.96-	LUC	Д144	21124			
1.8	07.96-	LUC	Д144	21124			
1.9 D	07.96-	LUC	Д144	21124			
1.9 TD	09.96-	LUC	Д144	21124			
1.9		BOSCH	Д219	24101/ 23599			
1.9 MULTISPACE		BOSCH	Д219	24101/ 23599			
2.0 HDi	00-	LUC	Д144	21124			
2.0 HDi		BOSCH	Д219	24101/ 23599			
2.0 HdI MULTISPACE	00-	BOSCH	Д219	24101/ 23599			
<b><u>C (light commercial)</u></b>							
C 15 D	10.84-10.92	LUC	Д702	21080			
C 15 E	07.87-07.96	LUC	Д702	21080			
C 22	10.81-02.94	LUC	Д530	20741			
C 25	10.81-02.94	LUC	Д530	20741			
C 25 D 1300 TURBO	07.86-02.94	LUC	Д674	21206			
C 25 D 1800	88- 94	LUC	Д674	21206			
<b><u>Jumper (light commercial)</u></b>							
All (Exc 2.5 TD 35)	02.94-	LUC	Д149	21797			
2.5 TD 35	02.94-	LUC	Д150	21799			
<b><u>Visa (light commercial)</u></b>							
1.7 D	03.84-03.91	LUC	Д702	21080			
1.7 GTI	11.84-03.91	LUC	Д702	21080			
1.7 RD	03.84-03.91	LUC	Д702	21080			

## DACIA

<b><u>Logan</u></b>							
1.4i	09.04-	LUC	Д339	20770	LUC	ДА339	
1.6i	09.04-	LUC	Д339	20770	LUC	ДА339	
1.5 dCi	09.04-	LUC	Д339	20770	LUC	ДА339	
1.6i 16V	09.04-	LUC	Д339	20770	LUC	ДА339	
<b><u>Nova</u></b>							
1.6	01.96-	BDX	Д226	20336			
<b><u>Super Nova</u></b>							
1.4	01.00-	BDX	Д226	20336			

## DAEWOO

<b><u>Aranos</u></b>							
ARANOS ALL MODELS	01.95-11.97	ATE	Д433	21190		ДА132	
<b><u>Espero</u></b>							
ESPERO ALL MODELS	01.95-	GM	Д269	20939		ДА132	
		ATE	Д433 или Д133	21190 23234			
<b><u>Korando</u></b>							
KORANDO ALL MODELS	01.99-				LUC	Д135	23237
<b><u>Lanos</u></b>							
LANOS ALL MODELS	98-	ATE	Д132	20547 23241		ДА132	



# Тормозные колодки для автомобилей иностранного производства



		i	DAFMI	W.V.A	i	DAFMI	W.V.A



<b><u>Leganza</u></b>							
LEGANZA ALL MODELS	12.97-		Д133И	23234		Д135	23237
<b><u>Lublin (light commercial)</u></b>							
LUBLIN ALL MODELS		BDX	Д478	20919			
<b><u>Matiz</u></b>							
MATIZ ALL MODELS	04.98-		Д132	23241		ДА136	
<b><u>Musso</u></b>							
MUSSO ALL MODELS	01.99-				LUC	Д135	23237
<b><u>Nexia</u></b>							
NEXIA ALL MODELS	93-	GM ATE	Д269 или Д433	20939 21190		ДА132	
<b><u>Nubira (I)</u></b>							
NUBIRA ALL MODELS	11.97-12.01		Д133	23234		ДА132	
NUBIRA ALL MODELS W/REAR DISC	11.97-12.01		Д133	23234		Д135	23237
<b><u>Nubira (II)</u></b>							
NUBIRA II ALL MODELS	01.99-		Д133	23234		ДА132	
NUBIRA II ALL MODELS W/REAR DISC	01.99-		Д133	23234		Д135	23237
<b><u>Prince</u></b>							
PRINCE ALL MODELS			Д133	23234			
<b><u>Racer</u></b>							
RACER ALL MODELS	93- 95	GM	Д269	20939			
<b><u>Sens</u></b>							
SENS ALL MODELS	98-		Д132	23241		ДА132	
<b><u>Tacuma</u></b>							
TACUMA ALL MODELS			Д133	23234			
<b><u>Tico</u></b>							
TICO ALL MODELS	94-08.00	AKE	Д143			ДА136	

## D.A.F.

<b><u>Sherpa</u></b>							
250	08.82-12.94	AP	Д430	20359			
280 COMBI	08.82-12.94	AP	Д430	20359			
285	09.83-12.94	AP	Д430	20359			
310	09.83-12.94	AP	Д430	20359			
350	83-12.85	AP	Д430	20359			

## FIAT

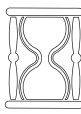

<b><u>131</u></b>							
131 MIRAFIORI	09.82-12.84	BDX	Д334	20950			
<b><u>Argenta</u></b>							
100	05.83- 85	LUC	Д373	20838			
110	05.83- 85	LUC	Д373	20838			
120 IE	05.83- 85	LUC	Д373	20838			
2.5 D	05.83- 85	LUC	Д373	20838			
2.5 TURBO D	05.83- 85	LUC	Д373	20838			
<b><u>Barchetta</u></b>							
1.8 16V	04.95-				LUC	Д938	21103
<b><u>Coupe</u></b>							
1.8 ALL	09.96-	ATE	Д711И2	21074	LUC	Д938	21103
2.0 16V	03.94-08.96	ATE	Д711И2	21074	LUC	Д938	21103
2.0 20V	08.96-				LUC	Д938	21103
2.0 16V TURBO	03.94-08.96	ATE	Д711И2	21074	LUC	Д938	21103
2.0 20V TURBO	97-				LUC	Д938	21103



							
		i	DAFMI	W.V.A	i	DAFMI	W.V.A

<i>Croma</i>							
1.6	08.86-10.88	LUC	Д425	21093	LUC	Д369 или Д960	20668 20293
1.6	10.88-12.93	BDX	Д792И	21182	LUC	Д369 или Д960	20668 20293
1.9 JTD	04.95-12.96	LUC	Д373 или Д792И	20838	LUC	Д369 или Д960	20668 20293
1.9 Tdi	08.88-11.88	LUC	Д425	21093	LUC	Д369	20668
1.9 Tdi	12.88-12.89	BDX	Д792И	21182	BDX	Д960	20293
1.9 Tdi	09.89-03.95	LUC	Д373 или Д792И	20838	LUC	Д369 или Д960	20668 20293
2.0 CHT	08.86-11.88	LUC	Д425	21093	BDX	Д960	20293
2.0 CHT	12.88-02.91	BDX	Д792И	21182	LUC	Д369 или Д960	20668 20293
2.0 iE	08.85-11.88	LUC	Д425	21093	LUC	Д369 или Д960	20668 20293
2.0 iE	12.88-03.95	BDX	Д792И	21182	BDX	Д960	20293
2.0 iE Business	09.89-02.91	BDX	Д792И	21182	LUC	Д369 или Д960	20668 20293
2.0 iE S	03.87-08.89	BDX	Д792И	21182	BDX	Д960	20293
2.0 iE S Business/Comfort	04.95-12.96	LUC	Д373	20838	LUC	Д369 или Д960	20668 20293
2.0 iE SL	04.87-11.88	LUC	Д425	21093	BDX	Д960	20293
2.0 iE SL	12.88-08.89	BDX	Д792И	21182	LUC	Д369 или Д960	20668 20293
2.0 iE Super	03.91-03.95	LUC	Д373 или Д792И	20838	LUC	Д369 или Д960	20668 20293
2.0 iE SX	03.91-03.95	BDX	Д792И	21182	BDX	Д960	20293
2.0 iE SX	04.95-12.96	LUC	Д373	20838	LUC	Д369 или Д960	20668 20293
2.0 iE TURBO	08.85-02.91	LUC	Д425	21093	ATE	Д960	20293

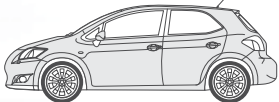
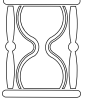
# Тормозные колодки для автомобилей иностранного производства

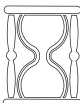

							
		i	DAFMI	W.V.A	i	DAFMI	W.V.A
2.0 iE TURBO	03.91-12.96				LUC	Д369 или Д960	20668 20293
2.0 iE TURBO Business/Comfort	04.95-12.96				LUC	Д369 или Д960	20668 20293
2.0 iE TURBO Long	03.91-03.95				LUC	Д369	20668
2.4	06.86-08.87	LUC	Д425	21093	LUC	Д369	20668
2.5	06.86-08.87	LUC	Д425	21093	LUC	Д369	20668
2.5 TD S	09.87-11.88	LUC	Д425	21093	LUC	Д369	20668
2.5 TD S	12.88-12.96	BDX	Д792	21182	BDX	Д960	20293
2.5 TD S Eco	04.95-12.96	BDX	Д792И	21182	BDX	Д960	20293
<b><u>Marea</u></b>							
1.4 W/ABS	03.96-02.99				LUC	Д938	21103
1.6 W/ABS	03.96-				LUC	Д938	21103
1.8 W/ABS	03.96-				LUC	Д938	21103
2.0	03.96-				LUC	Д938	21103
<b><u>Panda</u></b>							
PANDA ALL MODELS	05.93-	LUC	Д373 или Д334	20838 20950			
<b><u>Punto</u></b>							
55 ED W/ABS	07.93-07.99	BDX	Д373	20838			
55 S	07.93-07.99	BDX	Д373	20838			
55 SX	07.93-07.99	BDX	Д373	20838			
60 S	07.93-07.99	BDX	Д373	20838			
60 SX W/ABS	07.93-07.99	BDX	Д373	20838			
75 EL	07.93-10.98	BDX	Д373	20838			
75 ELX W/ABS	07.93-10.98	BDX	Д373	20838			
75 S	07.93-10.98	BDX	Д373	20838			
75 SX	07.93-10.98	BDX	Д373	20838			
90 ELX W/ABS	07.93-10.98	BDX	Д373	20838			
90 SX	07.93-10.98	BDX	Д373	20838			
1.2 S W/ABS CABRIO	07.93-10.98	LUC	Д373	20838			
1.4 GT	07.93-10.98	LUC	Д373	20838	LUC	Д938	21103
1.6 ELX CABRIO	07.93-10.98	LUC	Д373	20838			
1.7 TD	07.93-10.98	BDX	Д373	20838			
<b><u>Regata</u></b>							
70 ES	09.83-07.89	BDX	Д334	20950			
75 IE	04.85-07.88	BDX	Д334	20950			
75 IE WEEKEND	04.85-07.89	BDX	Д334	20950			
85	05.85-12.87	BDX	Д334	20950			
85 SUPER	09.83-04.85	BDX	Д334	20950			
90 S IE	01.87-07.89	LUC	Д373	20838			
100 SUPER	12.84-07.89	LUC	Д373	20838			
1.7 D	09.83-03.89	BDX	Д334	20950			
2.0 D	12.84-07.89	LUC	Д373	20838			
2.0 TURBO D	05.86-07.89	LUC	Д373	20838			
<b><u>Ritmo</u></b>							
50	04.85- 88	BDX	Д334	20950			
60	09.82- 88	BDX	Д334	20950			
70	09.82- 88	BDX	Д334	20950			
75	04.85- 88	BDX	Д334	20950			
85 S	09.82- 88	BDX	Д334	20950			
100 S	04.85- 88	LUC	Д373	20838			

							
		i	DAFMI	W.V.A	i	DAFMI	W.V.A

105 TC	05.83- 86	LUC	Д373	20838			
1.7 D	09.82- 86	BDX	Д334	20950			
1.7 D CL	04.85- 88	BDX	Д334	20950			
1.7 D L	04.85- 88	BDX	Д334	20950			
1.9 TURBO D	12.85- 88	LUC	Д373	20838			
<b>Tempra</b>							
1.4	05.90-07.96	LUC	Д482	21100			
1.4 I W/ABS	05.90-07.96	LUC	Д373	20838	LUC	Д938	21103
1.6	04.90-07.96	LUC	Д482	21100			
1.6 W/ABS	04.90-07.96	LUC	Д373	20838	LUC	Д938	21103
1.8	04.90-07.96	LUC	Д373	20838			
1.8 W/ABS	04.90-07.96	LUC	Д373	20838	LUC	Д938	21103
1.9 D	05.90-07.96	LUC	Д482	21100			
1.9 D W/ABS	05.90-07.96	LUC	Д373	20838	LUC	Д938	21103
1.9 TURBO D	02.91-07.96	LUC	Д373	20838			
1.9 TURBO D W/ABS	02.91-07.96	LUC	Д373	20838	LUC	Д938	21103
2.0	04.90-06.96	LUC	Д373	20838	LUC	Д938	21103
2.0 16V	93-07.96	LUC	Д711И1	21074	LUC	Д938	21103
<b>Tipo</b>							
1.4	01.88- 93	LUC	Д482	21100			
1.4 AGT	01.88- 90	LUC	Д482	21100			
1.4 AGT W/ABS	01.88- 90	LUC	Д373	20838	LUC	Д938	21103
1.4 DGT	01.88- 90	LUC	Д482	21100			
1.4 DGT W/ABS	01.88- 90	LUC	Д373	20838	LUC	Д938	21103
1.4 IE	01.88- 93	LUC	Д482	21100			
1.4 IE W/ABS	01.88- 93	LUC	Д373	20838	LUC	Д938	21103
1.6	88- 93	LUC	Д482	21100			
1.6 W/ABS	88- 93	LUC	Д373	20838	LUC	Д938	21103
1.6 AGT	01.88- 92	LUC	Д482	21100			
1.6 AGT	01.88- 93	LUC	Д482	21100	LUC	Д938	21103
1.6 AGT W/ABS	01.88- 92	LUC	Д373	20838	LUC	Д938	21103
1.6 DGT	01.88- 92	LUC	Д482	21100			
1.6 DGT	01.88- 93	LUC	Д482	21100	LUC	Д938	21103
1.6 DGT W/ABS	01.88- 92	LUC	Д373	20838	LUC	Д938	21103
1.6 IE	01.88- 92	LUC	Д482	21100			
1.6 IE W/ABS	01.88- 92	LUC	Д373	20838	LUC	Д938	21103
1.7 D	01.88- 93	LUC	Д482	21100			
1.7 16V IE	09.88- 92	LUC	Д373	20838	LUC	Д938	21103
1.8 IE GT W/ABS	92- 93	LUC	Д373	20838	LUC	Д938	21103
1.9 D	88- 93	LUC	Д482	21100			
1.9 GT W/ABS	01.88- 93	LUC	Д373	20838	LUC	Д938	21103
1.9 tds SX W/ABS	05.92- 93	LUC	Д373	20838	LUC	Д938	21103
1.9 tds SPORT W/ABS	01.88- 93	LUC	Д373	20838	LUC	Д938	21103
2.0 IE	90- 91	LUC	Д373	20838	LUC	Д938	21103
2.0 IE GT	90- 93	LUC	Д373	20838	LUC	Д938	21103
<b>Ulysse</b>							
1.9 TD	94-	LUC	Д711И3	21074			
2.0	94-	LUC	Д711И3	21074			
2.1	94-	LUC	Д711И3	21074			
<b>Uno</b>							
45	03.83-04.93	BDX	Д334	20950			
55	03.83-04.93	BDX	Д334	20950			
60	03.83-04.93	BDX	Д334	20950			
70	03.83-04.93	BDX	Д334	20950			
1.4 TURBO IE	08.85- 94	LUC	Д373	20838	LUC	Д938	21103

# Тормозные колодки для автомобилей иностранного производства





		i	DAFMI	W.V.A	i	DAFMI	W.V.A

ALL MODELS	05.93-12.94	BDX	Д334	20950			
<b><u>Daily (light commercial)</u></b>							
DAILY 35.8	01.91-	BRE	Д129	21048			
DAILY 35.9	01.91-	BRE	Д129	21048			
DAILY 35.10	01.91-	BRE	Д129	21048			
DAILY 40.8	01.91-	BRE	Д129	21048			
<b><u>Ducato (light commercial)</u></b>							
DUCATO 10	09.81-02.94	LUC	Д530	20741			
DUCATO 10	03.94-	LUC	Д149	21797			
DUCATO 13	09.81-02.94	LUC	Д530	20741			
DUCATO 14	09.81-02.94	LUC	Д530	20741			
DUCATO 14	03.94-	LUC	Д149	21797			
DUCATO 18	01.86-02.94	LUC	Д674	21206			
DUCATO 18	03.94-	LUC	Д150	21799			

## FORD

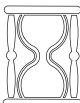
<b><u>Capri</u></b>							
CAPRY ALL MODELS	02.74- 86	LUC	Д359	20491			
<b><u>Cougar</u></b>							
2.0 ALL	01.99-	LUC	Д916	21396			
2.5 ALL	01.99-	LUC	Д930	21395			
<b><u>Cortina</u></b>							
CORTINA ALL MODELS	12.74-09.82	LUC	Д359	20491			
<b><u>Courier (light commercial)</u></b>							
ALL MODELS	10.91-	ATE	Д309	20640			
<b><u>Econovan (light commercial)</u></b>							
ALL MODELS	03.86-03.92	ATE	Д628	20002			
<b><u>Escort (II)</u></b>							
ALL MODELS	75- 80	LUC	Д359	20491			
<b><u>Escort (III)</u></b>							
1.1	07.80-02.83	ATE	Д309	20640			
1.2	03.83-08.90	ATE	Д309	20640			
		или	Д311	21171			
1.3	09.80-02.83	ATE	Д309	20640			
		ATE	Д309	20640			
1.3	03.83-08.90	ATE	или				
		ATE	Д311	21171			
1.4	08.80- 85	ATE	Д309	20640			
		ATE	Д309	20640			
1.4	86- 90	ATE	или				
		ATE	Д311	21171			
1.6	09.80- 90	ATE	Д309	20640			
		или	Д311	21171			
1.6 I	80-01.85	ATE	Д311	21171			
1.6 I	02.85-09.90	ATE	Д309	20640			
1.6 D	80-03.89	ATE	Д309	20640			
		ATE	Д309	20640			
1.8	09.88-10.90	ATE	или				
		ATE	Д311	21171			
<b><u>Escort (IV)</u></b>							
1.1	11.90-01.96	BDX	Д324	21171			
1.3	11.90-01.96	BDX	Д324	21171			

							
		i	DAFMI	W.V.A	i	DAFMI	W.V.A



1.4	11.90-01.96	BDX	Д324	21171			
1.6	10.90-01.96	BDX	Д324	21171			
1.8	10.90-01.96	BDX	Д324	21171			
1.8TD	10.90-01.96	BDX	Д324	21171			
<b><u>Escort (V / VI)</u></b>							
1.4	08.97-12.99	BDX	Д324	21171			
1.6	08.97-	BDX	Д324	21171			
1.8	08.97-12.99	BDX	Д324	21171			
1.8TD	08.97-	BDX	Д324	21171			
<b><u>Fiesta</u></b>							
1.0 W/ABS	02.00-04.02	ATE	Д714	23203			
1.2 Mk.IV W/ABS	02.00-04.02	ATE	Д714	23203			
1.2 Mk.V	03.03-	ATE	Д714	23203			
1.3 Mk.IV W/ABS	02.02-	ATE	Д714	23203			
1.3 Mk.V	05.02-	ATE	Д714	23203			
1.4 Mk.IV	02.00-04.02	ATE	Д714	23203			
1.4 Mk.V	05.02-	ATE	Д714	23203			
1.4 Mk.V, TDCI	05.02-	ATE	Д714	23203			
1.6 Mk.IV	02.02-04.02	ATE	Д714	23203			
1.6 Mk.V	05.02-	ATE	Д714	23203			
1.8 Mk.IV, TDdi W/ABS	02.00-04.02	ATE	Д714	23203			
2.0 Mk.V	11.04-	ATE	Д714	23203			
<b><u>Fiesta Van</u></b>							
1.2 W/ABS	02.00-05.01	ATE	Д714	23203			
1.3 W/ABS	02.00-05.01	ATE	Д714	23203			
1.4 W/ABS	09.99-05.01	ATE	Д714	23203			
1.8 W/ABS	02.00-05.01	ATE	Д714	23203			
<b><u>Fiesta (III)</u></b>							
1.0	03.89- 95	BDX	Д311	20783			
		ATE	-	21202			
1.1	04.89-12.96	ATE	Д309	20640			
		ATE	Д311	20783			
		ATE	-	21202			
1.3	08.91-12.95	ATE	Д309	20640			
		ATE	Д311	20783			
		ATE	-	21202			
1.4	04.89-10.95	ATE	Д309	20640			
		ATE	Д311	20783			
		ATE	Д309	20640			
1.6	04.89-12.95	ATE	Д311	20783			
		ATE	Д309	20640			
1.8 16V	04.89-12.95	ATE	Д309	20640			
<b><u>Fiesta (IV)</u></b>							
1.2 16V (not vent. disc)	96-01.00	ATE	Д309	20640			
1.3	96-01.00	ATE	Д309	20640			
1.4	96-01.00	ATE	Д309	20640			
		ATE	-				
1.8D	96-01.00	ATE	Д309	20640			
		ATE	Д309	20640			

# Тормозные колодки для автомобилей иностранного производства

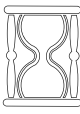

		i	DAFMI	W.V.A	i	DAFMI	W.V.A

<u>Focus</u>							
ALL MODELS	08.98-	ATE	Д189	23154		ДА189 (-ABS)	
1.4	08.04-	ATE	Д613	23723	ATE	Д206	24137
1.6	08.04-	ATE	Д613	23723	ATE	Д206	24137
1.6 TDCi	08.04-	ATE	Д613	23723	ATE	Д206	24137
2.0	08.04-	ATE	Д613	23723	ATE	Д206	24137
2.0 TDCi	08.04-	ATE	Д613	23723	ATE	Д206	24137
<u>Focus C-Max</u>							
1.6	10.03-	ATE	Д613	23723	ATE	Д966	23482/ 23483
1.6 TDCi	10.03-	ATE	Д613	23723	ATE	Д966	23482/ 23483
1.8	10.03-	ATE	Д613	23723	ATE	Д966	23482/ 23483
2.0 TDCi	10.03-	ATE	Д613	23723	ATE	Д966	23482/ 23483
<u>Focus Estate/Wagon</u>							
1.4	02.05-	ATE	Д613	23723	ATE	Д206	24137
1.6	02.05-	ATE	Д613	23723	ATE	Д206	24137
1.6 TDCi	02.05-	ATE	Д613	23723	ATE	Д206	24137
2.0	02.05-	ATE	Д613	23723	ATE	Д206	24137
2.0 TDCi	02.05-	ATE	Д613	23723	ATE	Д206	24137
<u>Fusion (JU )</u>							
1.25	08.02-	ATE	Д714	23203			
1.4	08.02-	ATE	Д714	23203			
1.4 TDCi	08.02-	ATE	Д714	23203			
1.6	08.02-	ATE	Д714	23203			
1.6 TDCi	08.02-	ATE	Д714	23203			
<u>Galaxy</u>							
ALL MODELS	06.95-	ATE	Д957	20676			
<u>Ka</u>							
1.3 (Vent. Disc)	10.96-01.00	ATE	Д309	20640			
1.6 i	09.96-	ATE	Д714	23203			
<u>Maverick</u>							
ALL MODELS	93-	LUC	Д138 или Д159	21410			
<u>Mondeo</u>							
1.6	01.93-	ATE	Д916 или Д930	21396 21395	LUC	ДА916 или -	
1.8	01.93-	ATE	Д916 или Д930	21396 21395	LUC	ДА916 или -	
1.8 TD	01.93-12.99	ATE	Д916 или Д930	21396 21395	LUC	ДА916 или -	
1.8 Mk.III	10.00-	BOSCH	Д205	23278/ 23279/ 23321	BOSCH	Д362	
1.8 Mk.III ESTATE/WAGON	10.00-	BOSCH	Д205	23278/ 23279/ 23321	BOSCH	Д362	
2.0	01.93-12.00	ATE	Д916 или Д930	21396 21395	LUC	ДА916 или -	
2.0 14" Wheel	01.93-12.00	ATE	Д930	21395	LUC	-	
2.0 Mk.III	10.00-	BOSCH	Д205	23278/ 23279/ 23321	BOSCH	Д362	

							
		i	DAFMI	W.V.A	i	DAFMI	W.V.A

2.0 Mk.III, TDCI/TDdI	10.00-	BOSCH	Д205	23278/ 23279/ 23321			
2.0 Mk.III ESTATE/WAGON	10.00-	BOSCH	Д205	23278/ 23279/ 23321	BOSCH	Д362	
2.0Mk.III,TDCI/TDdI ESTATE/WAGON	10.00-	BOSCH	Д205	23278/ 23279/ 23321	BOSCH	Д362	
2.5 Mk.III	10.00-	BOSCH	Д205	23278/ 23279/ 23321	BOSCH	Д362	
2.5 Mk.III ESTATE/WAGON	10.00-	BOSCH	Д205	23278/ 23279/ 23321	BOSCH	Д362	
3.0 Mk.III, ST220	02.02-	BOSCH	Д205	23278/ 23279/ 23321			
3.0 Mk.III, ST220 ESTATE/WAGON	02.02-	BOSCH	Д205	23278/ 23279/ 23321			
<b><u>Orion</u></b>							
1.3	07.83-01.86	ATE	Д309 или Д311	20640 20783			
1.3	08.90-08.93	BDX	Д324	21171			
1.4	01.86-08.90	ATE	Д309	20640			
1.4 AUTOMATIC	08.90-08.93	BDX	Д324	21171			
1.4 W/ABS	01.86-08.90	ATE	Д309	20640			
1.4	08.90-08.93	BDX	Д324	21171			
1.6	07.83-01.86	ATE	Д309 или Д311	20640 20783			
1.6	01.86-08.90	ATE	Д309	20640			
1.6	08.90-08.93	BDX	Д324	21171			
1.6 D	07.83-08.90	ATE	Д309 или Д311	20640 20783			
1.6 I	07.83-08.90	ATE	Д309 или Д311	20640 20783			
1.6 W/ABS	01.86-08.90	ATE	Д309	20640			
1.8	01.92-08.93	BDX	Д324	21171			
1.8 D	89-08.90	ATE	Д309	20640			
1.8 D	08.90-08.93	BDX	Д324	21171			
<b><u>Probe</u></b>							
2.0 16V, 24V	10.93-12.97	SUM	Д594	21754	SUM	Д551	21766
2.2 GT	12.90-05.92	AKE	Д450	21378			
2.5 24V	10.93-12.97	SUM	Д594	21754	SUM	Д551	21766
2.5 GT	12.90-	AKE	Д450	21378			
3.0 GT	12.90-	AKE	Д450	21378			
<b><u>Puma</u></b>							
ALL MODELS	07.97-	ATE	Д309	20640	SUM	Д551	21766





# Тормозные колодки для автомобилей иностранного производства



		i	DAFMI	W.V.A	i	DAFMI	W.V.A

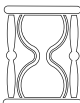

<b>Scorpio</b>							
1.8	03.85-09.94	ATE	Д789 Д916	20907 21396			
2.0	10.94-08.97	ATE	или Д930	21395	LUC	Д689	20981
2.0 I	03.85-09.94	ATE	Д789	20907			
2.0 I GHIA	03.85-09.92	ATE	Д785	20909	LUC	Д685	20981
2.0 I GL	03.85-09.92	ATE	Д785 Д916	20909 21396	LUC	Д685	20981
2.3 16V	10.94-08.98	ATE	или Д930	21395	LUC	Д689	20981
2.4	01.87-02.92	ATE	Д785	20909	LUC	Д685	21079
2.4 I	09.86-09.94	ATE	Д789	20907			
2.4 I GHIA	09.86-09.92	ATE	Д785	20909	LUC	Д685	20981
2.4 I GL	09.86-09.92	ATE	Д785 Д916	20909 21396	LUC	Д685	20981
2.4 V6	03.92-12.98	ATE	или Д930	21395	LUC	Д689	20981
2.5 D	12.85-09.94	ATE	Д789	20907			
2.5 TURBO D	03.85-09.92	ATE	Д785 Д916	20909 21396	LUC	Д685	20981
2.5 TURBO D	10.94-12.98	ATE	или Д930	21395	LUC	Д689	20981
2.8 I GHIA	03.85-09.92	ATE	Д785	20909	LUC	Д685	20981
2.8 I GL	03.85-09.92	ATE	Д785	20909	LUC	Д685	20981
2.8 I 4X4	03.85-09.92	ATE	Д785	20909	LUC	Д685	20981
2.9	01.87-02.92	ATE	Д785	20909	LUC	Д685	21079
2.9 4X4	01.86-02.92	ATE	Д785	20909	LUC	Д685	21079
2.9 I GHIA	09.86-09.92	ATE	Д785	20909	LUC	Д685	20981
2.9 I GL	09.86-09.92	ATE	Д785	20909	LUC	Д685	20981
2.9 I 4X4	09.86-09.92	ATE	Д785	20909	LUC	Д685	20981
2.9 I 24V	04.91-09.94	ATE	Д785 Д916	20909 21396	LUC	Д685	21079
2.9 V6 12V	10.94-06.96	ATE	или Д930	21395	LUC	Д689	20981
2.9 V6 24V	10.94-08.98				LUC	Д685	21079
<b>Sierra</b>							
1.3 L	10.82-02.87	LUC	Д446	21662	LUC	ДА309	
1.6	02.87-12.92	ATE	Д309	20640			
1.6 L	10.82-02.87	LUC	Д446	21662	LUC	ДА309 или Д685	20981
1.6 ST. WAGON	02.87-12.92	ATE	Д309	20640	LUC	ДА309 или Д685	20981
1.8	02.87-12.92	ATE	Д309	20640	LUC	ДА309	
1.8 TD P100 PICK-UP	12.87- 93	ATE или BDX	Д309 или Д983	20640 21141	LUC	ДА309 или Д685	20981
1.8 W/ABS	02.87-12.92	ATE	Д789	20907	LUC	ДА309 или Д685	20981
2.0	02.87-12.92	ATE	Д309	20640	LUC	ДА309	



							
		i	DAFMI	W.V.A	i	DAFMI	W.V.A

2.0 GL	10.82-02.87	ATE	Д309 или Д311	20640 20783	LUC	ДА309	
2.0 L	10.82-02.87	ATE	Д309 или Д311	20640 20783	LUC	ДА309	
2.0 P100 PICK-UP	12.87- 93	ATE или BDX	Д309 или Д983	20640 21141	LUC	ДА309 или Д685	20981
2.0 W/ABS	02.87-12.92	ATE	Д789	20907	LUC	Д689	20981
2.3 D	10.82-02.87	ATE	Д309 или Д311	20640 20783	LUC	ДА309	
2.3 D	02.87-12.92	ATE	Д309	20640	LUC	ДА309 или Д685	20981
2.3 D W/ABS	02.87-12.92	ATE	Д789	20907	LUC	Д689	20981
2.3 GHIA	10.82-02.87	ATE	Д309 Д311	20640 20783	LUC	ДА309	
2.3 GL	10.82-02.87	ATE	Д309 или Д311	20640 20783	LUC	ДА309	
2.8	02.87-12.92	ATE	Д789	20907	LUC	Д689	20981
2.8 XR 4 I	01.83-02.87	ATE	Д785	20909	LUC	Д685	21079
2.8 4X4	85-12.92	ATE	Д785	20909	LUC	Д689	20981
2.9	02.87-12.92	ATE	Д789	20907	LUC	Д689	20981
<b><u>Taunus</u></b>							
TAUNUS ALL MODELS	12.75-09.82	LUC	Д359	20491			
<b><u>Tourneo</u></b>							
ALL 14"	07.94-	BDX	Д837	21470	BDX	ДА837	
ALL 15"	07.94-	LUC	Д864	21469			
<b><u>Transit80 (light commercial)</u></b>							
1.6 (Vent. Disc)	10.76-11.85	AP	- или Д430	20364 20359			
1.6	02.86-10.91	BDX	Д983	21141			
2.0	10.76-11.85	AP	- или Д430	20364 20359			
2.0 14"	10.91-08.99	BDX	Д837	21470	BDX	ДА837	
2.4 D	10.76-11.85	AP	- или Д430	20364 20359			
2.5 D	02.86-10.91	BDX	Д983	21141			
2.5 D	10.91-08.99	BDX	Д837	21470	BDX	ДА837	
<b><u>Transit100 (light commercial)</u></b>							
1.5 Mini Bus	10.76-11.85	AP	Д430	20359			
1.6	02.86-10.91	BDX	Д983	21141			
2.0 Mini Bus	10.76-11.85	AP	- или Д430	20364 20359			
2.0	02.86-10.91	BDX	Д983	21141			
2.0	10.91-08.99	BDX	Д837	21470	BDX	ДА837	

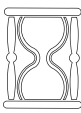
# Тормозные колодки для автомобилей иностранного производства

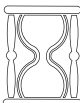

							
		i	DAFMI	W.V.A	i	DAFMI	W.V.A
2.4 D Mini Bus	10.76-11.85	AP	-	20364			
		AP	или Д430	20359			
		AP	-	20364			
2.5 D Mini Bus	10.76-11.85		или Д430	20359			
2.5 D	02.86-10.91	BDX	Д983	21141			
2.5 D	10.91-08.99	BDX	Д837	21470	BDX	ДА837	
<b><u>Transit120 (light commercial)</u></b>							
2.0	10.91-08.99	BDX	Д837	21470	BDX	ДА837	
2.5 D	02.86-10.91	BDX	Д983	21141			
2.5 D	10.91-08.99	BDX	Д837	21470	BDX	ДА837	
<b><u>Transit130 (light commercial)</u></b>							
1.5 Mini Bus	10.76-11.85	AP	-	20364			
		AP	или Д430	20359			
		AP	-	20364			
1.6 Mini Bus	10.76-11.85		или Д430	20359			
		AP	-	20364			
1.7 Mini Bus	10.76-11.85		или Д430	20359			
		AP	-	20364			
2.0 Mini Bus	10.76-11.85		или Д430	20359			
2.0	02.86-10.91	AP	Д430	20359			
2.0	10.91-08.99	BDX	Д864	21469			
		AP	-	20364			
2.4 D Mini Bus	10.76-11.85		или Д430	20359			
		AP	-	20364			
2.5 D Mini Bus	10.76-11.85		или Д430	20359			
2.5 D	02.86-10.91	AP	Д430	20359			
2.5 D	10.91-08.99	BDX	Д864	21469			
<b><u>Transit150 (light commercial)</u></b>							
2.0	10.91-08.99	BDX	Д864	21469			
2.5 D	10.91-08.99	BDX	Д864	21469			
<b><u>Transit160 (light commercial)</u></b>							
2.0	02.86-10.91	AP	Д430	20359			
2.5 D	02.86-10.91	AP	Д430	20359			
<b><u>Transit175 (light commercial)</u></b>							
1.6	02.86-10.91	AP	Д430	20359			
2.0	02.86-10.91	AP	Д430	20359			
2.4 D	02.86-10.91	AP	Д430	20359			
3.0	02.86-10.91	AP	Д430	20359			
<b><u>Transit175 (light commercial)</u></b>							
1.6	02.86-10.91	AP	Д430	20359			
2.0	02.86-10.91	AP	Д430	20359			
2.0	10.91-08.99	BDX	Д864	21469			
2.5 D	02.86-10.91	AP	Д430	20359			
2.5 D	10.91-08.99	BDX	Д864	21469			
<b><u>Transit F (light commercial)</u></b>							
2.0 DI 15" wheels	01.00-	BOSCH	Д340	23430	BOSCH	ДА995	
2.3 16V 15" wheels	01.00-	BOSCH	Д340	23430	BOSCH	ДА995	

							
		i	DAFMI	W.V.A	i	DAFMI	W.V.A



2.4 DI, TDE 15" wheels	01.00-	BOSCH	Д340	23430	BOSCH	ДА995	
<b>Transit Bus/Van/Flatbed-Chassis</b>							
2.2 TDCi, 2.4 TDCi	06-		Д217			Д212	
2.2 TDCi, 2.4 TDCi	06-		Д217			Д212	
<b>GREAT WALL</b>							
<b>Hoover</b>	06-		Д503		SUM	Д505	



## HONDA

<b>Accord (SY)</b>							
ACCORD (SY) ALL MODELS	09.82-12.83	SUM	Д421	20895			
<b>Accord (AC/AD)</b>							
1.6 EX (AC)	09.83-10.85	SUM	Д991	21012			
1.6 EX (AC)	08.83-10.85	SUM	Д991	21012			
1.6 EX (AC)	08.83-10.86	SUM	Д991	21012			
1.6 EX (AC)	08.83-10.87	SUM	Д991	21012			
1.6 EX (AC)	08.83-10.88	SUM	Д991	21012			
1.6 EX (AC)	08.83-10.89	SUM	Д991	21012			
1.6 EX (AC)	08.83-10.90	SUM	Д991	21012			
<b>Accord (CA)</b>							
1.6 L LIM (CA4)	11.85-12.89	AKE	Д968	20099			
1.8 EX (CA)	08.83-10.85	SUM	Д991	21012			
1.8 EXI (CA)	08.83-10.85	SUM	Д991	21012			
1.8 EXR (CA)	08.83-10.85	SUM	Д991	21012			
2.0 EX (CA)	08.83-10.85	SUM	Д991	21012			
2.0 EX (CA)	01.86-08.89	AKE	Д968	20099			
2.0 EX (CA5)	11.85-12.89	AKE	Д968	20099	AKE	Д563	21312
2.0 EX AERODECK (CA5)	11.85-12.89	AKE	Д968	20099	AKE	Д563	21312
2.0 EXI (CA)	08.83-10.85	SUM	Д991	21012			
2.0 EXI (CA)	01.86-08.89	AKE	Д968	20099			
2.0 EXI LIM. (CA5)	11.85-12.89	AKE	Д968	20099	AKE	Д563	21312
2.0 EX AERODECK (CA)	02.86-03.93	AKE	Д968	20099			
2.0 EXI AERODECK (CA)	03.86-03.93	AKE	Д968	20099			
2.0 EXR (CA)	08.83-10.85	SUM	Д991	21012			
2.0 I 16V 13" WHEEL (CA5)	10.87-12.89				AKE	Д563	21312
2.0 I 16V 14" WHEEL (CA5)	10.87-12.89				AKE	Д563	21312
<b>Accord (CB)</b>							
2.0 DX (CB3)	01.90-11.93	AKE	Д122 или Д890	21497 21879			
2.0 LX (CB3)	01.90-11.93	AKE	Д122 или Д890	21497 21879			
2.0 16V LIM. (CB3)	01.90-11.93	AKE	Д122	21497	AKE	Д751	21719
2.0 I EX (CB3)	01.90-11.93	AKE	Д122 или Д890	21497 21879			
2.2 I 16V AERODECK (CB8)	01.90-11.93				AKE	Д751	21719
2.0 I 16V LIM. (CB3)	01.90-11.93	AKE	Д122	21497	AKE	Д751	21719
2.2 (CB7)	01.90-11.93				AKE	Д751	21719
2.2 16V LIM. (CB7)	01.90-11.93	AKE	Д122	21497	AKE	Д751	21719
<b>Accord (CC/CE)</b>							
1.8 (CC7)	01.93-09.98	AKE	Д717I	21651	AKE	Д751	21719
2.0 ES/LS/S (CC7/CC8)	01.93-09.98	AKE	Д717I	21651	AKE	Д751	21719
2.2 i 16V (CC7)	01.93-09.98	AKE	Д717I	21651	AKE	Д751	21719

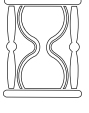
# Тормозные колодки для автомобилей иностранного производства

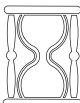

							
		i	DAFMI	W.V.A	i	DAFMI	W.V.A
2.3 All (CC7)	01.93-12.95	AKE	Д717И	21651	AKE	Д751	21719
2.0 Aerodeck LE/LX (CC9)	01.93-12.93	AKE	Д717И	21651	AKE	Д751	21719
<b>Accord (CE/CF)</b>							
1.8 ES/LS/S (CE7)	01.96-09.98	AKE	Д717И или Д890	21651 21879	AKE	Д751	21719
1.8 ES/LS/S (CE7)	01.96-09.98	AKE	Д890	21879	AKE	Д751	21719
2.2 VTEC (CE9)	01.96-09.98	AKE	Д717И	21651	AKE	Д751	21719
2.0 Aerodeck ES/LS (CE2)	01.94-10.97	AKE	Д890	21879	AKE	Д751	21719
2.2 Aerodeck ES/LS (CE1)	01.94-10.97	AKE	Д890	21879	AKE	Д751	21719
<b>Accord VII (CG/CH)</b>							
1.8 VTEC ES/LS/S (CG8/CH6)	10.98-12.02	LUC	Д200И	23094/ 23095	AKE		21719
1.8 SE (CH6)	04.99-12.02	LUC	Д200И	23094/ 23095	AKE		21719
2.0 VTEC ES/LS (CG9/CH7)	10.98-12.02	LUC	Д200И	23094/ 23095	AKE		21719
2.0 TDI (CH7)	01.98-12/02	LUC	Д200И	23094/ 23095	AKE		21719
2.2 VTEC (CH1)	10.98-	AKE	Д717И	21651	AKE	Д751	21719
<b>Ballade</b>							
1.6	01.87-12.89	AKE	Д968	20099			
1.8	01.87-12.89	AKE	Д968	20099			
<b>Civic I (SL/SS)</b>							
1.3 EXC. ST. WAGON (SL)	01.82-12.83	SUM	Д421	20895			
1.3 ST. WAGON (SS)	01.82-12.83	AKE	Д475	21351			
<b>Civic II (AF/AG/AH/AL/AS)</b>							
1.2 (AG)	01.84- 88	SUM	Д421	20895			
1.2 (AH)	01.84- 88	SUM	Д421	20895			
1.2 (AL)	01.84- 88	SUM	Д421	20895			
1.3 (AG)	10.83- 88	SUM	Д421	20895			
1.3 (AH)	01.84- 88	SUM	Д421	20895			
1.3 (AL)	10.83- 88	SUM	Д421	20895			
1.5 (AL)	01.84- 88	SUM	Д421	20895			
1.5 (AG)	01.84- 88	SUM	Д421	20895			
1.5 (AH)	01.84- 88	SUM	Д421	20895			
1.5 GL (AH)	10.83-10.97	SUM	Д421	20895			
1.5 GT (AH)	01.85-10.87	SUM	Д421	20895			
1.5 CRX (AF)	01.84- 85	SUM	Д421	20895			
1.5 CRX (AF)	85- 88	AKE	Д475	21351			
1.5 CRX (AS)	85- 88	AKE	Д968	20099			
1.5 CRX I (AF)	10.83-11.86	SUM	Д421	20895			
1.6 CRX I (AS)	03.86-10.87	AKE	Д968	20099			
<b>Civic III (EC/ED/EE)</b>							
1.3 (EC7)	88- 92	AKE	Д475	21351			
1.4 L (EC8)	88- 92	AKE	Д475	21351			
1.5 (EC9)	88- 92	AKE	Д475	21351			
1.6 (EE5)	88- 92	AKE	Д475	21351			
1.6 GL 16V (EE9)	88- 92	AKE	Д475	21351			
1.6 CRX I 16V (ED9)	10.87-02.92				AKE	Д563	21312
1.6 CRX I 16V (EE6)	10.87-02.92				AKE	Д563	21312
1.6 CRX I 16V (EE8)	10.87-02.92				AKE	Д563	21312
<b>Civic IV (EG/EH)</b>							
1.3 (EG3)	01.92-12.95	AKE	Д475	21351			
1.5 All (EG8/EG4)	01.92-12.95	SUM	Д872	21697			

							
		i	DAFMI	W.V.A	i	DAFMI	W.V.A

1.6 All(No ABS) (EG59)	01.92-12.95	SUM	Д872	21697	AKE	Д563	21312	
<b><u>Civic V (MA/MB/MC)</u></b>								
1.4 (MA8/MB2)	02.95-				AKE	Д563	21312	
1.5 (MA9/MB3)	02.95-				AKE	Д563	21312	
1.6 (MB1/MB4)	02.95-				AKE	Д563	21312	
1.6 Aerodeck (MC1)	02.98-				AKE	Д751	21719	
1.8 (MB6)	01.97-	AKE	Д717И	21651	AKE	Д751	21719	
1.8 Aerodeck (MC2)	02.98-	AKE	Д717И	21651	AKE	Д751	21719	
2.0 TDI (MB7)	01.97-				AKE	Д563	21312	
2.0 D Aerodeck (MC2)	05.98-				AKE	Д563	21312	
<b><u>Civic VI (EJ/EK)</u></b>								
1.5 Coupe (EJ2)	08.93-12.95	AKE	Д872	21697				
1.6 (EK1/EK4)	01.96-				AKE	Д563	21312	
1.6 Coupe (EJ6)	01.96-12.97	AKE	- или Д872	21697				
<b><u>Civic CRX</u></b>								
1.4 (EE6)	01.90-12.91	AKE	Д475	21351				
1.5 (AAF)	09.83-08.85	SUM	Д421	20895				
1.5 (AAF)	09.85-12.87	AKE	Д475	21351				
1.6 (AAS)	09.83-12.87	AKE	Д968	20099				
1.6 (ED9)	01.88-05.92				AKE	Д563 или Д968	21312 20099	
1.6 (EE8)	01.90-05.92	AKE	Д475	21351	AKE	Д563	21312	
1.6 (EG2)	06.92-12.93				AKE	Д563	21312	
<b><u>Civic Shuttle (AN/AR)</u></b>								
1.5 (AN)	01.84- 88	AKE	Д475	21351				
1.5 (AR)	85- 88	SUM	Д421	20895				
<b><u>Concerto</u></b>								
ALL MODELS	10.89-10.96				AKE	Д563	21312	
<b><u>CRV</u></b>								
CRV 2.0 ALL MODELS	07.95-	AKE	Д717И	21651				
<b><u>HRV</u></b>								
HRV 1.6 ALL MODELS	99-	AKE	Д717И	21651				
<b><u>Integra</u></b>								
1.6 (DA1)	01.86-12.88	AKE	Д968	20099				
<b><u>Legend</u></b>								
3.2 All (KA7/KA8)	01.89-12.95	AKE	Д717И	21651	AKE	Д751	21719	
3.5 All (KA9)	01.96-12.98	AKE	Д717И	21651	AKE	Д751	21719	
3.5 All (KA9)	01.99-				AKE	Д751	21719	
<b><u>Logo</u></b>								
1.3 All (GA3)	02.99-	SUM	Д872	21697				
<b><u>NSX</u></b>								
3.0 All (SRS)	09.90-12.96	AKE	Д717И	21651				
<b><u>Prelude</u></b>								
1.8 (AAB)	01.83-12.87	AKE	Д475	21351				
2.0 (BA4)	01.90-09.91	AKE	Д890	21879	AKE	Д563	21312	
2.0 (BB3)	10.91-12.96	AKE	Д890	21879	AKE	Д751	21312	
2.0 (BB9)	01.97-	AKE	Д890	21879	AKE	Д751	21312	
2.2 (BB1)	01.93-12.96	AKE	Д890	21879	AKE	Д751	21312	
2.2 (BB6/BB8)	01.97-	AKE	Д717И	21651	AKE	Д751	21312	
2.3 All (BB2/BB3)	10.91-12.96	AKE	Д717И	21651	AKE	Д751	21312	
<b><u>S200</u></b>								
2.0 All (AP1)	03.99-				AKE	Д751	21312	

# Тормозные колодки для автомобилей иностранного производства





		i	DAFMI	W.V.A	i	DAFMI	W.V.A

<b>Shuttle</b>							
SHUTTLE ALL MODELS	03.95-	AKE	Д717И	21651	AKE	Д751	21312
<b>Stream</b>							
STREAM ALL MODELS	05.01-				AKE	Д751	21312

## HYUNDAI

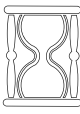
<b>Atos</b>							
1.0	11.97-	MAN	Д991	21012			
<b>Accent</b>							
1.3	10.94-	AKE	Д991	21012		ДА991	
1.5 16V	10.94-	AKE	Д991	21012		ДА991	
<b>Avante</b>							
1.8	06.01-07.03	MAN	Д214	24031/ 24032/ 24033			
1.8 W/ABS	06.95-05.00	AKE	Д487	21725	SUM	Д211	21553/ 21554/ 21555
1.8 W/ABS	06.00-05.01				SUM	Д211	21553/ 21554/ 21555
1.8 W/ABS	06.01-07.03	MAN	Д214	24031/ 24032/ 24033	SUM	Д211	21553/ 21554/ 21555
2.0	06.01-07.03	MAN	Д214	24031/ 24032/ 24033			
2.0 W/ABS	06.97-05.00	AKE	Д487	21725	SUM	Д211	21553/ 21554/ 21555
2.0 W/ABS	06.00-05.01				SUM	Д211	21553/ 21554/ 21555
2.0 W/ABS	06.01-07.03	MAN	Д214	24031/ 24032/ 24033	SUM	Д211	21553/ 21554/ 21555
<b>Coupe</b>							
1.6	08.96-10.97	AKE	Д487	21725			
1.6 W/ABS	11.96-01.02				SUM	Д211	21553/ 21554/ 21555
1.6 W/ABS	02.02-	MAN	Д191	23891			
1.6	02.02-				SUM	Д211	21553/ 21554/ 21555
2.0	08.96-10.97	AKE	Д487	21725			
2.0	04.96-01.02				SUM	Д211	21553/ 21554/ 21555
2.0	02.02-06.03	MAN	Д191	23891	SUM	Д211	21553/ 21554/ 21555
2.0 TIBURON	04.96-07.99				SUM	Д211	21553/ 21554/ 21555



							
		i	DAFMI	W.V.A	i	DAFMI	W.V.A



2.7	02.02-	MAN	Д191	23891	SUM	Д211	21553/ 21554/ 21555
<b><i>Elantra/Lantra</i></b>							
1.5	12.90-05.95	MAN	Д991	21012			
1.5 W/ABS	02.97-05.00	MAN	Д487	21725	SUM	Д211	21553/ 21554/ 21555
1.5 W/ABS ESTATE/WAGON	02.97-05.00	MAN	Д487	21725	SUM	Д211	21553/ 21554/ 21555
1.6	12.90-05.00	MAN	Д487	21725			
1.6	06.01-07.03	MAN	Д214	24031/ 24032/ 24033			
1.6 W/ABS	06.95-05.00	MAN	Д487	21725	SUM	Д211	21553/ 21554/ 21555
1.6 W/ABS	06.00-05.01				SUM	Д211	21553/ 21554/ 21555
1.6 W/ABS	06.01-07.03	MAN	Д214	24031/ 24032/ 24033	SUM	Д211	21553/ 21554/ 21555
1.6 W/ABS ESTATE/WAGON	09.95-05.00	MAN	Д487	21725	SUM	Д211	21553/ 21554/ 21555
1.8	06.92-	MAN	Д487	21725			
1.8	06.00-05.01				SUM	Д211	21553/ 21554/ 21555
1.8	06.01-07.03	MAN	Д214	24031/ 24032/ 24033			
1.8 W/ABS	06.95-05.00	MAN	Д487	21725	SUM	Д211	21553/ 21554/ 21555
1.8 W/ABS	06.00-05.01				SUM	Д211	21553/ 21554/ 21555
1.8 W/ABS	06.01-07.03	MAN	Д214	24031/ 24032/ 24033	SUM	Д211	21553/ 21554/ 21555
1.8 W/ABS ESTATE/WAGON	09.95-05.00	MAN	Д487	21725	SUM	Д211	21553/ 21554/ 21555
1.9	04.97-05.00	MAN	Д487	21725			
1.9 W/ABS	04.97-05.00	MAN	Д487	21725	SUM	Д211	21553/ 21554/ 21555
1.9 ESTATE/WAGON	04.97-05.00	MAN	Д487	21725			
1.9 W/ABS ESTATE/WAGON	04.97-05.00	MAN	Д487	21725	SUM	Д211	21553/ 21554/ 21555
2.0 GLS	06.97-	MAN	Д487	21725			

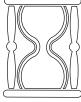

# Тормозные колодки для автомобилей иностранного производства

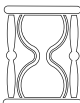

							
		i	DAFMI	W.V.A	i	DAFMI	W.V.A
2.0	04.97-05.00	MAN	Д487	21725			
2.0	06.00-05.01				SUM	Д211	21553/ 21554/ 21555
2.0	06.01-07.03	MAN	Д214	24031/ 24032/ 24033			
2.0 W/ABS	04.97-05.00	MAN	Д487	21725	SUM	Д211	21553/ 21554/ 21555
2.0 W/ABS	06.00-05.01				SUM	Д211	
2.0 W/ABS	06.01-07.03	MAN	Д214	24031/ 24032/ 24033	SUM	Д211	21553/ 21554/ 21555
2.0 CRDI	03.01-	MAN	Д214	24031/ 24032/ 24033	SUM	Д211	21553/ 21554/ 21555
2.0 CRDI W/ABS	03.01-07.03	MAN	Д214	24031/ 24032/ 24033	SUM	Д211	21553/ 21554/ 21555
2.0 ESTATE/WAGON	04.97-05.00	MAN	Д487	21725			
2.0 W/ABS ESTATE/WAGON	04.97-05.00	MAN	Д487	21725	SUM	Д211	21553/ 21554/ 21555
<b><u>Excel</u></b>							
1.3 I GL	01.88-06.90	AKE	Д991	21012			
1.3 I GLS	01.88-06.90	AKE	Д991	21012			
1.3 I L	01.88-07.91	SUM	Д646	20703			
1.5 L	01.88-08.89	SUM	Д646	20703			
1.5 I GL	01.88-08.94	AKE	Д991	21012			
1.5 I GLS	01.88-08.94	AKE	Д991	21012			
1.5 I L	01.88-12.99	AKE	Д991	21012			
1.5 I LS	12.91-12.99	AKE	Д991	21012			
1.5 SGX	11.89-08.92	AKE	Д991	21012			
1.5 SX	11.89-08.92	AKE	Д991	21012			
1.5 I MULTIPOINT	06.90-08.94	AKE	Д991	21012			
<b><u>Galloper</u></b>							
ALL MODELS	11.97-	SUM	Д487	21725			
<b><u>Lavita</u></b>							
1.8	07.00-03.02				MAN	Д198	23543
1.8	04.02-	MAN	Д214	24031/ 24032/ 24033	MAN	Д198	23543
<b><u>Highway Van</u></b>							
VAN (all models)	04.00-03.04	MAN	Д218				
<b><u>H100</u></b>							
2,4	07.93-	LUC	Д343				
2,5D	07.93-	LUC	Д343				
2,5TD	07.93-	LUC	Д343				
<b><u>H-1</u></b>							
2,5D	10.97-	LUC	Д343				

							
		i	DAFMI	W.V.A	i	DAFMI	W.V.A

2,5TD	10.97-	LUC	Д343				
<b><u>I 30</u></b>							
1.4	10.07-		Д233				
1.6	10.07-		Д233				
2.0	10.07-		Д233				
<b><u>I 30 CW</u></b>							
1.4	02.08-		Д233				
1.6 CRDi	02.08-		Д233				
2.0	02.08-		Д233				
<b><u>Matrix</u></b>							
1.5 CRDI	04.02-	MAN	Д214	24031/ 24032/ 24033			
1.5 CRDi W/ABS	08.01-03.02				MAN	Д198	23543
1.5 CRDi W/ABS	04.02-	MAN	Д214	24031/ 24032/ 24033	MAN	Д198	23543
1.6	04.02-	MAN	Д214	24031/ 24032/ 24033			
1.6 W/ABS	06.01-03.02				MAN	Д198	23543
1.6 W/ABS	04.02-	MAN	Д214	24031/ 24032/ 24033	MAN	Д198	23543
1.8	06.01-03.02				MAN	Д198	23543
1.8	04.02-	MAN	Д214	24031/ 24032/ 24033	MAN	Д198	23543
<b><u>Pony</u></b>							
1.2	79-08.88	SUM	Д646	20703			
1.3	79-08.88	SUM	Д646	20703			
1.3 LS	09.88-06.90	AKE	Д991	21012			
1.4	79-08.88	SUM	Д646	20703			
1.5	79-08.88	SUM	Д646	20703			
1.5 I GS	09.88-08.94	AKE	Д991	21012			
1.5 I GLS	09.88-12.99	AKE	Д991	21012			
1.5 LS	09.88-12.99	AKE	Д991	21012			
<b><u>S-Coupe</u></b>							
1.5 GS	04.90-12.92	AKE	Д991	21012			
1.5 GT	10.92-06.92	AKE	Д991	21012			
1.5 I 12V	10.92-07.93	AKE	Д991	21012			
1.5 LS	04.90-07.93	AKE	Д991	21012			
<b><u>Santa Fe</u></b>							
SANTA FE ALL MODELS	08.00-	MAN	Д209	23569	MAN	Д198	23543
<b><u>Sonata</u></b>							
1.8 I	09.91- 98	AKE	Д487	21725			
2.0 I	09.91- 96	AKE	Д487	21725			
2.4 I	09.91- 96	AKE	Д487	21725			
2.0 W/ABS	06.98-05.01				MAN	Д198	23543
2.0 W/ABS	06.01-11.04	MAN	Д191	23891	MAN	Д198	23543
2.4 W/ABS	06.98-				MAN	Д198	23543
2.5	06.98-05.01				MAN	Д198	23543

# Тормозные колодки для автомобилей иностранного производства





		i	DAFMI	W.V.A	i	DAFMI	W.V.A

2.7 3.0 I	06.01-11.04 09.91- 96	MAN AKE	Д191 Д487	23891 21725	MAN	Д198	23543
<b><u>Sonica</u></b>							
2.0 W/ABS	06.98-05.01				MAN	Д198	23543
2.0 W/ABS	06.01-11.04	MAN	Д191	23891	MAN	Д198	23543
2.5	06.98-05.01				MAN	Д198	23543
2.7	06.01-11.04	MAN	Д191	23891	MAN	Д198	23543
<b><u>Stellar</u></b>							
1.4 L	02.84-01.87	LUC	Д359	20491			
1.6 GSL	02.84-02.90	LUC	Д359	20491			
1.6 L	02.84-02.90	LUC	Д359	20491			
1.6 SL	02.84-02.90	LUC	Д359	20491			
2.0 GSL	06.86-02.90	AKE	Д991	21012			
<b><u>Tiburon</u></b>							
1.6	08.99-01.02				SUM	Д211	21553/ 21554/ 21555
2.0	08.99-01.02				SUM	Д211	21553/ 21554/ 21555
2.7	02.02-	MAN	Д191	23891	SUM	Д211	21553/ 21554/ 21555
<b><u>Trajet</u></b>							
TRAJET ALL MODELS	09.99-	MAN	Д218				
<b><u>Tucson</u></b>							
TUCSON ALL MODELS	06.04-				MAN	Д198	23543
2.0	06.04-	MAN	Д191	23891	MAN	Д198	23543
2.0 CRDi	06.04-	MAN	Д191	23891	MAN	Д198	23543
2.7	06.04-	MAN	Д191	23891	MAN	Д198	23543
<b><u>Tuscani</u></b>							
2.7	05.01-	MAN	Д191	23891	SUM	Д211	21553/ 21554/ 21555
<b><u>XG25</u></b>							
2.5	06.99-09.05				MAN	Д198	23543
<b><u>XG30</u></b>							
3.0	09.99-09.05				MAN	Д198	23543
<b><u>XG350</u></b>							
3.5	10.02-				MAN	Д198	23543

## ISUZU

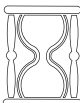
<b><u>Midi (light commercial)</u></b>							
MIDI-BUS 2.0	01.89-8.92	SUM	Д175	21115			
MIDI-BUS 2.0 TD	01.89-8.92	SUM	Д175	21115			
MIDI-BUS 2.2 D	01.89-8.92	SUM	Д175	21115			
MIDI-BUS 2.4 D	01.89-	SUM	Д175	21115			
MIDI-VAN 2.0	01.89-8.92	SUM	Д175	21115			
MIDI-VAN 2.0 TD	01.89-8.92	SUM	Д175	21115			
MIDI-VAN 2.2 D	01.89-8.92	SUM	Д175	21115			
MIDI-VAN 2.4 D	01.89-8.92	SUM	Д175	21115			
MIDI-VAN 2.4 TD	01.94-	SUM	Д175	21115			
<b><u>Trooper</u></b>							
2.2 (UBS)	11.86-12.91	AKE	Д866	21543			
2.2 TD (UBS)	11.85-12.87	AKE	Д866	21543			
2.6 (UBS)	06.88-10.91	AKE	Д866	21543			

							
		i	DAFMI	W.V.A	i	DAFMI	W.V.A

2.8 TD (UBS)	06.88-10.91	AKE	Д866	21543			
3.1 TD (UBS4JG2)	11.91-12.97	AKE	Д139	21845			
3.2 16V (UBS6VD1)	11.91-12.97	AKE	Д139	21845			
<b>WFR/MFR 11/12/53 (light commercial)</b>							
1.8	83- 90	SUM	Д175	21115			
2.0	83- 90	SUM	Д175	21115			
2.2	83- 90	SUM	Д175	21115			
2.2 D	83- 90	SUM	Д175	21115			
<b>NQR (light commercial)</b>							
NQR	01.95-		Д229				

## IVECO

<b>Daily (light commercial)</b>							
35.8-40.8	90- 96	BRE	Д129	21048			
35.8, 35.9, 35.10	96-	BRE	Д164	29121	BRE	Д164	29121
40.10	96-	BRE	Д168	29040			
45.10	89-	BRE	Д168	29040			
45.12	92-05.96	BRE	Д164	29121	BRE	Д164	29121
49.10, 49.12	89- 96	PER	Д168	29040			
49.10, 49.12	96-	PER	Д164	29121			
<b>Turbo Daily (light commercial)</b>							
35.8	01.91-	BRE	Д129	21048			
35.9	01.91-	BRE	Д129	21048			
35.10	01.91-	BRE	Д129	21048			
40.8	01.91-	BRE	Д129	21048			
40.10	01.96-	BRE	Д164	29121	BRE	Д164	29121
49.10, 49.12	89- 96	PER	Д168	29040			
49.10, 49.12	96-	PER	Д164	29121			
TURBO DAILY ALL MODELS	05.99-	BRE	Д128	29121	BRE	Д281	29123
<b>Eurocargo (light commercial)</b>							
75 E	91- 96	PER	Д989	29835			
<b>Eurocargo Range (light commercial)</b>							
60 E	91-	PER	Д989	29835	PER	Д989	29835

## JEEP



<b>Cherokee</b>							
2.1 D	01.91-04.95	KEL	Д130	21822			
2.5 TD	01.93- 96	KEL	Д130	21822			
4.0	01.91- 96	KEL	Д130	21822			
<b>Grand Cherokee</b>							
2.5	06.94-02.99	KEL	Д130	21822			
4.0	01.92-02.99	KEL	Д130	21822			
5.2	01.92-02.99	KEL	Д130	21822			
5.9	06.97-02.99	KEL	Д130	21822			
<b>Wrangler</b>							
2.5	01.91-02.99	KEL	Д130	21822			
4.0	01.91-02.99	KEL	Д130	21822			



## KIA

<b>Besta (light commercial)</b>							
BESTA 2.2	92-10.97	AKE	Д628	20002			
<b>Carens</b>							
1.8 W/ABS	07.99-06.02	MAN	Д196		SUM	Д235	23455/ 23456/ 23457
1.8	07.99-06.02	MAN	Д196				
<b>Carens II (FJ)</b>							
1.6			Д233				

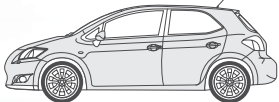
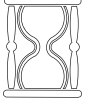
# Тормозные колодки для автомобилей иностранного производства

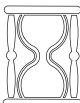

							
		i	DAFMI	W.V.A	i	DAFMI	W.V.A
1.8	07.02-		Д233		SUM	Д235	23455/ 23456/ 23457
2.0			Д233				
<b><u>Carnival</u></b>							
2.5 All	10.98-05.00	KEL	Д130	21822			
2.9 D All	10.98-05.00	KEL	Д130	21822			
<b><u>CEED</u></b>							
CEE'D универсал 1.4, 1.6, 2.0 CRDi			Д233			Д234	
CEE'D хэтчбек 1.4, 1.6, 2.0 CRDi			Д233			Д234	
PRO CEE'D 1.4, 1.6, 2.0 CRDi			Д233			Д234	
<b><u>Cerato</u></b>							
CERATO ALL MODELS	03.04-	MAN	Д193		MAN	Д211	21553/ 21554/ 21555
<b><u>Clarus</u></b>							
1.8	02.96-02.99	ATE	Д134	23450/ 23451			
1.8 W/ABS	02.96-02.99	ATE	Д134	23450/ 23451	SUM	Д235	23455/ 23456/ 23457
1.8 W/ABS	03.99-08.01	MAN	Д196		SUM	Д235	23455/ 23456/ 23457
1.8	09.99-08.01	MAN	Д196				
2.0	03.96-02.99	ATE	Д134	23450/ 23451	SUM	Д235	23455/ 23456/ 23457
2.0	03.99-08.01	MN	Д196		SUM	Д235	23455/ 23456/ 23457
<b><u>Credos</u></b>							
1.8	06.96-11.98	ATE	Д134				
1.8 W/ABS	06.96-11.98	ATE	Д134		SUM	Д235	23455/ 23456/ 23457
2.0	03.96-10.00	ATE	Д134		SUM	Д235	23455/ 23456/ 23457
2.0	03.96-10.00	MAN	Д196		SUM	Д235	23455/ 23456/ 23457
<b><u>Mentor II</u></b>							
1.5 W/ABS	05.99-03.01				SUM	Д235	23455/ 23456/ 23457
1.6 W/ABS	04.01-				SUM	Д235	23455/ 23456/ 23457
<b><u>Pride</u></b>							
1.4	03.05-					Д234	

							
		i	DAFMI	W.V.A	i	DAFMI	W.V.A



1.6 1.5 CRDi	03.05- 03.05-					Д234 Д234	
<b><u>Rio</u></b>							
1.3	08.02-02.05	MAN	Д196				
1.5	08.02-02.05	MAN	Д196				
<b><u>RIO NEW</u></b>							
1.4	03.05-					Д234	
1.6	03.05-					Д234	
1.5 CRDi	03.05-					Д234	
<b><u>Sephia</u></b>							
1.5	93- 98	ATE	Д309	20640			
1.6	93- 98	ATE	Д309	20640			
1.8	93- 98	ATE	Д309	20640			
<b><u>Sephia II</u></b>							
1.6 W/ABS	04.01-				SUM	Д235	23455/ 23456/ 23457
<b><u>Shuma</u></b>							
1.5 W/ABS	02.98-03.01				SUM	Д235	23455/ 23456/ 23457
1.8 W/ABS	02.98-03.01				SUM	Д235	23455/ 23456/ 23457
<b><u>Shuma II</u></b>							
1.6 W/ABS	04.01- 08.04				SUM	Д235	23455/ 23456/ 23457
1.8	05.01- 08.04				SUM	Д235	23455/ 23456/ 23457
<b><u>Sorento</u></b>							
2.4 2.5CRDi							
3.3 V6	07.02-	SUM	Д232	24068/ 24069/ 24070	SUM	Д345	
3.5 V6							
<b><u>Spectra</u></b>							
1.6 W/ABS	04.01-		Д196		SUM	Д235	23455/ 23456/ 23457
<b><u>Sportage</u></b>							
SPORTAGE 2.0 MRDI	08.94-08.97		Д805	21892			
SPORTAGE 2.0 TDI	07.96-08.97		Д805	21892			
SPORTAGE 2.2 D	08.94-08.97		Д805	21892			
2.0 4x4	09.04-	MAN	Д191	23891			
2.0 FWD	09.04-	MAN	Д191	23891			
2.7 4x4	09.04-	MAN	Д191	23891			



## LANCIA

<b><u>Dedra</u></b>							
1.6 IE W/ABS	02.90-02.93	LUC	Д373	20838	LUC BDX	Д938 или Д960	21103 20293

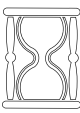
# Тормозные колодки для автомобилей иностранного производства

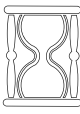

							
		i	DAFMI	W.V.A	i	DAFMI	W.V.A
1.6 IE EXC. ABS	04.89-06.94	LUC	Д482	21100			
1.8	09.89-06.94	LUC	Д373	20838	LUC	Д938 или Д960	21103  20293
1.8 TURBO D	90-06.94	LUC	Д373	20838	LUC	Д938	21103
1.9 TURBO D	09.89-04.97	LUC	Д373	20838	LUC BDX	Д938 или Д960	21103  20293
2.0 IE	09.89-08.91	LUC	Д373	20838	LUC BDX	Д938 или Д960	21103  20293
2.0 IE INTEGRALE	11.90-06.94	LUC	Д711И1	21074	LUC BDX	Д938 или Д960	21103  20293
2.0 IE TURBO	07.90-06.94	LUC	Д711И1	21074	LUC BDX	Д938 или Д960	21103  20293
2.0 TURBO D	90-06.94	LUC	Д373	20838	LUC	Д938	21103
<b><u>Delta</u></b>							
1.4 LE/LS	10.94-	LUC	Д373	20838			
1.6 HF TURBO	85-06.93	LUC	Д425	21093	LUC	Д369	20668
1.6 GT	01.83-10.93				LUC	Д960	20293
1.6 IE	01.83-08.96				LUC	Д960	20293
1.6 IE	06.93-	LUC	Д373	20838			
1.6 IE W/ABS	06.93-	LUC	Д373	20838	LUC	Д938	21103
1.6 LX	01.83-				LUC	Д960	20293
1.8 IE	06.93-	LUC	Д373	20838	LUC	Д938	21103
1.9 TD	94-05.96	LUC	Д373	20838	LUC	Д938	21103
1.9 TD	.96-				LUC	Д938	21103
2.0 16V	06.93-	LUC	Д711И1	21074	LUC	Д938	21103
2.0 16V INTEGRALE	06.93-	LUC	Д711И1	21074	LUC	Д960	20293
2.0 16V TURBO	03.96-	LUC	Д711И1	21074	LUC	Д938	21103
2.0 IE HF TURBO	05.83-06.93				LUC	Д960	20293
<b><u>Kappa</u></b>							
KAPPA ALL MODELS	10.94-	LUC	Д711И1	21074			
<b><u>Prisma</u></b>							
1.3	82-03.86	LUC	Д425	21093			
1.5	82-03.86	LUC	Д425	21093			
1.6	82-03.86	LUC	Д425	21093			
1.6 IE	04.86-12.89	LUC	Д373	20838			
1.9 TURBO D	05.85-12.89	LUC	Д373	20838			
2.0 IE	04.86-12.89	LUC	Д373	20838			
2.0 4WD	04.86-12.89	LUC	Д373	20838			
<b><u>Thema</u></b>							
2.0	11.84- 87	LUC	Д425	21093	LUC	Д369	20668
2.0	88- 94	BDX	Д792И	21182	LUC	Д369	20668
2.0 16V	08.92-12.93	LUC	Д711И1	21074	LUC	Д960	20293
2.0 TURBO 16V	12.88-09.92	BDX	Д792И	21182	LUC	Д369 или Д960	20668  20293

							
		i	DAFMI	W.V.A	i	DAFMI	W.V.A

2.0 TURBO 16V	10.92-05.95	LUC	Д711И1	21074	LUC	Д369 или Д960	20668  20293
2.4 TD	84- 88	LUC	Д425	21093	LUC	Д960	20293
2.5 TD	84- 87	LUC	Д425	21093	LUC	Д369	20668
2.5 TD	88- 94	LUC	Д711И1	21074	LUC	Д369	20668
2.8 V6	10.85- 87	LUC	Д425	21093	LUC	Д369	20668
2.8 V6	88- 94	BDX	Д792И	21182	LUC	Д369	20668
2.9	86- 94				LUC	Д369	20668
3.0 V6	91- 94	LUC	Д711И1	21074	LUC	Д369 или Д960	20668  20293
<b>Y</b>							
1.3 GT	09.89-				LUC	Д369	20668
1.3 I	09.89-				LUC	Д369	20668
<b>Y10</b>							
1.0 FIRE	06.85-02.92	BDX	Д334	20950			
1.0 TURBO	03.85-02.89	LUC	Д373	20838			
1.1 4WD	01.95- 96	BDX	Д334	20950			
1.1 AVENUE	01.95- 96	BDX	Д334	20950			
1.1 FIRE	07.89- 96	BDX	Д334	20950			
1.1 FIRE IE 4WD	09.92- 96	BDX	Д334	20950			
1.1 TURBO	85- 96	BDX	Д334	20950			
1.3 FIRE IE	11.87- 96	LUC	Д373	20838			
1.4	96-	LUC	Д373	20838			
<b>Zeta</b>							
2.0 TURBO IE	08.94-	LUC	Д711И3	21074			
2.1 HL TD	07.96-	LUC	Д711И3	21074			

## LAND ROVER

<b>90</b>							
90 2.3	84- 85	AP	Д430	20359			
90 3.5	82- 90	AP	Д430	20359			
<b>Range Rover</b>							
RANGE ROVER ALL MODELS	06.70- 85	AP	Д430	20359			

## LEXUS

<b>400</b>							
LS 400	12.89-08.92	АIS	Д185	21791			

## MAZDA

<b>121</b>							
1.1 (DB1)	02.91-10.93	SUM	Д774	21654			
1.2 (BAJ)	01.96-	ATE	Д309	20640			
1.3 (DB1)	02.91-12.95	SUM	Д774	21654			
1.8 D (BAJ)	01.96-	ATE	Д309	20640			
<b>2 (DY)</b>							
1.4 CD	04.03-10.07	ATE	Д714	23203			
1.25	04.03-10.07	ATE	Д714	23203			
1.4	04.03-10.07	ATE	Д714	23203			
1.6	04.03-10.07	ATE	Д714	23203			
<b>3</b>							
1.3 (BK14)	10.03-	ATE	Д613	23723	ATE	Д966	23482/ 23483
1.6 (BK12/BK14)	10.03-	ATE	Д613	23723	ATE	Д966	23482/ 23483
1.6 CITD (BK12/BK14)	10.03-	ATE	Д613	23723	ATE	Д966	23482/ 23483
2.0 (BK12/BK14)	10.03-	ATE	Д613	23723	ATE	Д966	23482/ 23483
2.3 (BK14)	10.03-	ATE	Д613	23723	ATE	Д966	23482/ 23483





# Тормозные колодки для автомобилей иностранного производства



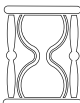

		i	DAFMI	W.V.A	i	DAFMI	W.V.A

<b>323</b>							
1.3	(BG)	09.89-07.94	SUM	Д774	21654		
1.3	(BA)	05.94-04.98	SUM	Д774	21654		
1.3 W/ABS	(BJ12)	10.00-10.03				AKE	Д222 20645/ 24045
1.3 F W/ABS	(BJ14)	10.00-10.03				AKE	Д222 20645/ 24045
1.5	(BG)	09.89-02.91	SUM	Д774	21654		
1.5	(BA)	05.94-07.98	SUM	Д774	21654		
1.5 F	(BA)	05.94-07.98	SUM	Д774	21654		
1.6	(BG)	09.89-10.94	SUM	Д774	21654		
1.6	(BJ12)	10.00-10.03				AKE	Д222 20645/ 24045
1.6 F	(BJ14)	10.00-10.03				AKE	Д222 20645/ 24045
1.7 D	(BG)	09.89-07.94	SUM	Д774	21654		
1.8 W/REAR DISC	(BG)	04.91-07.94	SUM	Д774	21654		
1.8	(BJ1)	05.98-09.00				AKE	Д222 20645/ 24045
1.8 F	(BJ1)	08.98-09.00				AKE	Д222 20645/ 24045
1.9	(BG)	03.91-07.94	SUM	Д774	21654		
2.0 DITD	(BJ12)	10.00-10.02				AKE	Д222 20645/ 24045
2.0 F	(BJ14)	10.00-10.03				AKE	Д222 20645/ 24045
2.0 F DITD	(BJ14)	10.00-10.03				AKE	Д222 20645/ 24045
F ALL MODELS	(BG)	07.89- 94	SUM	Д774	21654		
<b>5</b>							
MAZDA 5 ALL MODELS		02.05-	ATE	Д613	23723	ATE	Д206 24137
<b>6</b>							
1.8	(GG12/GG14)	04.02-	SUM	Д207		AKE	Д222 20645/ 24045
2.0	(GG12/GG14)	04.02-	AKE	Д199	24046/ 24047/ 24048	AKE	Д222 20645/ 24045
2.0 O/CiTD	(GG12/GG14)	10.02-	AKE	Д199	24046/ 24047/ 24048	AKE	Д222 20645/ 24045
2.3 17"SW	(GG12/GG14)	04.02-	AKE	Д199	24046/ 24047/ 24048	AKE	Д222 20645/ 24045
6 ESTATE/WAGON ALL MODELS		06.02-	AKE	Д199	24046/ 24047/ 24048	AKE	Д222 20645/ 24045
<b>626</b>							
ALL MODELS (GC)		11.82-05.87	AKE	Д387	21041		
16V ST. WAGON W/REAR DISC (GV)		01.88-03.92	AKE	Д450	21378		
1.6	(GD)	05.87-08.91	AKE	Д450	21378		
1.8	(GD)	05.87-08.91	AKE	Д450	21378		
1.8 W/REAR DISC	(GE)	09.91-10.97	SUM	Д594	21754	SUM	Д551 21766
1.8	(GF12/GF14)	04.97-	SUM	Д594	21754		
1.8 W/REAR DISC	(GD)	11.87-05.92	AKE	Д450	21378		

							
		i	DAFMI	W.V.A	i	DAFMI	W.V.A

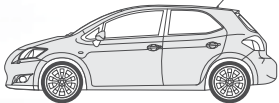
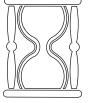

1.8 ESTATE/WAGON (GW1)	10.97-09.99					AKE	Д222	20645/ 24045
1.8 ESTATE/WAGON (GW19)	10.99-06.01					AKE	Д222	20645/ 24045
1.8 ESTATE/WAGON (GW19/GW69)	10.99-10.02					AKE	Д222	20645/ 24045
2.0 (GD)	05.87-08.91	AKE	Д450	21378				
2.0 D (GD)	05.87-08.91	AKE	Д450	21378				
2.0 D COMPREX W/REAR DISC (GE)	11.92-03.97	SUM	Д594	21754	SUM	Д551	21766	
2.0 ST. WAGON W/REAR DISC (GV)	10.88-10.90	AKE	Д450	21378				
2.0 W/REAR DISC (GE)	09.91-03.97	SUM	Д594	21754	SUM	Д551	21766	
2.0 (GF12/GF14)	04.94-03.97	SUM	Д594	21754				
2.0 (GF12/GF14)	04.97-07.99	SUM	Д594	21754		AKE	Д222	20645/ 24045
2.0 (GF12/GF14)	08.99-04.02					AKE	Д222	20645/ 24045
2.0 W/REAR DISC (GD)	06.87-05.92	AKE	Д450	21378				
2.0 D COMPREX ST. WAGON W/REAR DISC (GE)	01.92-03.97	SUM	Д594	21754	SUM	Д551	21766	
2.0 D W/REAR DISC (GD)	06.87-07.91	AKE	Д450	21378				
2.0 16V (GD)	11.87-05.92	AKE	Д450	21378				
2.0 ESTATE/WAGON (GW1)	10.97-09.99					AKE	Д222	20645/ 24045
2.0 ESTATE/WAGON (GW19)	10.99-06.01					AKE	Д222	20645/ 24045
2.0 ESTATE/WAGON (GW19/GW69)	10.99-10.02					AKE	Д222	20645/ 24045
2.0 DITD ESTATE/WAGON (GW1)	10.97-09.99					AKE	Д222	20645/ 24045
2.0 DITD ESTATE/WAGON (GW1/GW19)	10.99-10.02					AKE	Д222	20645/ 24045
2.2 12V ST WAGON (GV)	03.89-10.90	AKE	Д450	21378				
2.2 12V ST. WAGON W/REAR DISC (GV)	03.90-12.91	AKE	Д450	21378				
2.2 12V W/REAR DISC (GD)	11.87-07.91	AKE	Д450	21378				
2.2 ST. WAGON (GE)	09.91-01.92	SUM	Д594	21751				
2.2 ST. WAGON 4WD (GE)	09.91-01.92	SUM	Д594	21752				
2.2 4WD	09.91-01.92	SUM	Д594	21753	SUM	Д551	21766	
2.5 (GE14/GE64)	08.91-03.97	SUM	Д594	21754	SUM	Д551	21766	
<b><u>Atenza</u></b>								
2.0 (GG12)	04.02-	AKE	Д199	24046/ 24047/ 24048		AKE	Д222	20645/ 24045
<b><u>Demio</u></b>								
1.3 (DW19)	05.98-	SUM	Д774	21654				
<b><u>E (light commercial)</u></b>								
E 1800 (SDY021)	05.87-	AKE	Д628	20002				
E 1800 (SRY021)	05.87-	AKE	Д628	20002				
E 2000 (SDY021)	05.87-8.99	AKE	Д628	20002				
E 2000 (SRY021)	05.87-8.99	AKE	Д628	20002				
E 2200 (SDY021)	05.87-8.99	AKE	Д628	20002				
E 2200 (SRY021)	05.87-8.99	AKE	Д628	20002				
<b><u>Econovan (light commercial)</u></b>								
1.4 All (P327)	08.85-10.91	AKE	Д628	20002				
2.0 D All (P327)	08.85-10.91	AKE	Д628	20002				

							
		i	DAFMI	W.V.A	i	DAFMI	W.V.A

<b>Premacy</b>								
1.8 All	(CV19)	03.99-	SUM	Д594	21754			
2.0 All	(CV19)	03.99-	SUM	Д594	21754			
<b>XEDOS 6</b>								
1.6	(CA1)	01.92-04.94	SUM	Д594	21754			
1.6	(CA1)	04.94-	SUM	Д594	21754	SUM	Д551	21766
2.0	(CA1)	01.92-04.94	SUM	Д594	21754			
2.0	(CA1)	04.94-	SUM	Д594	21754	SUM	Д551	21766

### MERCEDES-BENZ

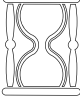
<b>Atego</b>								
ATEGO LIGHT		01.95-		Д609				
<b>(W116)</b>								
350		12.72-08.79	ATE	Д242	20392	ATE	Д602	20034
450		03.73-08.79	ATE	Д242	20392	ATE	Д602	20034
<b>(W123)</b>								
200		01.76-08.79	ATE	Д242	20392	ATE	Д602	20034
200		09.79-11.85	ATE	Д679	20341	ATE	Д602	20034
220		01.76-08.79	ATE	Д242	20392	ATE	Д602	20034
230		02.76-08.79	ATE	Д242	20392	ATE	Д602	20034
230		09.79-03.81	ATE	Д679	20341	ATE	Д602	20034
230 E		04.80-12.85	ATE	Д679	20341	ATE	Д602	20034
240		01.76-08.79	ATE	Д242	20392	ATE	Д602	20034
240		09.79-10.84	ATE	Д679	20341	ATE	Д602	20034
250		01.76-08.79	ATE	Д242	20392	ATE	Д602	20034
250		09.79-07.85	ATE	Д679	20341	ATE	Д602	20034
280		01.76-10.79	ATE	Д242	20392	ATE	Д602	20034
280		09.79-10.84	ATE	Д679	20341	ATE	Д602	20034
280 E		02.76-08.79	ATE	Д242	20392	ATE	Д602	20034
280 E		09.79-11.85	ATE	Д679	20341	ATE	Д602	20034
300		01.76-08.79	ATE	Д242	20392	ATE	Д602	20034
300		09.79-10.84	ATE	Д679	20341	ATE	Д602	20034
<b>(W123 C)</b>								
230 C		05.77-08.79	ATE	Д242	20392	ATE	Д602	20034
280 C		03.77-08.79	ATE	Д242	20392	ATE	Д602	20034
280 CE		03.77-08.79	ATE	Д242	20392	ATE	Д602	20034
<b>(W123 D)</b>								
200 D		03.76-08.79	ATE	Д679	20341	ATE	Д602	20034
240 D		01.76-08.79	ATE	Д679	20341	ATE	Д602	20034
240 TD		09.77-08.79	ATE	Д242	20392	ATE	Д602	20034
240 TD		03.79-12.85	ATE	Д679	20341	ATE	Д602	20034
300 D		02.76-08.79	ATE	Д679	20341	ATE	Д602	20034
300 TD		09.77-08.79	ATE	Д242	20392	ATE	Д602	20034
300 TD		02.76-11.85	ATE	Д679	20341	ATE	Д602	20034
<b>(W123 T)</b>								
200 T		11.80-11.85	ATE	Д679	20341	ATE	Д602	20034
230 T		09.77-08.79	ATE	Д242	20392	ATE	Д602	20034
230 TE		04.80-11.85	ATE	Д679	20341	ATE	Д602	20034
250 T		05.78-08.79	ATE	Д242	20392	ATE	Д602	20034
250 T		09.79-08.82	ATE	Д679	20341	ATE	Д602	20034
280 TE		09.77-08.79	ATE	Д242	20392	ATE	Д602	20034
280TE		09.79-08.82	ATE	Д679	20341	ATE	Д602	20034
<b>(W124)</b>								
200		12.85-05.90	LUC	Д742	21028	ATE	Д741	20687
200 E		09.88-06.93	LUC	Д742	21028	ATE	Д741	20687
E200		06.93-06.95	LUC	Д742	21028	ATE	Д741	20687

							
		i	DAFMI	W.V.A	i	DAFMI	W.V.A



200 E W/ASR	09.88-06.93	LUC	Д742	21028			
E200 W/ASR	06.93-06.95	LUC	Д742	21028			
200 W/ASR	12.85-05.90	LUC	Д742	21028			
220 E	12.84-06.93	LUC	Д742	21028	ATE	Д741	20687
E220	06.93-06.95	LUC	Д742	21028	ATE	Д741	20687
E220 W/ASR	06.93-06.95	LUC	Д742	21028			
230 E	12.84-06.93	LUC	Д742	21028	ATE	Д741	20687
230 E W/ASR	12.84-06.93	LUC	Д742	21028			
260	11.84-08.89	LUC	Д742	21028	ATE	Д741	20687
260 E	09.85-08.92	LUC	Д742	21028	ATE	Д741	20687
260 E W/ASR	09.85-08.92	LUC	Д742	21028			
280 E	10.92-06.93	LUC	Д742	21028	ATE	Д741	20687
E280	06.93-06.95	LUC	Д742	21028	ATE	Д741	20687
E280 W/ASR	06.93-06.95	LUC	Д742	21028			
300	11.84-08.89	LUC	Д742	21028	ATE	Д741	20687
300 E	01.85-06.93	LUC	Д742	21028	ATE	Д741	20687
E300	06.93-06.95	LUC	Д742	21028	ATE	Д741	20687
E300 W/ASR	06.93-06.95	LUC	Д742	21028			
<b>(W124 C)</b>							
E200 CABRIO	06.93- 95	LUC	Д742	21028	ATE	Д741	20687
E200 CABRIO W/ASR	06.93- 95	LUC	Д742	21028			
E200 COUPE	06.93- 95	LUC	Д742	21028	ATE	Д741	20687
E200 COUPE W/ASR	06.93- 95	LUC	Д742	21028			
E220 CABRIO	06.93- 95	LUC	Д742	21028	ATE	Д741	20687
E220 CABRIO W/ASR	06.93- 95	LUC	Д742	21028			
E220 COUPE	06.93-	LUC	Д742	21028	ATE	Д741	20687
E220 COUPE W/ASR	06.93-	LUC	Д742	21028			
230 CE	04.80-12.85	ATE	Д679	20341	ATE	Д602	20034
230 CE	03.87-05.93	LUC	Д742	21028	ATE	Д741	20687
230 CE W/ASR	03.87-05.93	LUC	Д742	21028			
280 CE	03.80-11.85	ATE	Д679	20341	ATE	Д602	20034
300 CD TURBO	09.81-07.85	ATE	Д679	20341	ATE	Д602	20034
300 CE	03.87-05.93	LUC	Д742	21028	ATE	Д741	20687
300 CE W/ASR	03.87-05.93	LUC	Д742	21028			
<b>(W124 D)</b>							
200 D	12.84-06.93	LUC	Д742	21028	ATE	Д741	20687
E200 D	06.93-06.95	LUC	Д742	21028	ATE	Д741	20687
200 D W/ASR	12.84-06.93	LUC	Д742	21028			
E200 D W/ASR	06.93-06.95	LUC	Д742	21028			
200 TD	09.85-08.91	LUC	Д742	21028			
250 D	04.85-06.93	LUC	Д742	21028	ATE	Д741	20687
E250 D	04.93-06.95	LUC	Д742	21028	ATE	Д741	20687
250 TD	09.88-06.93	LUC	Д742	21028	ATE	Д741	20687
250 TD W/ASR	09.88-06.93	LUC	Д742	21028			
250 D W/ASR	04.85-06.93	LUC	Д742	21028			
E250 D W/ASR	07.93-06.95	LUC	Д742	21028			
250 TD	09.85-06.93	LUC	Д742	21028			
E250 TD	06.93-06.95	LUC	Д742	21028	ATE	Д741	20687
E250 TD W/ASR	06.93-06.95	LUC	Д742	21028			
300 D	12.84-06.93	LUC	Д742	21028	ATE	Д741	20687
E300 D	07.93-06.95	LUC	Д742	21028	ATE	Д741	20687
E300 D W/ASR	07.93-06.95	LUC	Д742	21028			
300 TD	09.86-06.93	LUC	Д742	21028	ATE	Д741	20687
300 TD W/ASR	01.88-06.93	LUC	Д742	21028			
E300 TD	06.93-06.95	LUC	Д742	21028	ATE	Д741	20687

# Тормозные колодки для автомобилей иностранного производства

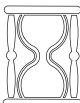

		i	DAFMI	W.V.A	i	DAFMI	W.V.A

E300 TD W/ASR	06.93-06.95	LUC	Д742	21028			
<b>(W124 T)</b>							
200 T	09.85-05.90	LUC	Д742	21028			
200 TE	09.88-06.93	LUC	Д742	21028			
230 TE	09.85-08.92	LUC	Д742	21028			
250 T	01.86-06.93	LUC	Д742	21028			
260 TE	09.85-08.92	LUC	Д742	21028			
300 TE	01.86-06.93	LUC	Д742	21028			
<b>(W126 1979-1985)</b>							
280	09.79-08.85	ATE	Д679	20341	ATE	Д602	20034
280 S	10.79-07.85	ATE	Д679	20341	ATE	Д602	20034
280 S W/ASR	10.79-07.85	ATE	Д679	20341			
280 SE	10.79-07.85	ATE	Д679	20341	ATE	Д602	20034
280 SE W/ASR	10.79-07.85	ATE	Д679	20341			
280 SEL	10.79-07.85	ATE	Д679	20341	ATE	Д602	20034
280 SEL W/ASR	10.79-07.85	ATE	Д679	20341			
300	09.79-08.85	ATE	Д679	20341	ATE	Д602	20034
380	09.79-08.85	ATE	Д679	20341	ATE	Д602	20034
380 SE W/ASR	12.79-07.85	ATE	Д679	20341			
380 SEL W/ASR	12.79-07.85	ATE	Д679	20341			
420	09.79-08.85	ATE	Д679	20341	ATE	Д602	20034
500	09.79-08.85	ATE	Д679	20341	ATE	Д602	20034
500 SE	12.79-07.85	ATE	Д679	20341			
500 SEL	12.79-07.85	ATE	Д679	20341			
500 SL	05.80-08.85				ATE	Д602	20034
<b>(W126 1985-1991)</b>							
260 SE	09.85-06.91	ATE	Д679	20341	ATE	Д602	20034
260 SE W/ASR	09.85-06.91	ATE	Д679	20341			
300 SE	09.85-06.91	ATE	Д679	20341	ATE	Д602	20034
300 SE W/ASR	09.85-06.91	ATE	Д679	20341			
300 SEL	09.85-06.91	ATE	Д679	20341	ATE	Д602	20034
300 SEL W/ASR	09.85-06.91	ATE	Д679	20341			
300 SL	09.85-08.89				ATE	Д602	20034
420 SE	10.85-06.91	ATE	Д679	20341			
420 SEC	10.85-06.91	ATE	Д679	20341	ATE	Д602	20034
420 SEC W/ASR	10.85-06.91	ATE	Д679	20341			
420 SEL	10.85-06.91	ATE	Д679	20341			
420 SL	01.86-08.89				ATE	Д602	20034
500 SE	08.85-06.91	ATE	Д679	20341			
500 SEC	08.85-06.91	ATE	Д679	20341	ATE	Д602	20034
500 SEC W/ASR	09.85-06.91	ATE	Д679	20341			
500 SEL	08.85-06.91	ATE	Д679	20341			
500 SL	09.85-08.89				ATE	Д602	20034
560	09.85-06.91	ATE	Д679	20341	ATE	Д602	20034
560 SE	10.85-06.91	ATE	Д679	20341			
560 SEC	10.85-06.91	ATE	Д679	20341	ATE	Д602	20034
560 SEC W/ASR	10.85-06.91	ATE	Д679	20341			
560 SEL	10.85-06.91	ATE	Д679	20341			
<b>(W201) 190</b>							
190 E 1.8	04.90-04.93	LUC	Д501	21055	ATE	Д213	20758
190 2.0	10.82-09.87	LUC	Д224	20749	ATE	Д213	20758
190 2.0	10.87-05.90	LUC	Д501	21055	ATE	Д213	20758
190 E 2.0	10.82-09.87	LUC	Д224	20749	ATE	Д213	20758
190 E 2.0	10.87-08.93	LUC	Д501	21055	ATE	Д213	20758
190 2.0 D	08.83-09.87	LUC	Д224	20749	ATE	Д213	20758



							
		i	DAFMI	W.V.A	i	DAFMI	W.V.A

190 2.0 D	10.87-05.92	LUC	Д501	21055	ATE	Д213	20758
190 2.0 E (ABS)	07.90-05.92	LUC	Д501	21055	ATE	Д213	20758
190 E 2.3	09.86-09.87	LUC	Д224	20749	ATE	Д213	20758
190 E 2.3	10.87-08.93	LUC	Д501	21055	ATE	Д213	20758
190 E 2.3 16V	04.84-09.87	LUC	Д224	20749	ATE	Д741	20687
190 E 2.3 16V	10.87-08.93	LUC	Д742	21028	ATE	Д741	20687
190 2.5 D	04.85-09.87	LUC	Д224	20749	ATE	Д213	20758
190 2.5 D	09.87-08.93	LUC	Д501	21055	ATE	Д213	20758
190 2.5 TD	02.88-05.92	LUC	Д501	21055	ATE	Д213	20758
190 2.5 E 16V	08.88-06.93				ATE	Д213	20758
190 2.5 E 16V EVO II	04.90-03.92				ATE	Д213	20758
190 2.6 E	09.87-05.92	LUC	Д501	21055	ATE	Д213	20758
<b>(W202)</b>							
C180	03.93-05.00	LUC	Д937	21439	ATE	Д741	20687
C180 W/ASR	03.93-05.00	LUC	Д937	21439			
C180 T	06.96-05.00	LUC	Д937	21439			
C200	01.94-05.00	LUC	Д937	21439	ATE	Д741	20687
C200 D	03.93-06.95	LUC	Д937	21439	ATE	Д741	20687
C200 TD	10.96-05.00	LUC	Д937	21439	ATE	Д741	20687
C200 TD W/ASR	10.96-05.00	LUC	Д937	21439			
C200 D W/ASR	03.93-06.95	LUC	Д937	21439			
C200 W/ASR	01.94-05.00	LUC	Д937	21439			
C200 T	06.96-05.00	LUC	Д937	21439			
C220	03.93-02.96	LUC	Д937	21439	ATE	Д741	20687
C220 D	08.93-05.98	LUC	Д937	21439	ATE	Д741	20687
C220 TD	06.96-05.98	LUC	Д937	21439	ATE	Д741	20687
C220 TD W/ASR	06.96-05.98	LUC	Д937	21439			
C220 D W/ASR	08.93-05.98	LUC	Д937	21439			
C220 W/ASR	03.93-02.96	LUC	Д937	21439			
C230	06.96-05.98	LUC	Д937	21439	ATE	Д741	20687
C230 W/ASR	06.96-05.00	LUC	Д937	21439			
C230 T	06.93-05.00	LUC	Д937	21439			
C230 T W/ASR	06.96-05.00	LUC	Д937	21439			
C250 D	05.93- 95	LUC	Д937	21439	ATE	Д741	20687
C250 D W/ASR	05.93- 95	LUC	Д937	21439			
C250 TD	06.96-05.00	LUC	Д937	21439	ATE	Д741	20687
C250 TD W/ASR	06.96-05.00	LUC	Д937	21439			
C250 TD	10.95-05.00	LUC	Д937	21439	ATE	Д741	20687
C250 TD W/ASR	10.95-05.00	LUC	Д937	21439			
C280	05.93-05.97	LUC	Д937	21439	ATE	Д741	20687
C280 W/ASR	06.97-05.00	LUC	Д937	21439			
<b>(W210)</b>							
E200	07.95-	ATE	Д155	21664			
E220	06.95-05.98	ATE	Д155	21664			
E220 D	07.95-	ATE	Д155	21664			
E230	06.95-10.97	ATE	Д155	21664			
E250	09.95-	ATE	Д155	21664			
E290 T	02.95-	ATE	Д155	21664			
E290 TD	07.95-	ATE	Д155	21664			
E300 D	07.95-01.96	ATE	Д155	21664			
E300 TD	12.96-	ATE	Д155	21664			
<b>(G Gelandewagen)</b>							
200 GE 2.0	02.79-05.93	PER	Д261	20784			
230 G 2.3	02.79-08.89	PER	Д261	20784			
230 GE 2.3	07.82-05.93	PER	Д261	20784			

# Тормозные колодки для автомобилей иностранного производства

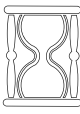

		i	DAFMI	W.V.A	i	DAFMI	W.V.A
240 GD 2.4	02.79-08.89	PER	Д261	20784			
250 GD 2.5	10.87-10.91	PER	Д261	20784			
280 GE 2.7	02.79-05.93	PER	Д261	20784			
290 GD 2.9	06.93-08.97	PER	Д261	20784			
		LUC	или Д585	21573			
300 GD 3.0	02.79-08.93	PER	Д261	20784			
		LUC	или Д585	21573			
300 GE	09.89-05.93	PER	Д261	20784			
		LUC	или Д585	21573			
<b><i>D (light commercial)</i></b>							
207 D	82-08.89	PER	Д261	20784			
208	10.82-04.95	PER	Д261	20784			
209 D	10.82-08.89	PER	Д261	20784			
210	10.82-04.95	PER	Д261	20784			
210 D	10.82-04.95	PER	Д261	20784			
307 D	10.82-08.89	PER	Д261	20784			
308	10.82-04.95	PER	Д261	20784			
308 D	10.82-04.95	PER	Д261	20784			
309 D	82-08.89	PER	Д261	20784			
310	82-04.95	PER	Д261	20784			
310 D	82-04.95	PER	Д261	20784			
407 D	82-07.89	PER	Д261	20784			
409 D	82-07.89	PER	Д261	20784			
410	82-10.84	PER	Д261	20784			
410 D	82-10.84	PER	Д261	20784			
507 D	86-07.89	PER	Д261	20784			
510	86-07.96	PER	Д261	20784			
608 D	86-07.96	PER	Д989	29835			
609 D	86-07.96	PER	Д989	29835			
709 D	86-07.96	PER	Д989	29835			
711 D	86-07.96	PER	Д989	29835			
809 D	86-07.96	PER	Д989	29835			
811 D	86-07.96	PER	Д989	29835			
814 D	08.89-	PER	Д989	29835			
815 D	04.98-	PER	Д989	29835			
<b><i>MB 80 (light commercial)</i></b>							
2.4 D	09.93-10.95	LUC	Д585	21573			
<b><i>MB 100 (light commercial)</i></b>							
MB 100 ALL MODELS	87-10.95	BDX	Д585	21573			
<b><i>MB 140 (light commercial)</i></b>							
2.4 D	04.88-10.95	LUC	Д585	21573			
<b><i>MB 160 (light commercial)</i></b>							
2.4	91-	BDX	Д585	21573			
<b><i>MB 180 (light commercial)</i></b>							
2.4 D	04.88-10.95	LUC	Д585	21573			
<b><i>Sprinter (light commercial)</i></b>							
208 D 2.3	12.94-05.98	ATE	Д145	21576	ATE	Д548	21278
208 D 2.5T	12.94-05.98	ATE	Д145	21576	ATE	Д548	21278
208 D 2.5T	05.98-	BOSCH	Д186	23022	BOSCH	Д167	23021
208 D 2.8T	02.95-	ATE	Д145	21576	ATE	Д147	21620
212 D 2.5T	02.95-05.98	ATE	Д145	21576	ATE	Д548	21278
212 D 2.5T	05.98-	BOSCH	Д186	23022	BOSCH	Д167	23021

							
		i	DAFMI	W.V.A	i	DAFMI	W.V.A

212 D 2.8T	02.95-	ATE	Д145	21576	ATE	Д147	21620
214 2.5T	02.95-05.98	ATE	Д145	21576	ATE	Д548	21278
214 2.5T	05.98-	BOSCH	Д186	23022	BOSCH	Д167	23021
214 2.8T	02.95-	ATE	Д145	21576	ATE	Д147	21620
308 D	12.94-	ATE	Д145	21576	ATE	Д148	21592
308 D	05.98-				BOSCH	Д167	23021
312 D	02.95-	ATE	Д145	21576	ATE	Д148	21592
312 D	05.98-				BOSCH	Д167	23021
314	02.95-	ATE	Д145	21576	ATE	Д148	21592
314	05.98-				BOSCH	Д167	23021
408 D	95-	PER	Д146	29076	PER	Д146	29076
410 D	95-	PER	Д146	29076	PER	Д146	29076
412 D	95-	PER	Д146	29076	PER	Д146	29076
414 D	95-	PER	Д146	29076	PER	Д146	29076
<b><i>Vito (light commercial)</i></b>							
2.0	03.96-12.97	ATE	Д145	21576	ATE	Д548	21278
2.0	01.98-	BOSCH	Д186	23022	BOSCH	Д187	23020
2.3 D/TD	03.96-12.97	ATE	Д145	21576	ATE	Д548	21278
2.3 D/TD	01.98-	BOSCH	Д186	23022	BOSCH	Д187	23020

## MITSUBISHI



<b><i>Carisma</i></b>							
1.6	03.95-06.99	LUC	Д180	23080			
1.6	06.99-	LUC	Д180	23080			
1.8	03.95-	LUC	Д169	21920			
1.9	03.95-	LUC	Д169	21920			
<b><i>Colt</i></b>							
1.1 (Z3_A)	04-		Д507	21796			
1.2 (A151/155)	80-06.85	SUM	Д646	20703			
1.3 (C51A)	06.88-09.90	SUM	Д396	20955			
1.3 (C51)	09.90-12.93	SUM	Д601	21650			
1.3 (Z3_A)	04-		Д507	21796			
1.4 (A152/153/156/157)	80-06.84	SUM	Д646	20703			
1.4 (A152A)	09.81-01.84	SUM	Д396	20955			
1.5 (C52)	09.90-12.93	SUM	Д601	21650			
1.5 (Z3_A)	04-		Д507	21796			
1.5 DI-D (Z3_A)	04-		Д507	21796			
1.6 (A152/153/156/157)	80-06.84	SUM	Д646	20703			
1.6 (C54/C13A)	06.84-04.90	SUM	Д396	20955	AKE	Д401	21125
1.6 (CA4A)	04.92-02.96	SUM	Д601	21650			
1.8 (C14A)	06.84-07.88	SUM	Д396	20955			
1.8 (C53)	08.88-03.90	SUM	Д396	20955			
1.8 (C58)	04.90-01.92	SUM	Д791	21647	AKE	Д401	21125
1.8 (CA5A)	04.92-	SUM	Д791	21647			
1.8 D	04.88-05.90	SUM	Д396	20955			
1.8 D	06.90-	SUM	Д601	21650			
<b><i>Cordia/Tredia</i></b>							
1600 GLS TURBO (A212A)	09.82-08.84	SUM	Д791	21647			
1800 (A213A)	09.84-12.86	SUM	Д396	20955			
1800 4WD (A215G)	03.85-12.86	SUM	Д396	20955			
1800 4WD (A217G)	03.85-12.86	SUM	Д396	20955			
<b><i>Eclipse</i></b>							
2.0 I 16V (D22A)	04.91-02.94	SUM	Д791	21647			
2000 GS 16V	12.95-						
2.0 TURBO 4x4 (D22A/D27A)	12.89-04.99	AKE	Д780	21363	AKE	Д401	21125



# Тормозные колодки для автомобилей иностранного производства

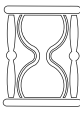

			i	DAFMI	W.V.A	i	DAFMI	W.V.A
2.0 O/TURBO	(D22A/D27A)	12.89-04.99	SUM	Д791	21647	AKE	Д188	21706/ 21707/ 21708
2.0 FWD	(D22A)	12.89-03.94	SUM	Д791	21647	AKE	Д401	21125
2.0 FWD W/ABS	(D22A)	12.89-03.94	SUM	Д791	21647	AKE	Д401	21125
2.4	(D35A)	05.96-04.99	SUM	Д791	21647	AKE	Д188	21706/ 21707/ 21708
<b><u>Galant</u></b>								
1600		01.74-12.77	SUM	Д646	20703			
2000		01.74-12.77	SUM	Д646	20703			
1.8 W/ABS	(E52A)	11.92-09.96	SUM	Д791	21647	AKE	Д188	21706/ 21707/ 21708
2.0	(E54A/E55A/E64A)	11.92-09.96	SUM	Д791	21647	AKE	Д188	21706/ 21707/ 21708
2.0 4x4	(E75A)	11.92-09.96	SUM	Д791	21647	AKE	Д188	21706/ 21707/ 21708
2.0 TDiC W/ABS	(E57A)	11.92-09.96	SUM	Д791	21647	AKE	Д188	21706/ 21707/ 21708
2.0	(EA2A)	04.00-10.03	AKE	Д192	23584	AKE	Д188	21706/ 21707/ 21708
2.4 GDi	(EA3A)	04.00-10.03	AKE	Д192	23584	AKE	Д188	21706/ 21707/ 21708
2.5	(EA5A)	04.00-10.03	AKE	Д192	23584	AKE	Д188	21706/ 21707/ 21708
<b><u>Galant Estate/Wagon</u></b>								
2.0	(EA2W)	04.00-10.03	AKE	Д192	23584	AKE	Д188	21706/ 21707/ 21708
2.4	(EA3W)	03.99-03.00	AKE	Д780	21363	AKE	Д188	21706/ 21707/ 21708
2.4 GDi	(EA3W)	04.00-10.03	AKE	Д192	23584	AKE	Д188	21706/ 21707/ 21708
2.5	(EA5W)	04.00-10.03	AKE	Д192	23584	AKE	Д188	21706/ 21707/ 21708
<b><u>Galant (A)</u></b>								
1600 GL	(A121)	01.78-03.81	SUM	Д646	20703			
1600 GLS	(A121)	01.78-03.81	SUM	Д646	20703			
2000 GL	(A123)	01.78-03.81	SUM	Д646	20703			
2000 GLS	(A123)	01.78-03.81	SUM	Д646	20703			
<b><u>Galant (E10)</u></b>								
1600 GLX	(E11A)	85- 88	SUM	Д396	20955			
1800 GLX	(E14A)	85- 88	SUM	Д396	20955			
2000 GLS	(E15A)	85- 88	SUM	Д396	20955			
2000 GLX	(E15A)	85- 88	SUM	Д396	20955			

							
		i	DAFMI	W.V.A	i	DAFMI	W.V.A



<b><u>Galant (E30)</u></b>							
1.8 (E32)	88-05.90	SUM	Д396	20955			
1.8 (E32A)	06.90-10.92	SUM	Д791	21647			
1.8 TD (E34A)	88-05.90	SUM	Д396	20955			
1.8 TD (E34A)	06.90-10.92	SUM	Д791	21647			
2.0 GLSI (E33A)	88-05.90	SUM	Д396	20955	AKE	Д401	21125
2.0 GLSI (E33A)	06.90-10.92	SUM	Д791	21647	AKE	Д401	21125
2.0 GTI 16V (E33A)	88-05.90	SUM	Д396	20955	AKE	Д401	21125
2.0 GTI 16V (E33A)	06.90-10.92	SUM	Д791	21647	AKE	Д401	21125
2.0 GTI 16V TURBO (E39A)	88-05.90	SUM	Д396	20955	AKE	Д401	21125
2.0 GTI 16V TURBO (E39A)	06.90-10.92	SUM	Д791	21647	AKE	Д401	21125
<b><u>Galant (E50/E60/E70/E80)</u></b>							
1.8 GLI (E88A)	11.92-11.96	SUM	Д791	21647	AKE	Д188	21706
1.8 GLSI (E88A)	11.92-11.96	SUM	Д791	21647	AKE	Д188	21706
2.0 GLI (E64A)	11.91-11.96	SUM	Д791	21647	AKE	Д188	21706
2.0 GLI (E75A)	11.91-11.96	SUM	Д791	21647	AKE	Д188	21706
2.0 GLI (E55A)	11.91-11.96	SUM	Д791	21647	AKE	Д188	21706
2.0 GLS (E88A)	12.96-09.96	SUM	Д791	21647	AKE	Д188	21706
2.0 GLSI (E55A)	11.91-11.96	SUM	Д791	21647	AKE	Д188	21706
2.0 GLSI (E64A)	11.91-11.96	SUM	Д791	21647	AKE	Д188	21706
2.0 GLSI (E75A)	11.91-11.96	SUM	Д791	21647	AKE	Д188	21706
2.0 GLX (E88A)	12.96-09.96	SUM	Д791	21647	AKE	Д188	21706
2.0 ST. WAGON (E57A)	12.96-09.96	SUM	Д791	21647	AKE	Д188	21706
2.0 TD GL (E57)	11.92-11.96	SUM	Д791	21647	AKE	Д188	21706
2.0 TD GLS (E57A)	11.92-11.96	SUM	Д791	21647	AKE	Д188	21706
2.5 (E88A)	11.92-11.96	SUM	Д780	21363	AKE	Д188	21706
2.5 V6 (E88A)	12.96-09.96	SUM	Д791	21647	AKE	Д188	21706
<b><u>Lancer</u></b>							
1200	75-12.78	SUM	Д646	20703			
1400	75-12.78	SUM	Д646	20703			
<b><u>Lancer (A)</u></b>							
1600 (A73)	78-12.79	SUM	Д646	20703			
F 1250 (A155)	83-01.84	SUM	Д646	20703			
F 1400 (A156)	83-01.84	SUM	Д646	20703			
<b><u>Lancer (C/CB/CAO/CS)</u></b>							
1.3 (CB1A)	06.92-02.96	AKE	Д601	21650			
1.3 12V (C61A)	06.92-05.94	AKE	Д601	21650			
1.5 12V (C62A)	05.89-05.92	AKE	Д601	21650			
1.6 12V (CB4A)	06.92-02.96	AKE	Д601	21650			
1.6 4X4 ST.WAGON (CAOW)	12.92-08.97	AKE	Д601	21650			
1.6 GLI (C66A)	06.92-05.94	AKE	Д601	21650			
1.6 ST. WAGON (CAOW)	12.92-08.97	AKE	Д601	21650			
1.6 TURBO (C13A)	84-04.88	SUM	Д396	20955			
1.8 D (C14A)	84-04.88	SUM	Д396	20955			
1.8 D (C64A)	04.88-05.92	AKE	Д601	21650			
1.8 GLXI 4X4 (C77A)	09.89-06.92	AKE	Д601	21650			
1.8 GTI 16V (C68A)	04.88-07.93				AKE	Д401	21125
1.8 GTI 16V (C68A)	11.89-05.92	SUM	Д791	21647	AKE	Д401	21125
1.8 GTI 16V (C69A)	06.92-12.93	SUM	Д791	21647	AKE	Д401	21125
2.0 D (CB8A)	06.92-02.96	AKE	Д601	21650			
<b><u>Lancer (CS_A)</u></b>							
1.3							
1.6	09.03-	AKE	Д192	23584	AKE	Д344	24014/24015
2.0							
2.0 16V EVO IX							

# Тормозные колодки для автомобилей иностранного производства

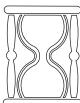

		i	DAFMI	W.V.A	i	DAFMI	W.V.A

<b>Lancer (CS_W)</b>							
1.6	09.03-	AKE	Д192	23584	AKE	Д344	24014/24015
2.0	09.03-	AKE	Д192	23584			
<b>Outlander</b>							
2.0							
2.0 4WD	05.03-05.08	AKE	Д780	21363	AKE	Д344	24014/24015
2.4 4WD							
2.0 Turbo 4WD							
<b>Pajero</b>							
2.4	03.91-08.94	AKE	Д780	21363	AKE	Д821	21840
2.5	03.91-10.97	AKE	Д780	21363	AKE	Д821	21840
2.8	06.94-08.99	AKE	Д780	21363	AKE	Д821	21840
3.0	03.91-08.99	AKE	Д780	21363	AKE	Д821	21840
3.5	11.93-08.99	AKE	Д780	21363	AKE	Д821	21840
<b>Pajero Pinin</b>							
1.8	05.99-				AKE	Д188	21706/ 21707/ 21708
1.8 GDI	05.99-				AKE	Д188	21706/ 21707/ 21708
2.0 GDI	05.99-				AKE	Д188	21706/ 21707/ 21708
<b>RVR</b>							
1.8 (N21W)	06.91-09.99				AKE	Д188	21706/ 21707/ 21708
2.0 TD (N18W)	06.93-09.99				AKE	Д188	21706/ 21707/ 21708
<b>Sapporo</b>							
2.4 (E16A)	02.87-12.90				AKE	Д188	21706/ 21707/ 21708
<b>Shogun</b>							
2.5 TD	04.91-	AKE	Д780	21363	AKE	Д821	21840
2.8	04.91-	AKE	Д780	21363	AKE	Д821	21840
2.8 TD	03.94-	AKE	Д780	21363	AKE	Д821	21840
3.0	04.91-	AKE	Д780	21363	AKE	Д821	21840
3.5	04.94-	AKE	Д780	21363			
<b>Shogun Pinin</b>							
SHOGUN PININ ALL MODELS	05.99-				AKE	Д188	21706/ 21707/ 21708
<b>Sigma</b>							
1600	01.76-12.77	SUM	Д646	20703			
2000	01.76-12.77	SUM	Д646	20703			
3.0 (F16A)	05.90-07.96	AKE	Д780	21363			
<b>Space gear</b>							
2.0	12.94-	AKE	Д780 или Д791	21363	AKE	Д821	21840
		SUM	Д791	21647			
2.4 GLX	12.94-	AKE	Д780 или Д791	21363	AKE	Д821	21840
		SUM	Д791	21647			

							
		i	DAFMI	W.V.A	i	DAFMI	W.V.A



2.5 D 4x4	12.94-	AKE SUM	Д780 или Д791	21363 21647	AKE	Д821	21840
<b><u>Space runner</u></b>							
SPACE RUNNER ALL MODELS	10.91-09.99	SUM	Д791	21647	AKE	Д188	21706/ 21707/ 21708
SPACE RUNNER ALL MODELS	05.00-04.03	AKE	Д192	23584	AKE	Д188	21706/ 21707/ 21708
<b><u>Space wagon</u></b>							
SPACE WAGON ALL MODELS	84-09.91	SUM	Д396	20955			
SPACE WAGON ALL MODELS	10.91-11.98	SUM	Д791	21647	AKE	Д188	21706/ 21707/ 21708
<b><u>Tredia</u></b>							
1.6 TURBO	83-06.86	SUM	Д396	20955			
1.8 TURBO	84-06.86	SUM	Д396	20955			
1.8 4WD	85-06.88	SUM	Д396	20955			
2.0 4WD GLS	85-09.88	SUM	Д396	20955			
<b><u>L (light commercial)</u></b>							
L 200 (K12T)	87-05.92	SUM	Д123	21375			
L 200 (K14T)	87-08.96	SUM	Д123	21375			
L 200 (K22T)	87-05.94	SUM	Д123	21375			
L 300 (P02W)	87-05.94	SUM	Д123	21375			
L 300 (P02V)	87-05.94	SUM	Д123	21375			
L 300 (P03V)	87-05.94	SUM	Д123	21375			
L 300 (P05V)	87-08.96	SUM	Д123	21375			
L 300 (P12V)	87-08.96	SUM	Д123	21375			
L 300 (P13V)	87-08.96	SUM	Д123	21375			
L 300 (P15V)	87-08.96	SUM	Д123	21375			
L 300 4WD (P23W)	87-08.96	SUM	Д123	21375			
L 300 4WD (P24W)	87-08.96	SUM	Д123	21375			



## NISSAN

<b><u>100</u></b>							
100 NX 1.8 (B13)	10.90- 95	SUM	Д840	21657			
<b><u>300</u></b>							
300 ZX	01.85-02.87	AKE	Д415	21099			
<b><u>Almera</u></b>							
ALMERO TINO ALL MODELS	04.00-05.03	LUC	Д200	23094/ 23095	LUC	Д163	21545
CLASSIC ALL MODELS	06-		Д647				
1.4 i 16V	07.95-12.97	SUM	Д181	23004			
1.4 i 16V (No ABS)	01.98-12.99	SUM	Д181	23004			
1.5 i 16V (No ABS)	01.00-	LUC	Д619	21546			
1.5 (N16E)	01.00-	LUC	Д197	23093/ 23463	LUC	Д163	21545
1.5 W/ABS (N16E)	04.01-11.02	LUC	Д197	23093/ 23463			
1.5 DCI W/ABS (N16E)	06.03-	LUC	Д197	23093/ 23463	LUC	Д163	21545
1.6 i 16V (No ABS)	01.98-12.99	SUM	Д181	23004			
1.6 i 16V (W/ABS)	07.95-07.97	SUM	Д181	23004			
1.8 i 16V (No ABS)	01.00-	LUC	Д619	21546			

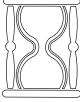
# Тормозные колодки для автомобилей иностранного производства

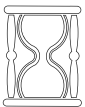

							
		i	DAFMI	W.V.A	i	DAFMI	W.V.A
1.8 i 16V (W/ABS)	07.95-07.97	SUM	Д181	23004			
1.8 (N16E)	01.00-	LUC	Д197	23093/ 23463	LUC	Д163	21545
1.8 W/ABS (N16E)	04.01-11.02	LUC	Д197	23093/ 23463			
2.0 D O/ABS	01.98-12.99	SUM	Д181	23004			
2.2 DiTD O/ABS	01.00-	LUC	Д619	21546			
2.2 DCI/DITD (N16E)	01.00-	LUC	Д197	23093/ 23463	LUC	Д163	21545
2.2 DITD (N16E)	04.01-04.03	LUC	Д197	23093/ 23463			
<b>Bluebird</b>							
BLUEBIRD ALL MODELS (910)	01.80-12.83	AKE	Д331	20718			
BLUEBIRD ALL MODELS (U 11)	01.84-12.90	AKE	Д415	21099			
BLUEBIRD ALL MODELS (T 12)	01.86-12.90	AKE	Д415	21099			
<b>Cherry (N 12)</b>							
1.0 DX	10.82-10.84	SUM	Д321	20958			
1.3 GL	10.82-06.86	SUM	Д321	20958			
1.5 GL	09.83-06.86	SUM	Д321	20958			
1.5 TURBO	83-08.86	AKE	Д331	20718			
1.7 D GL	10.82-09.86	AKE	Д331	20718			
<b>Laurel (C 31/C 32)</b>							
2.0 DX	05.81-09.83	AKE	Д331	20718			
2.4 E SGL	05.85-09.89	AKE	Д331	20718			
2.4 SGL	05.81-09.83	AKE	Д331	20718			
2.4 SGL	10.83-12.85	AKE	Д415	21099			
2.8 D	05.81- 89	AKE	Д331	20718			
2.8 SGL	05.81-12.85	AKE	Д415	21099			
<b>Maxima</b>							
MAXIMA 3.0 V6 (J30)	01.89-10.91	SUM	Д497	21561			
MAXIMA QX 2.0 (A32)	10.94-	SUM	Д497	21561			
MAXIMA QX 3.0 (A32)	10.94-	SUM	Д165	23086	SUM	Д162	21713
<b>Micra</b>							
1.0 (K12E)	01.03-05.05	LUC	Д204	23973			
1.2 (K12E)	01.03-	LUC	Д204	23973			
1.4 (K12E)	01.03-	LUC	Д204	23973			
1.5 DCI (K12E)	01.03-	LUC	Д204	23973			
<b>Micra CC</b>							
MICRA CC ALL MODELS	06.05-	LUC	Д204	23973			
<b>Pathfinder</b>							
3.0	02.88-12.90	SUM	Д159	21347			
<b>Prairie</b>							
1.5 (M 10)	09.82-02.89	AKE	Д331	20718			
1.8 SGL (M 10)	09.82-02.89	AKE	Д331	20718			
2.0 (M 11)	01.89- 96	AKE	Д487	21725			
2.0 4WD (M 10)	06.87- 89	AKE	Д331	20718			
2.4 (M 11)	01.89- 96	AKE	Д487	21725			
<b>Primastar (X83)</b>							
dCi 80 F9Q 762	09.02-	LUC	Д149	21797			
dCi 90	09.02-	LUC	Д149	21797			
dCi 100 F9Q 760	09.02-	LUC	Д149	21797			
dCi 120	09.02-	LUC	Д149	21797			
dCi 140 G9U 730	09.02-	LUC	Д149	21797			
dCi 150	09.02-	LUC	Д149	21797			
<b>Primera</b>							
1.6 I SLX (P10)	05.93-09.96	LUC	Д618	21280			
1.6 I SLX W/ABS (P10)	05.93-09.96	LUC	Д619	21546	LUC	Д163	21545
1.6 L (P10)	05.90-09.96	LUC	Д618	21280			
1.6 L W/ABS (P10)	05.93-09.96	LUC	Д619	21546	LUC	Д163	21545
1.6 LS (P10)	05.90-09.96	LUC	Д618	21280			
1.6 LX (P10)	05.90-09.96	LUC	Д618	21280			
1.6 LX W/ABS (P10)	05.90-09.96	LUC	Д619	21546	LUC	Д163	21545

							
		i	DAFMI	W.V.A	i	DAFMI	W.V.A



1.6 SLX (P10)	05.90-09.96	LUC	Д618	21280				
1.6 SLX W/ABS (P10)	05.90-09.96	LUC	Д619	21546	LUC	Д163	21545	
1.6 ST. WAGON (W10)	06.90-01.98	AKE	Д487	21725	LUC	Д163	21545	
1.6 (P11E)	04.98-12.01	LUC	Д197	23093/ 23463	LUC	Д163	21545	
1.6 ESTATE/WAGON (WP11E)	02.98-12.01	LUC	Д197	23093/ 23463	LUC	Д163	21545	
1.6 (P12E)	01.02-	LUC	Д200	23094/ 23095	ATE	Д966	23482/ 23483	
1.6 ESTATE/WAGON (P12E)	01.02-	LUC	Д200	23094/ 23095	ATE	Д966	23482/ 23483	
1.8 WABS (P11E)	06.99-12.01	LUC	Д197	23093/ 23463	LUC	Д163	21545	
1.8 ESTATE/WAGON (WP11E)	06.99-12.01	LUC	Д197	23093/ 23463	LUC	Д163	21545	
1.8 (P12E)	01.02-	LUC	Д200	23094/ 23095	ATE	Д966	23482/ 23483	
1.8 ESTATE/WAGON (P12E)	01.02-	LUC	Д200	23094/ 23095	ATE	Д966	23482/ 23483	
1.9 (P12E)	05.03-	LUC	Д200	23094/ 23095	ATE	Д966	23482/ 23483	
1.9 ESTATE/WAGON (P12E)	05.03-	LUC	Д200	23094/ 23095	ATE	Д966	23482/ 23483	
2.0 D (P10)	06.90-09.96	LUC	Д619	21546	LUC	Д163	21545	
2.0 D (P10)	12.90-09.96	LUC	Д618	21280				
2.0 D ST. WAGON (W10)	90- 98	AKE	Д487	21725				
2.0 D ST. WAGON (W10)	05.93-01.98	AKE	Д487	21725	SUM	Д162	21713	
2.0 D ST. WAGON (W10)	02.98-05.99	LUC	Д619	21546	LUC	Д163	21545	
2.0 I GS (P10)	06.90-09.96	LUC	Д619	21546	LUC	Д163	21545	
2.0 I GT (P10)	06.90-09.96	LUC	Д619	21546	LUC	Д163	21545	
2.0 I LS (P10)	06.90-09.96	LUC	Д619	21546	LUC	Д163	21545	
2.0 I LX (P10)	06.90-09.96	LUC	Д619	21546	LUC	Д163	21545	
2.0 I SGX (P10)	06.90-09.96	LUC	Д619	21546	LUC	Д163	21545	
2.0 I SLX (P10)	06.90-09.96	LUC	Д619	21546	LUC	Д163	21545	
2.0 ST. WAGON (W10)	06.90-01.98	AKE	Д487	21725	LUC	Д163	21545	
2.0 (P11E)	04.98-05.99	LUC	Д197	23093/ 23463	LUC	Д163	21545	
2.0 AUTO (P11E)	06.99-12.01	LUC	Д197	23093/ 23463	LUC	Д163	21545	
2.0 TD W/ABS (P11E)	04.98-05.99	LUC	Д197	23093/ 23463	LUC	Д163	21545	
2.0 TD (P11E)	06.99-12.01	LUC	Д197	23093/ 23463	LUC	Д163	21545	
2.0 ESTATE/WAGON AUTO (WP11E)	02.98-12.01	LUC	Д197	23093/ 23463	LUC	Д163	21545	
2.0 (P12E)	01.02-	LUC	Д200	23094/ 23095	ATE	Д966	23482/ 23483	
2.0 ESTATE/WAGON (P12E)	01.02-	LUC	Д200	23094/ 23095	ATE	Д966	23482/ 23483	
2.2 DCT (P12E)	03.02-04.03	LUC	Д200	23094/ 23095	ATE	Д966	23482/ 23483	
2.2 DCi (P12E)	05.03-	LUC	Д200	23094/ 23095	ATE	Д966	23482/ 23483	
2.2 DCT ESTATE/WAGON (P12E)	03.02-04.03	LUC	Д200	23094/ 23095	ATE	Д966	23482/ 23483	

# Тормозные колодки для автомобилей иностранного производства

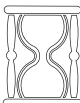

		i	DAFMI	W.V.A	i	DAFMI	W.V.A

2.2 DCi ESTATE/WAGON (P12E)	05.03-	LUC	Д200	23094/ 23095	ATE	Д966	23482/ 23483
<b><u>Silvia</u></b>							
1.8 (RS12)	10.83-09.88	AKE	Д415	21099			
2.0 (RS12)	10.83-09.88	AKE	Д415	21099			
<b><u>Stanza</u></b>							
STANZA ALL MODELS (T11)	11.81-09.85	AKE	Д331	20718			
<b><u>Sunny (B11)</u></b>							
1.5 GL	03.82-06.86	SUM	Д321	20958			
1.6 TOURING	03.82-06.86	SUM	Д321	20958			
<b><u>Sunny (B12)</u></b>							
1.0	03.86-09.90	SUM	Д321	20958			
1.3	03.86-09.90	SUM	Д321	20958			
1.4	03.86-09.90	SUM	Д321	20958			
1.6 SGX	03.86-09.90	SUM	Д321	20958			
1.6 SLX	01.89-09.90	SUM	Д321	20958			
1.8 I	06.86-09.90	AKE	Д436	21344			
<b><u>Sunny (N13)</u></b>							
1.3 LX	03.86-09.90	SUM	Д321	20958			
1.4 LX	03.86-09.90	SUM	Д321	20958			
1.6 GTI 16V	87-10.91	AKE	Д436	21344			
1.6 I SLX 4WD	87-09.90	AKE	Д436	21344			
1.6 LX	09.89-09.90	AKE	Д436	21344			
1.6 SLX	03.86-09.90	SUM	Д321	20958			
1.7 D LX	03.86-10.91	AKE	Д436	21344			
1.7 D SLX	03.86-10.91	AKE	Д436	21344			
<b><u>Sunny (N14)</u></b>							
1.4 LX	09.90- 95	SUM	Д840	21657			
1.6 SLX	09.90- 95	SUM	Д840	21657			
1.6 SLX COUPE	09.90- 93	AKE	Д436	21344			
2.0 D LX	09.90- 95	SUM	Д840	21657			
2.0 GTI R	91- 92	SUM	Д840	21657			
<b><u>Terrano</u></b>							
TERRANO ALL MODELS (D21)	08.87-02.93	SUM	Д159	21347			
TERRANO II 2.4 (R20)	02.93-	LUC	Д138 или Д159	21410 21347			
TERRANO II 2.7 TD (R20)	02.93-	LUC	Д138 или Д159	21410 21347			
<b><u>Trade</u></b>							
2.0	11.85-04.97	AKE	Д415	21099			
2.8	11.85-03.93	AKE	Д415	21099			
<b><u>Cabstar (light commercial)</u></b>							
2.0	82- 90	AKE	Д415	21099			
2.3 D	87- 90	AKE	Д415	21099			
2.5 D	82- 87	AKE	Д415	21099			
<b><u>King cab (D 21) (light commercial)</u></b>							
2.0	09.85-09.87	AKE	Д415	21099			
2.3	09.85-09.87	AKE	Д415	21099			
2.4	09.85-09.88	AKE	Д415	21099			
2.4	05.92-	SUM	Д159	21347			
2.5	09.85-09.87	AKE	Д415	21099			
2.5 TD	05.92-	SUM	Д159	21347			

							
		i	DAFMI	W.V.A	i	DAFMI	W.V.A

<b><u>Pick-up (light commercial)</u></b>							
PICK-UP (720) ALL MODELS	02.83-09.86	AKE	Д415	21099			
PICK-UP 2WD (D21) ALL MODELS	09.85-	AKE	Д415	21099			
PICK-UP 4WD (D21) ALL MODELS	09.85-10.88	AKE	Д415	21099			
<b><u>Serena (C 23) (light commercial)</u></b>							
SERENA ALL MODELS	07.92-	LUC	Д138	21410			
<b><u>Urvan (light commercial)</u></b>							
URVAN ALL MODELS (E23)	02.85-02.87	AKE	Д331	20718			
URVAN ALL MODELS (E24)	02.87-10.96	SUM	Д159	21347			
<b><u>Vanette (C120) (light commercial)</u></b>							
1.5	81-08.85	AKE	Д331	20718			
1.5	09.85- 87	AKE	Д415	21099			
2.0 D	11.84-12.85	AKE	Д331	20718			
2.0 D	01.86- 87	AKE	Д415	21099			
<b><u>Vanette (C220/C22) (light commercial)</u></b>							
1.5	87-08.94	AKE	Д415	21099			
2.0	87- 88	SUM	Д159	21347			
2.0 D	87- 90	AKE	Д415	21099			
2.0 D	90-08.94	SUM	Д159	21347			
2.4 I	87- 90	AKE	Д415	21099			
2.4 I	90-08.94	SUM	Д159	21347			
<b><u>Vanette Cargo (light commercial)</u></b>							
1.6	91-	AKE	Д415	21099			
		AKE	Д415	21099			
2.3 D	95-	SUM	или Д138	21410			

## OPEL

<b><u>Ascona B</u></b>							
1.2	07.74-08.78	ATE	Д276	20588			
1.2	09.78-07.81	GM	Д269	20939			
1.3N	07.74-07.81	ATE	Д276	20588			
1.3S	08.74-07.81	GM	Д269	20939			
		ATE	Д276	20588			
1.3S	08.74-07.81	GM	или Д269	20939			
		ATE	Д276	20588			
1.6N	08.74-07.81	GM	или Д269	20939			
		ATE	Д276	20588			
1.6S	08.74-07.81	GM	или Д269	20939			
		ATE	Д276	20588			
1.9	08.74-07.81	GM	или Д269	20939			
		ATE	Д276	20588			
2.0	08.74-07.81	GM	или Д269	20939			
<b><u>Ascona C</u></b>							
ASCONA C ALL MODELS	08.81-08.88	GM	Д269	20939	GM	ДА269	
<b><u>Astra (F)</u></b>							
1.4	06.91-01.98	ATE	Д700	20547	ATE	ДА700	
1.4 VAN	06.91-08.95	ATE	Д700	20547	ATE	ДА700	
1.6	06.91-01.98	ATE	Д700	20547	ATE	ДА700	
1.6 VAN	06.91-08.98	ATE	Д700	20547	ATE	ДА700	
1.6 16V	02.93-01.98	ATE	Д433	21190			





# Тормозные колодки для автомобилей иностранного производства



		i	DAFMI	W.V.A	i	DAFMI	W.V.A

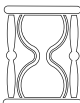

1.7 D	09.91-08.94	ATE	Д700	20547	ATE	ДА700	
1.7 TD	94-01.98	ATE	Д700	20547	ATE	ДА700	
1.7 TD VAN	94-08.98	ATE	Д700	20547	ATE	ДА700	
1.8	09.91-01.98	ATE	Д700	20547	ATE	ДА700	
1.8 GSI	09.91-08.94	ATE	Д433	21190	ATE	Д459	21140
1.8 I CD	04.93-08.94	ATE	Д433	21190			
1.8 VAN	06.91-08.94	ATE	Д700	20547	ATE	ДА700	
1.8 16V	09.91-01.98	ATE	Д433	21190	ATE	Д459	21140
1.8 16V VAN	93-08.94	ATE	Д433	21190			
2.0 CC GSI	09.91-01.98	ATE	Д433	21190			
2.0 GSI	03.92-01.98	ATE	Д433	21190	ATE	Д459	21140
2.0 16V	05.93-01.98	ATE	Д433	21190	ATE	Д459	21140
<b><u>Astra (G)</u></b>							
1.2	02.98-	ATE	Д184	23063	ATE BSC	ДА184 или -	
1.4	02.98-	ATE	Д184	23063	ATE BSC	ДА184 или -	
1.6	02.98-	ATE	Д184	23063	ATE BSC	ДА184 или -	
1.7	02.98-	ATE	Д184	23063	ATE BSC	ДА184 или -	
1.8 W/O ABS	02.98-	ATE	Д184	23063	ATE BSC	ДА184 или -	
2.0 Di W/O ABS	02.98-	ATE	Д184	23063	ATE BSC	ДА184 или -	
<b><u>Calibra</u></b>							
2.0 I	06.90-08.96	ATE	Д433	21190	ATE	Д459	21140
2.0 I 4 WD	06.90-05.98	ATE	Д433	21190	ATE	Д459	21140
2.0 TURBO 16V	03.92-05.98				ATE	Д459	21140
2.0 16V	06.90-05.98	ATE	Д433	21190	ATE	Д459	21140
2.5 V6	03.92-05.98				ATE	Д459	21140
<b><u>Corsa A</u></b>							
1.0	02.83-08.90	GM	Д269	20939			
1.2	02.83-08.90	GM	Д269	20939			
1.3	02.83-09.88	GM	Д269	20939			
1.3 I	09.85-09.90	GM	Д269	20939			
1.4 I	08.88-03.93	ATE	Д700	20547			
1.4 GT	08.89-08.91	GM	Д269	20939			
1.5 D	08.87-02.93	GM	Д269	20939			
1.5 TD	09.87-03.98	ATE	Д700	20547			
1.6 I	01.88-08.97	GM	Д269	20939			
1.6 I	09.91-03.93	ATE	Д700	20547			
<b><u>Corsa B</u></b>							
CORSA B ALL MODELS	03.93-	ATE	Д700	20547	ATE	ДА700	
<b><u>Frontera</u></b>							
2.0	06.92- 95	AKE	Д866	21543			
2.0	95-08.98	SUM	Д139	21845			
2.2	95-	SUM	Д139	21845			
2.3 TD	06.92- 95	AKE	Д866	21543			



							
		i	DAFMI	W.V.A	i	DAFMI	W.V.A

2.4	06.92- 95	AKE	Д866	21543			
2.8 TD	95-08.98	SUM	Д139	21845			
<b><u>Kadett C</u></b>							
1.0	09.73-08.79	ATE	Д602	20034			
1.2	09.73-08.79	ATE	Д602	20034			
1.6	05.77-08.79	ATE	Д276	20588			
1.9	05.77-08.79	ATE	Д276	20588			
2.0	05.77-08.79	ATE	Д276	20588			
<b><u>Kadett D</u></b>							
KADETT D ALL (EXC. CARAVAN)	07.79-07.84	GM	Д269	20939	GM	ДА269	
<b><u>Kadett E</u></b>							
1.2	08.84-06.91	GM	Д269	20939			
1.3	08.84-06.91	GM	Д269	20939			
1.4	07.89-06.91	GM	Д269	20939	GM	ДА269	
1.5 TD	07.88-06.91	GM	Д269	20939	GM	ДА269	
1.6	08.84-06.91	GM	Д269	20939	GM	ДА269	
1.6 D	07.84- 89	GM	Д269	20939	GM	ДА269	
					GM	ДА269	
1.7 D	07.89-06.91	GM	Д269	20939	ATE	или Д459	21140
					GM	ДА269	
1.7 TD	07.89-06.91	GM	Д269	20939	ATE	или Д459	21140
					GM	ДА269	
1.8	07.84-06.91	GM	Д269	20939	ATE	или Д459	21140
					GM	ДА269	
1.8 I	08.84-06.91	ATE	Д433	21190	ATE	или Д459	21140
2.0 GSI	06.86- 88	GM	Д269	20939	ATE	Д459	21140
2.0 GSI	88-06.91	ATE	Д433	21190	ATE	Д459	21140
<b><u>Manta B</u></b>							
1.2	07.74-09.78	ATE	Д276	20588			
1.2	09.78-07.81	GM	Д269	20939			
1.3	04.79-08.81	GM	Д269	20939			
1.6	75-02.80	ATE	Д276	20588			
1.8	08.78-12.98	GM	Д269	20939			
1.9	08.74-09.78	ATE	Д276	20588			
1.9	09.78-07.81	GM	Д269	20939			
2.0	08.74-09.78	ATE	Д276	20588			
2.0	09.78- 83	GM	Д269	20939			
2.0 GSI	09.76-08.87	GM	Д269	20939			
<b><u>Monterey</u></b>							
MONTEREY ALL MODELS	08.91-	SUM	Д139	21845			
<b><u>Monza</u></b>							
MONZA ALL MODELS	09.77-08.87				ATE	Д602	20034
<b><u>Omega A</u></b>							
1.8	09.86-09.89	GM	Д269	20939	ATE	Д687	21050
1.8	09.89-03.94	ATE	Д433	21190	ATE	Д687	21050
1.8 I	10.86-09.89	GM	Д269	20939	ATE	Д687	21050
1.8 I	09.89- 92	ATE	Д433	21190	ATE	Д687	21050
2.0 I	10.86-09.88	GM	Д269	20939	ATE	Д687	21050
2.0 I	09.88- 94	ATE	Д433	21190	ATE	Д687	21050
2.3 D	08.86-09.89	GM	Д269	20939	ATE	Д687	21050
2.3 D	09.89- 94	ATE	Д433	21190	ATE	Д687	21050

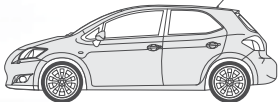
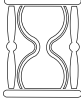
# Тормозные колодки для автомобилей иностранного производства

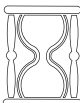

							
		i	DAFMI	W.V.A	i	DAFMI	W.V.A
2.3 TD	08.86-09.89	GM	Д269	20939	ATE	Д687	21050
2.3 TD	09.89- 94	ATE	Д433	21190	ATE	Д687	21050
2.4 I	88- 94	ATE	Д433	21190	ATE	Д687	21050
2.6 I	10.90- 94	LUC	Д152	21368	ATE	Д687	21050
3.0	09.92- 94	LUC	Д152	21368	ATE	Д687	21050
3.0 I	03.87-09.90	ATE	Д121	20903	ATE	Д687	21050
3.0 I	09.90- 94	LUC	Д152	21368	ATE	Д687	21050
3.0 I 24V	09.88-09.90	ATE	Д121	20903	ATE	Д687	21050
3.0 I 24V	09.90-12.92	LUC	Д152	21368	ATE	Д687	21050
<b><u>Omega B</u></b>							
2.0	04.94-07.99	ATE	Д160 или Д152	21411  21368	ATE	Д687	21050
2.5	04.94-07.99	LUC	Д152	21368	ATE	Д687	21050
2.5 TD	04.94-07.99	LUC	Д152	21368	ATE	Д687	21050
3.0	04.94-07.99	LUC	Д152	21368	ATE	Д687	21050
<b><u>Omega C</u></b>							
2.2	04.99-	LUC	Д152	21368	ATE	Д687	21050
<b><u>Record D</u></b>							
RECORD D ALL MODELS	02.72-07.74	ATE	Д602	20034			
RECORD D ALL MODELS	08.74-08.77	ATE	Д276	20588			
<b><u>Record E</u></b>							
RECORD E ALL MODELS	08.77-04.81	ATE	Д276	20588			
RECORD E ALL MODELS	05.81-07.86	GM	Д269	20939			
<b><u>Senator A</u></b>							
2.0	08.83-08.84	ATE	Д121	20903	ATE	Д602	20034
2.2 I	09.84-06.86	ATE	Д121	20903	ATE	Д602	20034
2.3 D	09.85-06.86	ATE	Д121	20903	ATE	Д602	20034
2.3 TD	09.85-06.86	ATE	Д121	20903	ATE	Д602	20034
2.5	08.81-07.83				ATE	Д602	20034
2.5	08.83-06.86	ATE	Д121	20903	ATE	Д602	20034
2.8	03.78-07.81				ATE	Д602	20034
3.0	08.78-12.82				ATE	Д602	20034
3.0 I	09.85-06.86	ATE	Д121	20903	ATE	Д602	20034
<b><u>Senator B</u></b>							
2.3 D	09.87-08.90	LUC	Д152	21368	ATE	Д687	21050
2.3 TD	08.88-08.90	LUC	Д152	21368	ATE	Д687	21050
2.5 I	10.87-09.90	ATE	Д121	20903	ATE	Д602	20034
2.5 I	10.90-07.93	LUC	Д152	21368	ATE	Д687	21050
2.6 I	10.90-12.92	LUC	Д152	21368	ATE	Д687	21050
3.0 I	10.87-09.90	ATE	Д121	20903	ATE	Д602	20034
3.0 I	10.90-07.93	LUC	Д152	21368	ATE	Д687	21050
3.0 I 24V	09.89-09.90	ATE	Д121	20903	ATE	Д602	20034
3.0 I 24V	10.90-07.93	LUC	Д152	21368	ATE	Д687	21050
<b><u>Tigra</u></b>							
1.4	07.94-	ATE	Д700	20547	ATE	ДА700	
1.6	07.94-	ATE	Д700	20547	ATE	ДА700	
<b><u>Vectra A</u></b>							
1.4	08.88-08.91	GM	Д269	20939			
1.6	08.88-09.91	GM	Д269	20939			
1.6	10.91- 92	ATE	Д700	20547			
1.6 I	08.88-08.91	GM	Д269	20939			
1.6 I	10.91-06.94	ATE	Д700	20547			
1.7 D	08.88-08.91	GM	Д269	20939			
1.7 D	09.91-06.94	ATE	Д700	20547			

							
		i	DAFMI	W.V.A	i	DAFMI	W.V.A

1.7 TD	06.91-08.95	ATE	Д700	20547			
1.8	10.88-09.91	GM	Д269	20939			
1.8	10.91-08.95	ATE	Д700	20547			
1.8 I	07.89-09.91	GM	Д269	20939			
1.8 I	10.91-07.92	ATE	Д700	20547			
1.8 4WD	08.88-08.95	ATE	Д433	21190	ATE	Д459	21140
2.0	08.88-08.95	ATE	Д433	21190	ATE	Д459	21140
2.0 I	08.88-11.95	ATE	Д433	21190			
2.0 I 4WD	08.88-07.92	ATE	Д433	21190			
2.0 I 4WD TURBO	09.92-06.94	ATE	Д160	21411	ATE	Д459	21140
2.5 I V6	03.93-08.95	ATE	Д160	21411	ATE	Д459	21140
<b><u>Vectra B</u></b>							
1.6 I	08.95-	ATE	Д433	21190	ATE	ДА184	
1.6 I 16V	09.95-	ATE	Д433	21190	ATE	Д687	21050
1.7 TD	09.95- 96	ATE	Д433	21190	ATE	Д687	21050
1.8 I	09.95-	ATE	Д433	21190	ATE	Д687	21050
2.0 I 16V	08.95-	ATE	Д156	21829	ATE	Д687	21050
2.0 D 16V	11.96-	ATE	Д433	21190	ATE	Д687	21050
2.5 I V6	08.95-	ATE	Д156	21829	ATE	Д687	21050
<b><u>Campo (light commercial)</u></b>							
2.2 D	09.91- 96	AKE	Д866	21543			
2.3	09.91- 96	AKE	Д866	21543			
2.5 D	09.91-	AKE	Д866	21543			
3.1 TD	04.92-	AKE	Д866	21543			
<b><u>Combo (light commercial)</u></b>							
COMBO ALL MODELS	93-12.99	ATE	Д700	20547			
<b><u>Vivaro Combi / Van</u></b>							
1.9 DI F9Q 774	08.01 -	LUC	Д149	21797			
1.9 TDI F9Q 760	08.01 -	LUC	Д149	21797			
2.0 ECOTEC	08.01 -	LUC	Д149	21797			
2.0 CDTI M9R 780	08.01 -	LUC	Д149	21797			
2.0 16V F4R 720	08.01 -	LUC	Д149	21797			
2.5 DTI G9U 730	08.01 -	LUC	Д149	21797			
2.5 CDTI G9MB6	08.01 -	LUC	Д149	21797			

## PEUGEOT



<b><u>106</u></b>							
1.0	91-	BDX	Д294	20905	LUC	ДА339	
1.1	91-	BDX	Д294	20905	LUC	ДА339	
1.3	91- 95	BDX	Д294	20905			
1.3	95- 96	CIT	Д548	21278			
1.4	91-	BDX	Д294	20905	LUC	ДА339	
1.4 W/ABS	95- 96	CIT	Д548	21278			
1.4 I	91- 96	BDX	Д294	20905			
1.5 D	94-	BDX	Д294	20905	LUC	ДА339	
1.5 D W/ABS	95- 96	CIT	Д548	21278			
1.6	94- 95	BDX	Д294	20905	LUC	ДА339	
1.6	95- 96	CIT	Д548	21278			
1.6 I	94-	BDX	Д294	20905	LUC	ДА339	
1.6 I W/ABS	95- 96	CIT	Д548	21278			
<b><u>205</u></b>							
205 ALL MODELS (EXC. 1.9 GTI)	83-05.97	BDX	Д294	20905			
		LUC	Д744	21080			
		LUC	Д339	20770			
205 1.9 GTI	09.86- 94	BDX	Д294	20905			
<b><u>206</u></b>							
1.1 I	08.98-04.01	BOSCH	Д179	21980	BSC	ДА179 (-ABS)	
1.4 I	08.98-05.01	BOSCH	Д179	21980	BSC	ДА179 (-ABS)	
1.6 I	08.98-05.01	BOSCH	Д179	21980	BSC	ДА179 (-ABS)	

# Тормозные колодки для автомобилей иностранного производства

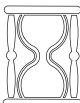

		i	DAFMI	W.V.A	i	DAFMI	W.V.A

1.9 D	08.98-05.01	BOSCH	Д179	21980	BSC	ДА179 (-ABS)	
<b>305</b>							
305 ALL MODELS	01.83- 90	BDX	Д294	20905			
<b>306</b>							
1.1 I	02.93-03.97	BDX	Д294	20905			
1.4 I No ABS	02.93-03.97	BDX	Д294	20905			
1.4 I No ABS	04.97-06.00	BOSCH	Д179	21980			
1.4 I W/ABS	04.97-06.00	LUC	Д144	21124			
1.6 I No ABS	04.97-06.00	BOSCH	Д179	21980			
1.6 I W/ABS	04.97-06.00	LUC	Д144	21124			
1.8 I	04.97-06.00	LUC	Д144	21124			
1.9 D/TD W/ABS	04.97-06.00	LUC	Д144	21124			
2.0	02.93-02.97	LUC	Д439	21209			
2.0	04.97-06.00	LUC	Д144	21124			
<b>307</b>							
1.6	03.01-	BOSCH	Д934	23600	LUC LUC	Д653 или Д481	20960/ 20961
2.0	03.01-	BOSCH	Д934	23600	LUC LUC	Д653 или Д481	20960/ 20961
2.0 HDI/HDIAP	03.01-	BOSCH	Д934	23600	LUC LUC	Д653 или Д481	20960/ 20961
2.0 HDIFAP	11.03-	ATE	Д195	23589/ 24153	LUC LUC	Д653 или Д481	20960/ 20961
<b>307CC</b>							
1.6	10.03-	BOSCH	Д934	23600	LUC LUC	Д653 или Д481	20960/ 20961
2.0	10.03-	ATE или BOSCH	Д195 или Д934	23589/ 24153 или 23600	LUC LUC	Д653 или Д481	20960/ 20961
<b>309</b>							
309 ALL MODELS EXC. 1.9	09.85- 93	BDX LUC	Д294 или Д744	20905 21080			
309 1.9	02.87- 93	BDX LUC	Д294 или Д339	20905 20770			
<b>405</b>							
1.4	87- 92	BDX	Д294	20905			
1.6	90- 92	BDX LUC	Д294 или Д439	20905 21209			
1.8 TD	02.88- 92	BDX LUC	Д294 или Д439	20905 21209			
1.9	87- 92	BDX	Д294	20905			
1.9	87- 92	LUC	Д439	21209	LUC LUC	Д653 или Д481	20960/ 20961

							
		i	DAFMI	W.V.A	i	DAFMI	W.V.A

1.9 D	87- 92	BDX	Д294 или Д439	20905			
		LUC		21209			
2.0	92- 96	LUC	Д439	21209	LUC LUC	Д653 или Д481	20960/ 20961
<b>605</b>							
605 ALL MODELS	09.89-02.91				ATE	Д548	21278
605 ALL MODELS	02.91-	BDX	Д572	21507	ATE	Д548	21278
<b>806</b>							
806 ALL MODELS EXC. 1.8	06.94-	LUC	Д711ИЗ	21074			
<b>Boxer (light commercial)</b>							
1.9 TD 1000 KG	03.94-	LUC	Д149	21797			
1.9 TD 1400 KG	03.94-	LUC	Д149	21797			
2.0 I EXC. 1800 KG	03.94-	LUC	Д149	21797			
2.0 I 1800 KG	03.94-	LUC	Д150	21799			
2.5 D 1800 KG	03.94-	LUC	Д150	21799			
2.5 TD 1400 KG	03.94-	LUC	Д149	21797			
2.5 TD 1800 KG	03.94-	LUC	Д150	21799			
<b>J5 (light commercial)</b>							
1.8	10.81- 93	LUC	Д530	20741			
1.9 D	09.90- 94	LUC	Д530	20741			
2.0 1000	10.81- 94	LUC	Д530	20741			
2.0 1300	10.81- 94	LUC	Д530	20741			
2.0 1800	09.87- 94	LUC	Д674	21206			
2.5 D 1000	10.81- 94	LUC	Д530	20741			
2.5 D 1300	10.81- 94	LUC	Д530	20741			
2.5 D 1800	09.87- 94	LUC	Д674	21206			
2.5 TD	09.87- 94	LUC	Д674	21206			
<b>J9 (light commercial)</b>							
J9 ALL MODELS	80- 92	BDX	Д499	20366			
<b>Partner (light commercial)</b>							
1.1 I	07.96-	LUC	Д144	21124			
1.1 CmV	11.01-10.02	BOSCH	Д219	24101/ 23599			
1.4 I	07.96-	LUC	Д144	21124			
1.4 Turn/CmV/Pla	11.01-	BOSCH	Д219	24101/ 23599			
1.6 Turn/Fam	11.01-10.02	BOSCH	Д219	24101/ 23599			
1.7 D	09.96-	LUC	Д144	21124			
1.8 D	07.96-	LUC	Д144	21124			
1.9 D	07.96-	LUC	Д144	21124			
1.9 Turn/CmV/Pla	11.01-10.02	BOSCH	Д219	24101/ 23599			
2.0 Turn/CmV/Pla	11.01-10.02	BOSCH	Д219	24101/ 23599			
2.0 HDi	00-	LUC	Д144	21124			
<b>Ranch</b>							
1.4 Turn/CmV	11.01-	BOSCH	Д219	24101/ 23599			
1.9 Turn/CmV	11.01-	BOSCH	Д219	24101/ 23599			

# Тормозные колодки для автомобилей иностранного производства



		i	DAFMI	W.V.A	i	DAFMI	W.V.A



2.0 HDI CmV/Turn	10.01-	BOSCH	Д219	24101/ 23599			
------------------	--------	-------	------	--------------	--	--	--

## PORSCHE

<b>911</b>							
911 ALL MODELS	72-04.83				ATE	Д620	20629
911 TARGA ALL MODELS	65- 72	ATE	Д620	20629			
<b>928</b>							
928 4.5 I	80-06.82	ATE	Д620	20629			
928 4.7 I S	09.79-09.85	ATE	Д620	20629			

## RENAULT

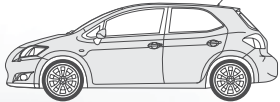
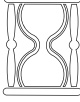
<b>Alpine</b>							
2.4 T	86- 91	LUC	Д339	20770			
2.7 A310	78- 85				BDX	Д226	20336
2.8 GT	85- 86	LUC	Д339	20770			
3.0 V6 T	91-08.94	LUC	Д926	20916			
<b>Clio I</b>							
1.1	06.92-05.95	LUC	Д339 или -	20770 21076			
1.2	90-02.98	LUC	Д339 или Д294	20770 20905	LUC	ДА339	
1.4	05.90-02.98	LUC	Д339 или Д294	20770 20905			
1.7	05.90-12.96	LUC	Д339	20770			
1.8	02.91-12.98	LUC	Д339	20770			
1.8 16V	09.90-11.96	LUC	Д339	20770			
1.9 D	05.90-02.98	LUC	Д339 или Д294	20770 20905	LUC	ДА339	
2.0 16V	09.90-04.96	BDX	Д339	20770			
<b>Clio II</b>							
1.2 I	98- 00	LUC	Д339	20770	LUC	ДА339	
1.4 I	98- 00	LUC	Д339	20770	LUC	ДА339	
1.6 I	98- 00	LUC	Д339	20770	LUC	ДА339	
1.9 D	98- 00	LUC	Д339	20770	LUC	ДА339	
<b>Clio III</b>							
ALL MODELS	01-	LUC	Д339	20770			
<b>Clio IV</b>							
1.2 (BRO2/BROJ/BROQ/BROR/BROS/ CRO2/CROJ/CROQ/CROK/CROS)	05.05-	LUC	Д204	23973			
1.4 (BROA/CROA)	05.05-	LUC	Д204	23973			
1.5 (BROF/BROG/BROH/CROF/ CROG/CROH)	05.05-	LUC	Д204	23973			
1.6 (BRO9/BROB/BROT/CRO9/ CROB/CROT)	05.05-	LUC	Д204	23973			
<b>Espace I (J 11/13)</b>							
2.0	06.84-12.90	LUC	Д339 или Д294	20770 20905			
2.0 I	85-01.91	LUC	Д339	20770			

								
			i	DAFMI	W.V.A	i	DAFMI	W.V.A
2.0 I W/ABS		85-01.91	LUC	Д339	20770	BDX	Д226	20336
2.0 4WD		88-01.91	LUC	Д339	20770	BDX	Д226	20336
2.1		86-01.91	LUC	Д339	20770			
2.1 W/ABS		86-01.91	LUC	Д339	20770	BDX	Д226	20336
2.1 TD		12.84-12.87	LUC	Д339	20770			
2.1 TD		01.88-01.91	LUC	Д339	20770	BDX	Д226	20336
<b><u>Espace II (J 63)</u></b>								
2.0		01.91-10.96	LUC	-	20236		-	
			BDX	или Д339	20770	BDX	или Д226	20336
2.1 TD		01.91-05.92	LUC	-	20236		-	
			LUC	или Д926	20916	BDX	или Д226	20336
2.2 (Not Quadra)		01.91-10.96	LUC	-	20236		-	
			LUC	или Д926	20916	BDX	или Д226	20336
2.2 Quadra		01.91-10.96					-	
						BDX	или Д226	20336
2.8 V6		01.91-04.92	LUC	Д926	20916	BDX	Д226	20336
2.9 V6		01.91-04.92					-	
						BDX	или Д226	20336
2.9 V6		05.92-09.96	LUC	Д926	20916	BDX	Д226	20336
<b><u>Espace III</u></b>								
1.9 Alu wh	(JKOG)	11.02-	ATE	Д231	23245/ 23247/ 23248	ATE	Д966	23482/ 23483
2.0	(JKOB/JKOD/JKOL)	11.02-	ATE	Д231	23245/ 23247/ 23248	ATE	Д966	23482/ 23483
2.2	(JKOH)	11.02-	ATE	Д231	23245/ 23247/ 23248	ATE	Д966	23482/ 23483
2.9 V6		10.96-04.99	LUC	Д926	20916	BDX	Д226	20336
3.0	(JKOJ)	11.02-	ATE	Д231	23245/ 23247/ 23248	ATE	Д966	23482/ 23483
3.5	(JKOF)	11.02-	ATE	Д231	23245/ 23247/ 23248	ATE	Д966	23482/ 23483
<b><u>Grand Espace</u></b>								
1.9 Alu wh	(JKOGL/JKOUL)	11.02-	ATE	Д231	23245/ 23247/ 23248	ATE	Д966	23482/ 23483
2.2	(JKOHL/JKOTL)	11.02-	ATE	Д231	23245/ 23247/ 23248	ATE	Д966	23482/ 23483
3.0	(JKOJL)	11.02-	ATE	Д231	23245/ 23247/ 23248	ATE	Д966	23482/ 23483
3.5	(JKOFL)	11.02-	ATE	Д231	23245/ 23247/ 23248	ATE	Д966	23482/ 23483





# Тормозные колодки для автомобилей иностранного производства

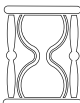

		i	DAFMI	W.V.A	i	DAFMI	W.V.A

<b>Grand Scenic</b>							
GRAND SCENIC ALL MODELS	10.03-					LUC	Д653 20960/ 20961
<b>Fuego</b>							
FUEGO ALL MODELS EXC. 1.6 TURBO	01.80- 86	LUC	Д339 или Д294	20770 20905			
FUEGO 1.6 TURBO	09.83- 86	LUC	Д339 или Д294	20770 20905	BDX	Д226	20336
<b>Kangoo</b>							
1.6 MONOSPACE, 4x4 (KCOP/KCOS)	11.01-	BOSCH	Д202	23930			
1.6 MONOSPACE, 4x4 (KCOL)	11.01-	BOSCH	Д202	23930			
1.6 EXPRESS 4x4 (FCOS)	11.01-	BOSCH	Д202	23930			
1.6 RAPID 4x4 (FCOS)	11.01-	BOSCH	Д202	23930			
1.9 MONOSPACE, 4x4 (KCOV)	11.01-	BOSCH	Д202	23930			
1.9 RAPID 4x4 (FCOV)	11.01-	BOSCH	Д202	23930			
<b>Laguna I</b>							
1.6 16V (W/ABS)	07.98-	LUC	Д926	20916			
1.8 (W/ABS)	10.94-	LUC	Д926	20916			
1.8 Nevada	11.95-06.98	LUC	Д926	20916			
1.9 16V (W/ABS)	06.95-06.98	LUC	Д926	20916			
1.9 DTI	99-	LUC	Д926	20916			
2.0 (W/ABS)	01.94-07.94	LUC	Д926	20916			
2.0	07.99-	LUC	Д926	20916			
2.0 Nevada	11.95-	LUC	Д926	20916			
2.2 D/TD	01.94-	LUC	Д926	20916			
2.9 24V	04.97-06.98	LUC	Д926	20916			
3.0 V6 24V	01.94-	LUC	Д926	20916			
<b>Laguna II</b>							
1.6 16"SW (BGOA/BGOL/BGOU)	03.01-	ATE	Д231	23245/ 23247/ 23248	ATE	Д966	23482/ 23483
1.8 15"SW (BGO4/BGO6/BGOC/BGOJ/ BGOM/BGOV)	03.01-				ATE	Д966	23482/ 23483
1.8 16"SW (BGO4/BGO6/BGOB/BGOC/ BGOJ/BGOM/BGOV)	03.01-	ATE	Д231	23245/ 23247/ 23248	ATE	Д966	23482/ 23483
1.9 15"SW (BGO8/BGOE/BGOR)	03.01-				ATE	Д966	23482/ 23483
1.9 16"SW (BGO8/BGOE/BGOG/ BGOR/BG1P)	03.01-	ATE	Д231	23245/ 23247/ 23248	ATE	Д966	23482/ 23483
2.0 16"SW (BGOK/BGON/KGOK)	09.01-	ATE	Д231	23245/ 23247/ 23248	ATE	Д966	23482/ 23483
2.0 16"SW (BGOP)	10.02-	ATE	Д231	23245/ 23247/ 23248	ATE	Д966	23482/ 23483
2.0 17"SW (BGOS/BG1M)	09.03-	ATE	Д231	23245/ 23247/ 23248	ATE	Д966	23482/ 23483
2.0 17"SW (BGOZ)	01.05-	ATE	Д231	23245/ 23247/ 23248	ATE	Д966	23482/ 23483

							
		i	DAFMI	W.V.A	i	DAFMI	W.V.A



2.2 16"SW (BGOF)	09.01-	ATE	Д231	23245/ 23247/ 23248	ATE	Д966	23482/ 23483
2.2 17"SW (BGO9/BGOF)	04.04-	ATE	Д231	23245/ 23247/ 23248	ATE	Д966	23482/ 23483
2.9 17"SW (BGO1/BGO2/BGOD)	03.01-	ATE	Д231	23245/ 23247/ 23248	ATE	Д966	23482/ 23483
2.9 17"SW (BGOY)	10.01-	ATE	Д231	23245/ 23247/ 23248	ATE	Д966	23482/ 23483
2.9 17"SW (BG1K)	04.04-	ATE	Д231	23245/ 23247/ 23248	ATE	Д966	23482/ 23483
<b><i>Laguna Estate/Break</i></b>							
1.6 16"SW (KGOA/KGOL/KGOU)	03.01-	ATE	Д231	23245/ 23247/ 23248	ATE	Д966	23482/ 23483
1.8 16"SW (KGO6/KGOB/KGOJ/KGOM/ KGOV)	03.01-	ATE	Д231	23245/ 23247/ 23248	ATE	Д966	23482/ 23483
1.8 16"SW (KGO4)	10.02-	ATE	Д231	23245/ 23247/ 23248	ATE	Д966	23482/ 23483
1.9 16"SW/17"SW (KGO8/KGOE/KGOG/ KGOR/KG10)	03.01-	ATE	Д231	23245/ 23247/ 23248	ATE	Д966	23482/ 23483
2.0 16"SW (KGOK/KGON)	09.01-	ATE	Д231	23245/ 23247/ 23248	ATE	Д966	23482/ 23483
2.0 16"SW (KGOP)	10.02-	ATE	Д231	23245/ 23247/ 23248	ATE	Д966	23482/ 23483
2.0 17"SW (KGOS)	09.03-03.05	ATE	Д231	23245/ 23247/ 23248	ATE	Д966	23482/ 23483
2.0 17"SW (KGOZ)	01.05-	ATE	Д231	23245/ 23247/ 23248	ATE	Д966	23482/ 23483
2.2 16"SW (KGOF)	09.01-	ATE	Д231	23245/ 23247/ 23248	ATE	Д966	23482/ 23483
2.2 17"SW (KGO9)	04.04-	ATE	Д231	23245/ 23247/ 23248	ATE	Д966	23482/ 23483
2.9 17"SW (KGO1/KGO2/KGOD)	03.01-	ATE	Д231	23245/ 23247/ 23248	ATE	Д966	23482/ 23483
2.9 17"SW (KGOY)	10.01-	ATE	Д231	23245/ 23247/ 23248	ATE	Д966	23482/ 23483
2.9 17"SW (KG1K)	04.04-	ATE	Д231	23245/ 23247/ 23248	ATE	Д966	23482/ 23483

# Тормозные колодки для автомобилей иностранного производства



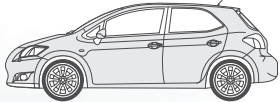
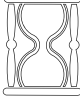

		i	DAFMI	W.V.A	i	DAFMI	W.V.A



<u>Logan</u>							
1.4i	09.04-	LUC	Д339	20770	LUC	ДА339	
1.6i	09.04-	LUC	Д339	20770	LUC	ДА339	
1.5 dCi	09.04-	LUC	Д339	20770	LUC	ДА339	
1.6i 16V	09.04-	LUC	Д339	20770	LUC	ДА339	
<u>Megane</u>							
1.4 I	10.95-02.99	LUC	Д339	20770			
1.5 (BMO2/BMOF/CMO2/CMOF/ LMO2/LMOF/SMO2/SMOF)	09.02-	BOSCH	Д202	23930			
1.6 I	10.95-02.99	LUC	Д339	20770			
1.6 (BMOC/BMOJ/BMOY/CMOC/CMOJ/ LMOJ/LMOY)	09.02-	BOSCH	Д202	23930			
1.9 D	10.95-	LUC	Д339	20770			
1.9 TD	10.95-02.99	LUC	Д339	20770			
1.9 (BMOG/CMOG)	09.02-08.03	BOSCH	Д202	23930			
2.0 I All	10.95-	LUC	Д339	20770			
2.0 I 16V All	10.95-	LUC	Д926	20916			
2.0 (BMO5/BMOU/BM1N/CMO5/ CMOU/CM1N/LMO5/LMOU/LM1N)	09.02-	BOSCH	Д202	23930			
<u>Megane CC</u>							
1.6 (EMOC/EMOJ/EM1B)	08.03-	BOSCH	Д202	23930			
1.9 (EMOG/EM1C/EM1N/EM1G)	08.03-	BOSCH	Д202	23930			
2.0 (EMO5/EMOU/EMOW/EM1M/EM1N)	08.03-	BOSCH	Д202	23930			
<u>Megane Scenic</u>							
1.4	10.96-05.99	LUC	Д339	20770			
1.6	01.96-05.99	LUC	Д339	20770			
1.9 D/TD	01.96-	LUC	Д926	20916			
2.0	01.96-	LUC	Д926	20916	LUC LUC	Д653 или Д481	20960/ 20961
<u>Modus</u>							
MODUS ALL MODELS	08.04-	LUC	Д204	23973	LUC LUC	Д653 или Д481	20960/ 20961
<u>R 5</u>							
R 5 ALL MODELS	12.84-12.94	LUC	Д339	20770			
R 5 VAN ALL MODELS	85-12.94	LUC BDX	Д339 или Д294	20770 20905			
<u>R 9</u>							
ALL MODELS	11.81-12.89	LUC BDX	Д339 или Д294	20770 20905			
<u>R 11</u>							
ALL MODELS	06.83-12.89	LUC BDX	Д339 или Д294	20770 20905			
<u>R 18</u>							
1.4	07.82-09.83	LUC	Д339 или Д294	20770 20905			
1.4	10.83-12.86	LUC	Д339	20770			

							
		i	DAFMI	W.V.A	i	DAFMI	W.V.A
1.9	09.78-07.86	LUC	Д339 или Д294	20770			
		BDX	Д294	20905			
		LUC	Д339	20770			
		BDX	Д294	20905			
		BDX	Д294	20905			
1.6 TURBO	09.80-12.81	LUC	Д339	20770			
		BDX	Д294	20905			
1.6 TURBO	01.82-09.85	LUC	Д339	20770	BDX	Д226	20336
		BDX	Д294	20905			
2.0	01.82-09.85	LUC	Д339	20770			
		BDX	Д294	20905			
2.1 D	11.80-11.86	LUC	Д339	20770			
		BDX	Д294	20905			
<b><u>R 19</u></b>							
1.2	11.88-12.96	LUC	Д339 или Д294	20770			
		BDX	Д294	20905			
1.2 CHAMADE	09.88-12.96	LUC	Д339	20770			
		BDX	Д294	20905			
1.4	09.88-12.96	LUC	Д339	20770			
		BDX	Д294	20905			
1.4 CHAMADE	09.88-12.96	LUC	Д339	20770			
		BDX	Д294	20905			
1.7	09.88-12.96	LUC	Д339	20770			
		BDX	Д294	20905			
1.7 CHAMADE	09.88-12.96	LUC	Д339	20770			
		BDX	Д294	20905			
1.8 16V	01.90-12.96	LUC	Д339	20770			
1.8 16V CHAMADE	01.90-12.96	LUC	Д339	20770			
1.9 D	09.88-12.96	LUC	Д339	20770			
		BDX	Д294	20905			
1.9 D CHAMADE	09.88-12.96	LUC	Д339	20770			
		BDX	Д294	20905			
1.9 TD	09.88-12.96	LUC	Д339	20770			
1.9 TD CHAMADE	09.88-12.96	LUC	Д339	20770			
<b><u>R 20</u></b>							
1.6	07.80-12.84	BDX	Д294	20905			
2.0	09.77-01.85	LUC	Д339	20770			
		BDX	Д294	20905			
2.1 D	01.80-07.84	LUC	Д339	20770			
		BDX	Д294	20905			
2.1 TD	01.80-07.84	LUC	Д339	20770			

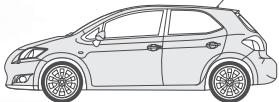
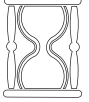
# Тормозные колодки для автомобилей иностранного производства

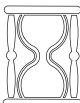

							
		i	DAFMI	W.V.A	i	DAFMI	W.V.A
<b><u>R 21</u></b>							
1.4	02.86-12.94	LUC	Д339 или Д294	20770			
		BDX		20905			
1.7	03.86-12.94	LUC	Д339 или Д294	20770			
		BDX		20905			
1.9 D	05.89-12.94	LUC	Д339 или Д294	20770			
		BDX		20905			
2.0	02.86-12.94				BDX	- или Д226	20336
2.1 D	02.86-12.94	LUC	Д339 или Д294	20770		-	
		BDX		20905	BDX	или Д226	20336
2.1 TD	02.86-12.94	BDX	Д294	20905			
2.2	07.86-12.94					- или Д226	20336
					BDX		
<b><u>R 25</u></b>							
2.0	02.84-12.92	LUC	Д339	20770	BDX	- или Д226	20336
2.1 D/TD	02.84-12.92	LUC	Д339	20770	BDX	- или Д226	20336
2.2	02.84-12.92	LUC	Д339	20770		- или Д226	20336
					BDX		20336
2.5 V6 Turbo	06.87-05.90	LUC	Д339	20770	BDX	Д226	20336
<b><u>R 30</u></b>							
2.1 TD	09.81-06.84	LUC	Д339	20770			
	03.75-12.84	LUC	Д996	20928	BDX	Д226	20336
<b><u>Rapid</u></b>							
RAPID ALL MODELS	86-07.98	LUC BDX	Д339 или Д294	20770 20905			
<b><u>Safrane</u></b>							
2.0	05.92-	LUC	Д926	20916			
2.1 D	05.92-10.96	LUC	Д926	20916			
2.2	01.92-10.96	LUC	Д926	20916			
2.2 TD	11.96-	LUC	Д926	20916			
2.5 D	11.96-	LUC	Д926	20916			
2.9	03.99-	LUC	Д926	20916			
3.0	01.92-	LUC	Д926	20916	BDX	- или Д352	20410 20859
<b><u>Scenic</u></b>							
SCENIC ALL MODELS	06.03-	BOSCH	Д202	23930	LUC LUC	Д653 или Д481	20960/ 20961

							
		i	DAFMI	W.V.A	i	DAFMI	W.V.A

<b>Scenic RX4</b>							
1.9 MPV/4x4 (JAO5/JA1U)	04.02-06.04	ATE	Д231	23245/ 23247/ 23248	LUC LUC	Д653 или Д481	20960/ 20961
2.0 MPV/4x4 (JAOC)	04.02-08.03	ATE	Д231	23245/ 23247/ 23248	LUC LUC	Д653 или Д481	20960/ 20961
<b>Twingo</b>							
1.1	05.96-	LUC	Д339	20770	LUC	ДА339	
<b>Vel Satis</b>							
VEL SATIS ALL MODELS	02.02-	ATE	Д231	23245/ 23247/ 23248	ATE	Д966	23482/ 23483
<b>Kangoo (light commercial)</b>							
1.2	08.97-	BOSCH	Д179	21980			
1.4	08.97-	BOSCH	Д179	21980			
1.9 D	08.97-	BOSCH	Д179	21980			
<b>Express (light commercial)</b>							
EXPRESS ALL MODELS	10.85-	LUC BDX	Д339 или Д294	20770 20905			
<b>Trafic (light commercial)</b>							
TRAFIC ALL MODELS	10.80-	BDX BDX	- или Д996	20488 20928			
<b>Trafic FL/JL/EL</b>							
1.9 dCi 80 F9Q 762	03.01 -	LUC	Д149	21797			
1.9 dCi 100 F9Q 760	03.01 -	LUC	Д149	21797			
2.0 dCi 90 M9R 780	03.01 -	LUC	Д149	21797			
2.0 dCi 115 M9R 780	03.01 -	LUC	Д149	21797			
2.0 F4R 720	03.01 -	LUC	Д149	21797			
2.5 dCi 135 G9U 730	03.01 -	LUC	Д149	21797			
2.5 dCi 145 G9U 630	03.01 -	LUC	Д149	21797			

## ROVER



<b>75</b>							
ALL MODELS	04.99-				ATE	Д154	21690
<b>200</b>							
214 16V W/ABS	10.89- 96				AKE	Д563	21312
216 16V W/ABS	10.89- 96				AKE	Д563	21312
<b>400</b>							
414 16V W/ABS	10.89- 97				AKE	Д563	21312
418 D W/ABS	10.92- 96				AKE	Д563	21312
418 TD W/ABS	10.92- 96				AKE	Д563	21312
420	10.92-				AKE	Д563	21312
420 D W/ABS	10.92- 97				AKE	Д563	21312
420 TURBO	10.92-				AKE	Д563	21312
<b>600</b>							
618 1.8	10.94- 96	AKE	Д890	21879	AKE	Д751	21719
619 1.8	10.94- 96	AKE	Д890	21879	AKE	Д751	21719
620 2.0	09.93- 98	AKE	Д890	21879	AKE	Д751	21719
620 2.0 D	04.95- 96	AKE	Д890	21879	AKE	Д751	21719
623 2.3	09.93- 98	AKE	Д890	21879	AKE	Д751	21719
623 2.3	09.93- 98	AKE	Д890	21879	AKE	Д751	21719
<b>800</b>							
820 2.0 I GSI					AKE	Д751	21719

## SAAB

<b>99</b>							
2.0	74- 80				ATE	Д511	21089
<b>900</b>							
2.0	09.79-03.84				ATE	Д511	21089
2.0	08.93-05.98	ATE	Д156	21829	ATE	Д687	21050
2.0 I	84-12.88				ATE	Д459	21140

# Тормозные колодки для автомобилей иностранного производства

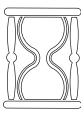



			
		i DAFMI W.V.A	i DAFMI W.V.A

2.0 I	01.89- 93				ATE	Д511	21089
2.0 I CABRIO	09.89- 94				ATE	Д687	21050
2.0 TURBO	02.94-05.98	ATE	Д156	21829	ATE	Д687	21050
2.0 TURBO CABRIO	09.86-05.98				ATE	Д459	21140
2.1 CABRIO	09.90- 91				ATE	Д511	21089
2.3	08.93-05.98	ATE	Д156	21829	ATE	Д687	21050
2.5 V6	08.93-05.98	ATE	Д156	21829	ATE	Д687	21050
<b>9000</b>							
9000 ALL MODELS	07.85- 98				ATE	Д511	21089
<b>9-3</b>							
9-3 ALL MODELS	98-	ATE	Д156	21829	ATE	Д687	21050
<b>9-5</b>							
9-5 ALL MODELS	08.97-	ATE	Д156	21829	ATE	Д687	21050

## SEAT

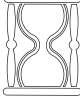
<b>131</b>							
131 ALL MODELS	82- 83	BDX	Д334	20950			
<b>Alhambra</b>							
1.8 T 20V	03.96-	ATE	Д957	20676	LUC	Д481	20961
1.9 TDI	03.96-	ATE	Д957	20676	LUC	Д481	20961
2.0	03.96-	ATE	Д957	20676	LUC	Д481	20961
2.0 I	03.96-	ATE	Д957	20676	LUC	Д481	20961
1.8i T 20V, 1.9 TDi, 2.0i 16V	09.95-02.00				LUC	Д638	23224
1.8i T 20V, 1.9 TDi, 2.8i VR6 (16")	03.00-				LUC	Д638	23224
<b>Arosa</b>							
1.0	05.97-	ATE	Д157	21866	ATE	ДА366 или ДА884	
1.4	11.97-	ATE	Д157	21866	ATE	ДА366 или ДА884	
1.7 SDI	03.98-	ATE	Д157	21866	ATE	ДА366 или ДА884	
<b>Cordoba</b>							
1.4 I CLX	01.94- 99	KH	Д366	20888	ATE	ДА366 или ДА884	
1.6	93-05.95	KH	Д366	20888	ATE	ДА366 или ДА884	
1.6	06.95-	KH	Д366 или	20888	ATE	ДА366 или	
1.8 GLX	11.93- 94	ATE	Д158	21866	ATE	ДА884	
1.8 GLX	94- 99	KH	Д366	20887	ATE	ДА884	
1.8 I GTI	11.93- 99	ATE	Д158	21866	ATE	ДА884	
1.9 D	06.95-	LUC	Д884	20168	LUC	Д653	20960
1.9 TD	11.93- 99	KH	Д366	20888	ATE	ДА884	

							
		i	DAFMI	W.V.A	i	DAFMI	W.V.A

1.9 DTi	06.95-	KH ATE	Д364 или Д158	20887 21866	ATE	ДА884	
2.0 I GTI	11.93- 99	LUC	Д884	20168	LUC	Д653	20960
<b><u>Ibiza</u></b>							
0.9	09.86-01.93	BDX	Д334	20950			
1.0 I SPAIN	01.94-	KH	Д368	20889	ATE	ДА366	
1.2	84-01.93	BDX	Д334	20950			
1.3 I	10.93- 94	KH	Д366	20888	ATE	ДА366	
1.3 I SPAIN	10.93- 94	KH	Д368	20889	ATE	ДА366	
1.4 SPAIN	94-	KH	Д368	20889	ATE	ДА366	
1.5	02.88-01.93	BDX	Д334	20950			
1.6 I	03.93-	KH	Д366	20888	ATE	ДА884	
1.7	01.92- 93	BDX	Д334	20950			
1.7 D	03.85-12.92	BDX	Д334	20950			
1.8	10.93-06.96	KH	Д366	20888	ATE	ДА884	
1.8	07.96-	KH	Д157	21866	ATE	ДА884	
1.8 GTI 16V	11.93-	LUC	Д884	20168	LUC	Д653	20960
1.9 D	03.93-01.96	KH	Д366	20888	ATE	ДА884	
1.9 D	02.96-	KH	Д157	21866	ATE	ДА884	
1.9 TD	02.96-	KH	Д157	21866	ATE	ДА884	
		LUC	Д884	20168			
2.0 I	03.93-	ATE	или Д157	21866	LUC	Д653	20960
<b><u>Leon</u></b>							
1.4	08.99-	ATE	Д137	21974	LUC	Д481	20961
1.6	08.99-	ATE	Д137	21974	LUC	Д481	20961
1.8 T	08.99-	ATE	Д957	20676	LUC	Д481	20961
1.7 D	08.99-	ATE	Д137	21974	LUC	Д481	20961
1.9 TDi	02.01-	ATE	Д957И2	23392	LUC	Д481	20961
2.8i Cupra	02.01-	ATE	Д957И2	23392	LUC	Д481	20961
<b><u>Malaga</u></b>							
1.2	09.85-10.91	BDX	Д334	20950			
1.5	09.85- 91	BDX	Д334	20950			
1.7 D	09.85-10.91	BDX	Д334	20950			
<b><u>Marbella</u></b>							
0.8	87-10.96	BDX	Д334	20950			
0.9	87-10.96	BDX	Д334	20950			
<b><u>Panda</u></b>							
0.9	82- 86	BDX	Д334	20950			
<b><u>Ritmo</u></b>							
1.2	79- 83	BDX	Д334	20950			
1.4	79- 83	BDX	Д334	20950			
<b><u>Ronda</u></b>							
1.2	06.83-07.86	BDX	Д334	20950			
1.4	07.83-12.83	BDX	Д334	20950			
1.5	09.85-07.86	BDX	Д334	20950			
1.6	06.83-08.85	BDX	Д334	20950			
1.7 D	06.83-07.86	BDX	Д334	20950			
<b><u>Toledo</u></b>							
1.4	11.98-	ATE	Д137	21974	ATE	ДА366	



# Тормозные колодки для автомобилей иностранного производства





		i	DAFMI	W.V.A	i	DAFMI	W.V.A

1.6	05.91-10.98	KH	Д366	20888	ATE	ДА366 или ДА884	20960
1.6	11.98-	ATE	Д137	21974	ATE LUC	ДА366 или ДА884	
1.8	91-10.98	KH	Д366	20888	ATE	ДА366 или ДА884	20960
1.8	11.98-	ATE	Д137	21974	ATE LUC	ДА366 или ДА884	
1.8 I 16V	09.91-12.93	LUC	Д884	20168	LUC	ДА366 или ДА884	20960
1.9 D	06.91-10.98	KH	Д366	20888	LUC	ДА366 или ДА884	20960
1.9 TDI	09.85-10.98	LUC	Д884 или Д885	20168	ATE	ДА366 или ДА884	
1.9 TDI	11.98-	ATE	Д137	21974	LUC	ДА366 или ДА884	20960
2.0	91-10.98	LUC	Д884	20168	LUC	ДА366 или ДА884	
2.0	07.04-	ATE	Д194	23587/ 23588/ 23589			
2.0 TDI	07.04-	ATE	Д194	23587/ 23588/ 23589			
2.3	11.98-08.99	ATE	Д957	20676	LUC	ДА366 или ДА884	20961
<b><u>Toledo II</u></b>							
1.9 TDi	05.01-	ATE	Д957И2	23392	LUC	ДА366 или ДА884	20961
2.3i V5	05.01-	ATE	Д957И2	23392	LUC	ДА366 или ДА884	20961

## SKODA

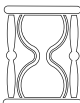
<b><u>Fabia</u></b>							
1.2	07.00-	ATE	Д137	21974	ATE	ДА366 или ДА884	
1.4	10.99-	ATE	Д137	21974	ATE	ДА366 или ДА884	
1.9 SDi	07.00-	ATE	Д137	21974	ATE	ДА366 или ДА884	
1.9 TDi	07.00-	ATE	Д137	21974	LUC	ДА366 или ДА884	20961
2.0	08.00-	ATE	Д957	20676	LUC	ДА366 или ДА884	20961
<b><u>Favorit</u></b>							
1.3	89- 95	LUC	Д446	21662			
1.3 I	89- 95	LUC	Д446	21662			
<b><u>Felicia</u></b>							
1.3	95-08.01	LUC	Д446	21662	ATE	ДА366 или ДА884	
1.6	95-08.01	LUC	Д446	21662	ATE	ДА366 или ДА884	
1.9 D	95-08.01	LUC	Д446	21662	ATE	ДА366 или ДА884	
<b><u>Forman</u></b>							
1.3	91- 95	LUC	Д446	21662			
1.3 I	91- 95	LUC	Д446	21662			

							
		i	DAFMI	W.V.A	i	DAFMI	W.V.A

<b>Octavia</b>							
1.4	05.04-				LUC	Д203	23914
1.6	10.96-	ATE	Д137	21974		ДА137	
1.6	05.04-				LUC	Д203	23914
1.6 Swt	09.04-				LUC	Д203	23914
		ATE	Д137	21974		ДА137	
1.8	08.96-		или			или	
		ATE	Д957	20676	LUC	Д481	20961
1.8i	08.00-	ATE	Д957И2	23392	LUC	Д481	20961
1.8i T	08.00-	ATE	Д957И2	23392	LUC	Д481	20961
		ATE	Д137	21974		ДА137	
1.9 D	05.97-		или			или	
		ATE	Д957	20676	LUC	Д481	20961
1.9 TDi	08.00-	ATE	Д957И2	23392	LUC	Д481	20961
1.9	05.04-				LUC	Д203	23914
1.9 Swt	09.04-				LUC	Д203	23914
		ATE	Д137	21974			
2.0	08.00-	ATE	или		LUC	Д481	20961
		ATE	Д957	20676			
2.0i	08.00-	ATE	Д957И2	23392	LUC	Д481	20961
2.0 Combi 4x4	08.00-	ATE	Д957И2	23392	LUC	Д481	20961
2.0	05.04-	ATE	Д194	23587/ 23588/ 23589	LUC	Д203	23914
2.0 Stw	09.04-	ATE	Д194	23587/ 23588/ 23589	LUC	Д203	23914
<b>Pick-up</b>							
PICK-UP 1.3	93-09.95	LUC	Д446	21662			

## SUBARU

<b>Domingo</b>							
1.0 DX	08.92-05.94	SUM	Д321	20958			
1.2 I DX	08.92-04.94	SUM	Д321	20958			
<b>Impreza</b>							
1.6 4WD	01.93-08.96	AKE	Д641	21495			
1.8 4WD	01.93-06.96	AKE	Д641	21495			
2.0 COUPE	96-08.96	AKE	Д641	21495			
2.0 TURBO COUPE	94-08.96	AKE	Д641	21495			
2.0 I 4WD	10.95-08.96	AKE	Д641	21495			
2.0 I TURBO	03.94-08.96	AKE	Д641	21495			
<b>Justy</b>							
1.3	05.96-	SUM	Д174	21333			
<b>Legacy</b>							
1.8 I	08.89-07.91	AKE	Д641	21495			
1.8 4 WD	08.89-07.91	AKE	Д641	21495			
2.0 I	09.94-	AKE	Д641	21495			
2.0 I 4WD	09.94-	AKE	Д641	21495			
2.2 I	94-	AKE	Д641	21495			

## SUZUKI

<b>Alto</b>							
0.7 I	94-	AKE	Д143				
1.0	09.94-	SUM	Д174	21333			

# Тормозные колодки для автомобилей иностранного производства



		i	DAFMI	W.V.A	i	DAFMI	W.V.A



<b>Grand Vitara</b>							
ALL MODELS	01.98-	AKE	Д178	23314			
<b>Swift</b>							
1.0	02.85-	SUM	Д174	21333			
1.0 CAT	02.89-	SUM	Д174	21333			
1.0 GL	02.89-	SUM	Д174	21333			
1.0 I	09.91-	SUM	Д174	21333			
1.3 GL	89-	SUM	Д174	21333			
1.3 GL 4WD	10.89-	SUM	Д174	21333			
1.3 GTI CAT	01.89-	SUM	Д174	21333			
1.3	02.05-	LUC	Д204И				
1.5	02.05-	LUC	Д204И				
		AKE	Д436	21344			
1.6 GLX	10.89-10.96		или Д174	21333			
		SUM	Д174	21333			
		AKE	Д436	21344			
1.6 GLX 4WD	11.89-10.96		или Д174	21333			
		SUM	Д174	21333			
<b>Vitara</b>							
2.0	96- 98	AKE	Д178	23314			
2.0 TD	94- 98	AKE	Д178	23314			
2.0 TD INTERCOOLER	95- 98	AKE	Д178	23314			
2.0 V6	94- 98	AKE	Д178	23314			
2.0 16V CABRIO	96- 99	AKE	Д178	23314			

## TALBOT

<b>Express (light commercial)</b>							
EXPRESS ALL MODELS EXC. TD	82- 94	LUC	Д530	20741			

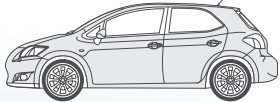
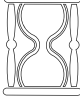

## TOYOTA

<b>4-Runner</b>							
2.4	12.87-07.89	SUM	Д974	20852			
2.4 TD (LN130)	08.89-08.91	SUM	Д210	21679/ 21680/ 21681/21785			
2.5 TD	89- 96	SUM	Д172	21775			
2.8 D	89- 96	SUM	Д172	21775			
3.0 (VZN130)	01.90-08.91	SUM	Д210	21679/ 21680/ 21681/21785			
3.0 V6	87-11.95	SUM	Д172	21775			
3.0 TD	10.93-11.95	SUM	Д172	21775			
<b>Avensis</b>							
1.6	10.97-02.03	ATE	Д897	21975			
1.6 VVTI (ZZT250)	03.03-	BOSCH	Д126	23480/ 23481/23768	BOSCH	Д361	
1.8	10.97-	ATE	Д897	21975			
1.8 VVTI (ZZT251)	03.03-	BOSCH	Д126	23480/ 23481/23768	BOSCH	Д361	
1.8 VVTI ESTATE/WAGON (ZZT251)	03.03-	BOSCH	Д126	23480/ 23481/23768	BOSCH	Д361	

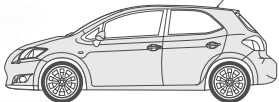
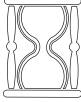

							
		i	DAFMI	W.V.A	i	DAFMI	W.V.A
2.0	10.97-	ATE	Д897	21975			
2.0 (AZT250)	03.03-	BOSCH	Д126	23480/ 23481/ 23768	BOSCH	Д361	
2.0 D4d (CDT250)	03.03-	BOSCH	Д126	23480/ 23481/ 23768	BOSCH	Д361	
2.0 ESTATE/WAGON (AZT250)	03.03-	BOSCH	Д126	23480/ 23481/ 23768	BOSCH	Д361	
2.0 D4d ESTATE/WAGON (CDT250)	03.03-	BOSCH	Д126	23480/ 23481/ 23768	BOSCH	Д361	
2.4 (AZT251)	09.03-	BOSCH	Д126	23480/ 23481/ 23768	BOSCH	Д361	
2.4 ESTATE/WAGON (AZT251)	03.03-	BOSCH	Д126	23480/ 23481/ 23768	BOSCH	Д361	
<b><i>Avensis Station Wagon</i></b>							
2.0 TD	00-				AKE	Д288	21834
<b><i>Camry (CV 10/11/SV 10/11)</i></b>							
1.8	83-12.85	AKE	Д404	20870			
1.8 TD	01.83- 85	AKE	Д404	20870			
2.0	07.84-10.86	AKE	Д404	20870			
<b><i>Camry (CV 20/SV 21/VZV 21)</i></b>							
1.8	86- 91	AKE	Д445	21372			
2.0 W/O ABS	11.86-10.91	AKE	Д445	21372			
2.0 I	86- 91	AKE	Д445	21372			
2.0 TD W/O ABS	11.86-08.91	AKE	Д445	21372			
2.5	06.88- 94	AKE	Д445	21372	AKE	Д288	21834
<b><i>Camry (V 10)</i></b>							
2.2	06.91-09.96	SUM	Д816 или Д185 или -	21601 21791	AKE	- или Д288	21834
3.0	06.91-09.96	SUM	Д816 или Д185 или -	21601 21791	AKE	- или Д288	21834
<b><i>Camry (V 20)</i></b>							
2.2	10.96-	SUM	Д185	21791	AKE	Д288	21834
2.4	10.96-	SUM	Д185	21791	AKE	Д288	21834
3.0	10.96-	SUM	Д185	21791	AKE	Д288	21834
<b><i>Camry (CV 30)</i></b>							
2.0 VVTI (ACV31)	08.01-	AKE	Д234				
2.4 VVTI (ACV30)	08.01-	AKE	Д234				
3.0 VVTI (MCV30)	08.01-	AKE	Д234				
<b><i>Carina II (T 15)</i></b>							
1.6	01.84-05.88	AKE	Д404	20870			
1.8	12.85-08.87	AKE	Д404	20870			
2.0 D	12.85-09.99	AKE	Д404	20870			

# Тормозные колодки для автомобилей иностранного производства

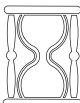

							
		i	DAFMI	W.V.A	i	DAFMI	W.V.A

<b>Carina II Liftback (T 17)</b>							
1.6 13" WHEELS	88- 92	AKE	Д404	20870			
1.6 14" WHEELS	88- 92	AKE	Д445	21372			
2.0 13" WHEELS	88- 92	AKE	Д404	20870	AKE	Д288	21834
2.0 14" WHEELS	88- 92	AKE	Д445	21372	AKE	Д288	21834
2.0 D 13" WHEELS	88- 92	AKE	Д404	20870			
2.0 D 14" WHEELS	88- 92	AKE	Д445	21372			
<b>Carina E (T 19)</b>							
1.6	92- 98	SUM	Д816	21601	AKE	Д288	21834
1.7	04.92- 96	SUM	Д816	21601			
1.8	11.95-	SUM	Д816	21601			
2.0	04.92- 96	SUM	Д816	21601			
2.0 D	10.94-09.97	SUM	Д816	21601			
2.0 D 13" WHEELS	94- 96	AKE	Д404	20870			
2.0 D 14" WHEELS	94- 96	AKE	Д445	21372			
		AKE	Д404	20870			
2.0 GTI	04.92- 96		или				
		SUM	Д816	21601			
2.0 GTI 16V	03.94- 96	SUM	Д816	21601	AKE	Д288	21834
<b>Celica</b>							
1.6	09.85-02.90	AKE	Д404	20870			
1.6	08.90- 94	AKE	Д404	20870	AKE	Д288	21834
1.6 GT	78- 82	AKE	Д404	20870			
1.8 I 16V	94-	SUM	Д816	21601	AKE	Д288	21834
2.0	01.88-12.89	AKE	Д404	20870			
2.0	03.90- 94	AKE	Д404	20870	AKE	Д288	21834
2.0 GT	12.85-08.90	AKE	Д404	20870			
2.0 GT 4WD	01.88-12.89						
2.0 GTI CABRIO	10.91- 92	AKE	Д445	21372			
2.0 GTI CABRIO	92- 94	AKE	Д404	20870	AKE	Д288	21834
<b>Corolla</b>							
1.3	12.79- 83	SUM	Д646	20703			
1.3 EXC. ST. WAGON	03.83-06.92	AKE	Д404	20870			
1.3 ST. WAGON	08.83-12.87	SUM	Д646	20703			
1.4 XLI 16V	07.92-	SUM	Д816	21601			
1.4 VVTI (ZZE120)	11.01-	LUC	Д201		LUC	Д489	
1.4 D4d (NDE120)	06.04-	LUC	Д201		LUC	Д489	
1.4 VVTI ESTATE/WAGON (ZZE120)	08.02-	LUC	Д201		LUC	Д489	
1.4 ESTATE/WAGON (NDE120)	06.04-	LUC	Д201		LUC	Д489	
1.6	80-01.83	SUM	Д646	20703			
1.6	83- 92	AKE	Д404	20870			
1.6 GTI	07.87-06.92	AKE	Д404	20870			
1.6 I	88- 91						
1.6 SI	07.92-	SUM	Д816	21601			
1.6 XLI 4WD TERCEL	05.88- 92	AKE	Д404	20870			
1.6 16V GT	03.85-12.87	AKE	Д404	20870			
1.6 VVTI (ZZE121)	11.01-	LUC	Д201		LUC	Д489	
1.6 VVTI ESTATE/WAGON (ZZE121)	08.02-	LUC	Д201		LUC	Д489	
1.8 D	01.82- 87	SUM	Д646	20703			
1.8 DX	08.83-06.92	AKE	Д404	20870			
1.8 I	93- 95	SUM	Д816	21601			
1.8 VAN	88- 90	AKE	Д404	20870			
1.8 16V 4WD	95-	SUM	Д816	21601			
1.8 VVTI (ZZE123)	11.01-05.04	LUC	Д201		LUC	Д489	
1.8 (ZZE123)	06.04-	LUC	Д201		LUC	Д489	



							
		i	DAFMI	W.V.A	i	DAFMI	W.V.A

2.0 D	07.92-	SUM	Д816	21601			
2.0 D4d (CDE120)	11.01-	LUC	Д201		LUC	Д489	
2.0 D4d ESTATE/WAGON (CDE120)	11.01-	LUC	Д201		LUC	Д489	
<b><i>Corolla Verso</i></b>							
1.6 VVTI (ZNR10)	03.04-	BOSCH	Д126	23480/ 23481/ 23768	BOSCH	Д361	
1.8 VVTI (ZNR11)	03.04-	BOSCH	Д126	23480/ 23481/ 23768	BOSCH	Д361	
2.0 D4d (CUR10)	02.04-08.05	BOSCH	Д126	23480/ 23481/ 23768	BOSCH	Д361	
<b><i>Corona</i></b>							
1.5	88- 92	AKE	Д404	20870			
1.6	88- 92	AKE	Д404	20870			
1.6 I	88- 92	AKE	Д404	20870			
1.8 I	88- 92	AKE	Д404	20870			
2.0 D	88- 92	AKE	Д404	20870			
<b><i>Hi-Ace (light commercial)</i></b>							
2.0	89-09.95	SUM	Д183	21689			
2.4 D	89-09.95	SUM	Д183	21689			
<b><i>Hi-Lux (light commercial)</i></b>							
1.8	12.82-07.87	SUM	Д183	21689			
2.0	12.82-08.93	SUM	Д183	21689			
2.0 4WD	12.83- 88	SUM	Д974	20852			
2.2 D	78- 84	SUM	Д974	20852			
2.2 4WD	87- 88	SUM	Д974	20852			
2.2 4x4 (YN106)	08.88-08.94	SUM	Д210	21679/ 21680/			
2.2 4x4 (YN110)	08.88-08.94	SUM	Д210	21681/ 21785			
2.4 D	12.82-08.93	SUM	Д183	21689			
2.4 D	89-	SUM	Д172	21775			
2.4 D 4WD	01.85-10.88	SUM	Д974	20852			
2.4 D 4WD	89-	SUM	Д172	21775			
2.4 4x4 (RN106/RN110)	08.94-07.97	SUM	Д210				
2.4 4x4 (RZN168/RZN173)	08.97-07.01	SUM	Д210	21679/			
2.4 4x4 (LN108/LN110)	08.88-07.97	SUM	Д210	21680/			
2.4 4x4 (LN105)	08.88-07.97	SUM	Д210	21681/ 21785			
2.4 4x4 (LN165/LN170)	08.98-07.01	SUM	Д210				
2.5 D4d 4x4 (KDN165/KDN170)	08.01-	SUM	Д210				
<b><i>Land cruiser</i></b>							
2.4	85- 92	SUM	Д974	20852			
2.4 D	85- 93	SUM	Д974	20852			
2.4 I	90-	SUM	Д974	20852			
2.4 TD	86- 90	SUM	Д974	20852			
2.4 (RJ70/RJ73)	01.90-05.93	SUM	Д210	21679/			
2.4 W/ABS (RJ70/RJ73)	01.90-03.96	SUM	Д210	21680/			
2.4 TD (LJ77)	04.90-05.93	SUM	Д210	21681/ 21785			
2.4 TD W/ABS (LJ77)	04.90-04.94	SUM	Д210				
2.5 D	85-	SUM	Д974	20852			
2.5 TD	85-	SUM	Д974	20852			
2.5 TDI	88- 93	SUM	Д974	20852			
3.0 D	75 84	SUM	Д974	20852			

# Тормозные колодки для автомобилей иностранного производства

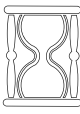

		i	DAFMI	W.V.A	i	DAFMI	W.V.A
3.0 D	05.93-	SUM	Д974	20852			
3.0 TD	93-	SUM	Д974	20852			
3.0 TD (KZJ70/KZJ73)	01.90-03.96	SUM	Д210	21679/ 21680/			
3.0 TD W/ABS (KZJ70/KZJ73)	01.90-03.96	SUM	Д210	21681/ 21785			
3.4 D	80- 85	SUM	Д974	20852			
3.5 D	89-	SUM	Д974	20852			
3.5 (PZJ70/PZJ73/PZJ75)	01.90-08.92	SUM	Д210	21679/ 21680/ 21681/ 21785			
3.5 W/ABS (PZJ70/PZJ73)	01.90-08.92	SUM	Д210				
4.0	85- 92	SUM	Д974	20852			
4.0 D ST. WAGON 60	80- 87	SUM	Д974	20852			
LAND CRUISER 4.0 TD	87- 90	SUM	Д974	20852			
4.2	10.81-08.82	SUM	Д974	20852			
4.2 D	92- 93	SUM	Д172	21775			
4.2 ST. WAGON 60	80- 84	SUM	Д974	20852			
4.2 TD	92-	SUM	Д172	21775			
4.2 TD ST. WAGON 80	89-	SUM	Д974	20852			
4.2 TD (HZJ73/HZJ75)		SUM	Д210				
4.2 TD W/ABS (HZJ73/HZJ75)		SUM	Д210	21679/ 21680/			
4.2TD/TDIW/ABS(HZJ80/HZJ73/HZJ75)	04.90-12.97	SUM	Д210	21681/ 21785			
4.5 24V ST. WAGON 80	95-	SUM	Д172	21775			
4.5 (FZJ80)	02.95-12.97	SUM	Д210	21679/ 21680/ 21681/ 21785			
<b><u>Land cruiser 70</u></b>							
4.2 (HZJ70/HZJ73)	04.96-07.99	SUM	Д210	21679/ 21680/ 21681/ 21785			
4.2 (HZJ75)	04.96-07.99	SUM	Д210	21679/ 21680/ 21681/ 21785			
<b><u>Land cruiser 90</u></b>							
LAND CRUISER 90 ALL MODELS	04.96-08.02	SUM	Д210	21679/ 21680/ 21681/ 21785			
<b><u>Land cruiser 300</u></b>							
3.0 TD (KZJ90/KZJ95)	04.96-07.00	SUM	Д210				
3.0 D4d (KDJ90/KDJ95)	08.00-08.02	SUM	Д210	21679/ 21680/			
3.4 TD (VZJ95)	04.96-07.00	SUM	Д210	21681/ 21785			
3.4 TD (VZJ90)	04.96-08.02	SUM	Д210				

							
		i	DAFMI	W.V.A	i	DAFMI	W.V.A

<b>Land cruiser 400</b>							
4.2	(HZJ70/HZJ73/HZJ77/HZJ79)	04.96-07.99	SUM	Д210	21679/ 21680/ 21681/21785		
4.2	(HZJ70/HZJ73)	04.96-07.99	SUM	Д210	21679/ 21680/ 21681/21785		
<b>Land cruiser 450</b>							
4.5	(FZJ80)	08.92-12.97	SUM	Д210	21679/ 21680/ 21681/21785		
<b>Land cruiser Colorado</b>							
	LANDCRUISER COLORADO ALL MODELS	04.96-08.02	SUM	Д210	21679/ 21680/ 21681/21785		
<b>Paseo</b>							
1.3 I 16V		96-	AKE	Д404	20870		
1.5 I		91- 96	AKE	Д404	20870		
1.5 I 16V		96-	AKE	Д404	20870		
<b>Picnic</b>							
2.0		09.96-	AKE	Д816	21601		
2.2 D		97-	AKE	Д816	21601		
<b>Rav 4</b>							
	RAV 4 ALL MODELS	04.94-	AKE	Д816	21601		
	1.8 VVTI 4drs/FWD (ZCA26)	05.00-	AKE	Д215	23585	AKE	Д495
	1.8 VVTI 2drs/FWD (ZCA25/ZCA26)	05.00-	AKE	Д215	23585	AKE	Д495
	2.0 (ACA20)	05.00-	AKE	Д215	23585		
	2.0 (ACA20/ACA21)	05.00-	AKE	Д215	23585	AKE	Д495
	2.0 D4d 2drs (CLA20)	06.00-	AKE	Д215	23585		
	2.0 D4d 4drs (CLA21)	06.00-	AKE	Д215	23585	AKE	Д495
<b>Starlet</b>							
1.3		90- 96	AKE	Д404	20870		
1.3 I		90- 96	AKE	Д404	20870		
<b>Tercel</b>							
1.3		08.82-02.85	AKE	Д404	20870		
1.5 I		08.82-01.88	AKE	Д404	20870		

## VOLKSWAGEN

<b>Beetle New</b>							
	BEETLE NEW ALL MODELS	01.98-	KH	Д137	21974		
<b>Bora</b>							
1.4		04.98-	KH	Д137	21974	LUC	Д481 20961
1.6		04.98-	KH	Д137	21974	LUC	Д481 20961
1.8		04.98-	KH	Д137	21974	LUC	Д481 20961
1.9 TDi		04.98-	KH	Д137	21974	LUC	Д481 20961
2.0		04.98-	KH	Д137	21974	LUC	Д481 20961
2.3 V5		04.98-	ATE	Д957	20676	LUC	Д481 20961
3.2 Rsi 4x4		07.00-	ATE	Д957И2	23392	LUC	Д481 20961
<b>Corrado</b>							
1.8 I 16V		88- 90	LUC	Д332	20669	LUC	Д653 20960





# Тормозные колодки для автомобилей иностранного производства

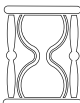

		i	DAFMI	W.V.A	i	DAFMI	W.V.A

1.8 I 16V	90- 92	LUC	Д332 или Д884	20669 20168	LUC	Д653	20960
1.8 I ALL MODELS	88- 89	LUC	Д884	20168	LUC	Д653	20960
1.8 I ALL MODELS	90- 95	LUC	Д332	20669	LUC	Д653	20960
1.8 I G60	90- 95	LUC	Д332	20669	LUC	Д653	20960
1.8 I	88- 91	LUC	Д327	20669			
1.8 I	88- 91	LUC	Д885	20168	LUC	Д653	20960
2.0 I 16V	91- 96	LUC	Д884	20168	LUC	Д653	20960
2.9 VR6	88- 89	LUC	Д884	20168	LUC	Д653	20960
2.9 VR6	90- 95	LUC	Д327	20669	LUC	Д653	20960
<b><u>Golf I</u></b>							
1.1	08.74-12.83	ATE	Д608	20228	VAG	ДА366	
1.3	09.79-12.83	ATE	Д608	20228	VAG	ДА366	
		ATE	Д598	20228			
1.5	08.77-03.84		или		VAG	ДА366	
		KH	Д366	20888			
1.5 D	08.76-07.80	ATE	Д608	20228	VAG	ДА366	
		ATE	Д598	20228			
1.6	08.76-07.78		или		VAG	ДА366	
		KH	Д366	20888			
1.6	08.78- 81	KH	Д366	20888	VAG	ДА366	
1.6 D	08.81-07.83	ATE	Д608	20228	VAG	ДА366	
1.6 D VAN	82- 84	KH	Д368	20889	VAG	ДА366	
1.6 GTI	08.75-07.78	ATE	Д608	20228	VAG	ДА366	
1.6 GTI	08.78-07.82	KH	Д366	20888	VAG	ДА366	
1.6 TD	03.82-07.83	KH	Д366	20888	VAG	ДА366	
1.8 GTI	08.82-07.83	KH	Д364	20887	VAG	ДА366	
<b><u>Golf II</u></b>							
1.0	08.83- 92	KH	Д368	20889	VAG	ДА366	
1.1 GL CABRIO	04.79-07.83	KH	Д366	20888	VAG	ДА366	
1.3	08.83- 92	KH	Д368	20889	VAG	ДА366	
1.3 CABRIO	08.79-07.86	KH	Д366	20888	VAG	ДА366	
1.5 CABRIO	79-07.83	KH	Д366	20888	VAG	ДА366	
1.6	08.83- 92	KH	Д366	20888	VAG	ДА366	
1.6 CABRIO	08.83-06.90	KH	Д366	20888	VAG	ДА366	
1.6 D	08.83- 91	KH	Д366	20888	VAG	ДА366	
1.6 GLI CABRIO	09.79-07.82	KH	Д364	20887	VAG	ДА366	
1.6 TD	08.83- 91	KH	Д366	20888	VAG	ДА366	
1.8	01.84-10.91	KH	Д366	20888	VAG	ДА366	
1.8 CABRIO	08.82- 93	KH	Д364	20887	VAG	ДА366	
1.8 GTI	03.84- 91	KH	Д364	20887	LUC	Д653	20960
1.8 GTI 16V	01.87-12.89	LUC	Д332	20669	LUC	Д653	20960
1.8 GTI 16V	01.90- 92	LUC	Д884	20168	LUC	Д653	20960
1.8 GTI G60	10.89-12.91	LUC	Д885	20168	LUC	Д653	20960
1.8 GTI G60 SYNCRO	09.89-12.89	LUC	Д327	20669	LUC	Д653	20960
1.8 GTI G60 SYNCRO	01.90-07.91	LUC	Д885	20168	LUC	Д653	20960
1.8 SYNCRO	02.86- 91	LUC	Д332	20669	LUC	Д653	20960
1.8 SYNCRO 98PS	08.88-12.91	KH	Д366	20888	LUC	Д653	20960
1.8 VENTILATED DISC	01.84-10.91	KH	Д364	20887	LUC	Д653	20960
<b><u>Golf III</u></b>							
1.4	10.91-09.97	KH	Д366 или Д158	20888 21866	ATE	ДА884	



							
		i	DAFMI	W.V.A	i	DAFMI	W.V.A

1.6	10.92-09.97	KH	Д366 или Д158	20888 21866	ATE LUC	ДА884 или Д653	20960
1.6 VARIANT	12.93-02.99	KH	Д366	20888	ATE LUC	ДА884 или Д653	20960
1.8	10.91-09.97	KH	Д366 или Д884	20888	ATE	ДА327 или ДА884	
1.8 CABRIO	09.93-	LUC	Д885	20168	ATE ATE	ДА327 или ДА884	
1.8 SYNCRO	01.93-09.97	KH	Д366	20888	ATE ATE	ДА327 или ДА884	
1.8 VARIANT	08.93-02.99	LUC	Д885	20168	ATE ATE	ДА327 или ДА884	
1.8 VARIANT VENTILATED DISC	08.93-02.99	LUC	Д884	20168	ATE	ДА327 или ДА884	
1.8 VARIANT W/ABS	08.93-02.99	LUC	Д885	20168	LUC	Д653	20960
1.8 VARIANT W/ABS VENTILATED DISC	08.93-02.99	LUC	Д884	20168	LUC	Д653	20960
1.8 W/ABS	10.91-09.97	KH	Д366 или Д884	20888	LUC	Д653	20960
1.9 D	10.91- 92	KH	Д366	20888	ATE	ДА884	
1.9 D	93-09.97	KH	Д158	21866	ATE	ДА884	
1.9 D TDI CABRIO	08.95-	LUC	Д885	20168	ATE	ДА884	
1.9 D VARIANT	08.93-02.99	LUC	Д885	20168	ATE	ДА884	
1.9 TD	10.91- 92	KH	Д366	20888	ATE	ДА884	
1.9 TD	93-09.97	KH	Д158	21866	ATE	ДА884	
1.9 TD VAN	91-02.99	LUC	Д885	20168	ATE	ДА884	
1.9 TD VARIANT	12.93-02.99	LUC	Д885	20168	ATE	ДА884	
1.9 TDI	08.93- 96	LUC	Д885	20168	ATE LUC	ДА884 или Д653	20960
1.9 TDI	96-09.97	ATE	Д957	20676	ATE LUC	ДА884 или Д653	20960
1.9 TDI VARIANT	12.93-02.99	LUC	Д885	20168	ATE LUC	ДА884 или Д653	20960
2.0 CABRIO	09.93-04.98	LUC	Д884	20168	ATE	ДА884	
2.0 GL AUTOMATIC	10.92-09.97	LUC	Д884	20168	LUC	Д653	20960
2.0 GTI	10.91-09.97	LUC	Д884	20168	LUC	Д653	20960
2.0 GTI 16V	03.92-07.95	LUC	Д885	20168	LUC	Д653	20960
2.0 VARIANT	08.93-02.99	LUC	Д884	20168	LUC	Д653	20960
2.8 VR6	93-09.97	LUC	Д885	20168	LUC	Д653	20960
2.9 VR6 SYNCRO	94-09.97	LUC	Д885	20168	LUC	Д653	20960
<b><i>Golf IV</i></b>							
1.4	09.97-03.98	ATE	Д158 или Д177	21866 21866	LUC	Д481	20961

# Тормозные колодки для автомобилей иностранного производства

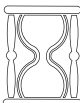

		i	DAFMI	W.V.A	i	DAFMI	W.V.A
1.4 Variant	04.97-03.98	ATE	Д366	20888	LUC	Д481	20961
1.4 16V	10.97-	KH	Д137	21974	LUC	Д481	20961
1.6 Saloon/Estate	04.97-03.98	ATE	Д158 или	21866	LUC	Д481	20961
		ATE	Д177	21866			
1.6 Variant	97-	LUC	Д884	20168	LUC	Д481	20961
		LUC	или Д885	20168	LUC	Д481	20961
1.6	04.98-	ATE	Д137	21974	LUC	Д481	20961
		ATE	Д158	21866			
1.8	09.97-03.98	или			LUC	Д481	20961
		ATE	Д177	21866			
1.8	04.98-	ATE	Д137	21974	LUC	Д481	20961
		LUC	Д884	20168			
1.8 Saloon/Estate	04.97-03.98	или			LUC	Д481	20961
		LUC	Д885	20168			
1.8 Variant	09.97-02.99	ATE	Д366	20888	LUC	Д481	20961
1.8 Turbo	04.98-	ATE	Д957	20676	LUC	Д481	20961
1.8i T	05.99-	ATE	Д957И2	23392	LUC	Д481	20961
1.9 D/TD	09.97-03.98	ATE	Д158	21866	LUC	Д481	20961
1.9 D/TD Estate	09.97-04.99	ATE	Д884	20168	LUC	Д481	20961
1.9 SDi	04.98-	ATE	Д137	21974	LUC	Д481	20961
1.9 TDi	04.98-	ATE	Д137	21974	LUC	Д481	20961
1.9 TDi	05.99-	ATE	Д957И2	23392	LUC	Д481	20961
2.0	09.97-04.98	ATE	Д884	20168	LUC	Д481	20961
2.0 I 16V	05.98-	ATE	Д137	21974	LUC	Д481	20961
2.0 I GTi 16V	09.97-04.98	ATE	Д885	20168			
		или	-		LUC	Д481	20961
2.0 Mk.V, FSI	10.03-07.04	ATE	Д194		LUC	Д481	20961
2.0 Mk.V, GTI	09.04-	ATE	Д194				
2.0 Mk.V	10.03-12.03	ATE	Д194	23587/			
2.0 Mk.V	01.04-	ATE	Д194	23588/ 23589	LUC	Д481	20961
2.0 FSI PLUS	05.05-	ATE	Д194		LUC	Д481	20961
2.0 TDI PLUS	10.04-	ATE	Д194		LUC	Д481	20961
2.3 I VR5	12.97-	ATE	Д957	20676	LUC	Д481	20961
2.3i VR5	05.99-	ATE	Д957И2	23392	LUC	Д481	20961
2.8i VR6	05.99-	ATE	Д957И2	23392	LUC	Д481	20961
<b><i>Jetta I</i></b>							
1.1	01.81-07.83	ATE	Д608	20228	VAG	ДА366	
1.3	08.79-01.84	ATE	Д608	20228	VAG	ДА366	
1.5	08.79- 81	KH	Д366	20888	VAG	ДА366	
1.5 D	79- 80	ATE	Д608	20228	VAG	ДА366	
1.6	05.81-01.84	KH	Д366	20888	VAG	ДА366	
1.6 D	08.80-12.83	ATE	Д608	20228	VAG	ДА366	
1.6 TD	08.82-01.84	KH	Д366	20888	VAG	ДА366	
1.6 VENTILATED DISC	08.79-07.82	KH	Д364	20887	VAG	ДА366	
<b><i>Jetta II</i></b>							
1.0	10.85- 91	KH	Д368	20889	ATE	ДА366	
1.3	01.84 92	KH	Д368	20889	ATE	ДА366	
1.6	01.84- 92	KH	Д366	20888	ATE	ДА366	
1.6 D	01.84- 91	KH	Д368	20889	ATE	ДА366	
1.6 TD	01.84- 91	KH	Д366	20888	ATE	ДА366	
1.6 O/FSI	08.05-				LUC	Д203	23914
1.8	01.87-06.90	KH	Д366	20888	ATE	ДА366	

							
		i	DAFMI	W.V.A	i	DAFMI	W.V.A



1.8 GT	01.84- 91	KH	Д364	20887	LUC	Д653	20960
1.8 GTX 16V 129PS	02.86-10.88	KH	Д364	20887	LUC	Д653	20960
1.8 GTX 16V 129PS	11.88-10.91	LUC	Д884	20168	ATE	ДА366	
1.8 GTX 16V 139PS	10.87-12.89	LUC	Д332	20669	LUC	Д653	20960
1.8 GTX 16V 139PS	01.90- 91	LUC	Д884	20168	ATE	ДА366	
1.8 SYNCRO	08.88- 91	KH	Д366	20888	ATE	ДА366	
1.8 VENTILATED DISC	09.84- 91	KH	Д364	20887	ATE	ДА366	
1.8 W/ABS	01.87-06.90	KH	Д366	20888	LUC	Д653	20960
1.8 W/ABS VENTILATED DISC	09.84- 91	KH	Д364	20887	LUC	Д653	20960
1.9 TD	08.05-				LUC	Д203	23914
2.0	09.05-	ATE	Д194	23587/	LUC	Д203	23914
2.0 FSI	10.05-	ATE	Д194	23588/ 23589	LUC	Д203	23914
2.0 TDI	09.05-	ATE	Д194		LUC	Д203	23914
<b><u>Lupo</u></b>							
1.0	05.98-	ATE	Д157	21866	ATE	ДА366 или ДА884	
1.4	05.98-	ATE	Д157	21866	ATE	ДА366	
1.6 GTI	04.02-				LUC	Д653	20960
<b><u>Passat I</u></b>							
1.3	73-09.80	ATE	Д608	20228			
		LUC	Д253	20574			
1.5 D	09.78-09.80		или Д608	20228			
1.5 D	02.80-07.80	ATE	Д608	20228			
1.6	08.75-07.79	KH	Д366	20888			
1.6	08.79-09.80	ATE	Д608	20228			
1.6 GLI	08.79-09.80	KH	Д366	20888			
			Д364	20887			
<b><u>Passat II</u></b>							
1.3	08.80-07.81	ATE	Д608	20228	VAG	ДА366	
1.3	08.81-07.87	KH	Д366	20888	VAG	ДА366	
1.6	08.80- 88	KH	Д366	20888	VAG	ДА366	
1.6 D	08.80- 88	KH	Д366	20888	VAG	ДА366	
1.6 TD	08.82- 88	KH	Д366	20888	VAG	ДА366	
1.8	01.83- 88	KH	Д366	20888	ATE	ДА885	
1.8 SYNCRO	86- 88	LUC	Д884	20168	LUC	Д653	20960
1.8 SYNCRO VARIANT	01.86- 88	LUC	Д332	20669	LUC	Д653	20960
1.9	08.80-07.83	KH	Д364	20887	ATE	ДА885	
2.0	07.83- 88	KH	Д364	20887	ATE	ДА885	
2.0 GT SYNCRO VARIANT	85- 88	KH	Д364	20887	LUC	Д653	20960
2.0 SYNCRO GT VARIANT	02.85- 88	LUC	Д332	20669	LUC	Д653	20960
2.0 SYNCRO S/CH	08.84-07.85	LUC	Д884	20168	LUC	Д653	20960
2.0 SYNCRO VARIANT	84- 85	LUC	Д332	20669	LUC	Д653	20960
2.2	02.85- 88	KH	Д364	20887	ATE	ДА885	
2.2 GT	01.85- 88	LUC	Д332	20669	LUC	Д653	20960
2.2 SYNCRO S/CH	01.87-12.88	LUC	Д884	20168	LUC	Д653	20960
<b><u>Passat III</u></b>							
1.6	04.88- 94	KH	Д366	20888	ATE	ДА327	
1.6 VARIANT	01.90-12.96	LUC	Д885	20168	ATE	ДА327	
1.6 TD	08.88-12.89	LUC	Д327	20669	ATE	ДА327	
1.6 TD	01.90- 94	LUC	Д885	20168	ATE	ДА327	
1.6 W/ABS	04.88- 94	LUC	Д885	20168	ATE	ДА327	
1.8	08.88-12.89	LUC	Д327	20669	ATE	ДА327	
1.8	01.90- 96	LUC	Д885	20168	ATE	ДА327	
1.8 VARIANT	04.88-12.89	LUC	Д327	20669	ATE	ДА327	

# Тормозные колодки для автомобилей иностранного производства



		i	DAFMI	W.V.A	i	DAFMI	W.V.A

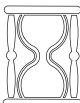

1.8 VARIANT	04.88-12.89	LUC	Д332	20669	LUC	Д653	20960
1.8 VARIANT	01.90-07.90	LUC	Д884	20168	ATE	ДА327	
1.8 VENTILATED DISC	02.88-12.89	LUC	Д332	20669	LUC	Д653	20960
1.8 VENTILATED DISC	01.90- 94	LUC	Д884	20168	LUC	Д653	20960
1.8 16V	88- 94	LUC	Д884	20168	LUC	Д653	20960
1.8 G60	89- 94	LUC	Д885	20168	LUC	Д653	20960
1.8 SYNCRO GT G60	09.88-12.89	LUC	Д327	20669	LUC	Д653	20960
1.8 SYNCRO GT G60	01.90- 94	LUC	Д885	20168	LUC	Д653	20960
1.9 D	12.88-12.89	LUC	Д327	20669	ATE	ДА327	
1.9 D	01.89- 93	LUC	Д885	20168	ATE	ДА327	
1.9 TD	88- 96	LUC	Д885	20168	ATE	ДА327	
1.9 TDI	09.93- 96	LUC	Д151	21866	LUC	Д653	20960
2.0	01.90-07.97	LUC	Д884	20168	LUC	Д653	20960
2.0 VARIANT	03.90- 93	LUC	Д332	20669	LUC	Д653	20960
2.0 VARIANT	93- 96	LUC	Д884	20168	LUC	Д653	20960
2.0 115PS	93- 96	LUC	Д151	21866	LUC	Д653	20960
2.0 GT 16V	08.88-12.89	LUC	Д332	20669	LUC	Д653	20960
2.0 GT 16V	01.90- 96	LUC	Д884	20168	LUC	Д653	20960
2.0 GT 16V VARIANT	08.88- 94	LUC	Д884	20168	LUC	Д653	20960
2.0 GT 16V VARIANT	93- 96	LUC	Д151	21866	LUC	Д653	20960
2.0 SYNCRO	07.90-08.93	LUC	Д884	20168	LUC	Д653	20960
2.8 VR6	05.91- 96	LUC	Д885	20168	LUC	Д653	20960
2.8 GT VR6 VARIANT	08.91- 93	LUC	Д885	20168	LUC	Д653	20960
2.8 GT VR6 VARIANT	93- 96	KH	Д957	20676	LUC	Д653	20960
<b>Passat IV</b>							
1.6 Saloon	10.96-	LUC	Д161	20887	LUC	Д369	20668
1.6 Estate	10.97-	LUC	Д161	20887	LUC	Д481	20961
1.8 Saloon	10.96-	LUC	Д161	20887	LUC	Д481	20961
1.8 Saloon Turbo 20V	10.96-	ATE	Д957	20676	LUC	Д481	20961
		LUC	Д885	20168			
1.8 Estate	10.97-	LUC	или Д161	20887	LUC	Д481	20961
1.9 TDI Saloon	10.96-	LUC	Д161	20887	LUC	Д481	20961
		ATE	Д957	20676			
1.9 TDI Estate	10.97-	LUC	или Д885	20168	LUC	Д481	20961
		LUC	или Д161	20887			
1.9 TDI Saloon	10.97-	ATE	Д957	20676	LUC	Д481	20961
		LUC	или Д885	20168			
2.3 VR5	01.97-	ATE	Д957	20676	LUC	Д481	20961
2.5 TDI	12.98-	ATE	Д957	20676	LUC	Д481	20961
		ATE	Д957	20676			
2.8 V6 30V	12.98-	LUC	или Д161	20887	LUC	Д481	20961
<b>Passat V</b>							
ALL MODELS	00-	ATE	Д957	20676			
<b>Passat VI</b>							
1.6 Mk.VI, O/FSI	04.05-	ATE	Д194	23587/ 23588/ 23589	LUC	Д203	23914
1.9 Mk.VI, TDI	04.05-	ATE	Д194	23587/ 23588/ 23589	LUC	Д203	23914

							
		i	DAFMI	W.V.A	i	DAFMI	W.V.A

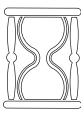

2.0 Mk.VI, FSI	04.05-	ATE	Д194	23587/ 23588/ 23589	LUC	Д203	23914
2.0 Mk.VI, O/FSI 4x4	04.05-				LUC	Д203	23914
3.2 Mk.VI, FSI	09.05-				LUC	Д203	23914
<b><u>Polo I</u></b>							
0.9	04.75-09.81	ATE	Д608	20228			
1.0	10.81-12.84	ATE	Д608	20228			
1.0	01.85- 90	KH	Д368	20889			
1.1	04.75- 85	ATE	Д608	20228			
1.1 VAN	85- 94	ATE	Д608	20228			
1.3	04.75-12.84	ATE	Д608	20228			
1.3	12.85- 90	KH	Д368	20889			
1.3 D	87- 90	KH	Д368	20889			
1.3 I	86- 90	ATE	Д608	20228			
<b><u>Polo II</u></b>							
1.0	90- 94	KH	Д364	20887	ATE	ДА366	
1.0	94-	KH	Д368	20889	ATE	ДА366	
1.3	90- 94	KH	Д364	20887	ATE	ДА366	
1.3	94-	KH	Д368	20889	ATE	ДА366	
1.4	09.95-		или Д368	20889	ATE	ДА366	
1.4 16V CLASSIC	96-	LUC	Д151	21945			
1.4 CLASSIC	09.95-	KH	Д364	20887	ATE	ДА366	
1.4 D	90- 94	KH	Д157	21866	ATE	ДА366	
1.6	94-	KH	Д364 или Д368	20887 20889	ATE	ДА366	
1.6 CLASSIC DISC 239X12	95-	KH	Д366	20888			
1.6 CLASSIC DISC 239X20	95-	LUC	Д151	21945	ATE	ДА366	
1.9 D	10.94-	KH	Д157	21866	ATE	ДА884	
		KH	Д177	21866	ATE	ДА884	
		KH	Д366	20888	ATE	ДА884	
<b><u>Santana</u></b>							
1.3	08.83-01.85	KH	Д366	20888	ATE	ДА366	
1.6	08.81-01.85	KH	Д366	20888	ATE	ДА366	
1.6 D	08.81-01.85	KH	Д366	20888	ATE	ДА366	
1.6 TD	08.82-01.85	KH	Д366	20888	ATE	ДА884	
1.8	01.83-01.85	KH	Д366	20888	ATE	ДА884	
1.9	08.81-07.83	KH	Д364	20887	ATE	ДА884	
2.0	08.83-01.85	KH	Д364	20887	ATE	ДА884	
<b><u>Scirocco</u></b>							
1.1	74-08.79	ATE	Д598	20228			
1.3	08.79-07.83	KH	Д366	20888	ATE	ДА366	
1.5	74-07.79	ATE	Д598	20228			
1.5	08.79-01.83	KH	Д366	20888	ATE	ДА366	
1.6	07.75-07.79	ATE	Д598	20228			
1.6	08.79-08.83	KH	Д366	20888	ATE	ДА366	
1.6 I	76-07.79	ATE	Д598	20228			
1.6 I	08.79-08.82	KH	Д364	20887	ATE	ДА366	
1.8	08.82- 92	KH	Д364	20887			
1.8 16V	11.85-12.89	LUC	Д332	20669	LUC	Д653	20960
1.8 16V	01.90-07.92	LUC	Д884	20168	LUC	Д653	20960

# Тормозные колодки для автомобилей иностранного производства

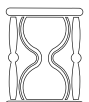

			
		i DAFMI W.V.A	i DAFMI W.V.A

<b>Sharan</b>							
1.8i T 20V, 1.9 TDi, 2.0i 16V	09.95-02.00				LUC	Д638	23224
1.8i T 20V, 1.9 TDi, 2.8i VR6 (16")	03.00-				LUC	Д638	23224
1.9 TDI	09.96-	ATE	Д957	20676	LUC	Д481	20961
2.0	09.95-	ATE	Д957	20676	LUC	Д481	20961
2.8 VR6	11.96-	ATE	Д957	20676	LUC	Д481	20961
2.8 VR6 SYNCRO	09.95-	ATE	Д957	20676	LUC	Д481	20961
<b>Touran</b>							
TOURAN ALL MODELS	02.03-	ATE	Д194	23587/ 23588/ 23589	LUC	Д203	23914
<b>Vento</b>							
1.4	01.92- 95	KH	Д366	20888	ATE	ДА884	
1.4	95-07.95	KH	Д158	21865	ATE	ДА884	
1.6	01.92- 95	KH	Д366	20888	ATE	ДА884	
1.6	95-07.97	KH	Д158	21866	ATE	ДА884	
1.6 16V	96-07.97	LUC	Д885	20168	LUC	Д653	20960
1.8	01.92-07.97	KH	Д366	20888	ATE	ДА884	
1.8 90PS	01.92-07.97	LUC	Д884	20168	LUC	Д653	20960
1.9 D	01.92- 95	KH	Д366	20888	ATE	ДА884	
1.9 D	95-07.97	KH	Д158	21866	ATE	ДА884	
1.9 TD	01.92-07.97	KH	Д366	20888	ATE	ДА884	
1.9 TDI	12.93-07.97	LUC	Д885	20168	LUC	Д653	20960
2.0	01.92-07.97	LUC	Д885	20168	LUC	Д653	20960
2.0 GTI 16V	03.92-07.97	LUC	Д885	20168	LUC	Д653	20960
2.8 VR6	01.92-07.97	LUC	Д885	20168	LUC	Д653	20960
<b>Caddy (light commercial)</b>							
1.4	01.96-	LUC	Д884 или Д151	20168 21945			
1.5	08.82- 93	KH	Д366	20888			
1.6	84- 93	KH	Д366	20888			
1.6	01.96-	LUC	Д885 или Д151	20168 21945	ATE	ДА327	
1.6		LUC	Д885	20168			
1.7 D	01.96-	LUC	Д151	21945	ATE	ДА327	
1.8	84- 93	KH	Д366	20888	ATE	ДА327	
1.8		LUC	Д885	20168			
1.9 D	01.96-	LUC	Д151	21945	ATE	ДА327	
1.4 Mk.III Lw735kg	02.04-	ATE	Д194		LUC	Д203	23914
1.4 Mk.III	02.04-	ATE	Д194		LUC	Д203	23914
1.6 Mk.III	02.04-	ATE	Д194		LUC	Д203	23914
1.9 Mk.III, TDI Lw735kg	02.04-	ATE	Д194	23587/ 23588/ 23589	LUC	Д203	23914
1.9 Mk.III, TDI	02.04-	ATE	Д194		LUC	Д203	23914
2.0 Mk.III, SDI Lw735kg	02.04-	ATE	Д194		LUC	Д203	23914
2.0 Mk.III, SDI	02.04-	ATE	Д194		LUC	Д203	23914
<b>Caravelle (light commercial)</b>							
1.6 D	85- 90	LUC	Д173	20979			
1.7 D	85- 90	LUC	Д173	20979			
1.8	90- 95	LUC	Д637 или Д763	20124 20652			

							
		i	DAFMI	W.V.A	i	DAFMI	W.V.A
1.9	85- 90	LUC	Д173 Д637	20979 20124			
1.9 D	90- 95	LUC	или Д763	20652			
1.9 TD	96-	LUC	Д142	21479			
2.0	95-	LUC	Д142	21479			
2.0 I	85- 90	LUC	Д173 Д637	20979 20124			
2.0 I	90- 95	LUC	или Д763	20652			
2.1 I	85- 90	LUC	Д173	20979			
2.4	96-	LUC	Д142 Д637	21479 20124			
2.4 D	90- 95	LUC	или Д763	20652			
2.4 D	95-	LUC	Д142	21479			
2.5 I	90- 95	LUC	Д763	20652			
2.5 I GL	93-	LUC	Д142	21479			
<b><u>LT (light commercial)</u></b>							
LT 28 ALL MODELS	04.75- 96	ATE	Д679	20341			
LT 28 ALL MODELS	97-	ATE	Д145	21576	ATE	Д147	21620
LT 31 ALL MODELS	04.75- 93	ATE	Д679	20341			
LT 35 ALL MODELS	04.75- 96	ATE	Д679	20341			
LT 35 ALL MODELS (Not 2.8 Tdi)	97-	ATE	Д145	21576	ATE	Д148	21592
LT 35 2.8 Tdi	97-	ATE	Д145	21576	BOSCH	Д167	23021
LT 40 ALL MODELS	78-04.96	ATE	Д679	20341			
LT 45 ALL MODELS	78-04.96	ATE	Д679	20341			
LT 46 ALL MODELS	12.96-	PER	Д146	29076	PER	Д146	29076
LT 50 ALL MODELS	12.82-04.96	ATE	Д679	20341			
LT 55 ALL MODELS	12.82- 93	ATE	Д679	20341			
<b><u>Taro (light commercial)</u></b>							
1.8 4WD	91-07.96	SUM	Д172	21775			
2.2 4WD	88-07.96	SUM	Д172	21775			
2.5 D 4WD	91-07.96	SUM	Д172	21775			
<b><u>Transporter/ Bus (light commercial)</u></b>							
T2 ALL MODELS	79- 91	LUC	Д173	20979			
T4 14" ALL MODELS	90-	LUC	Д637	20124			
T4 15" VENT.DISC ALL MODELS	90-	LUC	Д763	20652			
T4 15" N/VENT.DISC ALL MODELS	09.90-	LUC	Д142	21479			
<b><u>Transporter / Caravelle T4 (light commercial)</u></b>							
1.8, 1.9 D/TD/TDi, 2.0, 2.4 D, 2.5 D/TD/Tdi, 2.8 (15" wheels)	01.90-06.98	LUC	Д142	21479			
		LUC	или Д763	20652	ATE	Д492	21154
		ATE	или -				
1.8, 1.9 D/TD/TDi, 2.0, 2.4 D, 2.5, 2.5 D/TD/Tdi, 2.8, 2.8i VR6 (15" wheels)	06.98-	LUC	Д142	21479	LUC	Д638	23224
					ATE	Д492	21154
2.5 TDi , 2.8 TDi	01.96-				или LUC	Д638	23224
All models 16" wheels	01.99-	LUC	Д763	20652	LUC	Д638	23224





# Тормозные колодки для автомобилей иностранного производства



		i	DAFMI	W.V.A	i	DAFMI	W.V.A

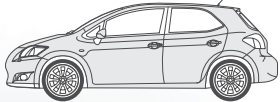
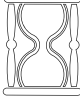

## VOLVO



<b>240-265</b>							
240 ALL MODELS	82-12.93	LUC	Д784	20200	ATE	Д602	20034
242 ALL MODELS	79- 81	LUC	Д784	20200	ATE	Д602	20034
244 ALL MODELS	09.74-08.82	LUC	Д784	20200	ATE	Д602	20034
245 ALL MODELS	76- 82	LUC	Д784	20200	ATE	Д602	20034
260 ALL MODELS	82- 85	LUC	Д784	20200	ATE	Д602	20034
262 ALL MODELS	07.78-07.82	LUC	Д784	20200	ATE	Д602	20034
264 ALL MODELS	74-07.82	LUC	Д784	20200	ATE	Д602	20034
265 ALL MODELS	74-07.82	LUC	Д784	20200	ATE	Д602	20034
<b>340-360</b>							
340 ALL MODELS	08.76- 91	LUC	Д253	20574			
343 ALL MODELS	12.79-08.85	LUC	Д253	20574			
345 ALL MODELS	09.81-09.92	LUC	Д253	20574			
360 ALL MODELS	09.82- 90	LUC	Д253	20574			
<b>440</b>							
1.6 I	91- 96	LUC	Д645	21216	ATE	Д511	21089
1.7	08.88-08.94	LUC	Д645	21216	ATE	Д511	21089
1.7 T SOLID DISC	08.88-04.96	LUC	Д645	21216	ATE	Д511	21089
1.8	07.91- 93	LUC	Д645	21216	ATE	Д511	21089
1.8 I	93-08.97	LUC	Д645	21216	ATE	Д511	21089
1.9 TD	94- 96	LUC	Д645	21216	ATE	Д511	21089
2.0	92- 94	LUC	Д645	21216	ATE	Д511	21089
2.0 I	93- 96	LUC	Д645	21216	ATE	Д511	21089
<b>460</b>							
1.6 I	93- 96	LUC	Д645	21216			
1.7	12.89- 91	LUC	Д645	21216			
1.7 T SOLID DISC	12.89- 96	LUC	Д645	21216	ATE	Д511	21089
1.8 GL	07.91- 93	LUC	Д645	21216			
1.8 I	93- 96	LUC	Д645	21216			
2.0 I	92- 96	LUC	Д645	21216			
<b>480</b>							
1.7 ES	08.87- 92	LUC	Д645	21216	ATE	Д511	21089
1.7 T SOLID DISC	01.90- 95	LUC	Д645	21216	ATE	Д511	21089
2.0	92- 95	LUC	Д645	21216	ATE	Д511	21089
<b>740</b>							
2.0	83- 91	LUC	Д736	20740	ATE	Д602	20034
2.0	01.89-12.91	BDX	Д739	21233	ATE	Д602	20034
2.0 I T	84-08.92	LUC	Д736	20740	ATE	Д602	20034
2.0 W/ABS	01.89-12.91	LUC	Д819	20163			
2.3	09.85- 92	LUC	Д736	20740	ATE	Д602	20034
2.3	01.89- 92	BDX	Д739	21233	ATE	Д602	20034
2.3 GLT 16V	88-08.92	LUC	Д736	20740			
		BDX	Д739	21233	ATE	Д602	20034
2.3 T	85- 90	LUC	Д736	20740	ATE	Д602	20034
2.3 T	01.89- 90	BDX	Д739	21233	ATE	Д602	20034
2.4 D	84-12.88	LUC	Д736	20740	ATE	Д602	20034
2.4 D	01.89-08.91	BDX	Д739	21233	ATE	Д602	20034
		LUC	Д736	20740			
2.4 TD INTERCOOLER	86- 90	LUC	Д736	20740	ATE	Д602	20034
		BDX	Д739	21233			
2.4 TD INTERCOOLER W/ABS	86- 90	LUC	Д819	20163			
<b>760</b>							
2.0 I T	84- 89	LUC	Д736	20740			

							
		i	DAFMI	W.V.A	i	DAFMI	W.V.A
2.0 IT	01.88- 89	BDX	Д739	21233			
2.3 T	84-08.90	LUC	Д736	20740			
2.3 T	01.88- 90	BDX	Д739	21233			
2.4 D	84- 90	LUC	Д736	20740			
2.4 D	01.88- 90	BDX	Д739	21233			
2.4 TD	84- 90	LUC	Д736	20740			
2.4 TD	01.88- 90	BDX	Д739	21233			
2.8	03.82-08.90	LUC	Д736	20740	ATE	Д602	20034
2.8	01.88-08.90	BDX	Д739	21233	ATE	Д602	20034
<b>780 Coupe</b>							
2.0 T	12.89-08.90	BDX	Д739	21233	ATE	Д602	20034
		LUC	Д736	20740			
2.0 IT	86- 89	BDX	или Д739	21233	ATE	Д602	20034
2.4 TDI	01.89-08.90	LUC	Д736	20740	ATE	Д602	20034
2.8 I	08.89-08.90	LUC	Д736	20740	ATE	Д602	20034
2.8 I	01.88-08.90	BDX	Д739	21233	ATE	Д602	20034
<b>850</b>							
2.0 I 10V	94- 96	ATE	Д176	21273			
2.0 I 16V	91- 96	ATE	Д176	21273			
2.0 I 20V	93- 96	ATE	Д176	21273			
2.4 I 10V	94- 96	ATE	Д176	21273			
2.4 I 20V	91- 96	ATE	Д176	21273			
2.5 TDI	95- 96	ATE	Д176	21273			
<b>940</b>							
2.0	07.91- 95	LUC	Д736 или Д739	20740 21233	ATE	Д602	20034
		LUC	Д736	20740			
2.0 IT	91-.95	BDX	или Д739	21233	ATE	Д602	20034
		LUC	Д736	20740			
2.0 W/ABS	07.91- 95	LUC	Д819	20163			
2.0 IT W/ABS	91-.95	LUC	Д819	20163			
		LUC	Д736	20740			
2.3	90- 95	BDX	или Д739	21233	ATE	Д602	20034
		LUC	Д736	20740			
2.3 IT	90- 93	BDX	или Д739	21233	ATE	Д602	20034
		LUC	Д736	20740			
2.3 W/ABS	90- 95	LUC	Д819	20163			
2.3 IT W/ABS	90- 93	LUC	Д819	20163			
		LUC	Д736	20740			
2.4 D	90- 95	BDX	или Д739	21233	ATE	Д602	20034
		LUC	Д736	20740			
2.4 TD	90- 95	BDX	или Д739	21233	ATE	Д602	20034
		LUC	Д736	20740			
2.4 D	90- 95	LUC	Д819	20163			
2.4 TD	90- 95	LUC	Д819	20163			
<b>960</b>							
2.3 IT	90- 97	LUC	Д736 или Д739	20740 21233	ATE	Д602	20034
		BDX	Д739	21233			
2.3 IT W/ABS	90- 97	LUC	Д819	20163			

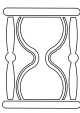

# Тормозные колодки для автомобилей иностранного производства

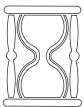

							
		i	DAFMI	W.V.A	i	DAFMI	W.V.A
2.4 D	90- 97	LUC	Д736 или Д739	20740 21233	ATE	Д602	20034
2.4 D	90- 97	BDX	Д819	20163			
2.4 TD	90- 91	LUC	Д736 или Д739	20740 21233	ATE	Д602	20034
2.4 TD	90- 91	BDX	Д819	20163			
2.4 TD INTERCOOLER	91- 97	LUC	Д736 или Д739	20740 21233	ATE	Д602	20034
2.4 TD INTERCOOLER	91- 97	BDX	Д819	20163			
3.0	90- 97	LUC	Д736 или Д739	20740 21233	ATE	Д602	20034
3.0	90- 97	BDX	Д819	20163			
<b><u>C 70</u></b>							
2.0 20V	97-	ATE	Д176	21273			
2.0 20V T	97-	ATE	Д176	21273			
2.3 20V T5	97-	ATE	Д176	21273			
2.4 20V T	97-	ATE	Д176	21273			
<b><u>S 40</u></b>							
1.6 16V	95- 97	LUC	Д169	21920			
1.8 16V	95- 97	LUC	Д169	21920			
1.9 TD	95- 97	LUC	Д169	21920			
2.0 16V	95- 97	LUC	Д169	21920			
<b><u>S 60</u></b>							
2.0 15"SW/16"SW	07.00-	ATE	Д230				
2.3 16"SW/17"SW	07.00-	ATE	Д230	23072/			
2.4 15"SW/16"SW	03.01-	ATE	Д230	23073/ 23074			
2.5 15"SW/16"SW	06.02-	ATE	Д230				
<b><u>S 70</u></b>							
2.0	97-	ATE	Д176	21273			
2.0 20V	97-	ATE	Д176	21273			
2.0 20V T	97-	ATE	Д176	21273			
2.3 20V T5	97-	ATE	Д176	21273			
2.4	97-	ATE	Д176	21273			
2.4 20V	97-	ATE	Д176	21273			
2.4 20V T	97-	ATE	Д176	21273			
2.5 TDI	97-	ATE	Д176	21273			
<b><u>S 80</u></b>							
S80 ALL MODELS	11.98-	ATE	Д230	23072/ 23073/ 23074			
<b><u>S 90</u></b>							
2.9 ALL MODELS	96-	LUC	Д819	20163			
<b><u>V 40</u></b>							
1.6 16V	95- 99	LUC	Д169	21920			
1.8 16V	95- 97	LUC	Д169	21920			
1.9 TD	95- 99	LUC	Д169	21920			
2.0 16V	95- 97	LUC	Д169	21920			
<b><u>V 70</u></b>							
2.0 FWD 16"SW	10.99-08.02	ATE	Д230				
2.3 AWD/FWD 16"SW	10.99-09.04	ATE	Д230	23072/			
2.4 AWD/FWD 5"SW	10.99-	ATE	Д230	23073/ 23074			
2.4 AWD 17"SW/FWD 16"SW	10.99-09.04	ATE	Д230				

							
		i	DAFMI	W.V.A	i	DAFMI	W.V.A

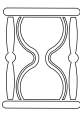
2.4 FWD 16"SW	06.01-08.02	ATE	Д230				
2.4 CROSS COUNTRY	10.99-06.03	ATE	Д230				
2.4 XC 16"SW	10.00-08.02	ATE	Д230	23072/ 23073/ 23074			
2.5 FWD 15"SW	11.96-03.02	ATE	Д230				
2.5 FWD 16"SW	10.99-10.01	ATE	Д230				
<b><u>V90</u></b>							
2.9 ALL MODELS	96-	LUC	Д819	20163			
<b><u>XC70</u></b>							
XC ALL MODELS	06.02-	ATE	Д230	23072/ 23073/ 23074			

							
		i	DAFMI	W.V.A	i	DAFMI	W.V.A

### ВАЗ

<b>ВАЗ 1111 "ОКА"</b>						
ВАЗ 1111 "ОКА" ВСЕ МОДИФИКАЦИИ	86-		Д131			
<b>ВАЗ 2101-2107</b>						
ВАЗ 2101-2107 ВСЕ МОДИФИКАЦИИ Кроме ВАЗ 2103	70-		Д656	20166		ДА656
ВАЗ 2103	70- 85		Д656	20166		ДА603
<b>ВАЗ 2108-2109 "САМАРА"</b>						
ВАЗ 2108-2109 "САМАРА" ВСЕ МОДИФИКАЦИИ	83-		Д743	21170		ДА140
<b>ВАЗ 2110</b>						
ВАЗ 2110 ВСЕ МОДИФИКАЦИИ	95-		Д140	21170		ДА140
<b>ВАЗ 2121 "НИВА"</b>						
ВАЗ 2121 "НИВА" ВСЕ МОДИФИКАЦИИ	76-		Д301	20660		ДА656
ВАЗ 2123 "CHEVROLET-NIVA"	02-		Д301	20660		ДА656

### ГАЗ

<b>ГАЗ 2410 "ВОЛГА"</b>						
ГАЗ 2410 "ВОЛГА" ВСЕ МОДИФИКАЦИИ	72- 85		ДА124			ДА124
<b>ГАЗ 3102 "ВОЛГА"</b>						
ГАЗ 3102 "ВОЛГА" ВСЕ МОДИФИКАЦИИ	87-		Д412			ДА124
<b>ГАЗ 3110 "ВОЛГА"</b>						
ГАЗ 3110 "ВОЛГА" ВСЕ МОДИФИКАЦИИ	96-		Д443			ДА124
<b>ГАЗ 3302 "ГАЗЕЛЬ"</b>						
ГАЗ 3302 "ГАЗЕЛЬ" ВСЕ МОДИФИКАЦИИ	94-		Д443			ДА443
<b>ГАЗ-3310 "ВАЛДАЙ"</b>						
ГАЗ-3310 "ВАЛДАЙ" ВСЕ МОДИФИКАЦИИ	01.04-		Д609			Д609

### ЗИЛ

<b>ЗИЛ 5301 "БЫЧОК"</b>						
ЗИЛ 5301 "БЫЧОК" ВСЕ МОДИФИКАЦИИ	96-		Д531			ДА531

### АЗЛК/ ИЖ



<b>М 2140</b>						
М 2140 ВСЕ МОДИФИКАЦИИ	70-		Д412			ДА412
<b>М 412</b>						
М 412 ВСЕ МОДИФИКАЦИИ	68-		Д412			ДА412
<b>М 2141</b>						
М 2141 ВСЕ МОДИФИКАЦИИ	83-		Д141			ДА141

### ЗАЗ

<b>ЗАЗ 1102 "Таврия"</b>						
ЗАЗ 1102 "Таврия" ВСЕ МОДИФИКАЦИИ	86-		Д110			ДА110
<b>ЗАЗ 1103 "Славута"</b>						
ЗАЗ 1103 "Славута" ВСЕ МОДИФИКАЦИИ	99-		Д110			ДА110
<b>УАЗ</b>						
ПАТРИОТ			Д221			

### БОГДАН

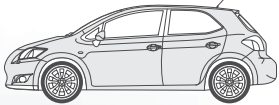
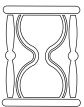
<b>БОГДАН (light commercial)</b>						
А092 (EURO-II)	01.95-		Д229			

							
		i	DAFMI	W.V.A	i	DAFMI	W.V.A

## "РЫБИНСКИЕ МОТОРЫ"

<b><u>СНЕГОХОД "Тайга"</u></b>							
СНЕГОХОД "Тайга" ВСЕ МОДИФИКАЦИИ	98-		P406				

## СП "ТАТРА-ЮГ"



<b><u>ТРАМВАЙ Т-3 М</u></b>							
ТРАМВАЙ Т-3 М	94-		ТК 0100.000			ТК 0100.000	

## ТРАКТОРА

<b><u>ЮМЗ-6</u></b>							
ЮМЗ-6 ВСЕ МОДИФИКАЦИИ	94-		45-3502040А-01				
<b><u>Т-150К</u></b>							
Т-150К ВСЕ МОДИФИКАЦИИ	72-		125.38.102А-01				

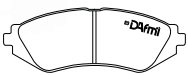
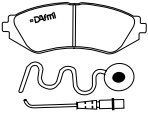

## КОМБАЙНЫ

<b><u>ДОН-1500</u></b>							
ДОН-1500 ВСЕ МОДИФИКАЦИИ	91-		3518020-45860-01				

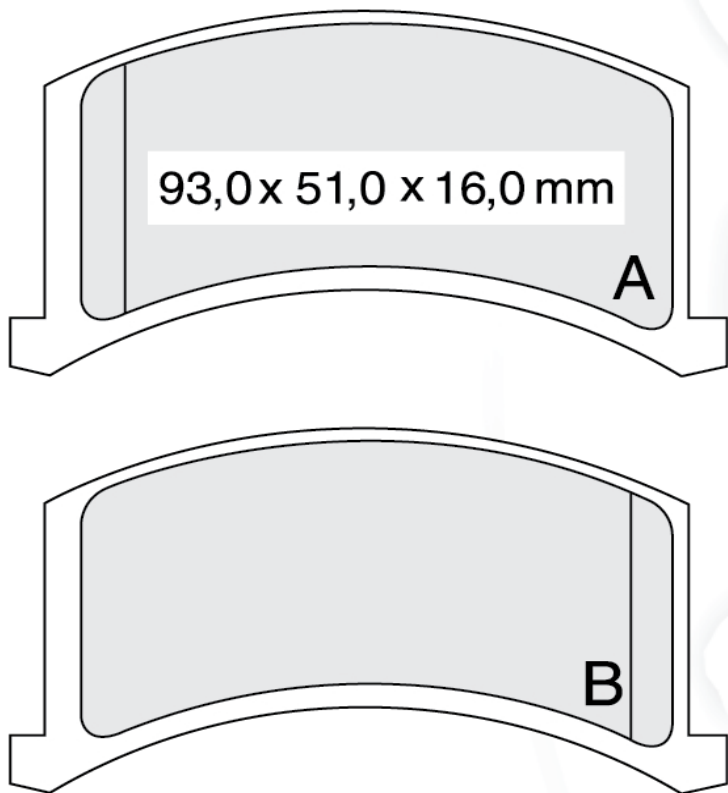
			W.V.A
<b>Д110</b>	<b>Д110И</b>	<b>ЗАЗ</b>	



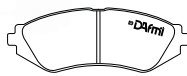
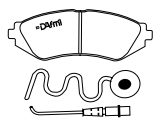

В комплект входят две колодки типа А, две колодки типа В

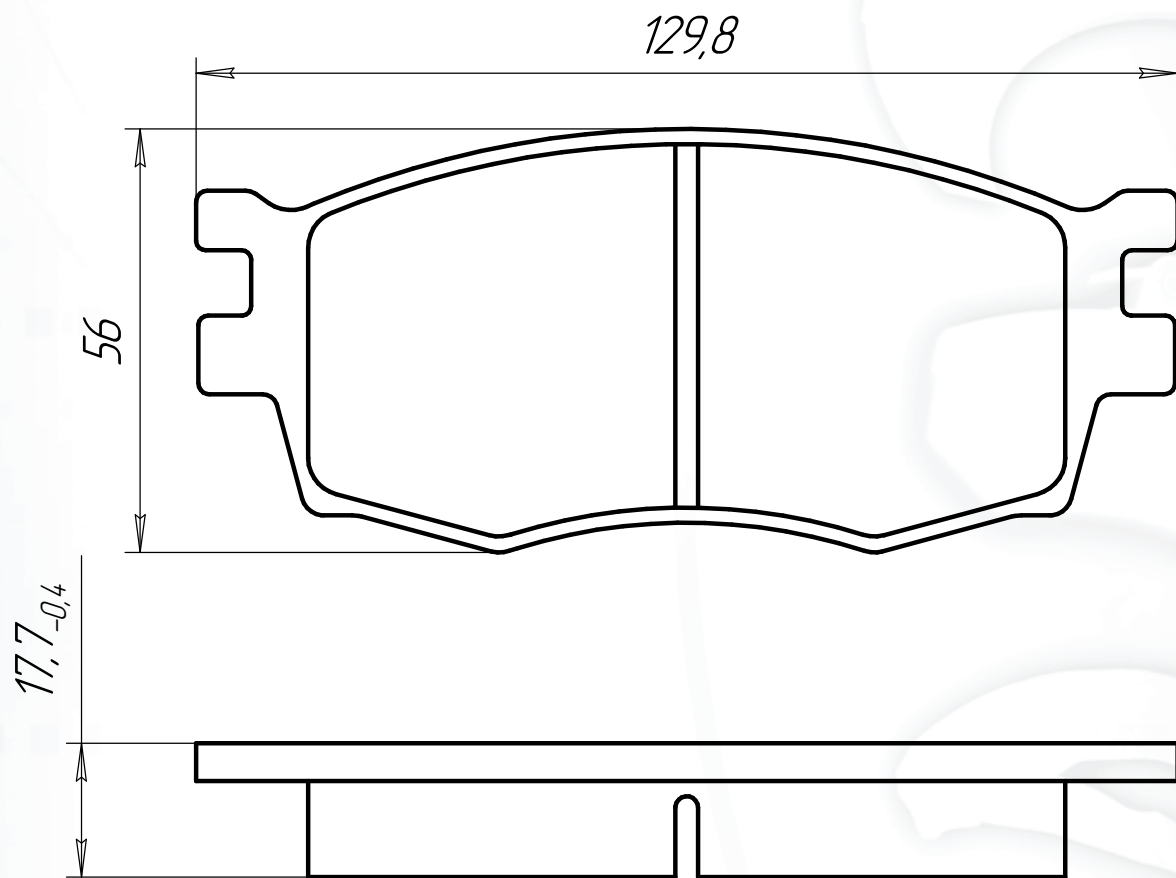

			<p>W.V.A</p>
<p>114</p>		<p>HYUNDAI, KIA</p>	

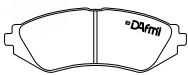
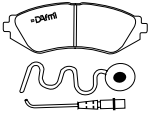



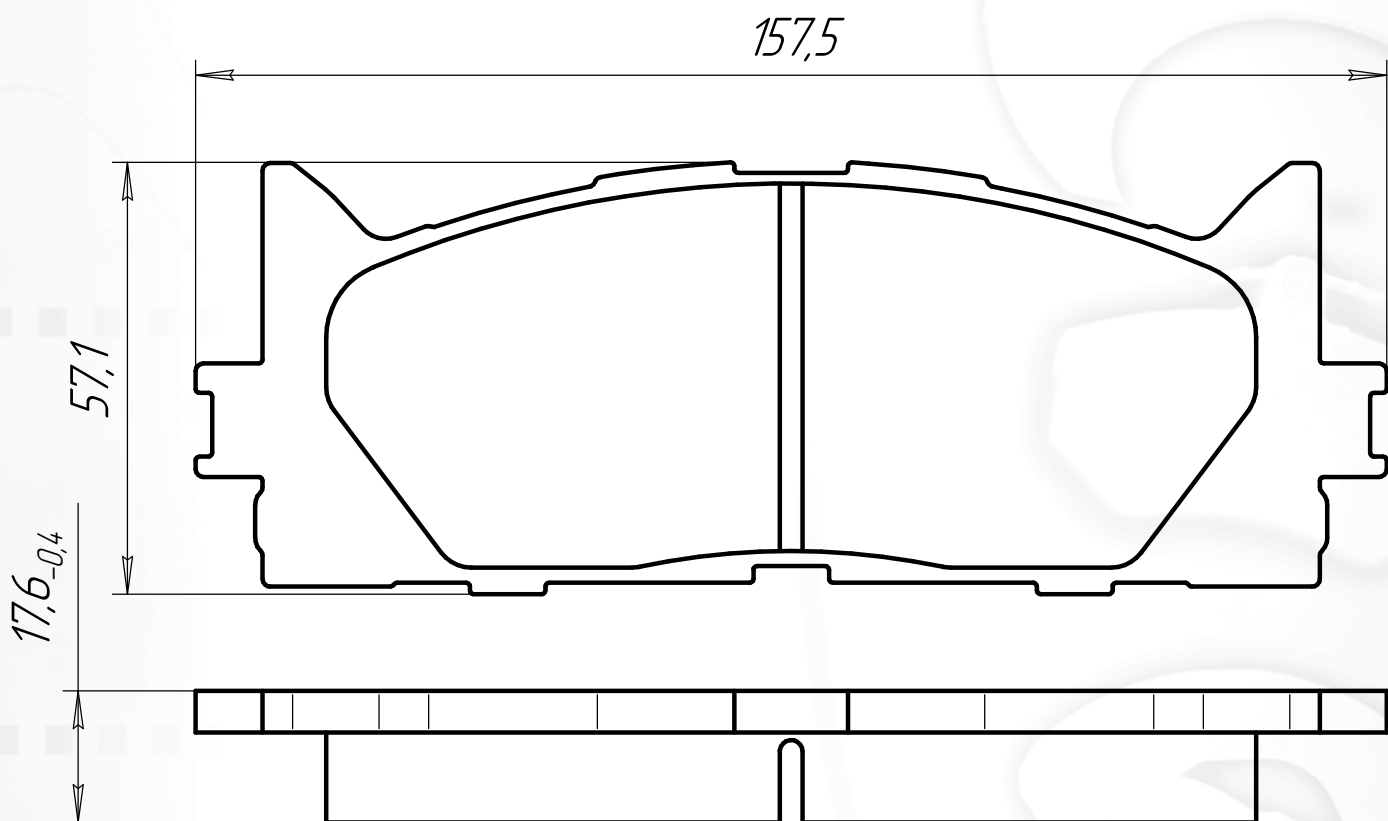

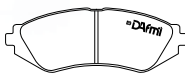
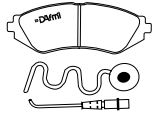
			<p>W.V.A</p>
<p>115</p>		<p>TOYOTA</p>	



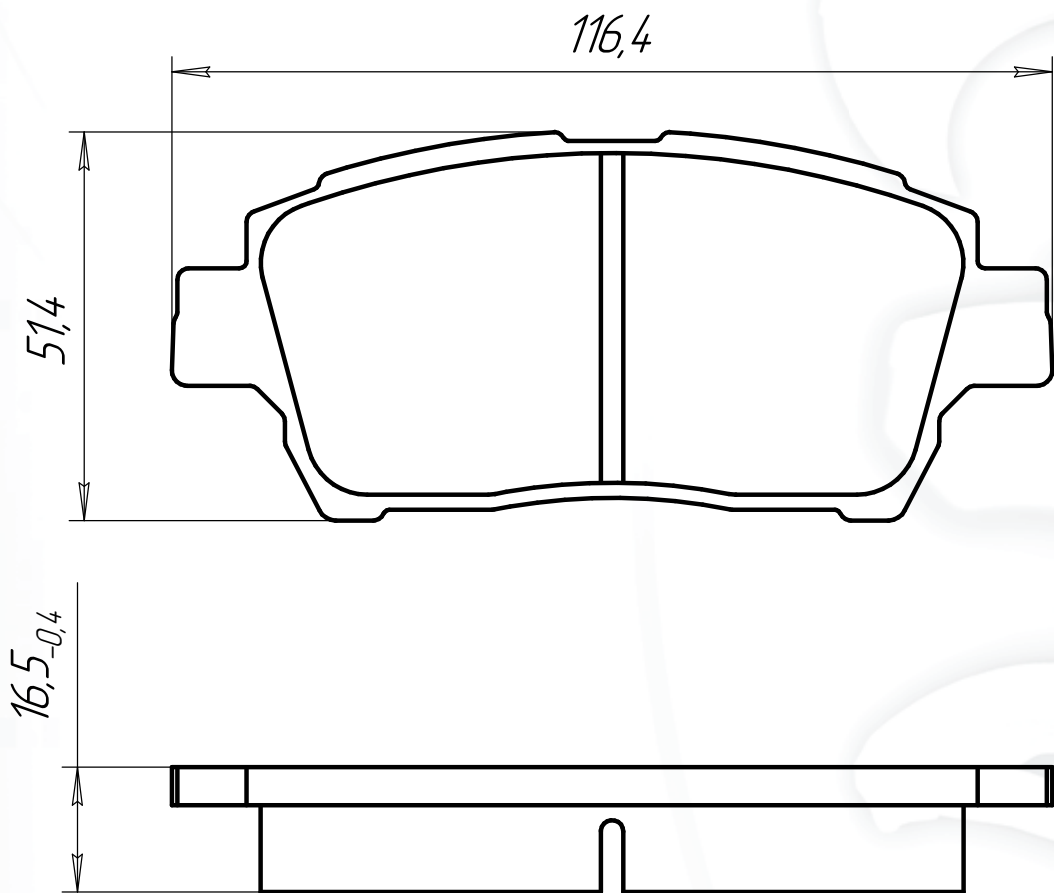

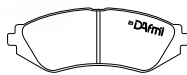
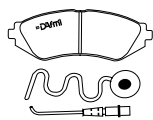
			<p>W.V.A</p>
<p>116</p>		<p>TOYOTA</p>	

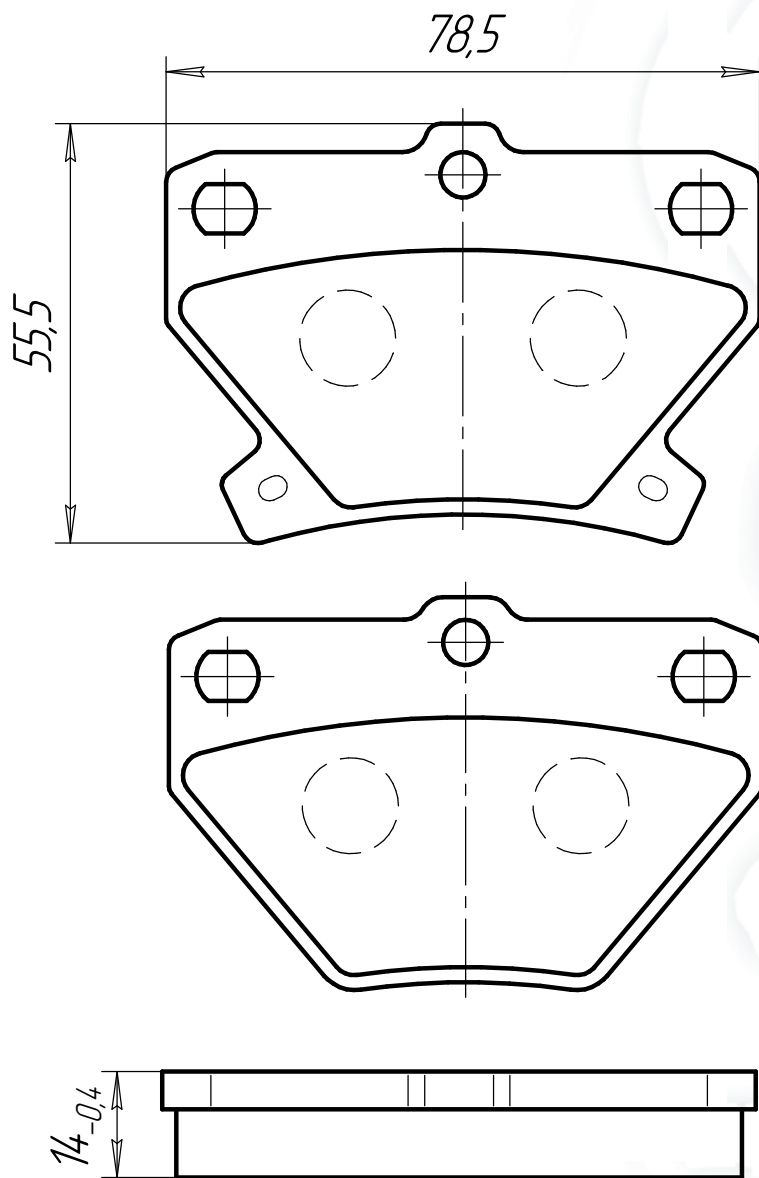

			<p>W.V.A</p>
<p>117</p>		<p>TOYOTA</p>	

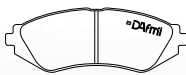
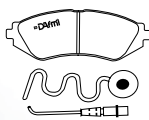

			W.V.A
---	---	--	-------

<b>Д121</b>		<b>OPEL</b>	<b>20903</b>
-------------	--	-------------	--------------

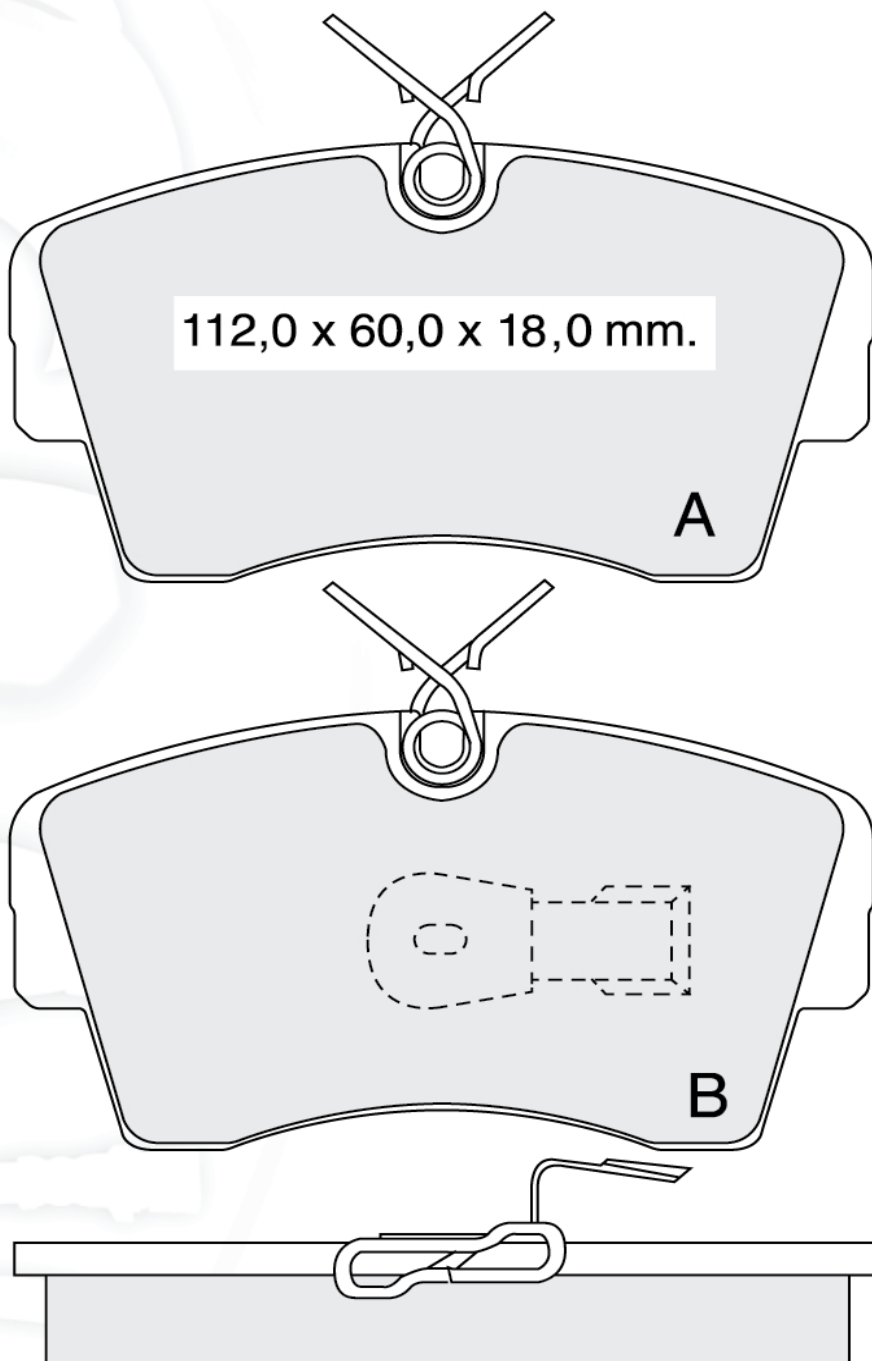

В комплект входят две колодки типа А, две колодки типа В

			W.V.A
--	--	--	-------

<b>Д122</b>		<b>HONDA</b>	<b>21497</b>
-------------	--	--------------	--------------

Индикатор износа входит в базовую комплектацию данной колодки.

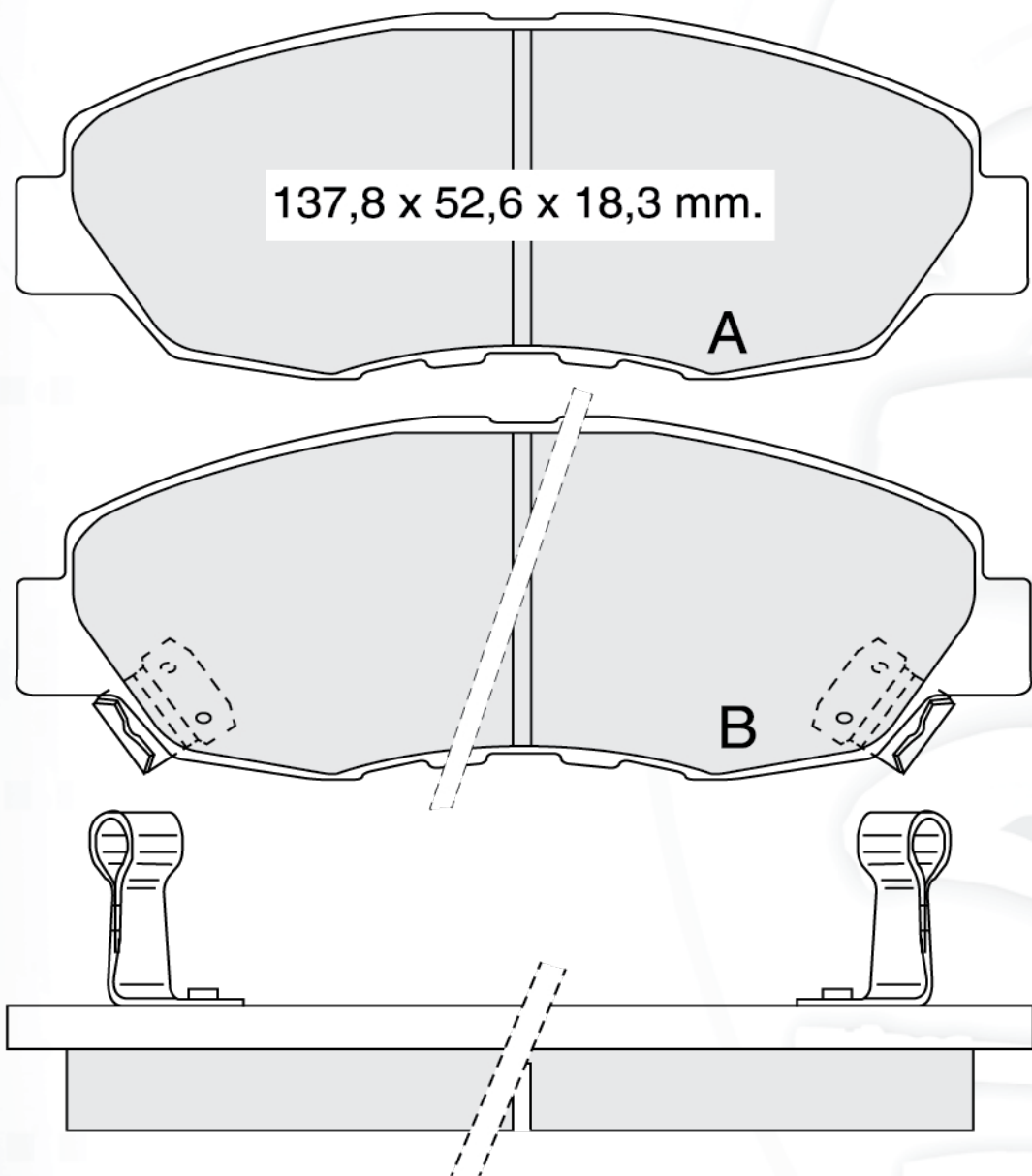

В комплект входят две колодки типа А, две колодки типа В



			W.V.A
--	--	--	-------

<b>Д123</b>		<b>МITSUBISHI</b>	<b>21373</b>
-------------	--	-------------------	--------------

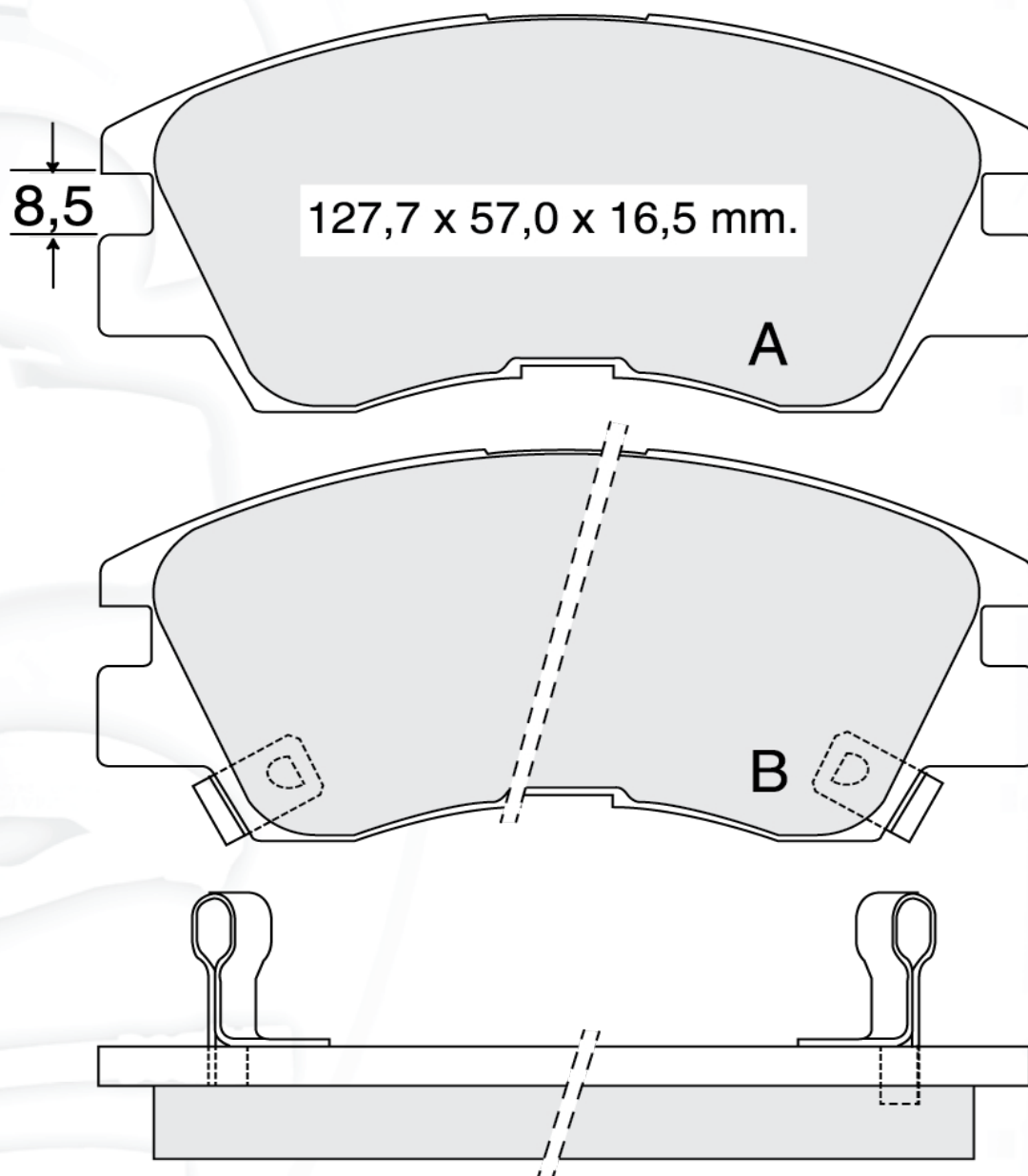
Индикатор износа входит в базовую комплектацию данной колодки.

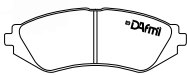
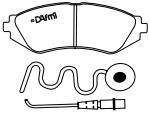

В комплект входят две колодки типа А, две колодки типа В

			<p>W.V.A</p>
<p><b>Д125</b></p>	<p>-</p>	<p><b>CHEVROLET</b></p>	<p>24071</p>

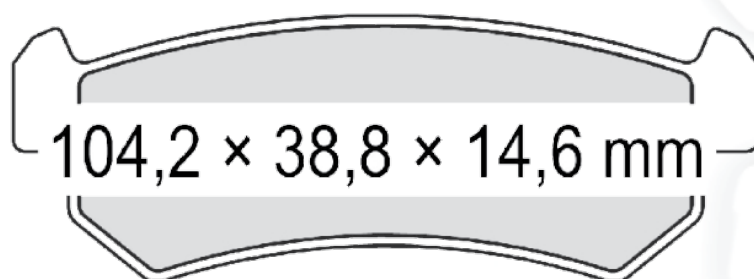

			W.V.A
--	--	--	-------

<b>Д126</b>		<b>TOYOTA</b>	23480 23481 23768
-------------	--	---------------	-------------------------

Индикатор износа входит в базовую комплектацию данной колодки

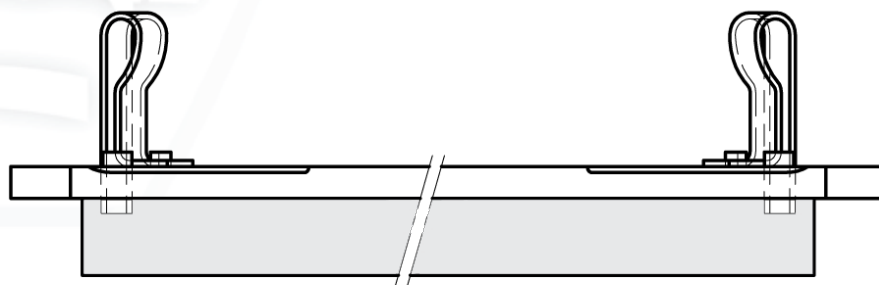
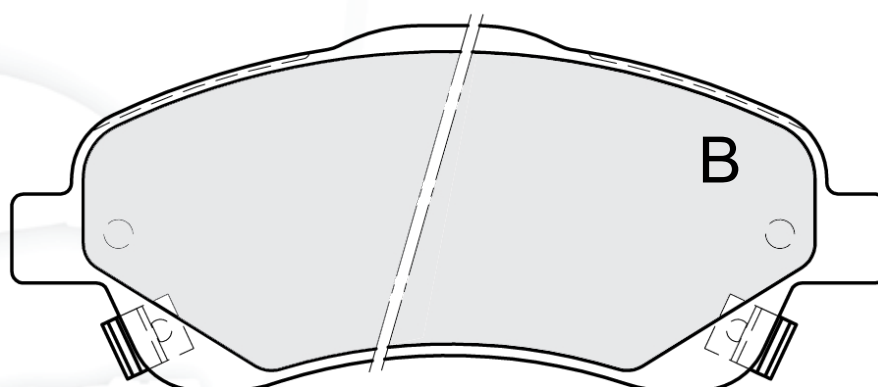
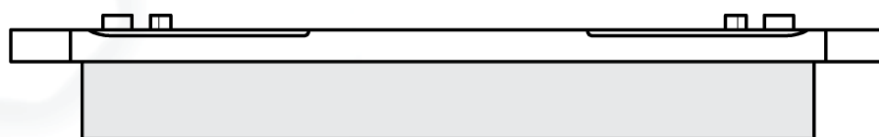
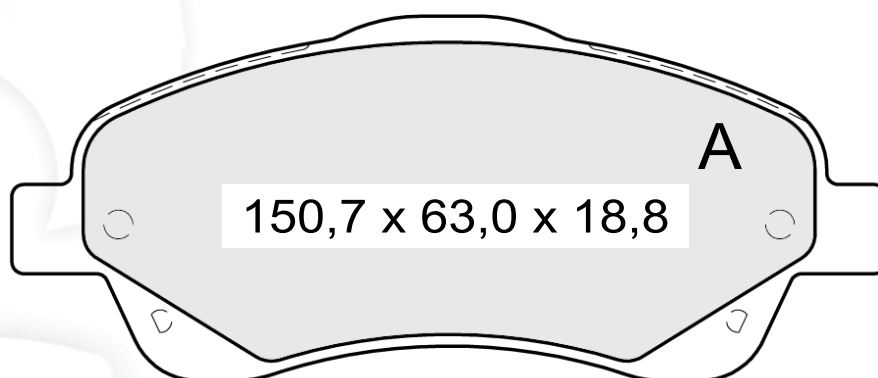

В комплект входят две колодки типа А, две колодки типа В



			W.V.A
Д128	Д128И	IVECO	29121

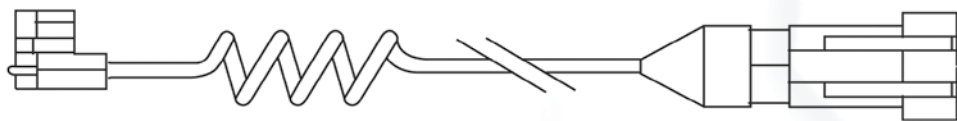
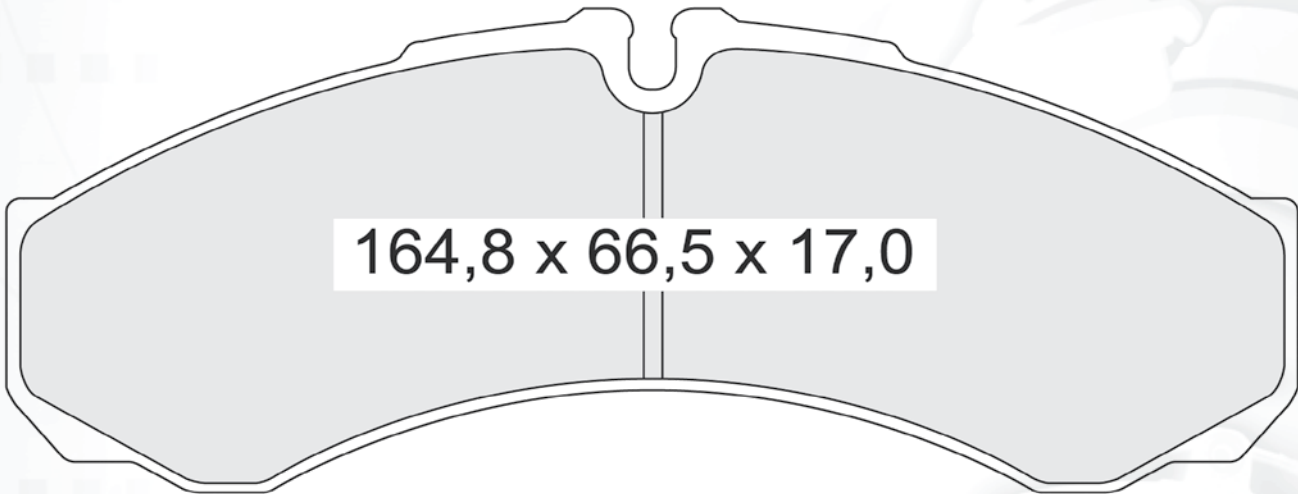

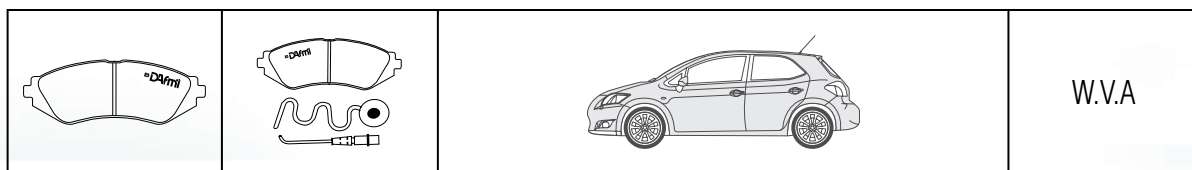

<b>Д129</b>		<b>FIAT, IVECO</b>	<b>21048</b>
-------------	--	--------------------	--------------

Индикатор износа входит в базовую комплектацию данной колодки.

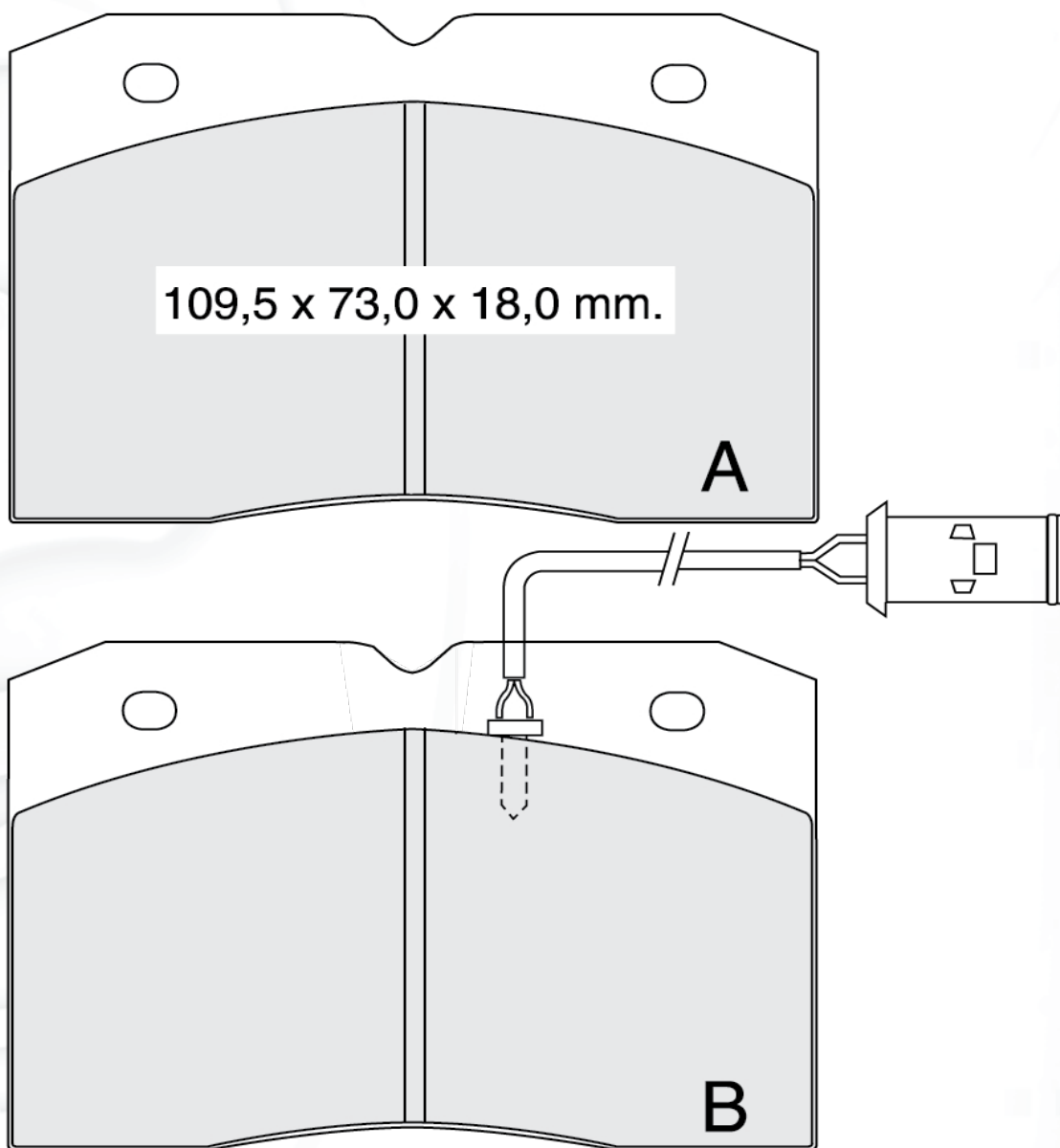

В комплект входят две колодки типа А, две колодки типа В

			W.V.A
--	--	--	-------

<b>Д130</b>		<b>JEEP</b>	<b>21822</b>
-------------	--	-------------	--------------

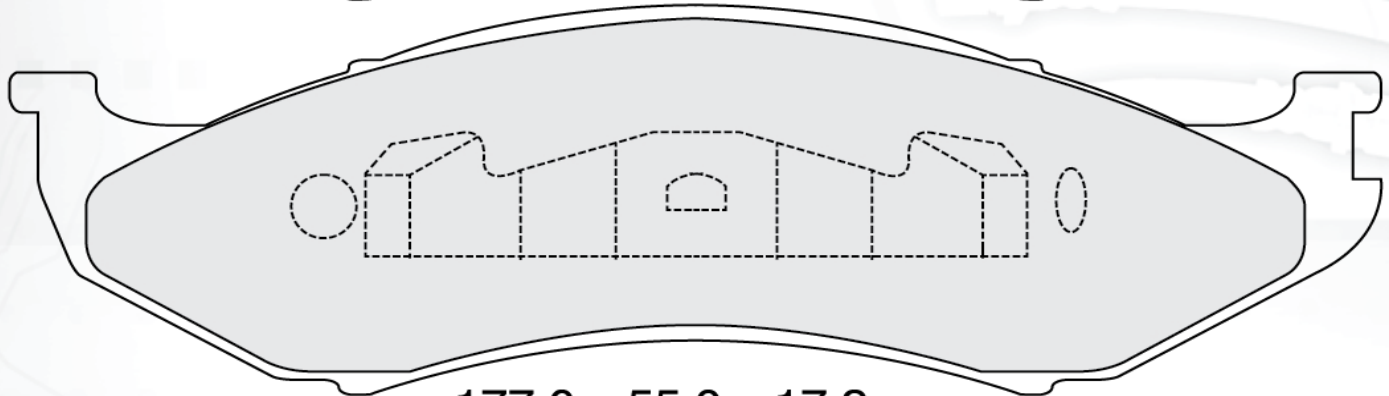
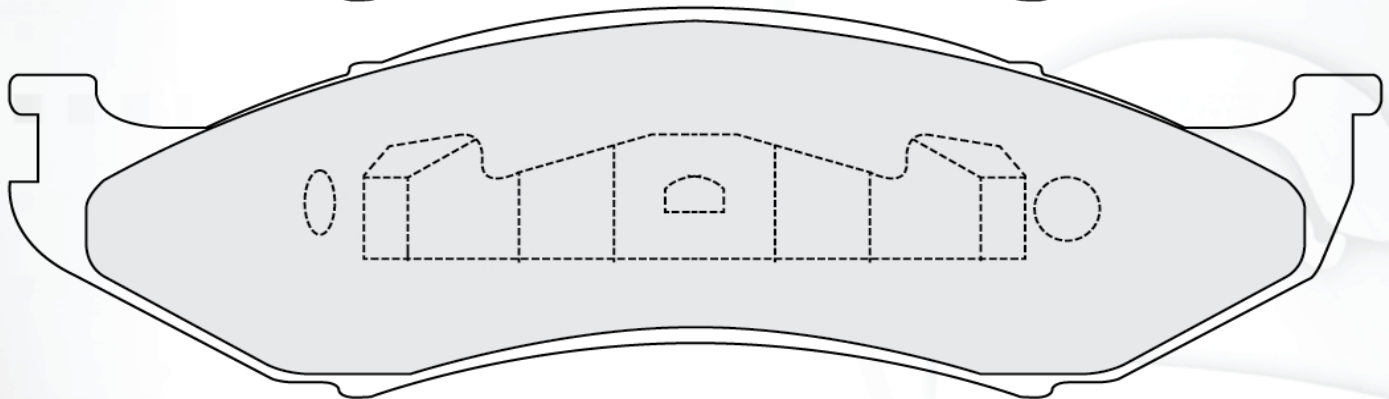
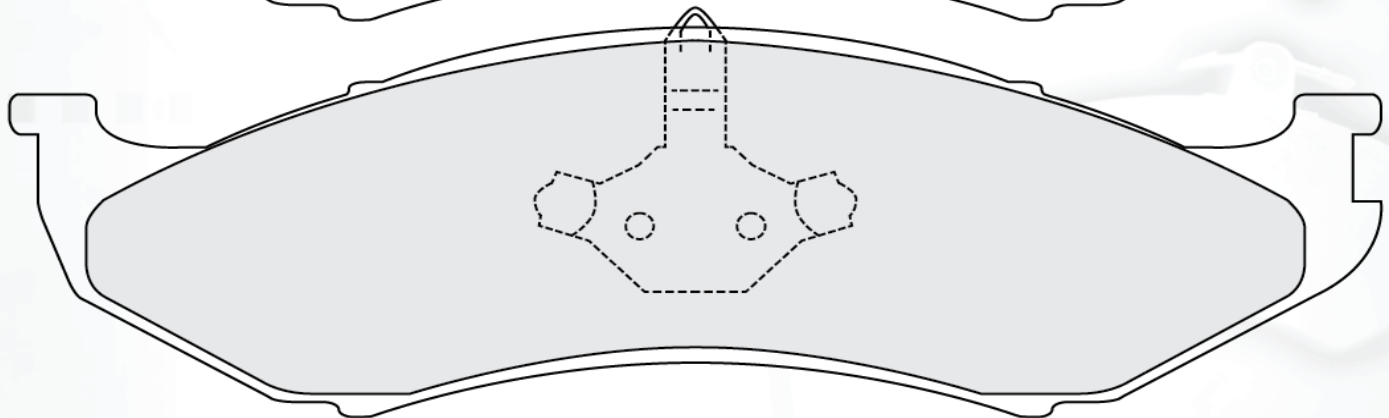
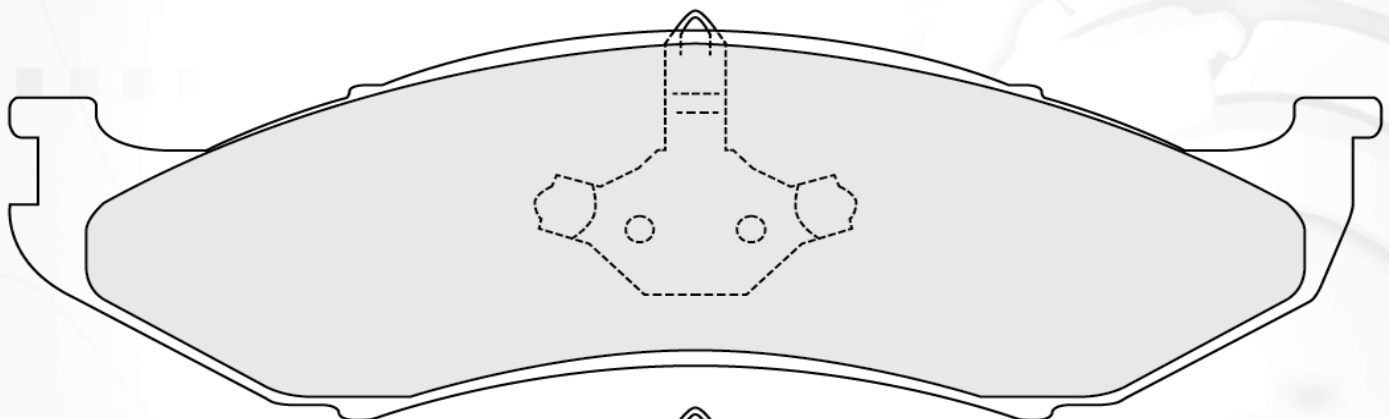

177,0 x 55,0 x 17,2 mm.

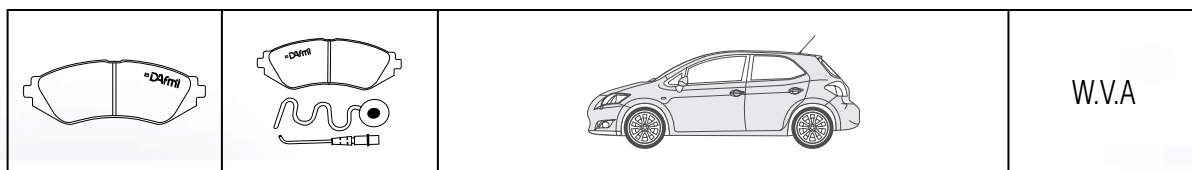

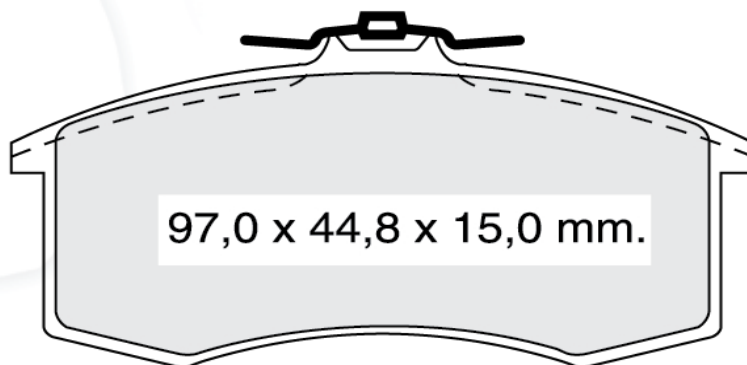

<b>Д131</b>		<b>BA3</b>	
-------------	--	------------	--

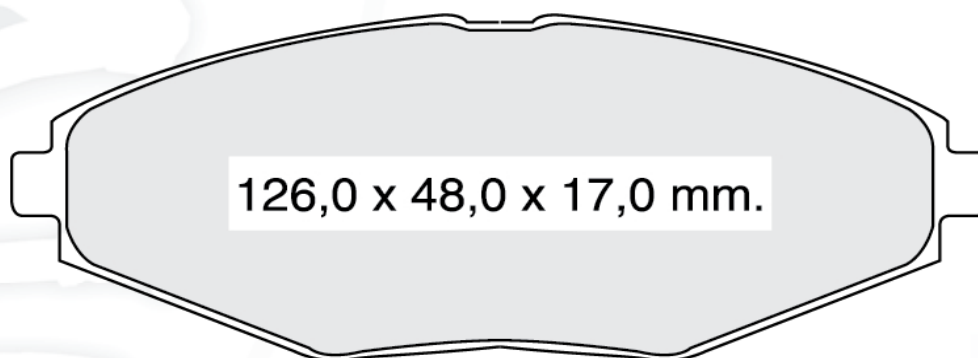

<b>Д132</b>	<b>Д132K</b>	<b>DAEWOO</b>	
-------------	--------------	---------------	--

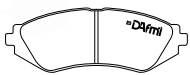
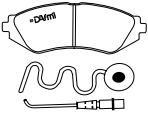

			W.V.A
<b>Д133</b>	<b>Д133И</b>	<b>DAEWOO</b>	<b>23234</b>

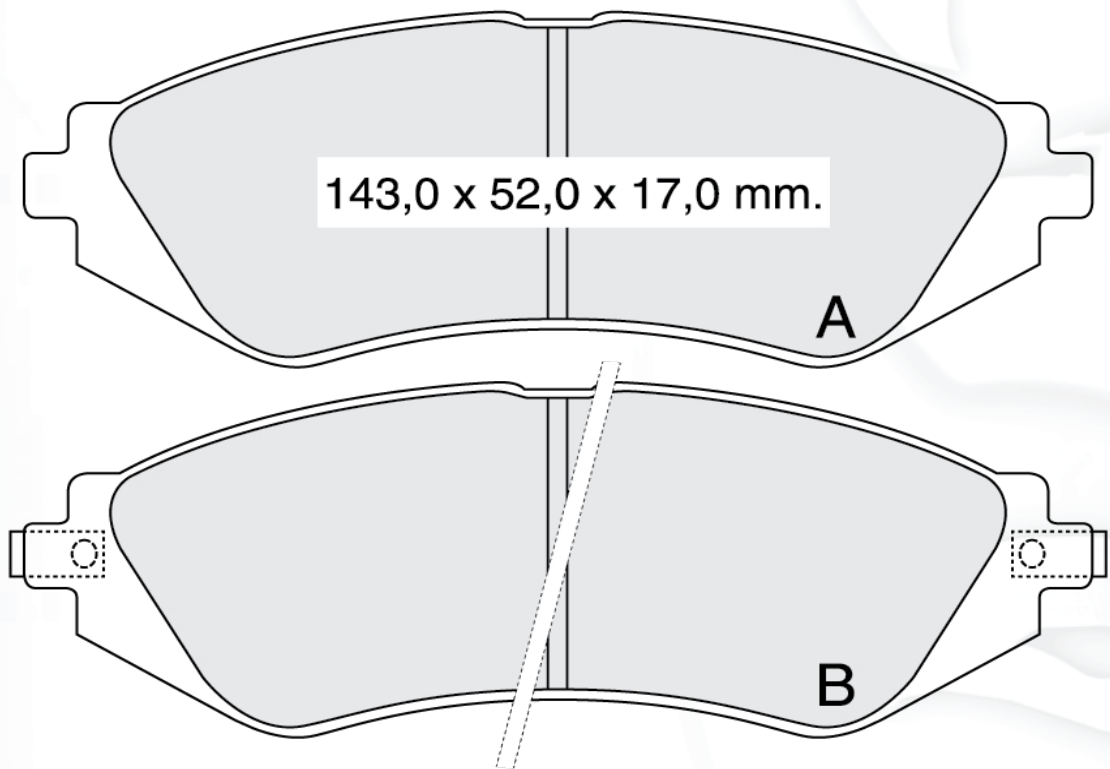

Д133 – в комплект входят четыре колодки типа А  
 Д133И – в комплект входят две колодки типа А, две колодки типа В

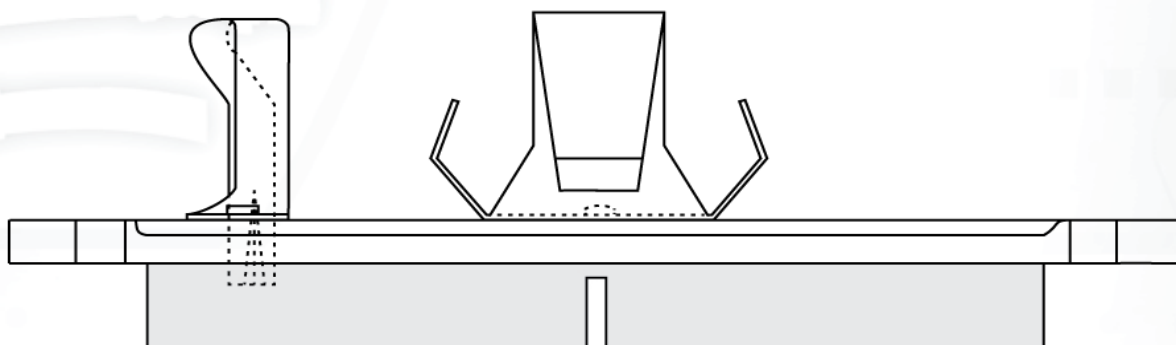
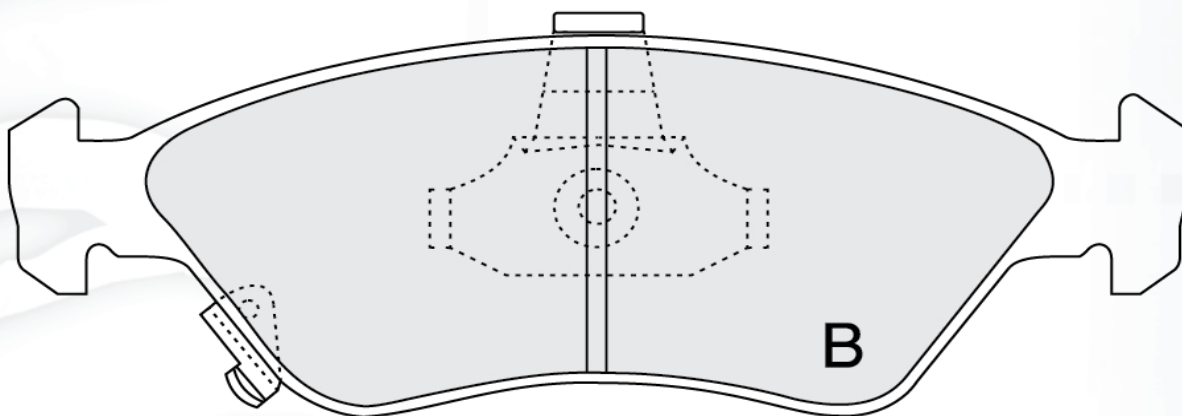
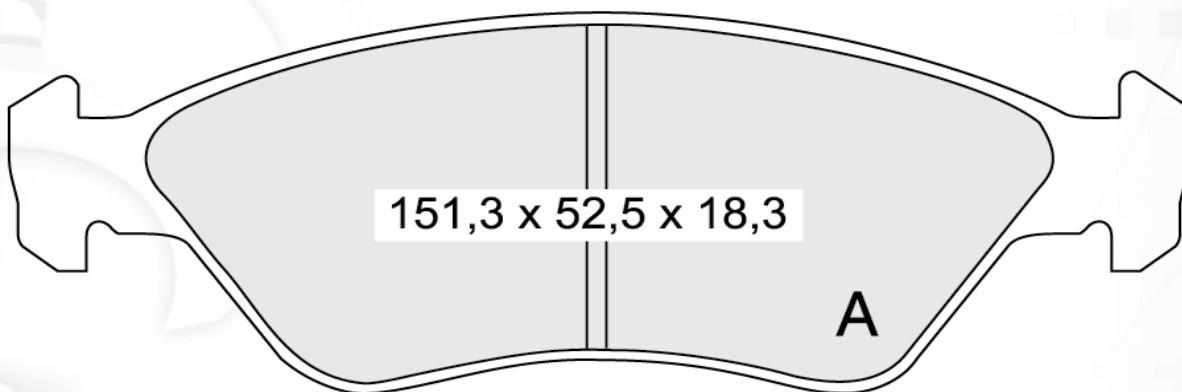
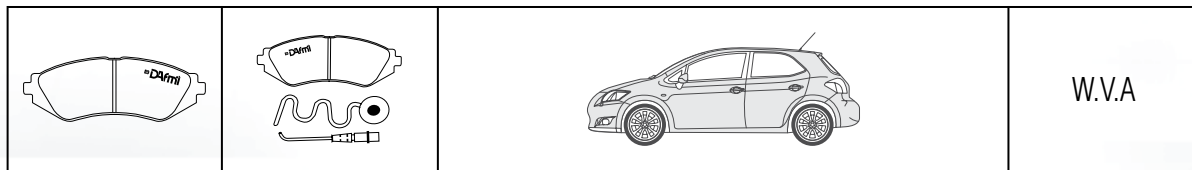

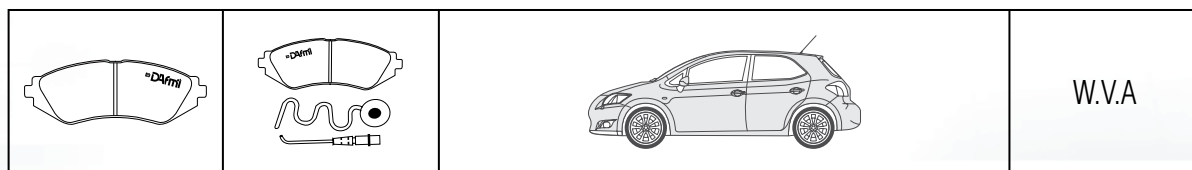

В комплект входят две колодки типа А, две колодки типа В



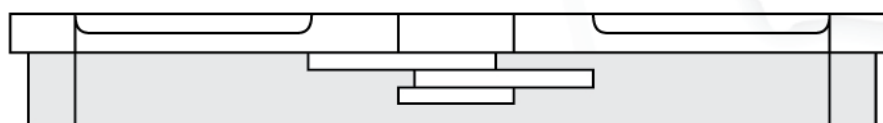
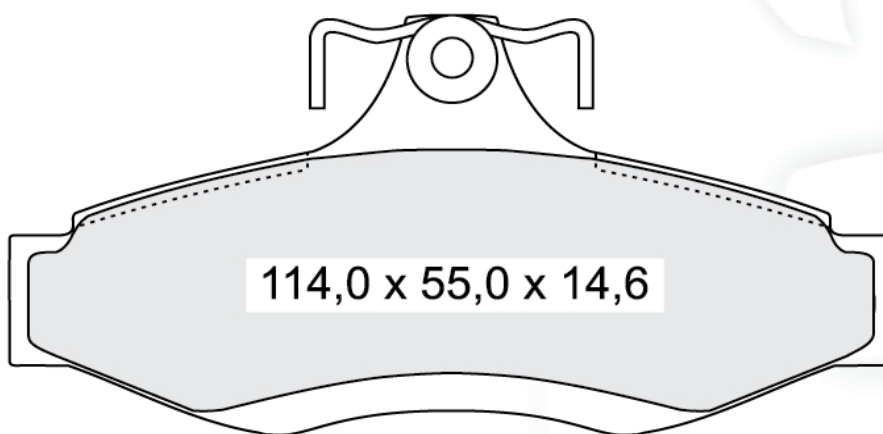

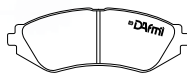
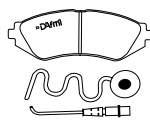
<b>Д135</b>		<b>DAEWOO</b>	<b>23237</b>
-------------	--	---------------	--------------

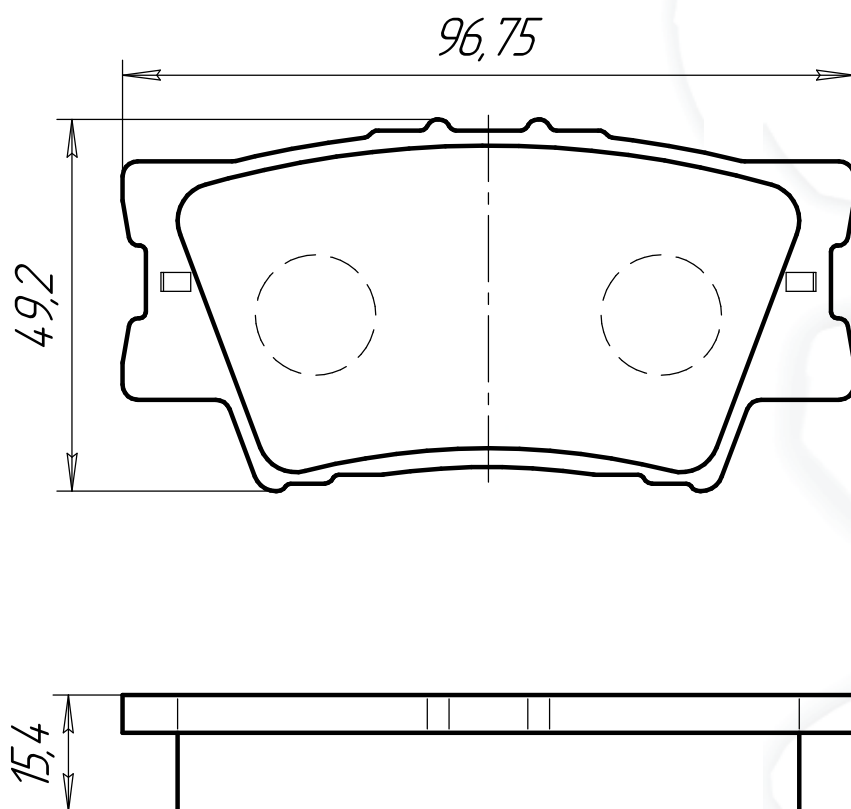

			<p>W.V.A</p>
<p>136</p>		<p>TOYOTA</p>	



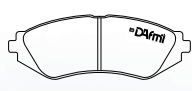
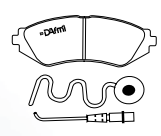

			W.V.A
---	---	--	-------

<b>Д137</b>	<b>Д137И</b>	<b>AUDI, SKODA, VOLKSWAGEN</b>	<b>21974</b>
-------------	--------------	--------------------------------	--------------

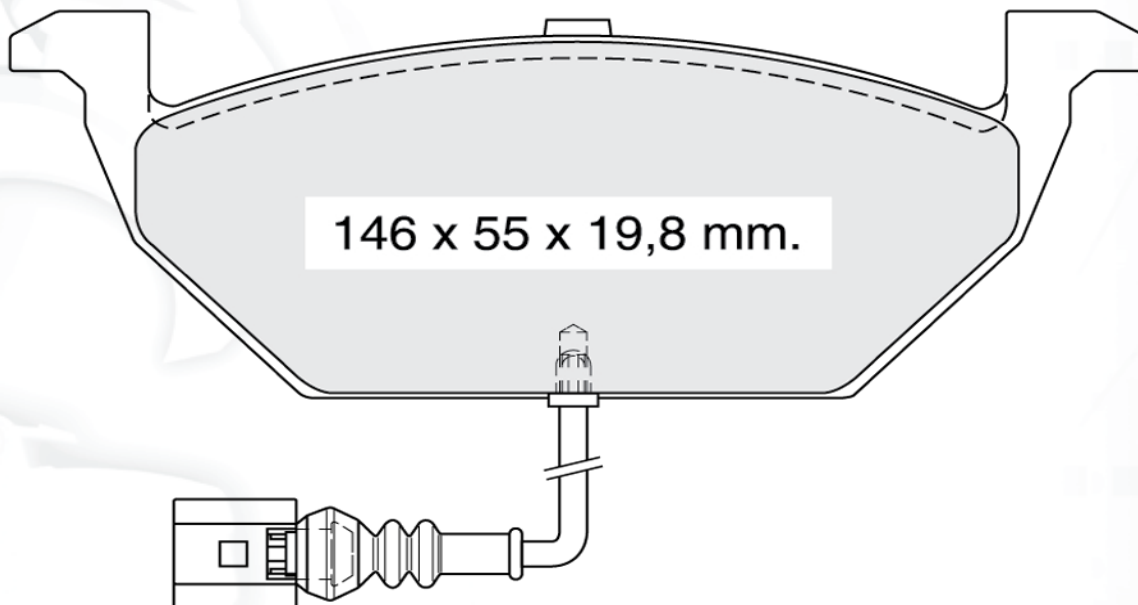

<b>Д138</b>		<b>NISSAN, FORD</b>	<b>21410</b>
-------------	--	---------------------	--------------

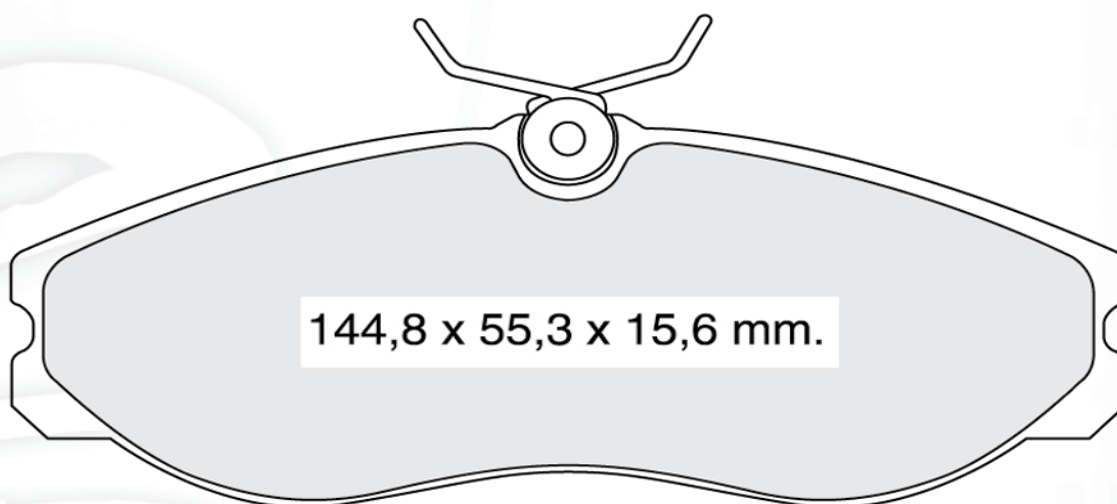

			W.V.A
--	--	--	-------

<b>Д139</b>		<b>ISUZU, OPEL</b>	<b>21845</b>
-------------	--	--------------------	--------------

Индикатор износа входит в базовую комплектацию данной колодки.

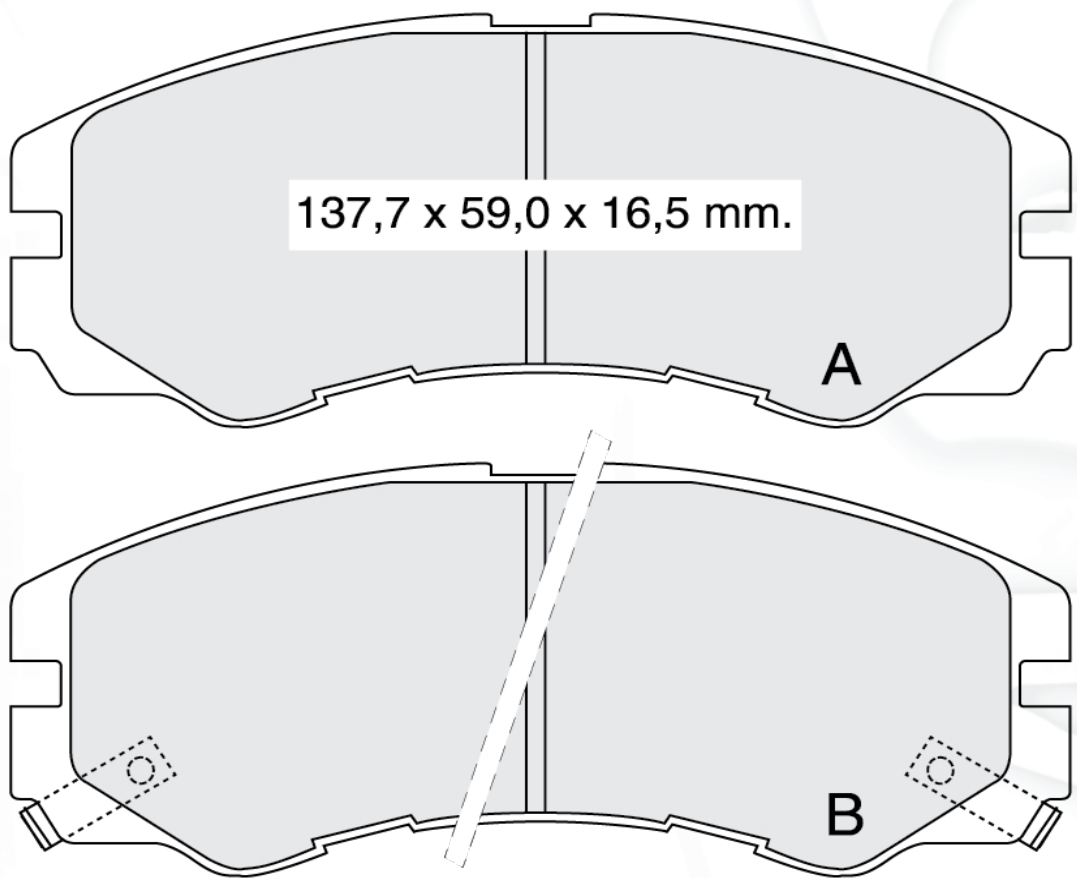

В комплект входят две колодки типа А, две колодки типа В

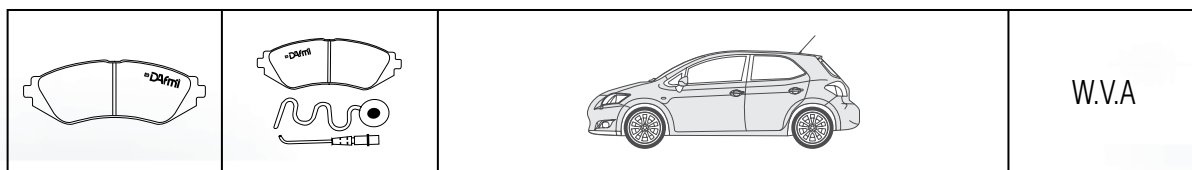

<b>Д140</b>	<b>Д140И</b>	<b>ВАЗ</b>	
-------------	--------------	------------	--

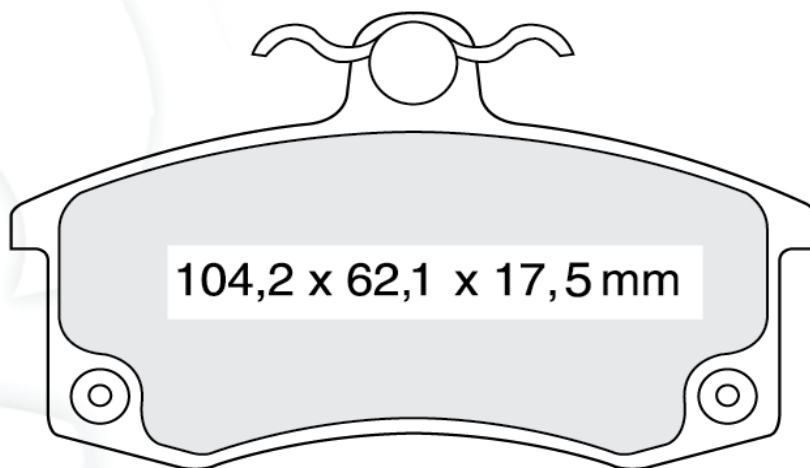

<b>Д141</b>		<b>АЗЛК</b>	
-------------	--	-------------	--

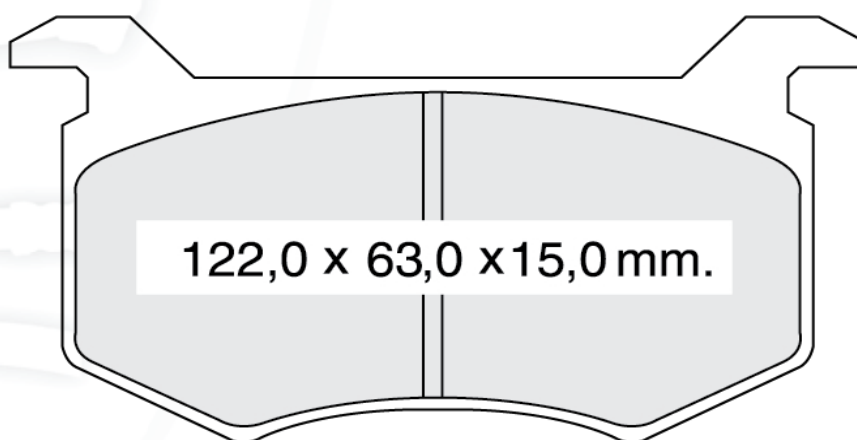

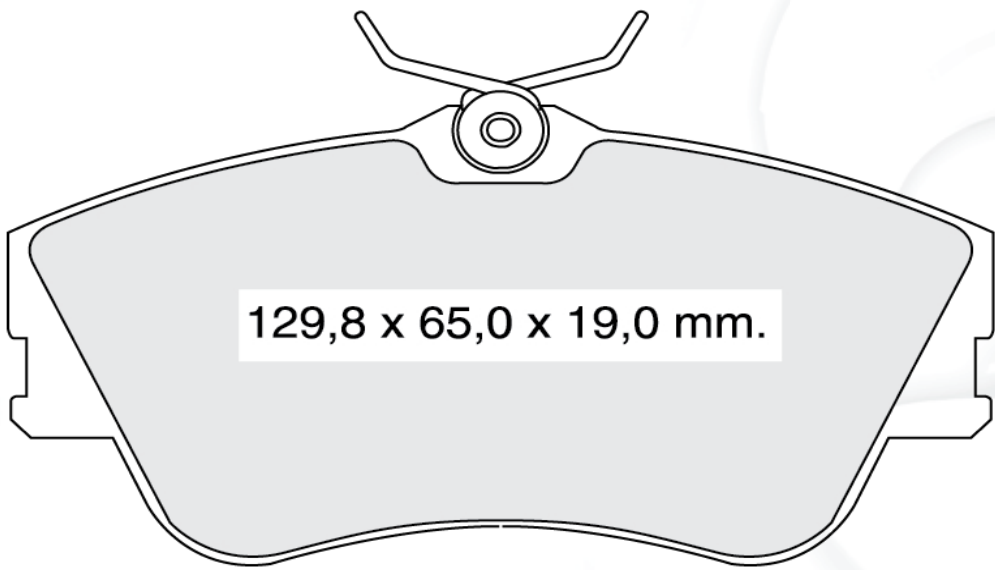

			W.V.A
--	--	--	-------

<b>Д142</b>		<b>VOLKSWAGEN</b>	<b>21479</b>
-------------	--	-------------------	--------------

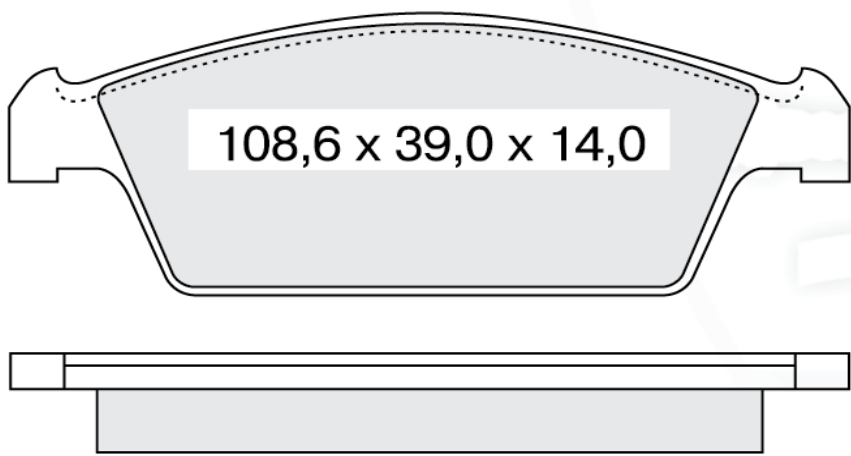

<b>Д143</b>		<b>DAEWOO, SUZUKI</b>	
-------------	--	-----------------------	--

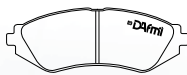
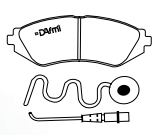

			<p>W.V.A</p>
---	---	--	--------------

<p><b>Д144</b></p>		<p><b>CITROEN, PEUGEOT</b></p>	<p>21124</p>
--------------------	--	--------------------------------	--------------

Индикатор износа входит в базовую комплектацию данной колодки.

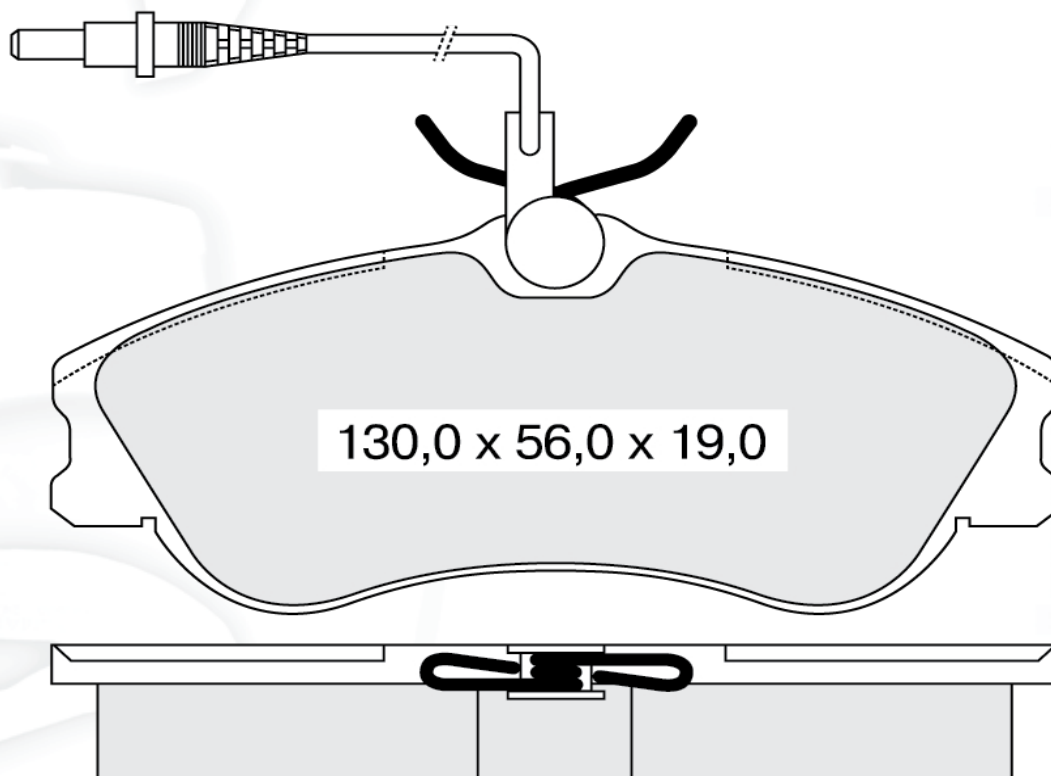

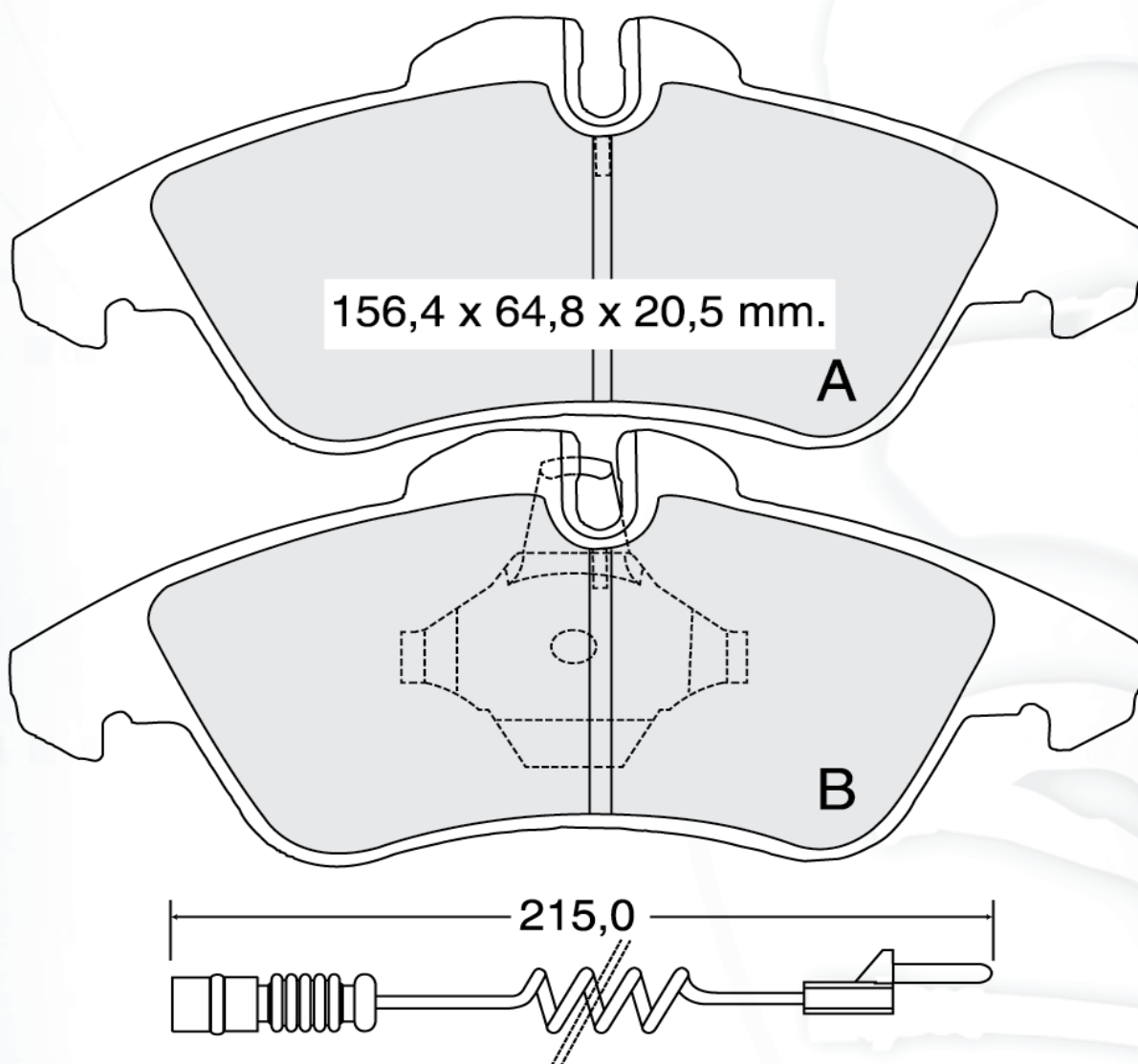

			W.V.A
--	--	--	-------

<b>Д145</b>	<b>Д145И</b>	<b>MERSEDES-BENZ</b>	<b>21576</b>
-------------	--------------	----------------------	--------------

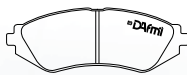
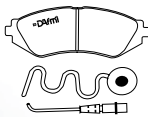

В комплект входят две колодки типа А, две колодки типа В

			W.V.A
<b>Д146</b>	<b>Д146И</b>	<b>MERSEDES-BENZ</b>	<b>29076</b>

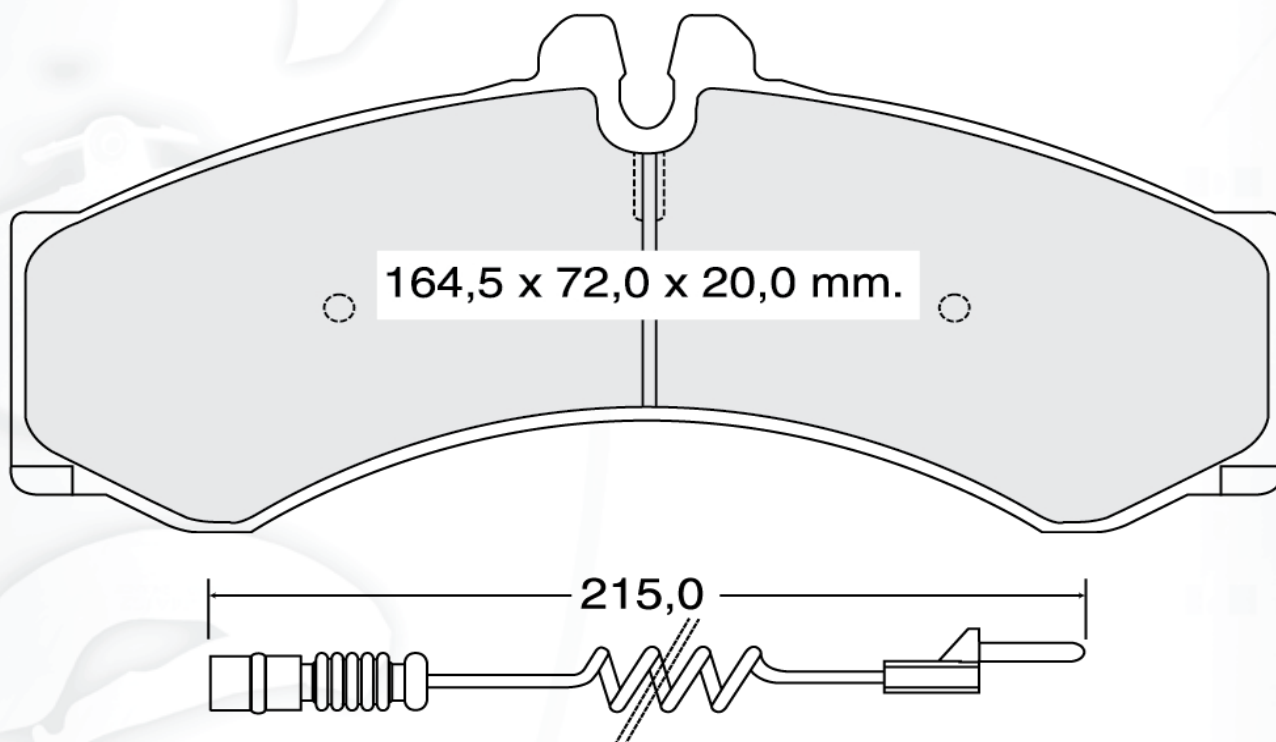

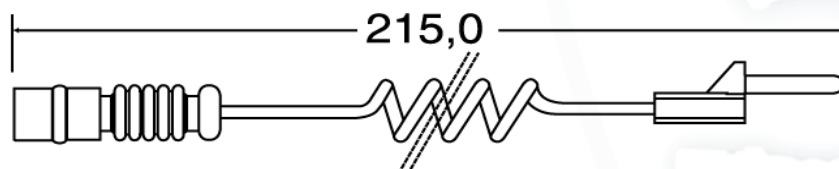
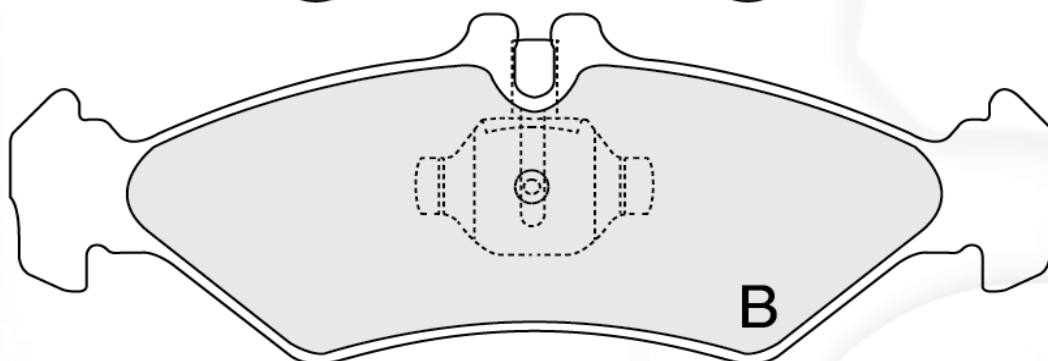
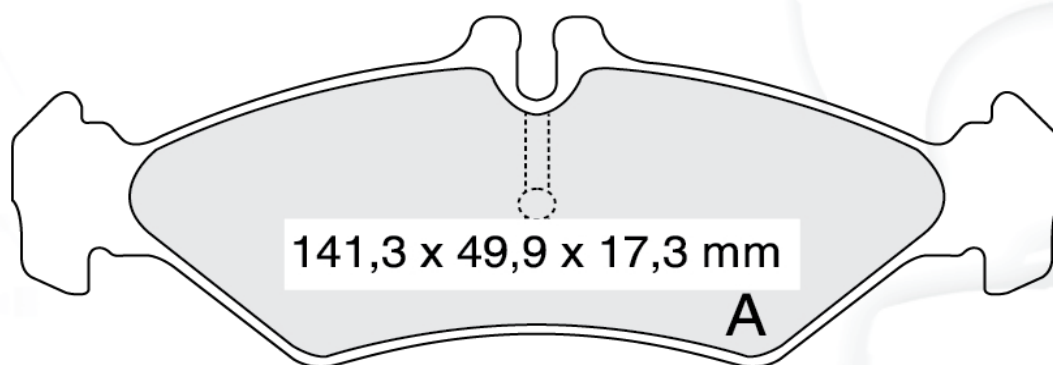

			W.V.A
<b>Д147</b>	<b>Д147И</b>	<b>MERSEDES-BENZ</b>	<b>21620</b>



В комплект входят две колодки типа А, две колодки типа В

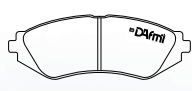
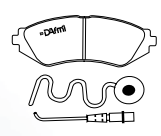

			W.V.A
---	---	--	-------

<b>Д148</b>	<b>Д148И</b>	<b>MERSEDES-BENZ</b>	<b>21592</b>
-------------	--------------	----------------------	--------------

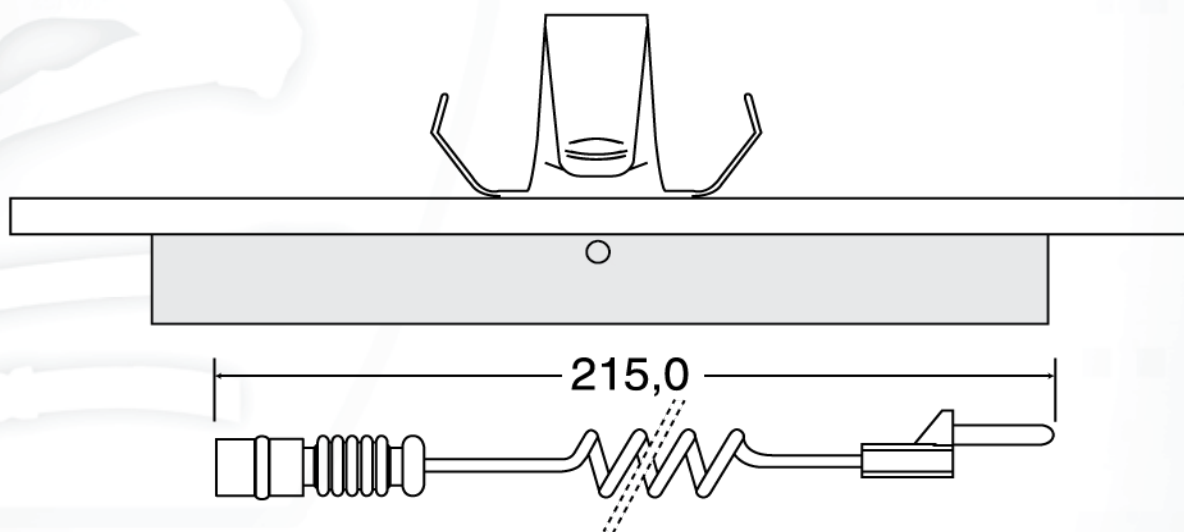
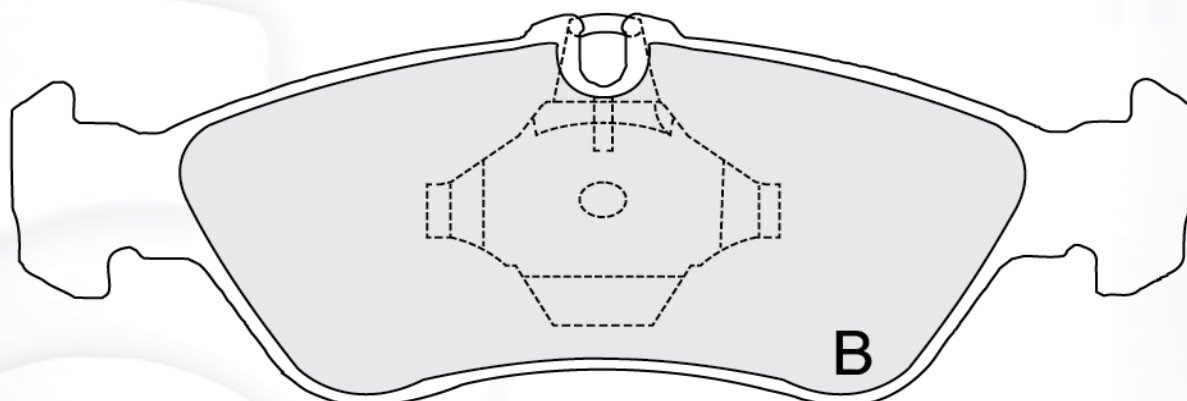
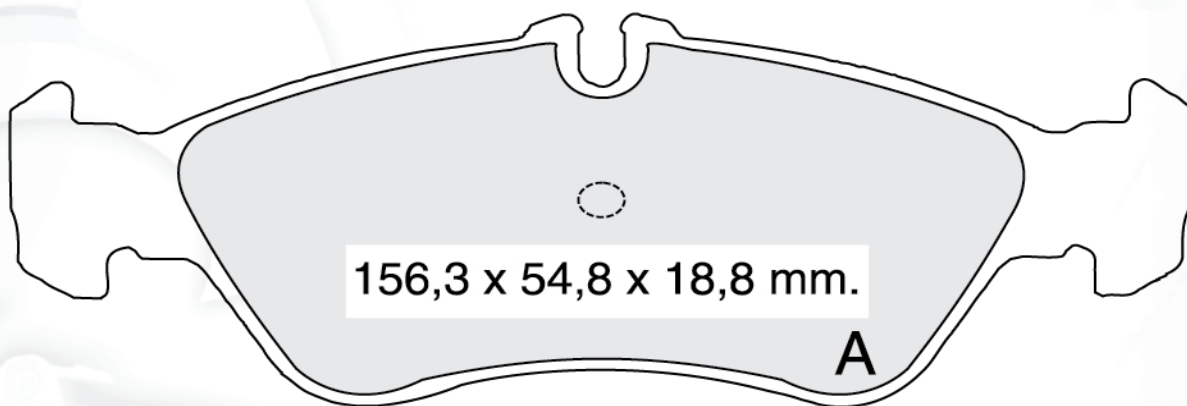

В комплект входят две колодки типа А, две колодки типа В

			W.V.A
--	--	--	-------

<b>Д149</b>	<b>Д149И</b>	<b>CITROEN, FIAT, PEUGEOT, RENAULT</b>	<b>21797</b>
-------------	--------------	--	--------------

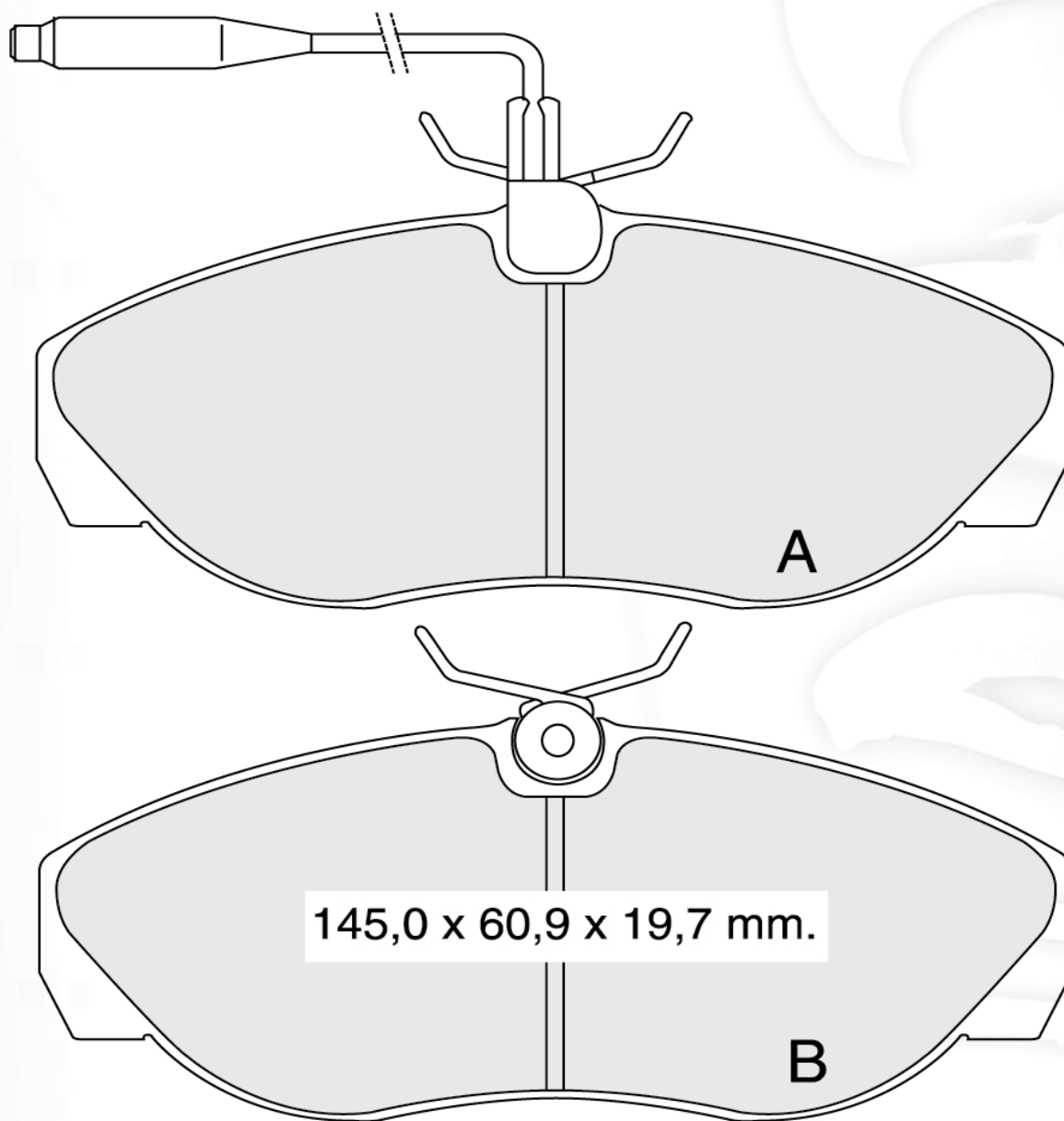

Д149 – в комплект входят четыре колодки типа В  
 Д149И – в комплект входят две колодки типа А, две колодки типа В

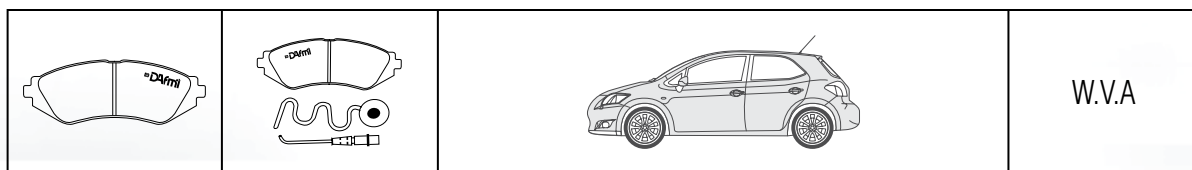

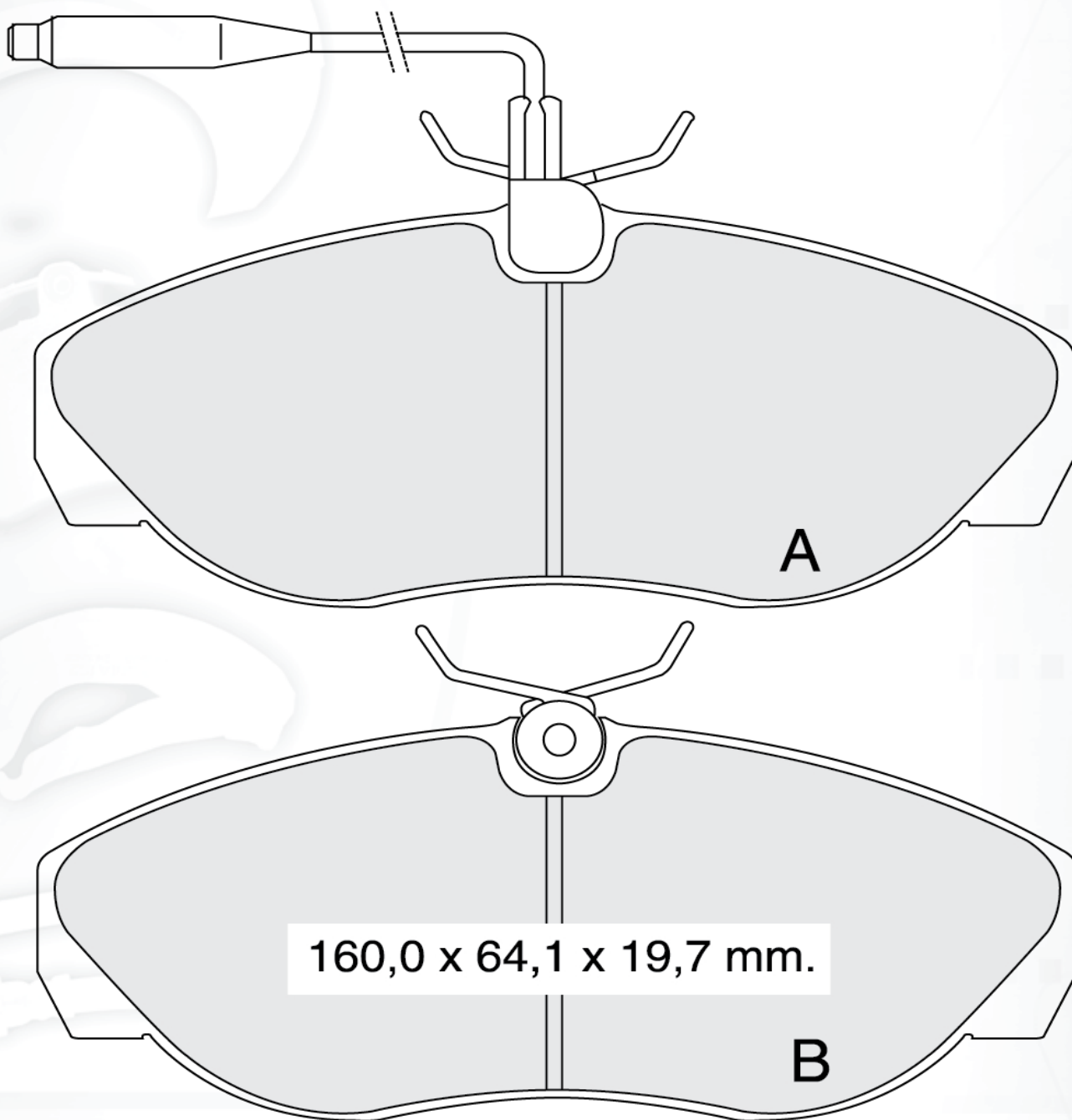

<b>Д150</b>	<b>СИТРОЕН, ФИАТ, ПЕЖЕОТ</b>	<b>21799</b>
-------------	------------------------------	--------------

Индикатор износа входит в базовую комплектацию данной колодки.



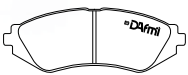
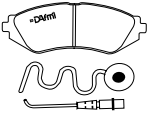

В комплект входят две колодки типа А, две колодки типа В

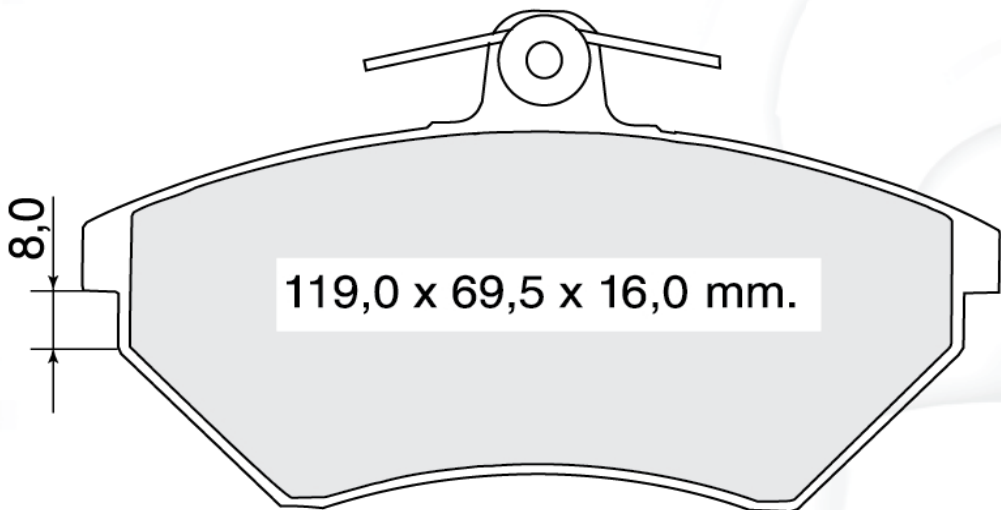
			W.V.A
<b>Д151</b>		<b>VOLKSWAGEN</b>	<b>21866</b>

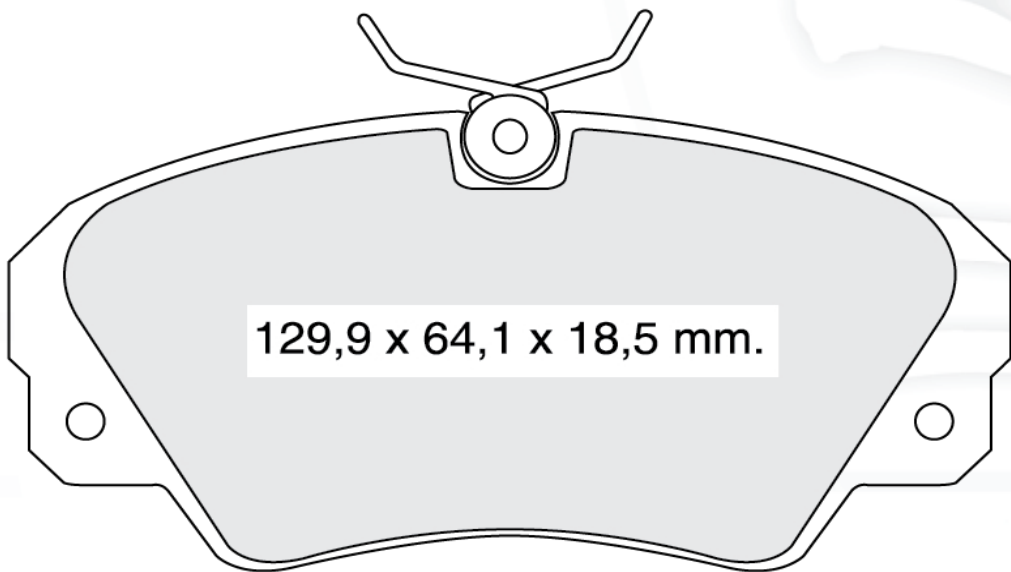

<b>Д152</b>	<b>Д152И</b>	<b>OPEL</b>	<b>21368</b>
-------------	--------------	-------------	--------------

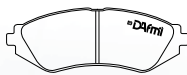
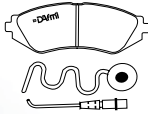

			W.V.A
---	---	--	-------

<b>Д153</b>	<b>Д153И</b>	<b>BMW</b>	<b>21676</b>
-------------	--------------	------------	--------------

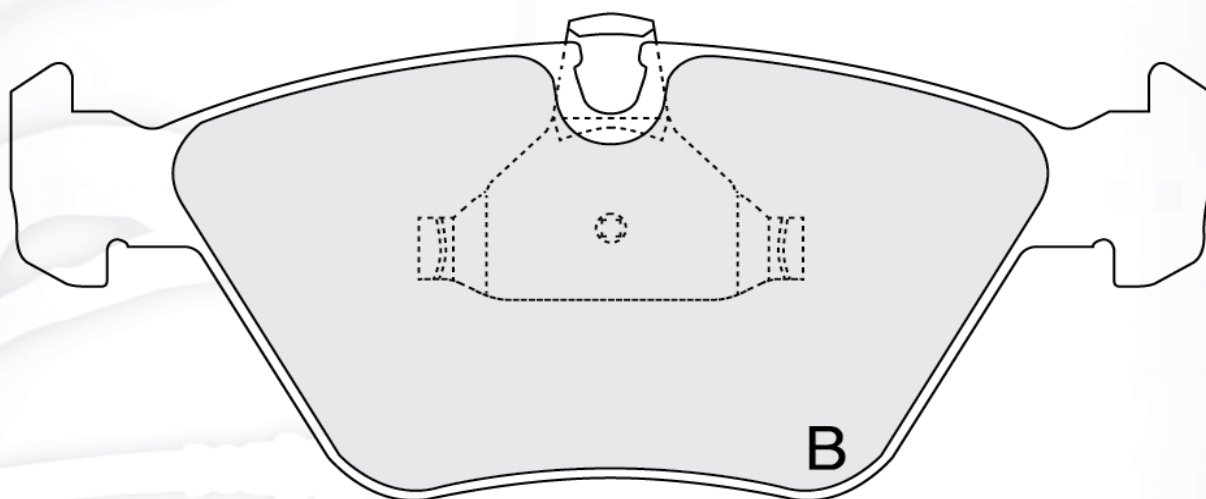
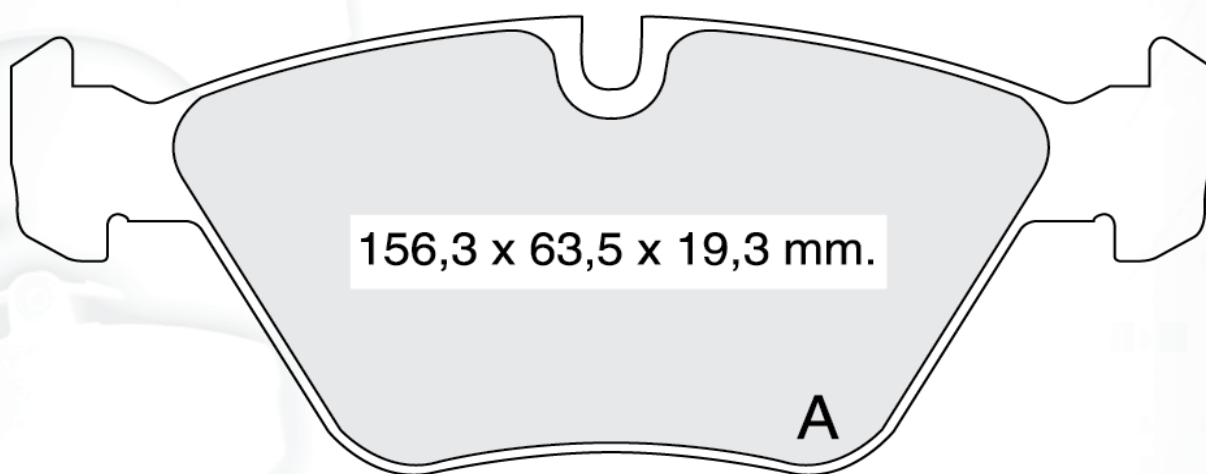

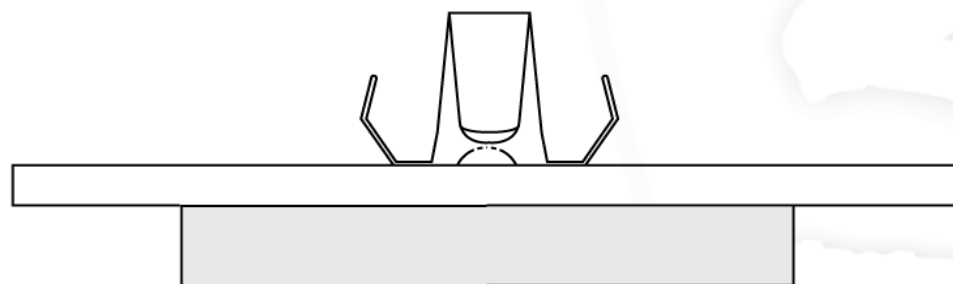
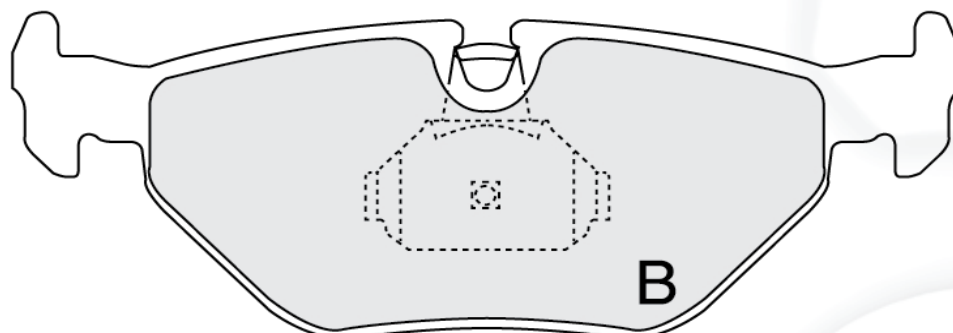
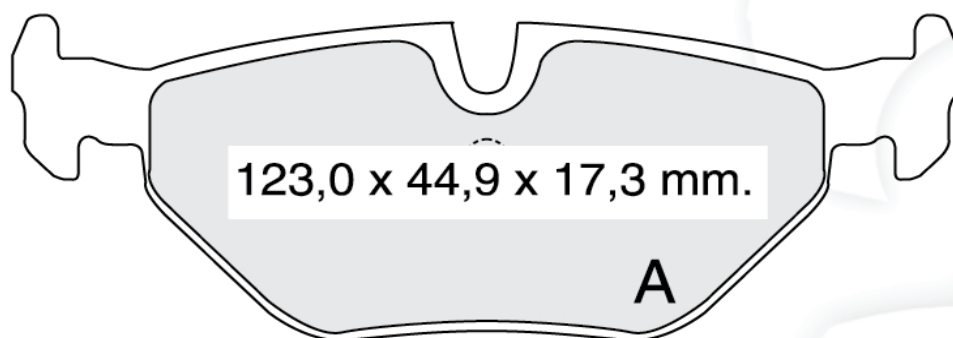

В комплект входят две колодки типа А, две колодки типа В

			W.V.A
<b>Д154</b>	<b>Д154И</b>	<b>BMW</b>	<b>21690</b>

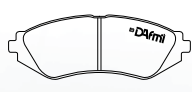
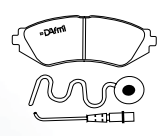

В комплект входят две колодки типа А, две колодки типа В

			W.V.A
---	---	--	-------

<b>Д155</b>	<b>Д155И</b>	<b>BMW</b>	<b>21664</b>
-------------	--------------	------------	--------------

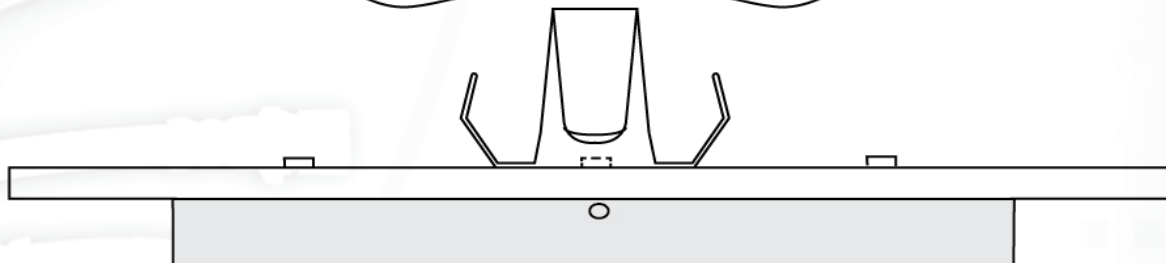
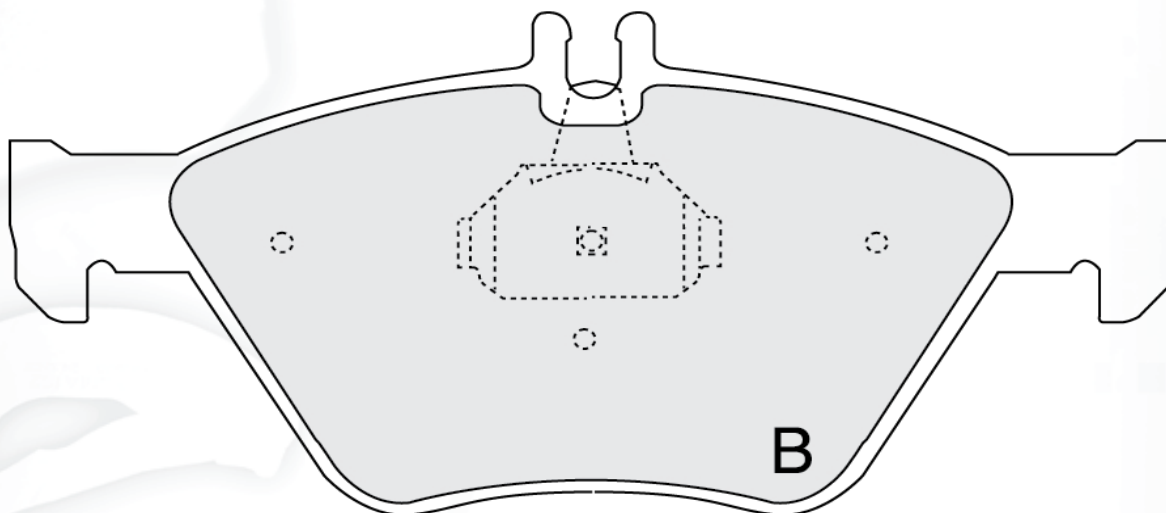
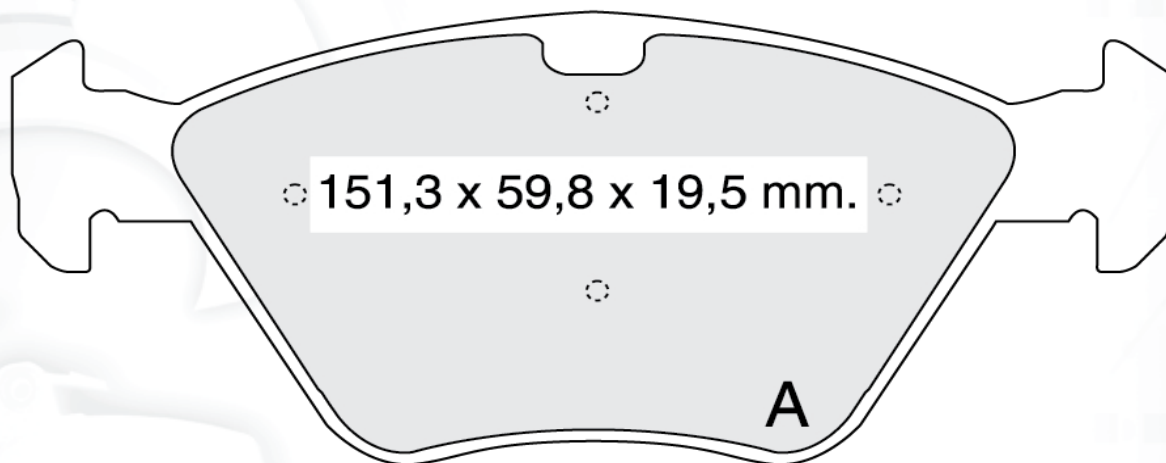

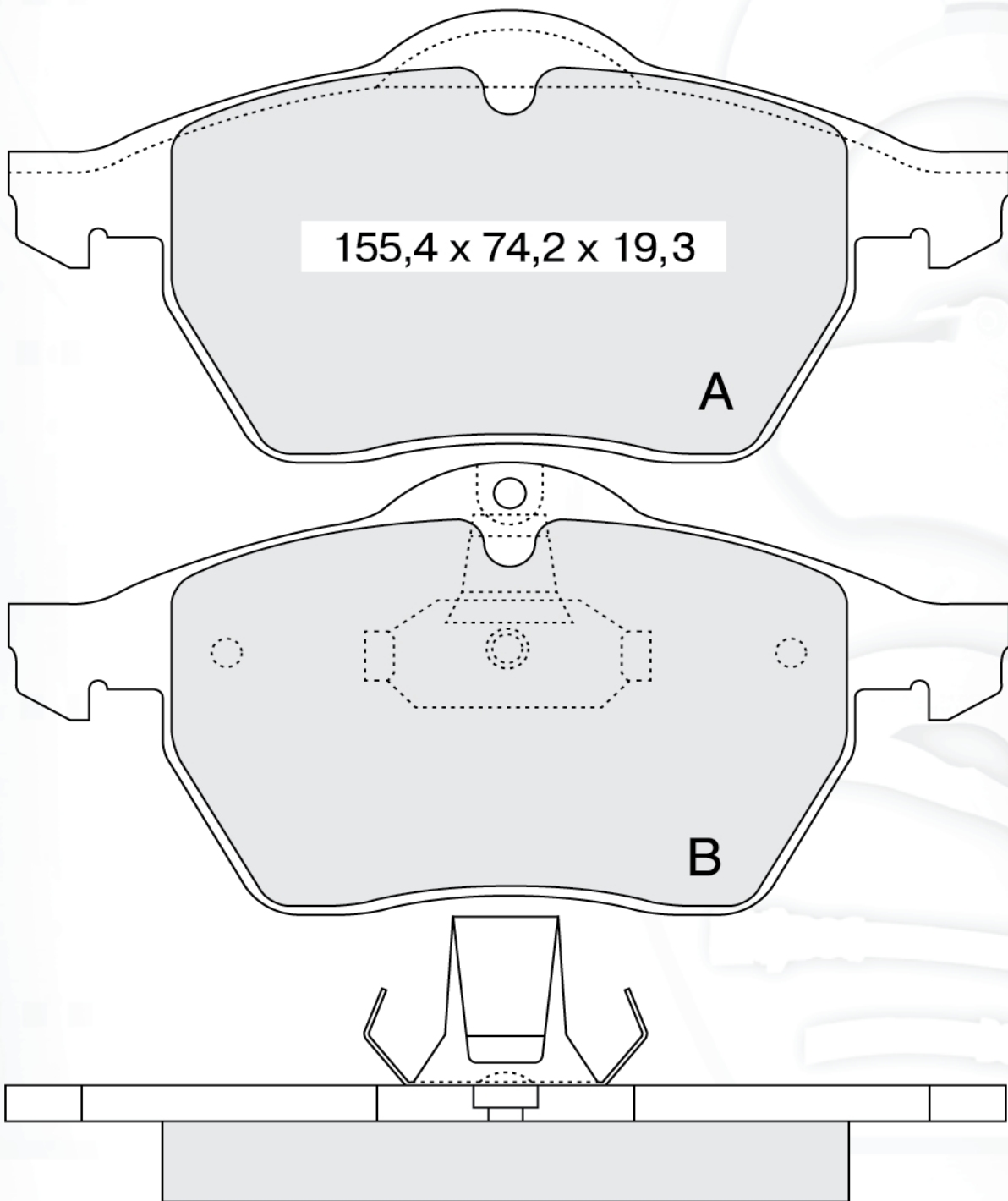

В комплект входят две колодки типа А, две колодки типа В

			W.V.A
<b>Д156</b>	<b>Д156И</b>	<b>OPEL, SAAB</b>	<b>21829</b>



В комплект входят две колодки типа А, две колодки типа В

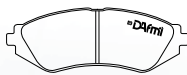
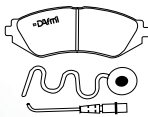

			W.V.A
<b>Д157</b>		<b>VOLKSWAGEN</b>	<b>21866</b>

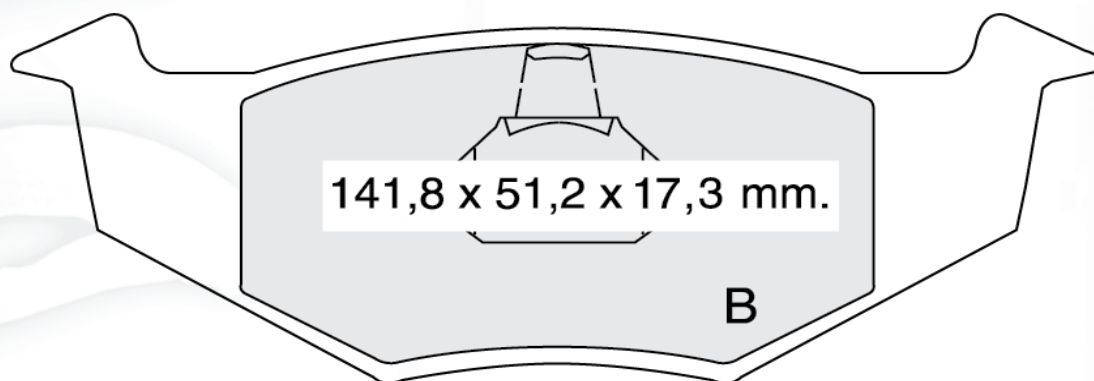
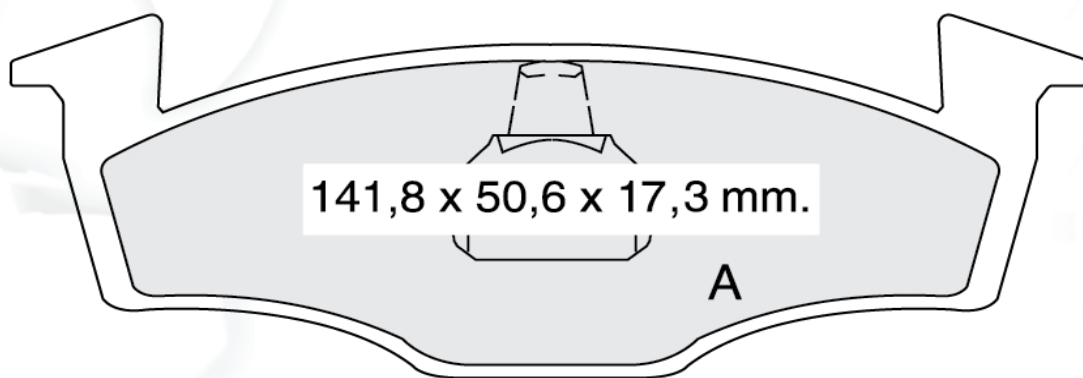

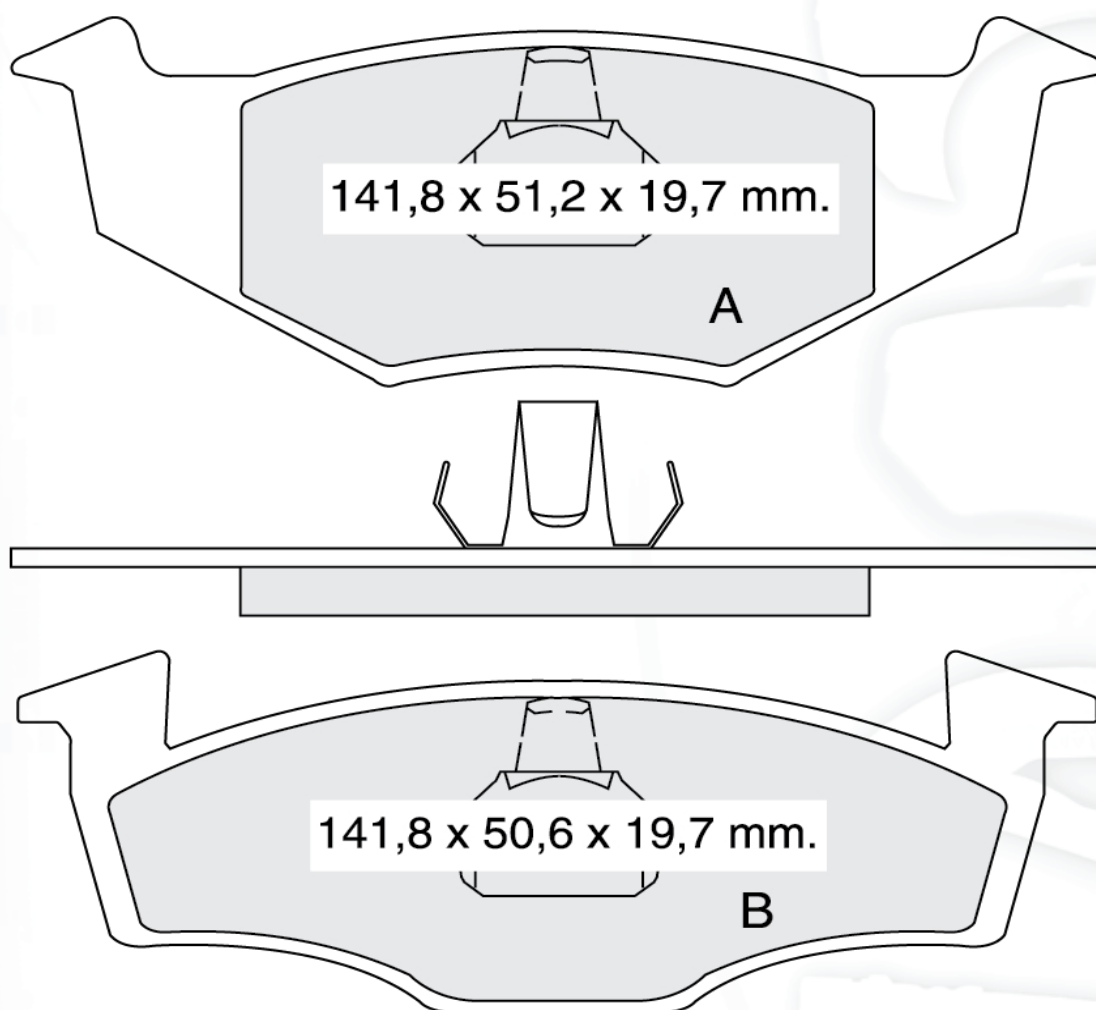

В комплект входят две колодки типа А, две колодки типа В

			W.V.A
<b>Д158</b>		<b>VOLKSWAGEN</b>	<b>21866</b>

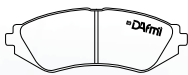
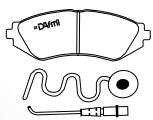

В комплект входят две колодки типа А, две колодки типа В

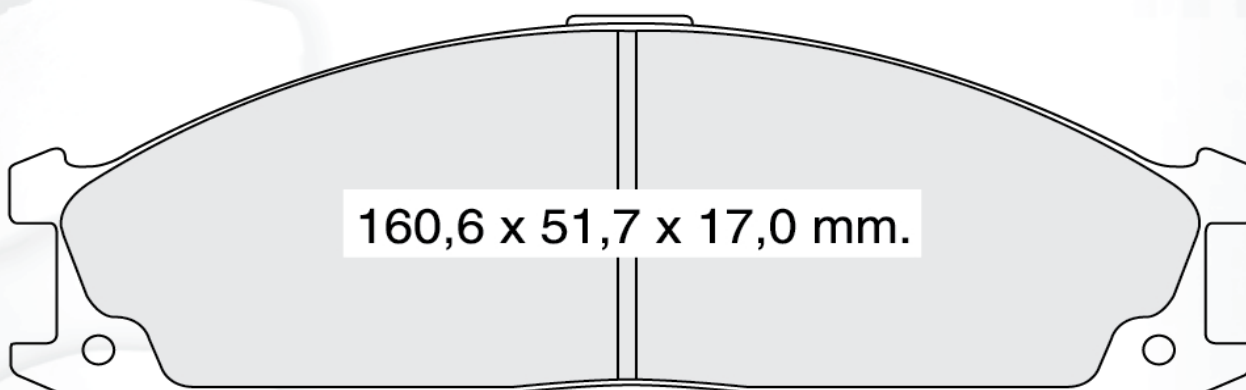

			<p>W.V.A</p>
<p><b>Д159</b></p>		<p><b>NISSAN</b></p>	<p><b>21374</b></p>

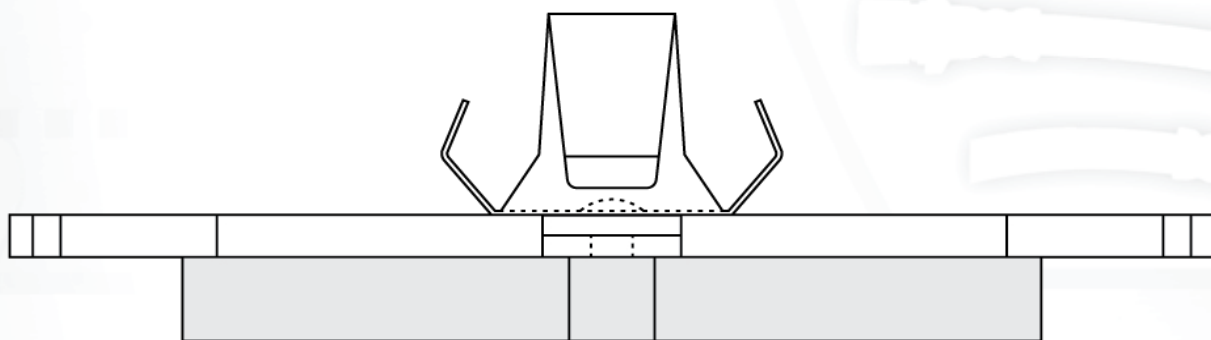
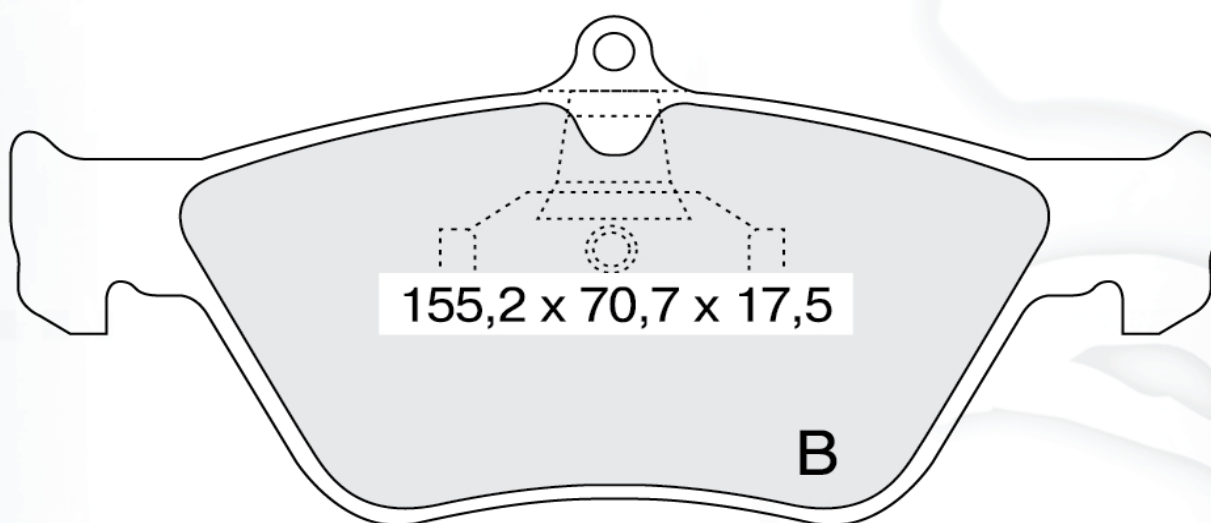
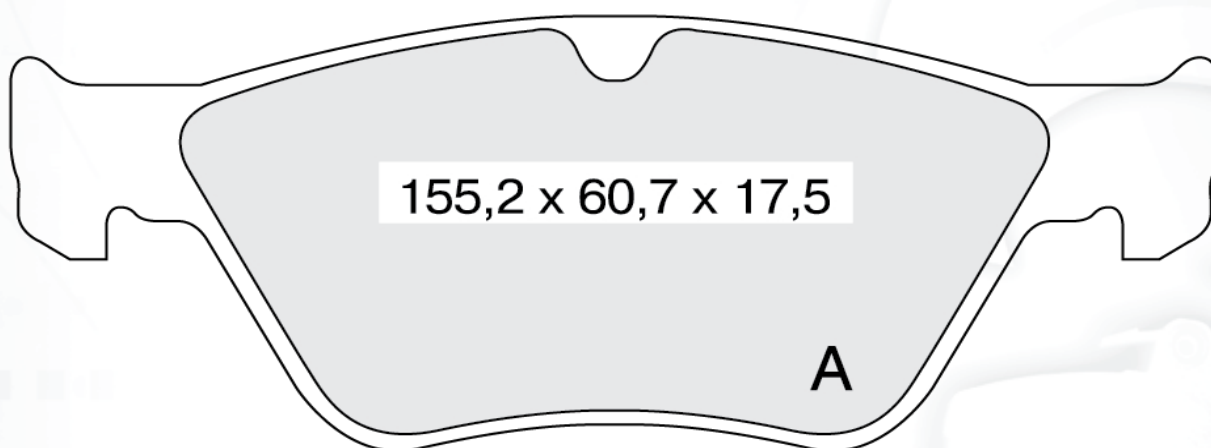

			W.V.A
<b>Д160</b>	<b>Д160И</b>	<b>OPEL, SAAB</b>	<b>21411</b>

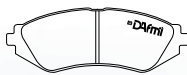
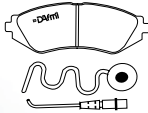

В комплект входят две колодки типа А, две колодки типа В

			W.V.A
<b>Д161</b>	<b>Д161И</b>	<b>VOLKSWAGEN</b>	<b>20887</b>

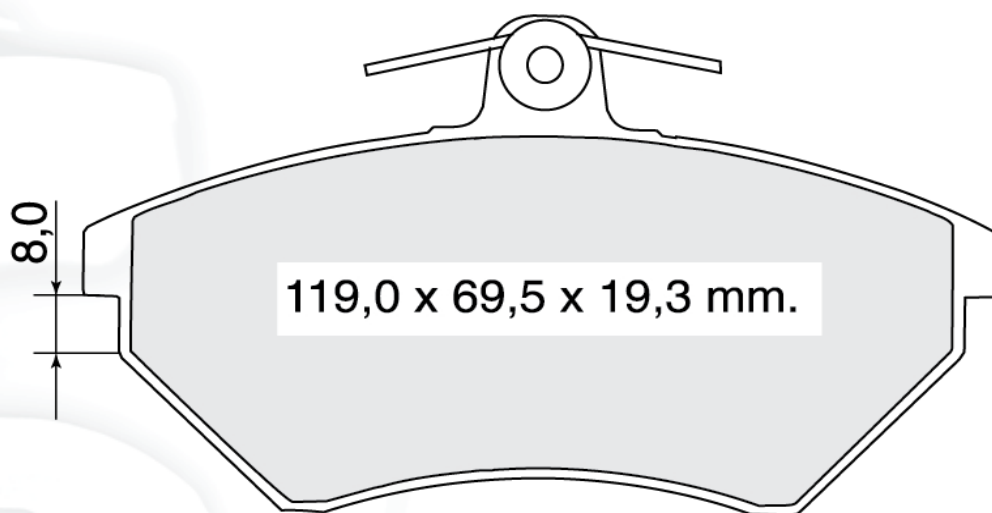

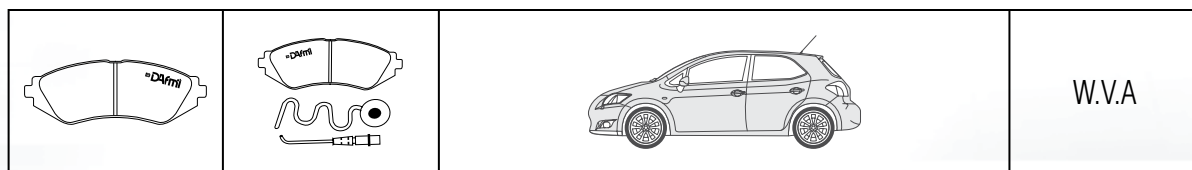

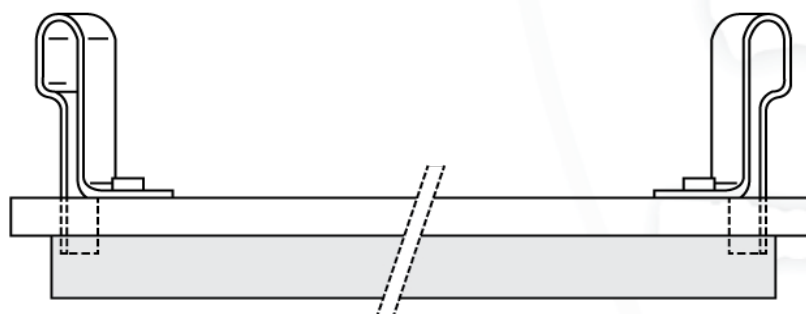
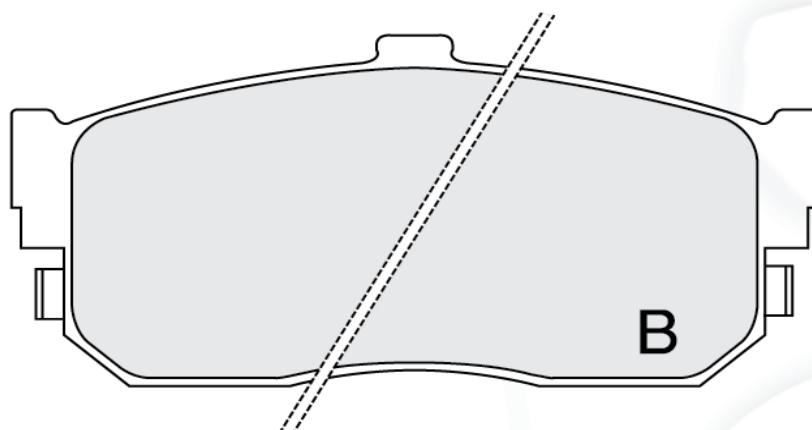
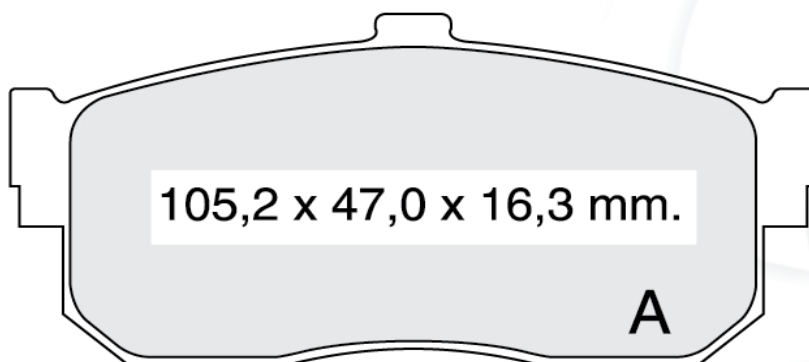

<b>Д162</b>		<b>NISSAN</b>	
-------------	--	---------------	--

Индикатор износа входит в базовую комплектацию данной колодки.

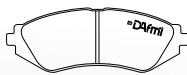
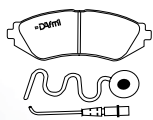

В комплект входят две колодки типа А, две колодки типа В

			<p>W.V.A</p>
<p><b>Д163</b></p>		<p><b>NISSAN</b></p>	<p><b>21545</b></p>

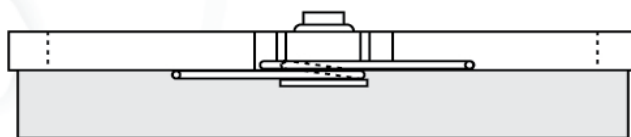
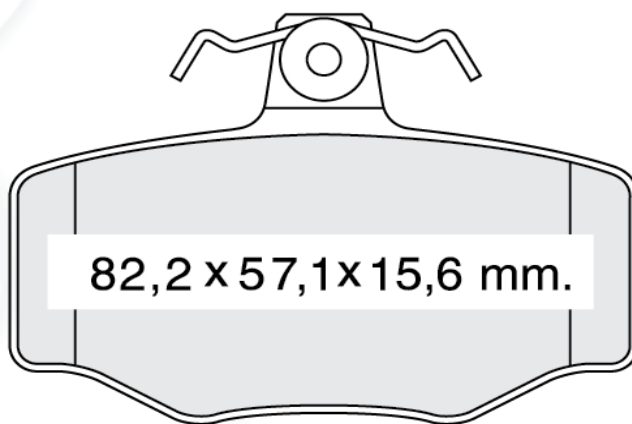

			W.V.A
--	--	--	-------

<b>Д164</b>	<b>Д164И</b>	<b>IVECO</b>	<b>29121</b>
-------------	--------------	--------------	--------------

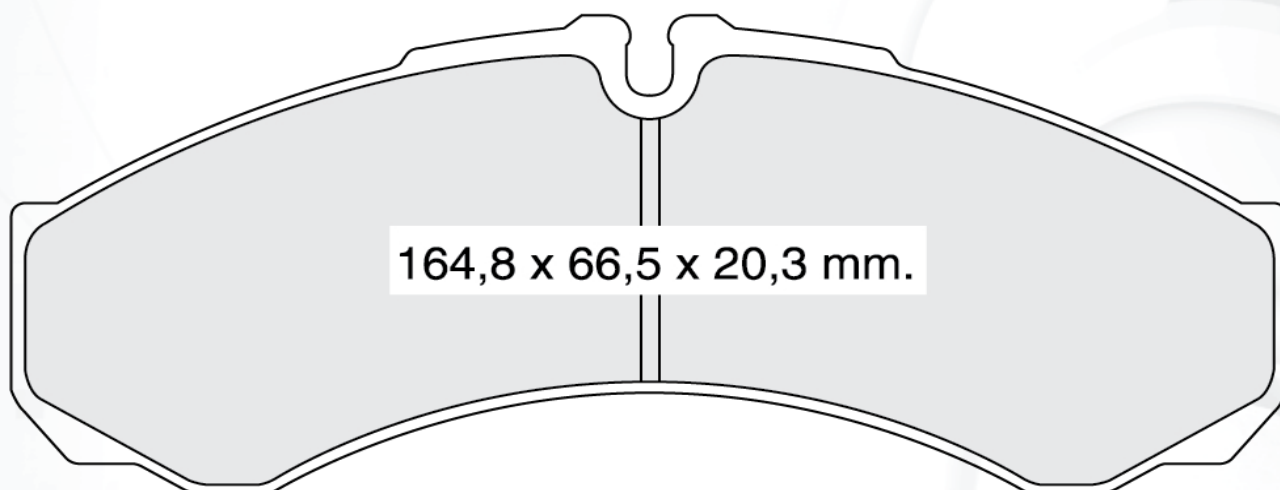

	<b>Д165И</b>	<b>NISSAN</b>	
--	--------------	---------------	--

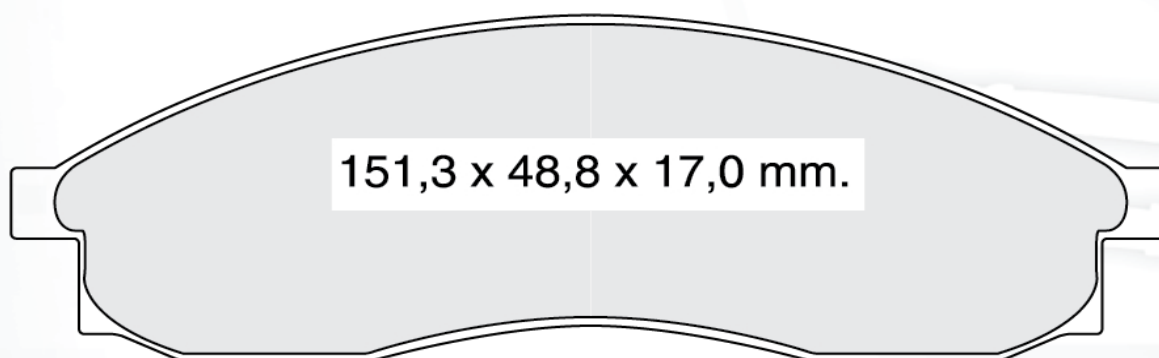

В комплект входят две колодки типа А, две колодки типа В



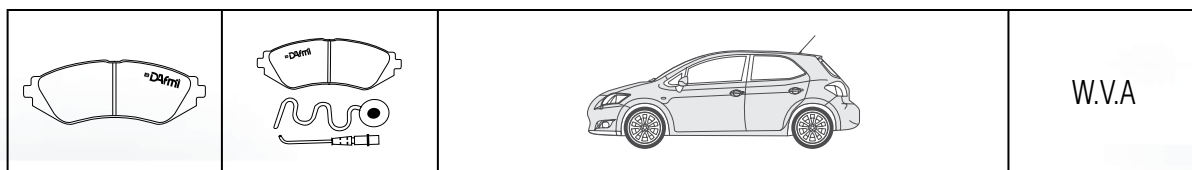

<b>Д167</b>	<b>Д167И</b>	<b>MERSCEDES-BENZ</b>	<b>23021</b>
-------------	--------------	-----------------------	--------------

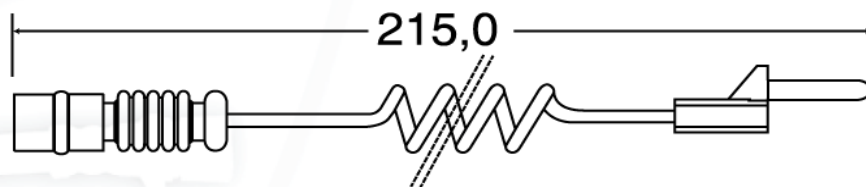
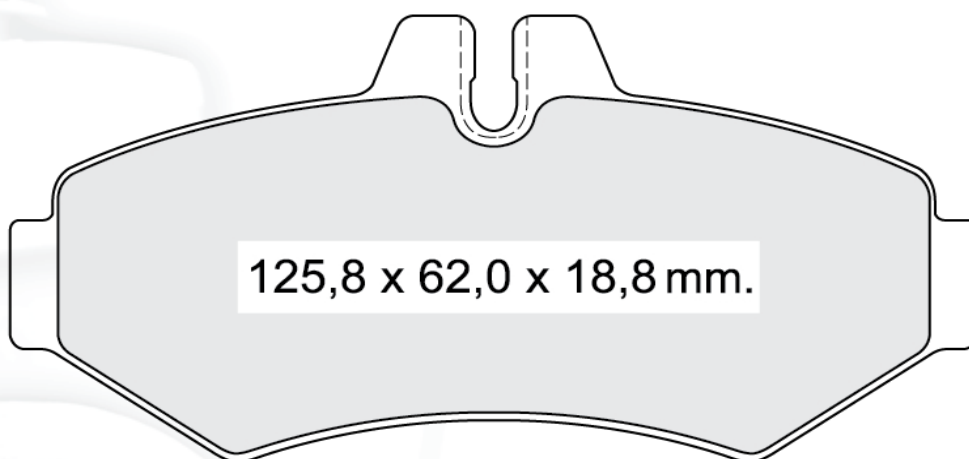

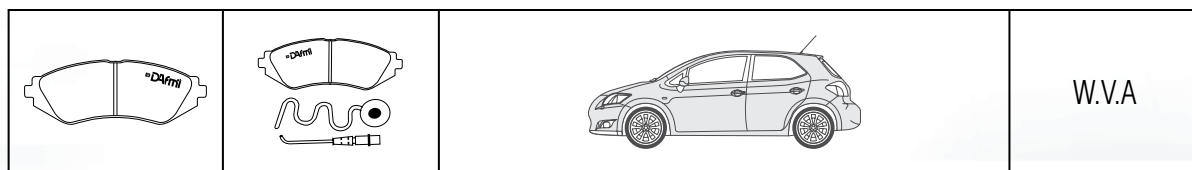

<b>Д168</b>		<b>IVECO</b>	<b>29040</b>
-------------	--	--------------	--------------

Индикатор износа входит в базовую комплектацию данной колодки.

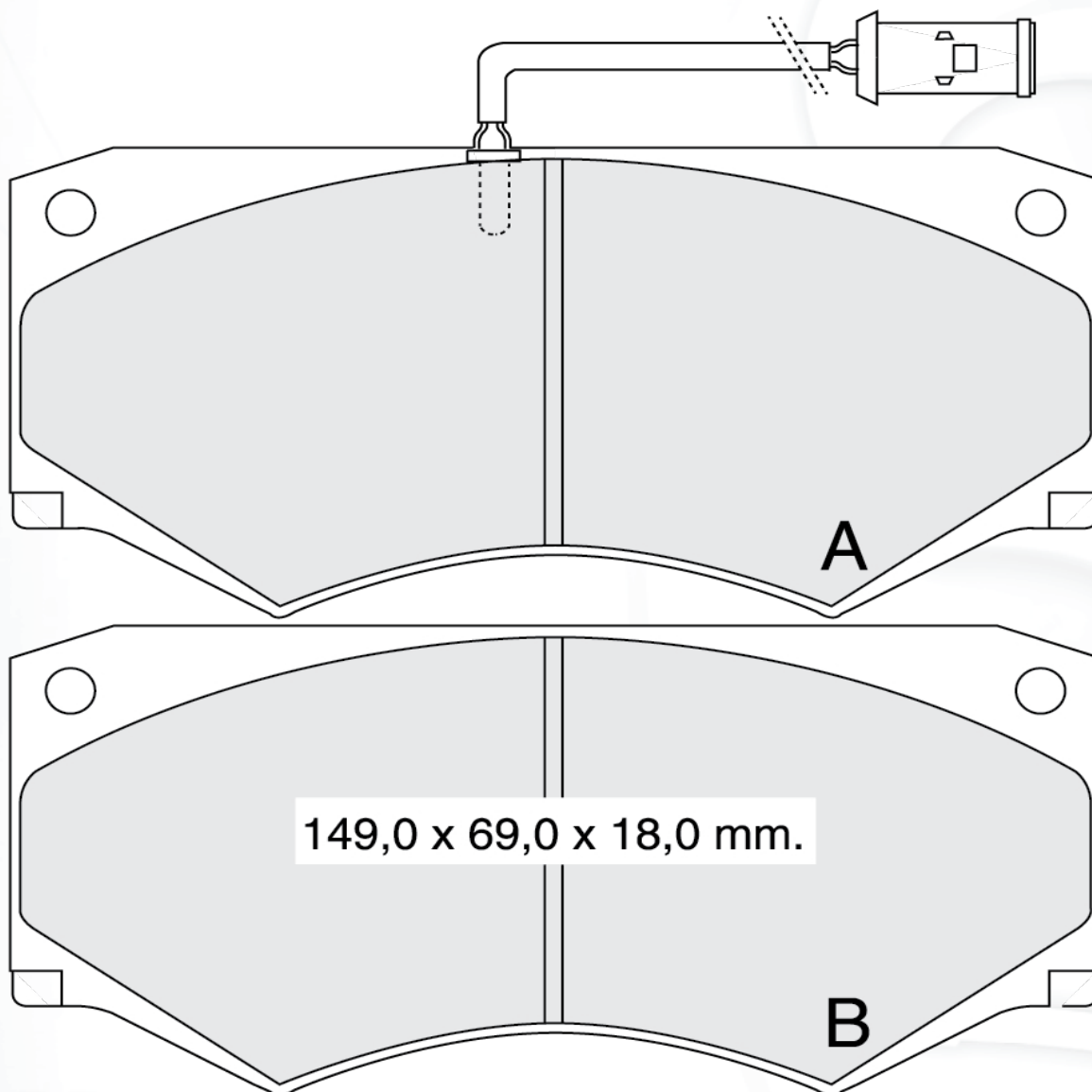

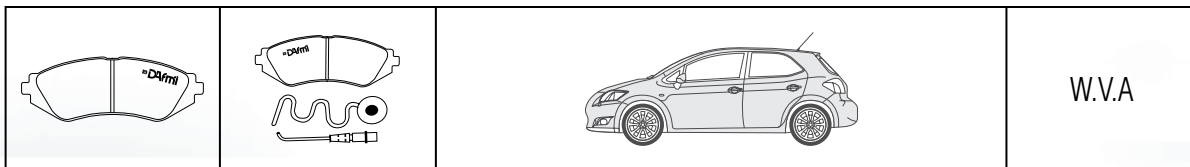

В комплект входят две колодки типа А, две колодки типа В

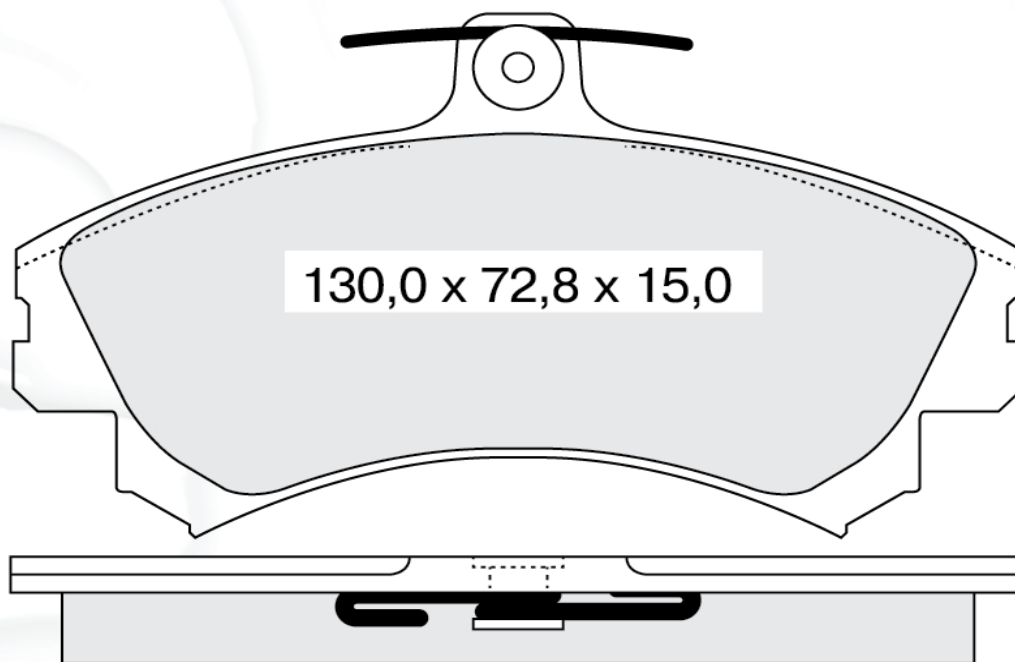

<b>Д169</b>	<b>Д169И</b>	<b>MITSUBISHI, VOLVO</b>	<b>21920</b>
-------------	--------------	--------------------------	--------------

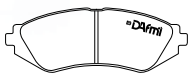
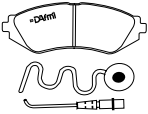



			W.V.A
---	---	--	-------

<b>Д172</b>		<b>TOYOTA</b>	<b>21775</b>
-------------	--	---------------	--------------

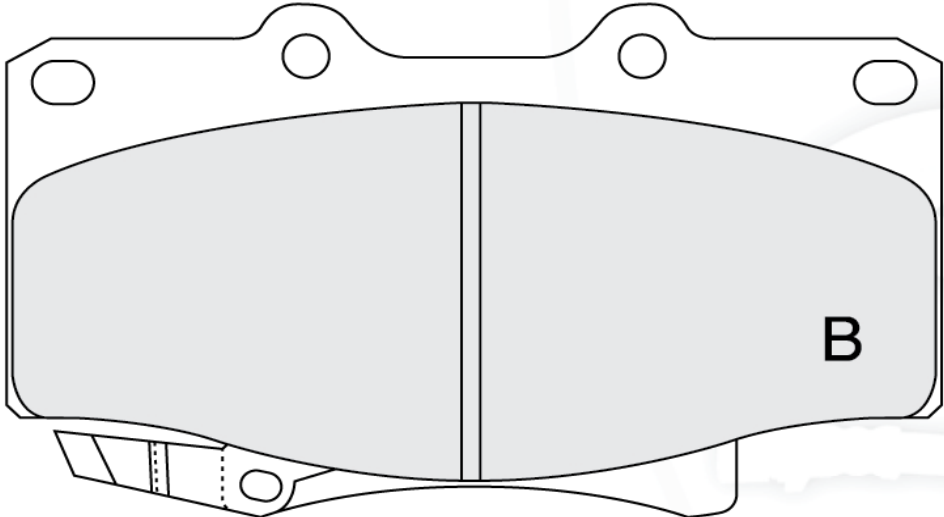
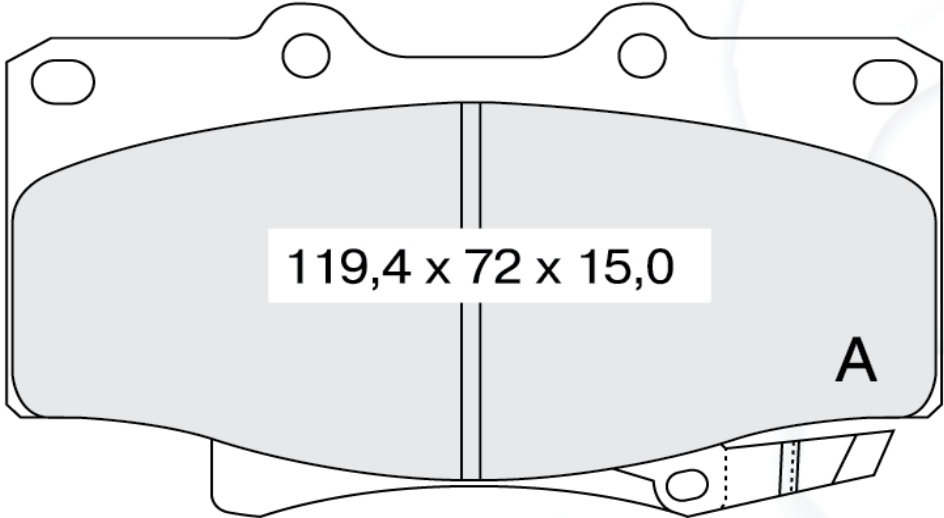
Индикатор износа входит в базовую комплектацию данной колодки.

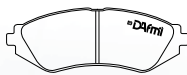
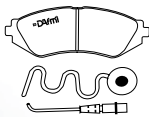

В комплект входят две колодки типа А, две колодки типа В

			W.V.A
---	---	--	-------

<b>Д173</b>		<b>VOLKSWAGEN</b>	<b>20979</b>
-------------	--	-------------------	--------------

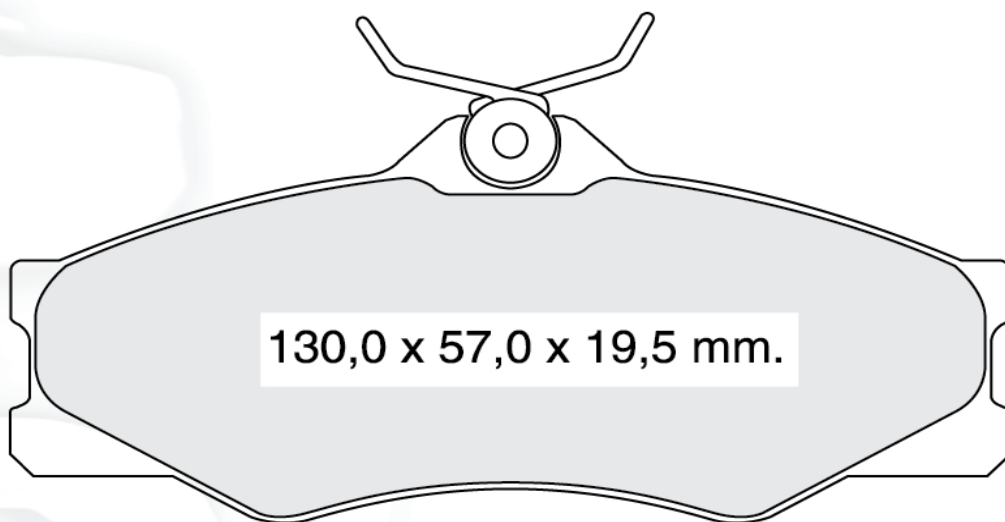



			W.V.A
--	--	--	-------

<b>Д174</b>		<b>SUBARU, SUZUKI</b>	<b>21333</b>
-------------	--	-----------------------	--------------

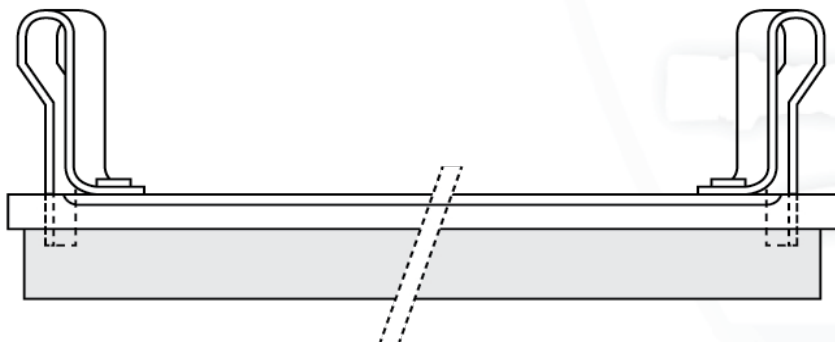
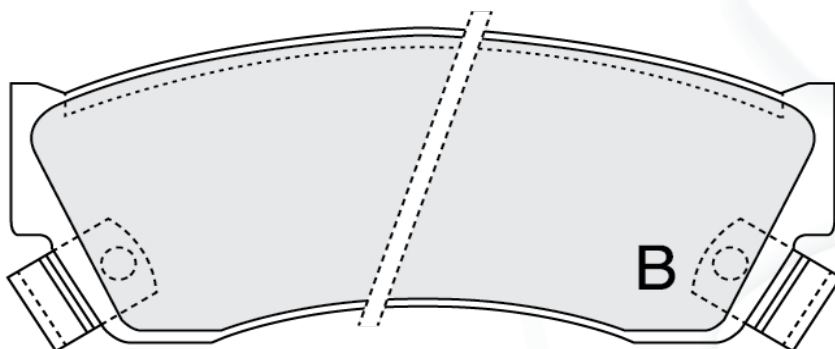
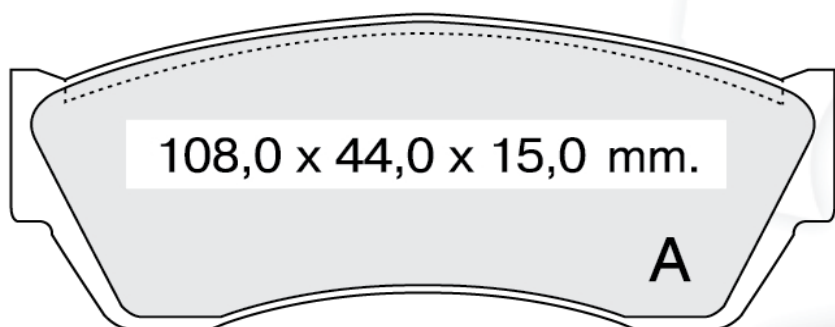
Индикатор износа входит в базовую комплектацию данной колодки.

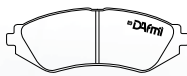
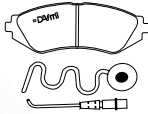

В комплект входят две колодки типа А, две колодки типа В

			W.V.A
<b>Д175</b>		<b>ISUZU</b>	<b>21115</b>

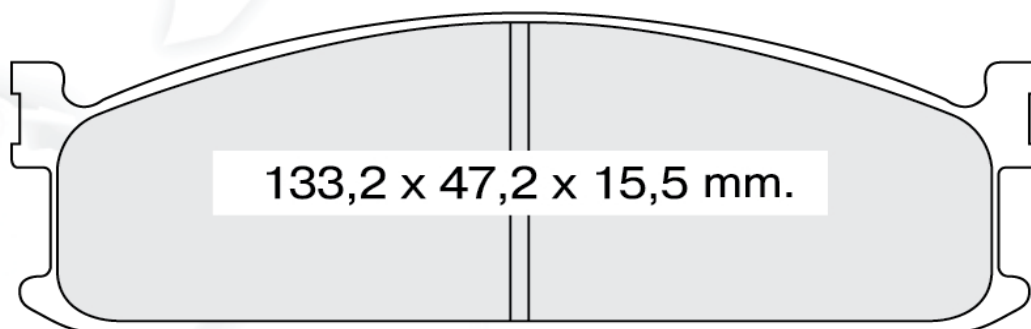

			W.V.A
<b>Д176</b>		<b>VOLVO</b>	<b>21273</b>

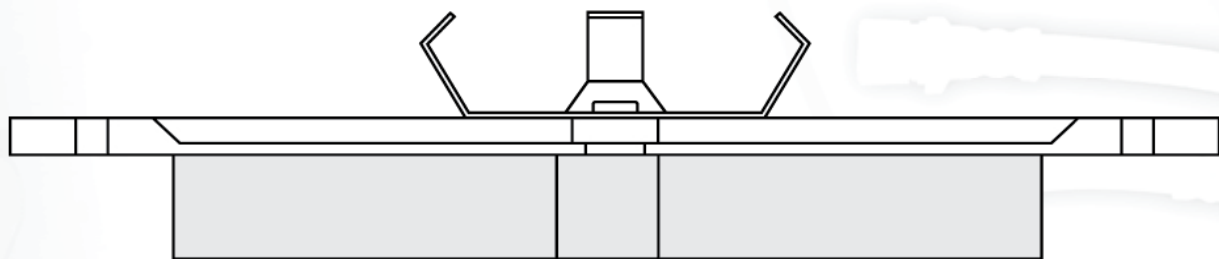
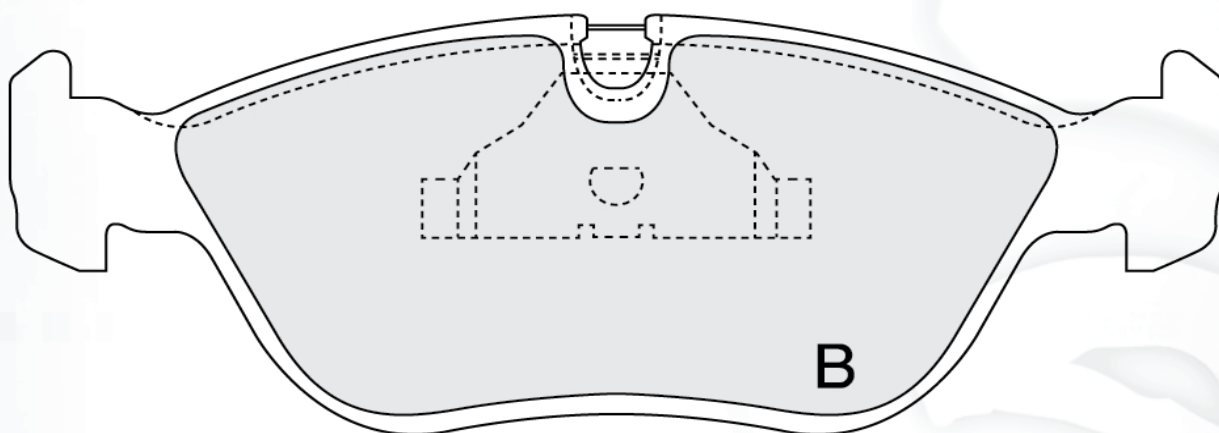
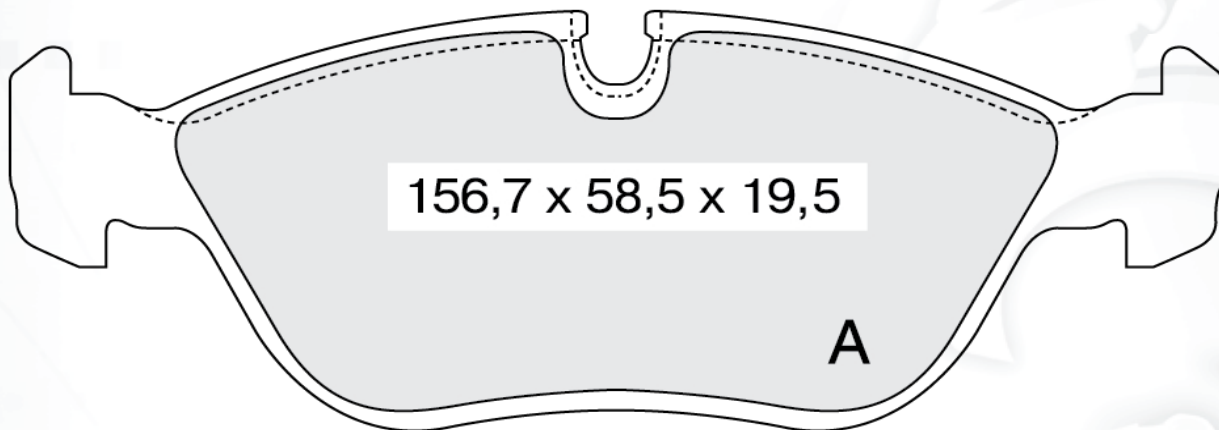

В комплект входят две колодки типа А, две колодки типа В



			W.V.A
--	--	--	-------

<b>Д177</b>		<b>VOLKSWAGEN</b>	<b>21866</b>
-------------	--	-------------------	--------------

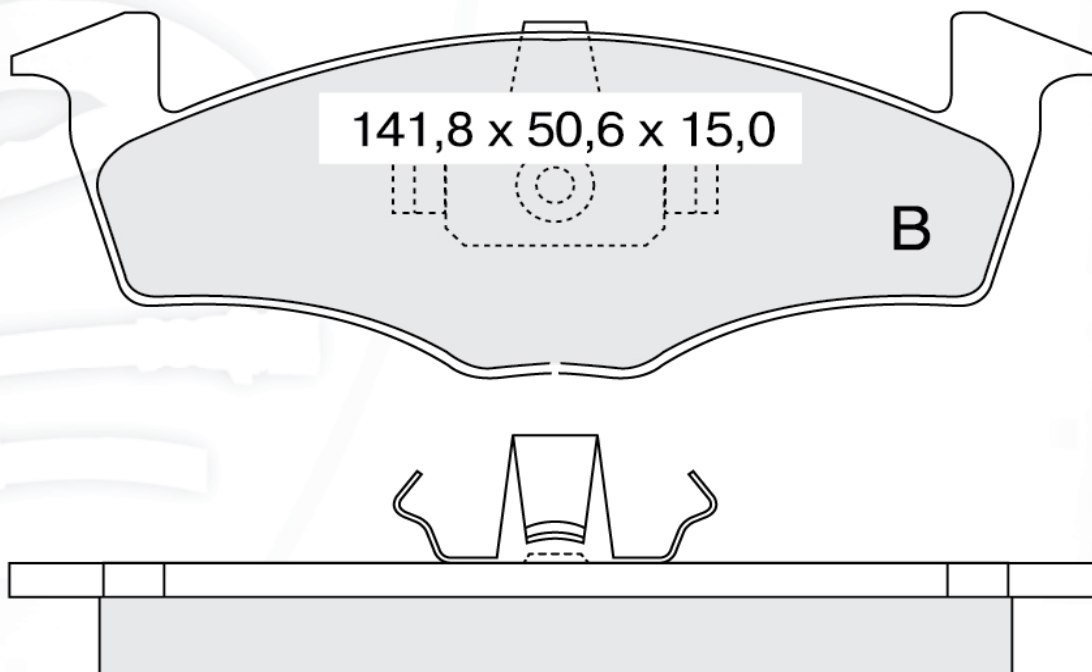
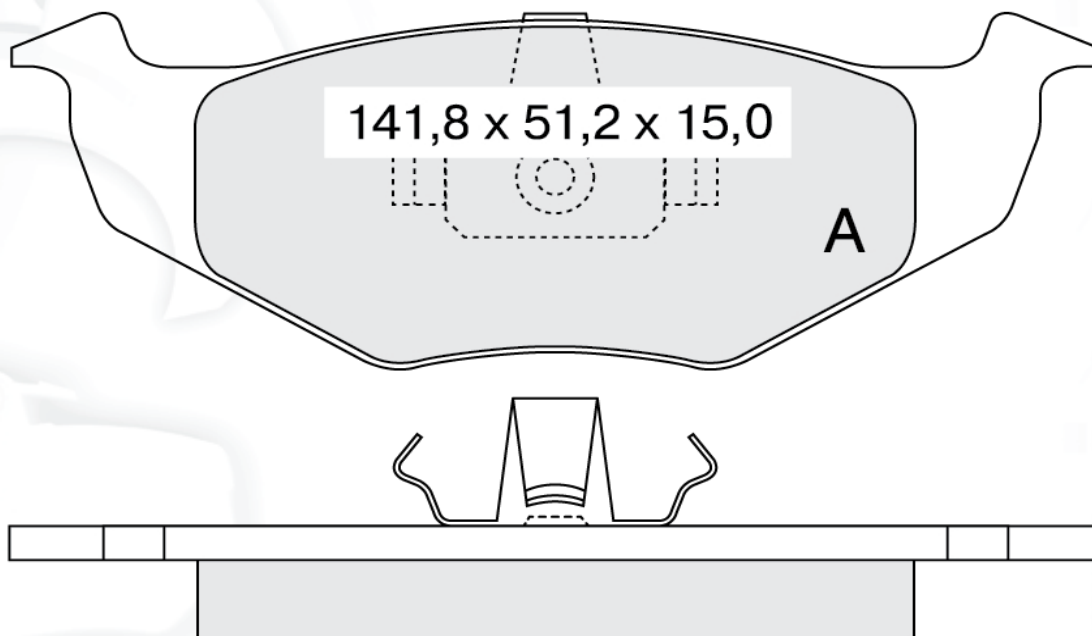

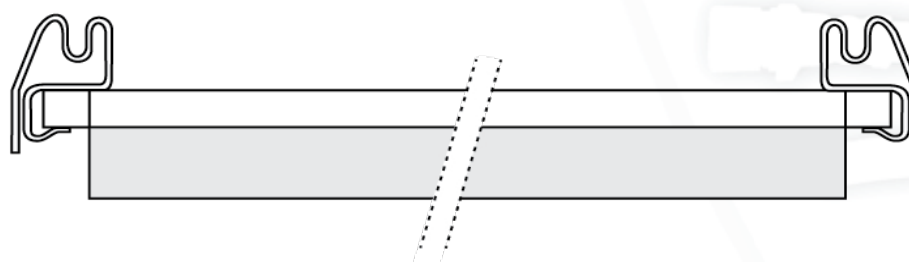
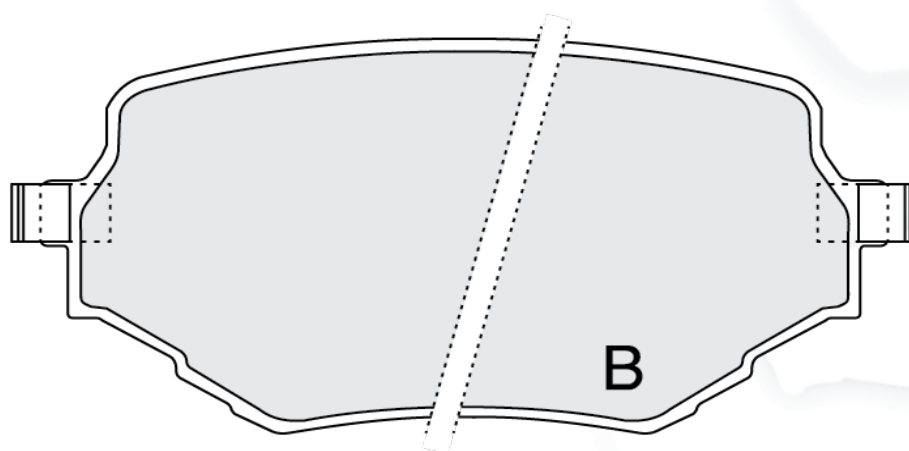
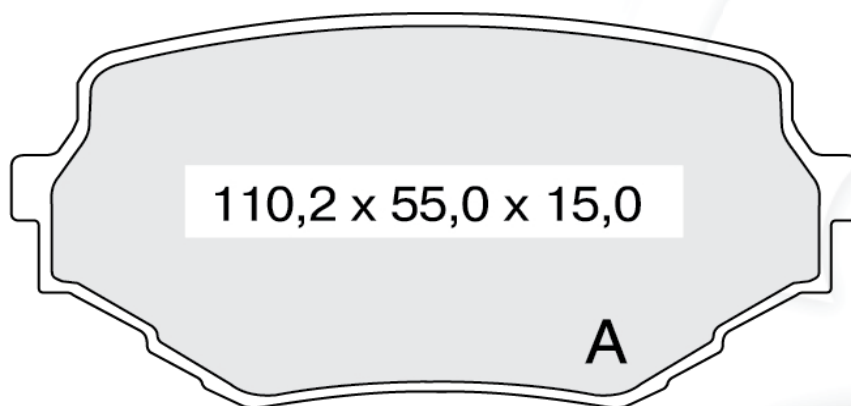

В комплект входят две колодки типа А, две колодки типа В

			W.V.A
<b>Д178</b>	<b>Д178И</b>	<b>SUZUKI</b>	



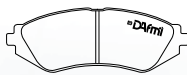
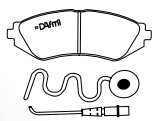

В комплект входят две колодки типа А, две колодки типа В

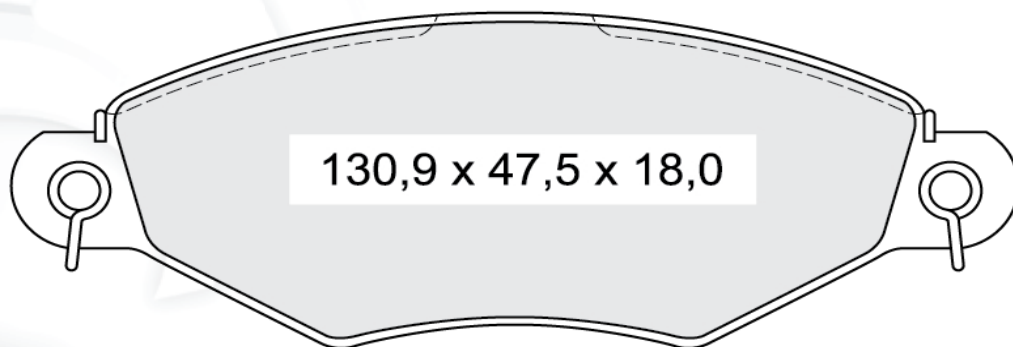
			<p>W.V.A</p>
<p><b>Д179</b></p>		<p><b>PEUGEOT</b></p>	<p><b>21980</b></p>

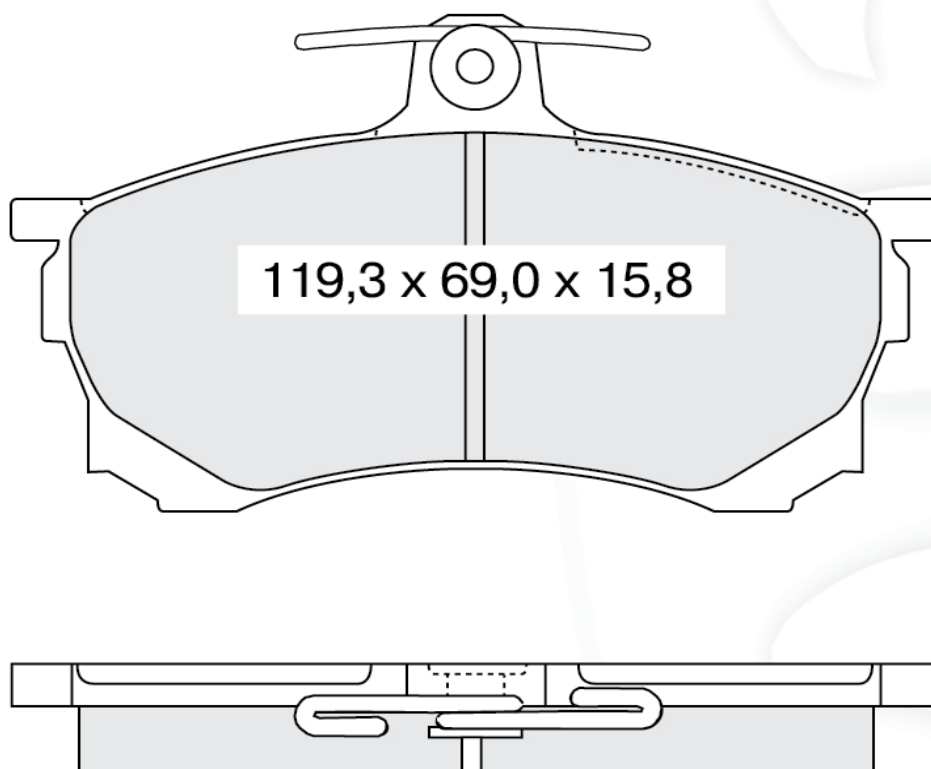

			W.V.A
<b>Д180</b>	<b>Д180И</b>	<b>МITSUBISHI</b>	

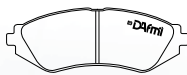
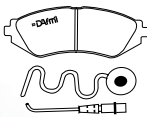

			W.V.A
---	---	--	-------

<b>Д181</b>		<b>NISSAN</b>	<b>23004</b>
-------------	--	---------------	--------------

Индикатор износа входит в базовую комплектацию данной колодки.

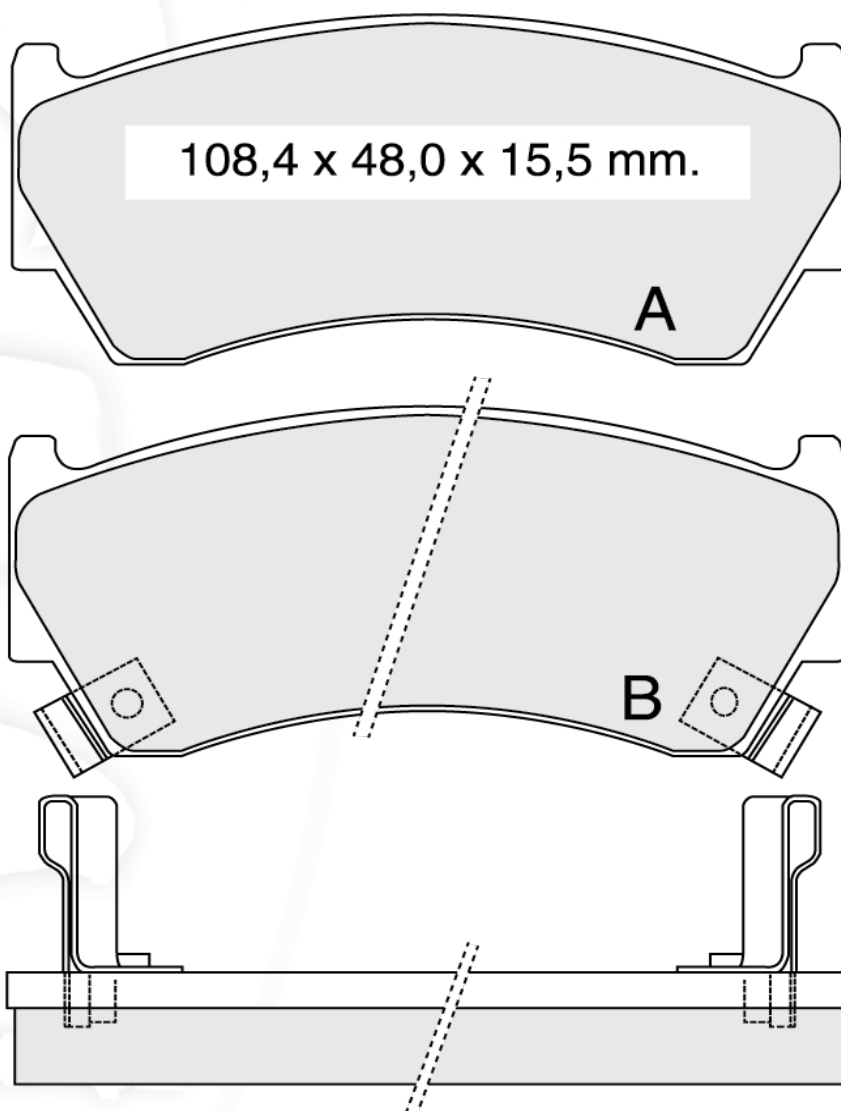

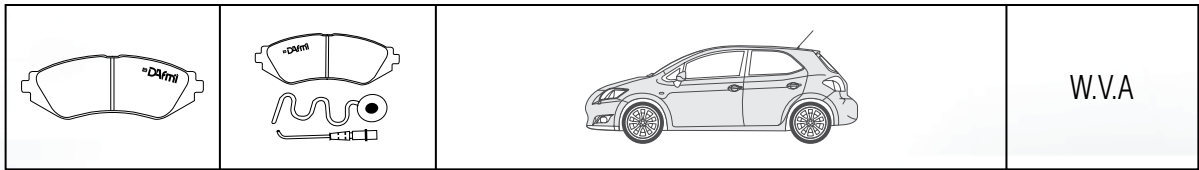

В комплект входят две колодки типа А, две колодки типа В

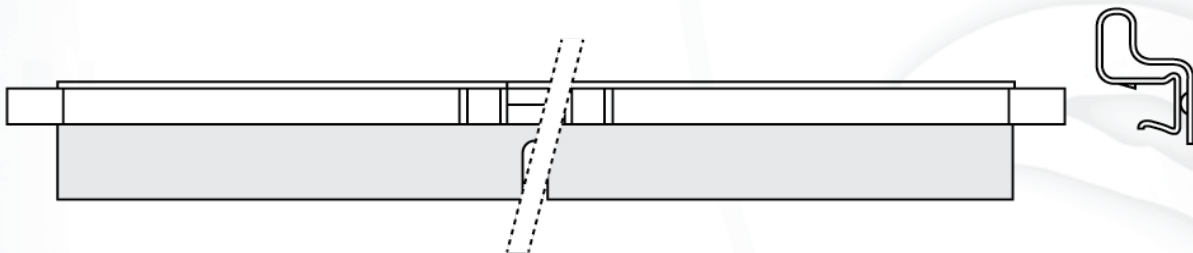
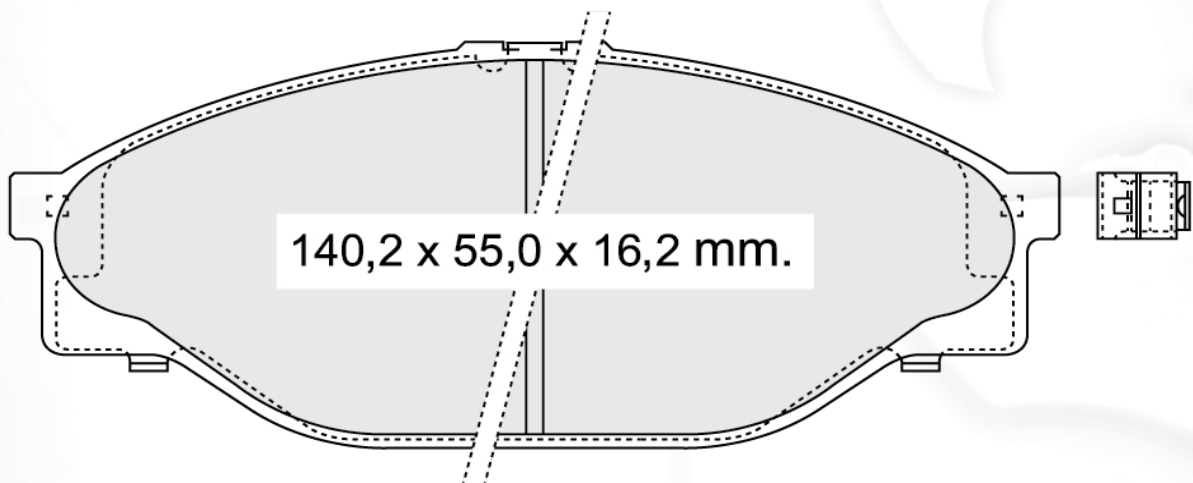

<b>Д183</b>	<b>Д183И</b>	<b>ТОУОТА</b>	<b>21689</b>
-------------	--------------	---------------	--------------

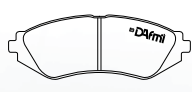
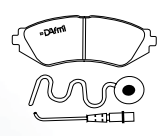

			W.V.A
---	---	--	-------

	<b>Д184И</b>	<b>OPEL</b>	<b>23063</b>
--	--------------	-------------	--------------

Изображение в масштабе

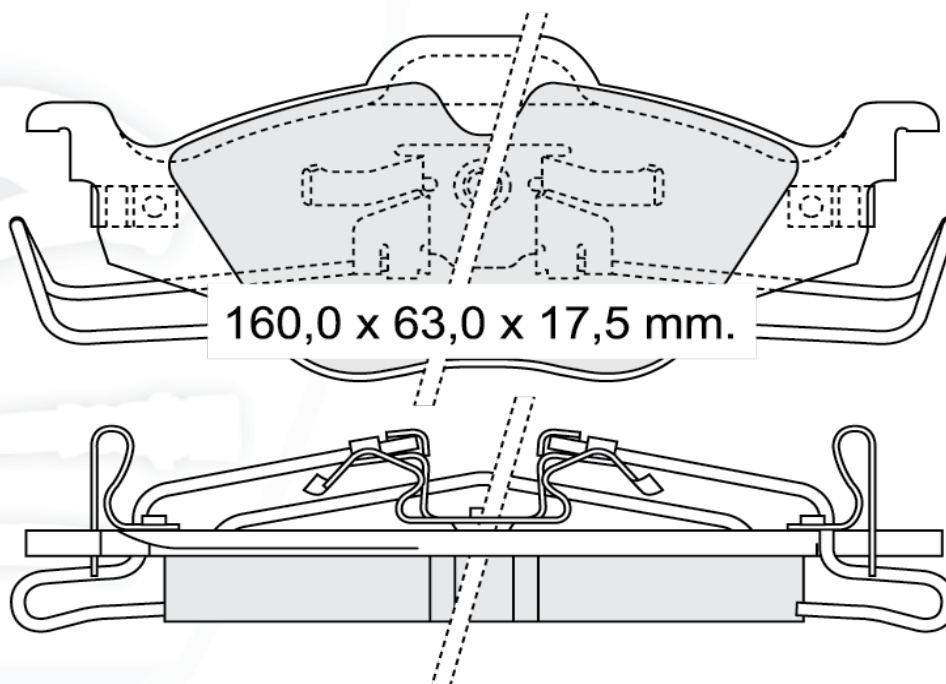
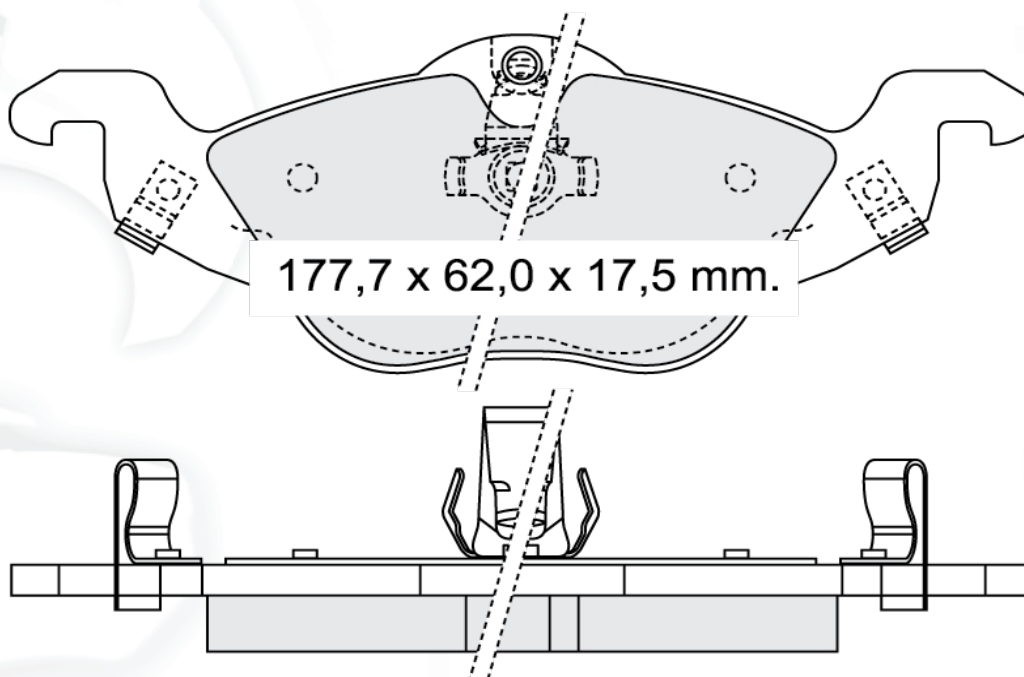

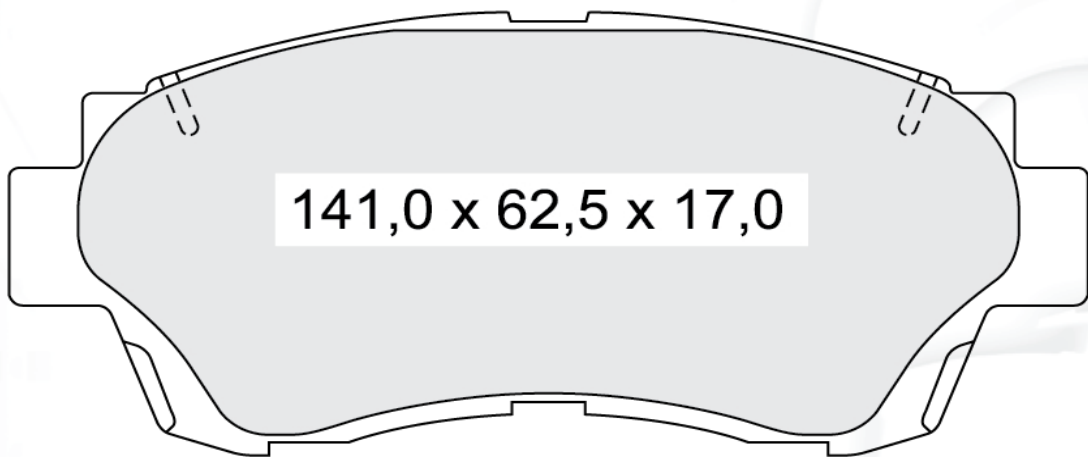

			W.V.A
<b>Д185</b>		<b>TOYOTA</b>	<b>21791</b>

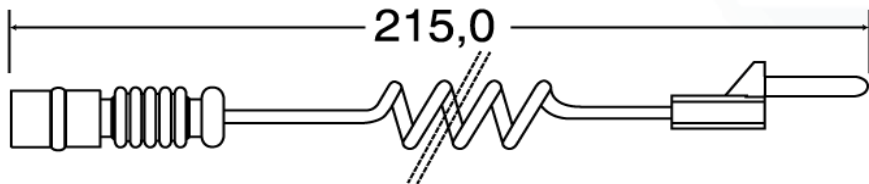
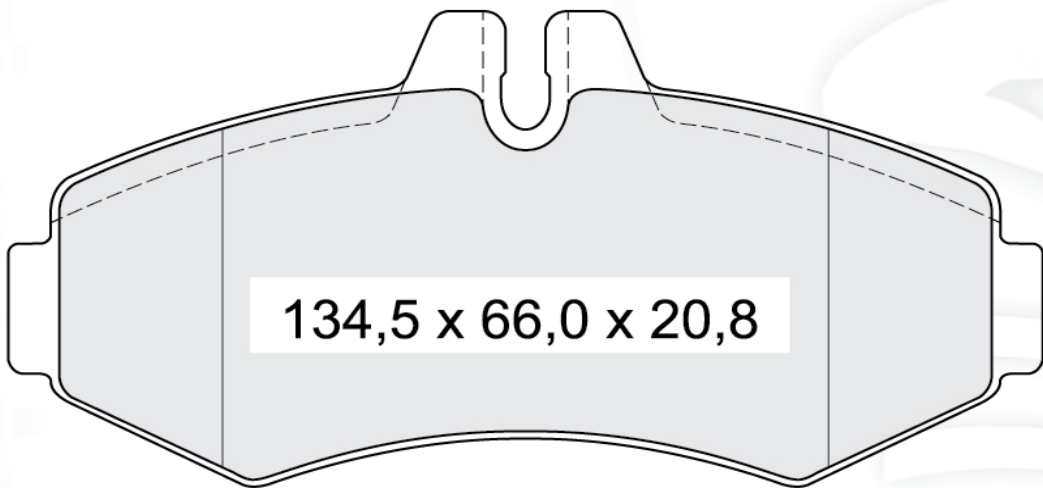

<b>Д186</b>	<b>Д186И</b>	<b>MERCEDES</b>	<b>23022</b>
-------------	--------------	-----------------	--------------



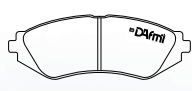
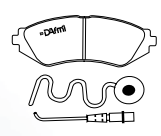

			W.V.A
---	---	--	-------

<b>Д187</b>		<b>MERCEDES</b>	<b>23020</b>
-------------	--	-----------------	--------------

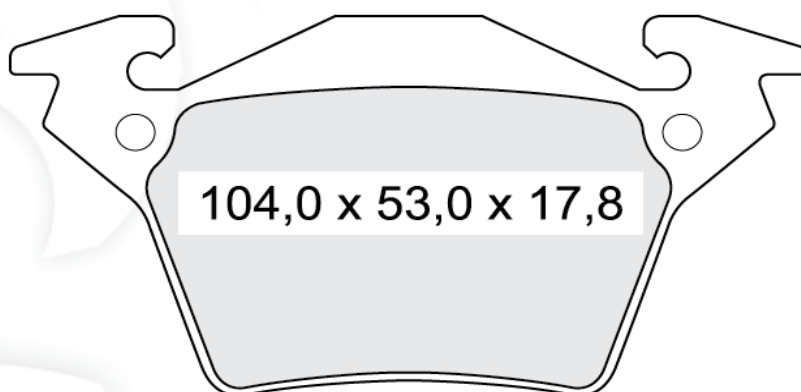

<b>Д188</b>		<b>MITSUBISHI</b>	<b>21706</b>
-------------	--	-------------------	--------------

Индикатор износа входит в базовую комплектацию данной колодки

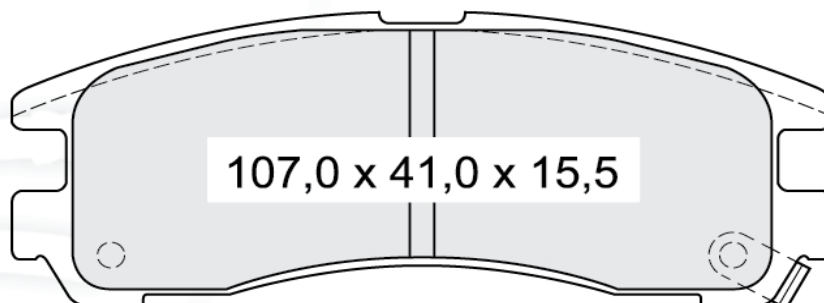

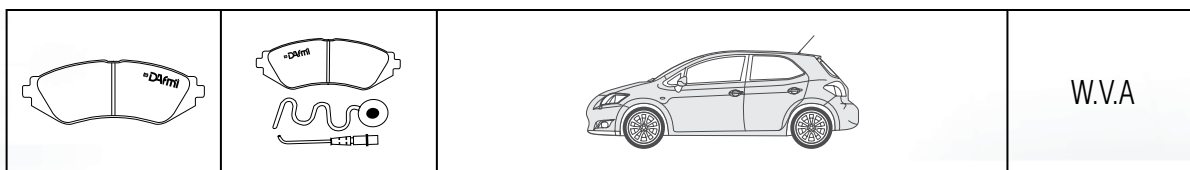

<b>Д189</b>		<b>FORD</b>	<b>23154</b>
-------------	--	-------------	--------------

Изображение в масштабе

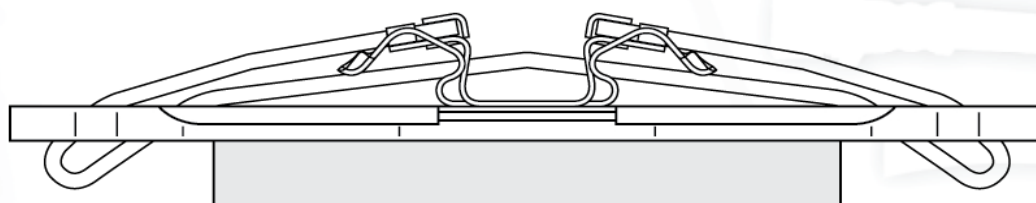
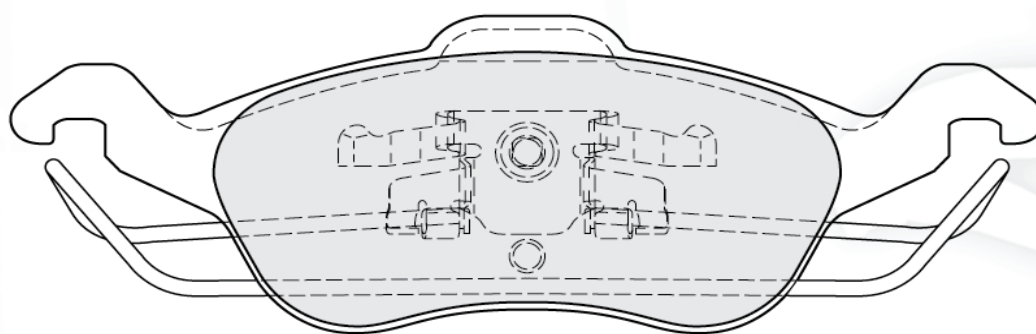
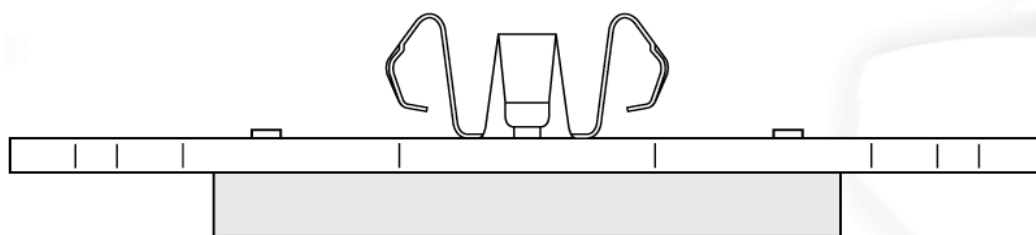
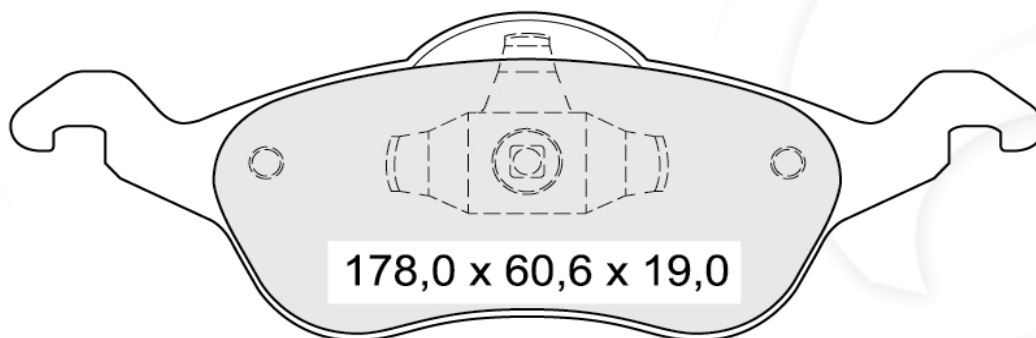

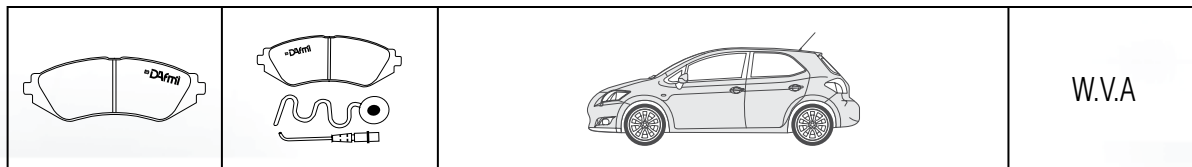

Д190		CHEVROLET	23974
------	--	-----------	-------

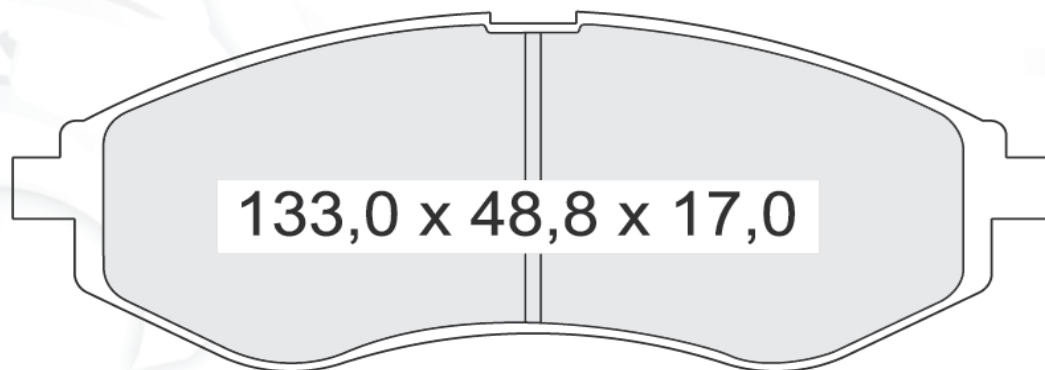

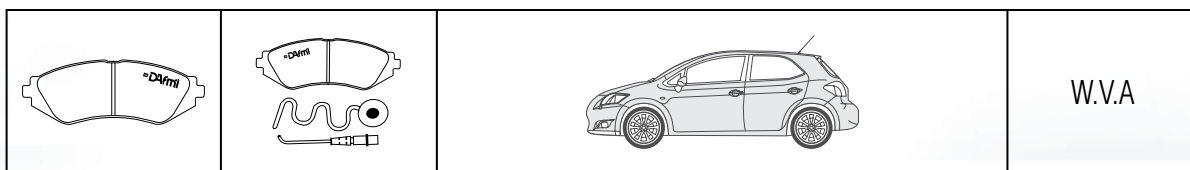

<b>Д191</b>	-	<b>HYUNDAI</b>	<b>23891</b>
-------------	---	----------------	--------------

Индикатор износа входит в базовую комплектацию данной колодки

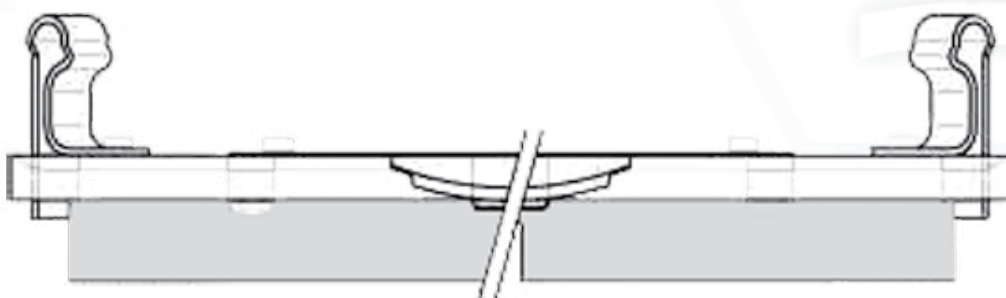
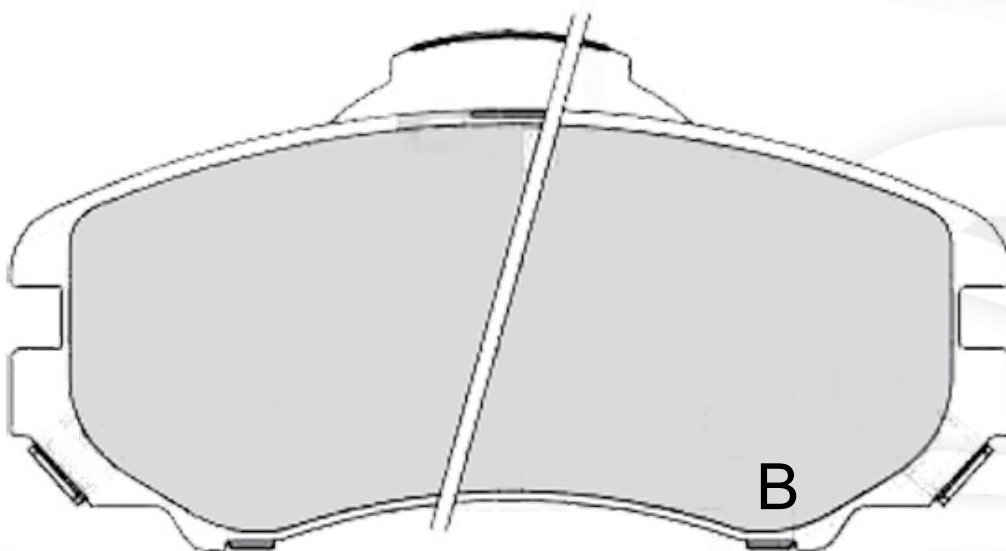
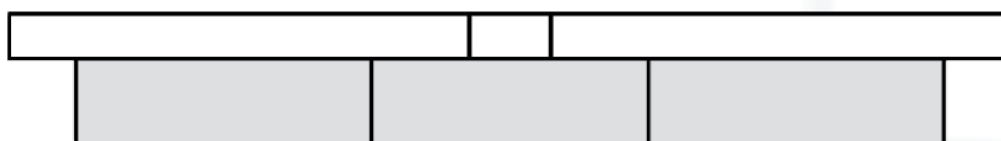
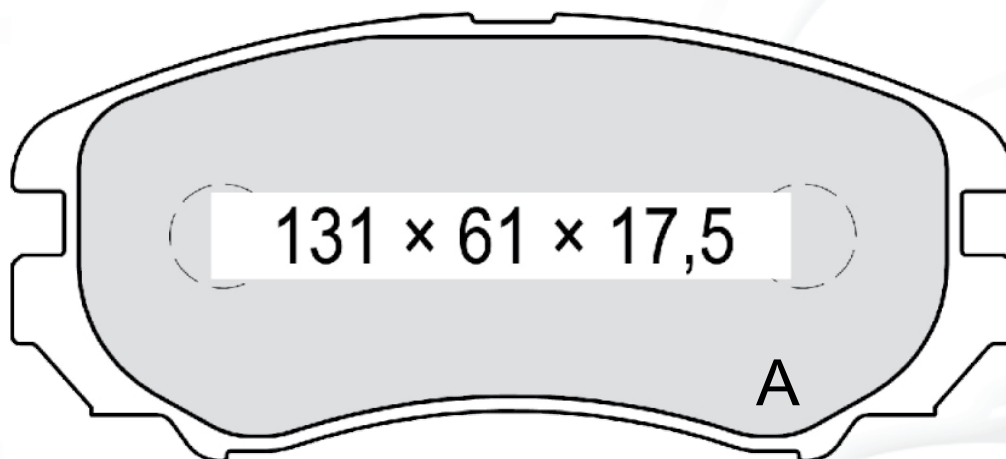

В комплект входят две колодки типа А, две колодки типа В

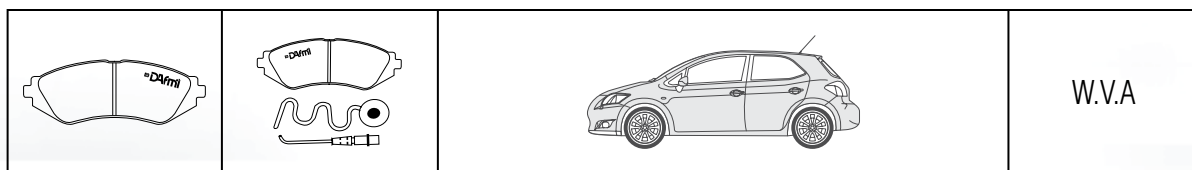

<b>Д192</b>	-	<b>МITSUBISHI</b>	<b>23584</b>
-------------	---	-------------------	--------------

Индикатор износа входит в базовую комплектацию данной колодки

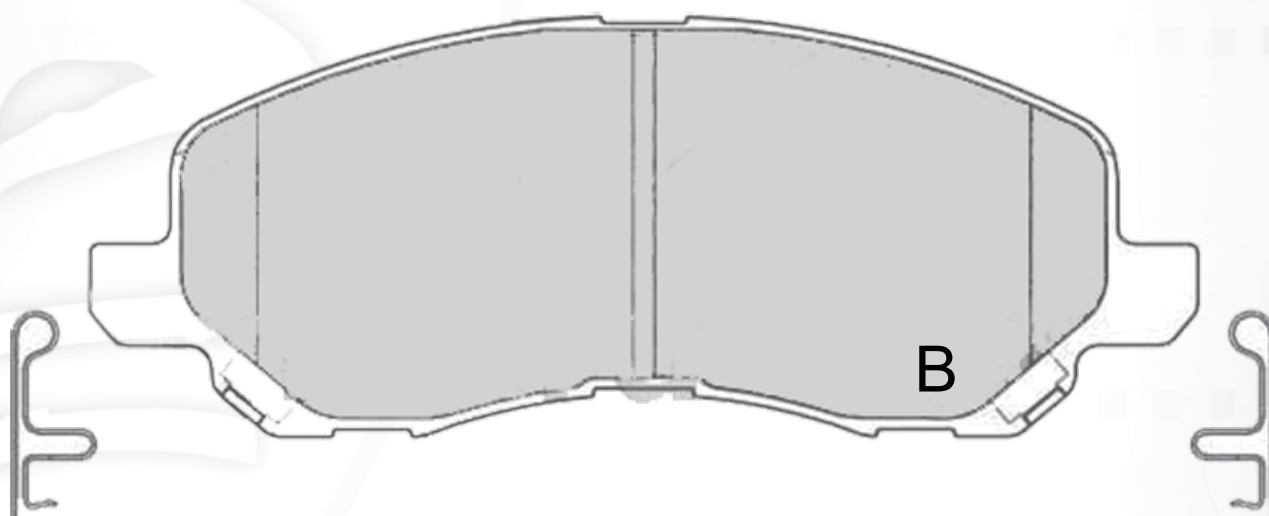
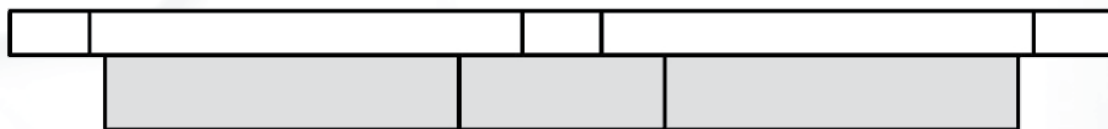
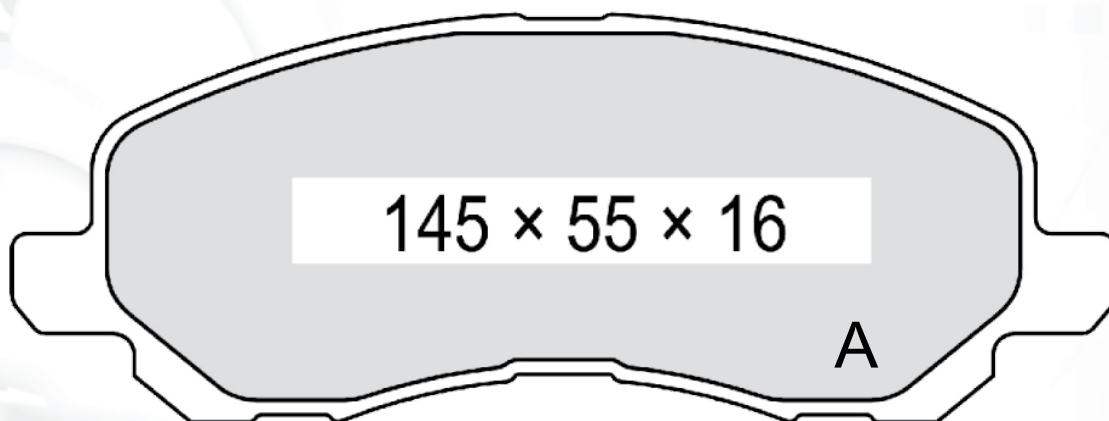

В комплект входят две колодки типа А, две колодки типа В

			W.V.A
--	--	--	-------

<b>Д193</b>	-	<b>KIA</b>	-
-------------	---	------------	---

Индикатор износа входит в базовую комплектацию данной колодки

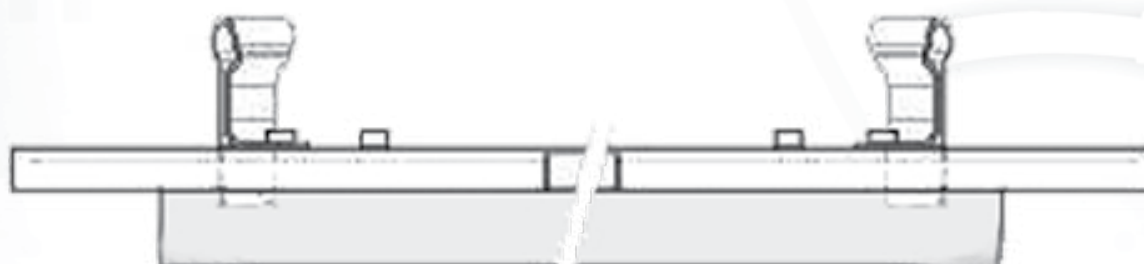
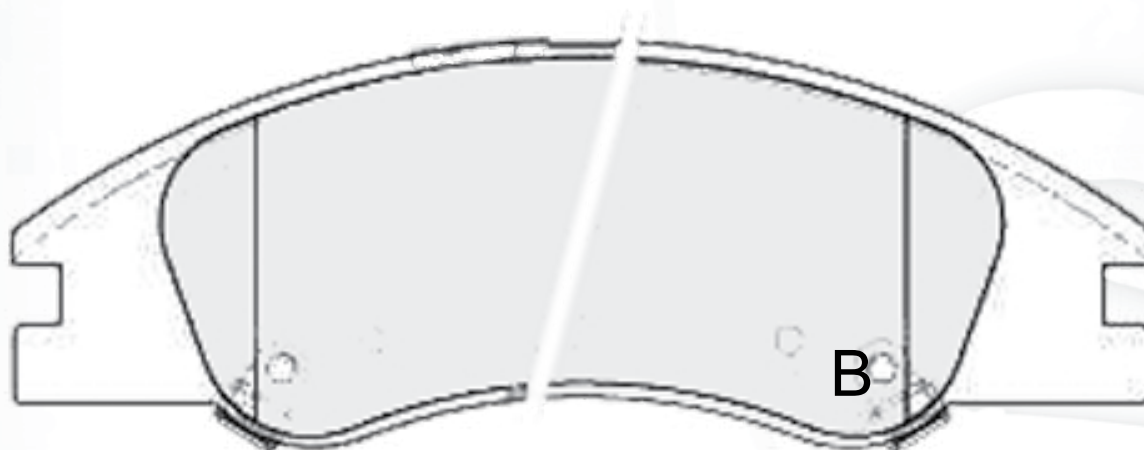
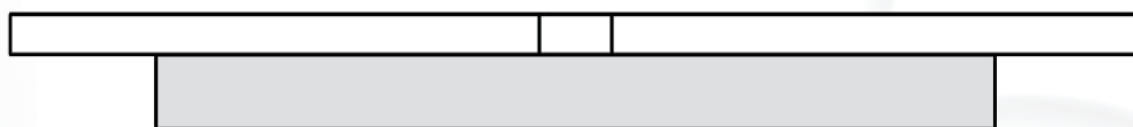
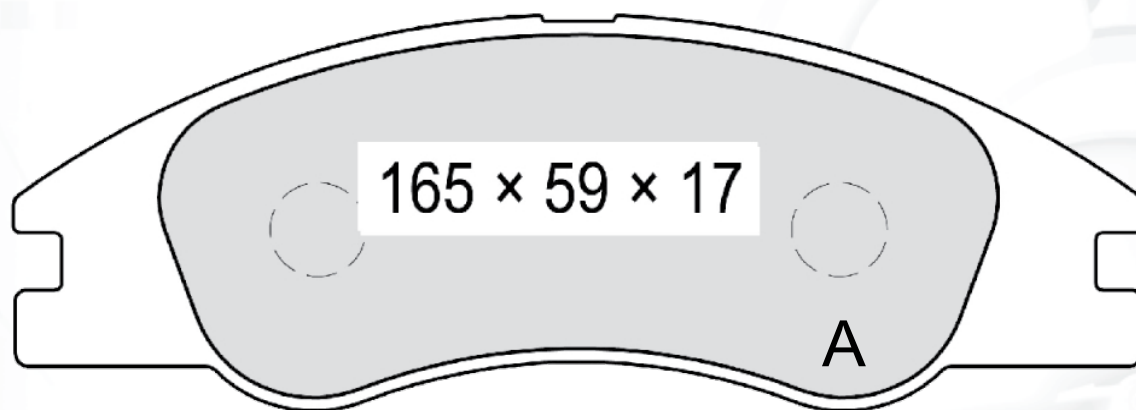

В комплект входят две колодки типа А, две колодки типа В

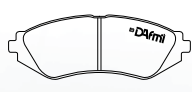
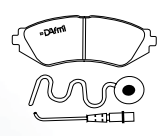
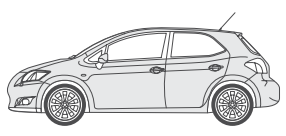
			W.V.A
---	---	--	-------

<b>Д194</b>	-	<b>AUDI, SEAT, SKODA, VOLKSWAGEN</b>	<b>23587/ 23588/ 23589</b>
-------------	---	--	--------------------------------

Индикатор износа входит в базовую комплектацию данной колодки

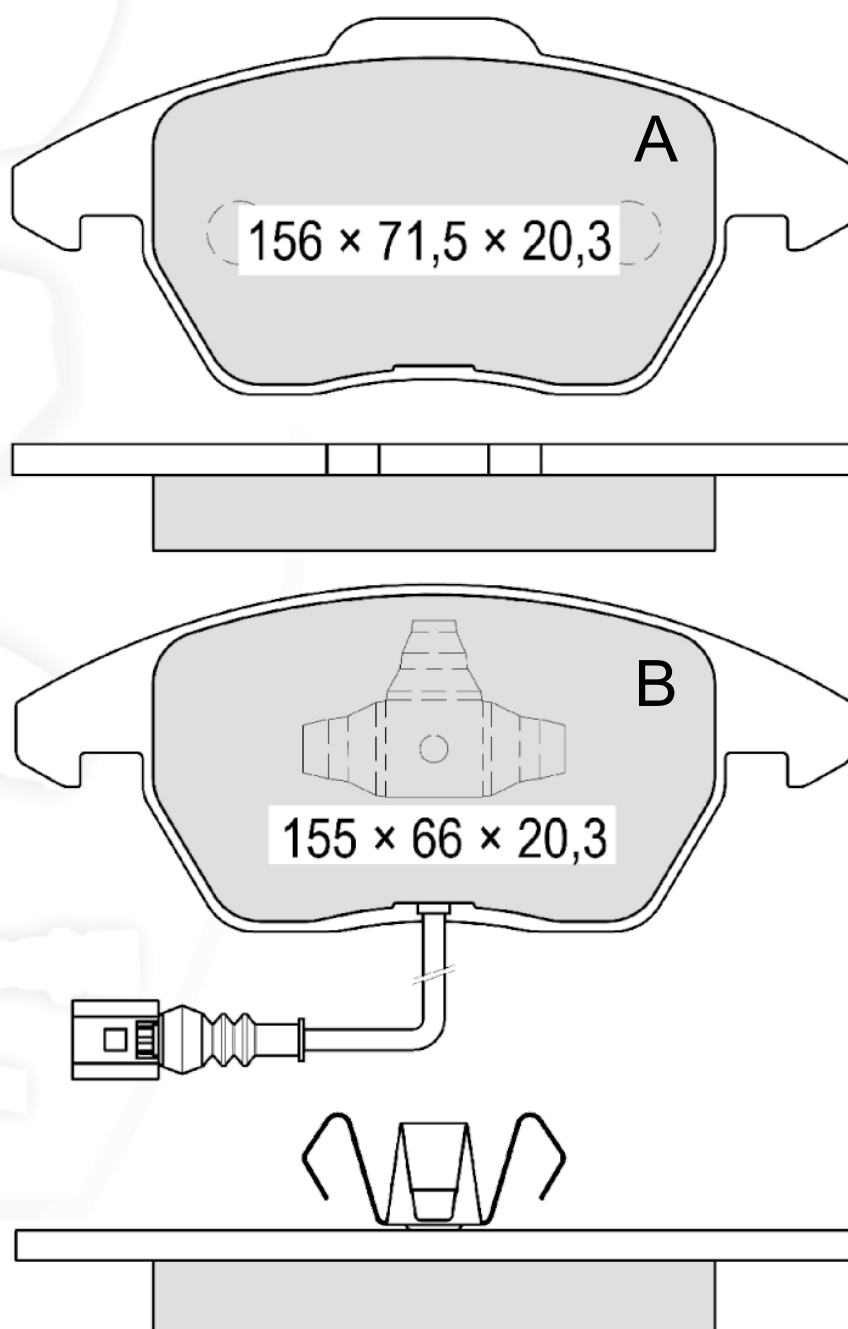

В комплект входят две колодки типа А, две колодки типа В

			W.V.A
--	--	--	-------

<b>Д195</b>	-	<b>CITROEN, PEUGEOT</b>	<b>23589/ 24153</b>
-------------	---	-------------------------	---------------------

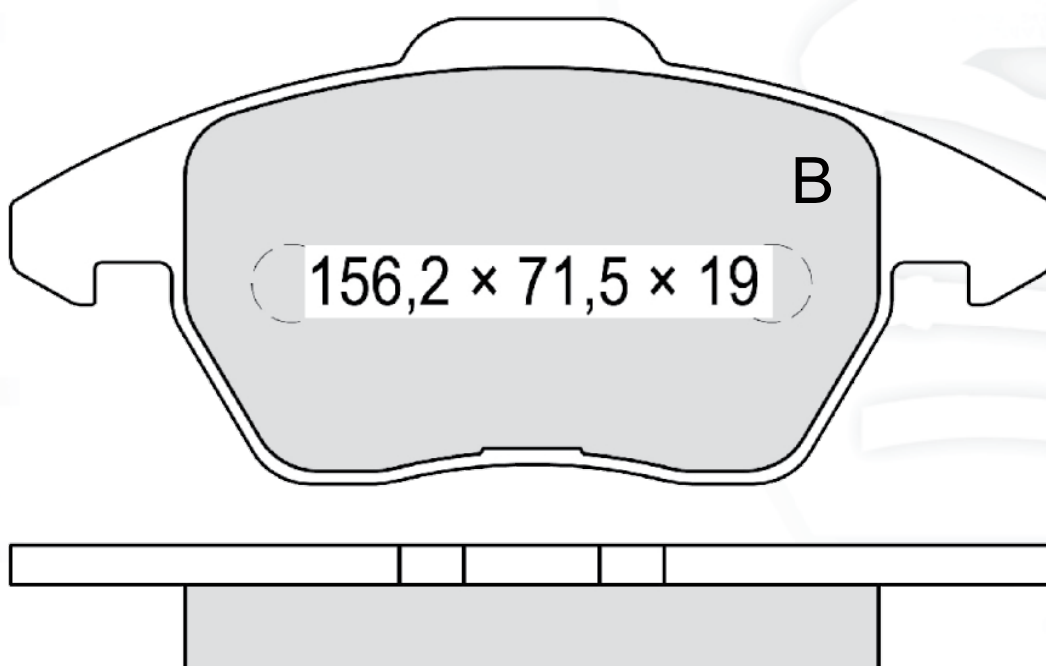
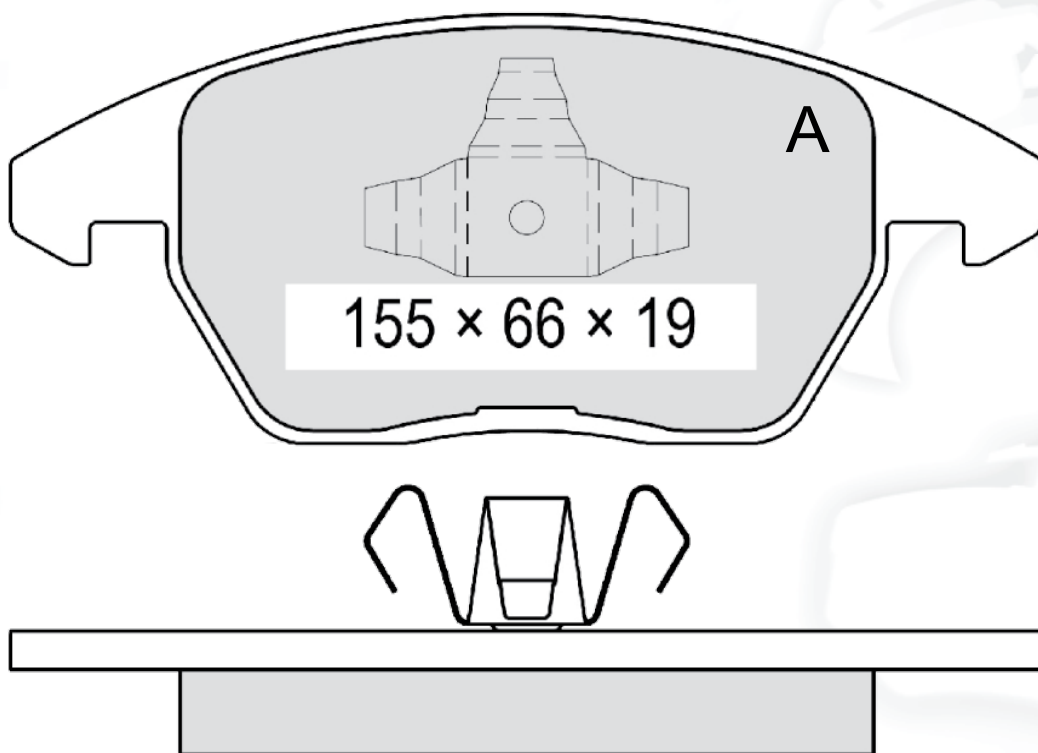

В комплект входят две колодки типа А, две колодки типа В



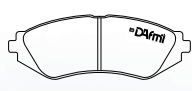
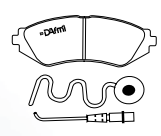
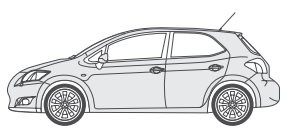

			W.V.A
---	---	--	-------

<b>Д196</b>	-	<b>КІА</b>	-
-------------	---	------------	---

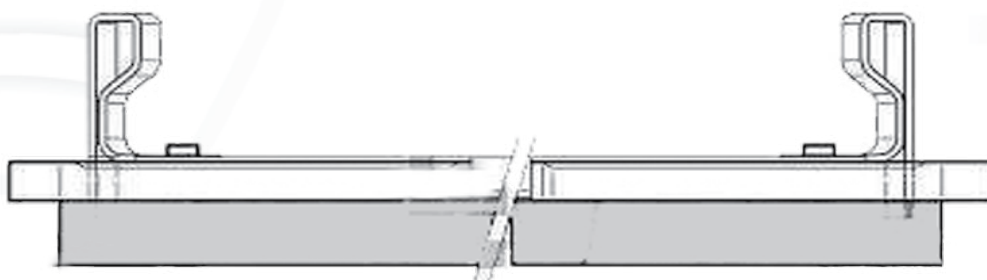
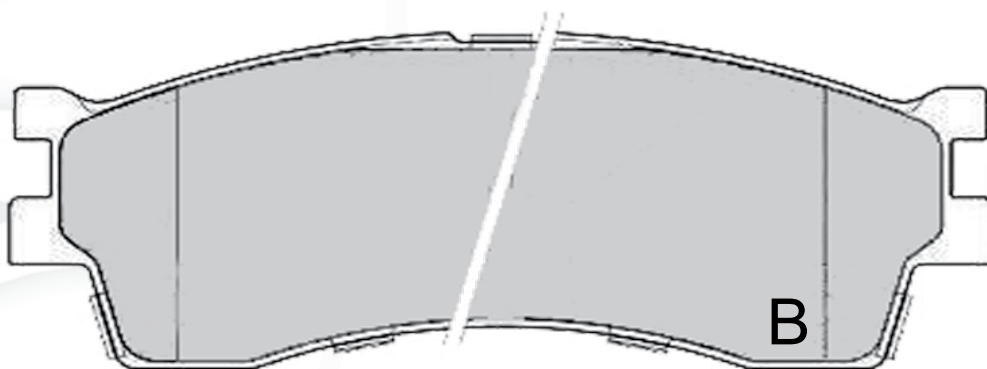
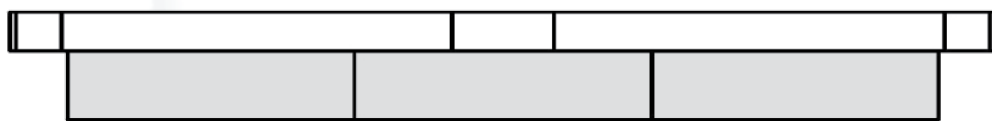
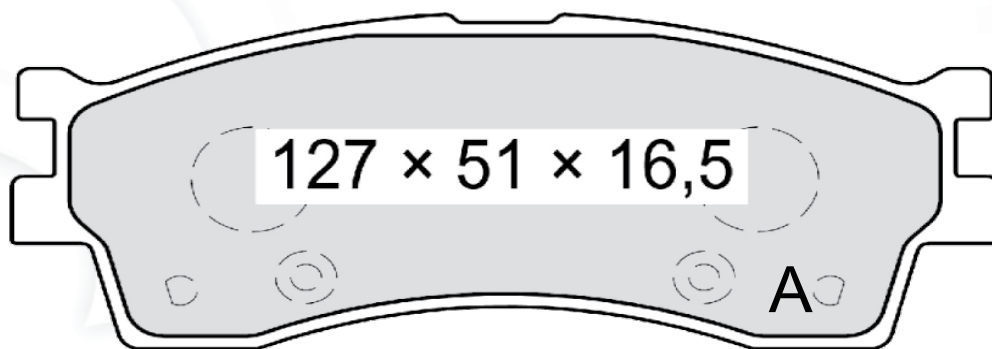

Индикатор износа входит в базовую комплектацию данной колодки

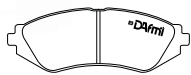
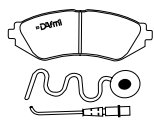

В комплект входят две колодки типа А, две колодки типа В

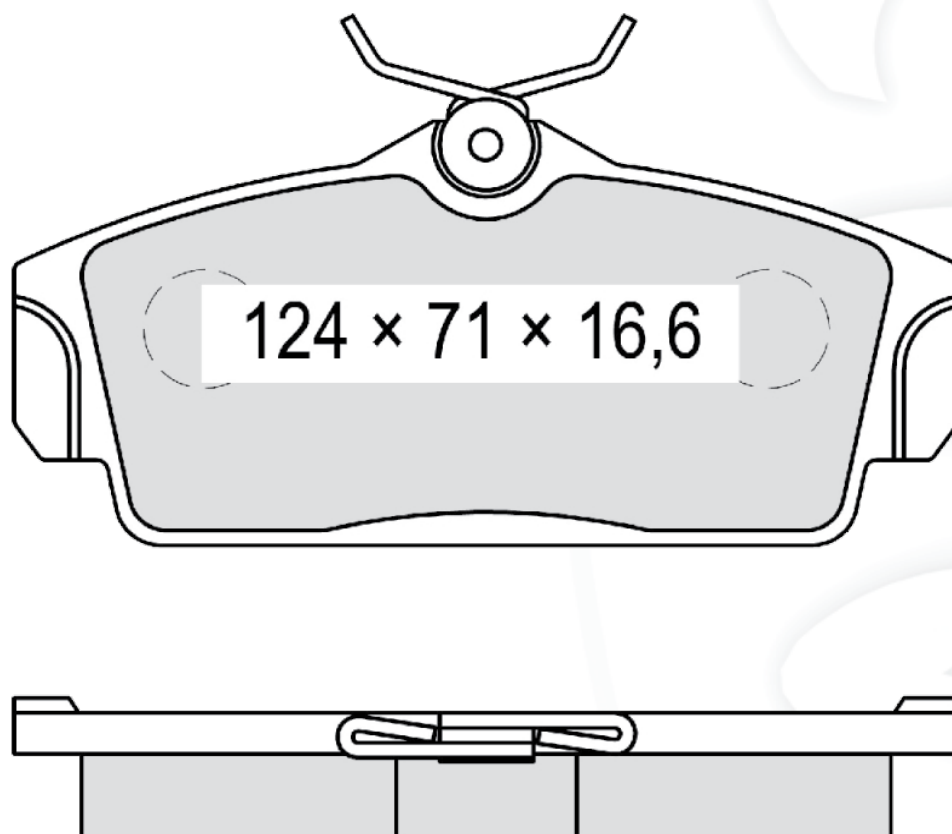
			W.V.A
<b>Д197</b>	-	<b>NISSAN</b>	-

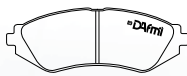
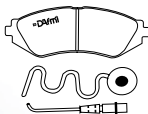

			W.V.A
---	---	--	-------

<b>Д198</b>	-	<b>HYUNDAI</b>	<b>23543</b>
-------------	---	----------------	--------------

Индикатор износа входит в базовую комплектацию данной колодки

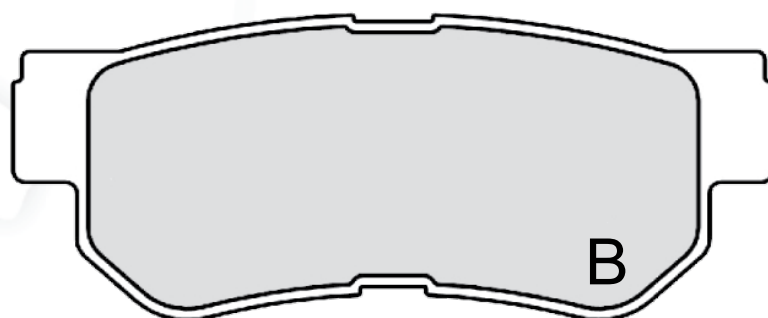
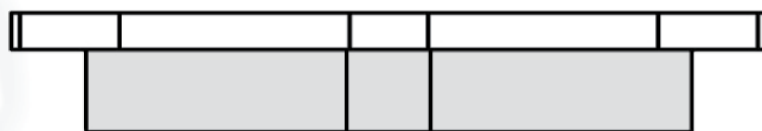
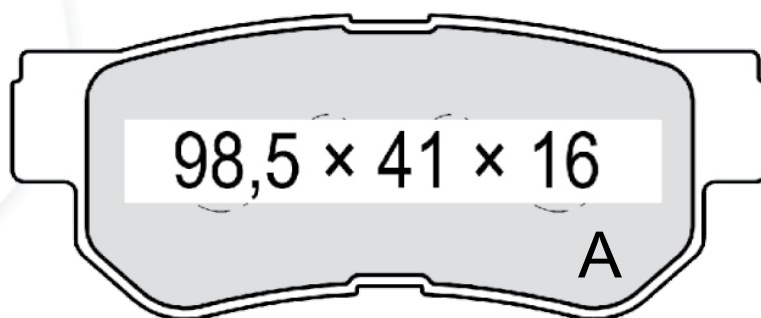

В комплект входят две колодки типа А, две колодки типа В

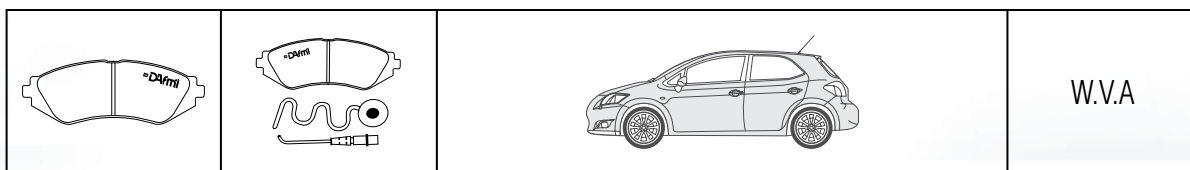

<b>Д199</b>	-	<b>MAZDA</b>	<b>24046/ 24047/ 24048</b>
-------------	---	--------------	--------------------------------

Индикатор износа входит в базовую комплектацию данной колодки

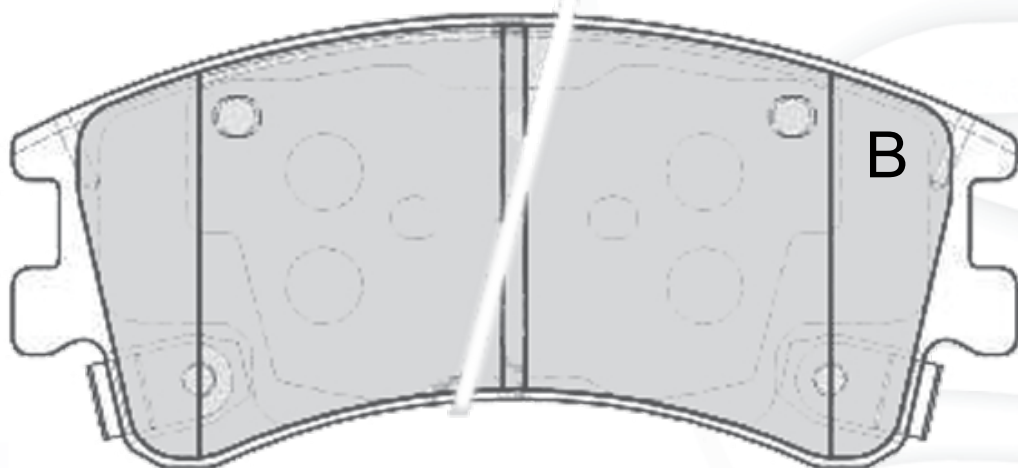
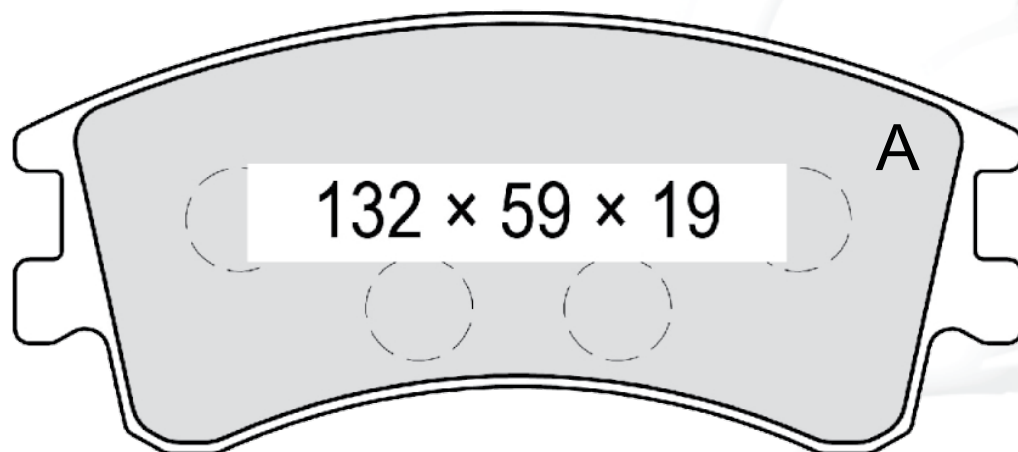

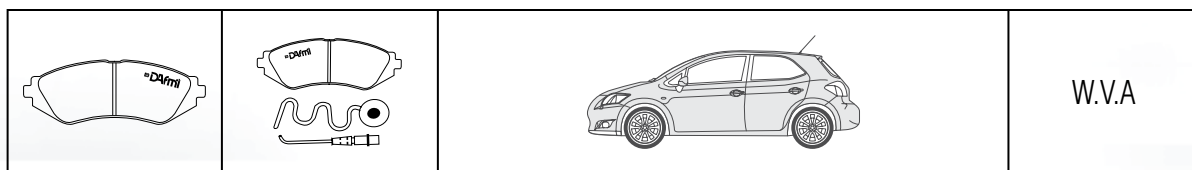

В комплект входят две колодки типа А, две колодки типа В

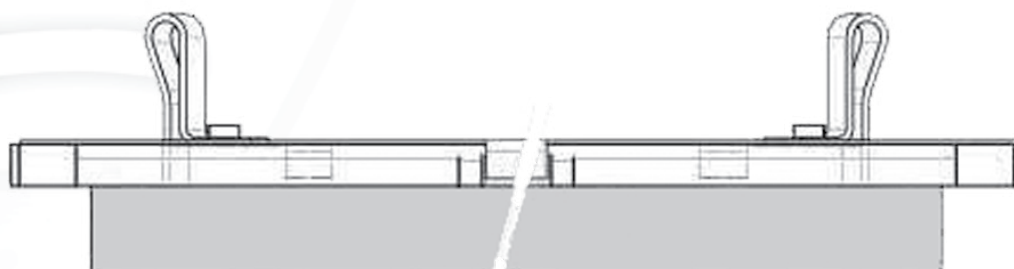
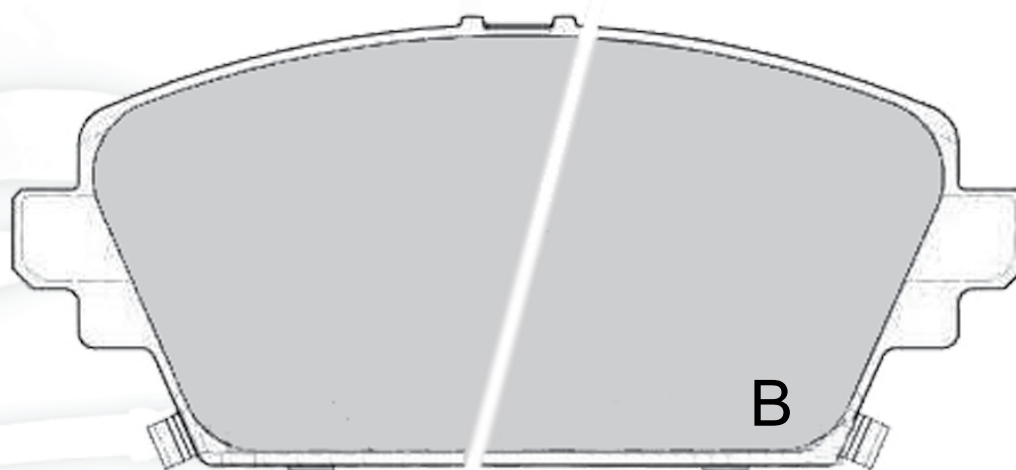
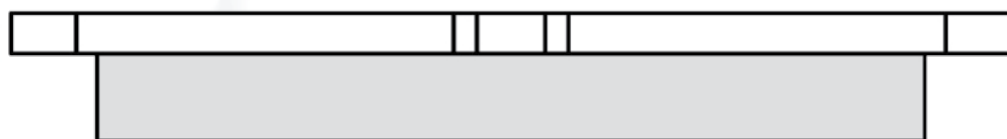
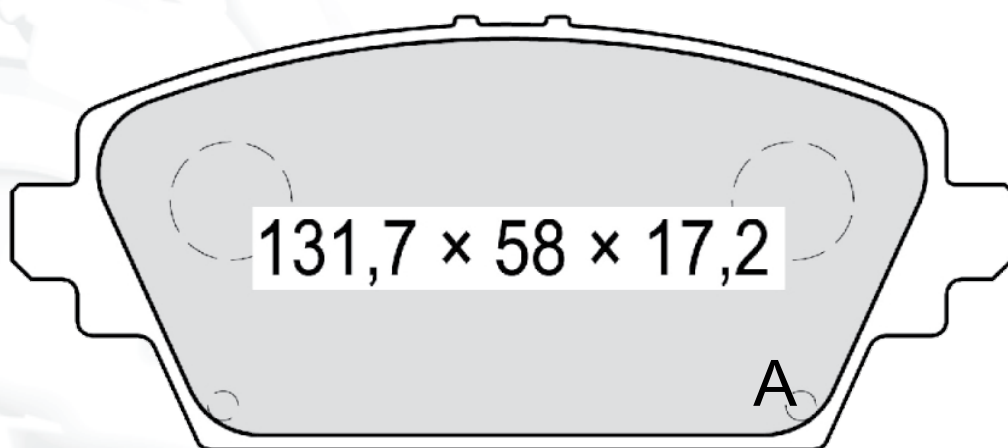

<b>Д200</b>	<b>Д200И</b>	<b>NISSAN</b>	<b>23094/ 23095</b>
-------------	--------------	---------------	---------------------

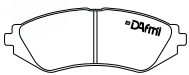
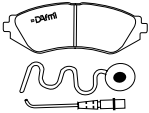

Д200 – в комплект входят четыре колодки типа А  
 Д200И – в комплект входят две колодки типа А, две колодки типа В



			W.V.A
---	---	--	-------

<b>Д201</b>	-	<b>TOYOTA</b>	-
-------------	---	---------------	---

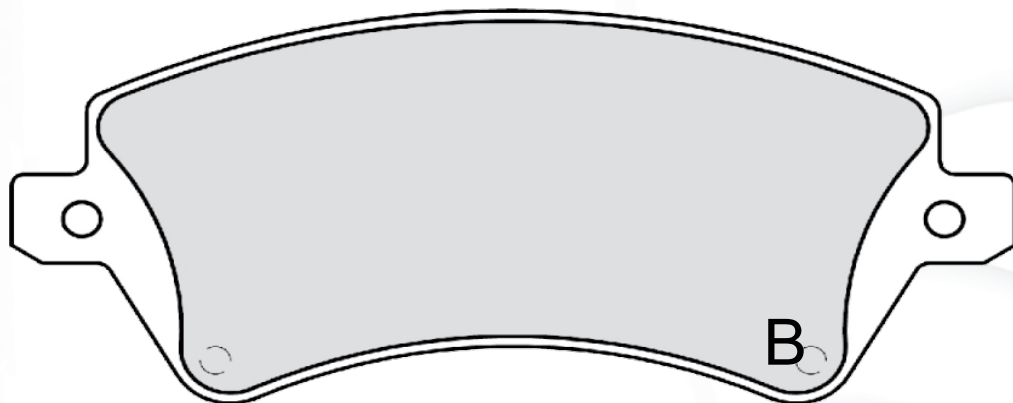
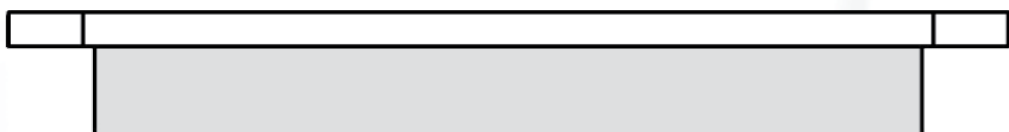
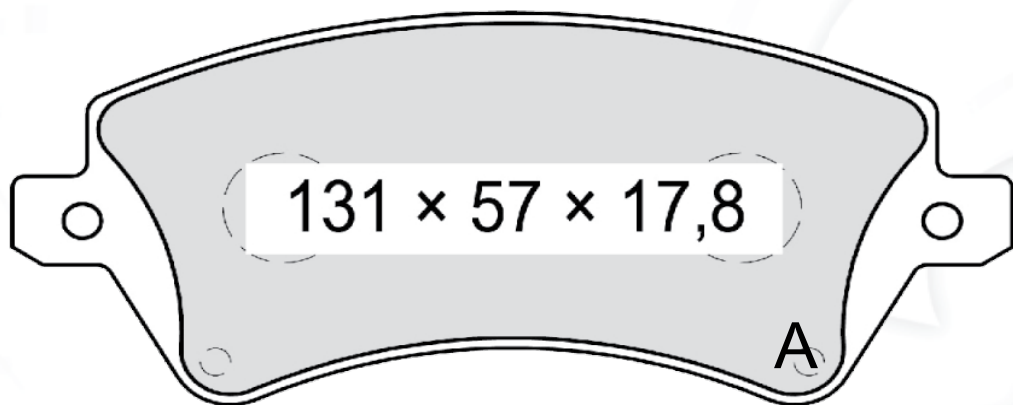
Индикатор износа входит в базовую комплектацию данной колодки

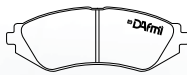
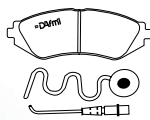

В комплект входят две колодки типа А, две колодки типа В

			W.V.A
---	---	--	-------

<b>Д202</b>	-	<b>RENAULT</b>	<b>23930</b>
-------------	---	----------------	--------------

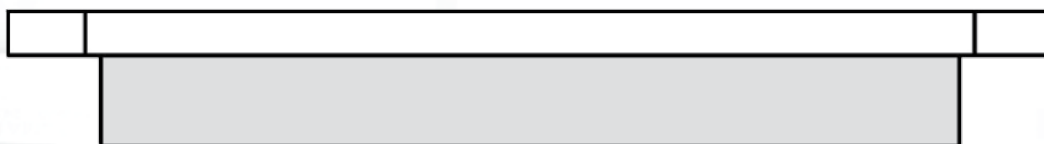
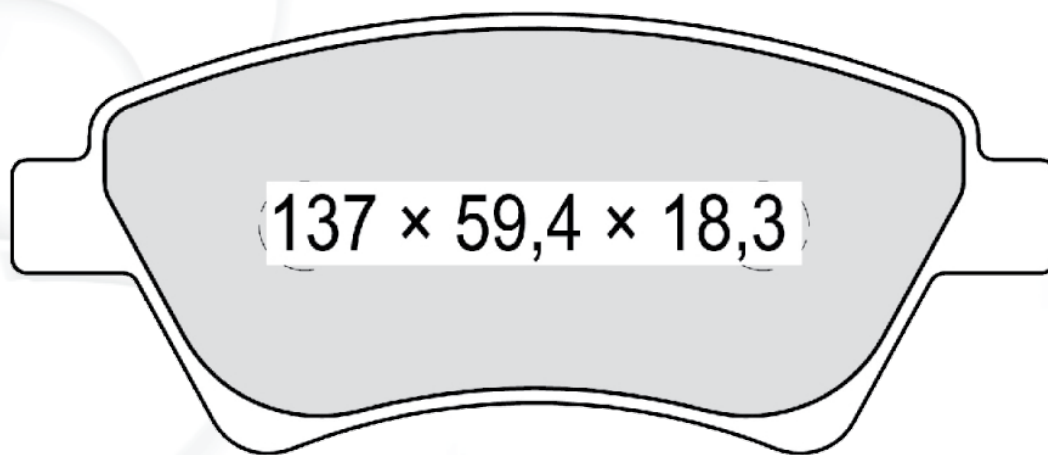

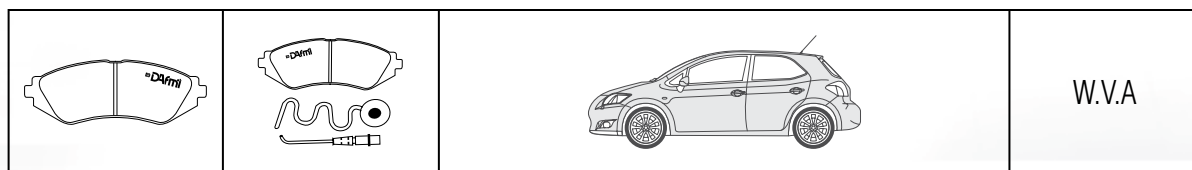

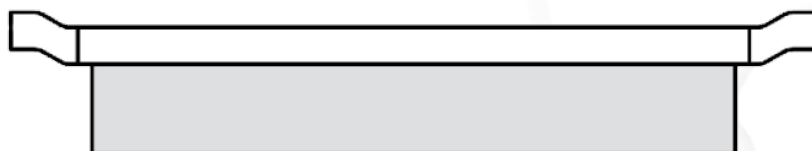
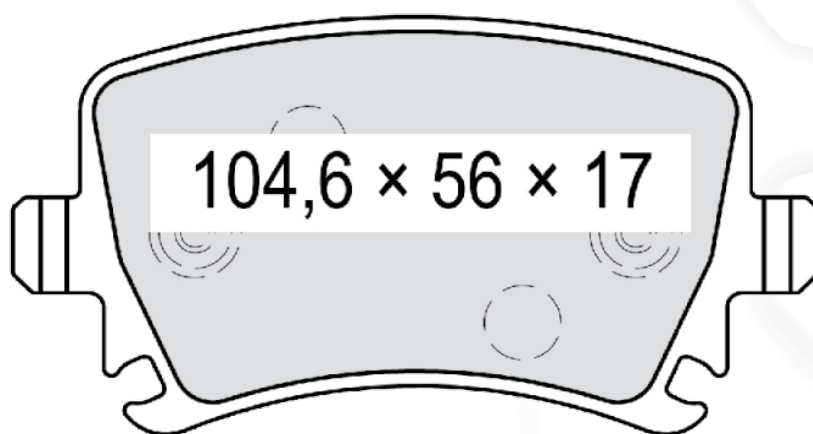

<b>Д203</b>	-	<b>SKODA, VOLKSWAGEN</b>	<b>23914</b>
-------------	---	--------------------------	--------------



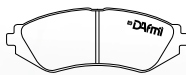
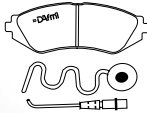

			W.V.A
---	---	--	-------

<b>Д204</b>	<b>Д204И</b>	<b>NISSAN, RENAULT</b>	<b>23973</b>
-------------	--------------	------------------------	--------------

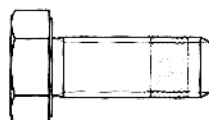
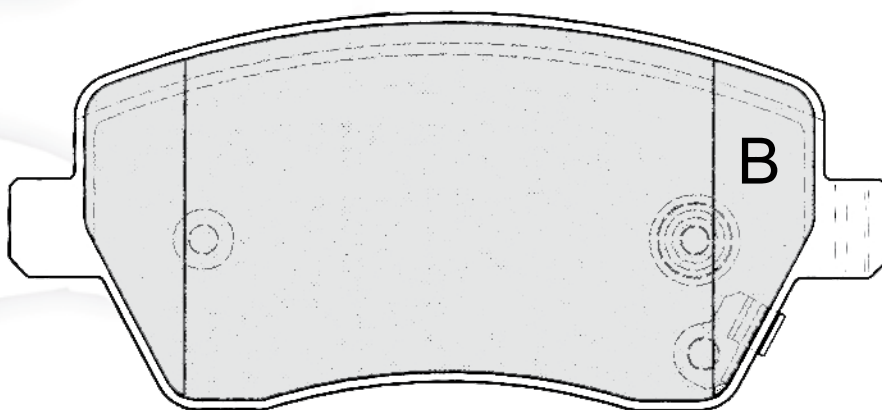
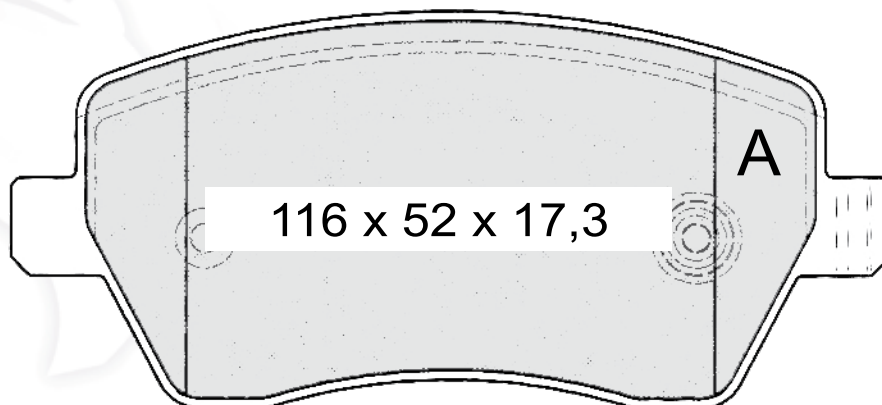



Д204 – в комплект входят четыре колодки типа А  
 Д204И – в комплект входят две колодки типа А, две колодки типа В

			W.V.A
--	--	--	-------

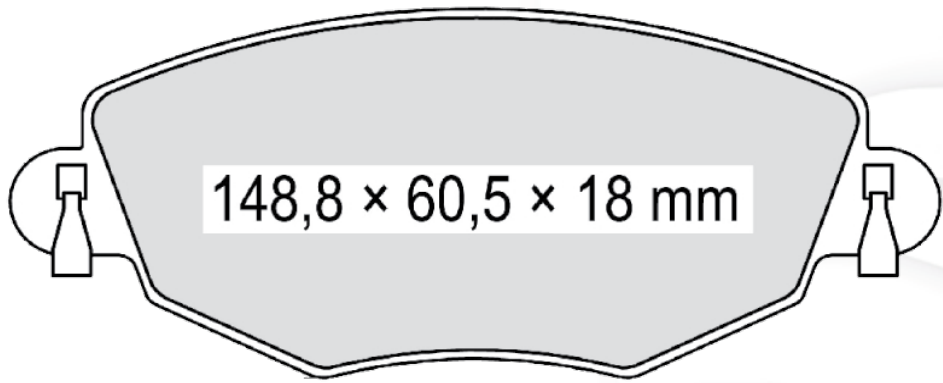
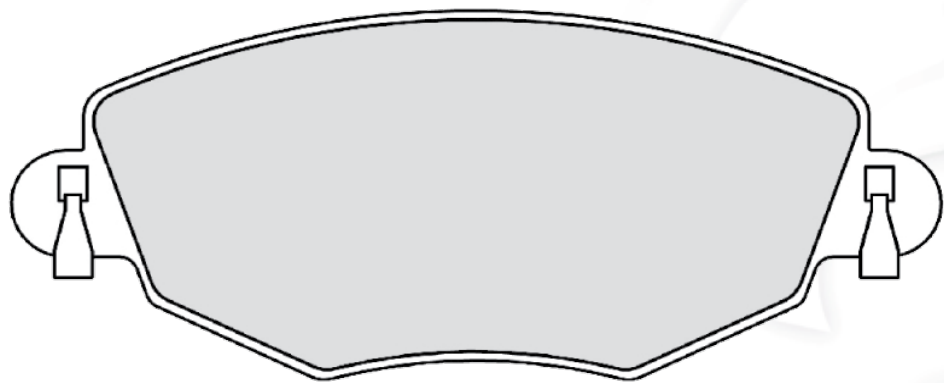
<b>Д205</b>	-	<b>FORD, RENAULT</b>	<b>23278/ 23279/ 23321</b>
-------------	---	----------------------	--------------------------------

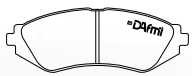
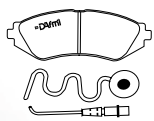

			W.V.A
---	---	--	-------

<b>Д206</b>	-	<b>MAZDA, FORD</b>	<b>24137</b>
-------------	---	--------------------	--------------

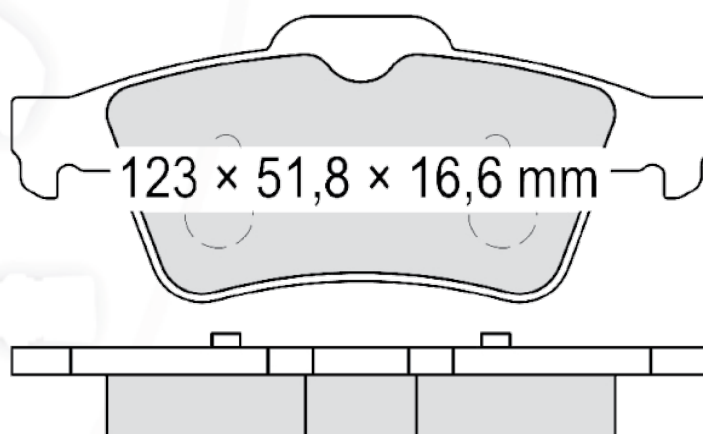
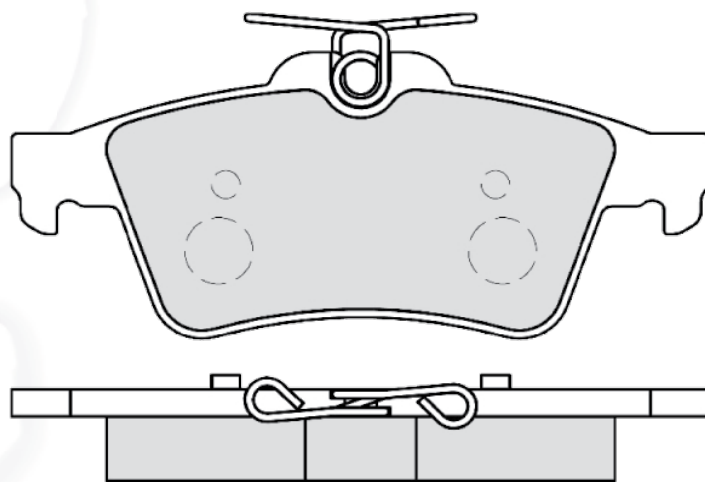

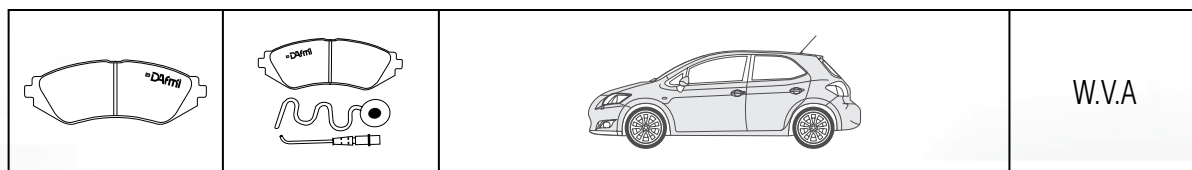

<b>Д209</b>	-	<b>HYUNDAI</b>	<b>23569</b>
-------------	---	----------------	--------------

Индикатор износа входит в базовую комплектацию данной колодки

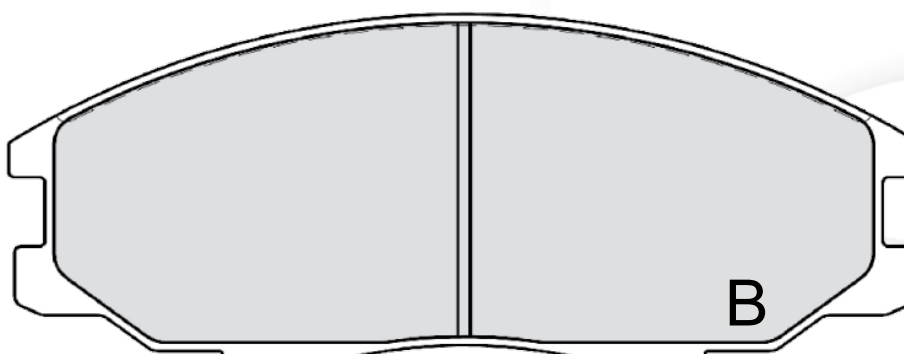
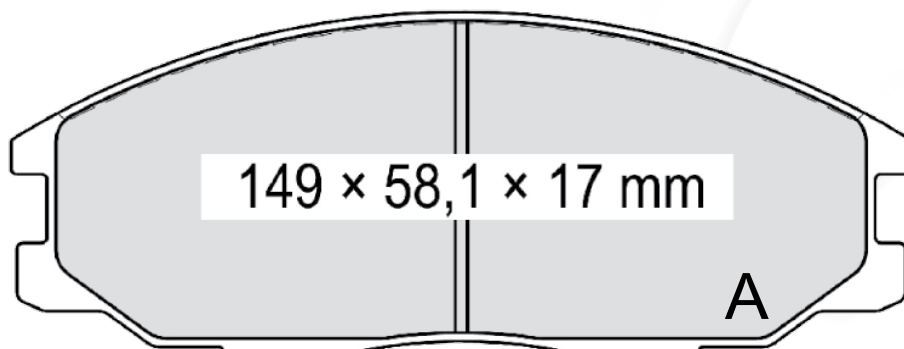

В комплект входят две колодки типа А, две колодки типа В

			W.V.A
--	--	--	-------

<b>Д210</b>	-	<b>ТОУОТА</b>	21679/ 21680/ 21681/ 21785
-------------	---	---------------	-------------------------------

Индикатор износа входит в базовую комплектацию данной колодки

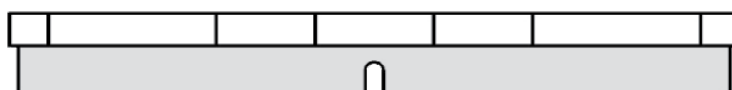
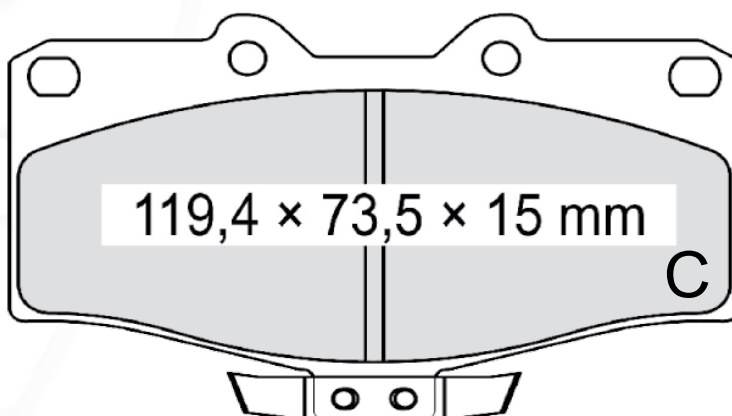
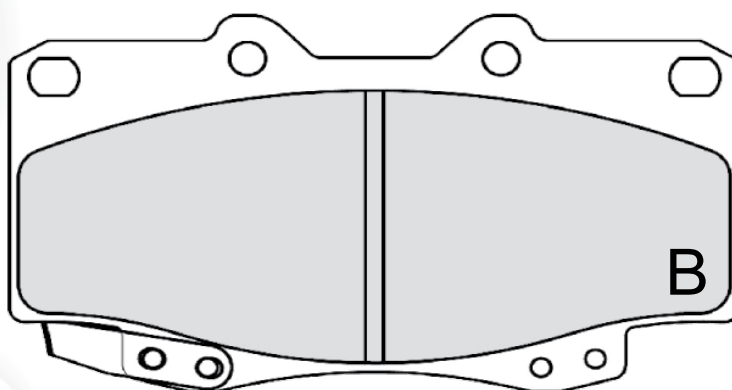
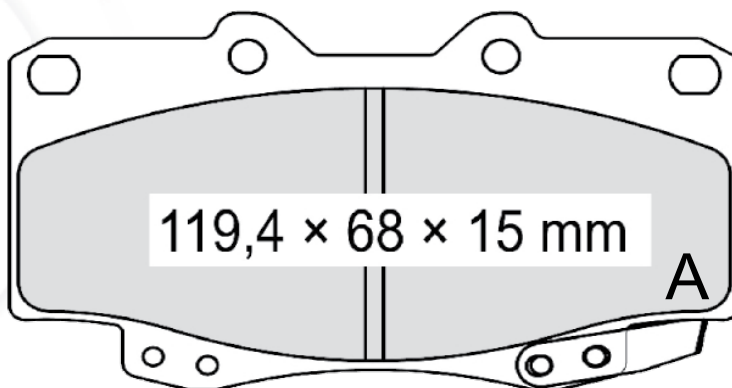

В комплект входят одна колодка типа А,  
одна колодка типа В, две колодки типа С

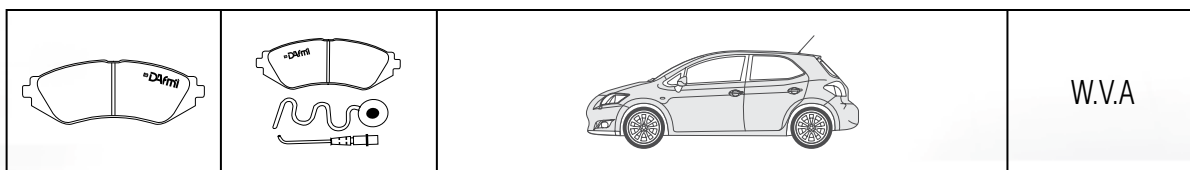



<b>Д211</b>	-	<b>HYUNDAI</b>	<b>21553/ 21554/ 21555</b>
-------------	---	----------------	--------------------------------

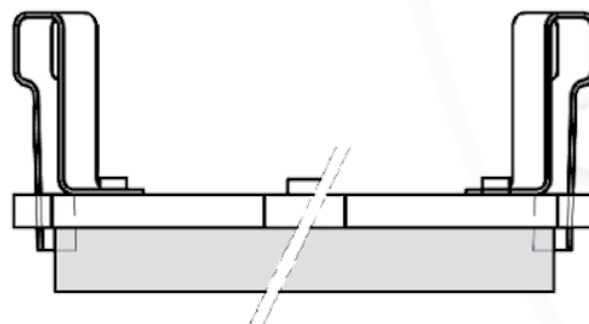
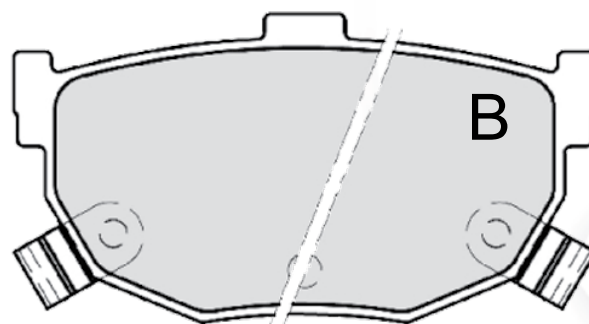
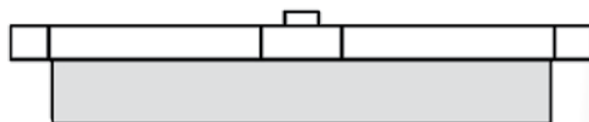
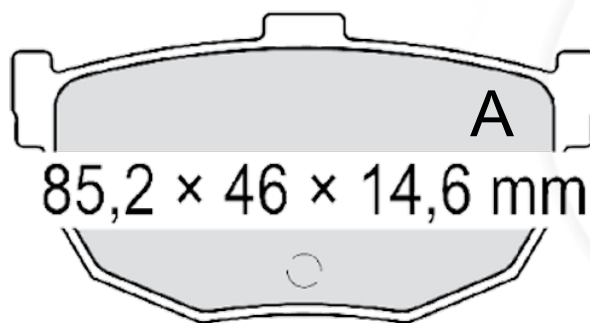

Индикатор износа входит в базовую комплектацию данной колодки

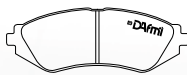
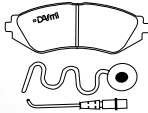

В комплект входят две колодки типа А, две колодки типа В

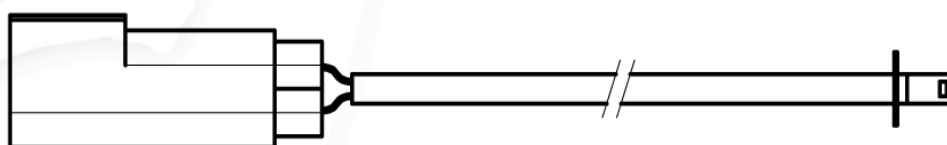
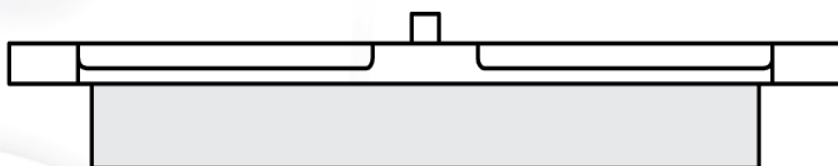
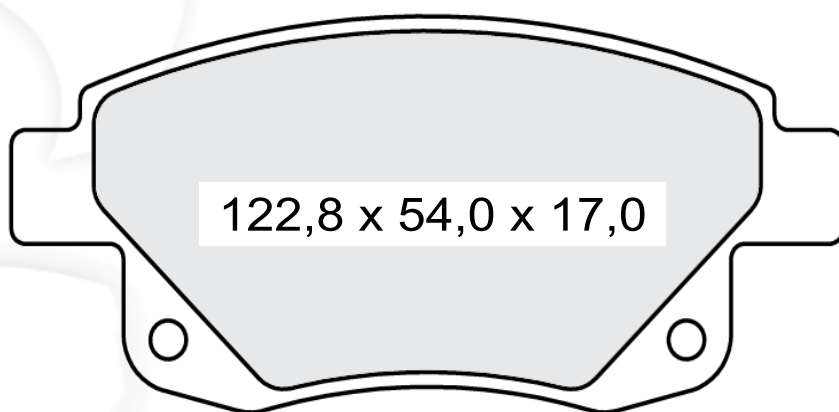
			W.V.A
<b>Д212</b>	<b>Д212И</b>	<b>FORD</b>	

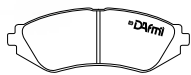
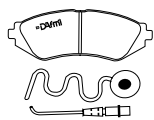

			W.V.A
<b>Д213</b>		<b>MERCEDES-BENZ</b>	<b>20758</b>

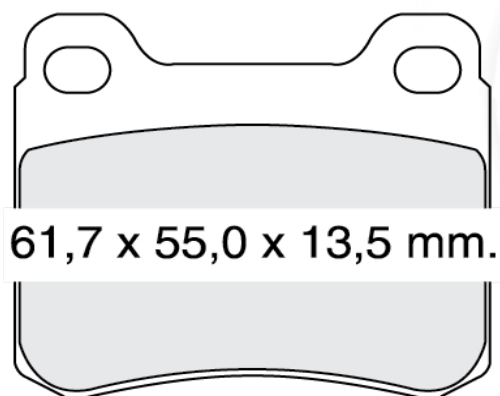



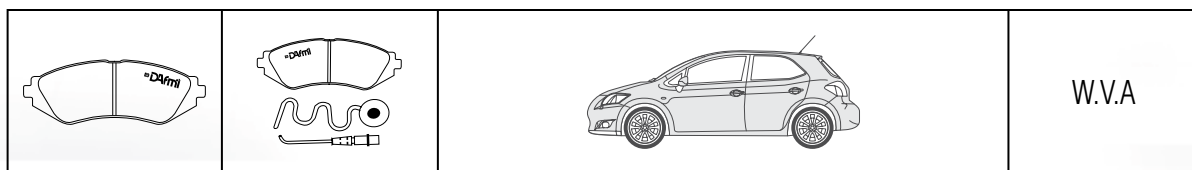



<b>Д214</b>	-	<b>HYUNDAI</b>	<b>24031/ 24032/ 24033</b>
-------------	---	----------------	--------------------------------

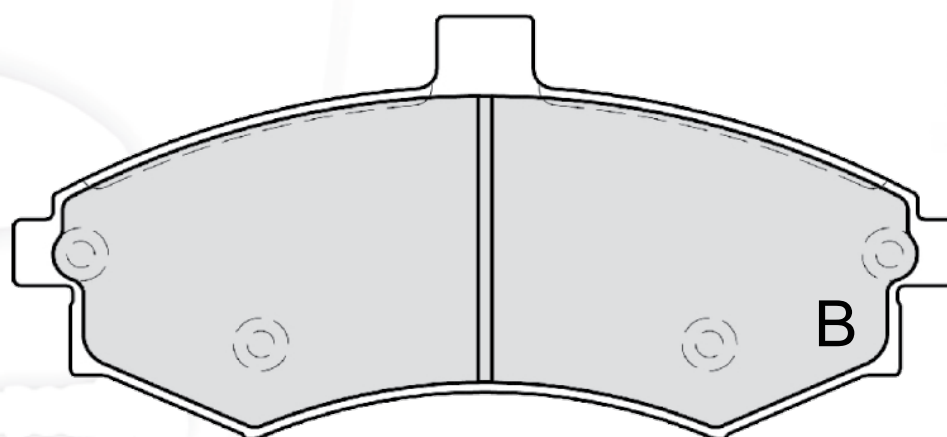
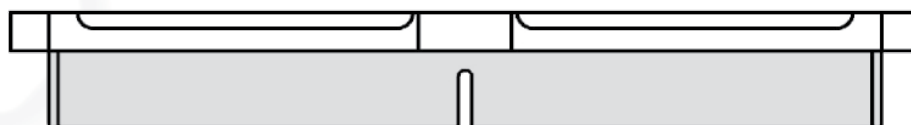
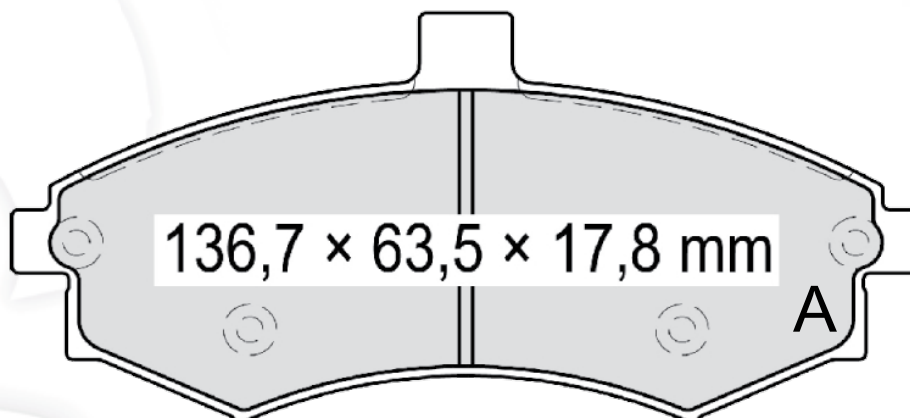

Индикатор износа входит в базовую комплектацию данной колодки

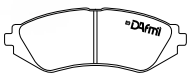
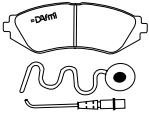

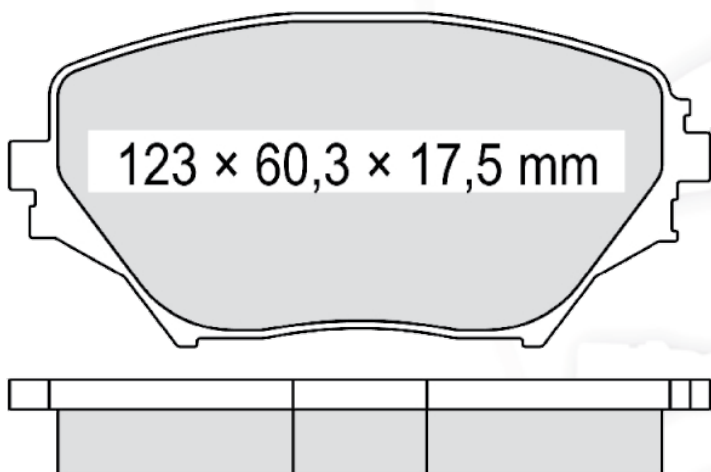
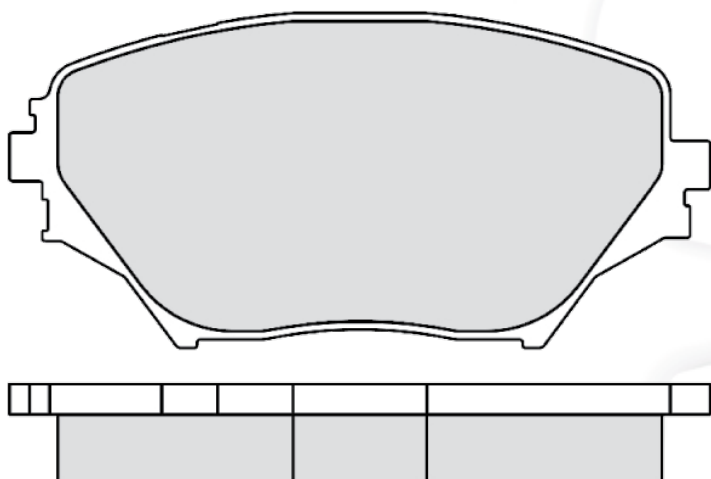

В комплект входят две колодки типа А, две колодки типа В

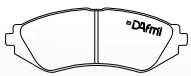
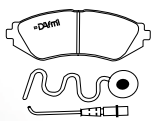
			W.V.A
<b>Д215</b>	<b>Д215И</b>	<b>TOYOTA</b>	<b>23585</b>

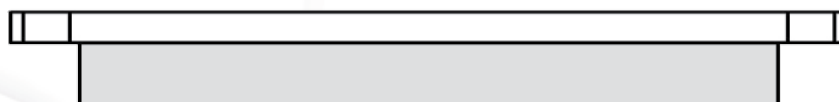
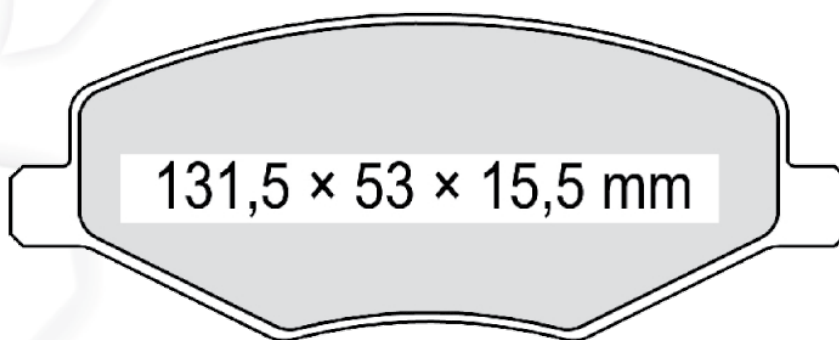

			<p>W.V.A</p>
<p><b>Д216</b></p>	<p>-</p>	<p><b>CHERY</b></p>	<p>-</p>

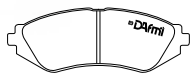
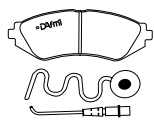

			W.V.A
<b>Д217</b>	<b>Д217И</b>	<b>FORD</b>	-

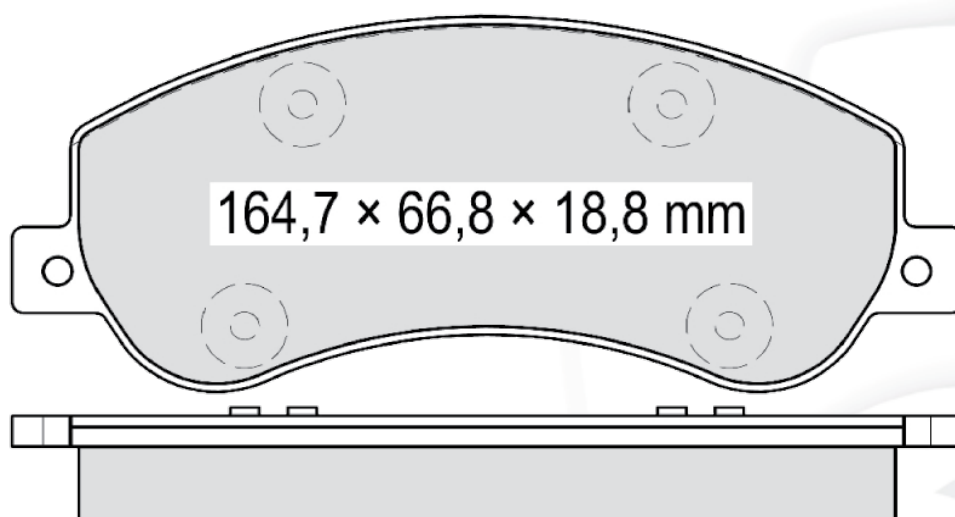

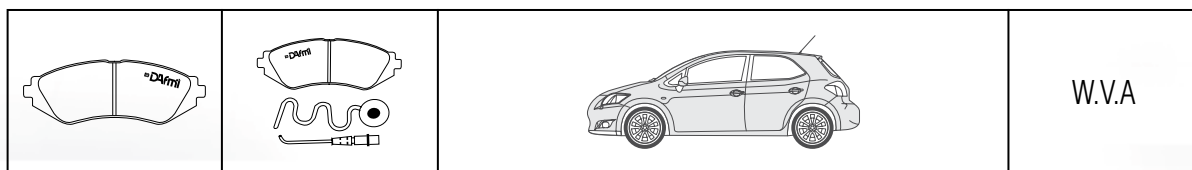

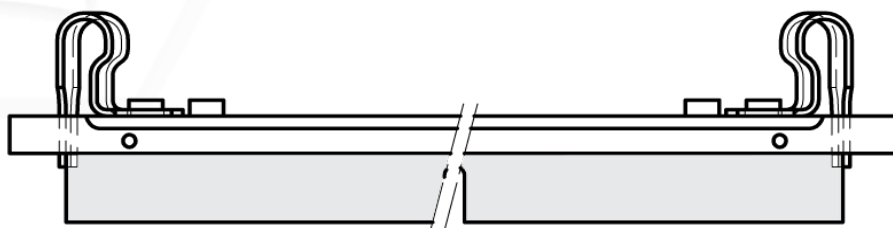
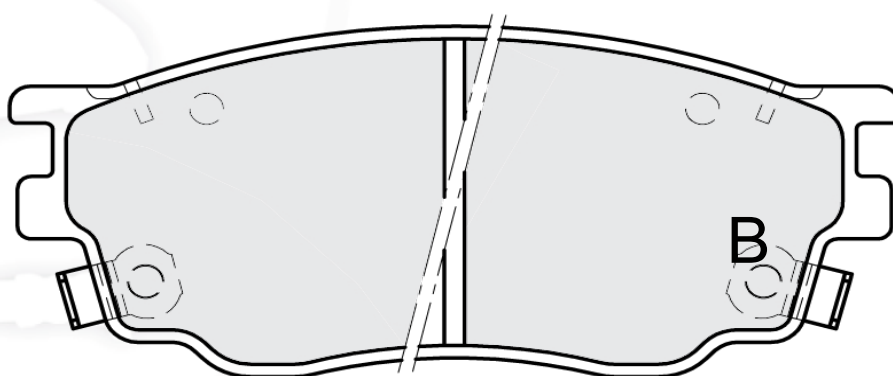
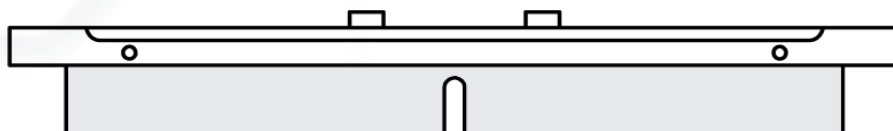
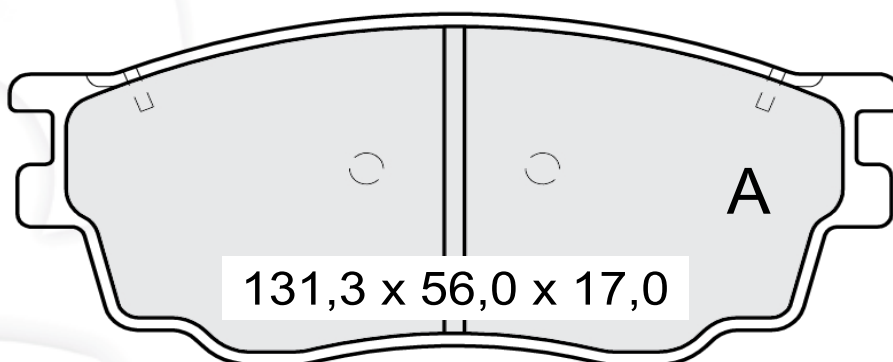

<b>Д218</b>		<b>MAZDA</b>	
-------------	--	--------------	--

Индикатор износа входит в базовую комплектацию данной колодки



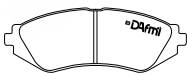
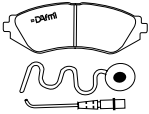

В комплект входят две колодки типа А, две колодки типа В

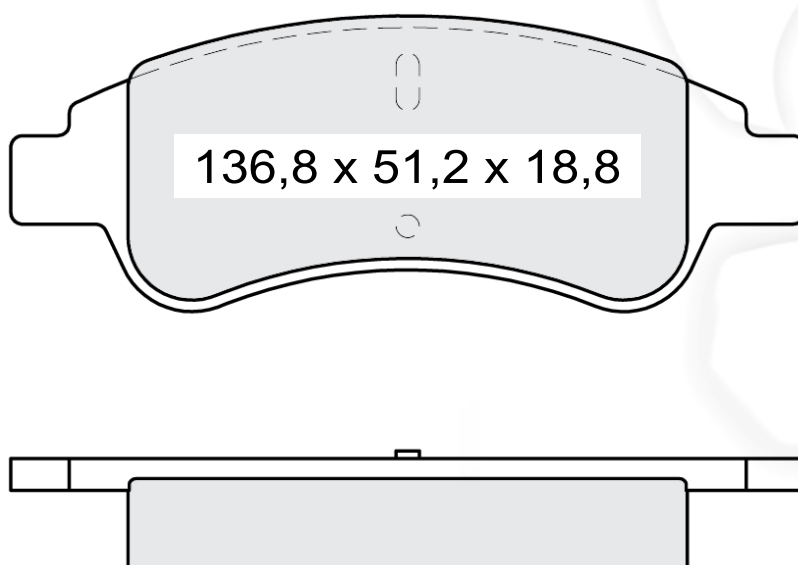
			<p>W.V.A</p>
<p><b>Д219</b></p>		<p><b>CITROEN, PEUGEOT</b></p>	<p>24101 23599</p>

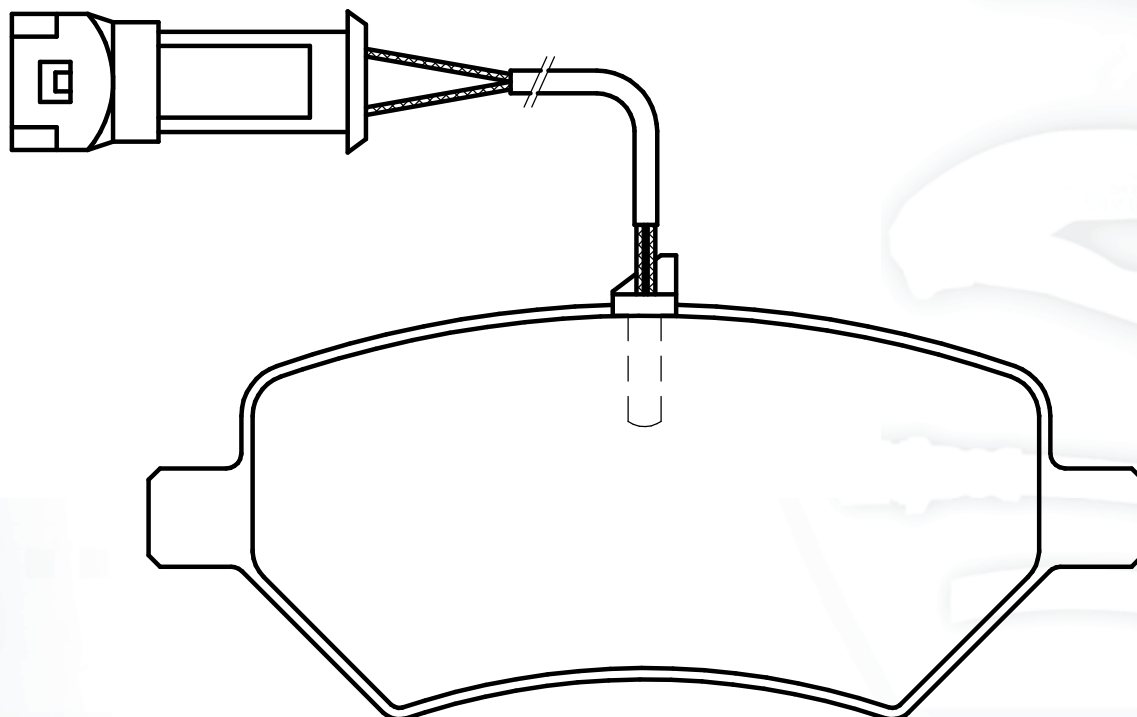
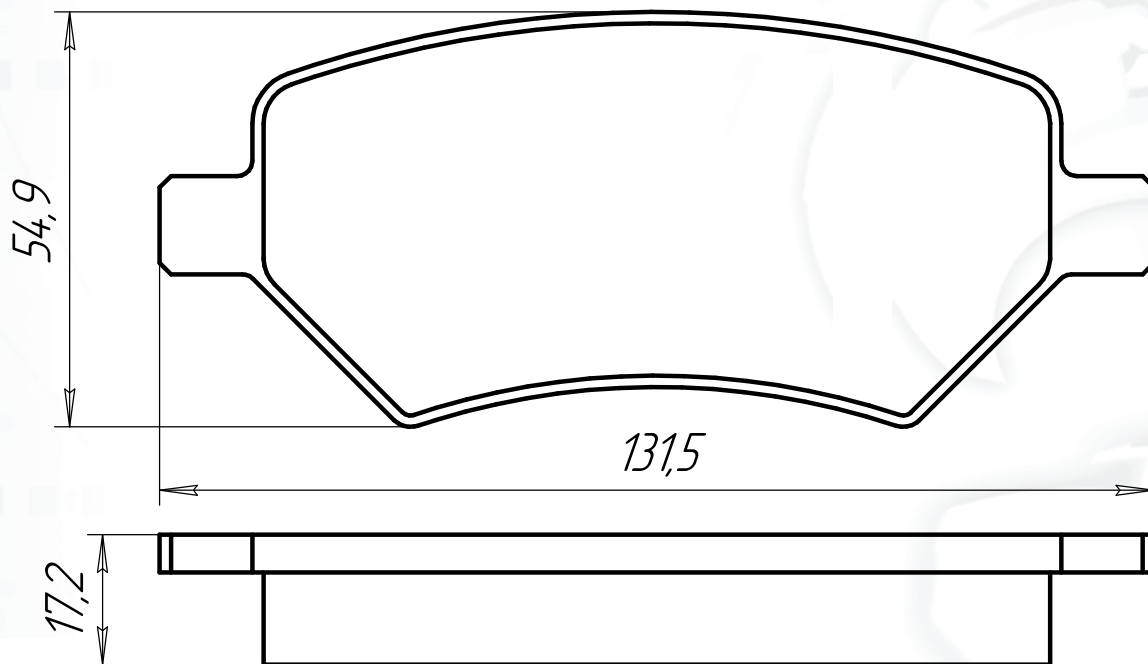

			W.V.A
220		CHERY	

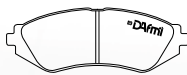
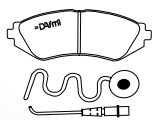

			<p>W.V.A</p>
<p><b>Д221</b></p>		<p><b>УАЗ</b></p>	

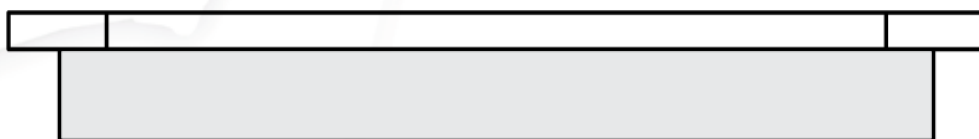
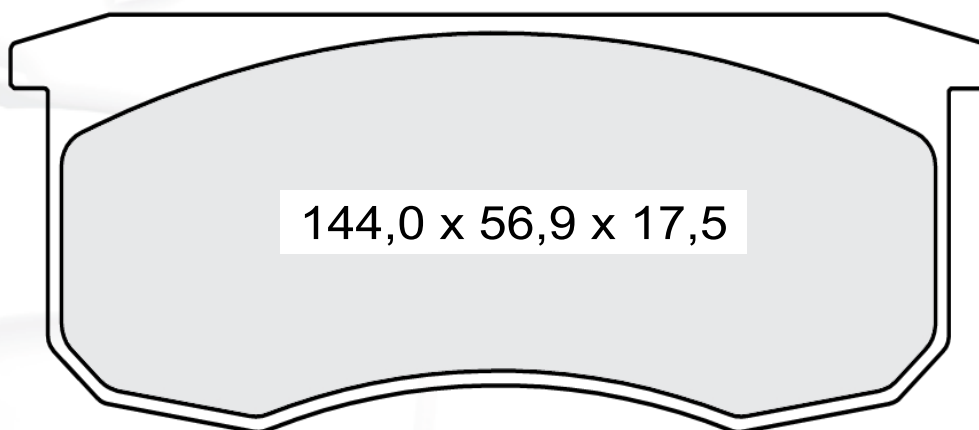





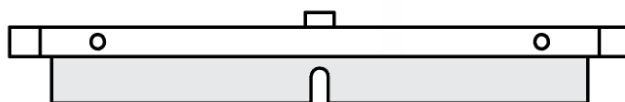
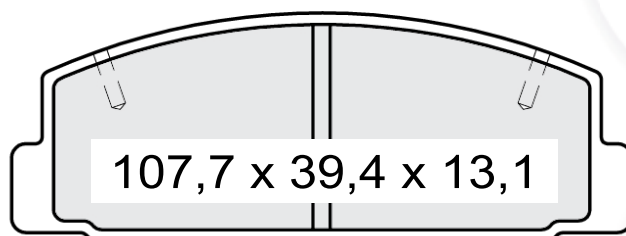

			W.V.A
--	--	--	-------

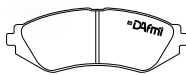
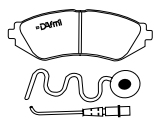
<b>Д222</b>		<b>MAZDA</b>	20645 24045
-------------	--	--------------	----------------



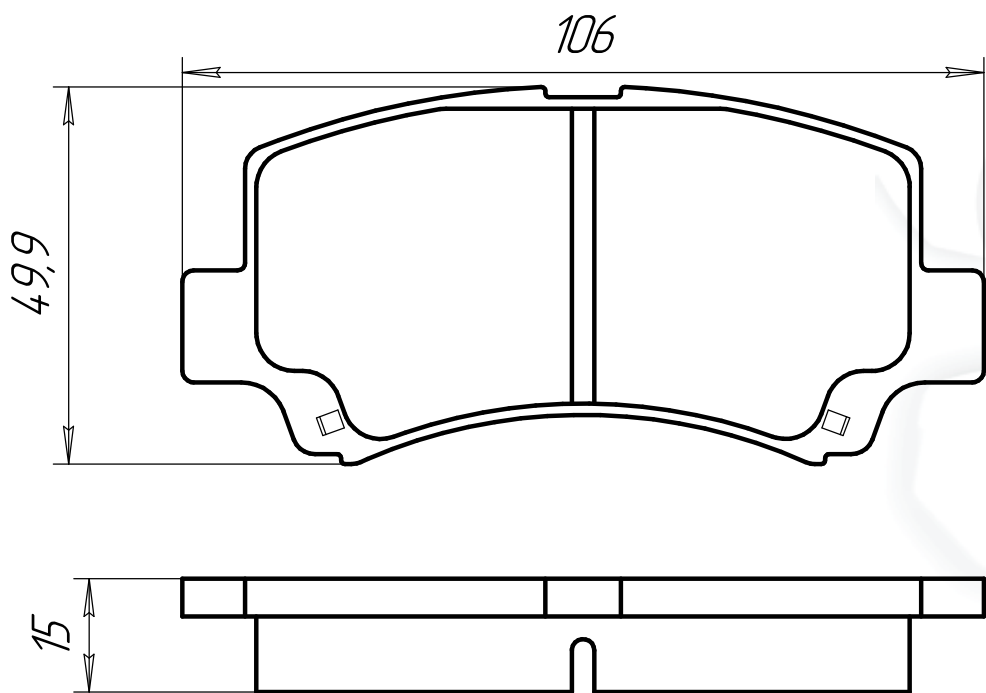

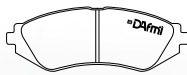
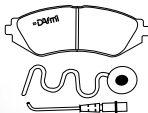
			<p>W.V.A</p>
<p>223</p>		<p>CHERY, SUZUKI</p>	

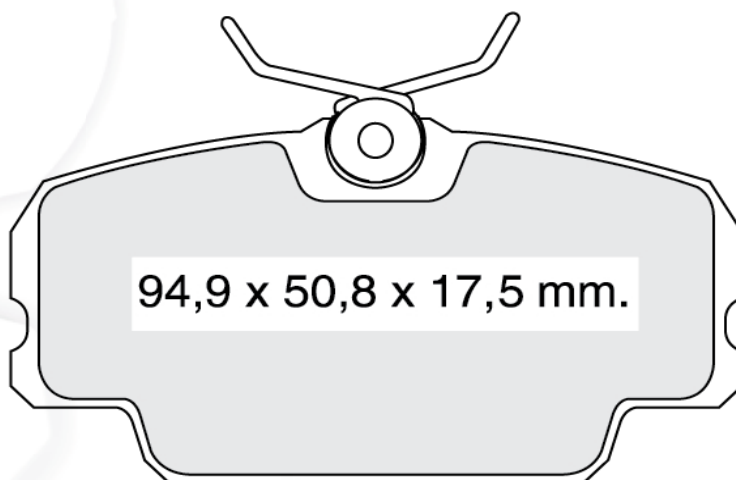

			W.V.A
---	---	--	-------

<b>Д224</b>	<b>Д224И1</b>	<b>BMW, MERCEDES-BENZ</b>	<b>20749</b>
	<b>Д224И2</b>	<b>MERCEDES-BENZ</b>	
		<b>BMW</b>	

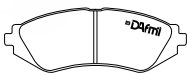
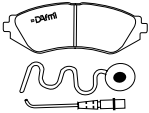

			W.V.A
<b>Д226</b>		<b>RENAULT</b>	<b>20336</b>

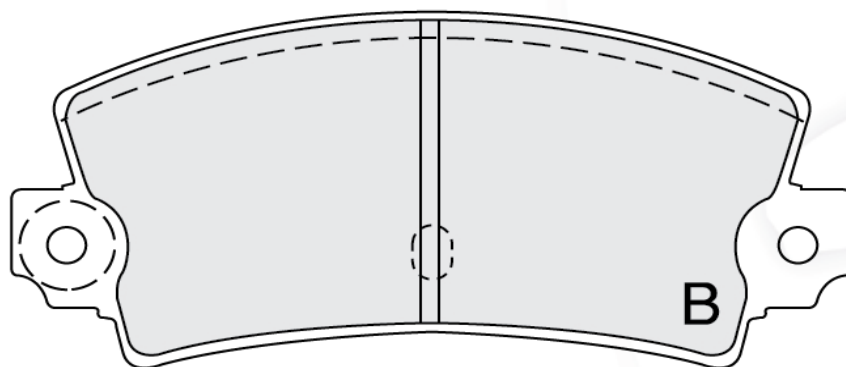
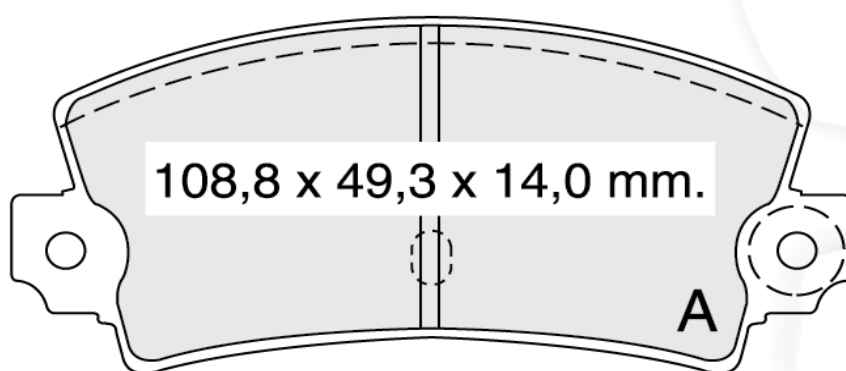

В комплект входят две колодки типа А, две колодки типа В

			W.V.A
227		CHEVROLET	

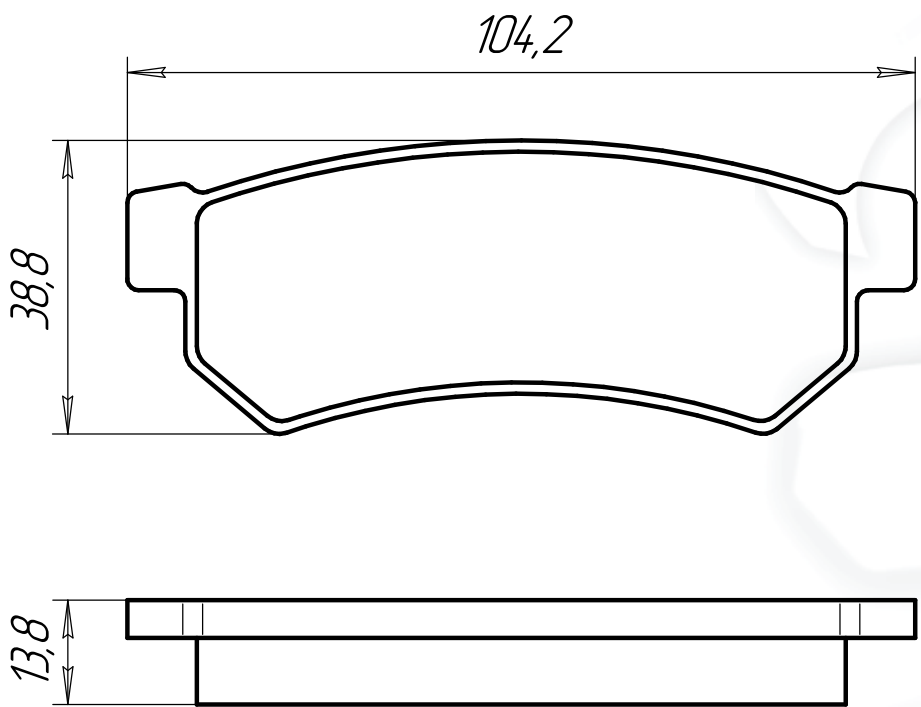

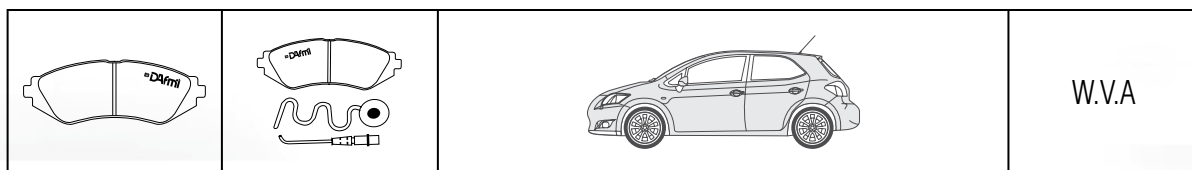

<b>Д229</b>		<b>БОГДАН, ISUZU</b>	-
-------------	--	----------------------	---

Индикатор износа входит в базовую комплектацию данной колодки

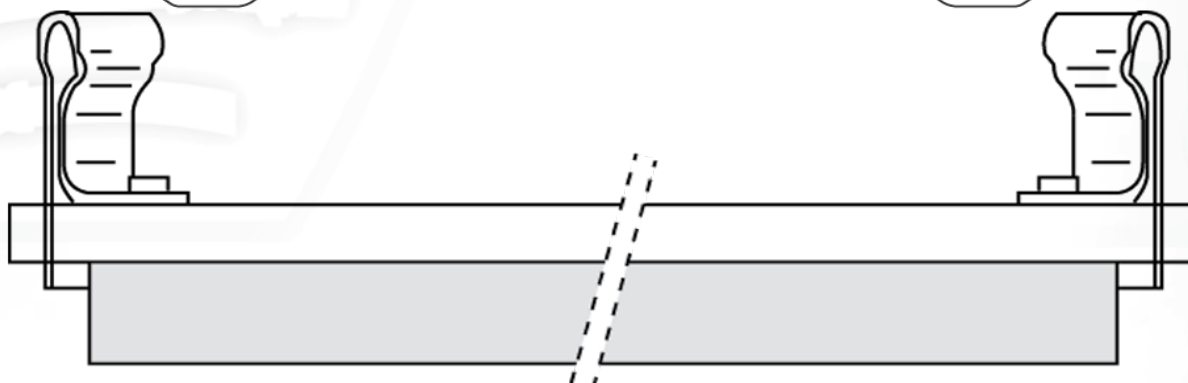
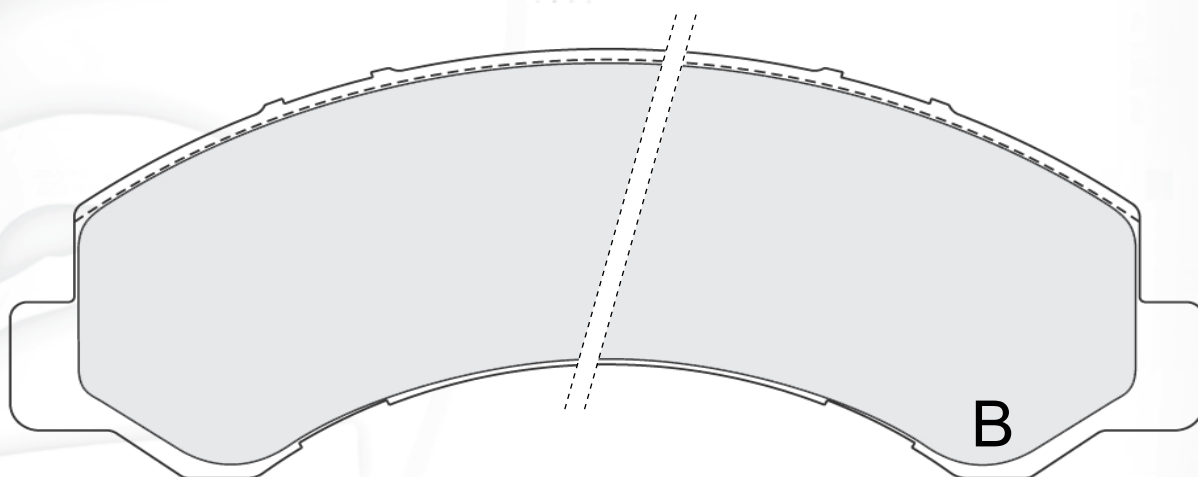
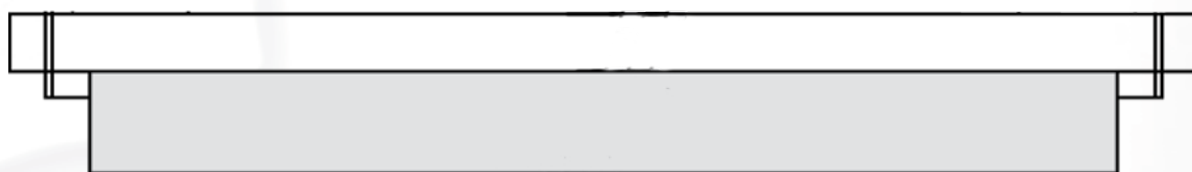
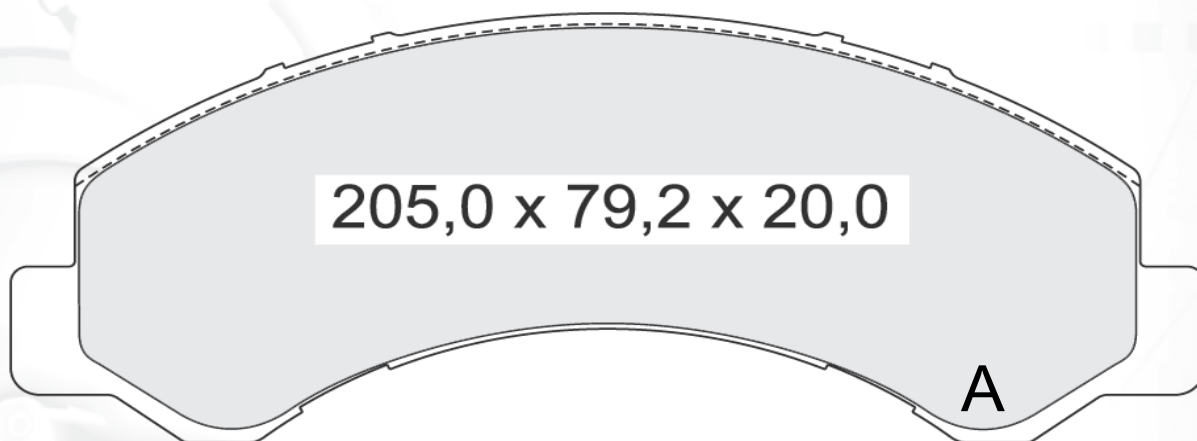

В комплект входят две колодки типа А, две колодки типа В

			W.V.A
--	--	--	-------

<b>Д231</b>		<b>RENAULT</b>	23245 23247 23248
-------------	--	----------------	-------------------------

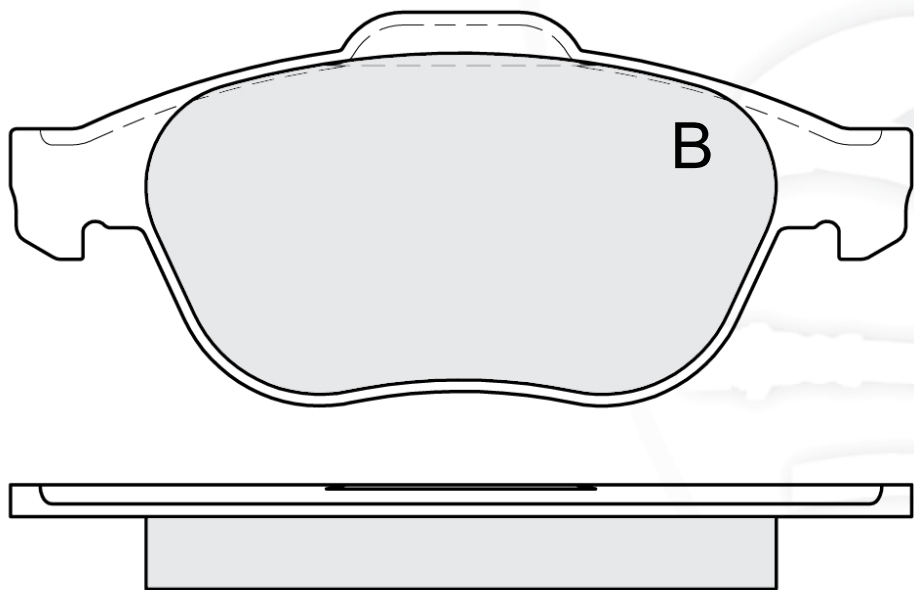
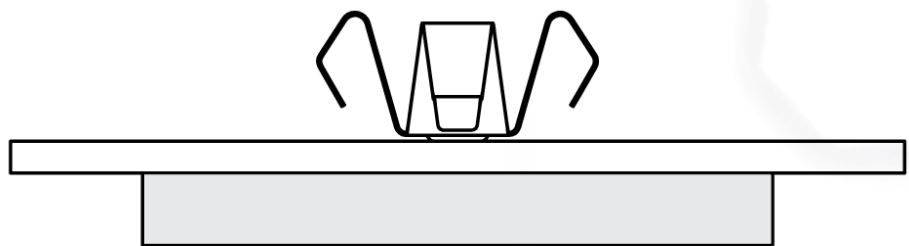
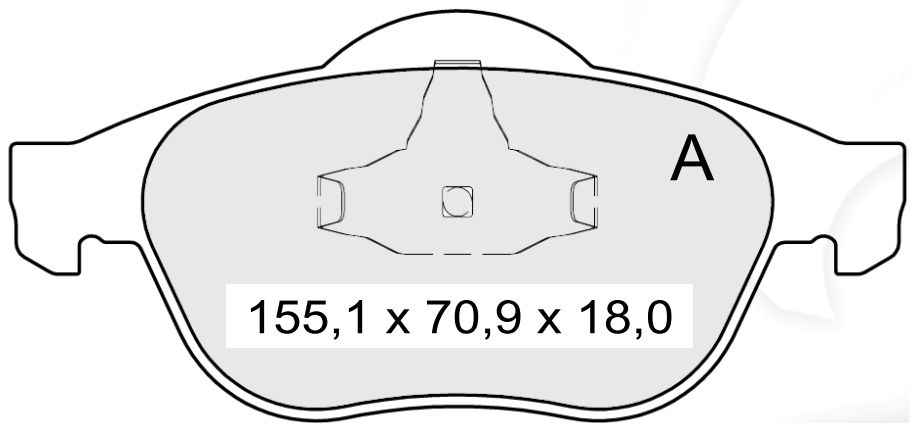

В комплект входят две колодки типа А, две колодки типа В

			W.V.A
--	--	--	-------

<b>Д232</b>		<b>KIA</b>	24068 24069 24070
-------------	--	------------	-------------------------

Индикатор износа входит в базовую комплектацию данной колодки

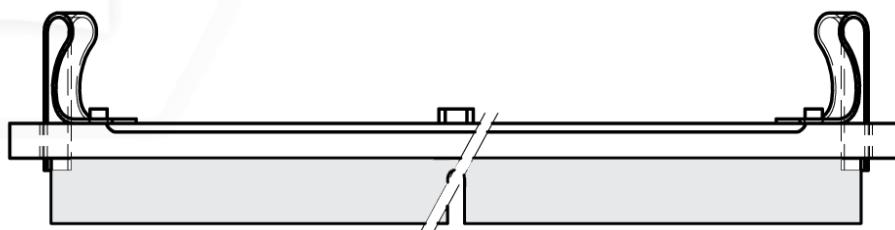
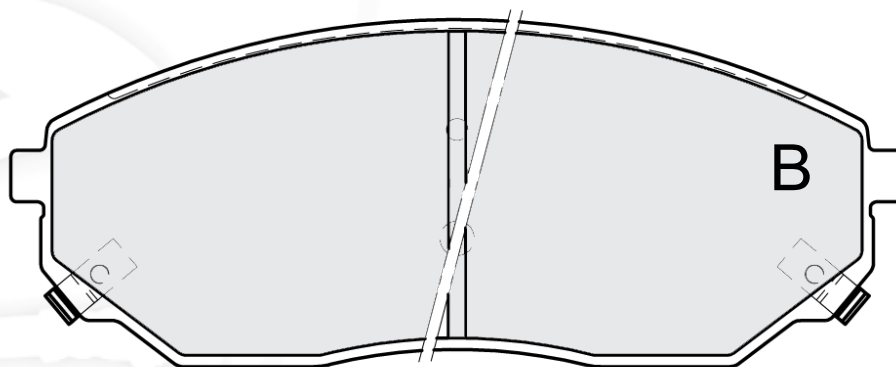
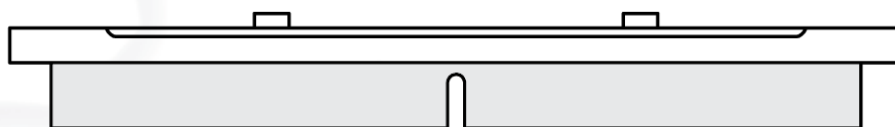
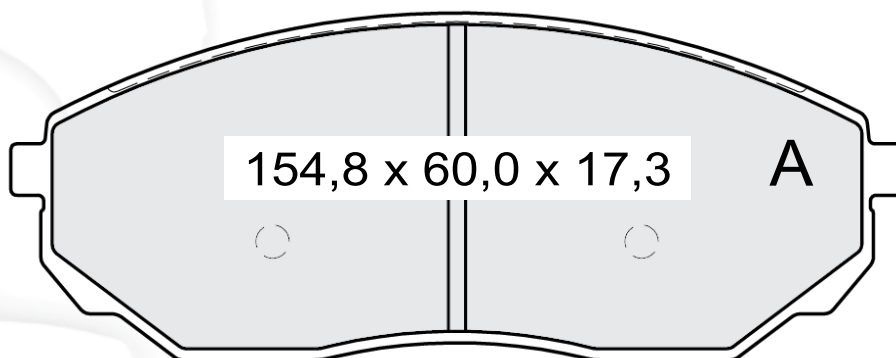

В комплект входят две колодки типа А, две колодки типа В



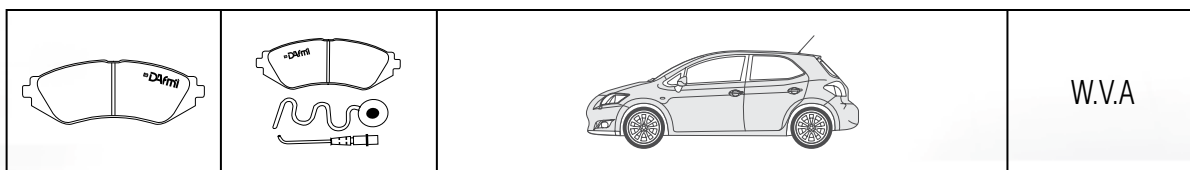

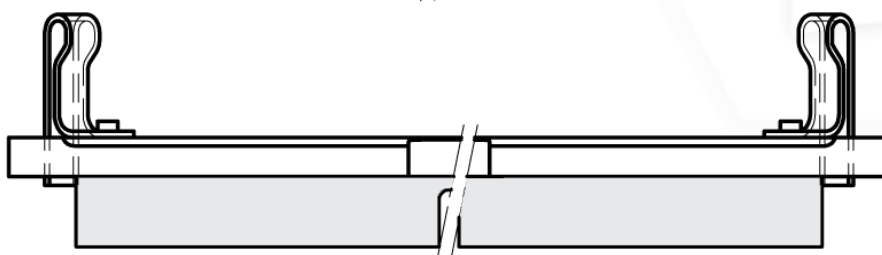
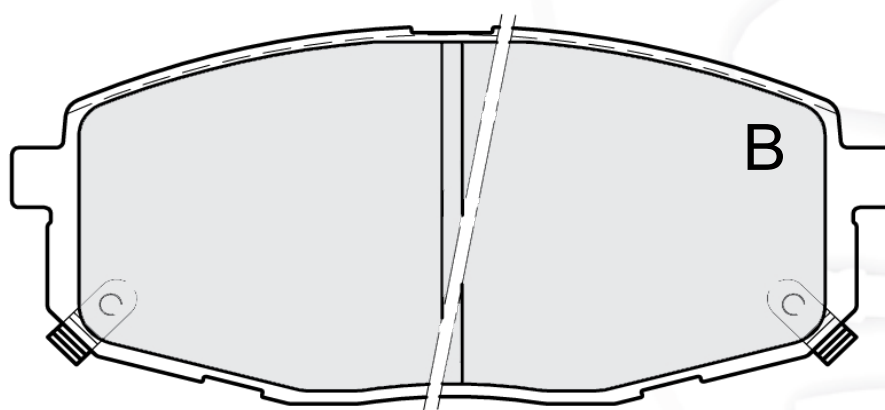
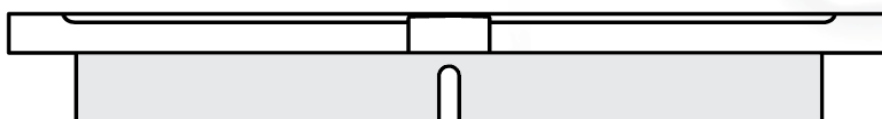
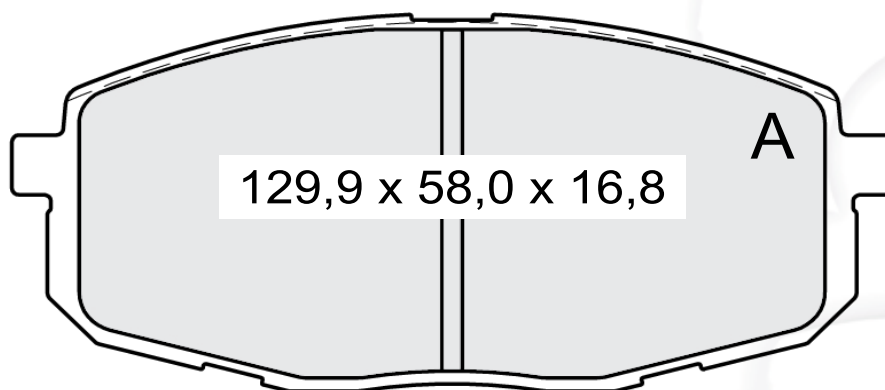

<b>Д233</b>		<b>KIA</b>	
-------------	--	------------	--

Индикатор износа входит в базовую комплектацию данной колодки

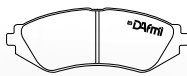
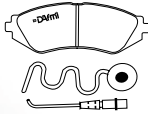

В комплект входят две колодки типа А, две колодки типа В

			W.V.A
<b>Д234</b>		<b>KIA</b>	

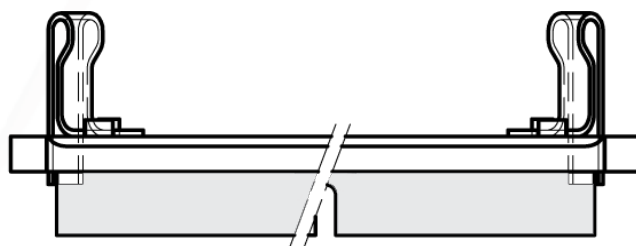
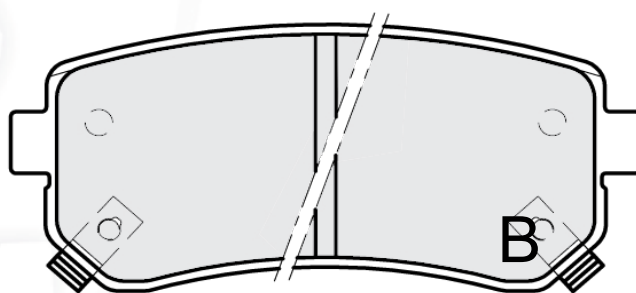
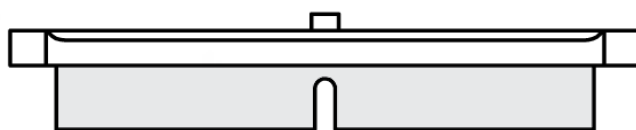
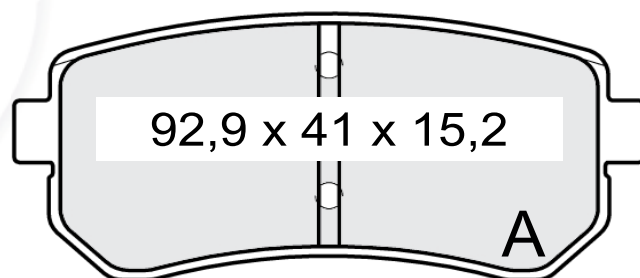



В комплект входят две колодки типа А, две колодки типа В

			W.V.A
<b>Д235</b>		<b>KIA</b>	23455 23456 23457

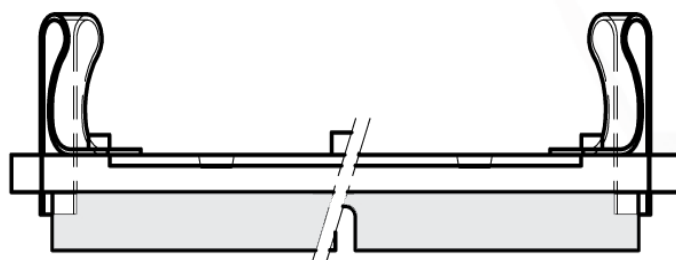
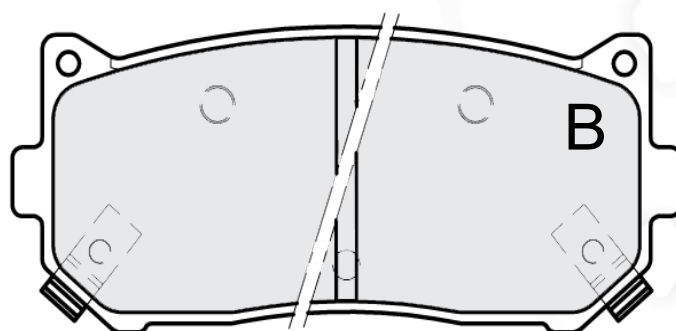
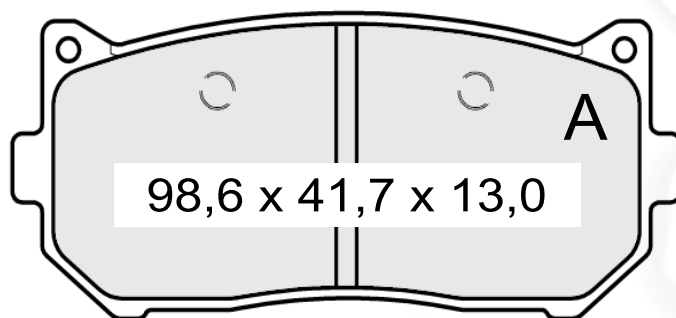
Индикатор износа входит в базовую комплектацию данной колодки

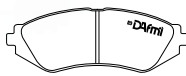
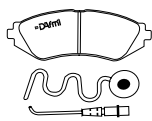

В комплект входят две колодки типа А, две колодки типа В

			<p>W.V.A</p>
<p>241</p>		<p>HYUNDAI</p>	

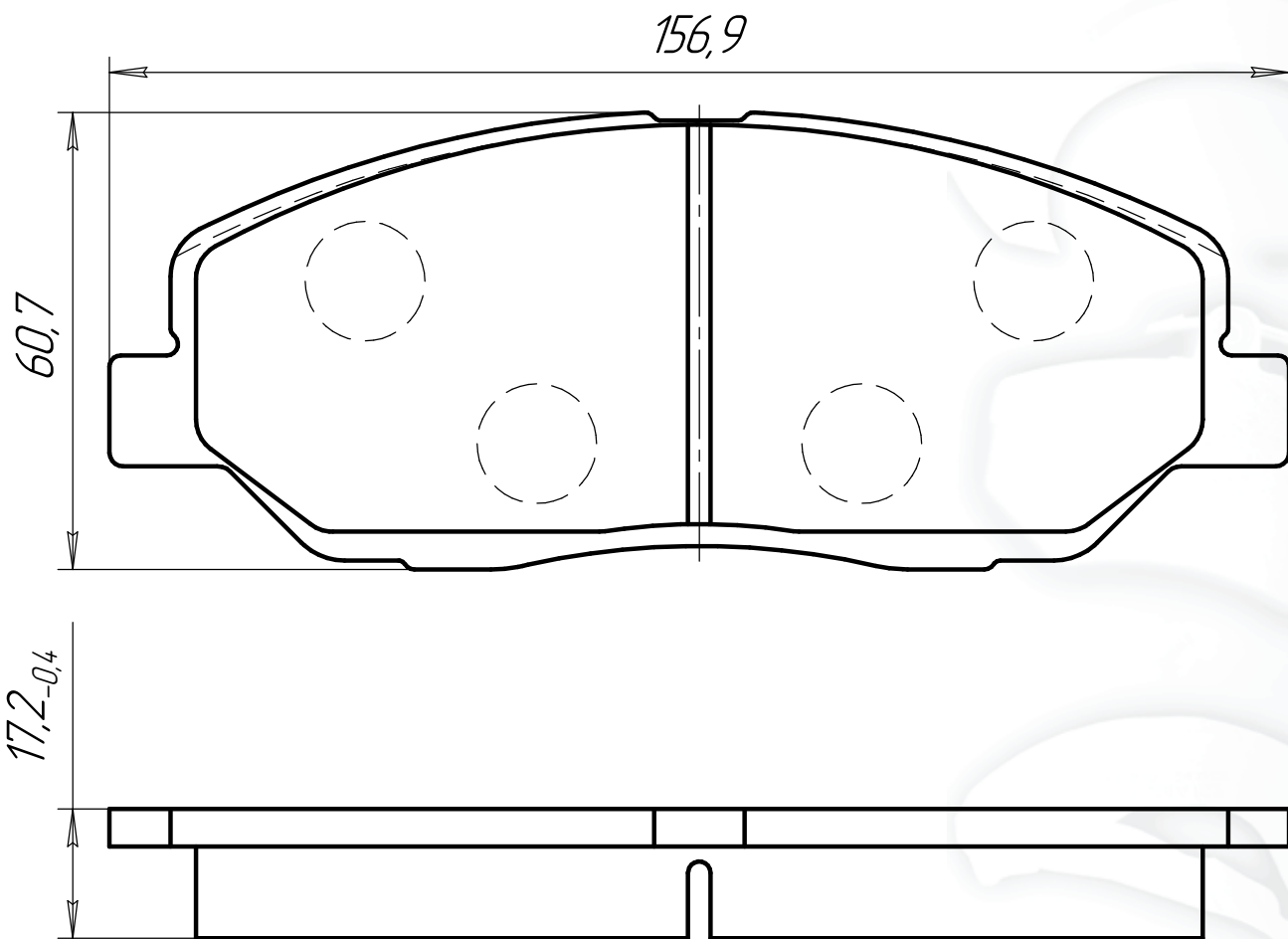

			W.V.A
--	--	--	-------

<b>Д242</b>	<b>Д242И</b>	<b>MERCEDES-BENZ</b>	20392
-------------	--------------	----------------------	-------

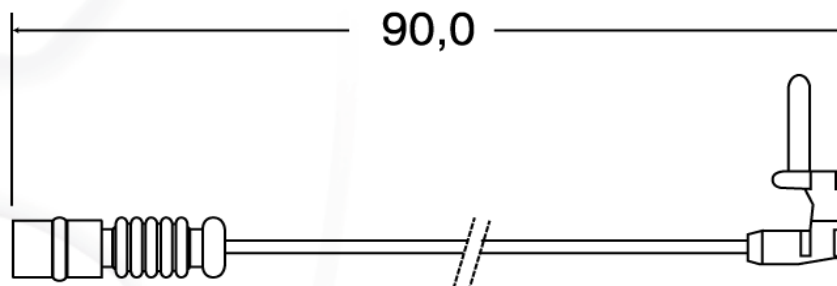
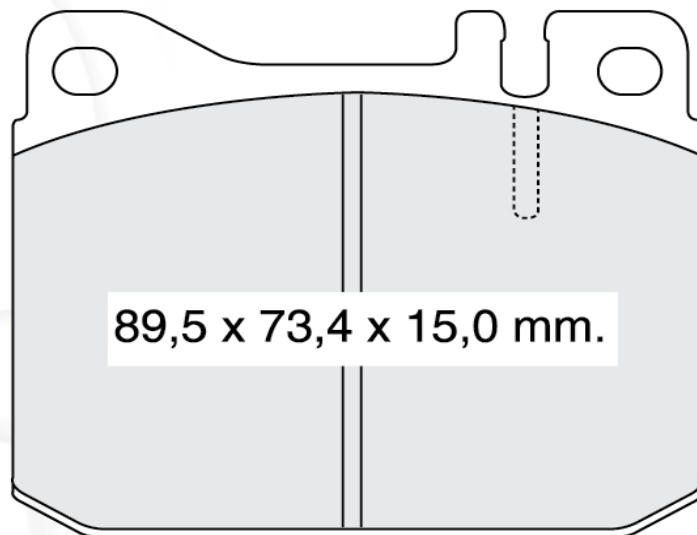

<b>Д253</b>	<b>AUDI, VOLKSWAGEN, VOLVO</b>	20574
-------------	--------------------------------	-------

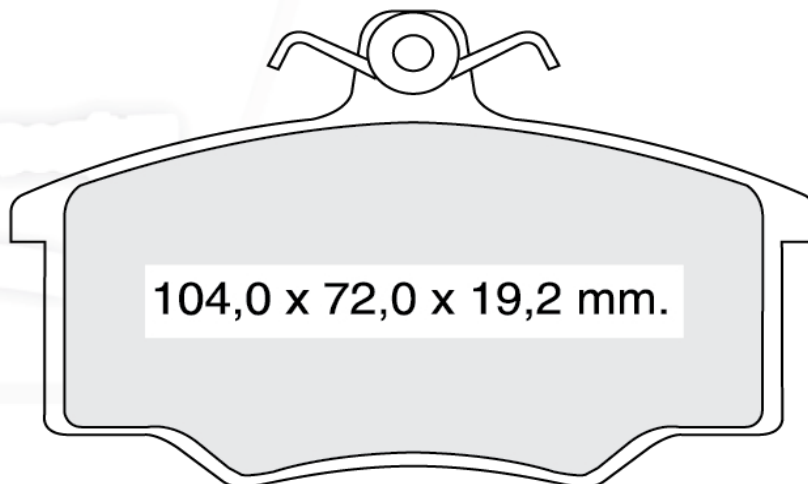

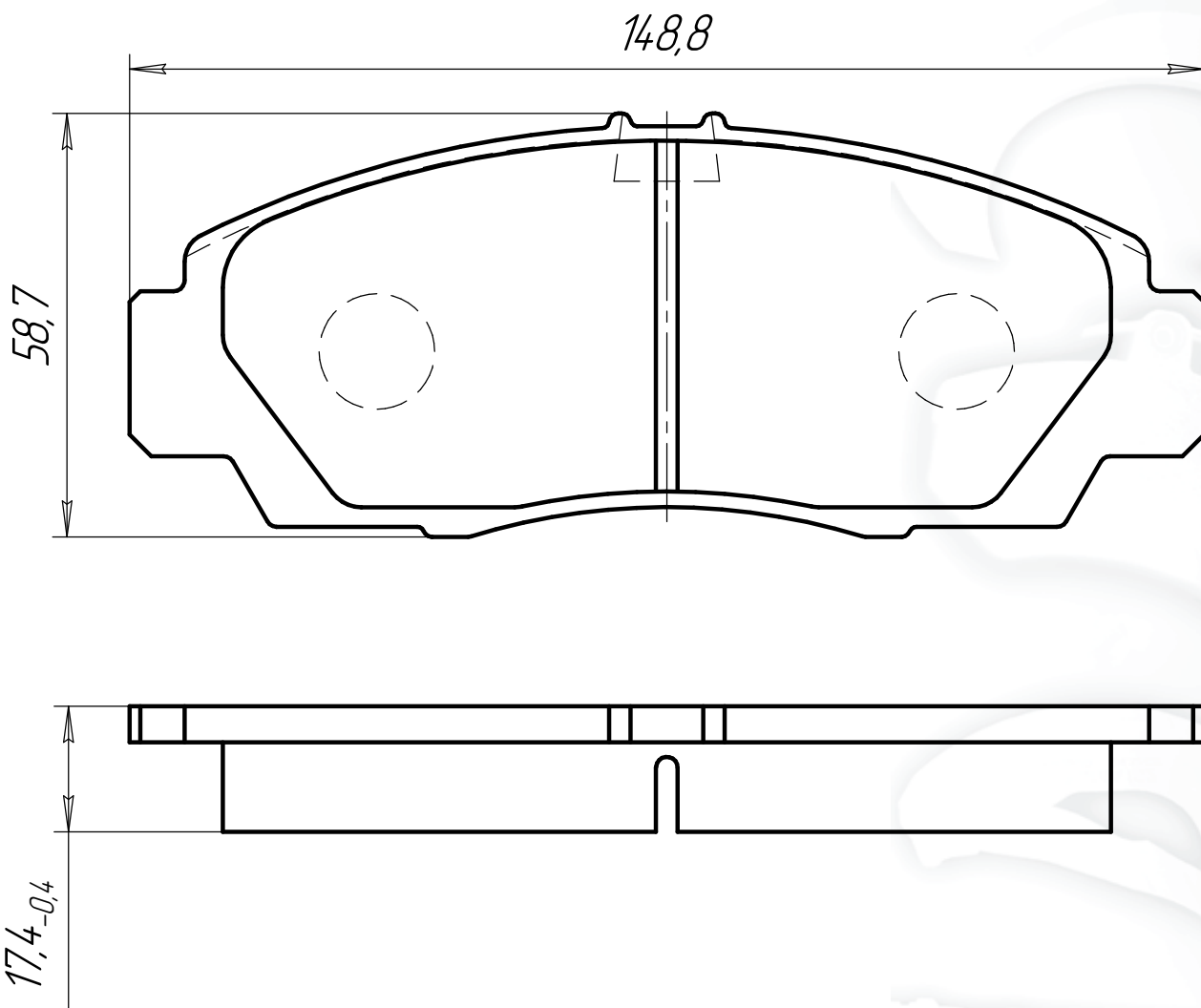

			W.V.A
250		HONDA	

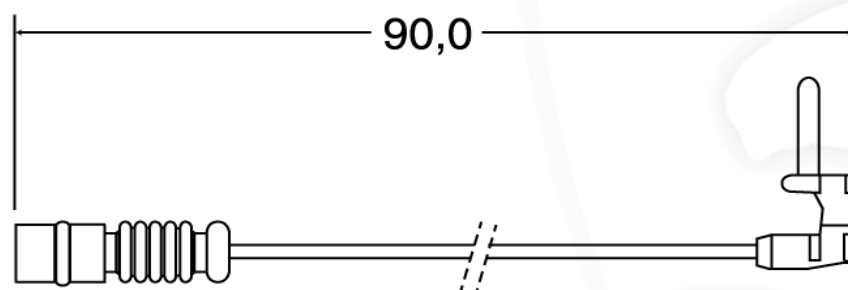
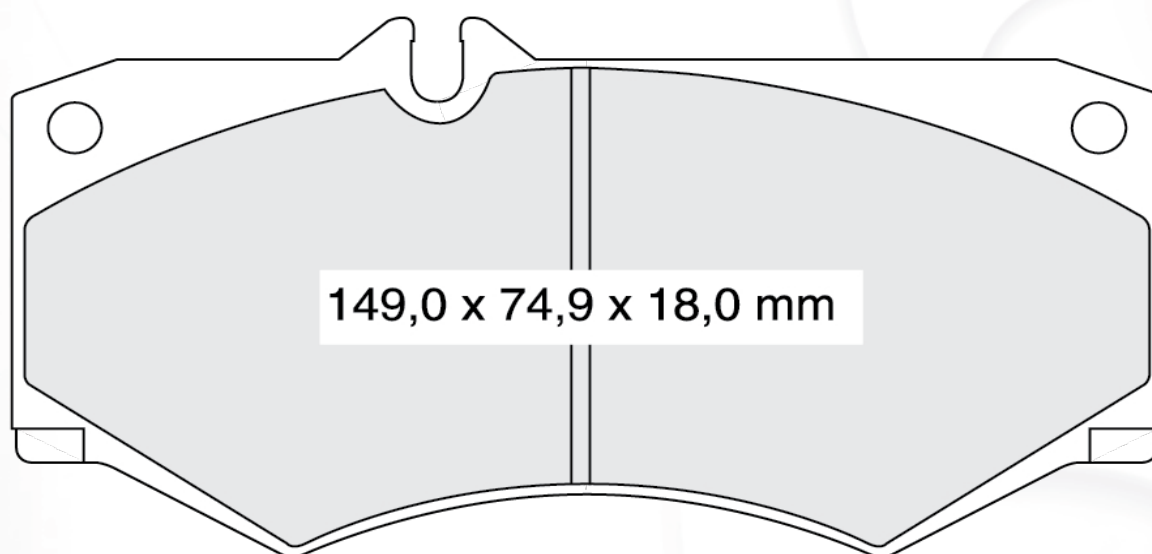

			W.V.A
<b>Д261</b>	<b>Д261И</b>	<b>MERCEDES-BENZ</b>	<b>20336</b>

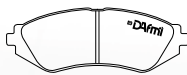
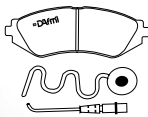

			W.V.A
---	---	--	-------

<b>Д269</b>		<b>BEDFORD, DAEWOO, OPEL</b>	20939
-------------	--	------------------------------	-------

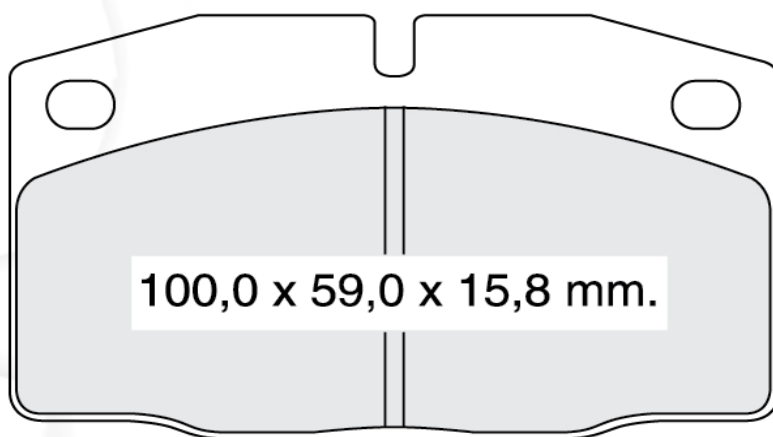

Д269К1 - для невентилируемых дисков  
 Д269К2 - для вентилируемых дисков

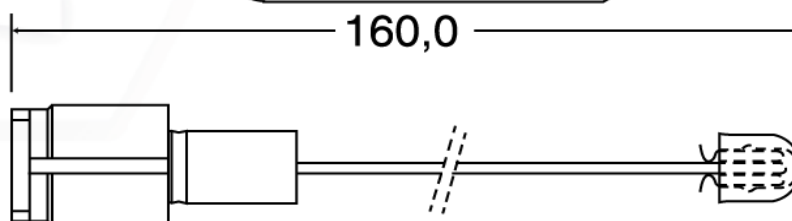
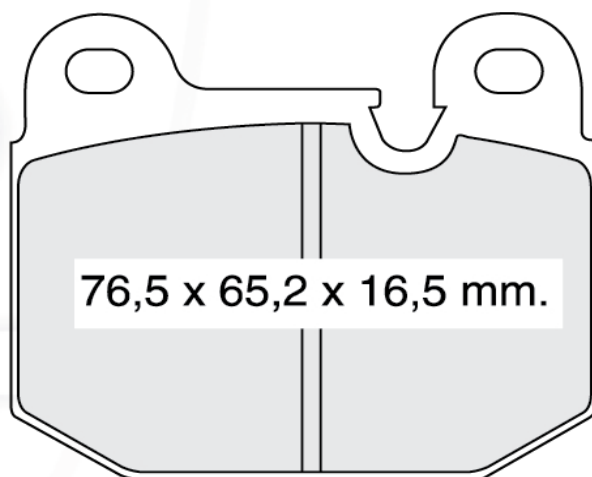

<b>Д276</b>	<b>Д276И</b>	<b>ALFA-ROMEO, BMW, OPEL</b>	20588
-------------	--------------	------------------------------	-------



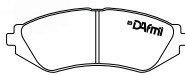
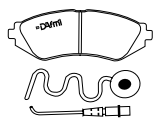

			<p>W.V.A</p>
<p>274</p>		<p>HYUNDAI</p>	

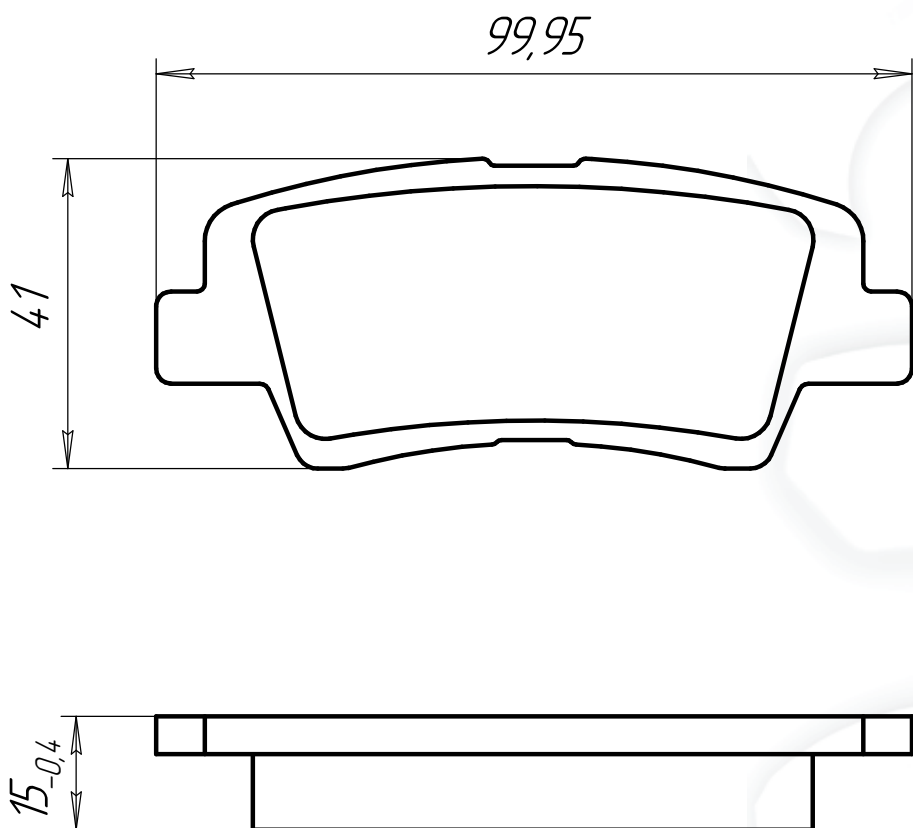

			W.V.A
<b>Д279</b>	<b>Д279И</b>	<b>BMW</b>	<b>20437</b>

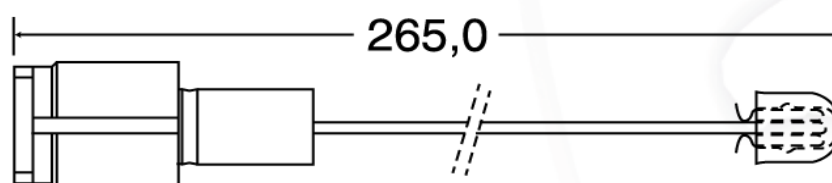
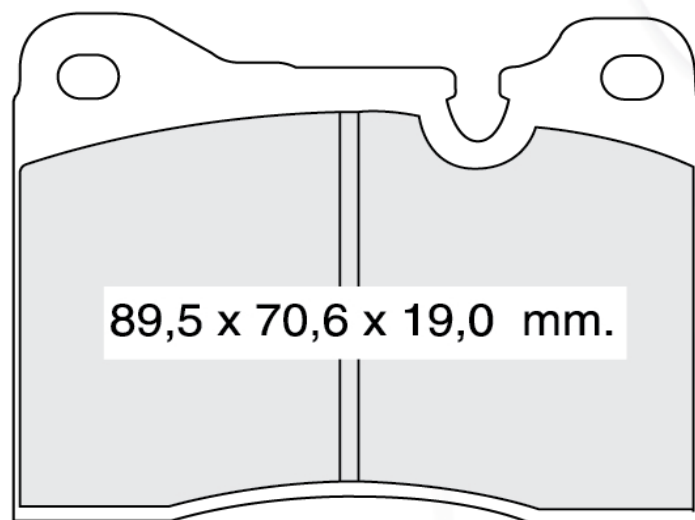

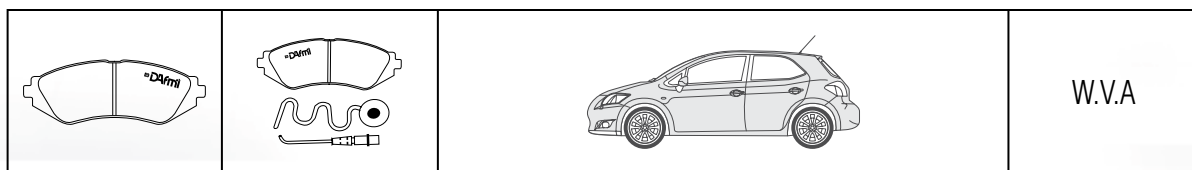

<b>Д281</b>	<b>Д281И</b>	<b>IVECO</b>	<b>29123</b>
-------------	--------------	--------------	--------------

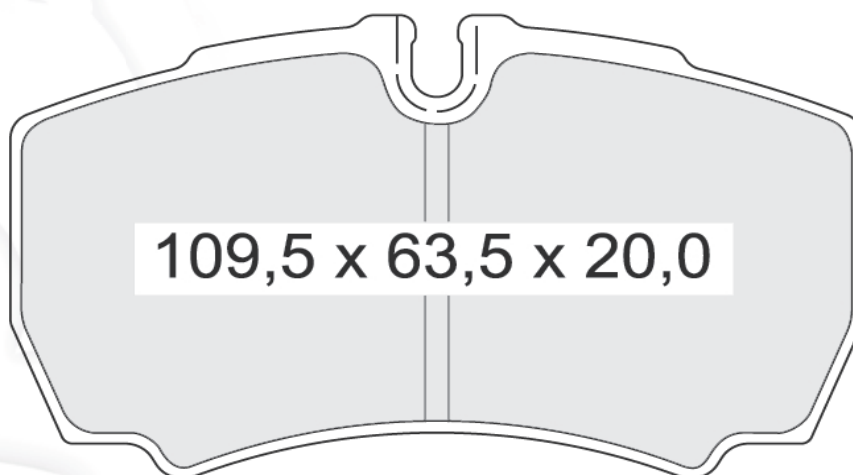

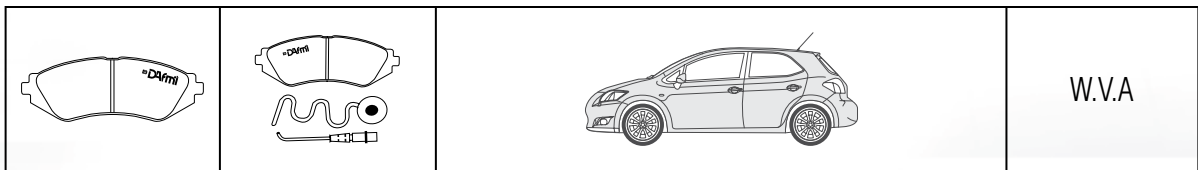

<b>Д284</b>		<b>CITROEN</b>	<b>20575</b>
-------------	--	----------------	--------------

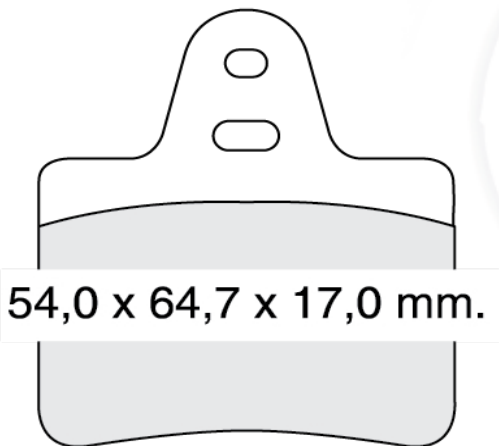

<b>Д288</b>		<b>LEXUS, TOYOTA</b>	<b>21834</b>
-------------	--	----------------------	--------------

Индикатор износа входит в базовую комплектацию данной колодки

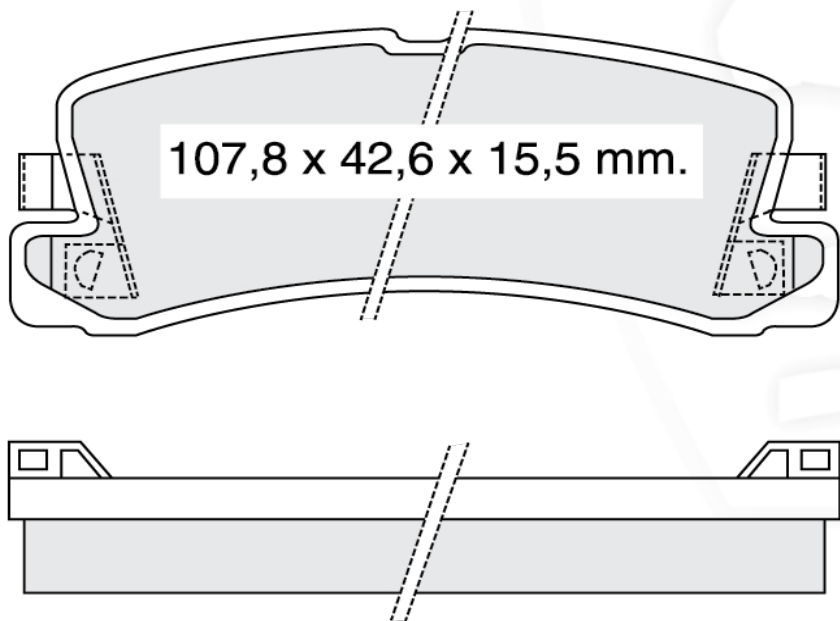

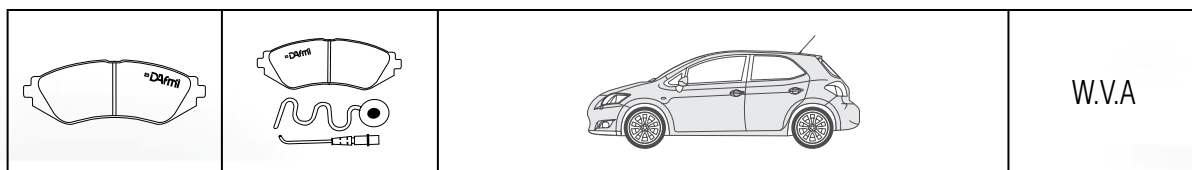

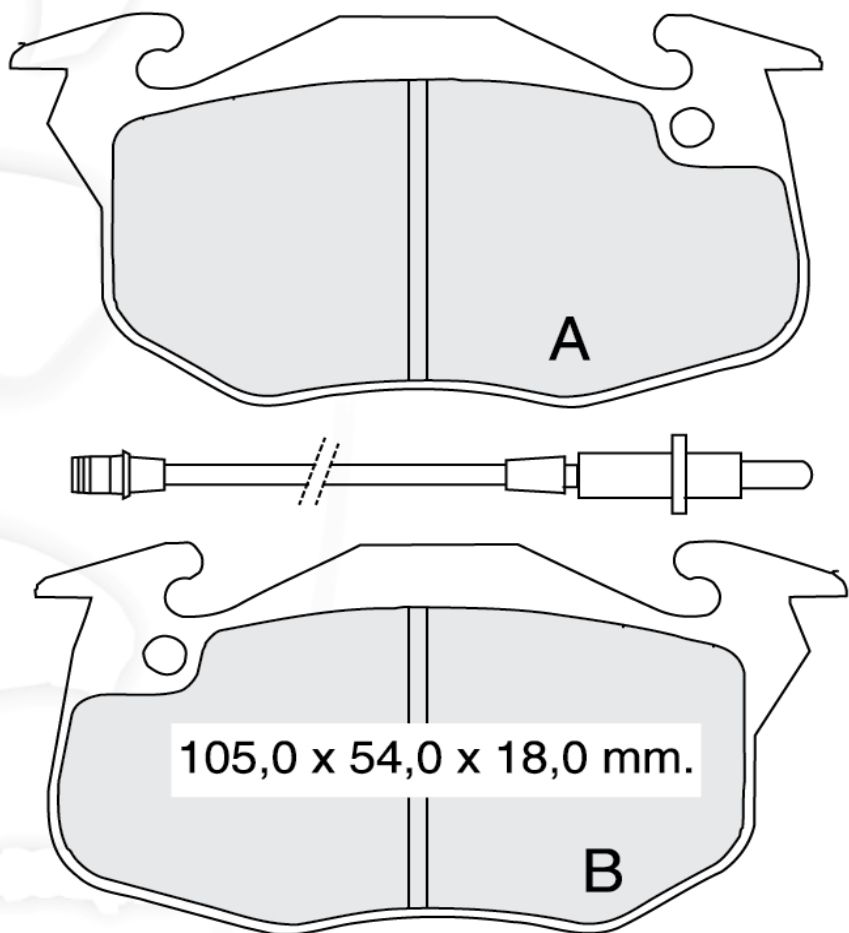

<b>Д294</b>		<b>PEUGEOT, RENAULT</b>	20905
-------------	--	-------------------------	-------

Индикатор износа входит в базовую комплектацию данной колодки

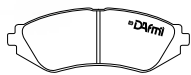
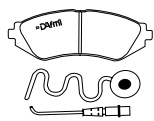

В комплект входят две колодки типа А, две колодки типа В

			W.V.A
<b>Д301</b>	<b>Д301И</b>	<b>ВАЗ</b>	<b>20560</b>

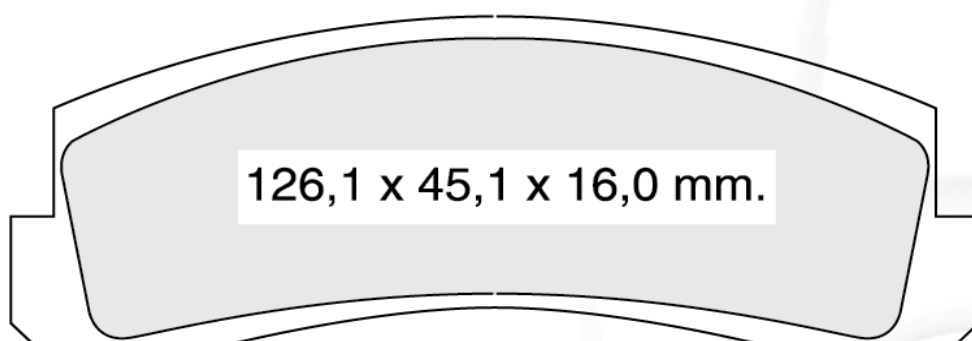

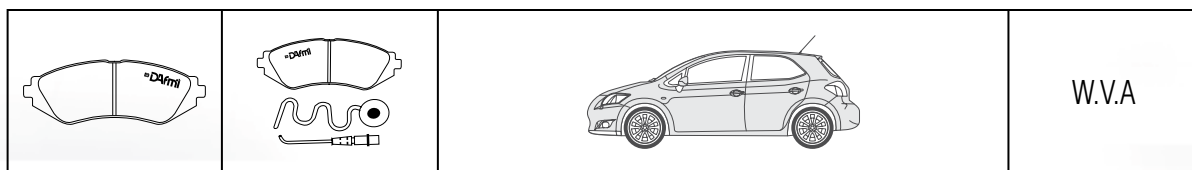

<b>Д309</b>		<b>FORD, KIA</b>	<b>20640</b>
-------------	--	------------------	--------------

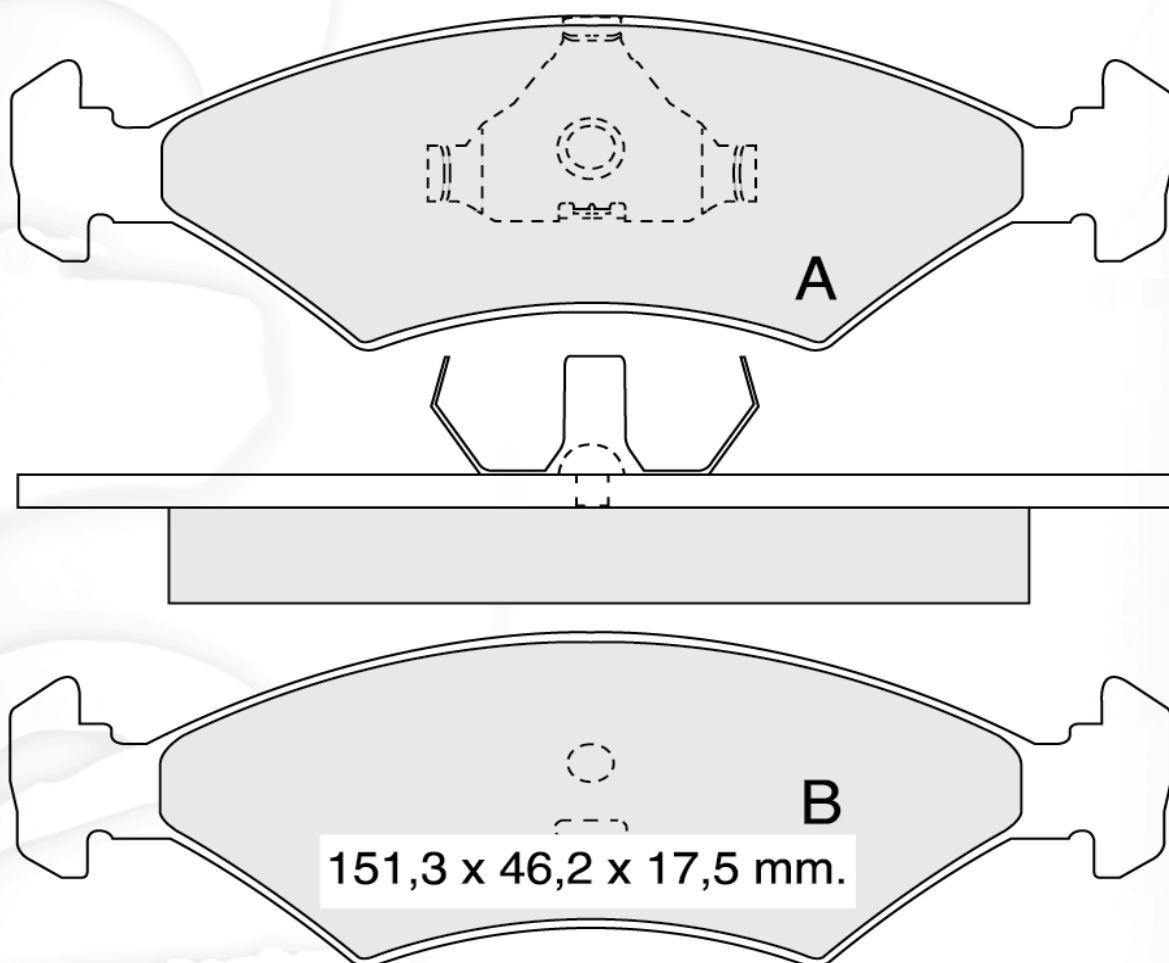

В комплект входят две колодки типа А, две колодки типа В

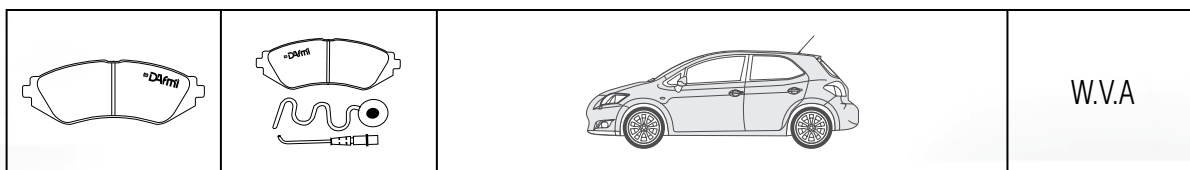

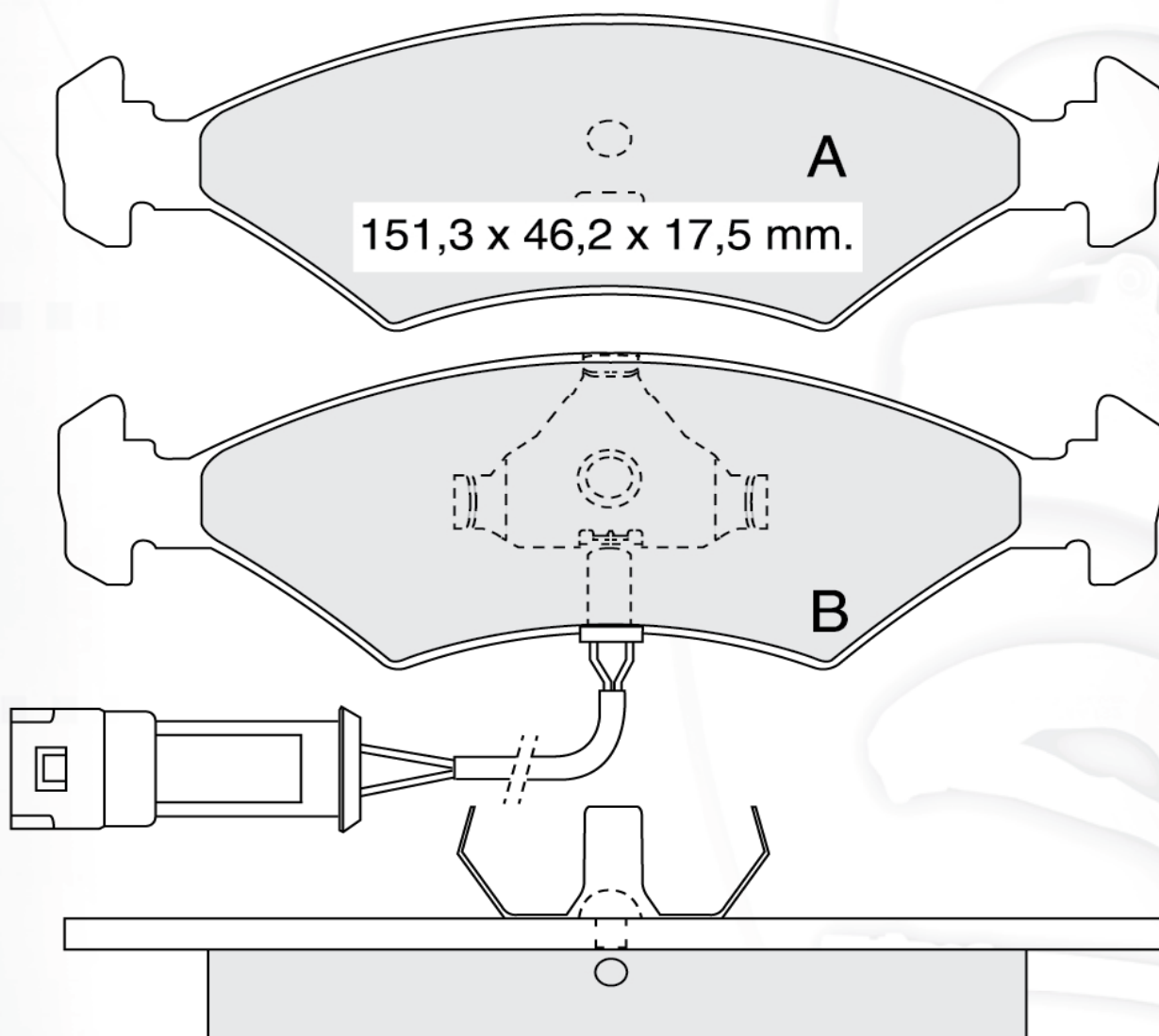

<b>Д311</b>		<b>FORD</b>	<b>20783</b>
-------------	--	-------------	--------------

Индикатор износа входит в базовую комплектацию данной колодки.



В комплект входят две колодки типа А, две колодки типа В

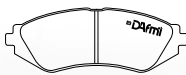
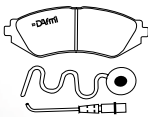

			W.V.A
---	---	--	-------

<b>Д321</b>		<b>NISSAN, SUBARU</b>	<b>20958</b>
-------------	--	-----------------------	--------------

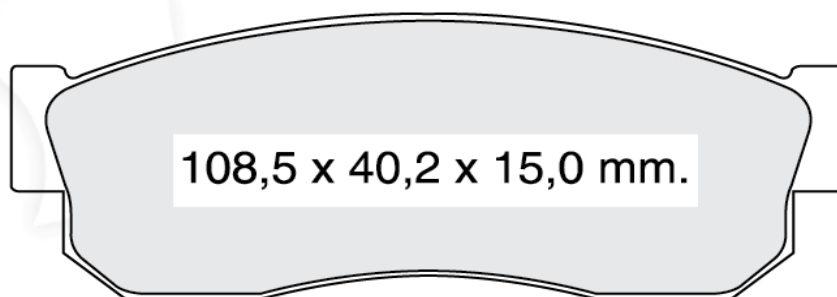

<b>Д324</b>		<b>FORD</b>	<b>21171</b>
-------------	--	-------------	--------------

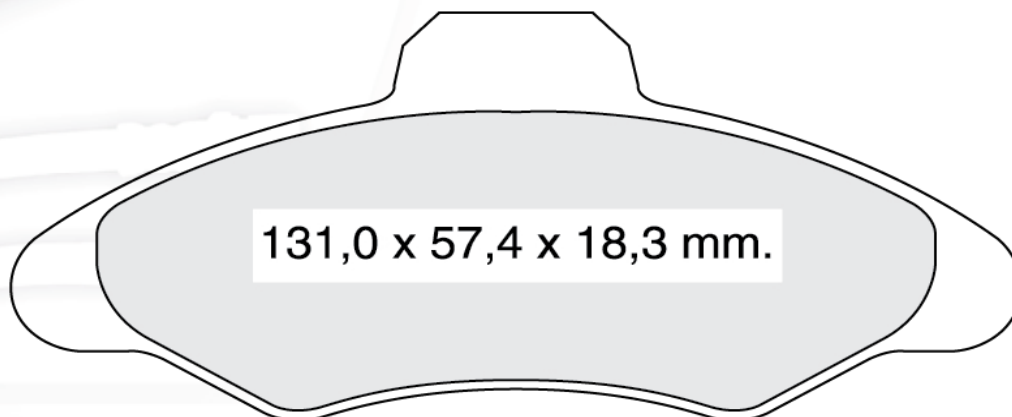

			W.V.A
--	--	--	-------

<b>Д327</b>		<b>AUDI, VOLKSWAGEN</b>	20669
-------------	--	-------------------------	-------

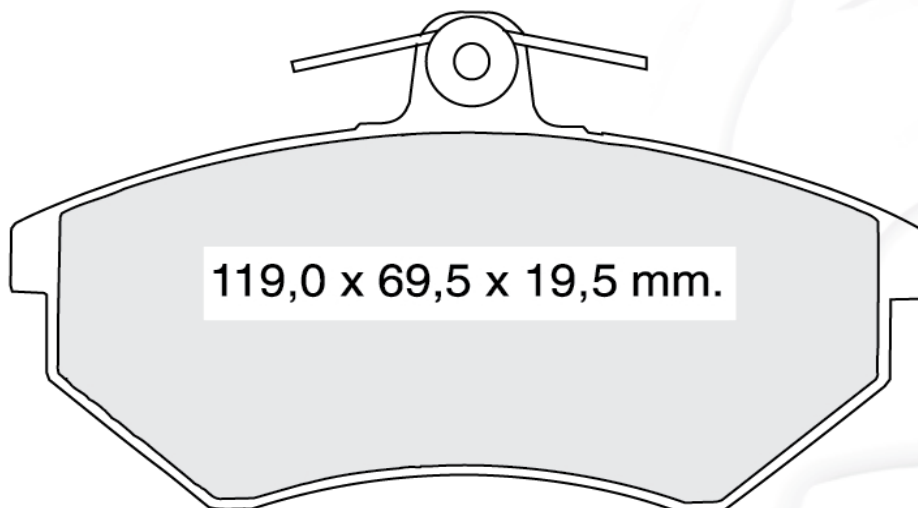

<b>Д328</b>		<b>AUDI</b>	20901
-------------	--	-------------	-------

Индикатор износа входит в базовую комплектацию данной колодки.

Комплект состоит из двух колодок с индикатором износа и двух колодок без индикатора износа.

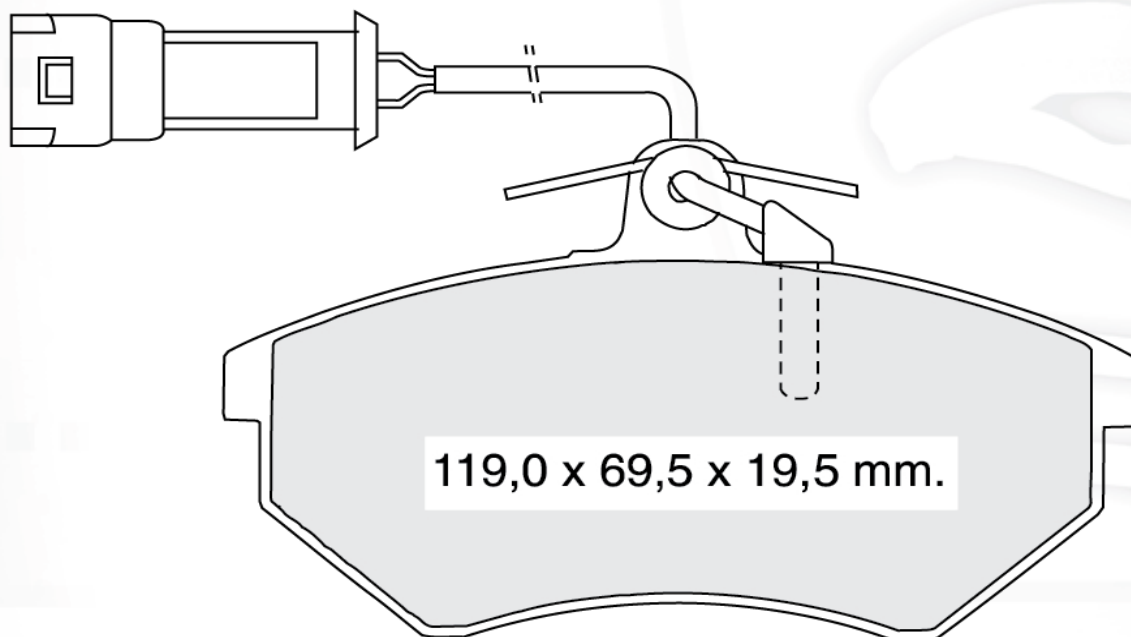

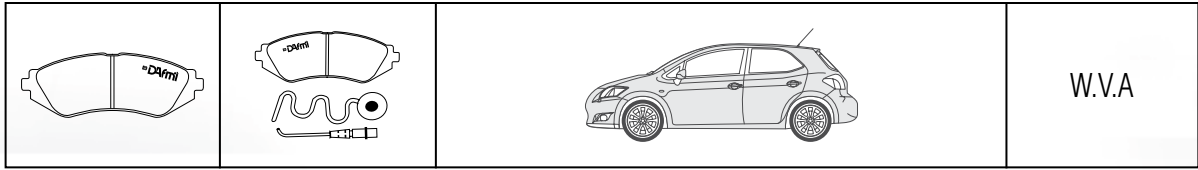

<b>Д331</b>		<b>NISSAN</b>	<b>20718</b>
-------------	--	---------------	--------------

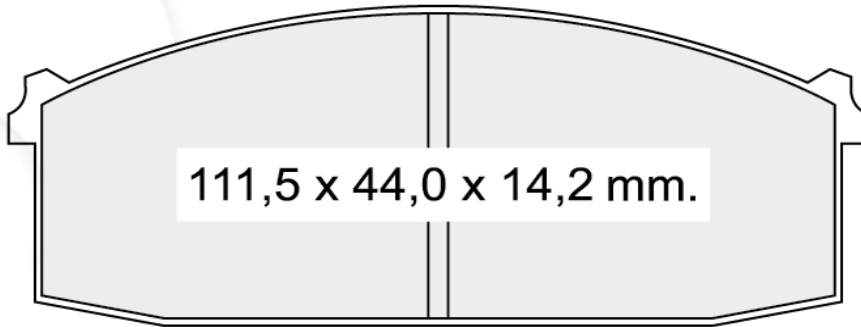

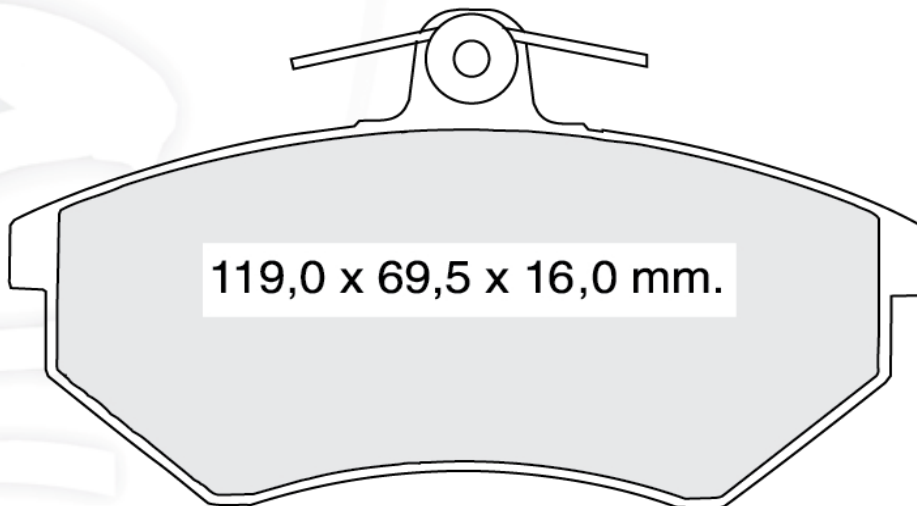

<b>Д332</b>		<b>AUDI, VOLKSWAGEN</b>	<b>20669</b>
-------------	--	-------------------------	--------------

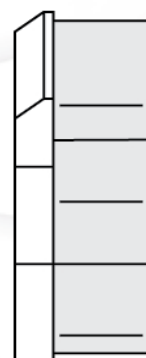
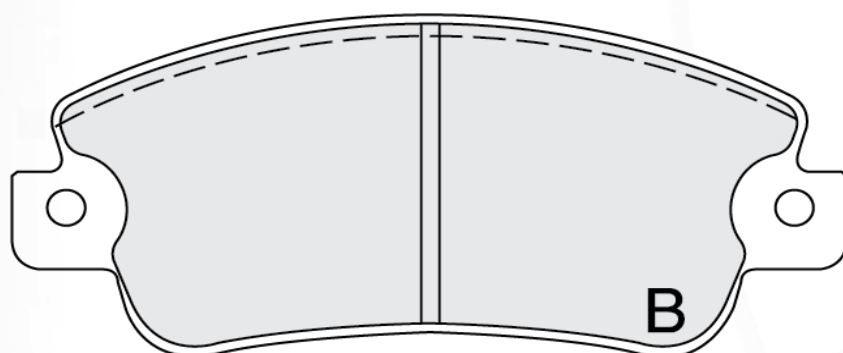
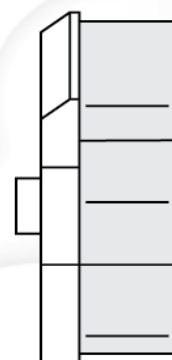
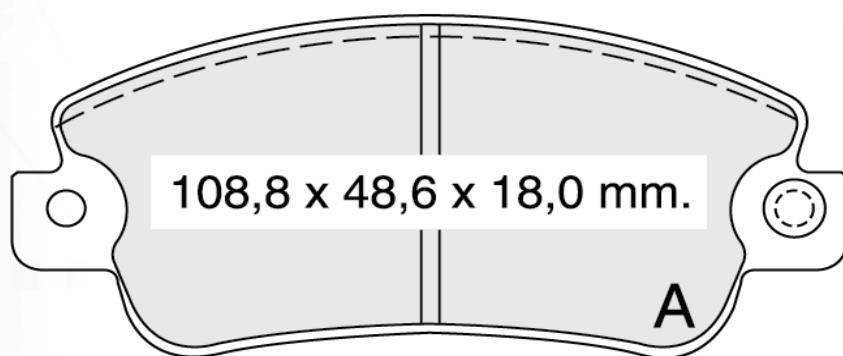

			W.V.A
<b>Д334</b>		<b>FIAT, LANCIA, SEAT</b>	<b>20950</b>
Индикатор износа входит в базовую комплектацию данной колодки.			

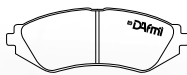
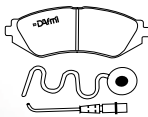

В комплект входят две колодки типа А, две колодки типа В

			W.V.A
---	---	--	-------

<b>Д339</b>	<b>Д339И</b>	<b>PEUGEOT, RENAULT, DACIA</b>	<b>20770</b>
-------------	--------------	--------------------------------	--------------

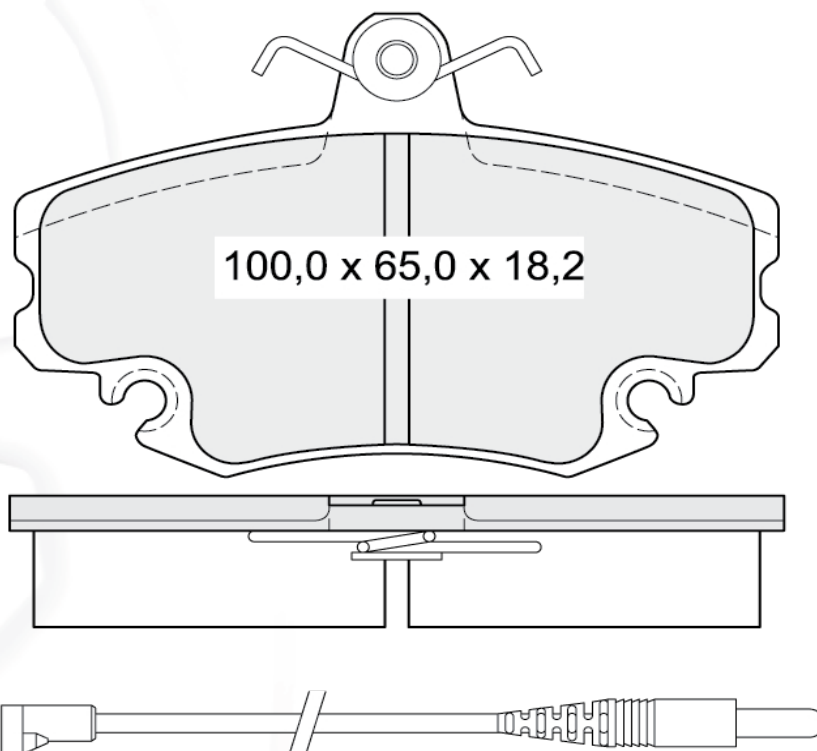

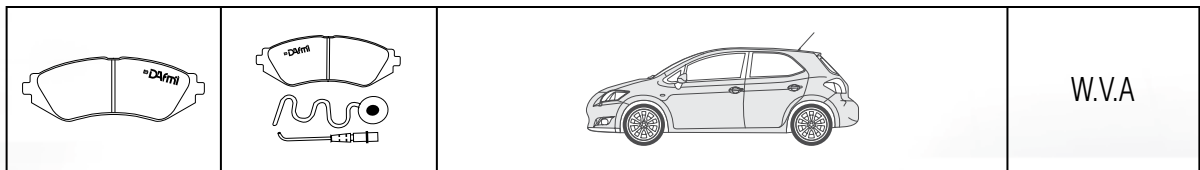

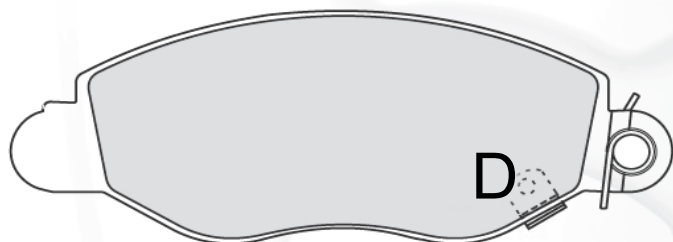
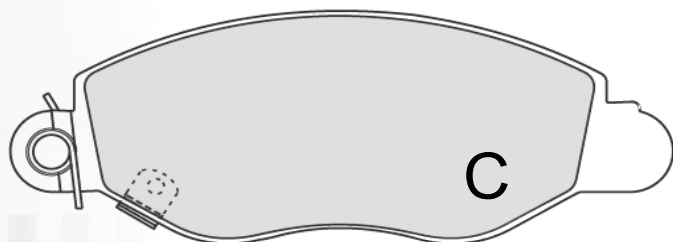
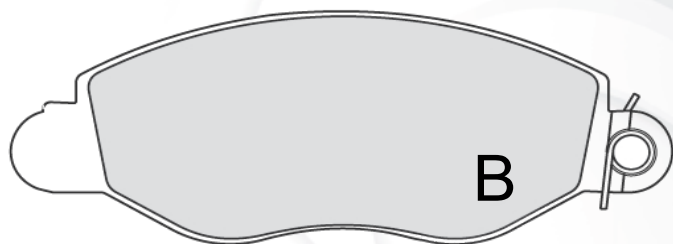
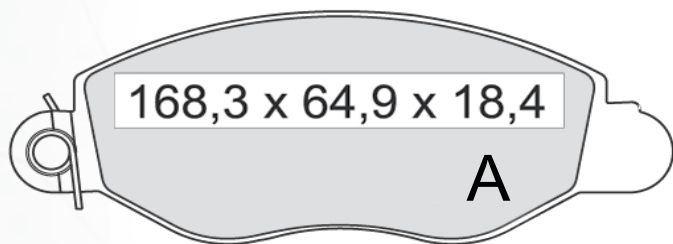

<b>Д340</b>		<b>FORD</b>	<b>23430</b>
-------------	--	-------------	--------------

Индикатор износа входит в базовую комплектацию данной колодки

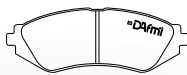
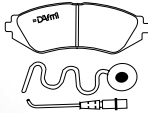

В комплект входят одна колодка А, одна колодка В,  
одна колодка С, одна колодка D

			W.V.A
---	---	--	-------

<b>Д342</b>	<b>Д342И</b>	<b>BMW</b>	<b>21173</b>
-------------	--------------	------------	--------------

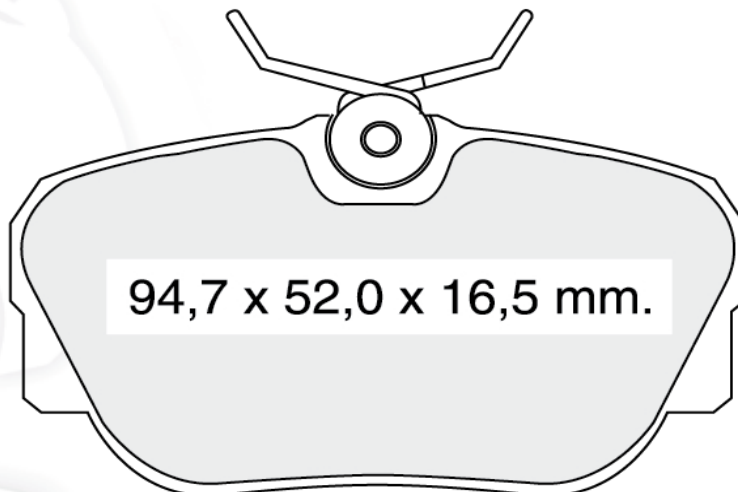

			W.V.A
<b>Д343</b>		<b>HYUNDAI</b>	

Индикатор износа входит в базовую комплектацию данной колодки

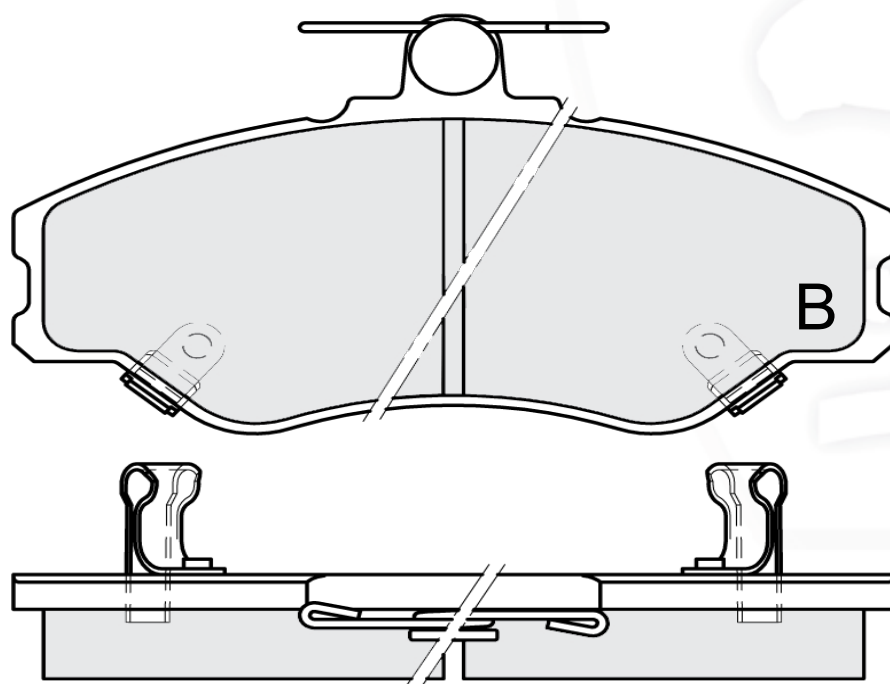
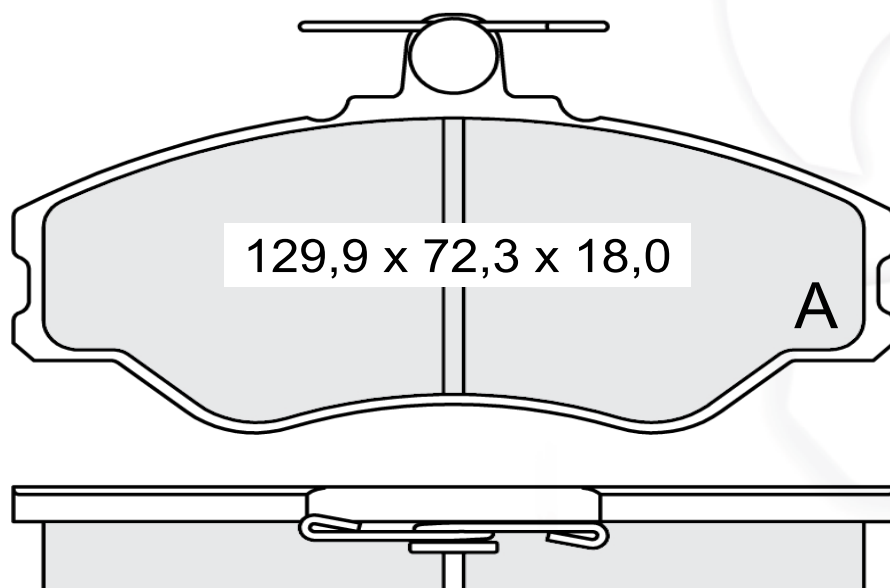

В комплект входят две колодки типа А, две колодки типа В



			W.V.A
<b>Д344</b>		<b>MINI</b>	24014 24015

Индикатор износа входит в базовую комплектацию данной колодки

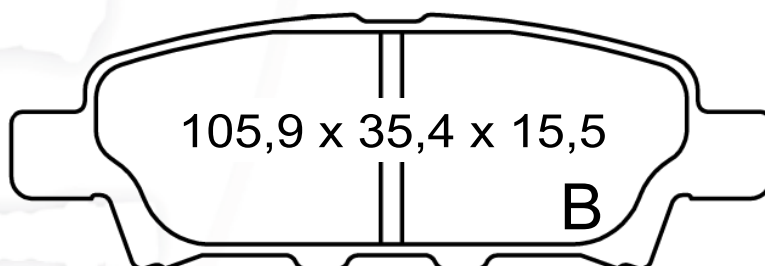
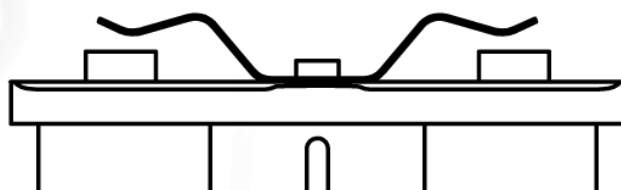
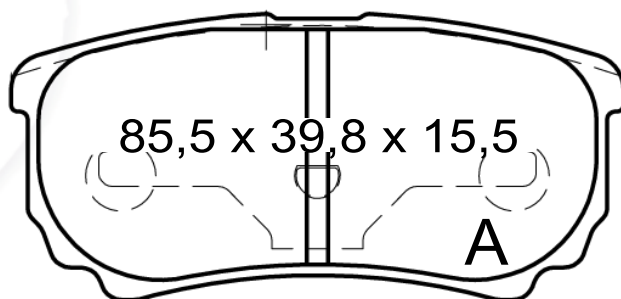

В комплект входят две колодки типа А, две колодки типа В

			W.V.A
--	--	--	-------

<b>Д345</b>		<b>KIA</b>	
-------------	--	------------	--

Индикатор износа входит в базовую комплектацию данной колодки

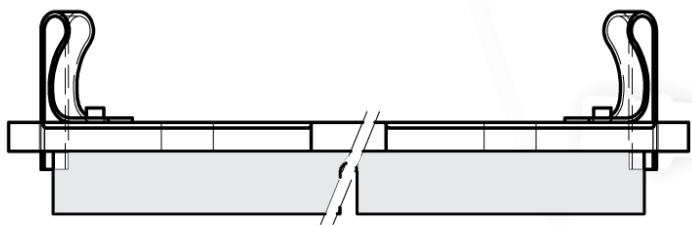
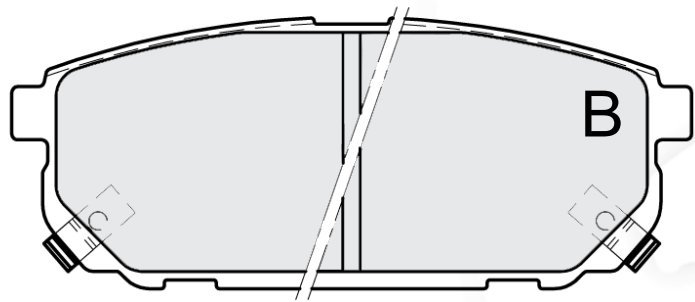
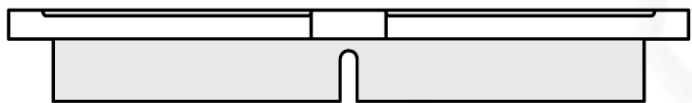
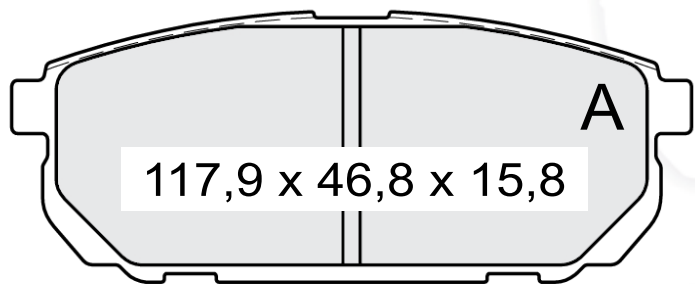

В комплект входят две колодки типа А, две колодки типа В

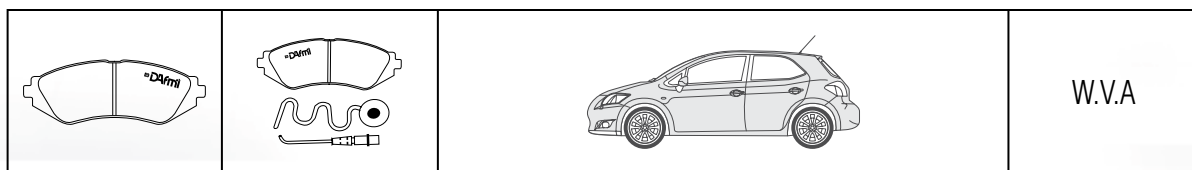

<b>Д352</b>		<b>CITROEN, PEUGEOT</b>	<b>20859</b>
-------------	--	-------------------------	--------------

Индикатор износа входит в базовую комплектацию данной колодки.

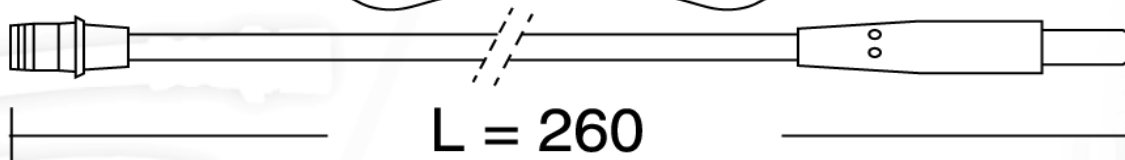
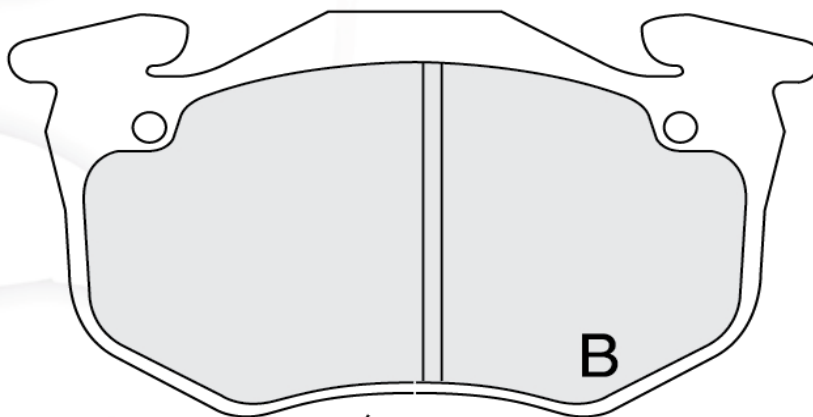
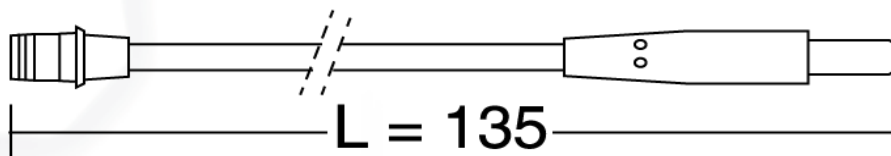
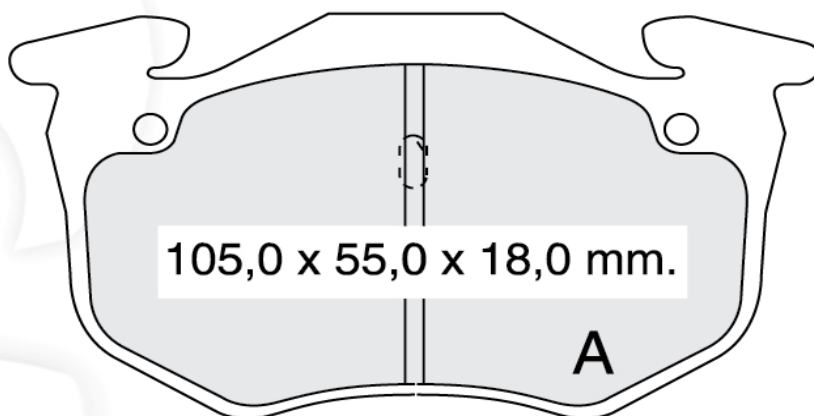

В комплект входят две колодки типа А, две колодки типа В

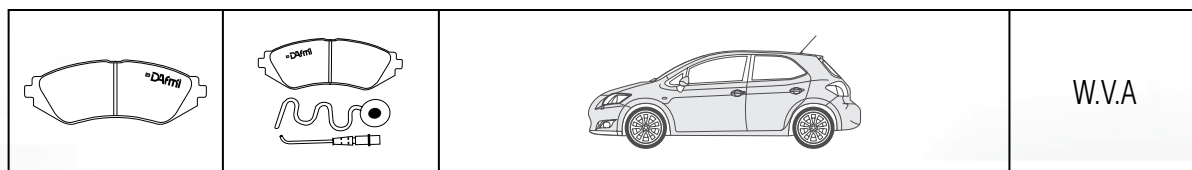

<p><b>Д359</b></p>		<p><b>FORD, HYUNDAI</b></p>	<p><b>20491</b></p>
--------------------	--	-----------------------------	---------------------

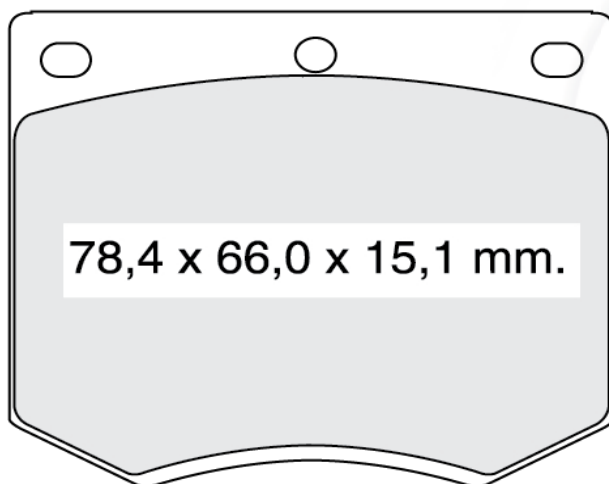



			W.V.A
--	--	--	-------

<b>Д361</b>		<b>ТОУОТА</b>	
-------------	--	---------------	--

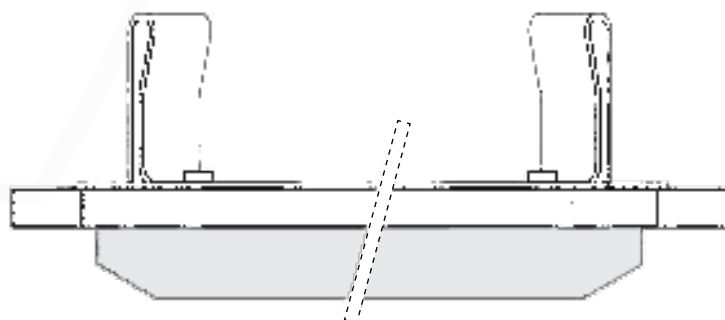
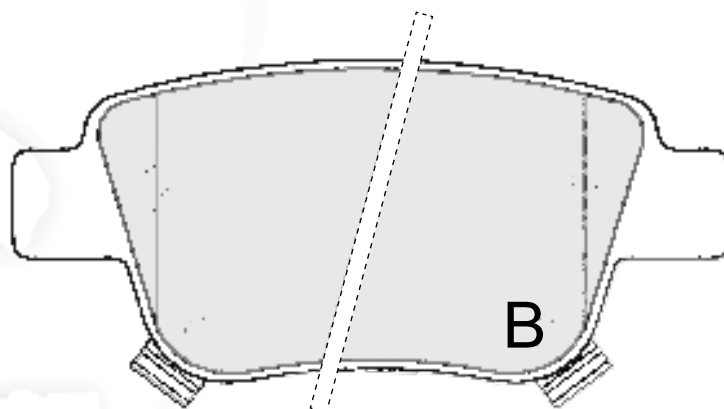
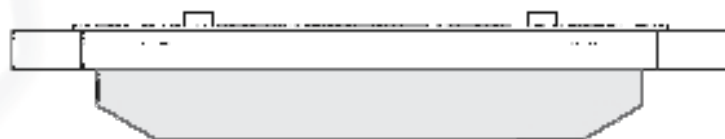
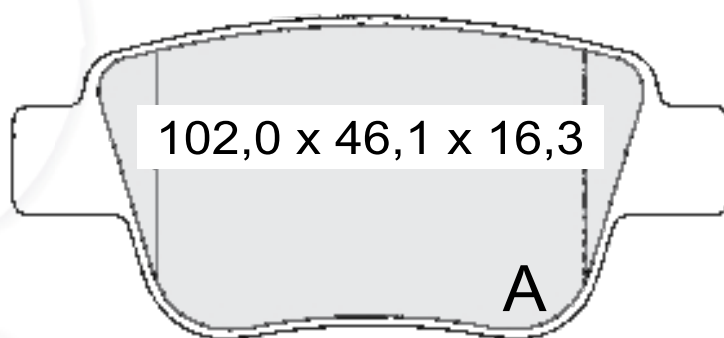
Индикатор износа входит в базовую комплектацию данной колодки

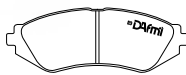
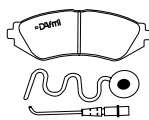

В комплект входят две колодки типа А, две колодки типа В

			<p>W.V.A</p>
<p><b>Д362</b></p>		<p><b>FORD</b></p>	

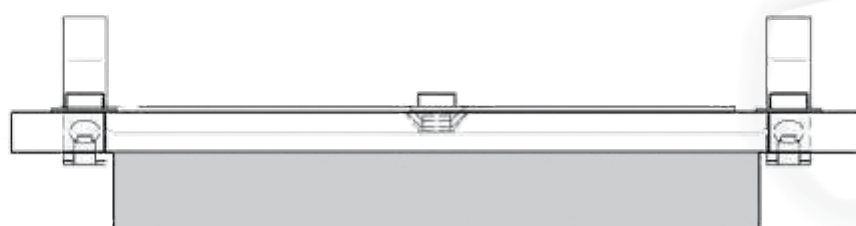
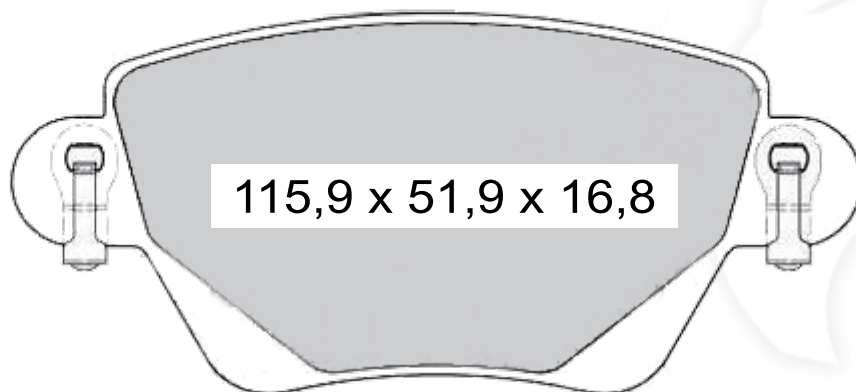

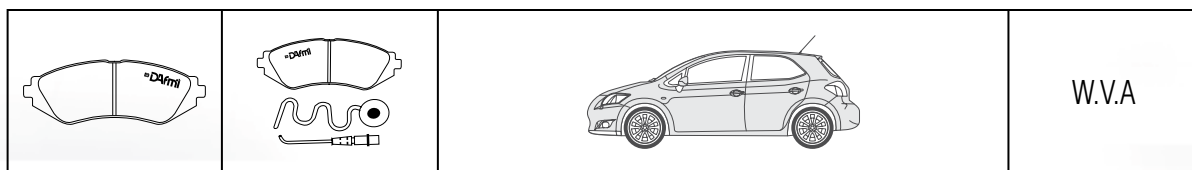

<b>Д364</b>	<b>Д364К</b>	<b>SEAT, VOLKSWAGEN</b>	<b>21173</b>
-------------	--------------	-------------------------	--------------

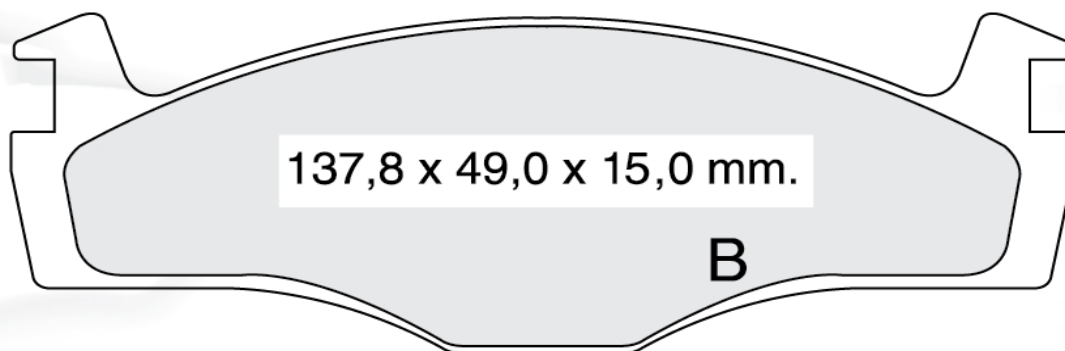
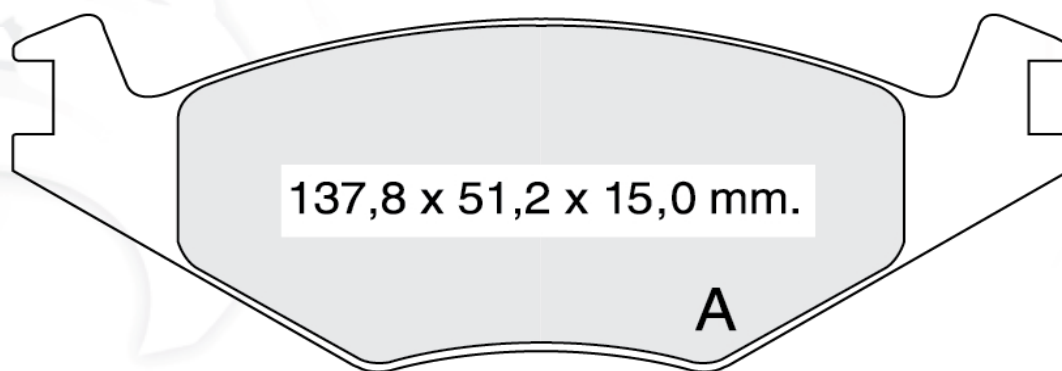

В комплект входят две колодки типа А, две колодки типа В

			W.V.A
--	--	--	-------

<b>Д366</b>		<b>SEAT, VOLKSWAGEN</b>	<b>20888</b>
-------------	--	-------------------------	--------------

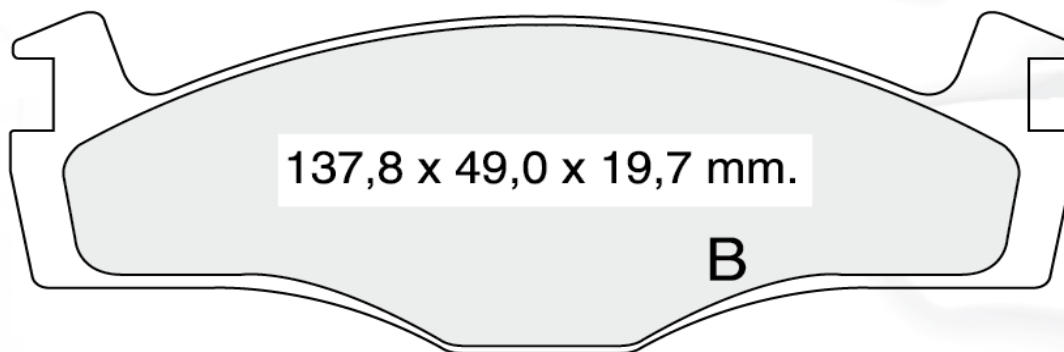
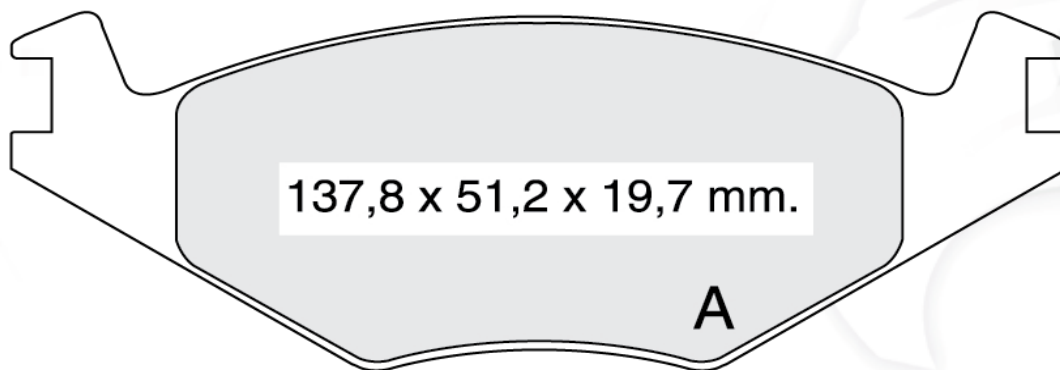

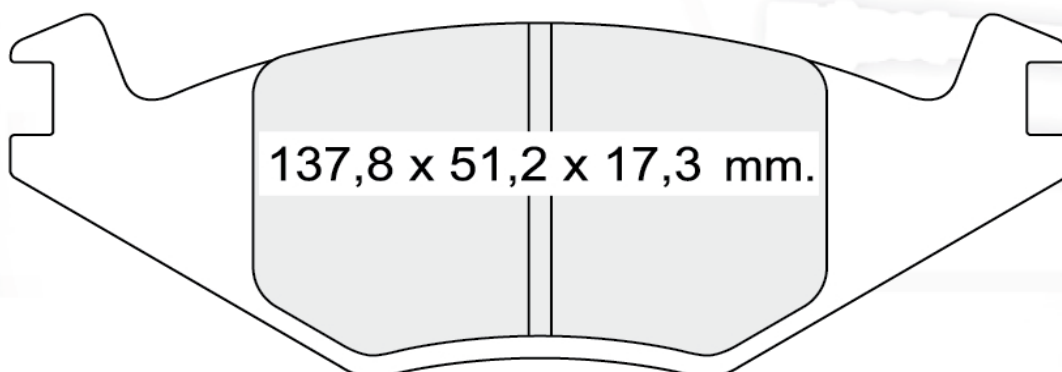

В комплект входят две колодки типа А, две колодки типа В

<b>Д368</b>	<b>Д368К</b>	<b>SEAT, VOLKSWAGEN</b>	<b>20889</b>
-------------	--------------	-------------------------	--------------



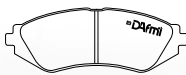
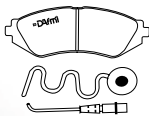

			W.V.A
---	---	--	-------

<b>Д369</b>		<b>ALFA ROMEO, AUDI, FIAT, LANCIA, VOLKSWAGEN</b>	20668
-------------	--	---	-------

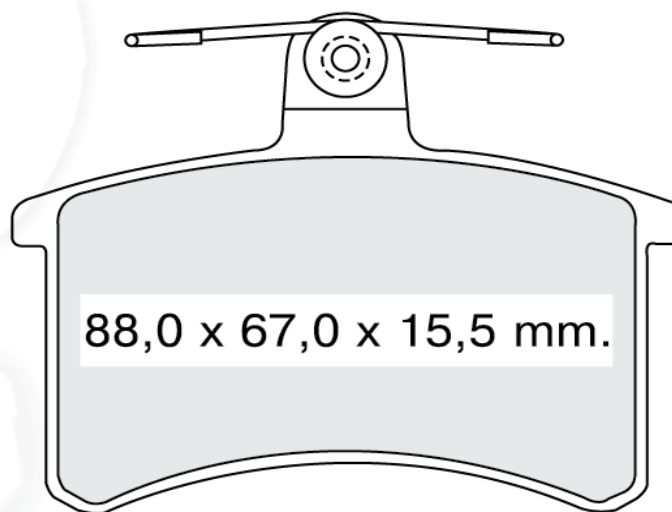

<b>Д373</b>		<b>ALFA ROMEO, FIAT, LANCIA</b>	20838
-------------	--	---------------------------------	-------

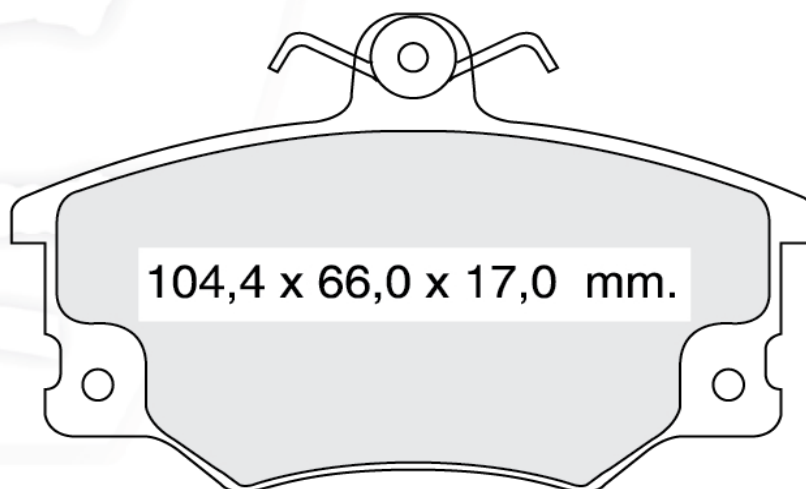

Индикатор износа входит в базовую комплектацию данной колодки.

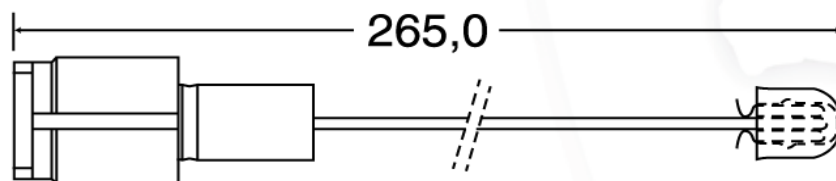
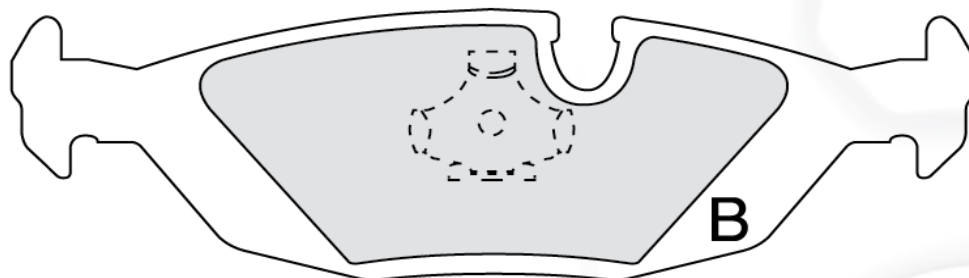
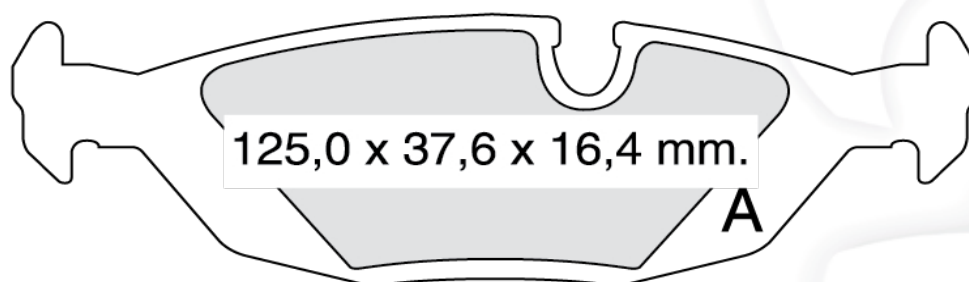

			W.V.A
<b>Д381</b>	<b>Д381И</b>	<b>BMW</b>	<b>20675</b>

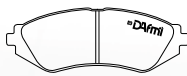
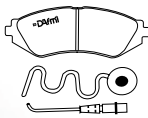

В комплект входят две колодки типа А, две колодки типа В

			W.V.A
<b>Д387</b>	<b>Д387И</b>	<b>MAZDA</b>	<b>21041</b>

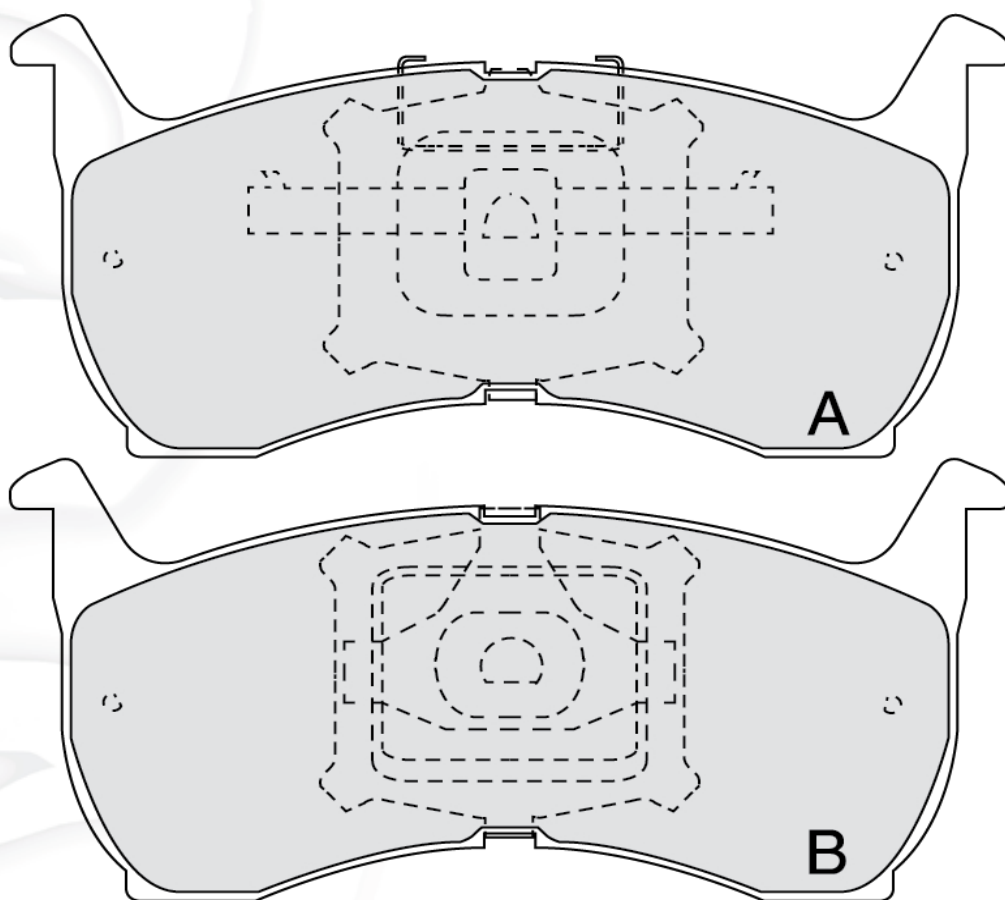

130,0 x 61,0 x 15,0 mm.

В комплект входят две колодки типа А, две колодки типа В

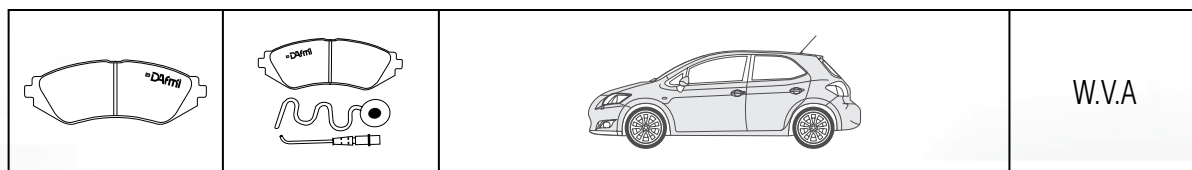

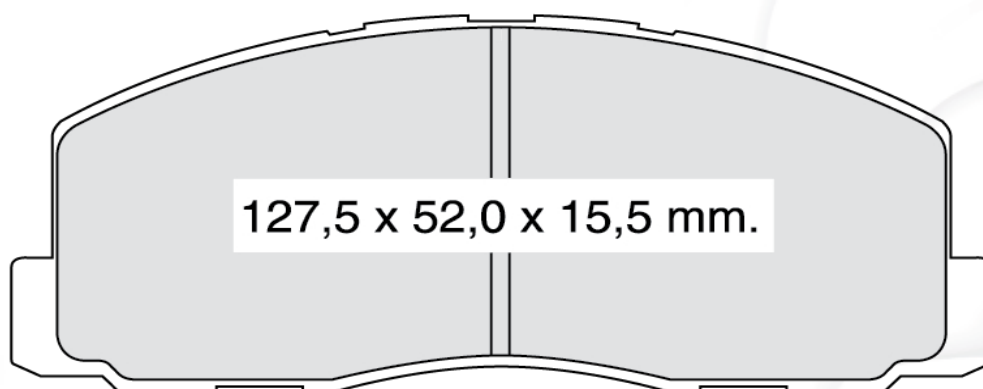

<b>Д396</b>		<b>MITSUBISHI</b>	<b>20955</b>
-------------	--	-------------------	--------------

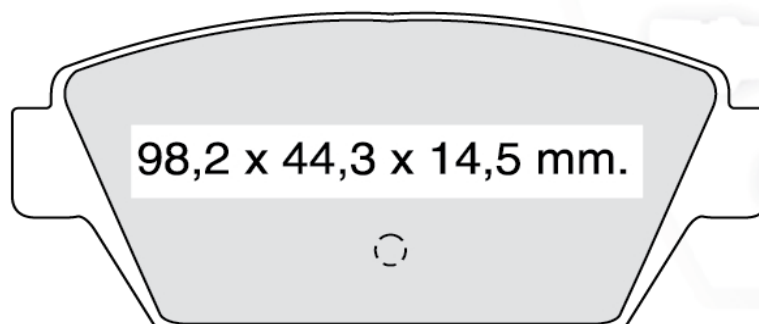

<b>Д401</b>		<b>MITSUBISHI, ISUZU</b>	<b>21125</b>
-------------	--	--------------------------	--------------

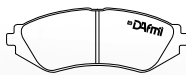
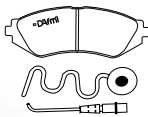

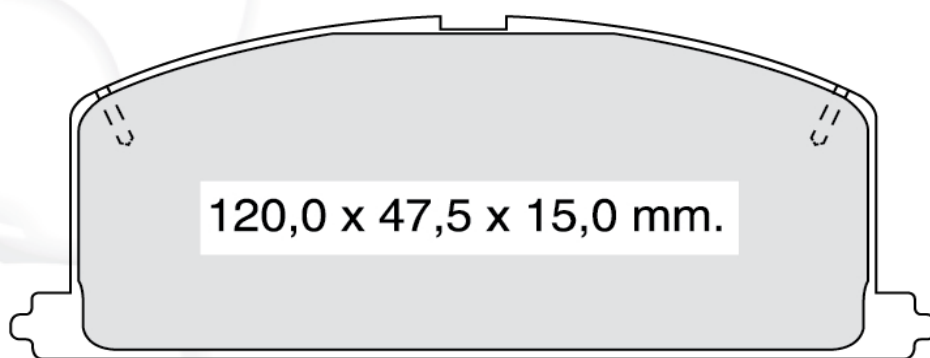

			W.V.A
<b>Д404</b>	<b>Д404И</b>	<b>ТОУОТА</b>	<b>20870</b>

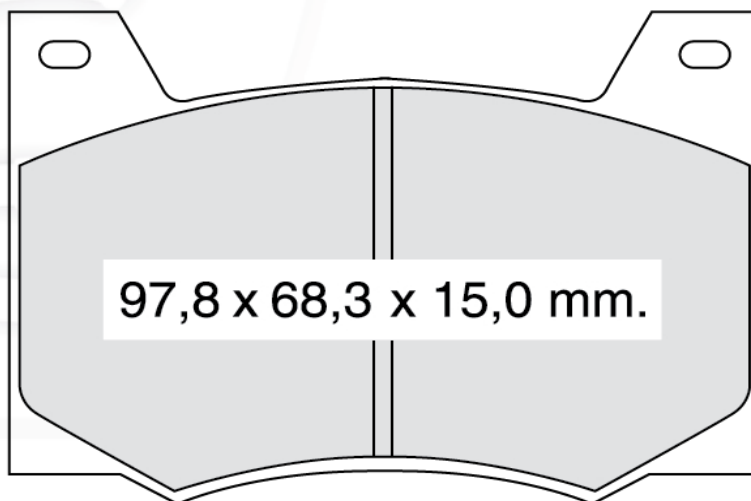

<b>Д412</b>		<b>АЗЛК, ГАЗ</b>	
-------------	--	------------------	--

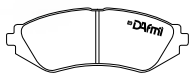
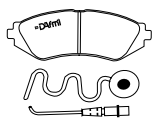

			W.V.A
<b>Д415</b>	<b>Д415И</b>	<b>NISSAN</b>	<b>21099</b>

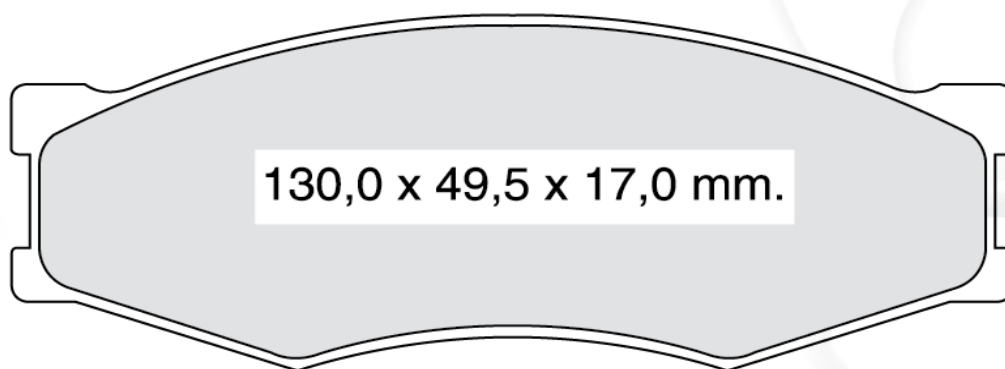

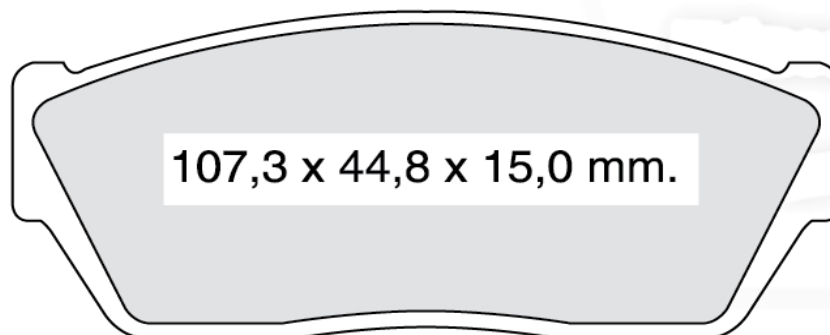

<b>Д421</b>	<b>Д421К</b>	<b>HONDA, ROVER</b>	<b>20895</b>
-------------	--------------	---------------------	--------------

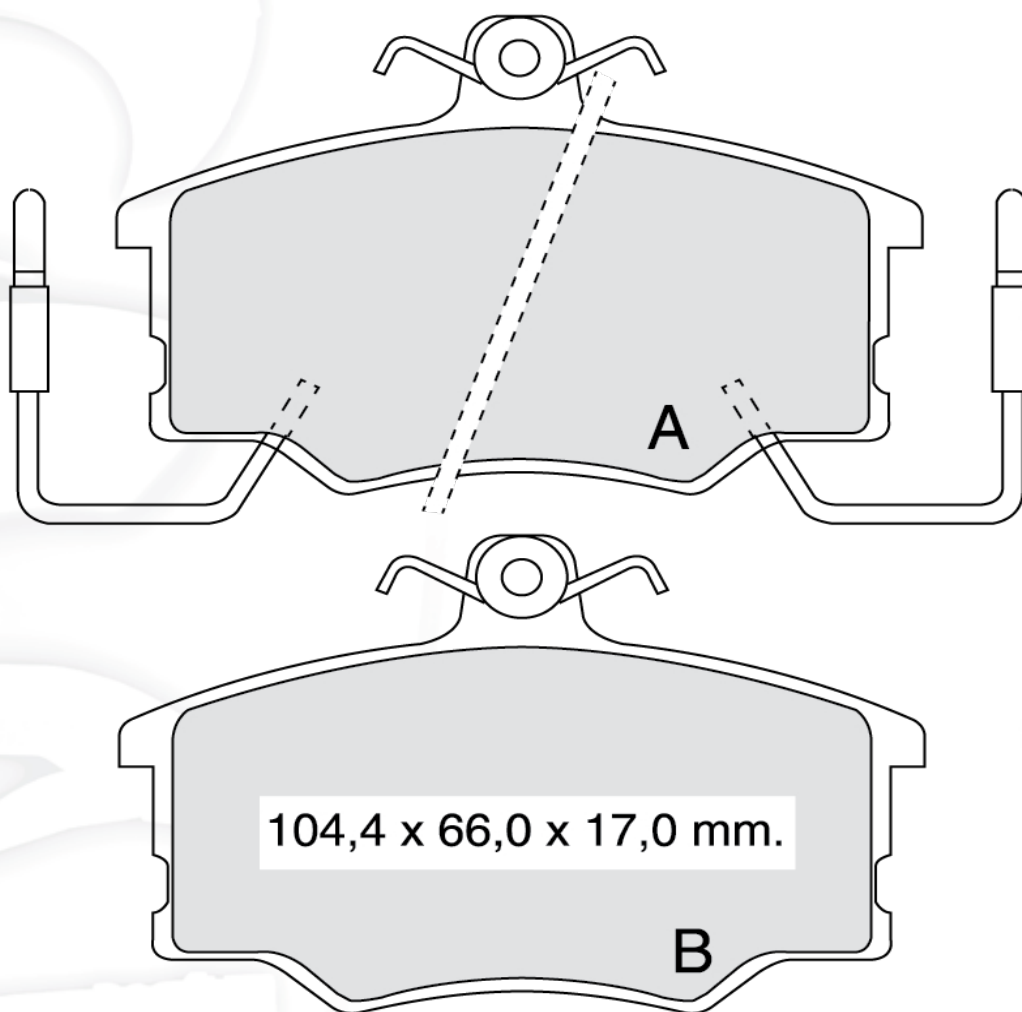

			W.V.A
<b>Д425</b>		<b>FIAT, LANCIA</b>	<b>21093</b>
Индикатор износа входит в базовую комплектацию данной колодки.			

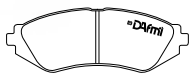
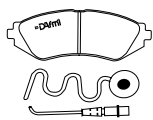

В комплект входят две колодки типа А, две колодки типа В

			W.V.A
<b>Д430</b>		<b>D.A.F., FORD, LAND ROVER</b>	<b>20359</b>

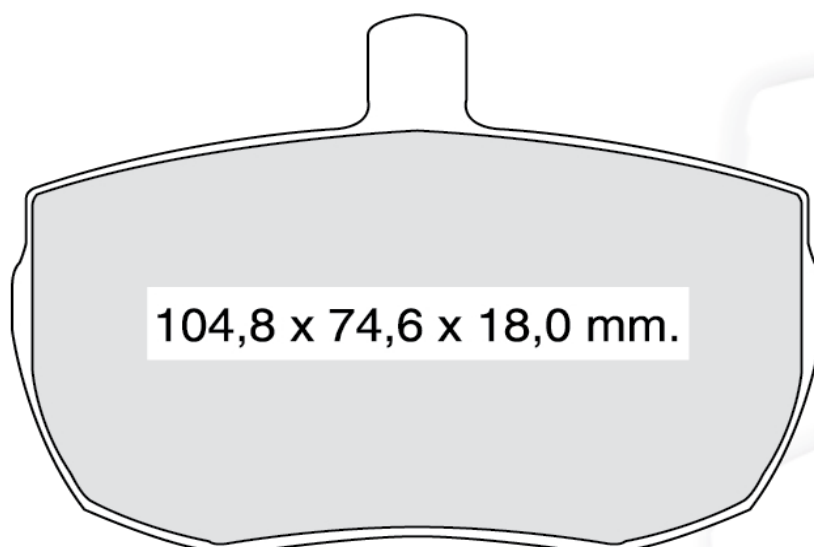



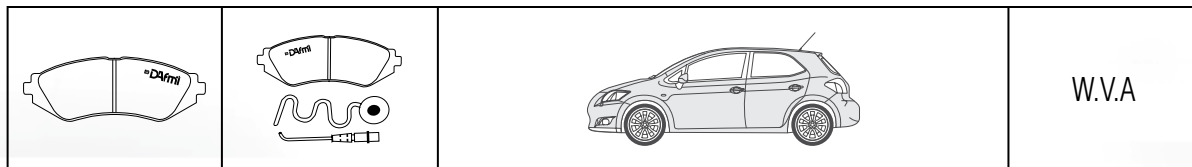

<b>Д433</b>	<b>Д433И</b>	<b>DAEWOO, OPEL</b>	<b>21190</b>
-------------	--------------	---------------------	--------------

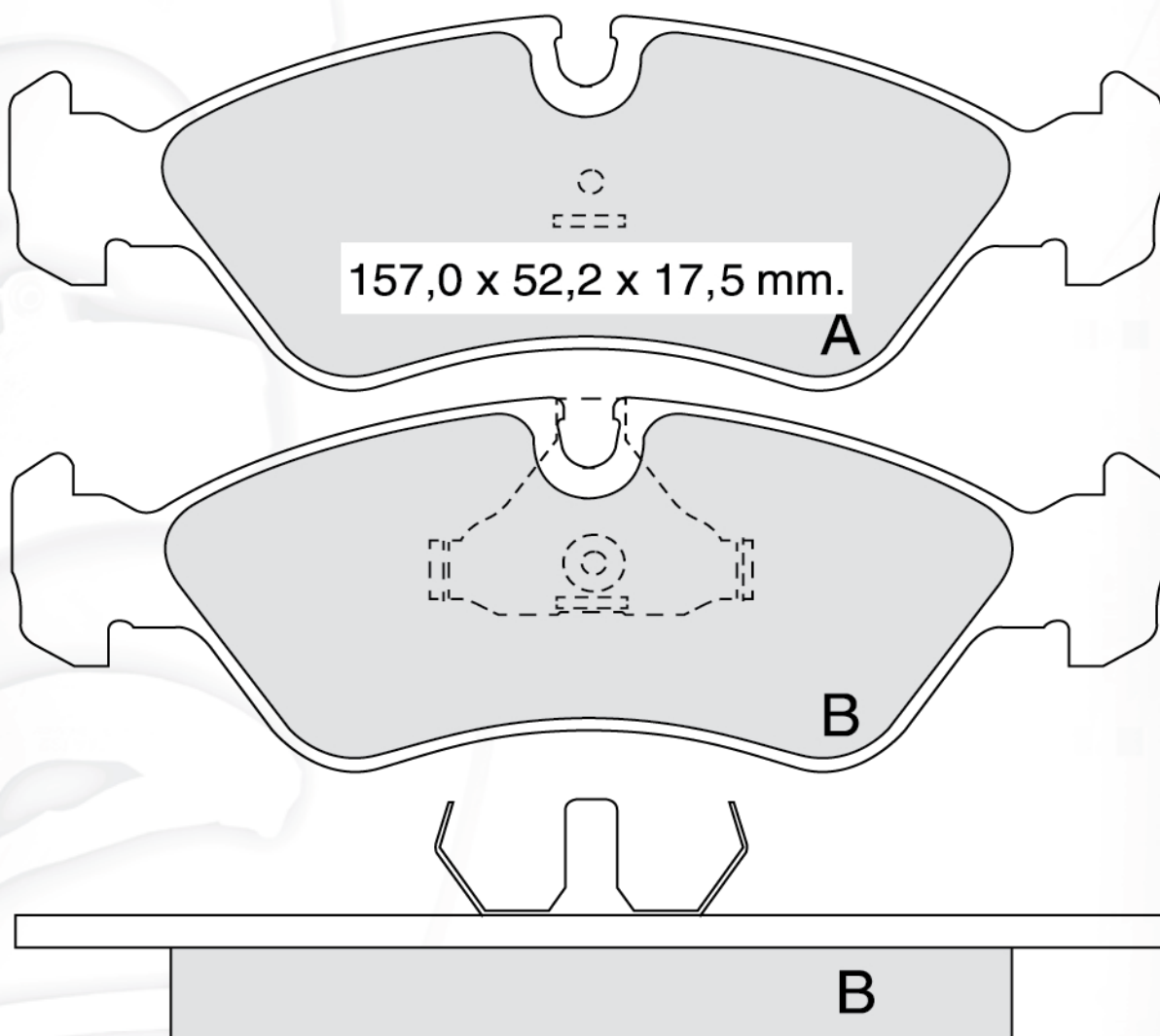

В комплект входят две колодки типа А, две колодки типа В

			W.V.A
<b>Д436</b>		<b>NISSAN, SUZUKI</b>	<b>21344</b>
Индикатор износа входит в базовую комплектацию данной колодки.			

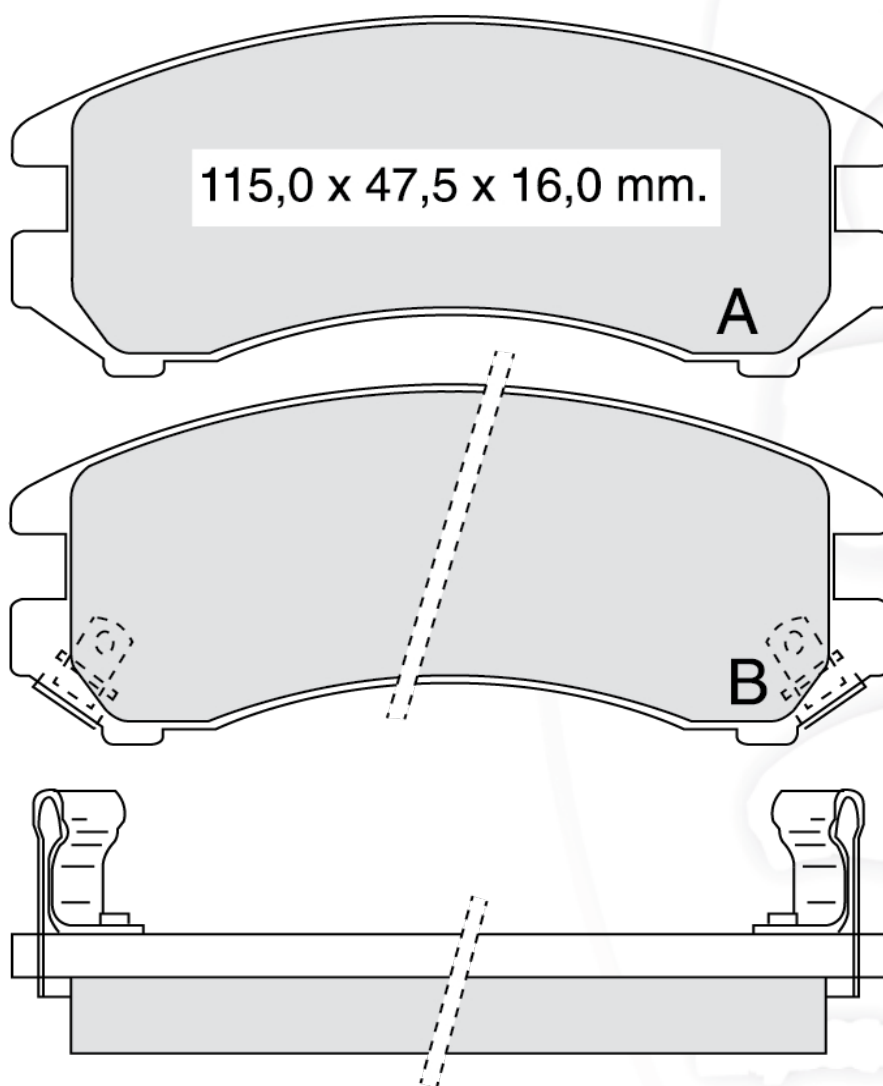

В комплект входят две колодки типа А, две колодки типа В

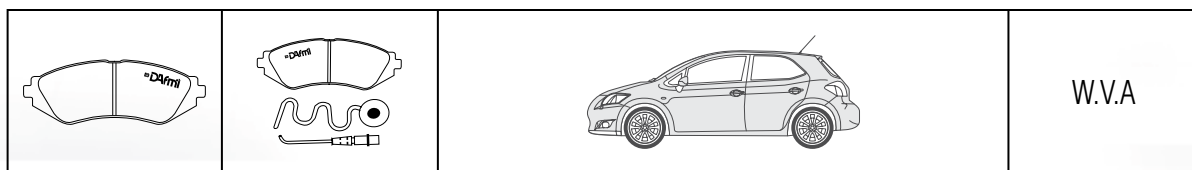

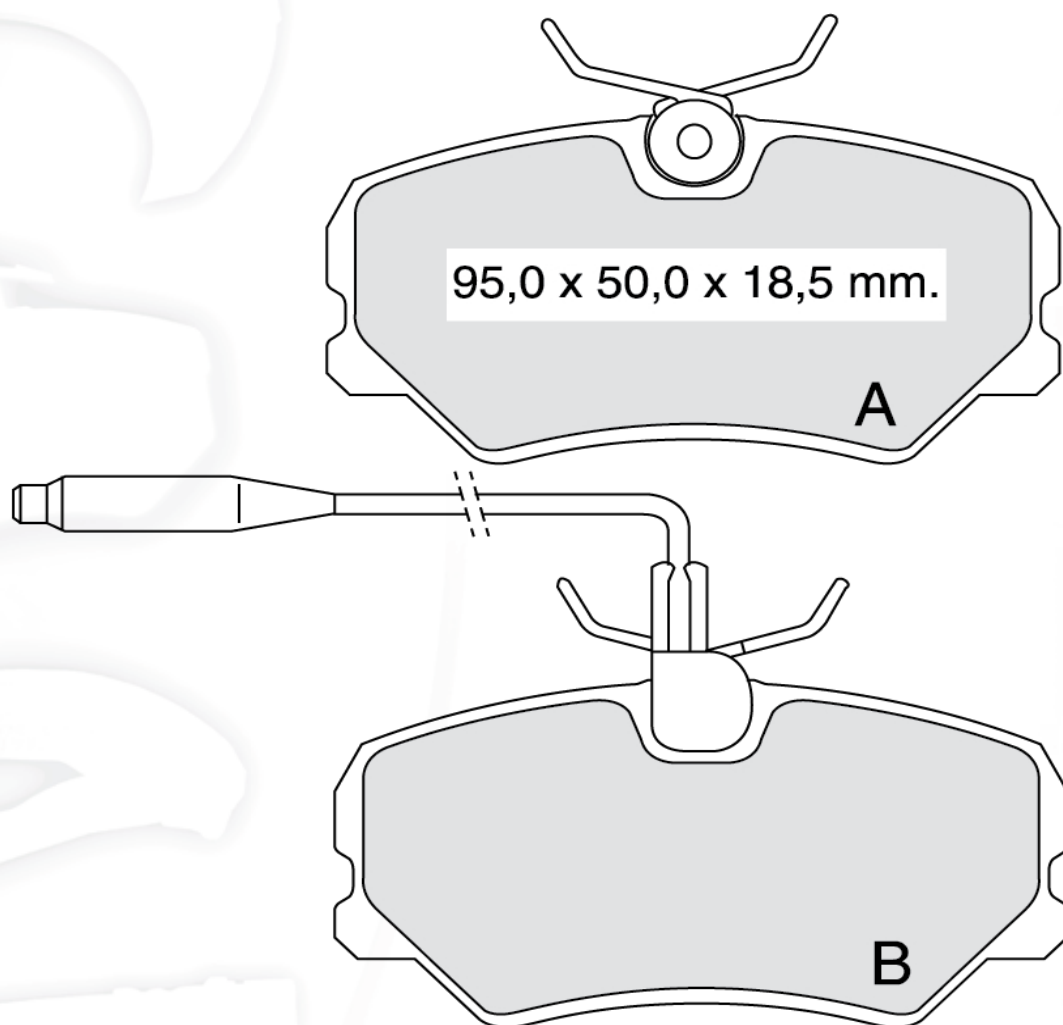

<b>Д439</b>		<b>PEUGEOT</b>	<b>21209</b>
-------------	--	----------------	--------------

Индикатор износа входит в базовую комплектацию данной колодки.

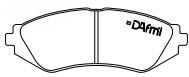
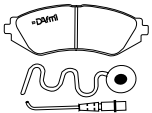

В комплект входят две колодки типа А, две колодки типа В

			W.V.A
<b>Д443</b>	<b>Д443И</b>	<b>ГАЗ</b>	

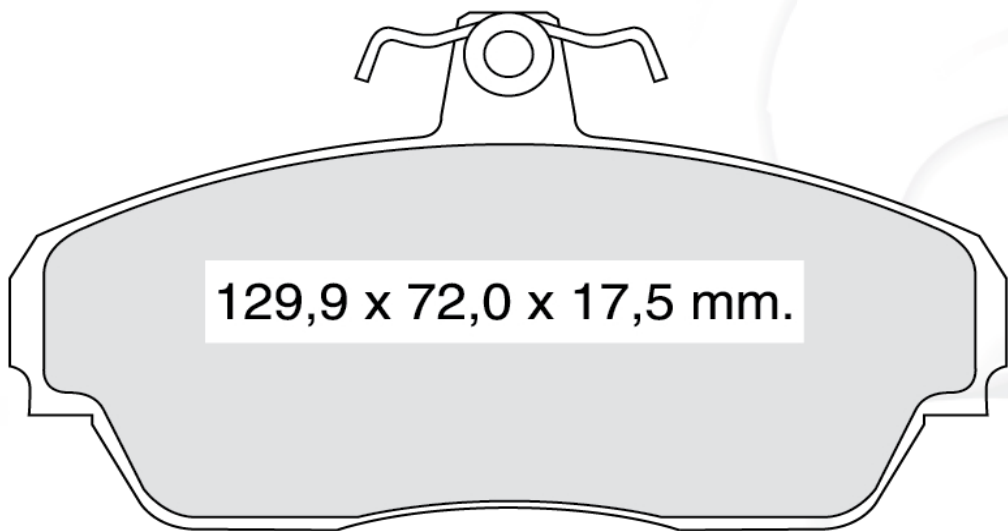

<b>Д445</b>	<b>Д445И</b>	<b>ТОУОТА</b>	<b>21372</b>
-------------	--------------	---------------	--------------

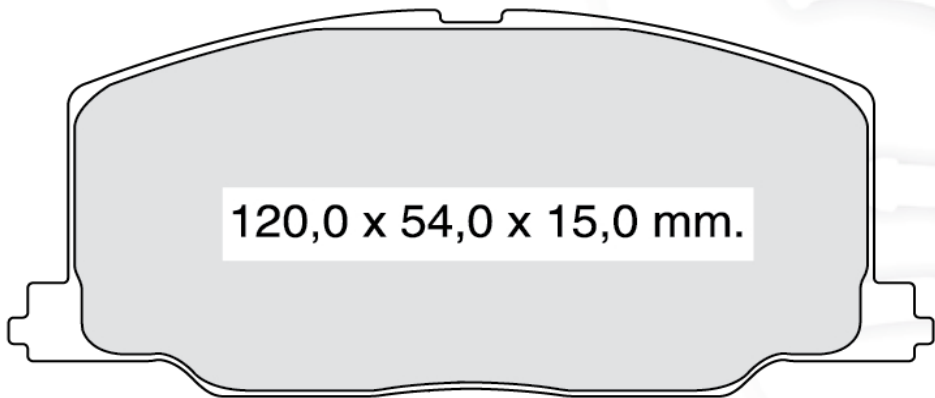

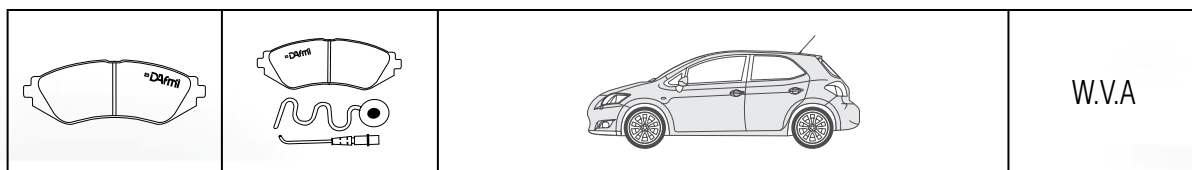

<b>Д446</b>	<b>Д446И</b>	<b>FORD, SKODA</b>	<b>21662</b>
-------------	--------------	--------------------	--------------

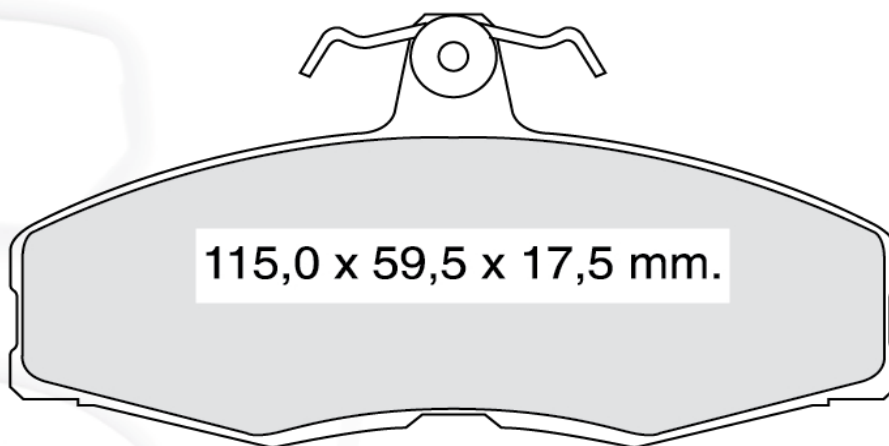



			W.V.A
--	--	--	-------

<b>Д450</b>		<b>FORD, MAZDA</b>	<b>21378</b>
-------------	--	--------------------	--------------

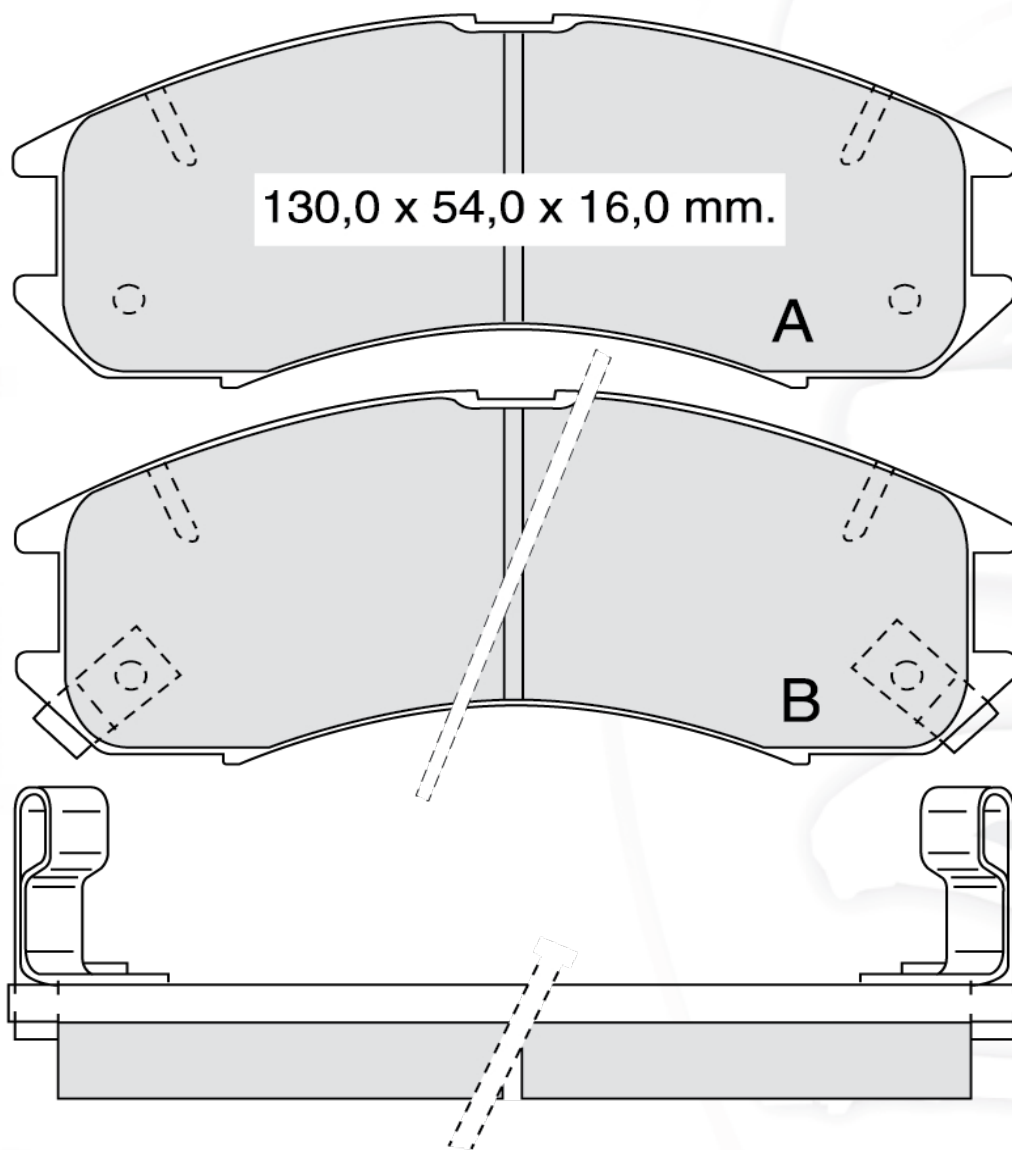
Индикатор износа входит в базовую комплектацию данной колодки.

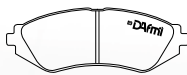
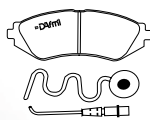

В комплект входят две колодки типа А, две колодки типа В

			W.V.A
<b>Д459</b>		<b>ОPEL, SAAB</b>	<b>21140</b>

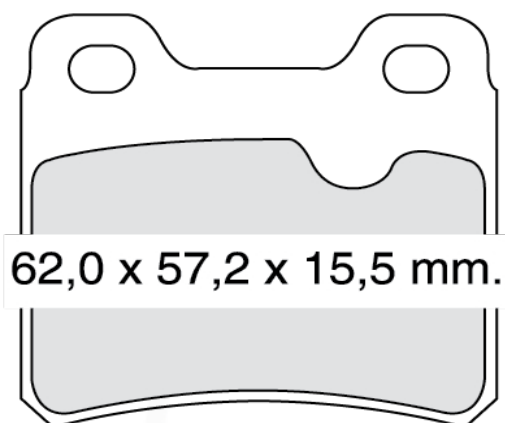

			W.V.A
<b>Д475</b>		<b>HONDA</b>	<b>21351</b>
Индикатор износа входит в базовую комплектацию данной колодки.			

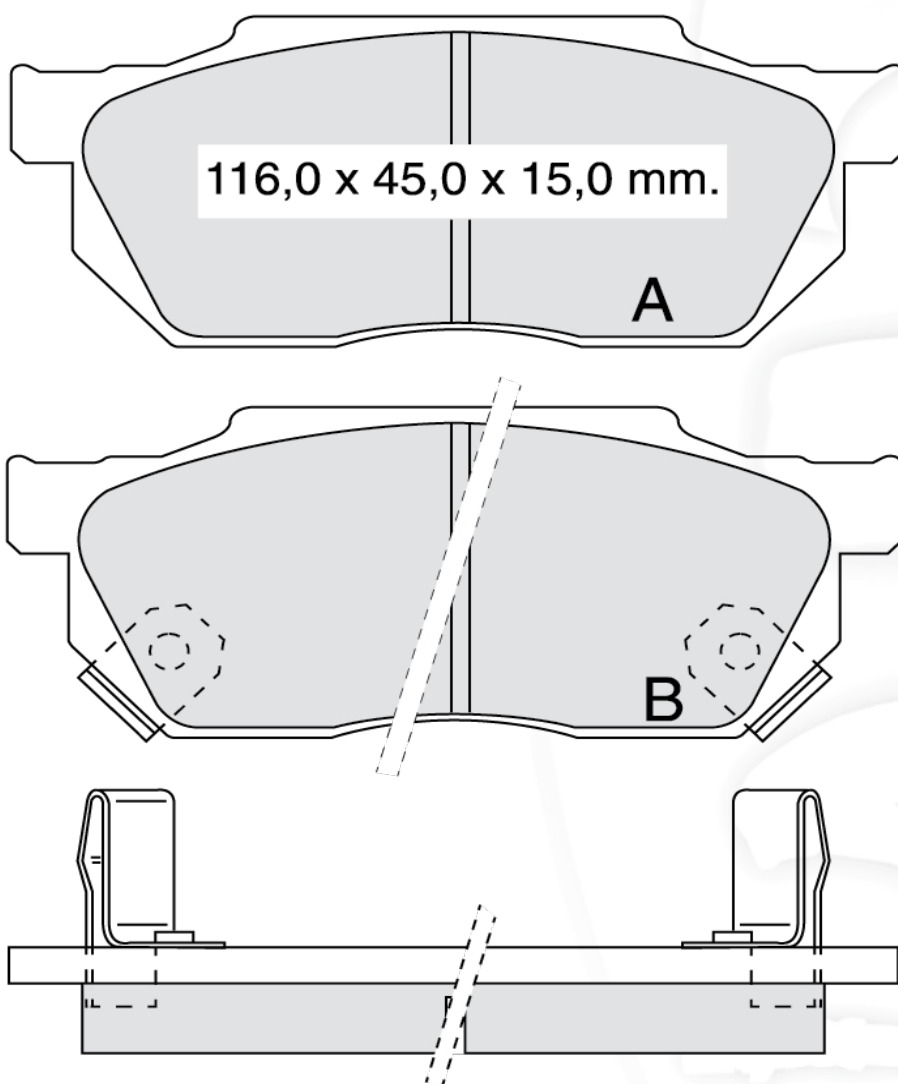

В комплект входят две колодки типа А, две колодки типа В



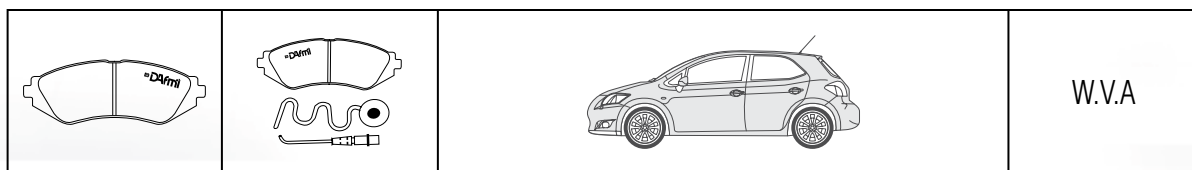

<b>Д478</b>		<b>RENAULT</b>	<b>20919</b>
-------------	--	----------------	--------------

Индикатор износа входит в базовую комплектацию данной колодки.

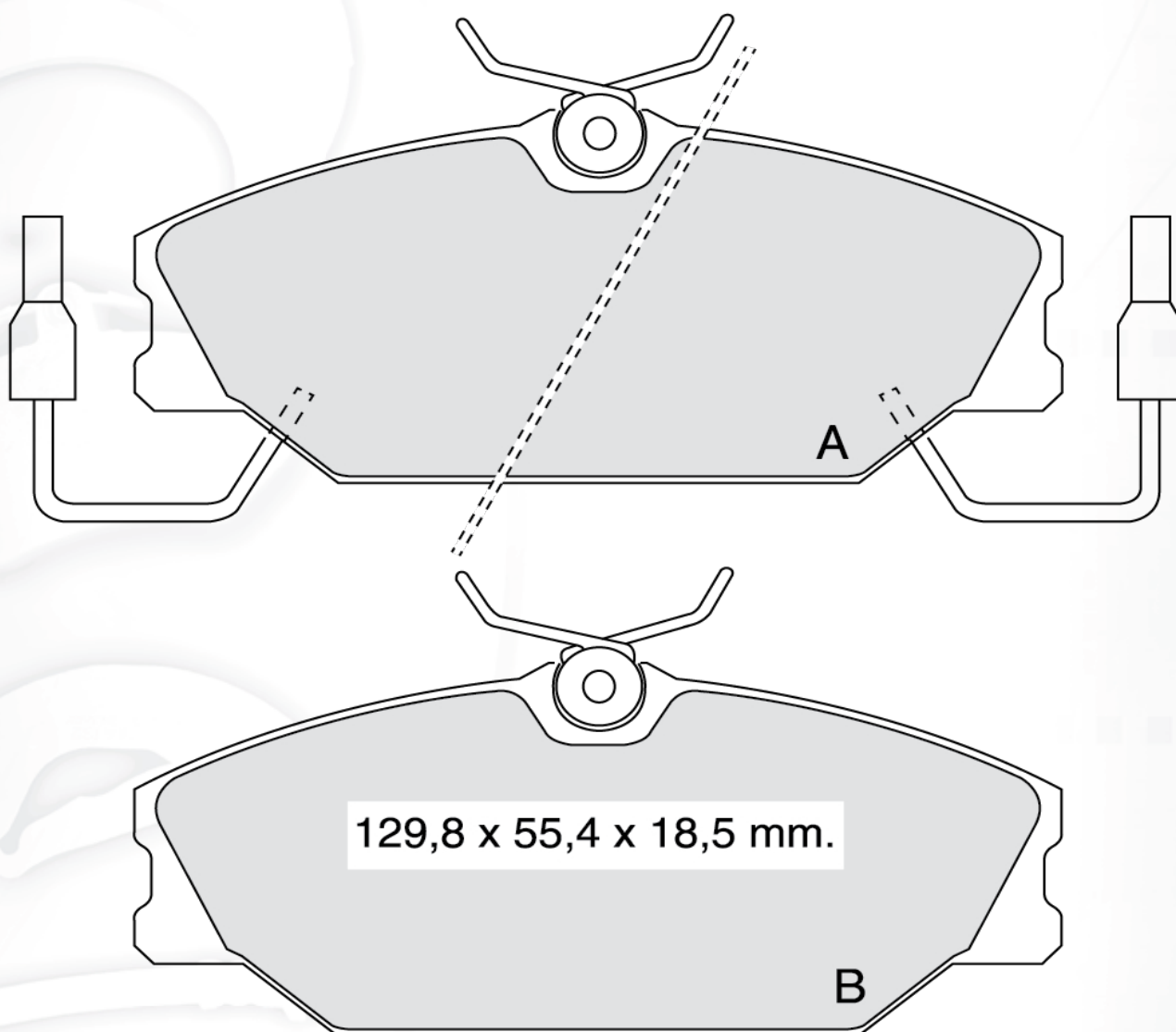

В комплект входят две колодки типа А, две колодки типа В

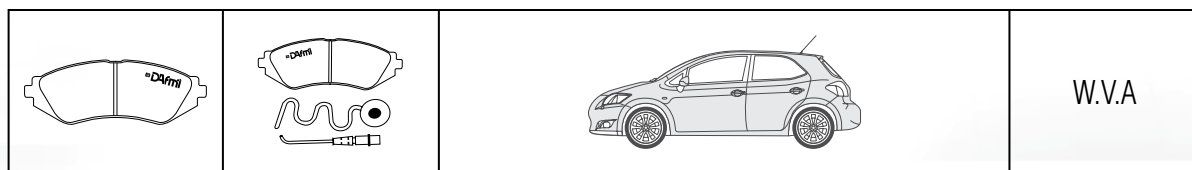

<b>Д481</b>	<b>AUDI, PEUGEOT, SEAT, VOLKSWAGEN</b>	<b>21664</b>
-------------	--	--------------

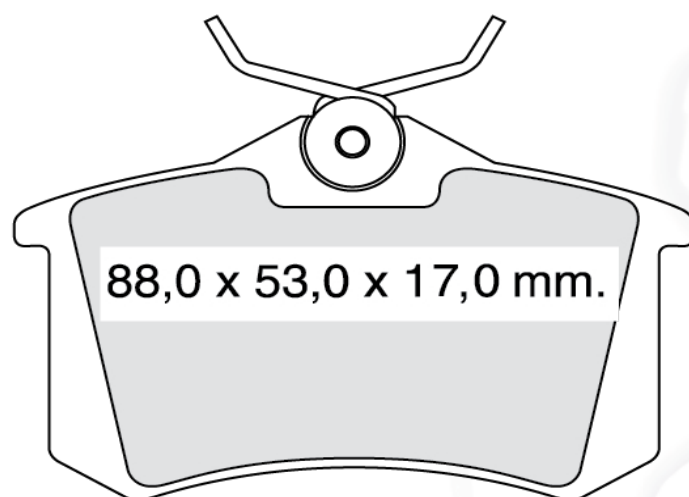

			W.V.A
--	--	--	-------

<b>Д482</b>		<b>FIAT, LANCIA</b>	<b>21100</b>
-------------	--	---------------------	--------------

Индикатор износа входит в базовую комплектацию данной колодки.

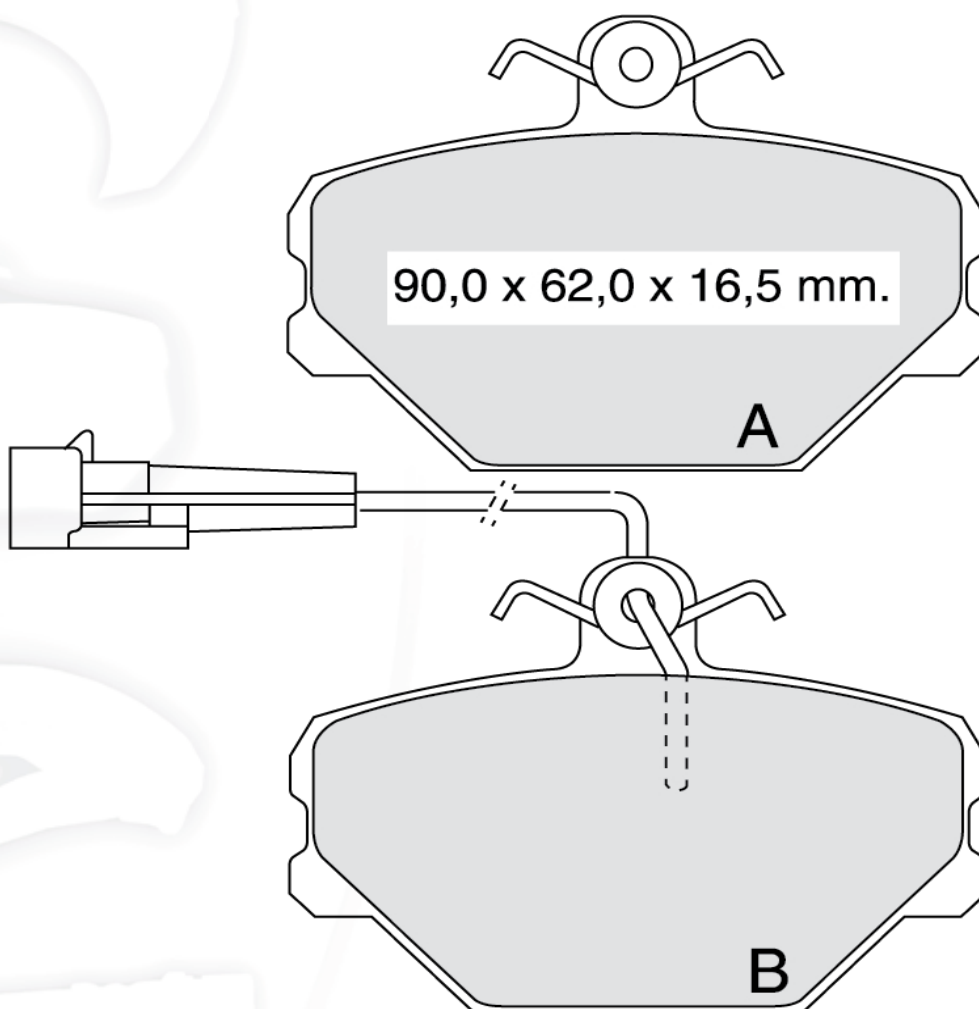

В комплект входят две колодки типа А, две колодки типа В

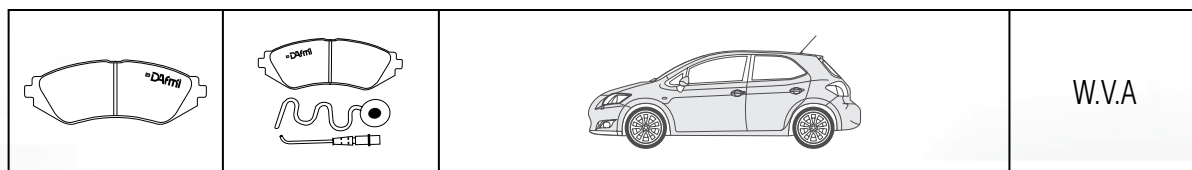

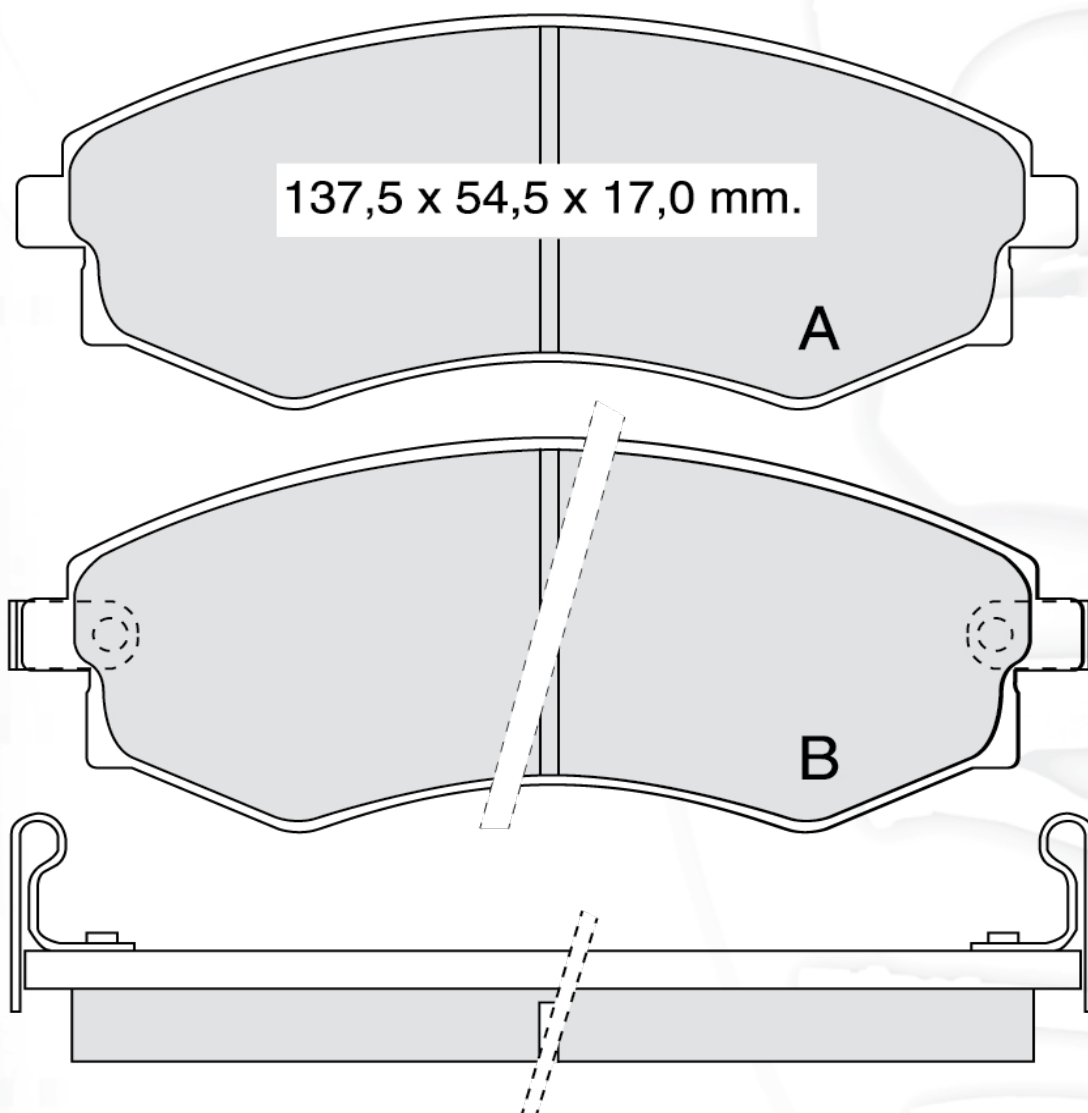

<b>Д487</b>		<b>HYUNDAI, NISSAN</b>	<b>21725</b>
-------------	--	------------------------	--------------

Индикатор износа входит в базовую комплектацию данной колодки

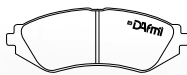
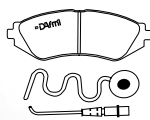

В комплект входят две колодки типа А, две колодки типа В

			W.V.A
---	---	--	-------

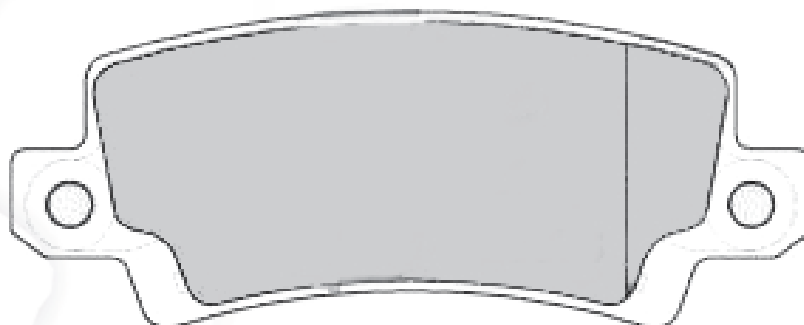
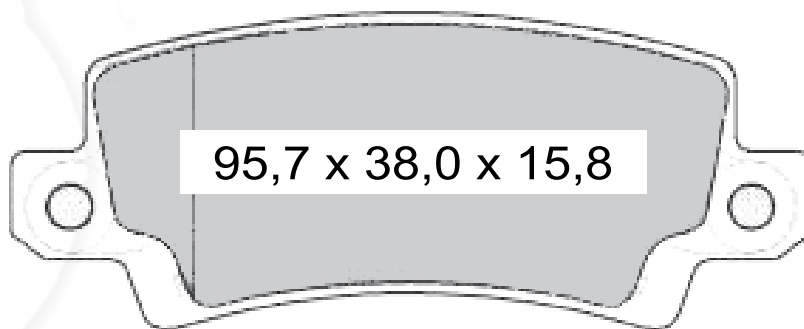

<b>Д489</b>	<b>Д489И</b>	<b>ТОУОТА</b>	
-------------	--------------	---------------	--

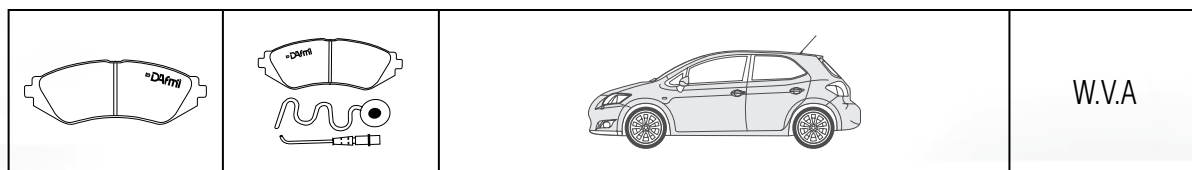

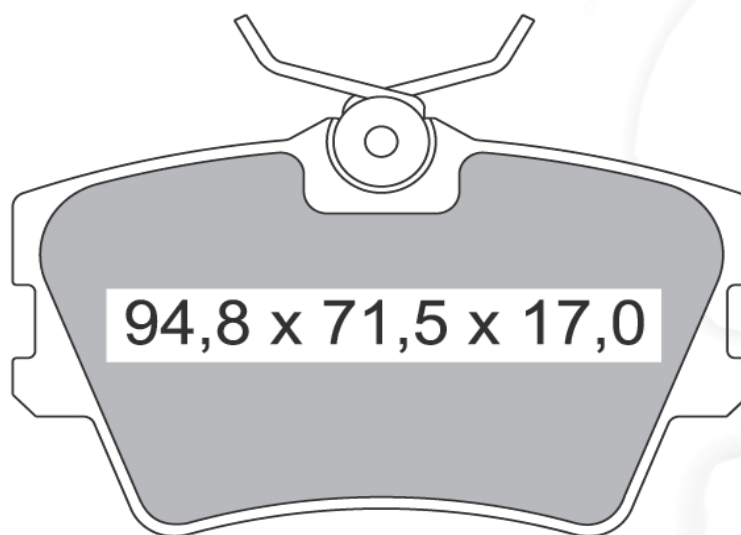

<b>Д492</b>	<b>Д492И</b>	<b>VOLKSWAGEN</b>	-
-------------	--------------	-------------------	---

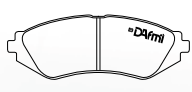
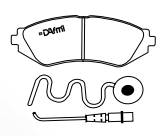

			W.V.A
---	---	--	-------

<b>Д494</b>	<b>Д494И</b>	<b>BMW</b>	<b>20968</b>
-------------	--------------	------------	--------------

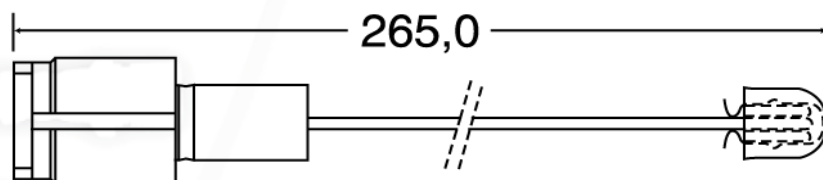
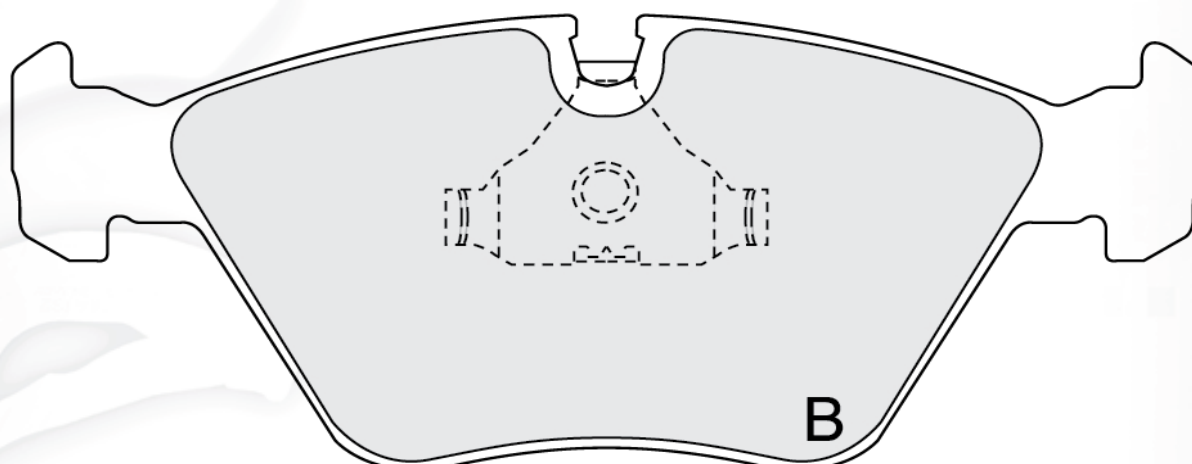
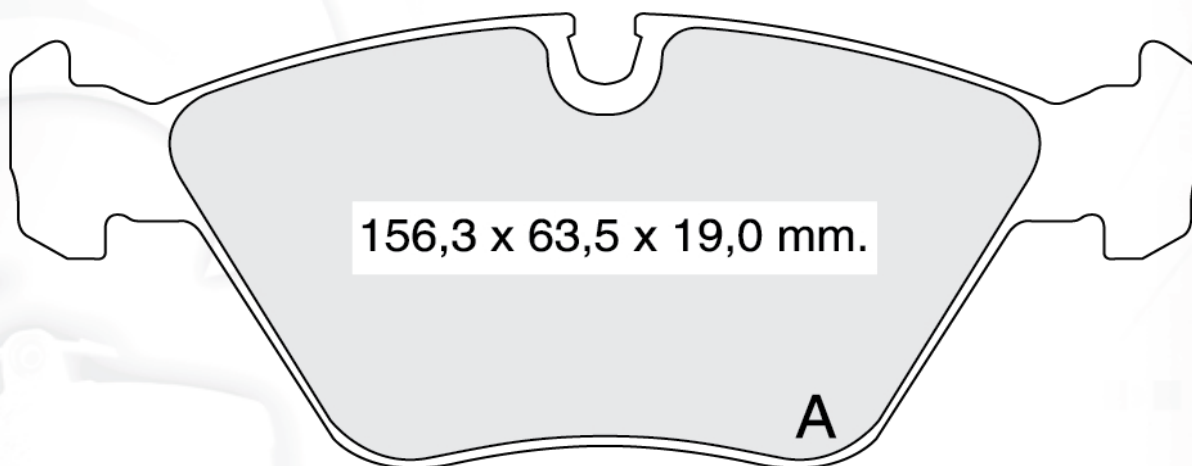

В комплект входят две колодки типа А, две колодки типа В

			W.V.A
--	--	--	-------

<b>Д495</b>		<b>TOYOTA, CHERY</b>	
-------------	--	----------------------	--

Индикатор износа входит в базовую комплектацию данной колодки

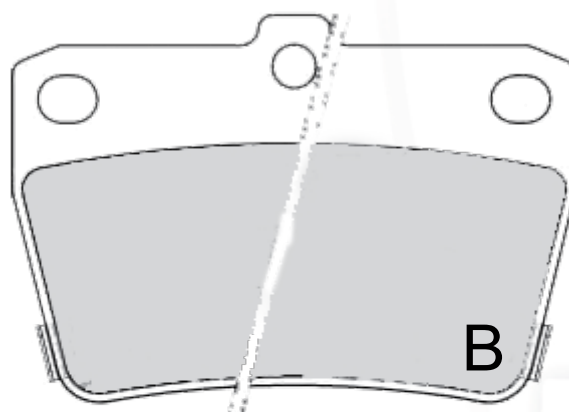
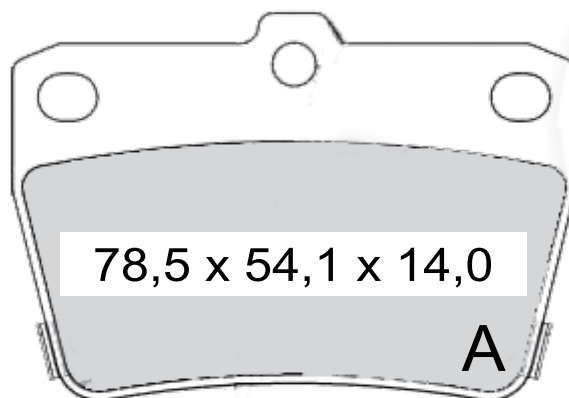

В комплект входят две колодки типа А, две колодки типа В



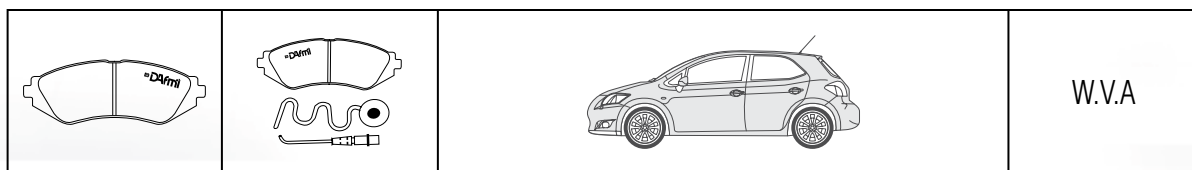

<b>Д497</b>		<b>NISSAN</b>	<b>21725</b>
-------------	--	---------------	--------------

Индикатор износа входит в базовую комплектацию данной колодки

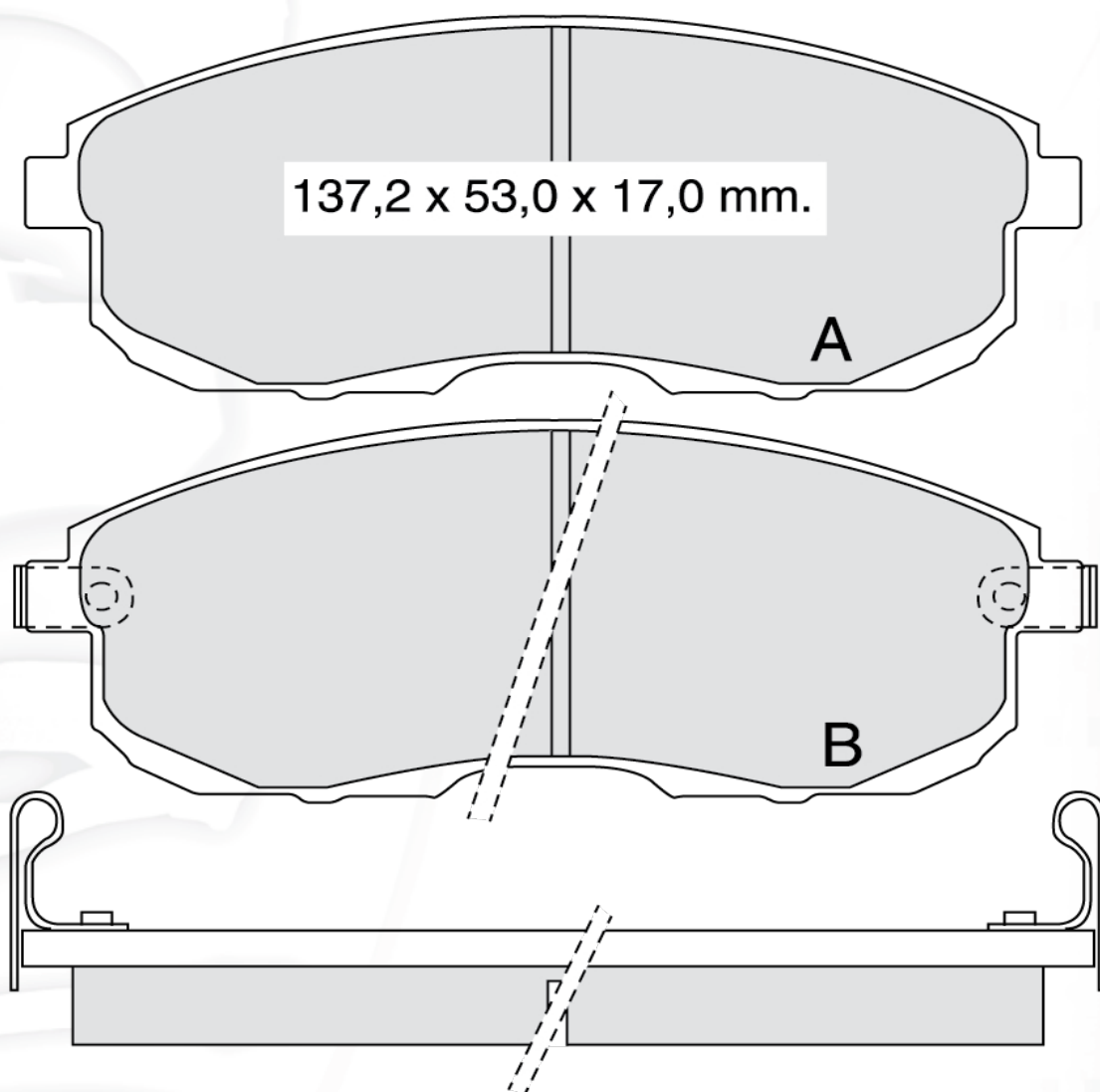

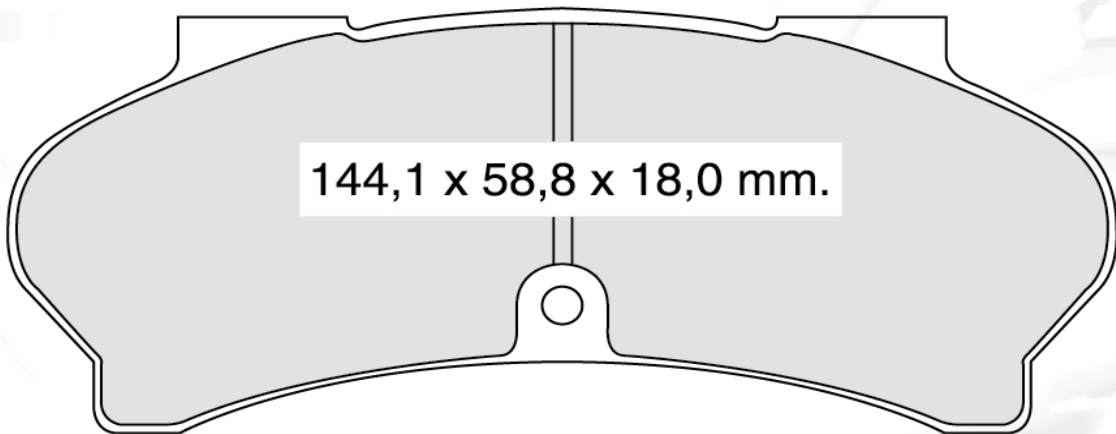

В комплект входят две колодки типа А, две колодки типа В

			W.V.A
<b>Д499</b>		<b>PEUGEOT</b>	<b>20366</b>

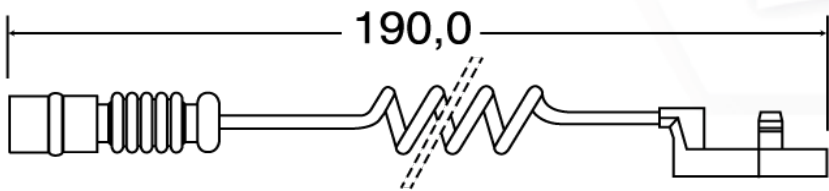
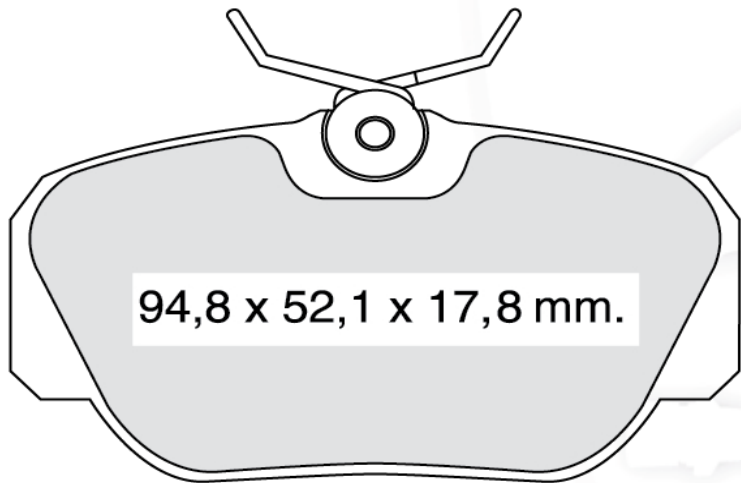

<b>Д501</b>	<b>Д501И</b>	<b>MERCEDES-BENZ</b>	<b>21055</b>
-------------	--------------	----------------------	--------------

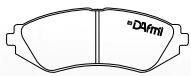
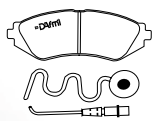

			W.V.A
<b>Д503</b>		<b>GREAT WALL</b>	24370 24594

Индикатор износа входит в базовую комплектацию данной колодки

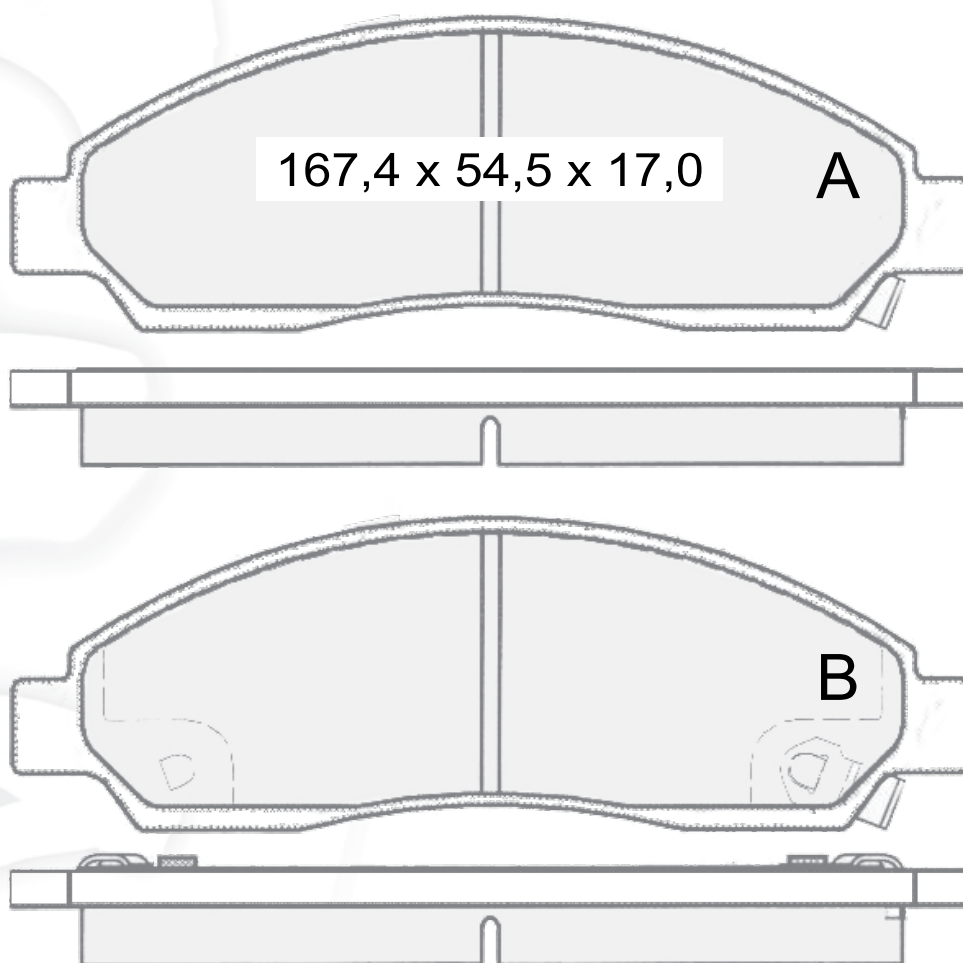



В комплект входят две колодки типа А, две колодки типа В

			W.V.A
<b>Д505</b>		<b>GREAT WALL</b>	21875

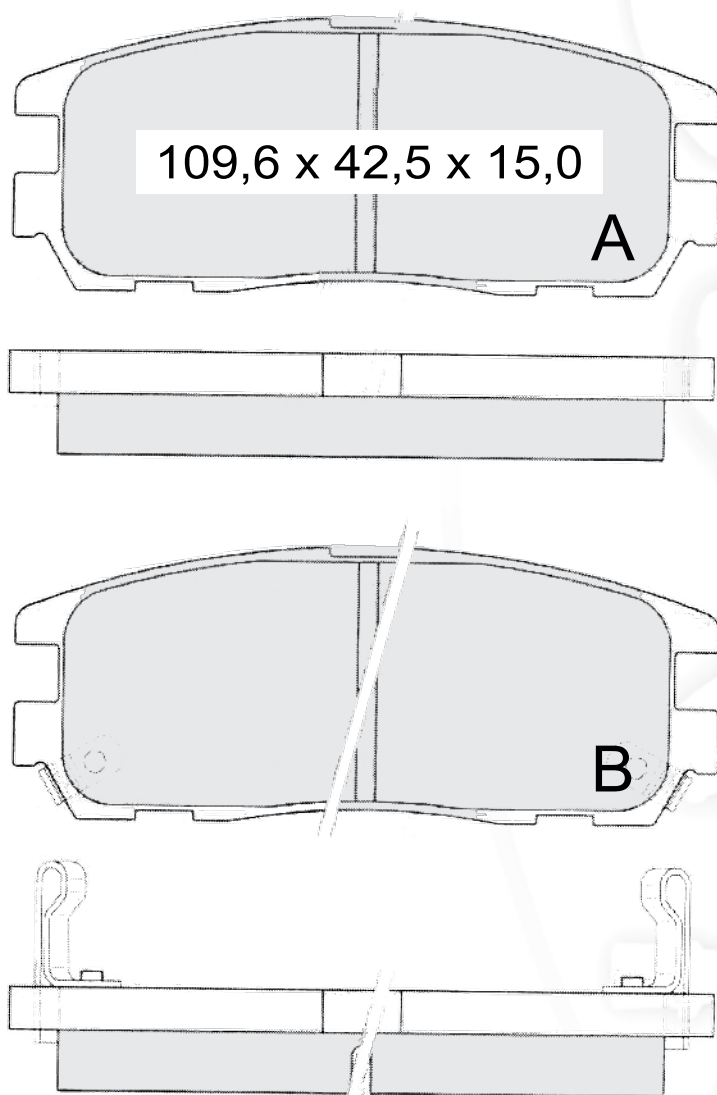
Индикатор износа входит в базовую комплектацию данной колодки

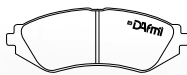
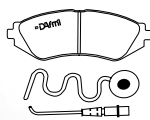

В комплект входят две колодки типа А, две колодки типа В

			W.V.A
---	---	--	-------

<b>Д507</b>	<b>Д507И</b>	<b>МITSUBISHI</b>	21796
-------------	--------------	-------------------	-------

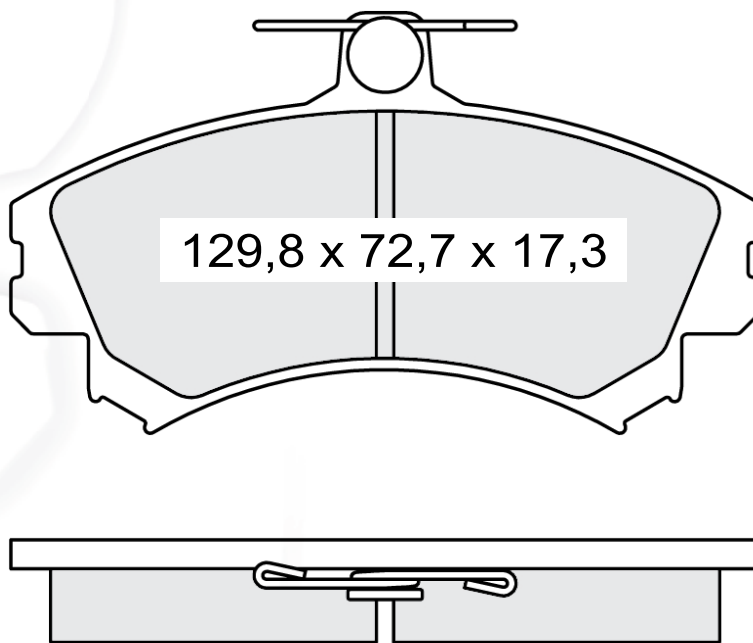

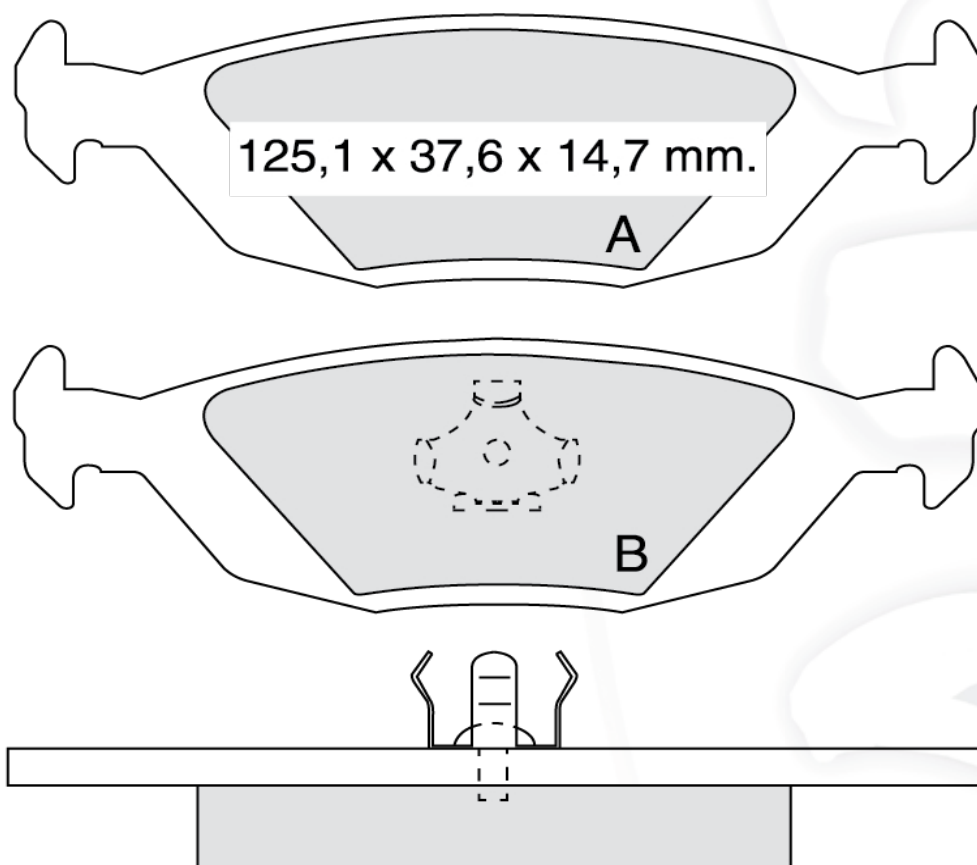

			W.V.A
<b>Д511</b>		<b>SAAB, VOLVO</b>	<b>21089</b>



В комплект входят две колодки типа А, две колодки типа В

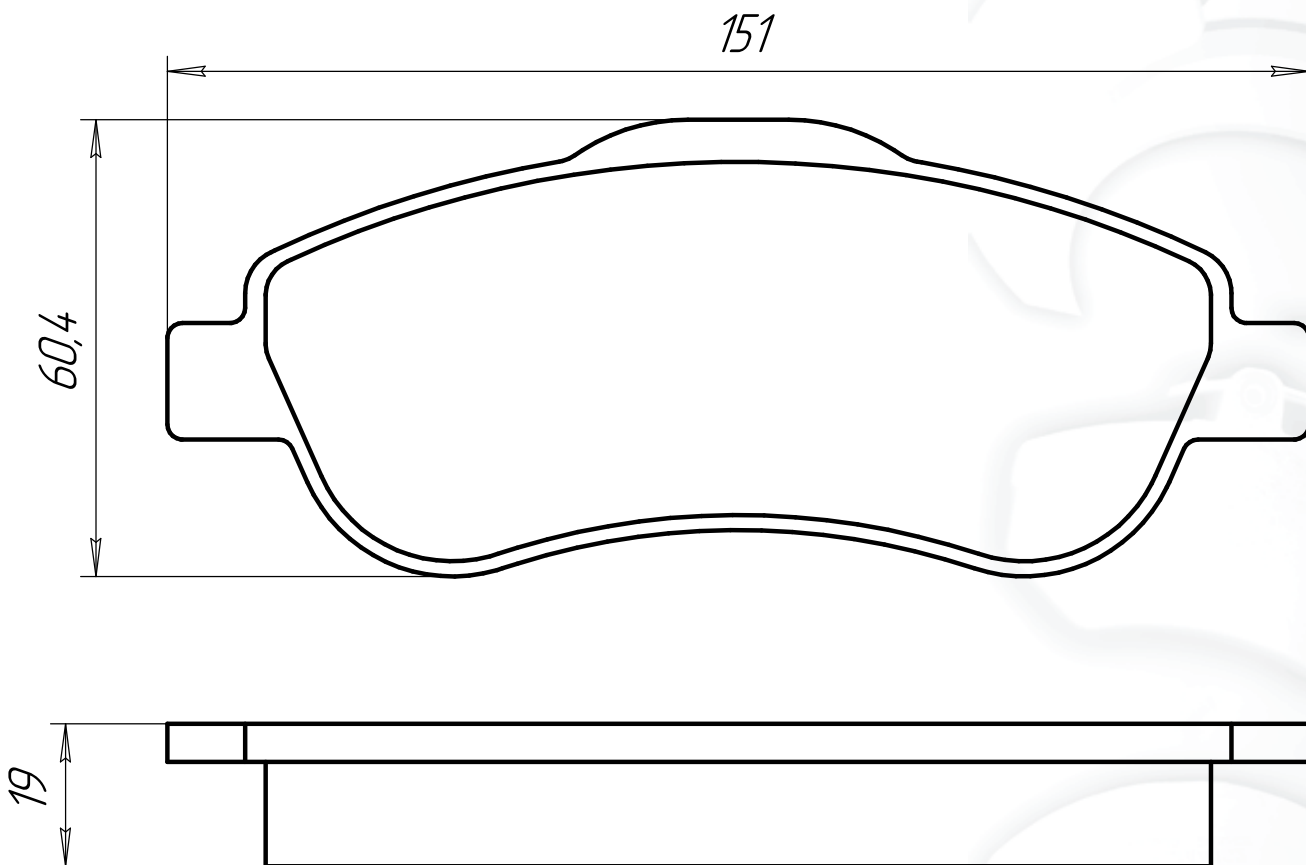

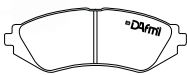
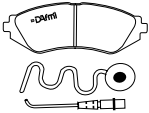
			W.V.A
512		HONDA	



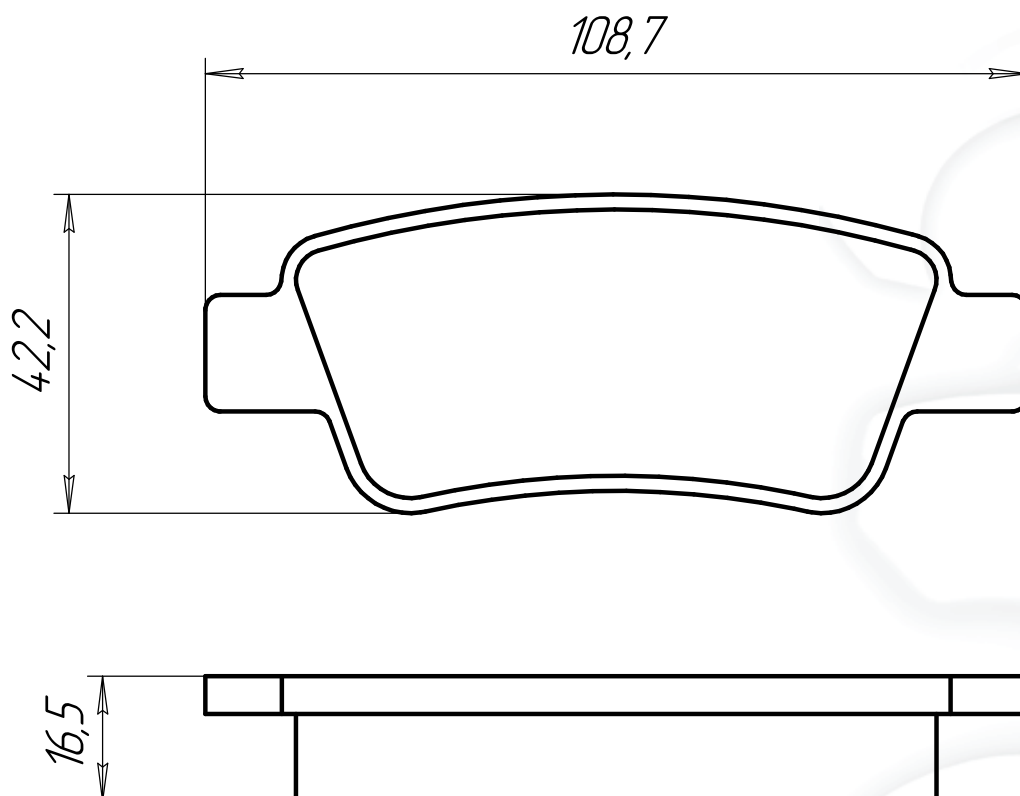

			<p>W.V.A</p>
<p>513</p>		<p>HONDA</p>	

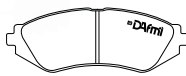
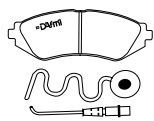

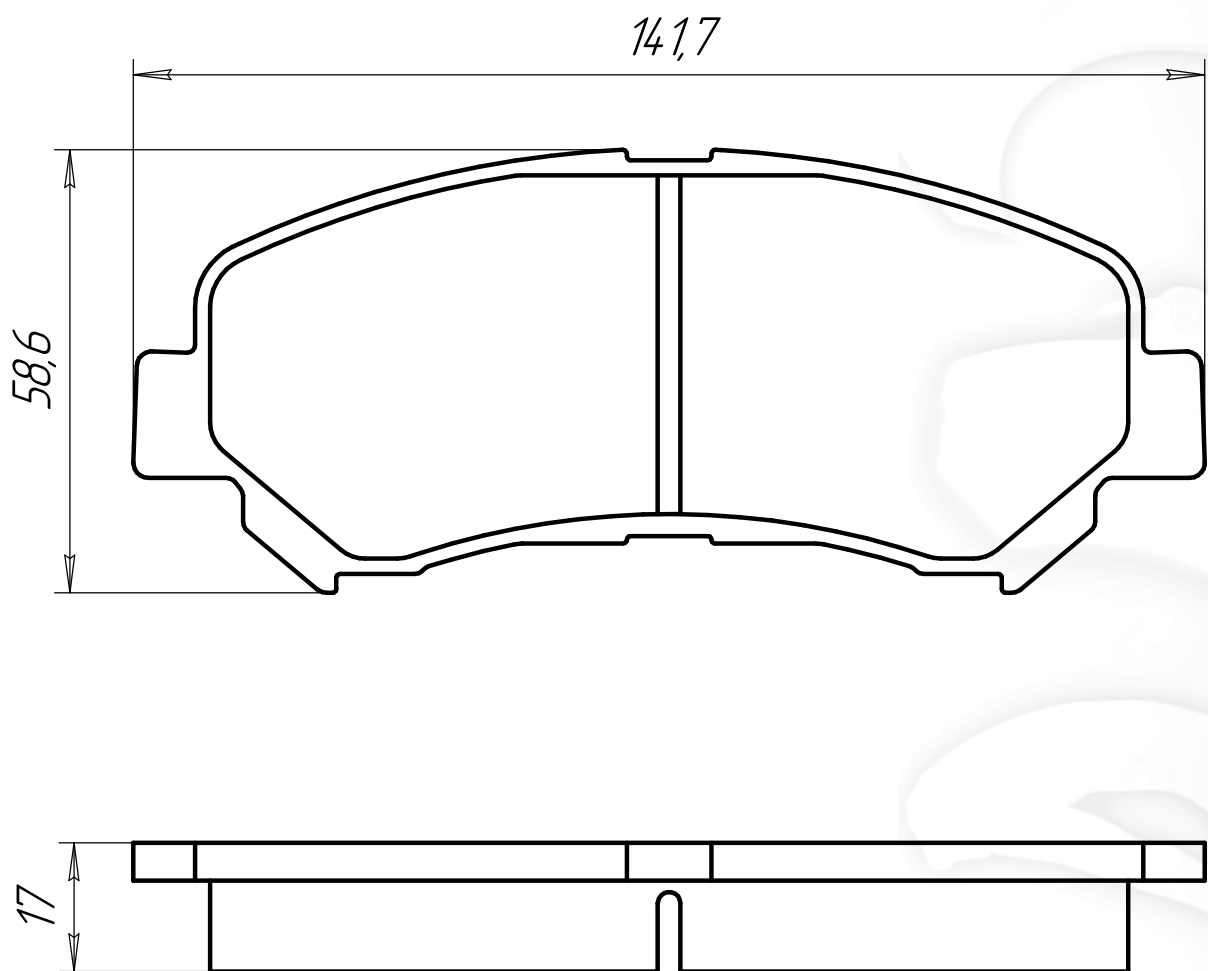

			<p>W.V.A</p>
<p>514</p>		<p>NISSAN, RENAULT</p>	

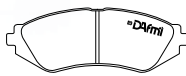
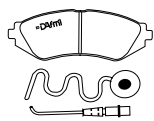

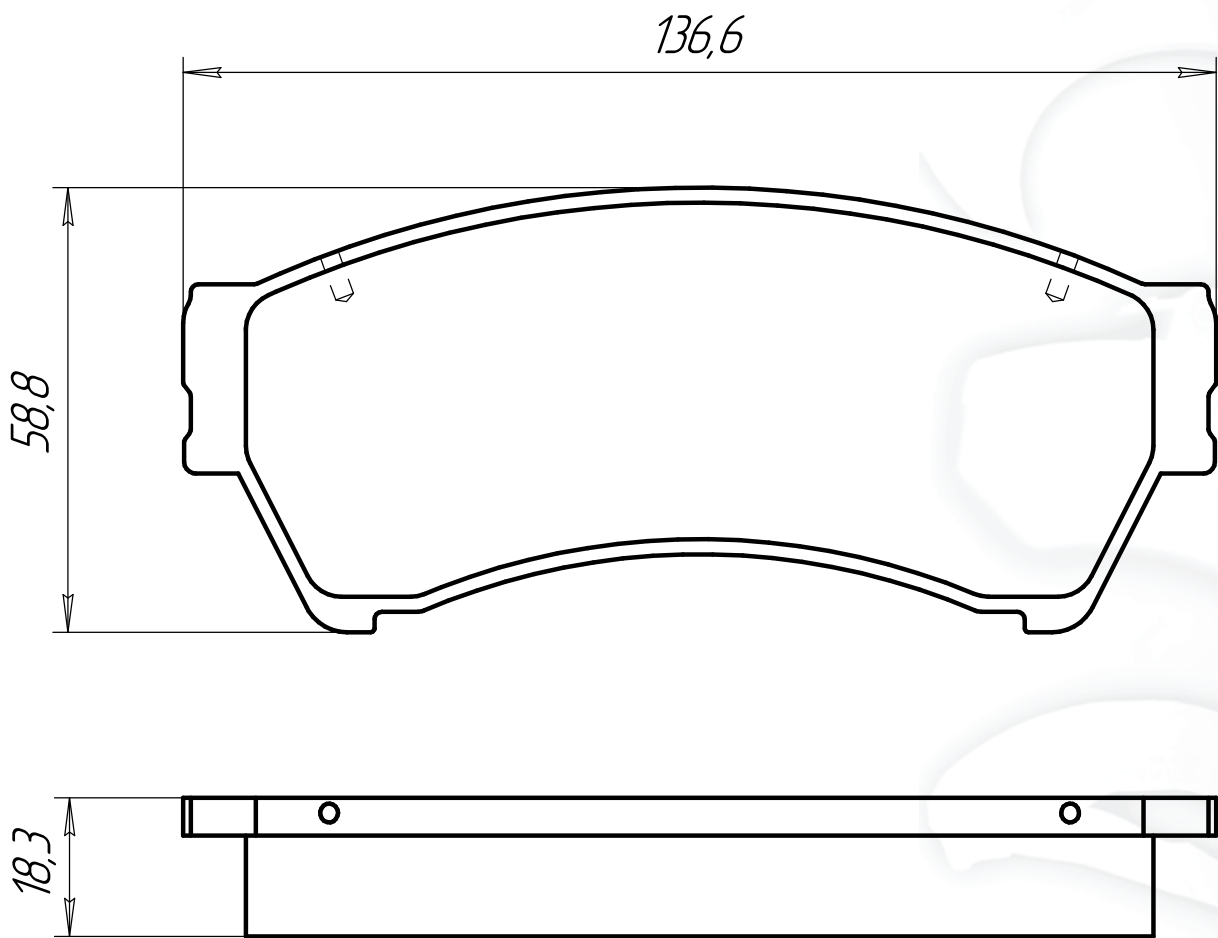

			<p>W.V.A</p>
<p>515</p>		<p>MAZDA</p>	

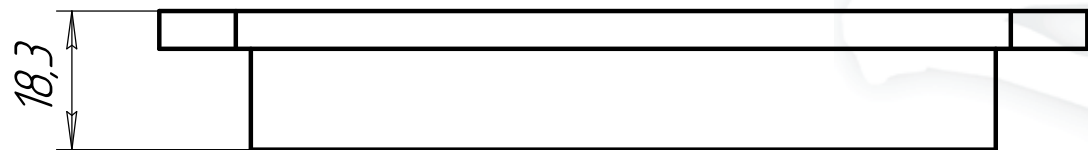
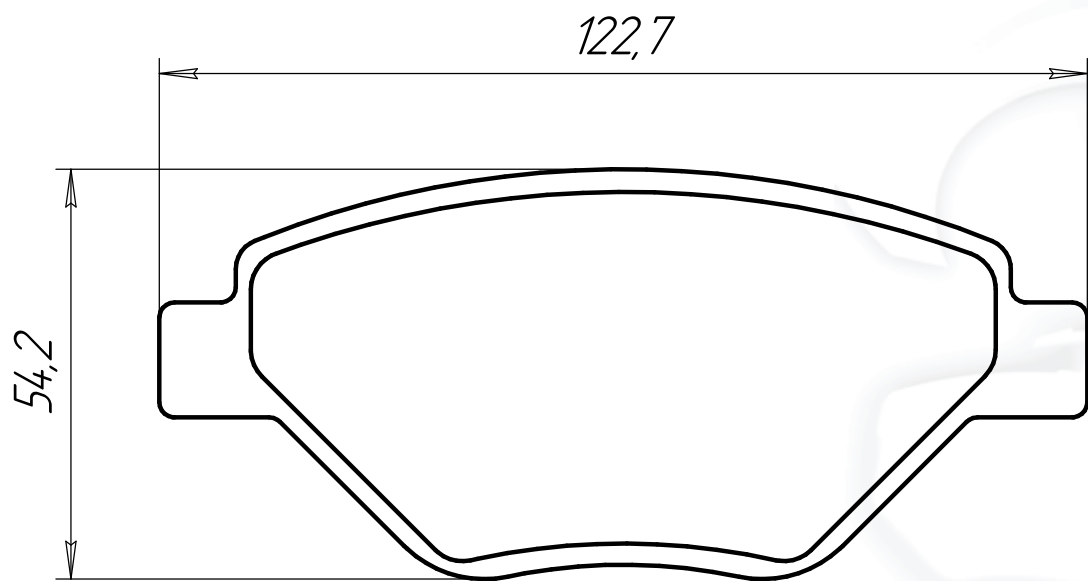

			W.V.A
516		RENAULT	

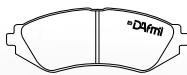
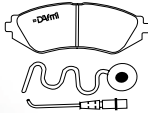



			W.V.A
---	---	--	-------

<b>Д530</b>		<b>CITRIEN, FIAT, PEUGEOT</b>	<b>20741</b>
-------------	--	-------------------------------	--------------

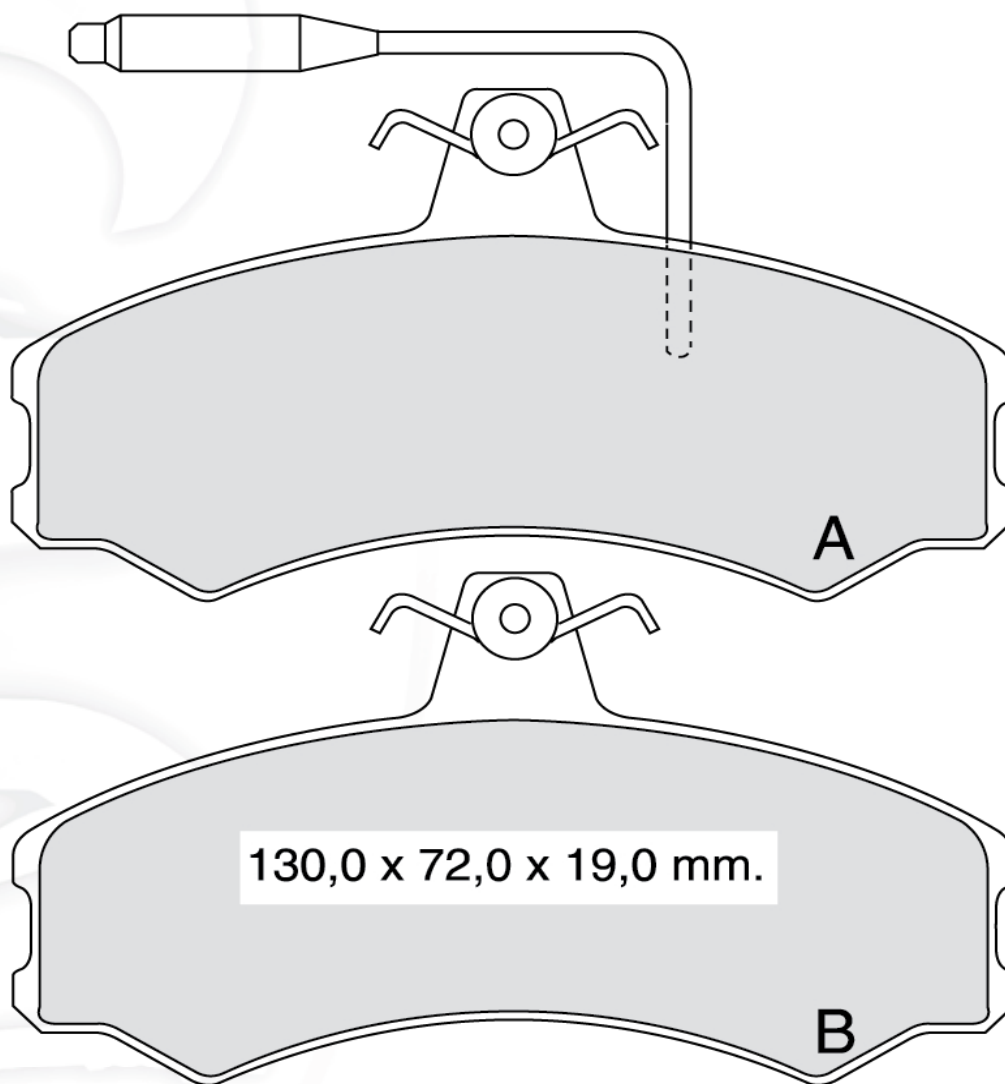
Индикатор износа входит в базовую комплектацию данной колодки.

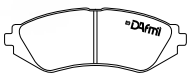
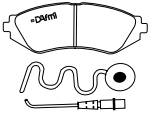

В комплект входят две колодки типа А, две колодки типа В

			W.V.A
<b>Д531</b>		<b>ЗИЛ</b>	

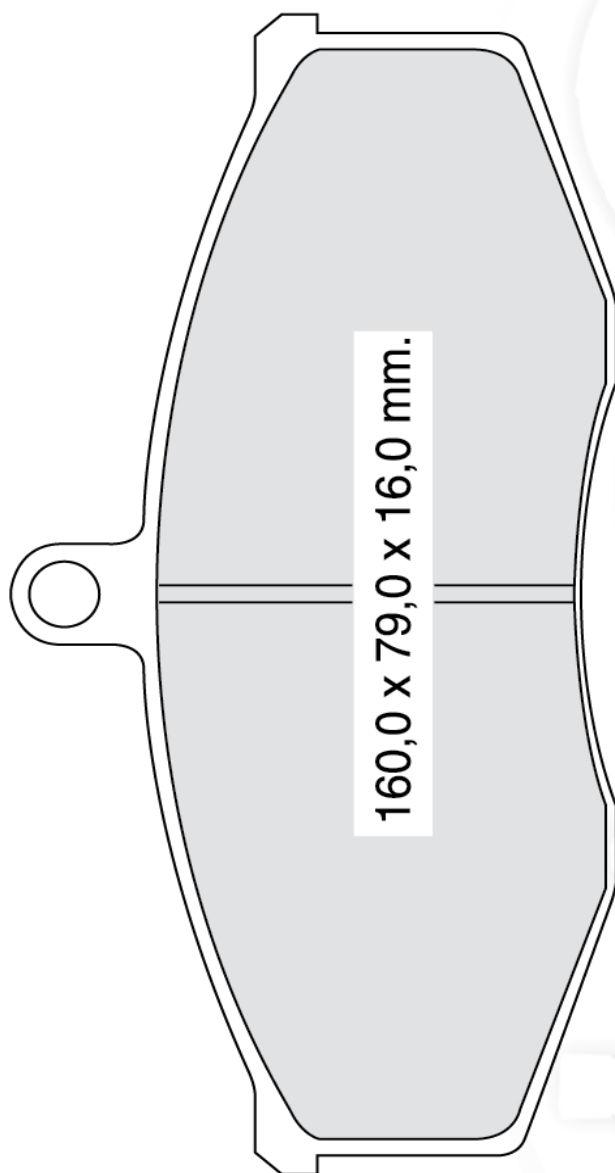

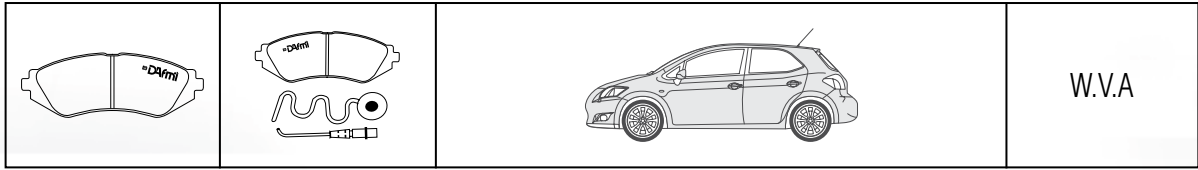

<b>Д548</b>		<b>MERCEDES-BENZ, PEUGEOT</b>	<b>21278</b>
-------------	--	-------------------------------	--------------

Индикатор износа входит в базовую комплектацию данной колодки.

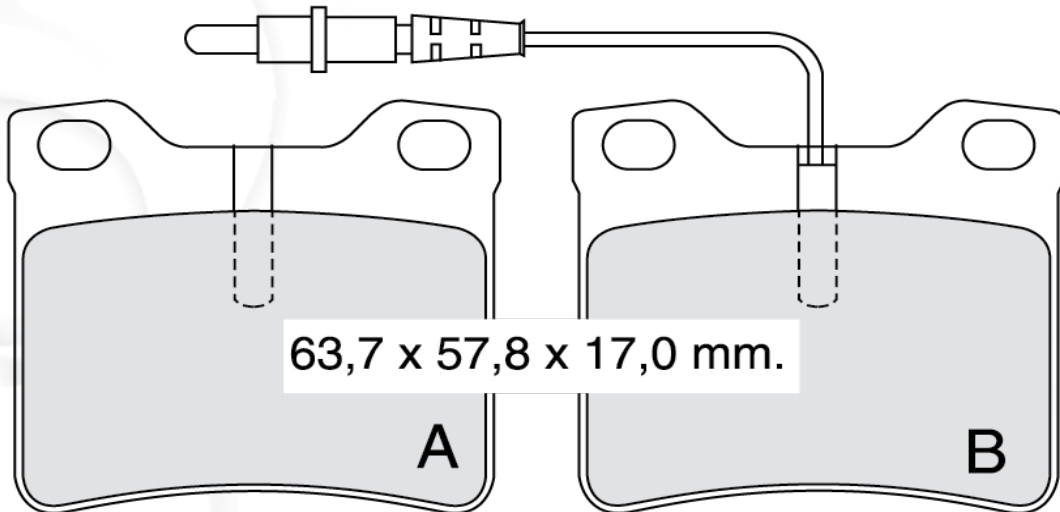

В комплект входят две колодки типа А, две колодки типа В

<b>Д551</b>	<b>Д551К</b>	<b>FORD, MAZDA</b>	<b>21766</b>
-------------	--------------	--------------------	--------------

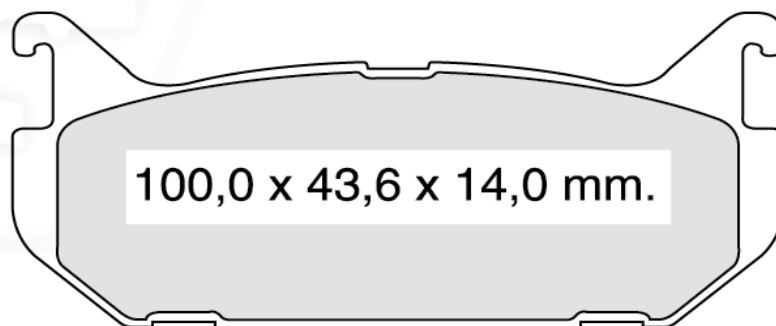

			W.V.A
<b>Д563</b>		<b>HONDA, ROVER</b>	<b>21312</b>
Индикатор износа входит в базовую комплектацию данной колодки.			

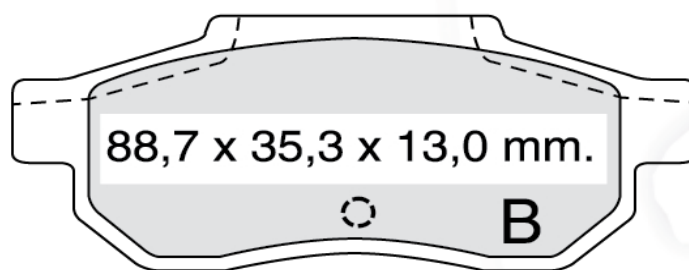
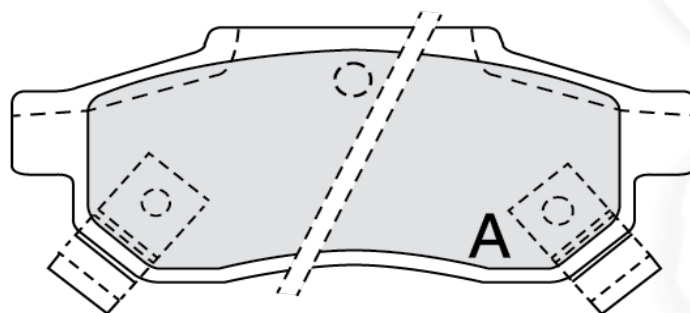

В комплект входят две колодки типа А, две колодки типа В

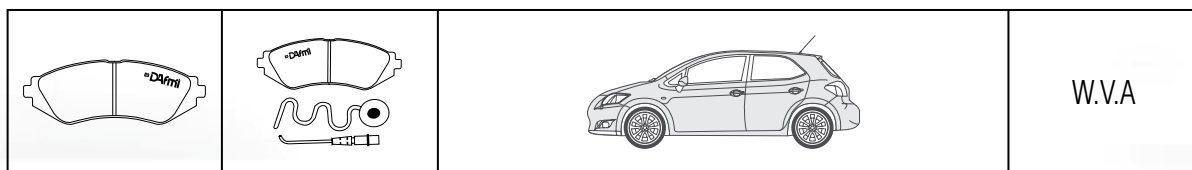

<b>Д572</b>		<b>PEUGEOT</b>	<b>21507</b>
-------------	--	----------------	--------------

Индикатор износа входит в базовую комплектацию данной колодки.

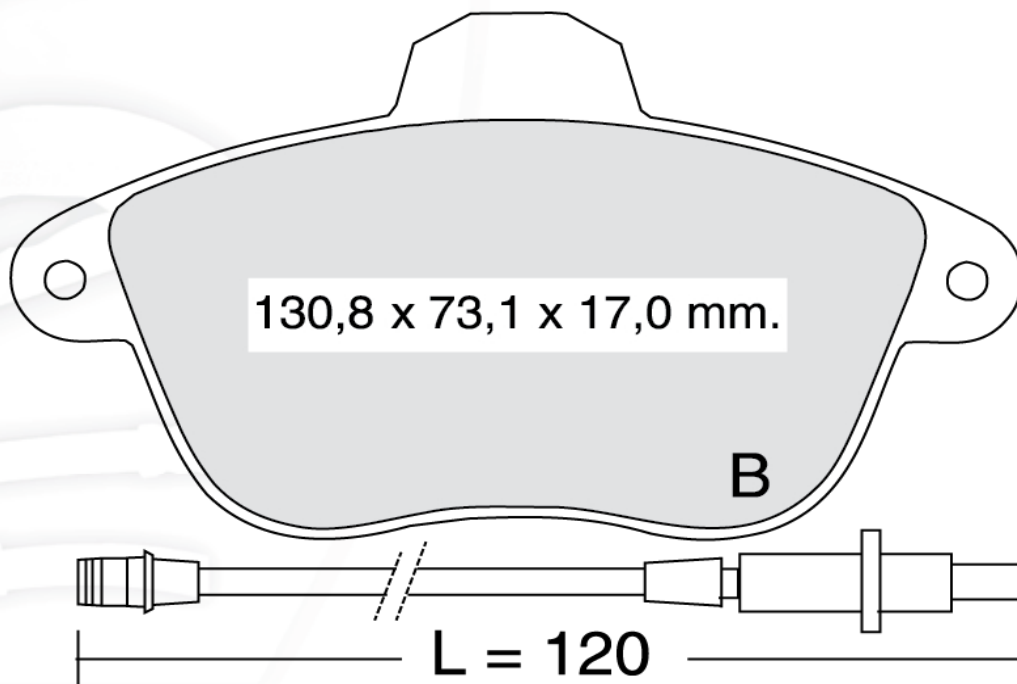
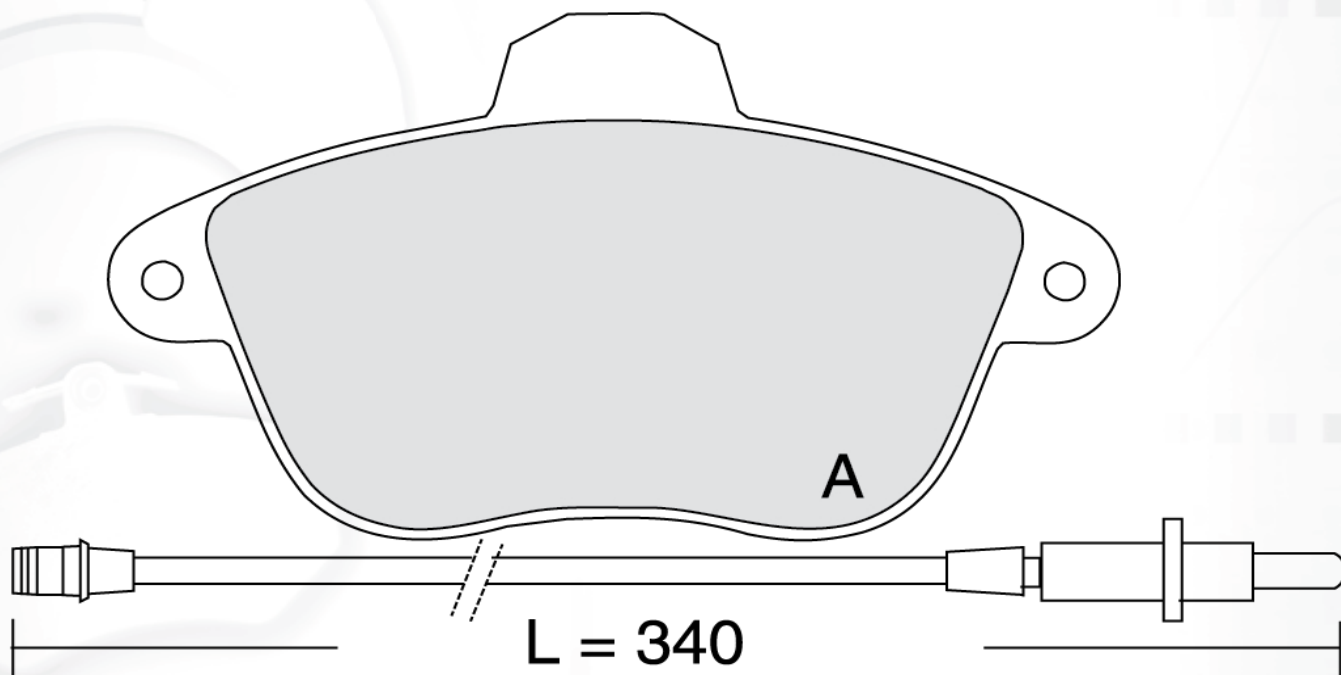

В комплект входят две колодки типа А, две колодки типа В



			W.V.A
<b>Д585</b>		<b>MERCEDES-BENZ</b>	<b>20932</b>

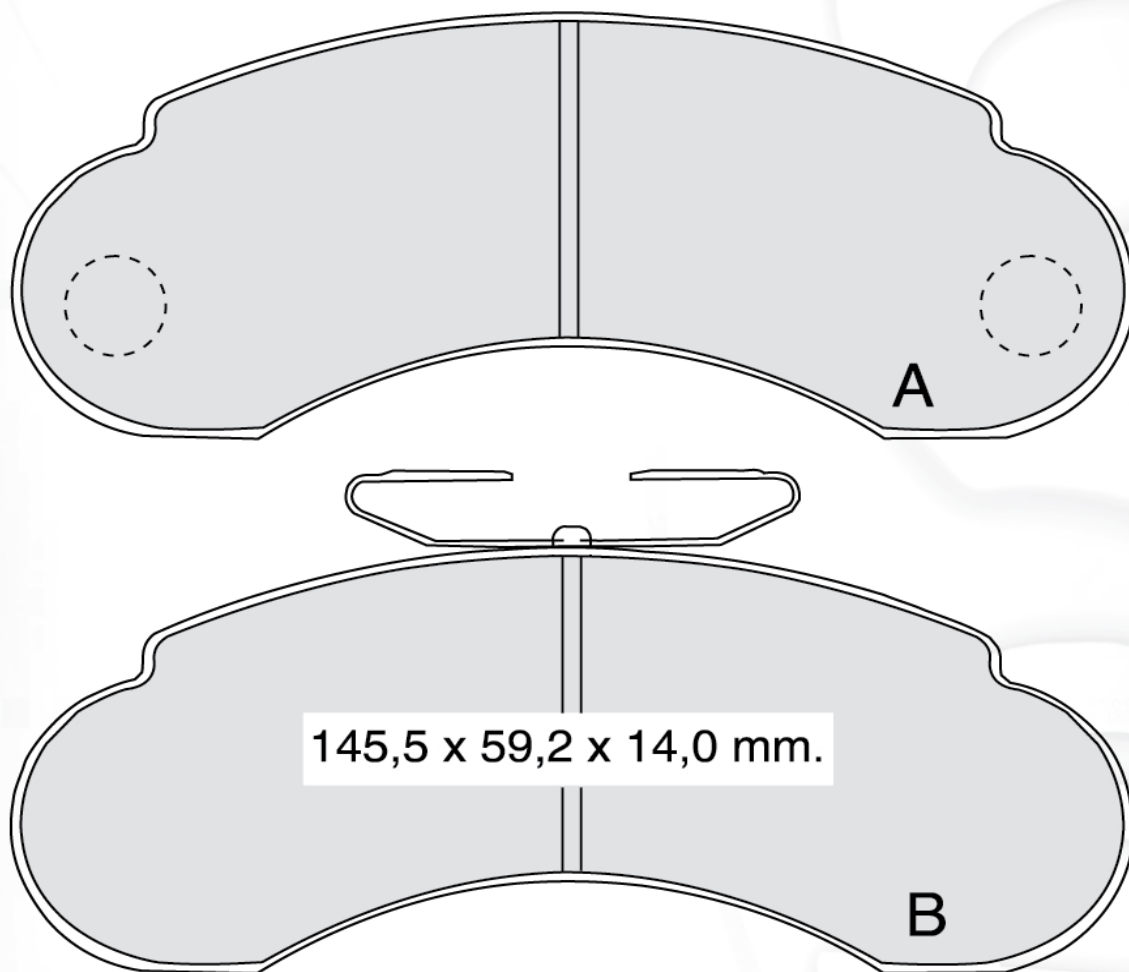

В комплект входят две колодки типа А, две колодки типа В

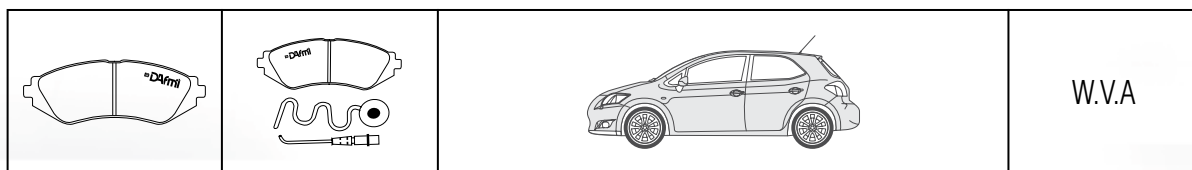

<b>Д594</b>		<b>FORD, MAZDA</b>	<b>21754</b>
-------------	--	--------------------	--------------

Индикатор износа входит в базовую комплектацию данной колодки.

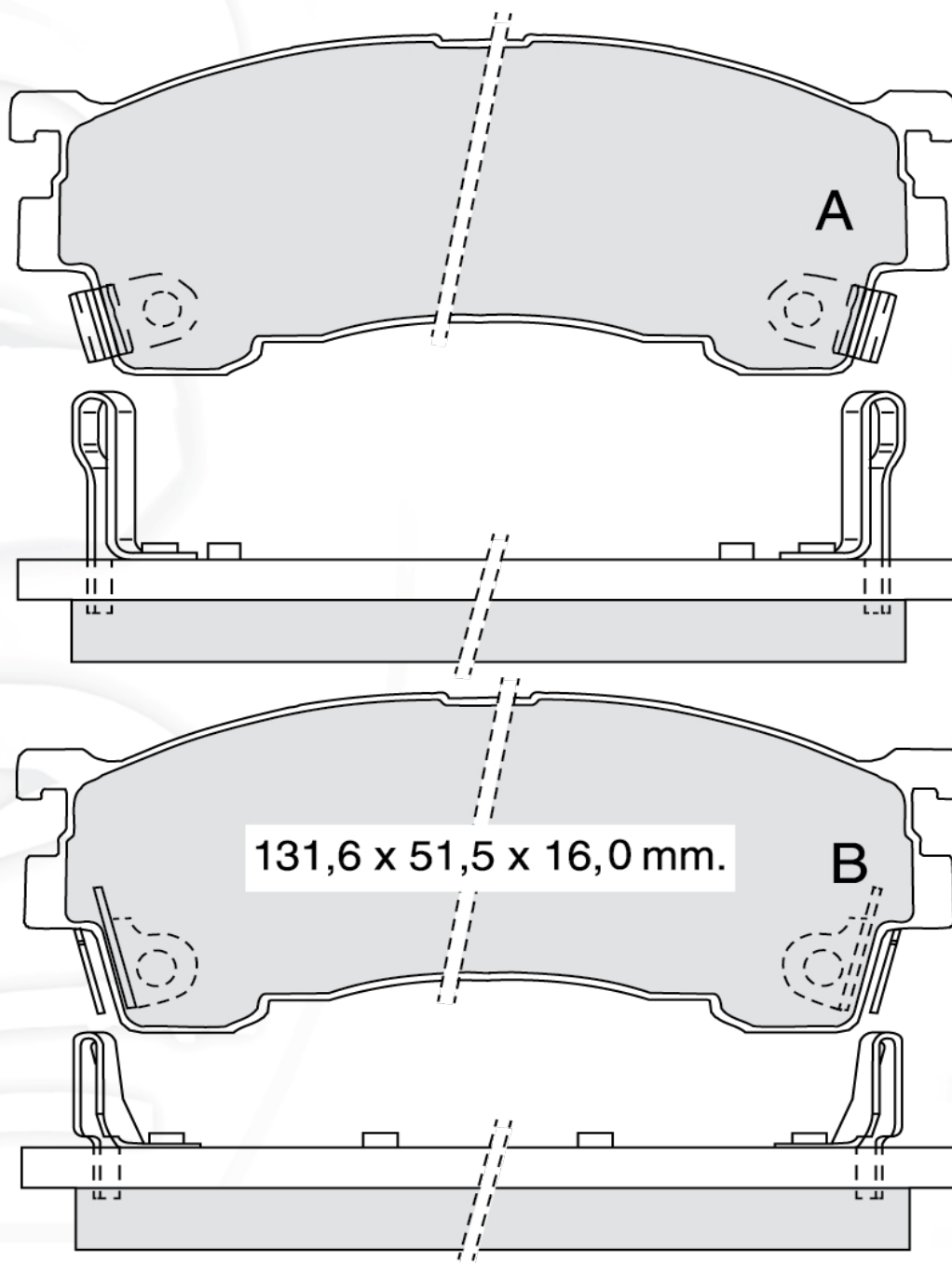

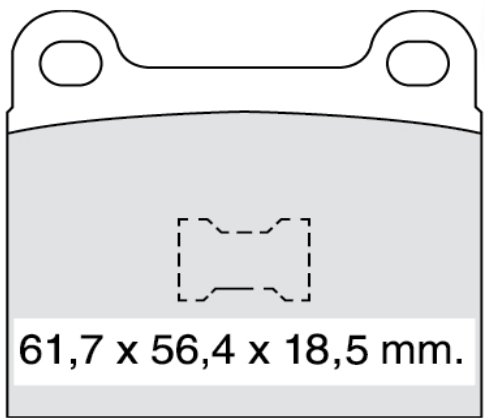

В комплект входят две колодки типа А, две колодки типа В

			W.V.A
<b>Д598</b>		<b>AUDI, VOLKSWAGEN</b>	<b>20228</b>

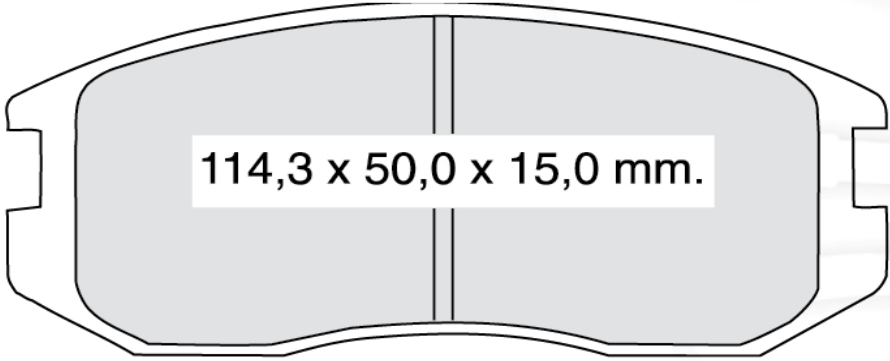

<b>Д601</b>		<b>MITSUBISHI</b>	<b>21650</b>
-------------	--	-------------------	--------------

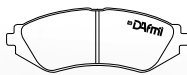
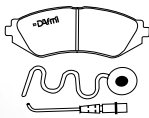

			W.V.A
---	---	--	-------

<b>Д602</b>		<b>ALFA ROMEO, BEDFORD, BMW, MERCEDES-BENZ, OPEL, PORSCHE, SAAB, TABLOT, VOLVO</b>	20034
-------------	--	--	-------

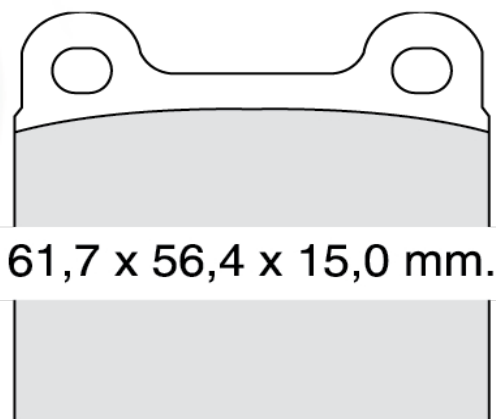

<b>Д608</b>	<b>Д608K</b>	<b>AUDI, TABLOT, VOLKSWAGEN</b>	20228
-------------	--------------	---------------------------------	-------

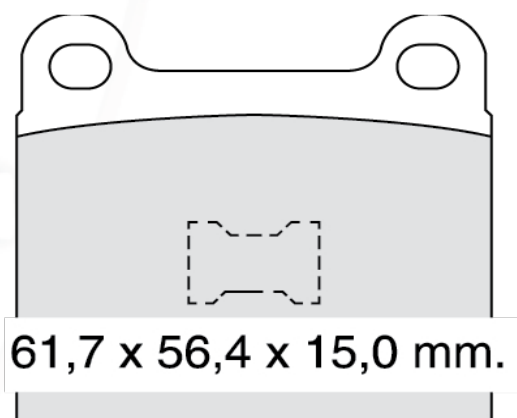

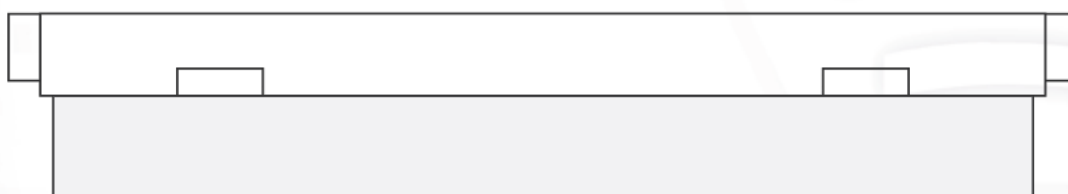
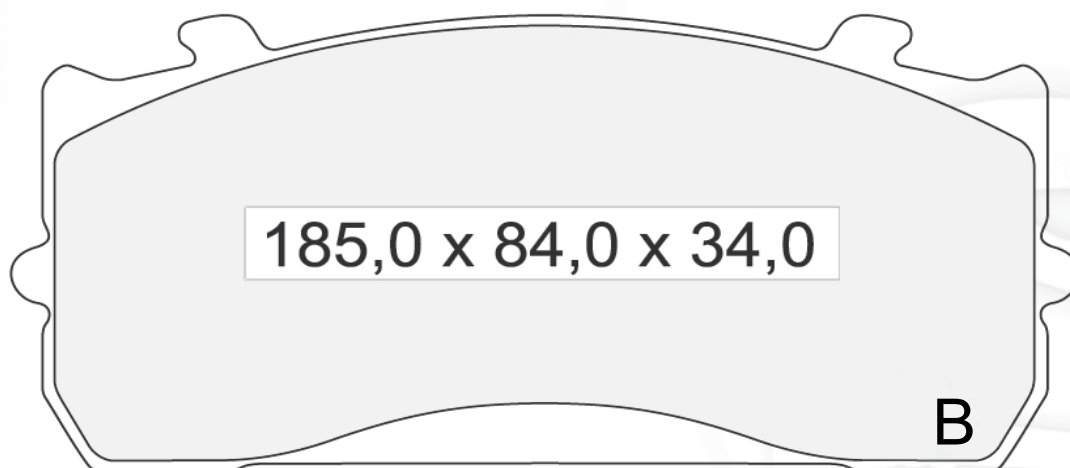
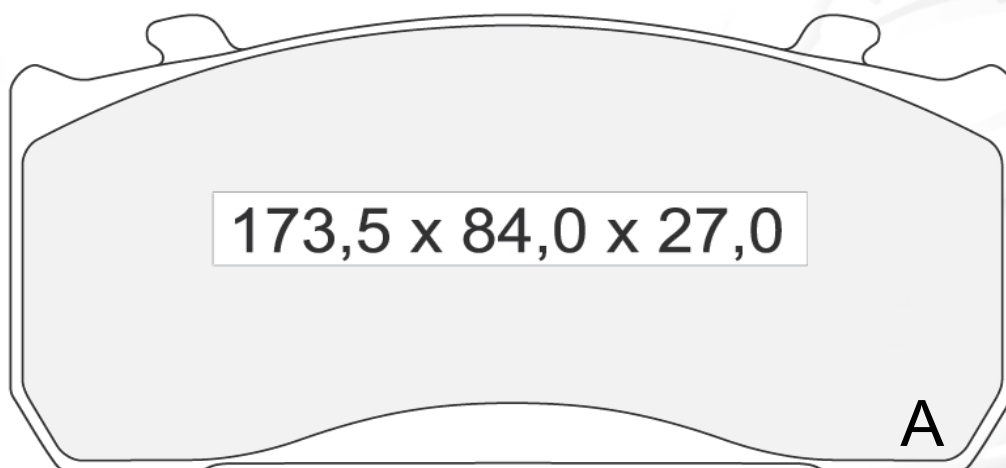

			W.V.A
--	--	--	-------

Д609	2001	MERCEDES, ГАЗ	-
------	------	---------------	---

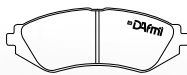
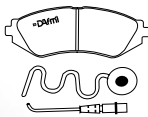

В комплект входят две колодки типа А, две колодки типа В

			W.V.A
---	---	--	-------

<b>Д613</b>	-	<b>MAZDA, FORD</b>	<b>23723</b>
-------------	---	--------------------	--------------

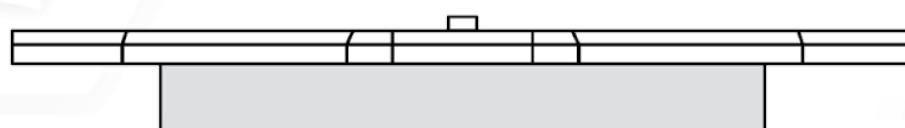
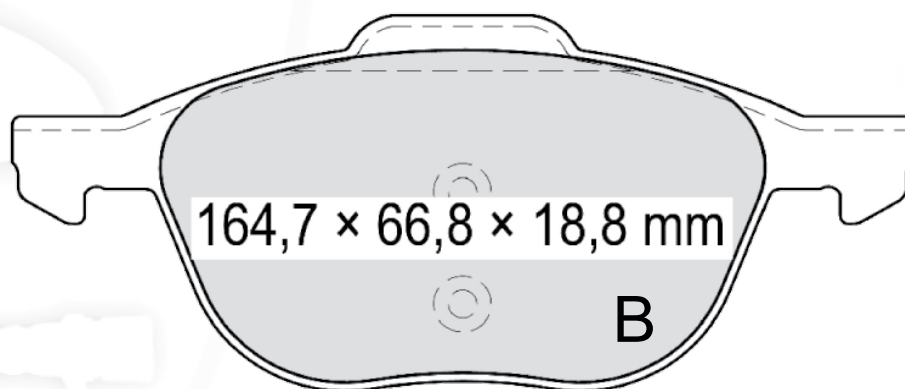
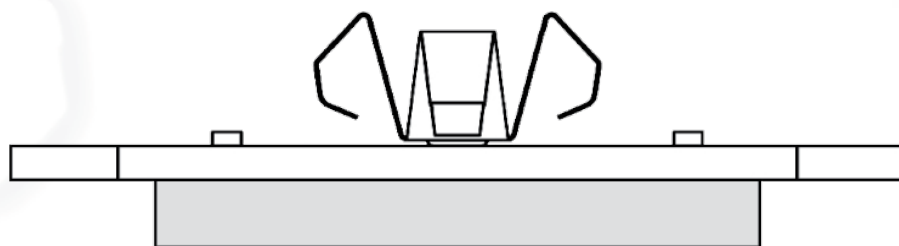
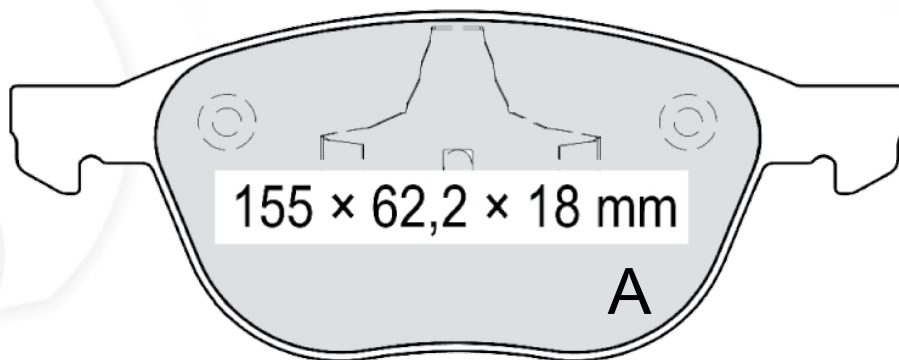

В комплект входят две колодки типа А, две колодки типа В

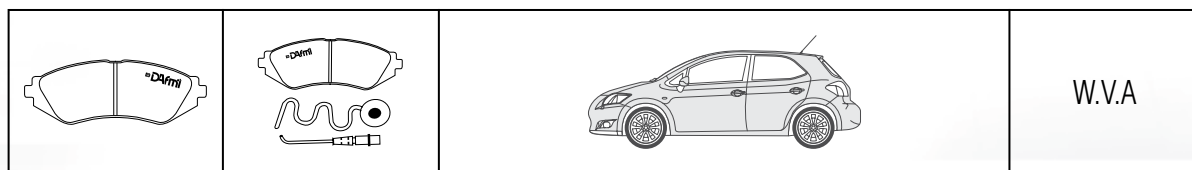

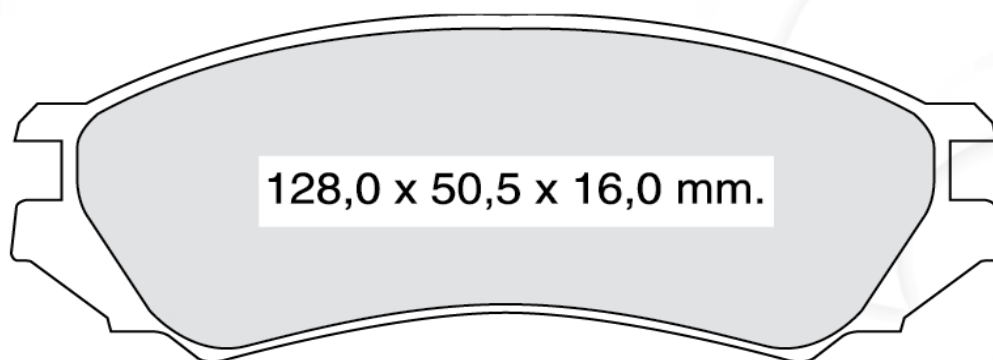

<b>Д618</b>		<b>NISSAN</b>	<b>21280</b>
-------------	--	---------------	--------------

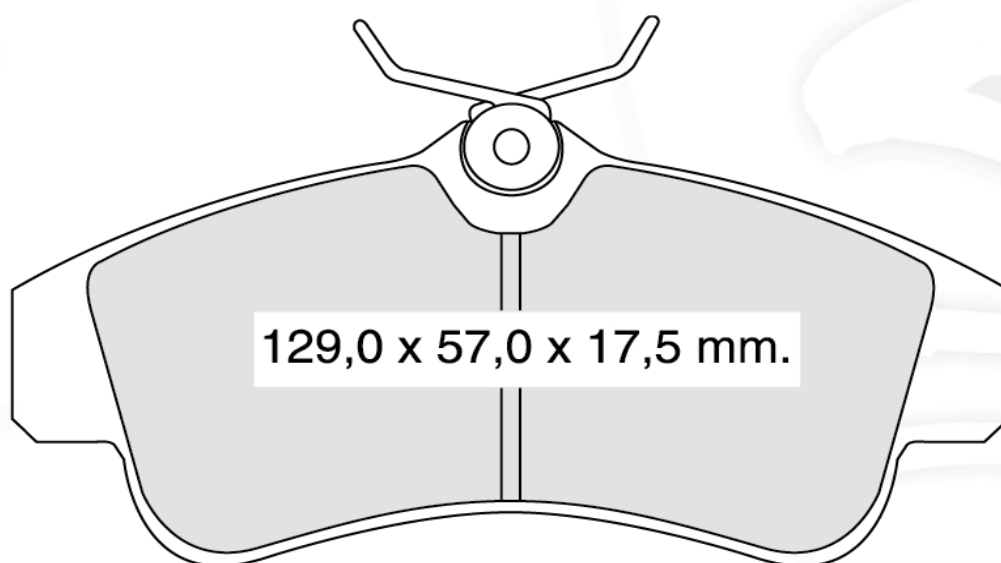

<b>Д619</b>		<b>NISSAN</b>	<b>21546</b>
-------------	--	---------------	--------------

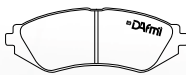
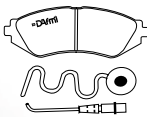

			W.V.A
<b>Д620</b>	<b>Д620И</b>	<b>BMW, PORSCHE</b>	<b>20629</b>

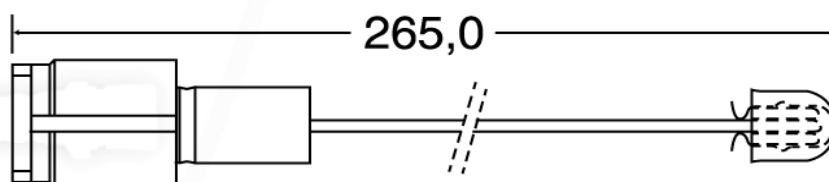
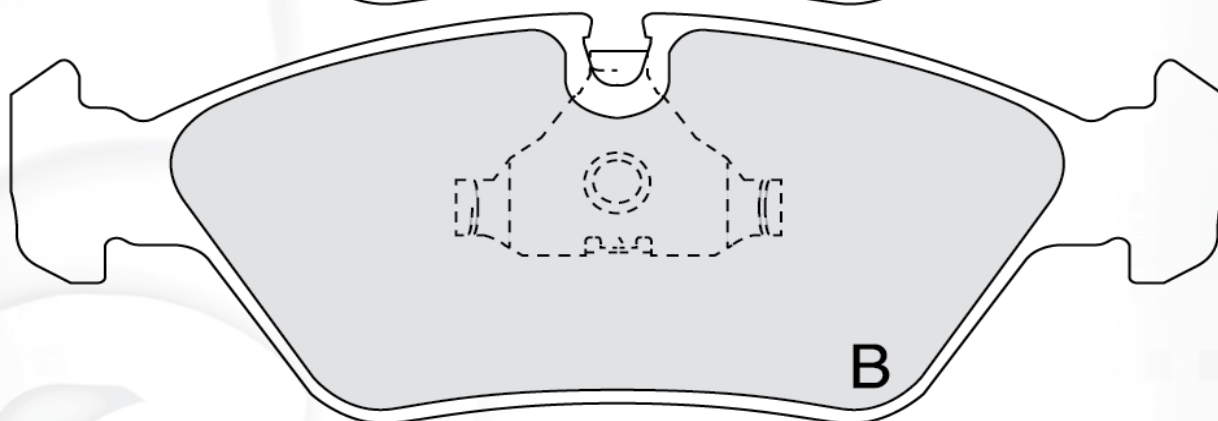
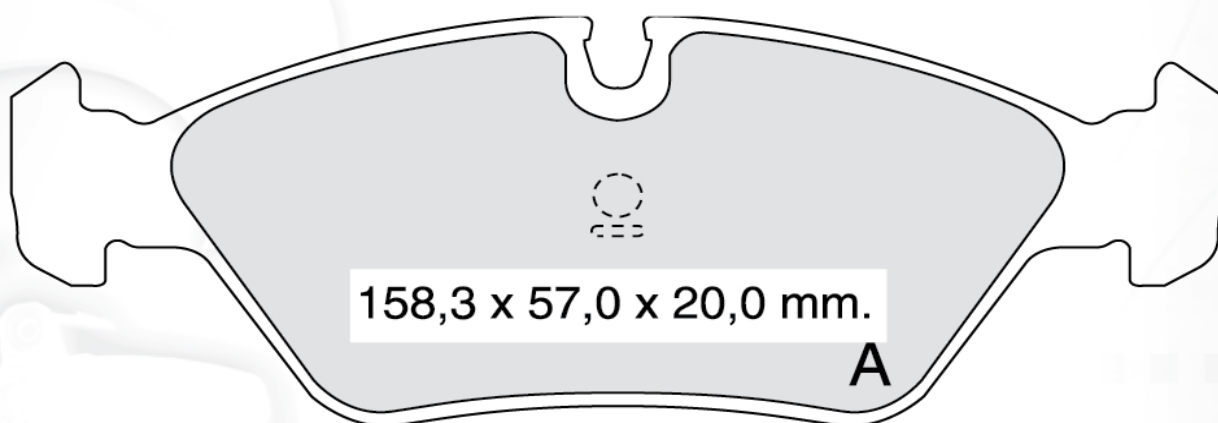

В комплект входят две колодки типа А, две колодки типа В



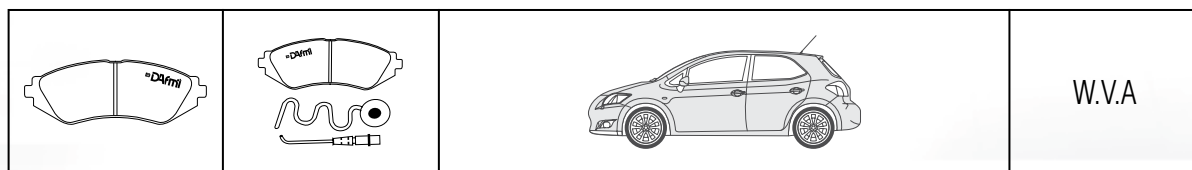

<b>Д628</b>		<b>MAZDA</b>	<b>20002</b>
-------------	--	--------------	--------------

Индикатор износа входит в базовую комплектацию данной колодки.

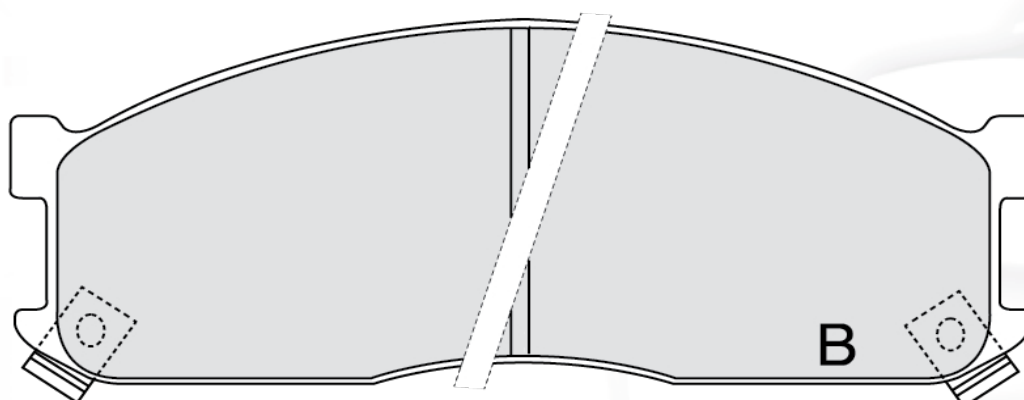
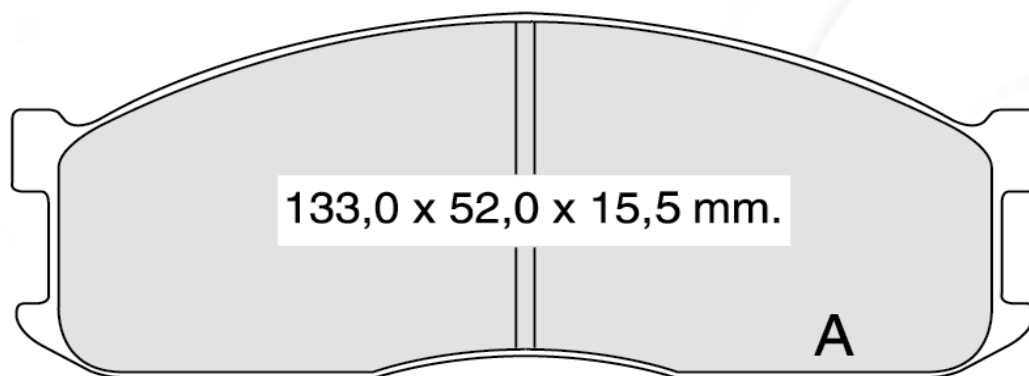

В комплект входят две колодки типа А, две колодки типа В

<b>Д637</b>	<b>Д637К</b>	<b>VOLKSWAGEN</b>	<b>20124</b>
-------------	--------------	-------------------	--------------

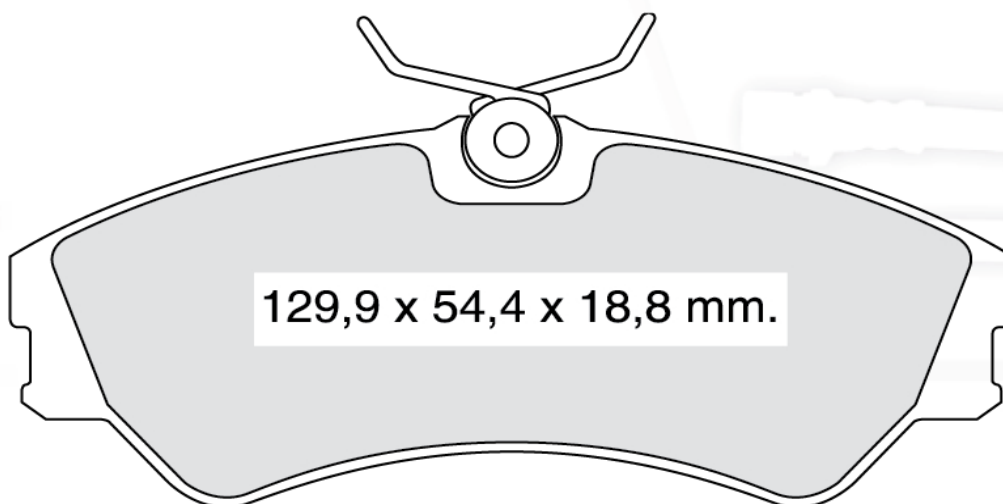

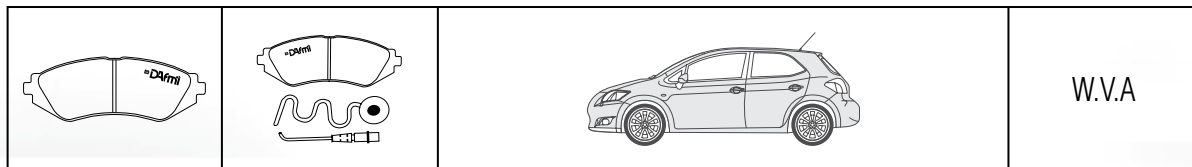

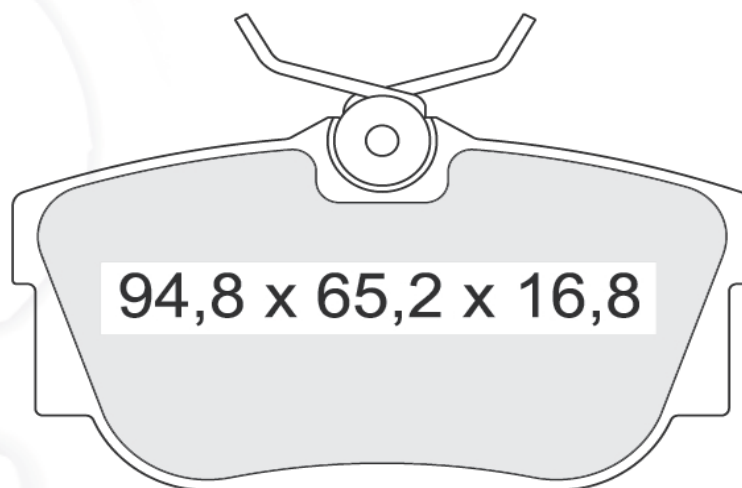

<b>Д638</b>	<b>Д638И</b>	<b>VOLKSWAGEN</b>	<b>23224</b>
-------------	--------------	-------------------	--------------

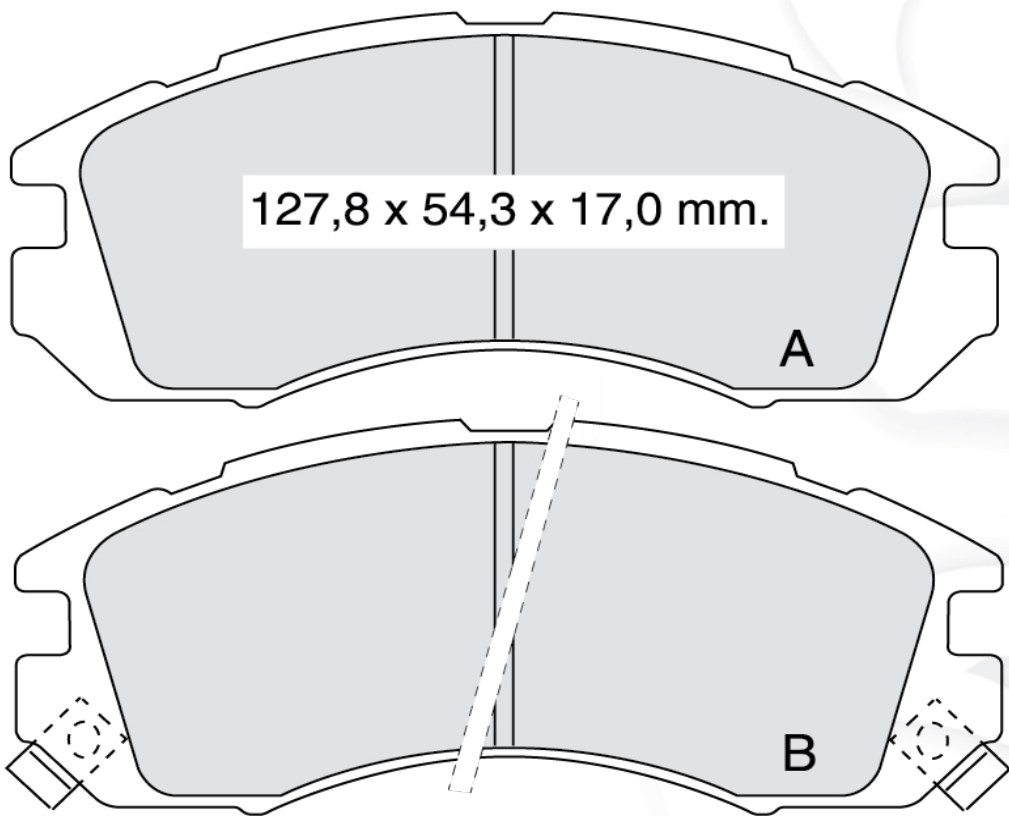

			W.V.A
<b>Д641</b>	<b>Д641К</b>	<b>SUBARU</b>	<b>21495</b>
Индикатор износа входит в базовую комплектацию данной колодки.			

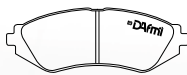
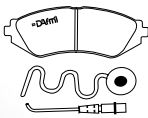

В комплект входят две колодки типа А, две колодки типа В

			W.V.A
---	---	--	-------

<b>Д645</b>		<b>VOLVO</b>	<b>21216</b>
-------------	--	--------------	--------------

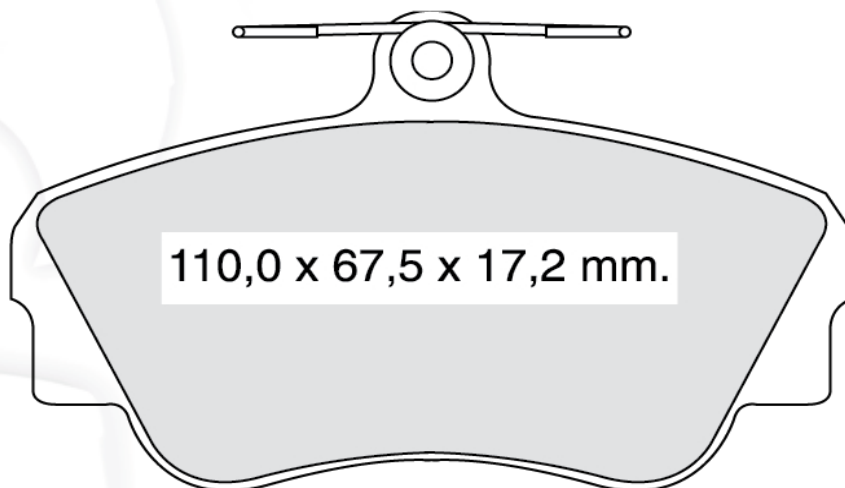

<b>Д646</b>	<b>Д646К</b>	<b>DAIHATSU, HYUNDAI, MAZDA, MITSUBISHI, TOYOTA</b>	<b>20703</b>
-------------	--------------	---	--------------

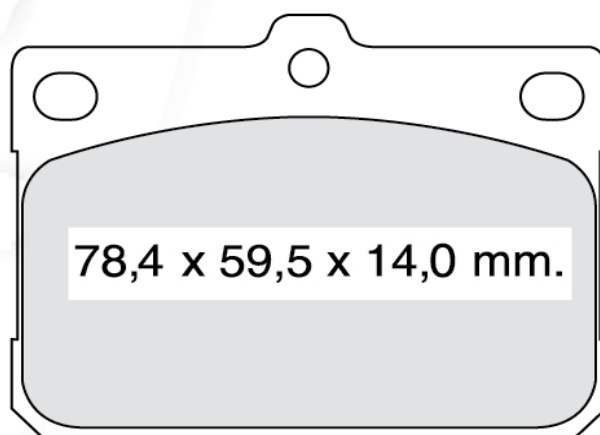



			W.V.A
--	--	--	-------

<b>Д647</b>	-	<b>NISSAN</b>	-
-------------	---	---------------	---

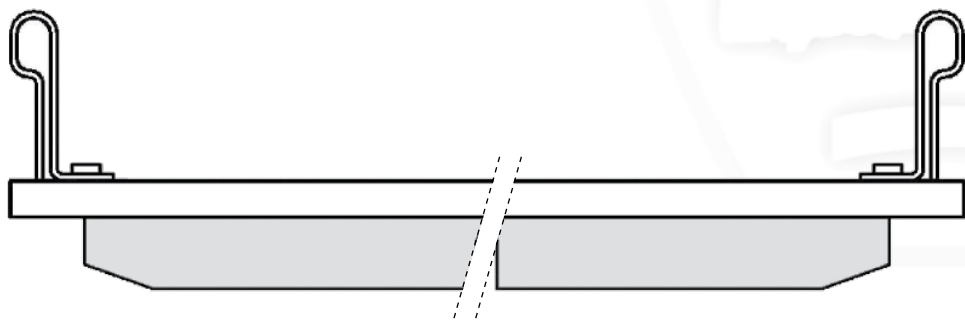
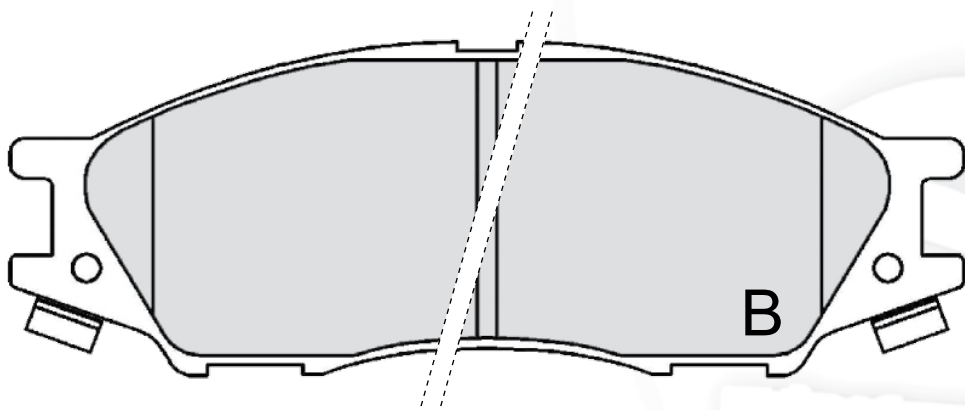
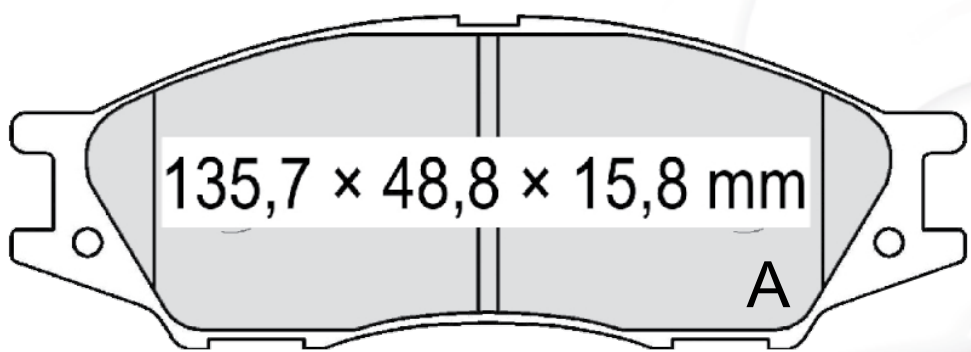
Индикатор износа входит в базовую комплектацию данной колодки

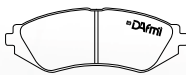
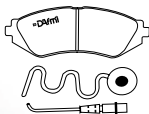

В комплект входят две колодки типа А, две колодки типа В

			W.V.A
---	---	--	-------

<b>Д653</b>		<b>PEUGEOT, SEAT, SKODA, VOLKSWAGEN</b>	20960
-------------	--	---	-------

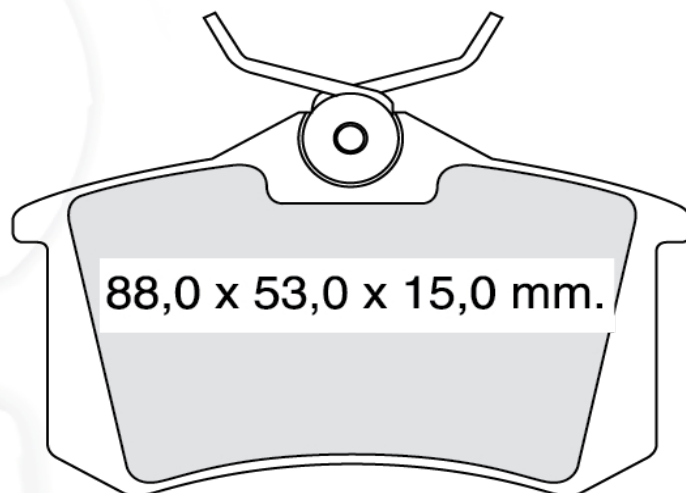

<b>Д656</b>		<b>BA3</b>	20166
-------------	--	------------	-------

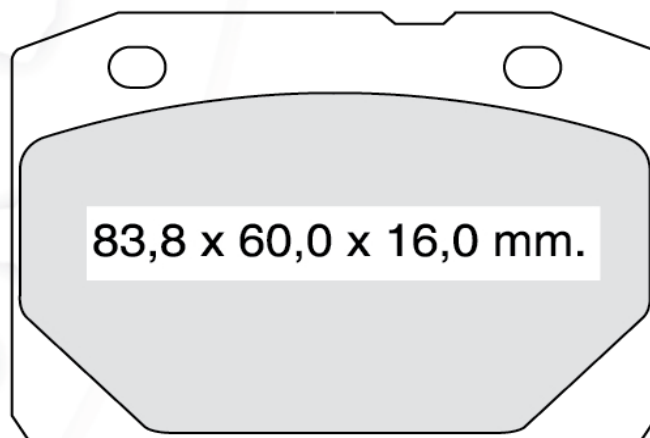

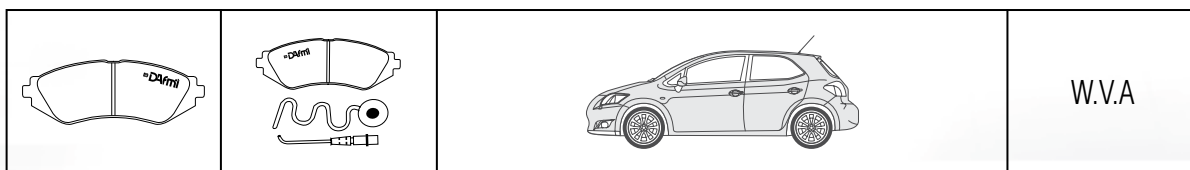

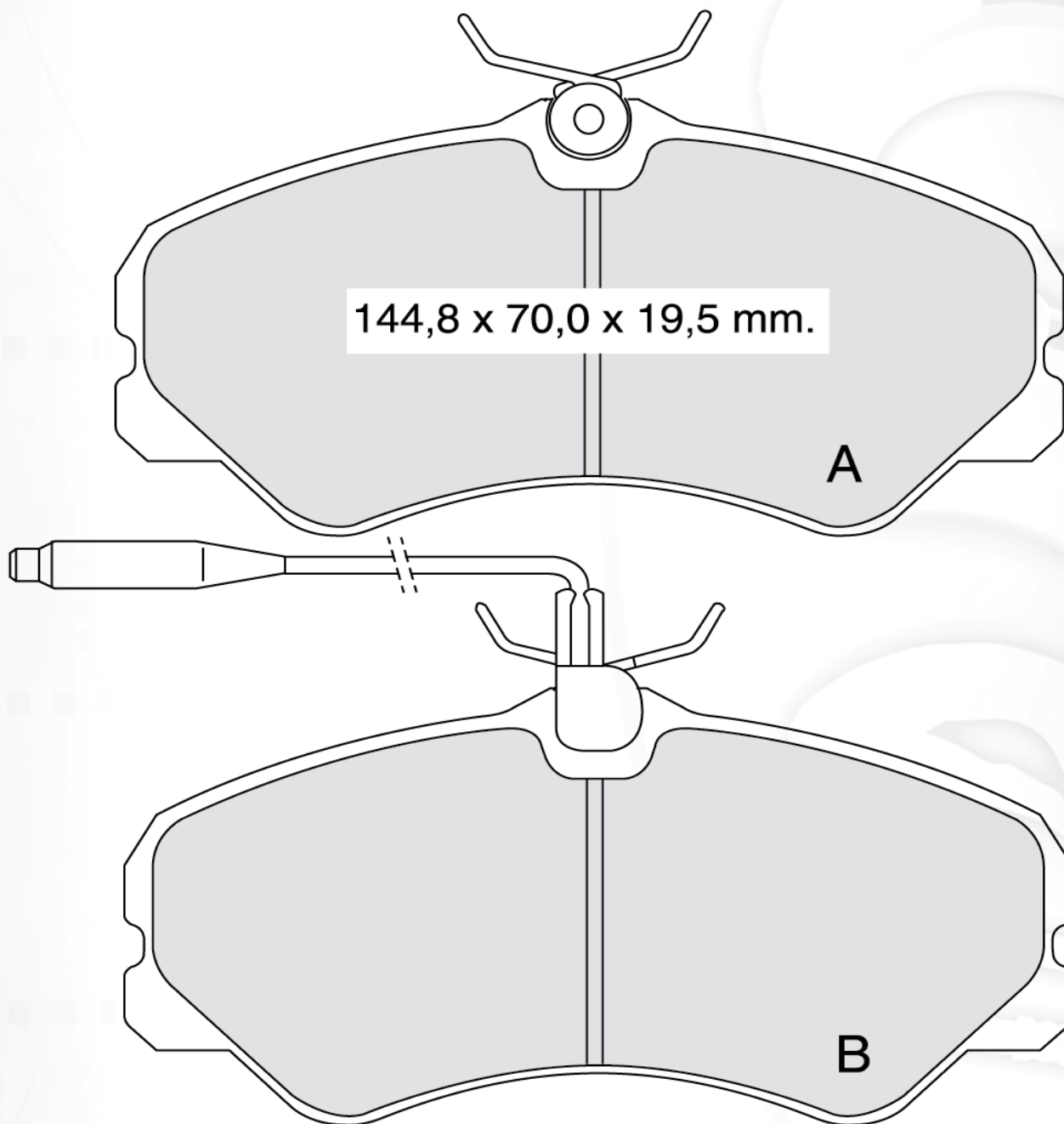

<b>Д674</b>		<b>СИТРОЕН, ФИАТ, ПЕЖЕОТ</b>	<b>21206</b>
-------------	--	------------------------------	--------------

Индикатор износа входит в базовую комплектацию данной колодки.

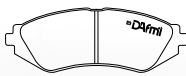
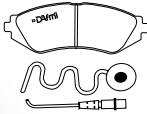

В комплект входят две колодки типа А, две колодки типа В

			W.V.A
---	---	--	-------

<b>Д679</b>	<b>Д679И</b>	<b>MERCEDES-BENZ, VOLKSWAGEN</b>	<b>20341</b>
-------------	--------------	----------------------------------	--------------

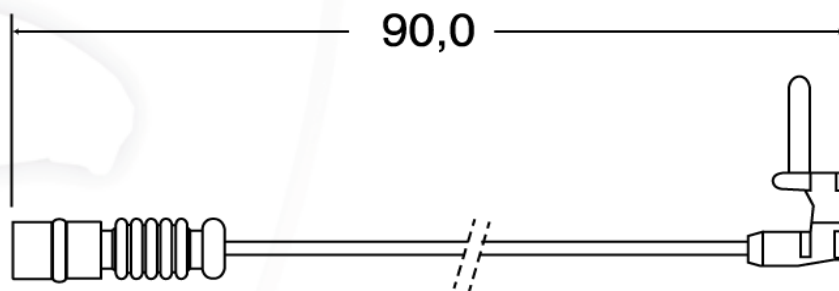
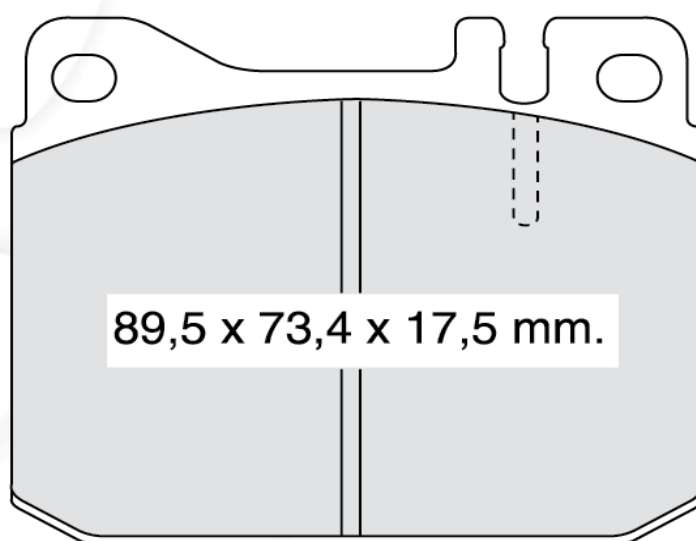



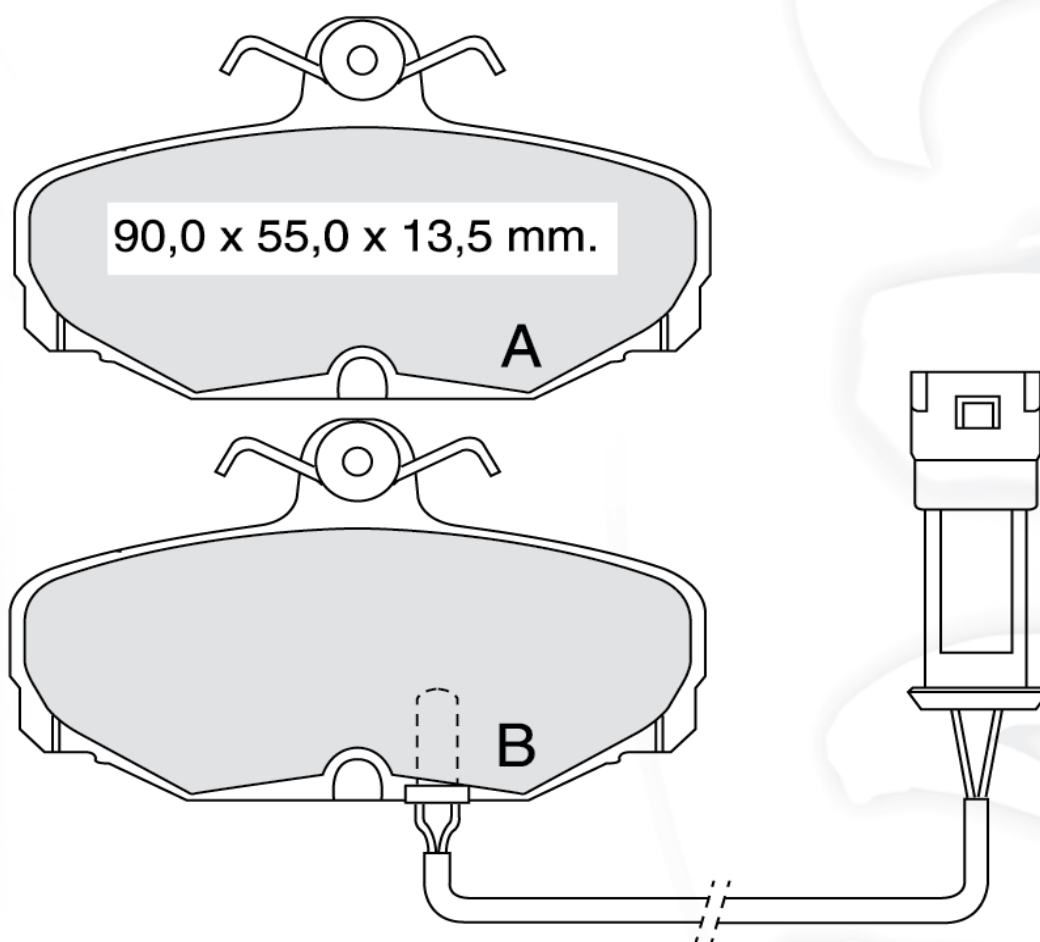

			W.V.A
<b>Д685</b>		<b>FORD</b>	<b>21079</b>
Индикатор износа входит в базовую комплектацию данной колодки.			

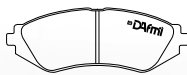
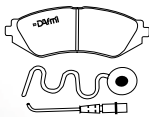

В комплект входят две колодки типа А, две колодки типа В

			W.V.A
---	---	--	-------

<b>Д687</b>		<b>OPEL, SAAB</b>	<b>21050</b>
-------------	--	-------------------	--------------

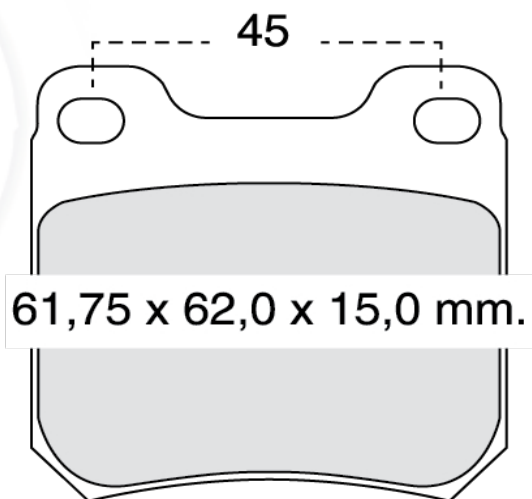

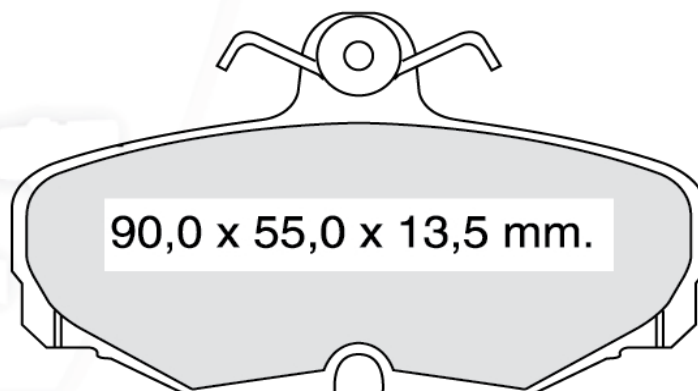

<b>Д689</b>		<b>FORD</b>	<b>20981</b>
-------------	--	-------------	--------------

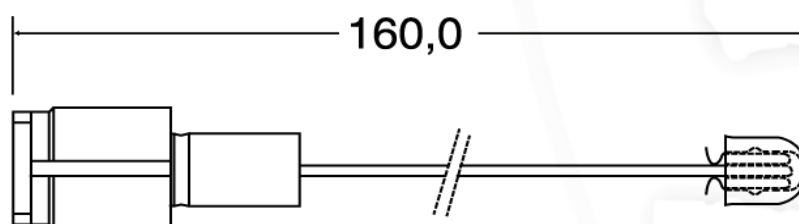
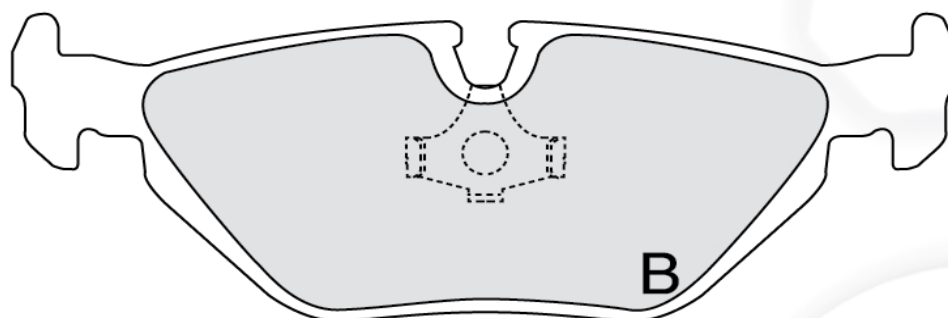
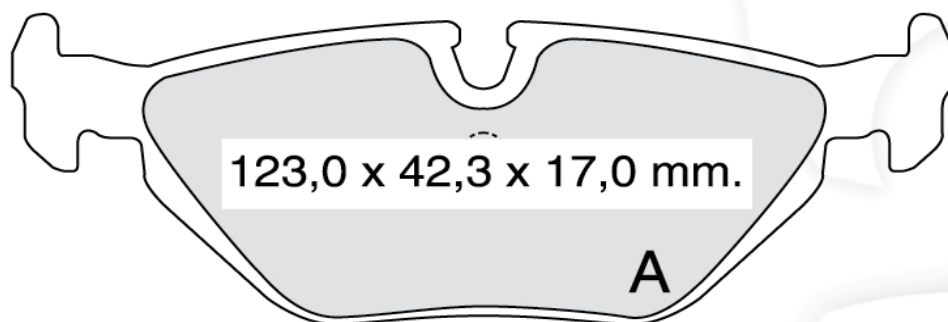

			W.V.A
<b>Д698</b>	<b>Д698И</b>	<b>BMW</b>	<b>20180</b>

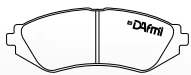
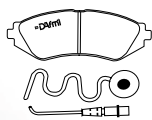

В комплект входят две колодки типа А, две колодки типа В

			W.V.A
<b>Д700</b>	<b>Д700И</b>	<b>OPEL</b>	<b>20547</b>

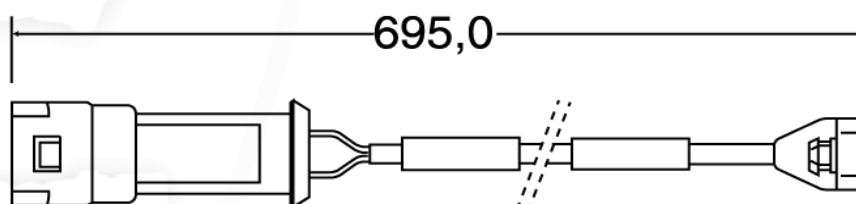
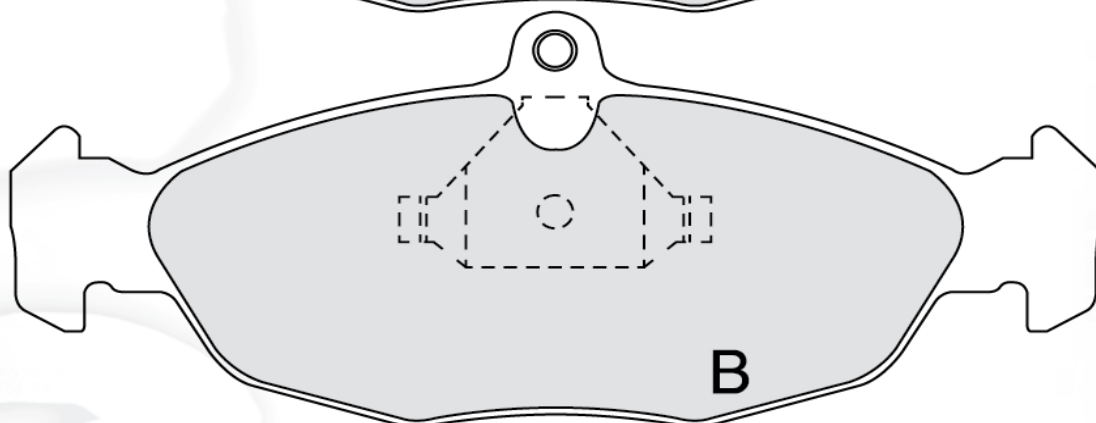
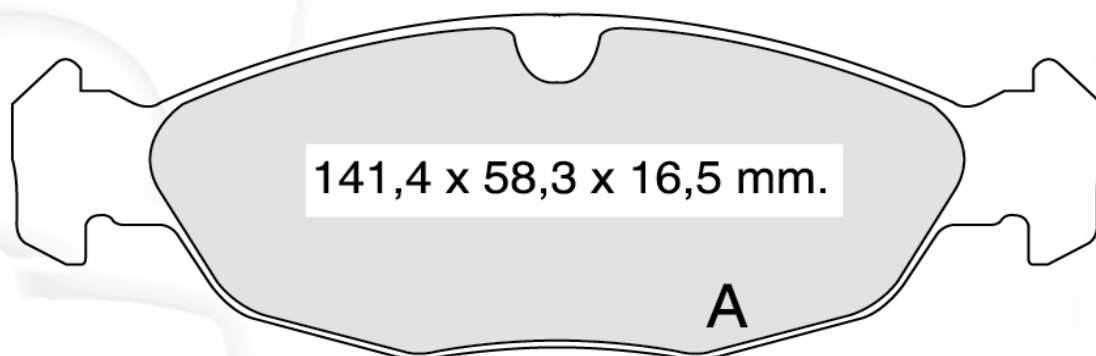

В комплект входят две колодки типа А, две колодки типа В

			W.V.A
--	--	--	-------

<b>Д702</b>		<b>CITROEN</b>	<b>21080</b>
-------------	--	----------------	--------------

Индикатор износа входит в базовую комплектацию данной колодки.

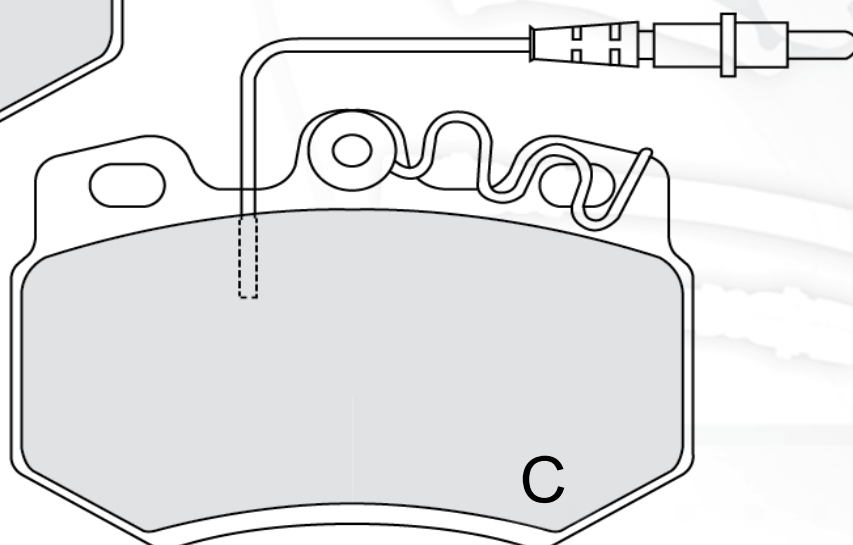
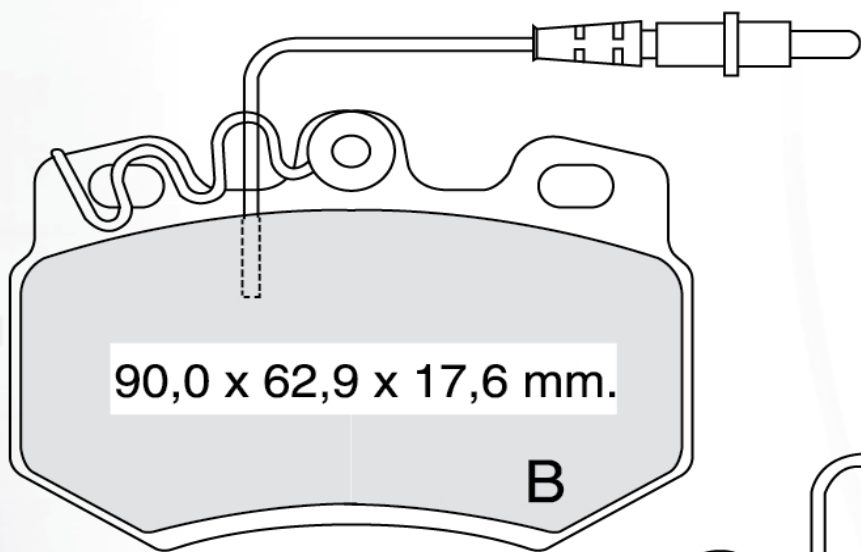
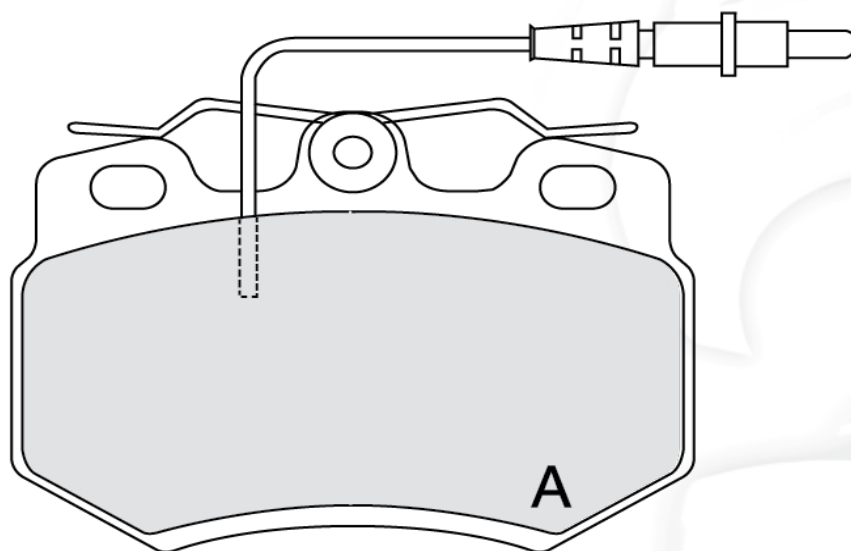

В комплект входят две колодки типа А,  
одна колодка типа В, одна колодка типа С

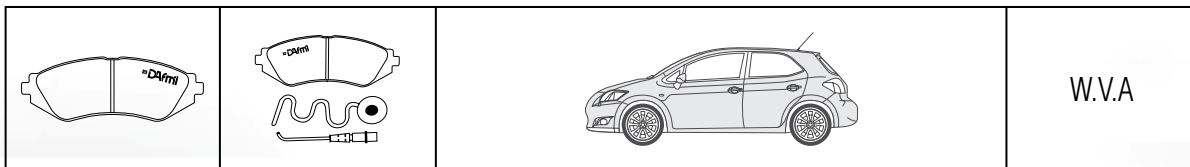

<b>Д711И1</b>	<b>LANCIA</b>	<b>21074</b>
---------------	---------------	--------------

Комплект состоит из двух колодок с индикатором износа и двух колодок без индикатора износа.

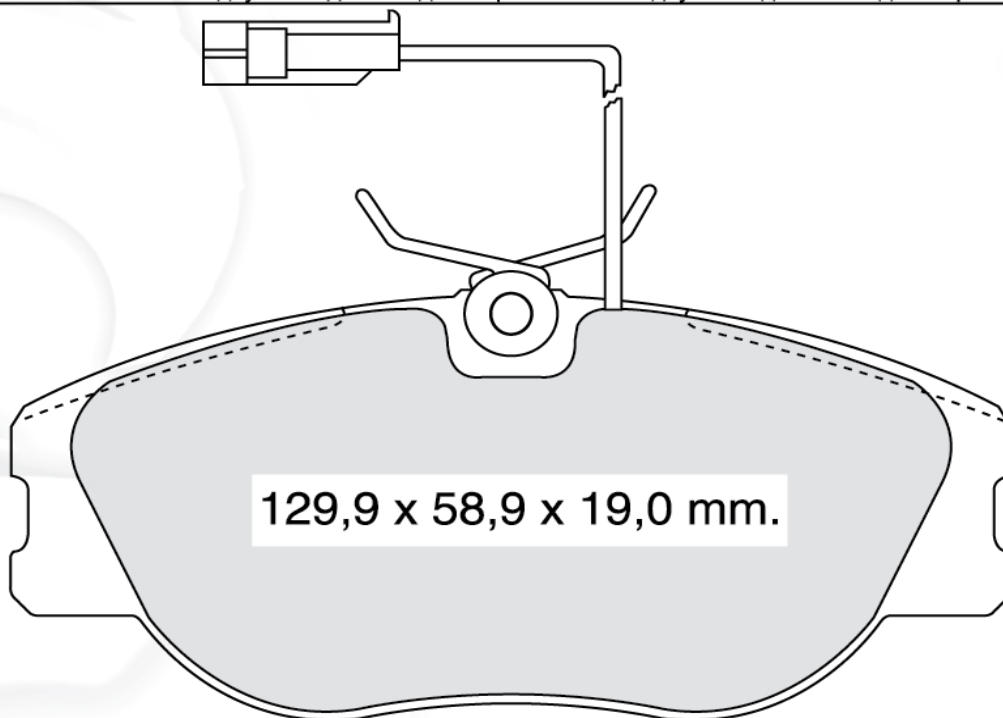

<b>Д711И2</b>	<b>ALFA ROMEO, FIAT</b>	<b>21074</b>
---------------	-------------------------	--------------

Комплект состоит из двух колодок с индикатором износа и двух колодок без индикатора износа.

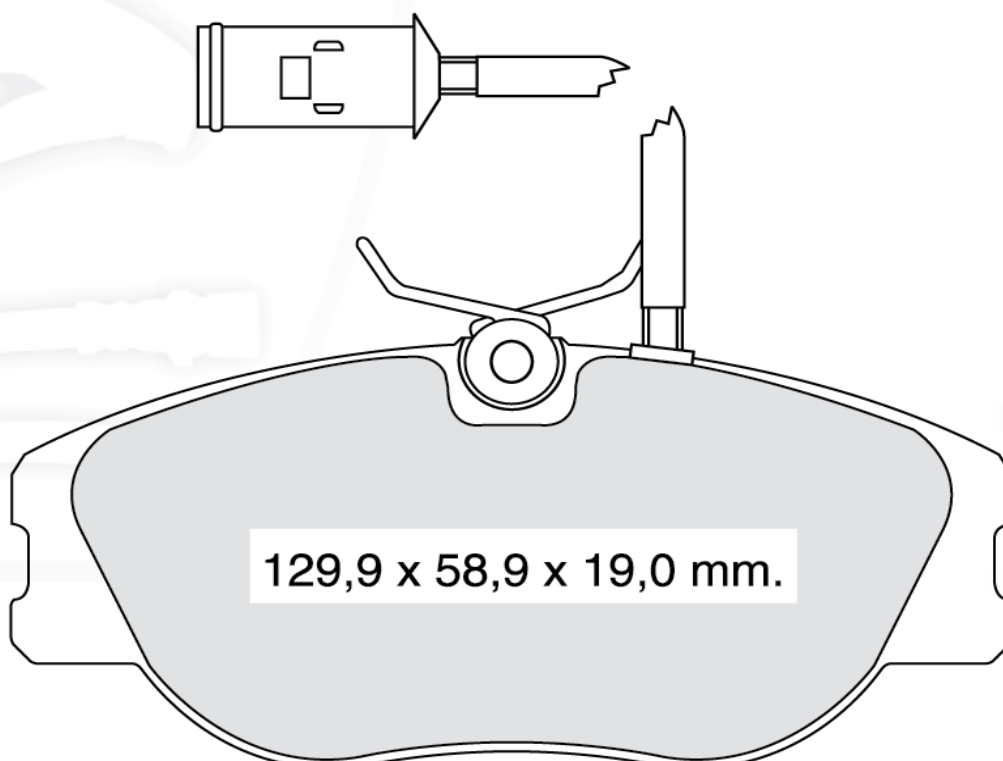

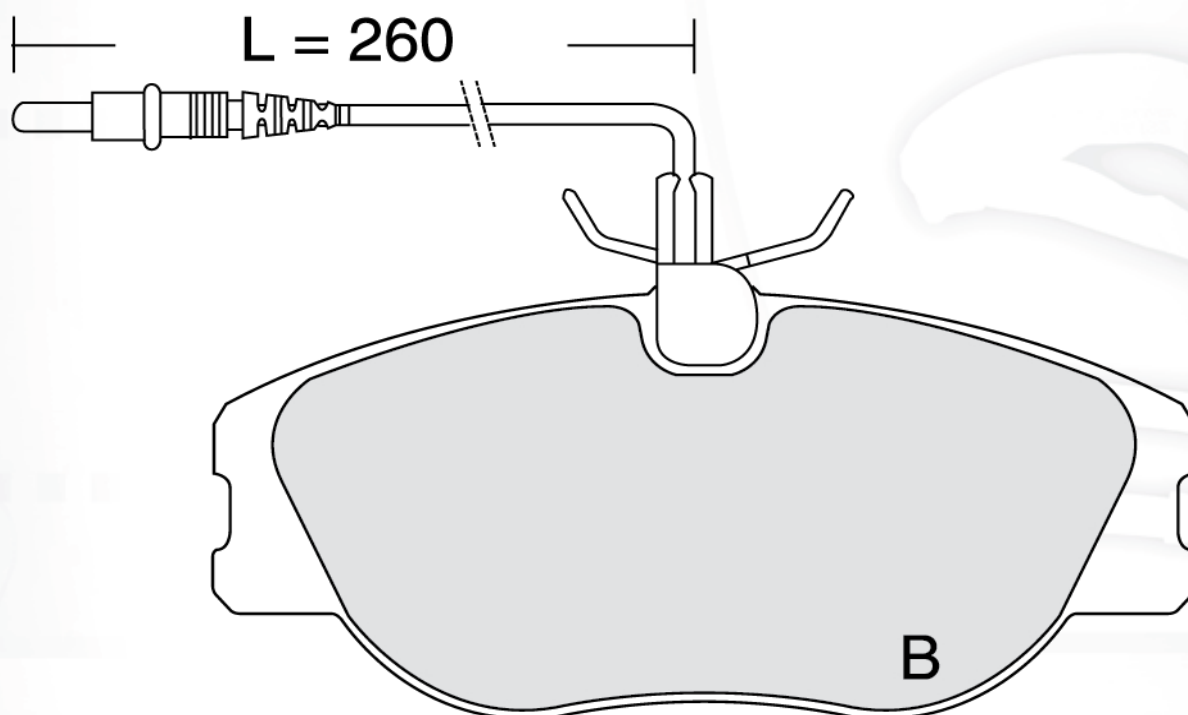
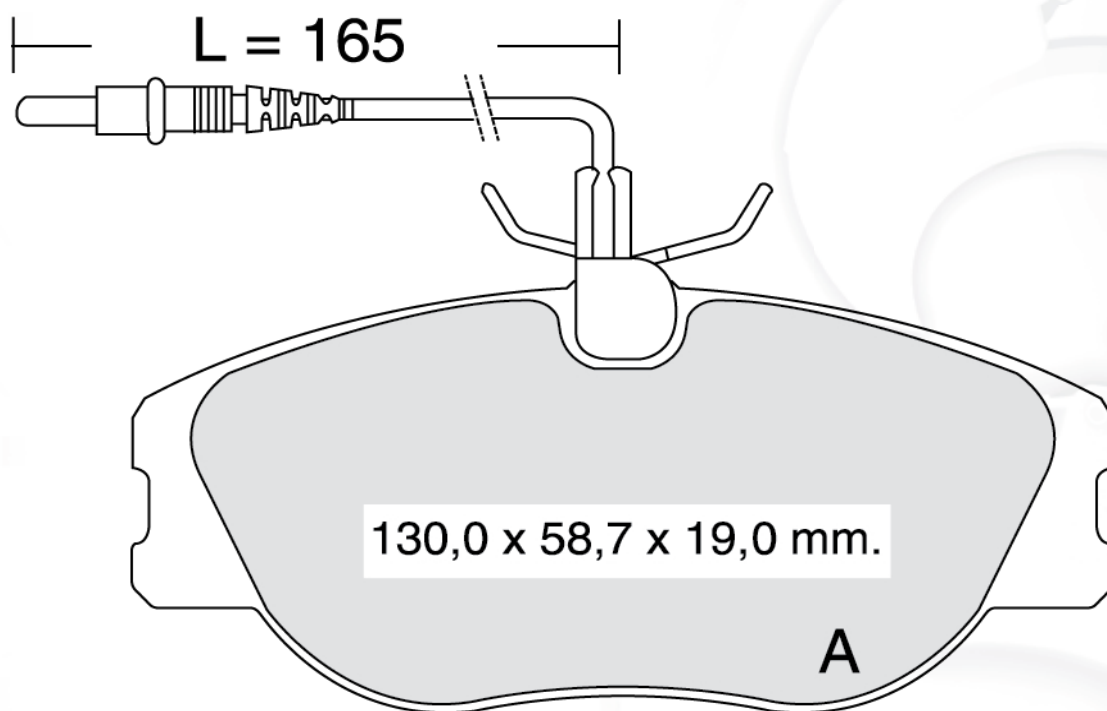

			W.V.A
--	--	--	-------

	<b>Д711ИЗ</b>	<b>MAZDA, FORD</b>	<b>21074</b>
--	---------------	--------------------	--------------

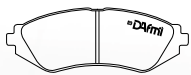
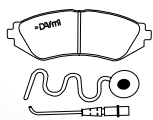

В комплект входят две колодки типа А, две колодки типа В

			W.V.A
<b>Д714</b>		<b>FORD</b>	23202 23203

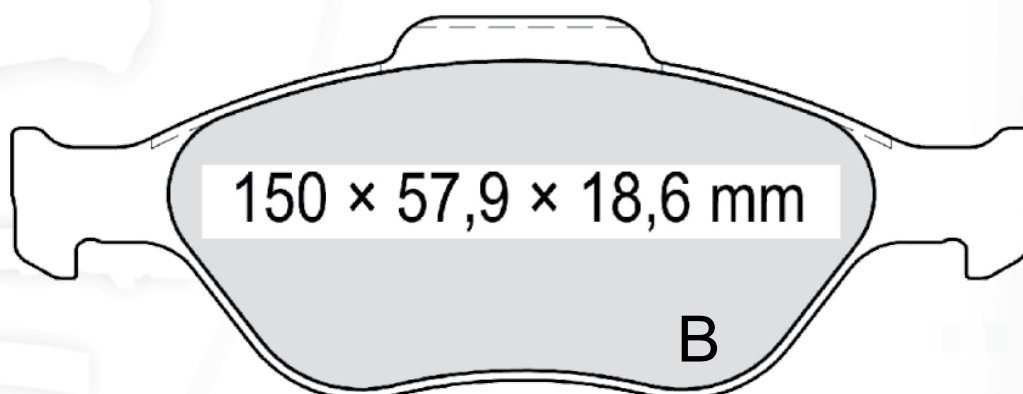
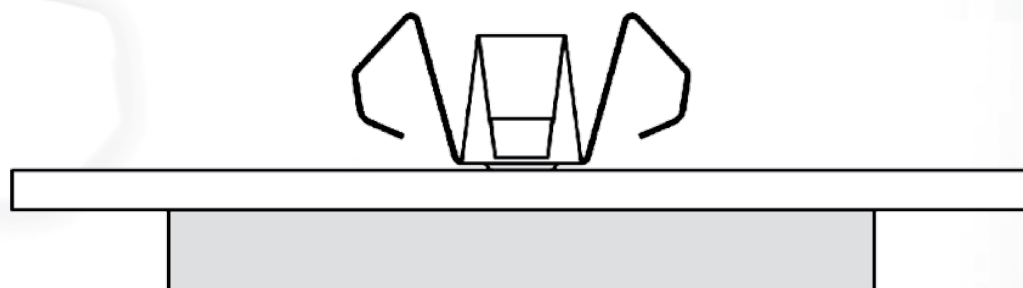
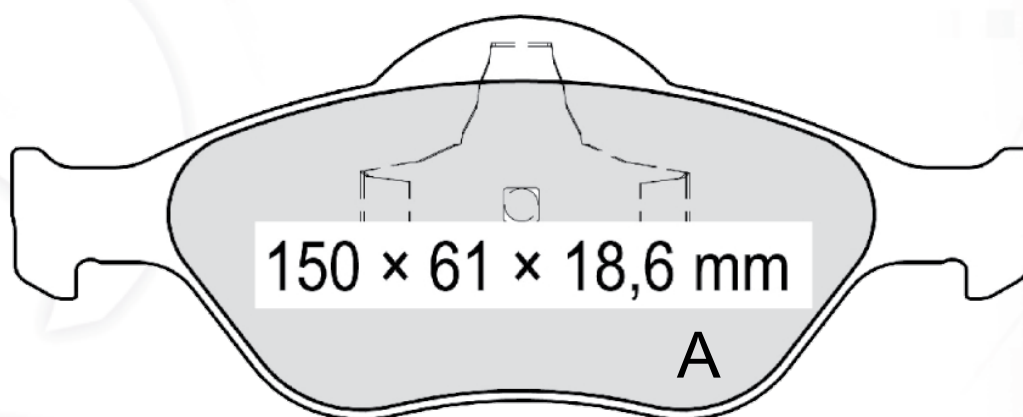



В комплект входят две колодки типа А, две колодки типа В

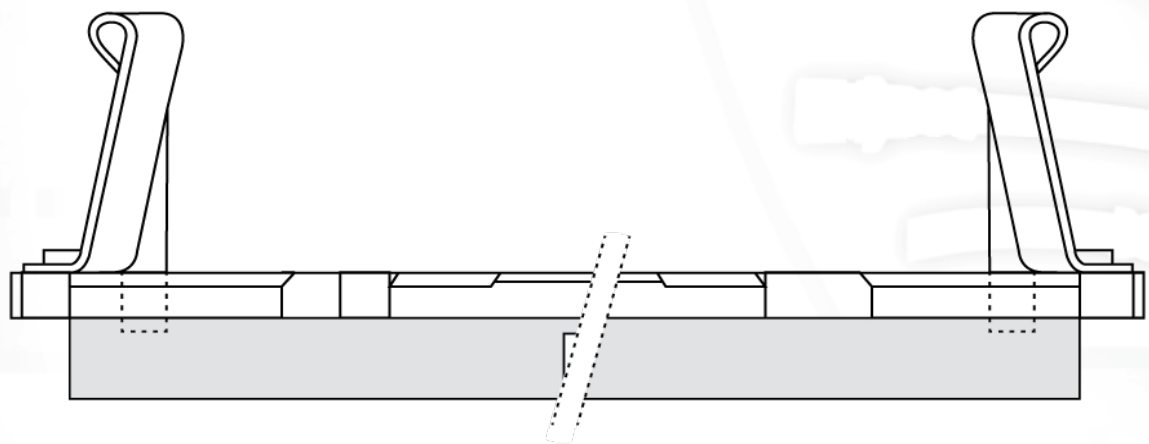
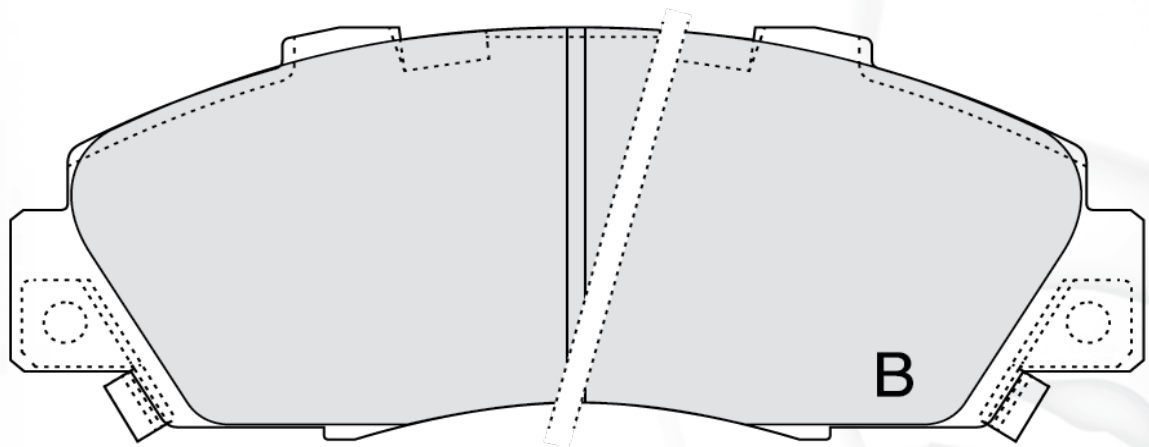
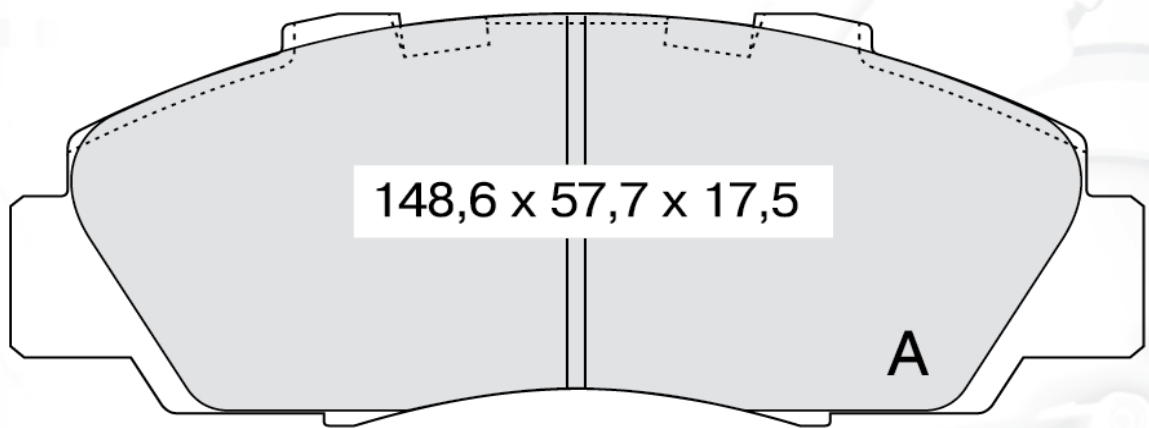

			W.V.A
	<b>Д717И</b>	<b>HONDA</b>	21651



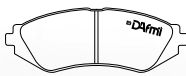
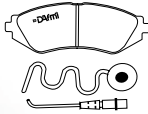

В комплект входят две колодки типа А, две колодки типа В

			W.V.A
---	---	--	-------

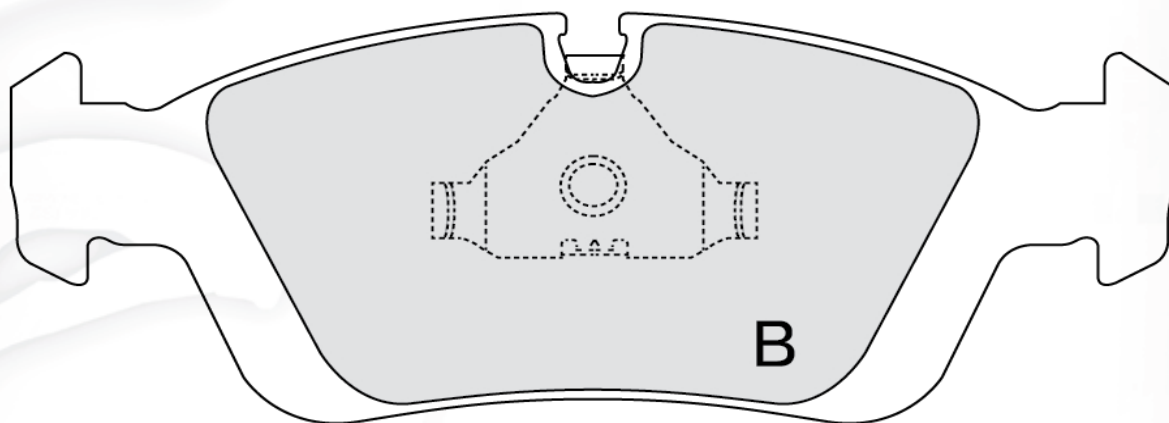
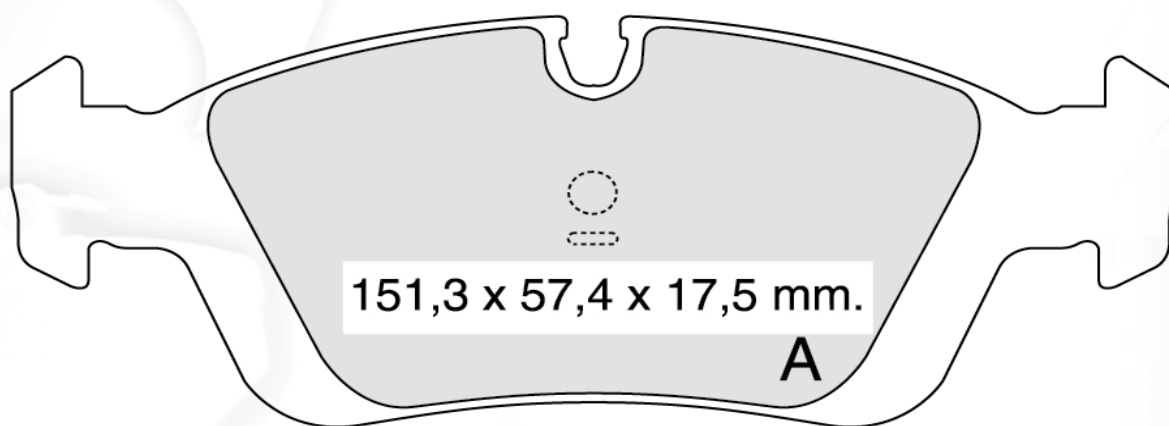
<b>Д720</b>	<b>Д720И</b>	<b>BMW</b>	<b>21292</b>
-------------	--------------	------------	--------------

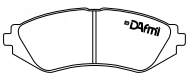
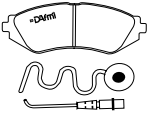

В комплект входят две колодки типа А, две колодки типа В

			W.V.A
<b>Д736</b>		<b>VOLVO</b>	<b>20740</b>

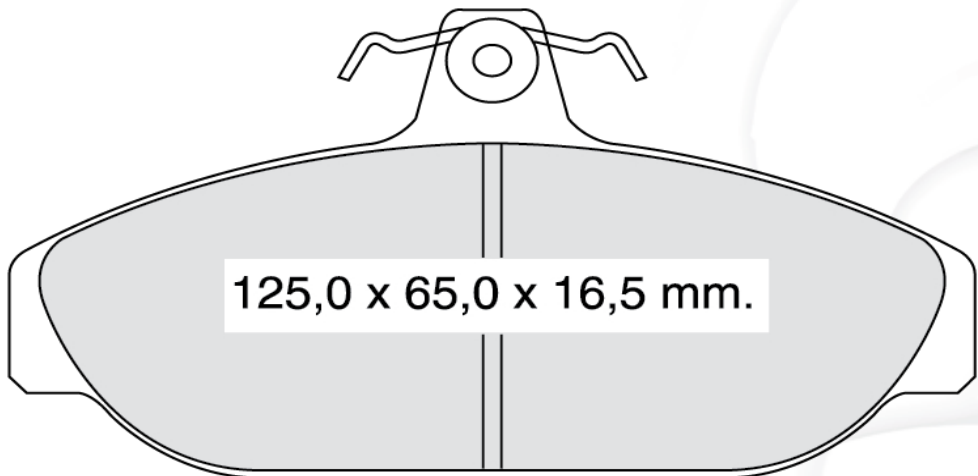

<b>Д739</b>		<b>VOLVO</b>	<b>21233</b>
-------------	--	--------------	--------------

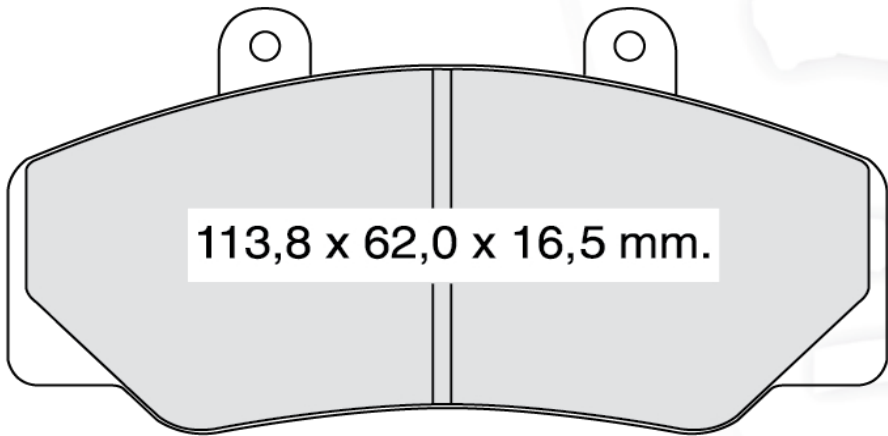

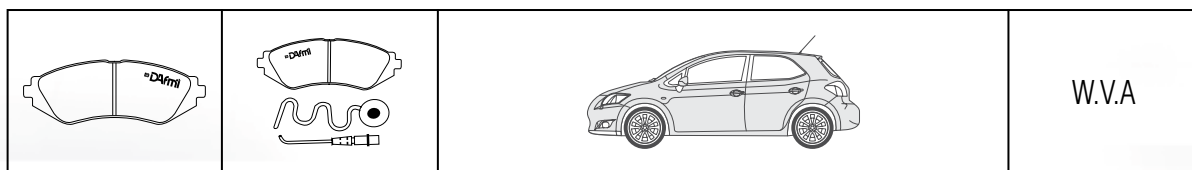

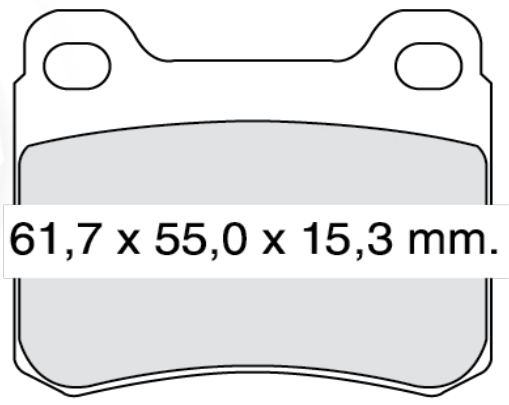

<b>Д741</b>		<b>MERCEDES-BENZ</b>	<b>20687</b>
-------------	--	----------------------	--------------



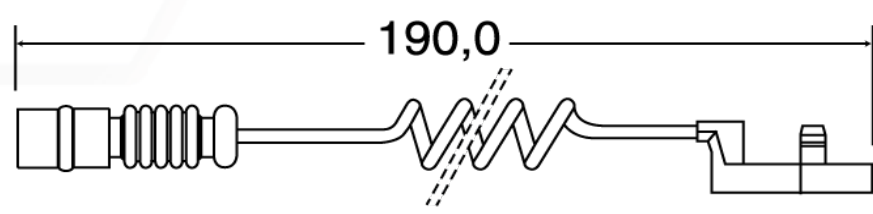
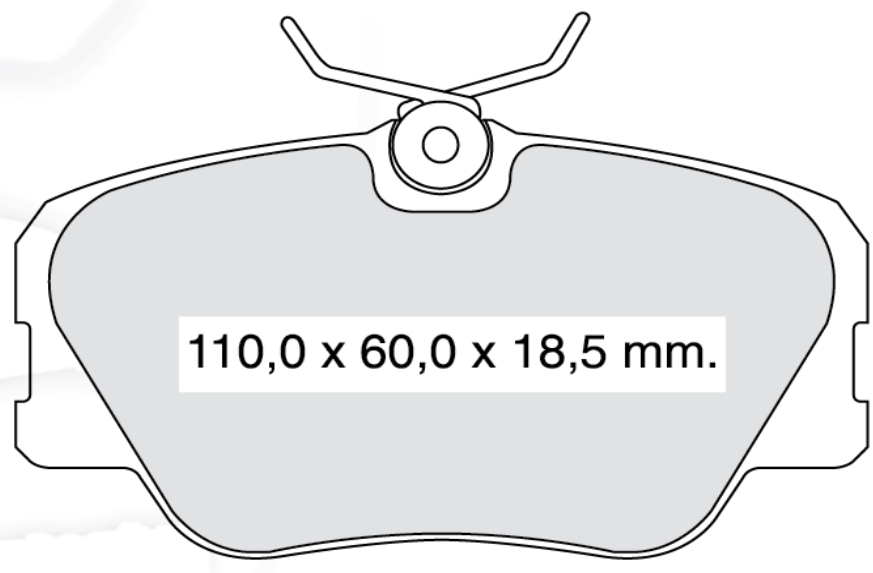

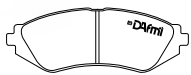
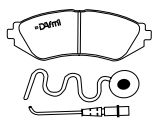
<b>Д742</b>	<b>Д742И</b>	<b>MERCEDES-BENZ</b>	<b>21028</b>
-------------	--------------	----------------------	--------------

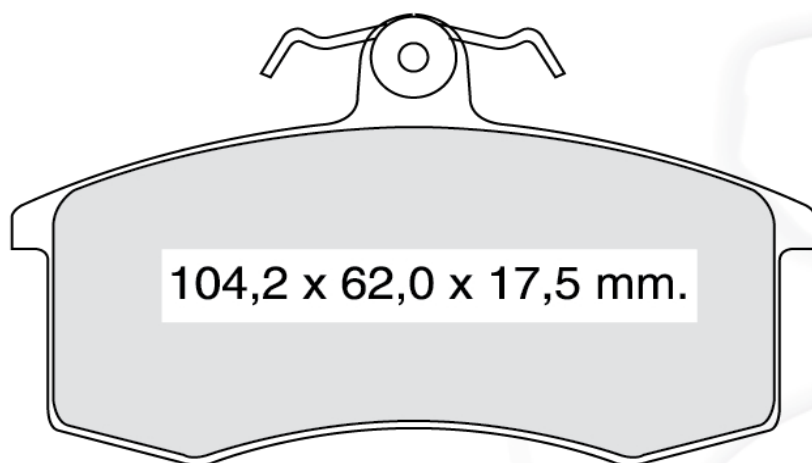

			W.V.A
<b>Д743</b>	<b>Д743И</b>	<b>ВАЗ</b>	<b>21170</b>

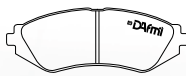
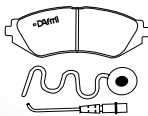



			W.V.A
---	---	--	-------

<b>Д744</b>		<b>PEUGEOT</b>	<b>21080</b>
-------------	--	----------------	--------------

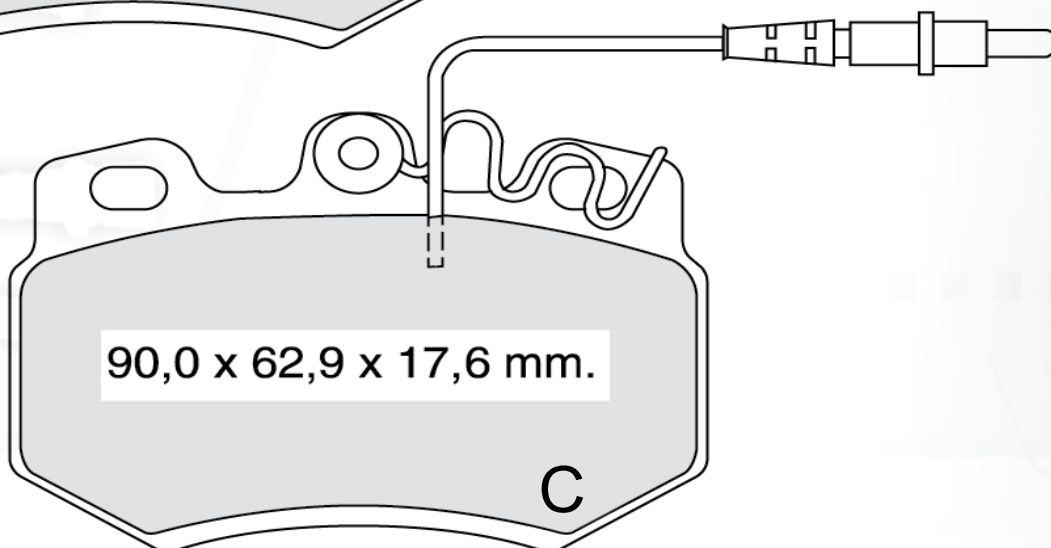
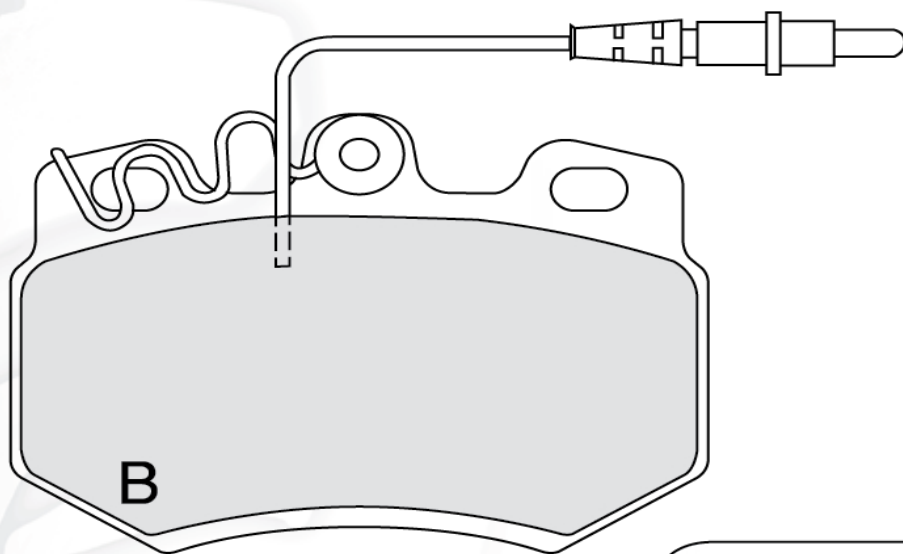
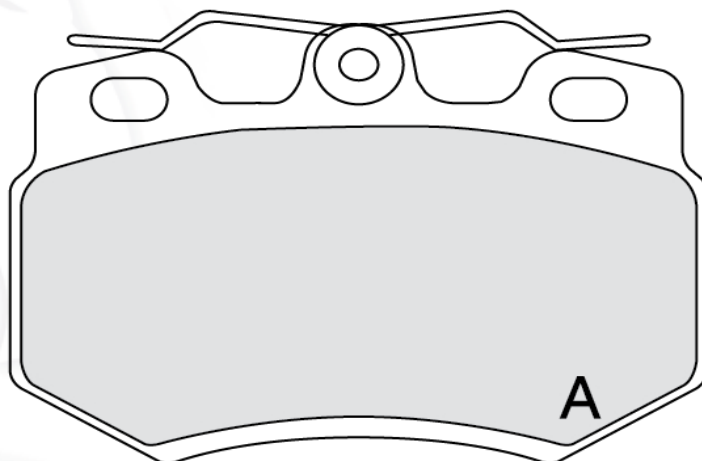
Индикатор износа входит в базовую комплектацию данной колодки.



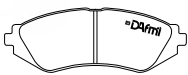
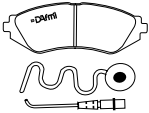

В комплект входят две колодки типа А,  
одна колодка типа В, одна колодка типа С

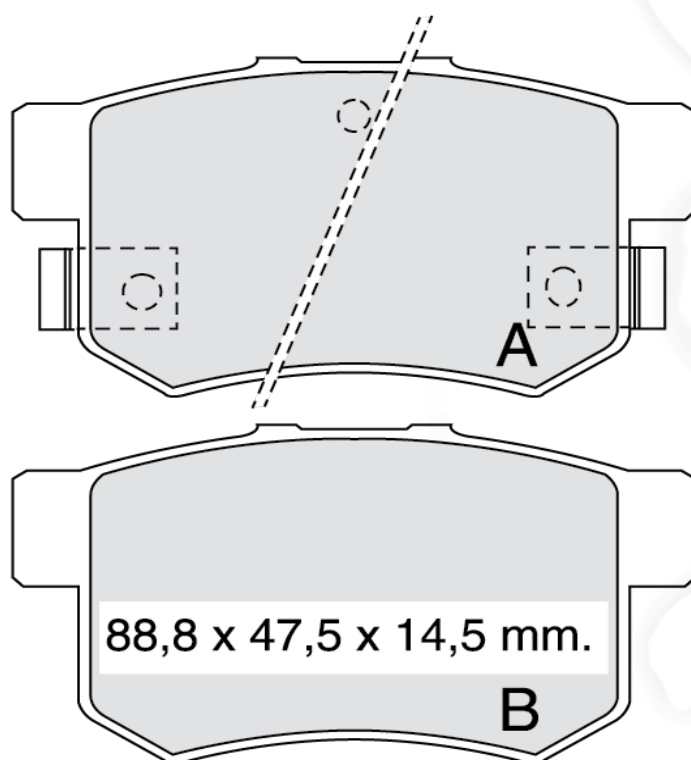
			W.V.A
<b>Д751</b>		<b>HONDA, ROVER</b>	<b>21719</b>
Индикатор износа входит в базовую комплектацию данной колодки.			

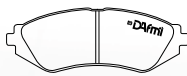
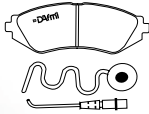

В комплект входят две колодки типа А, две колодки типа В

			W.V.A
<b>Д763</b>		<b>VOLKSWAGEN</b>	<b>20652</b>

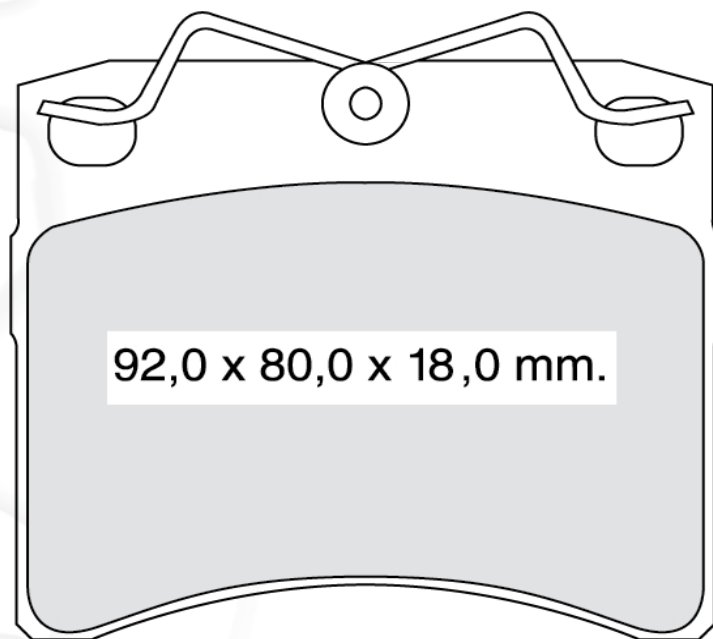



			W.V.A
<b>Д765</b>	<b>Д765И</b>	<b>BMW</b>	<b>20995</b>

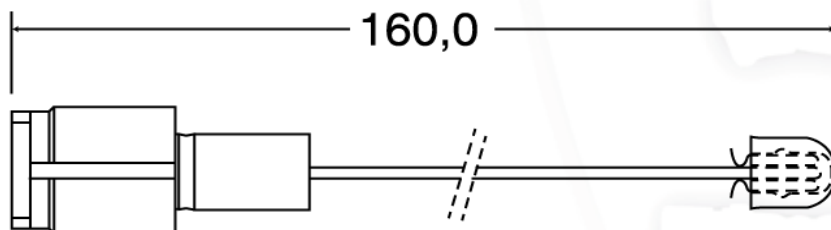
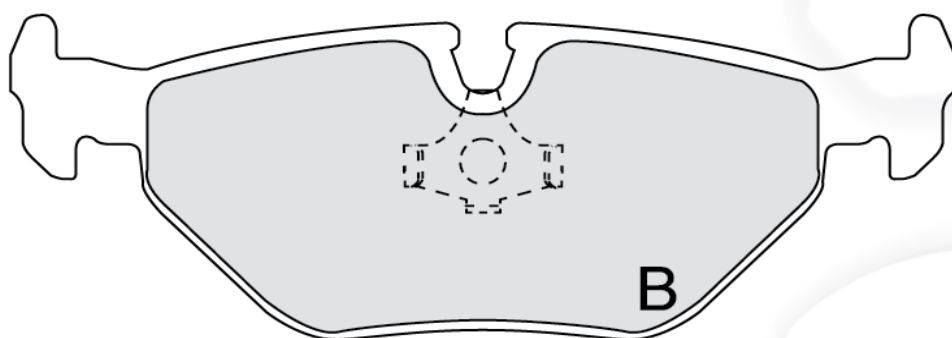
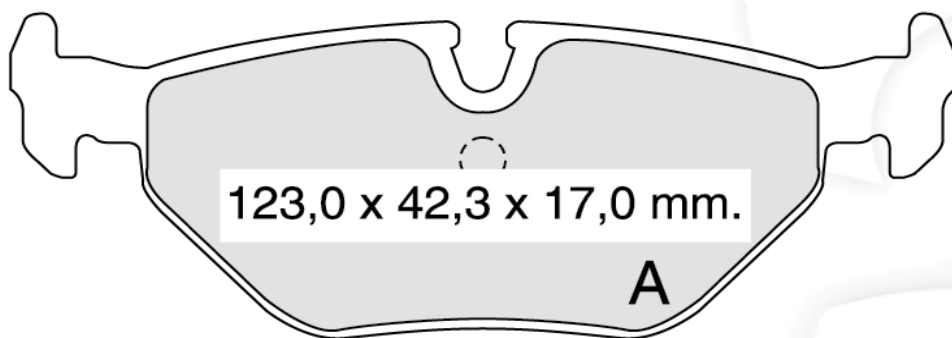

В комплект входят две колодки типа А, две колодки типа В

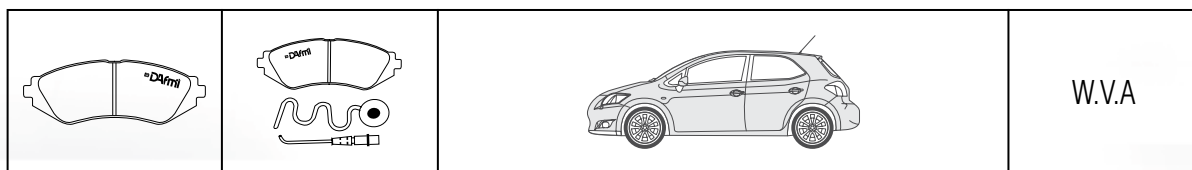

<b>Д774</b>		<b>MAZDA</b>	<b>21654</b>
-------------	--	--------------	--------------

Индикатор износа входит в базовую комплектацию данной колодки.

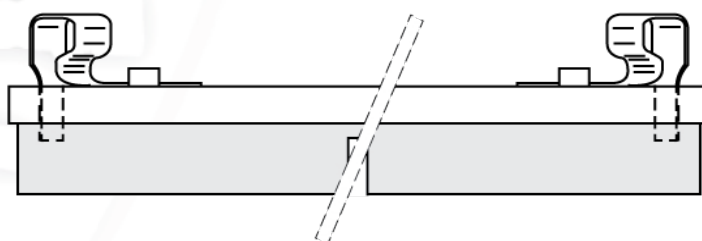
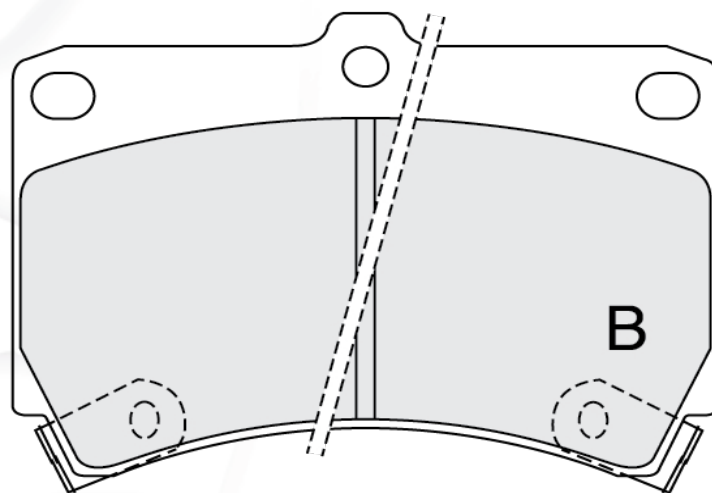
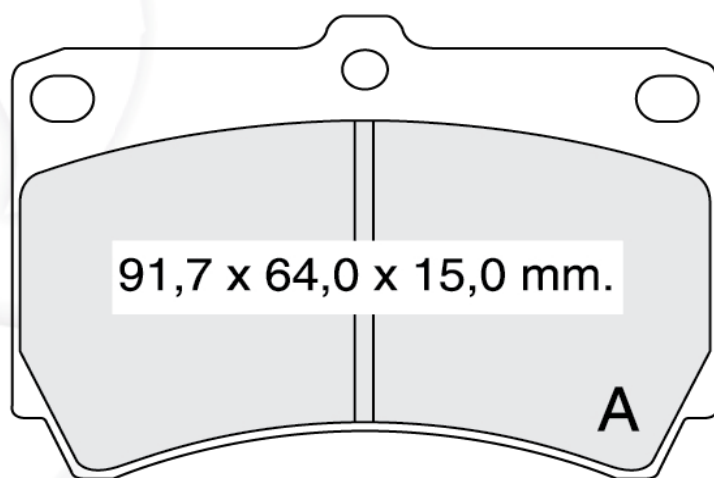

В комплект входят две колодки типа А, две колодки типа В

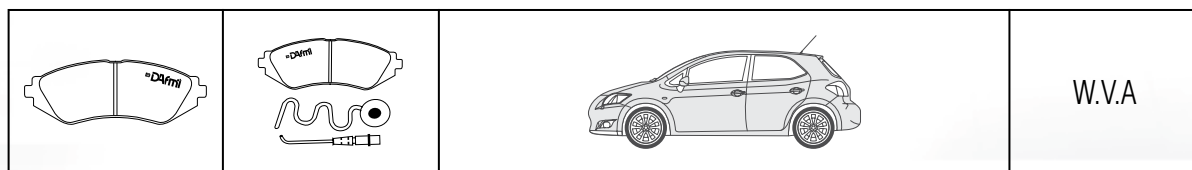

<b>Д780</b>		<b>МITSUBISHI</b>	<b>21363</b>
-------------	--	-------------------	--------------

Индикатор износа входит в базовую комплектацию данной колодки.

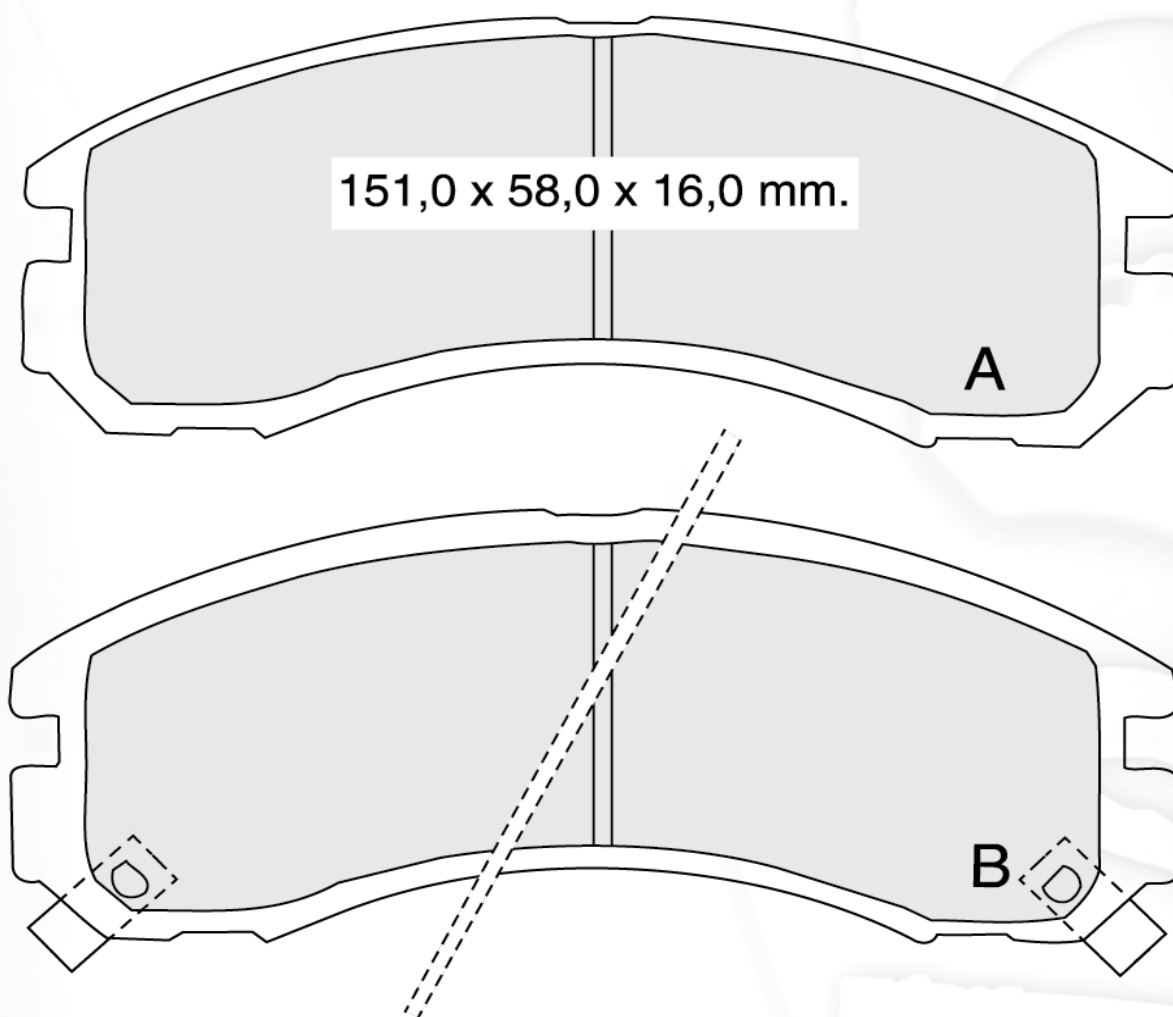

В комплект входят две колодки типа А, две колодки типа В

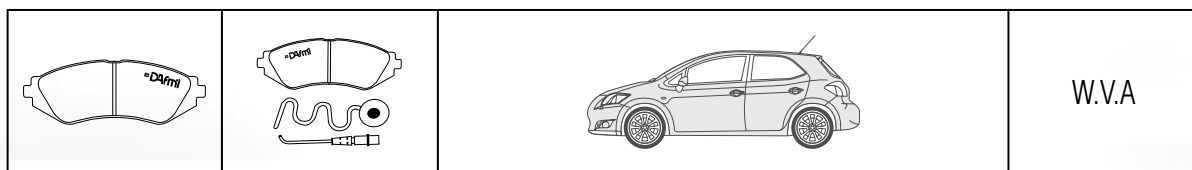

<b>Д784</b>		<b>VOLVO</b>	<b>20200</b>
-------------	--	--------------	--------------

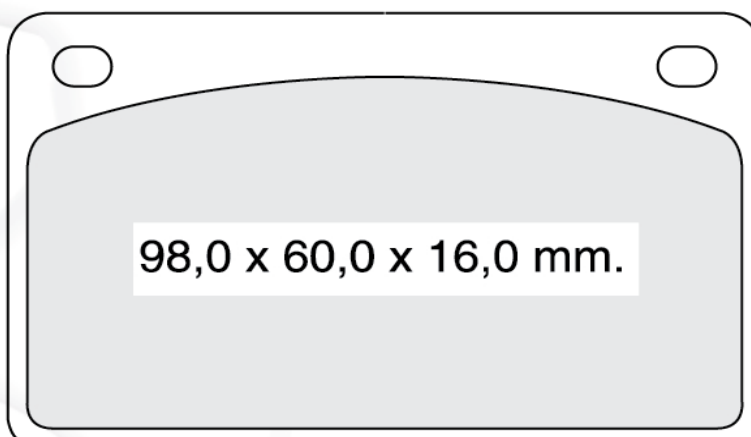



			W.V.A
--	--	--	-------

<b>Д785</b>		<b>FORD</b>	<b>20909</b>
-------------	--	-------------	--------------

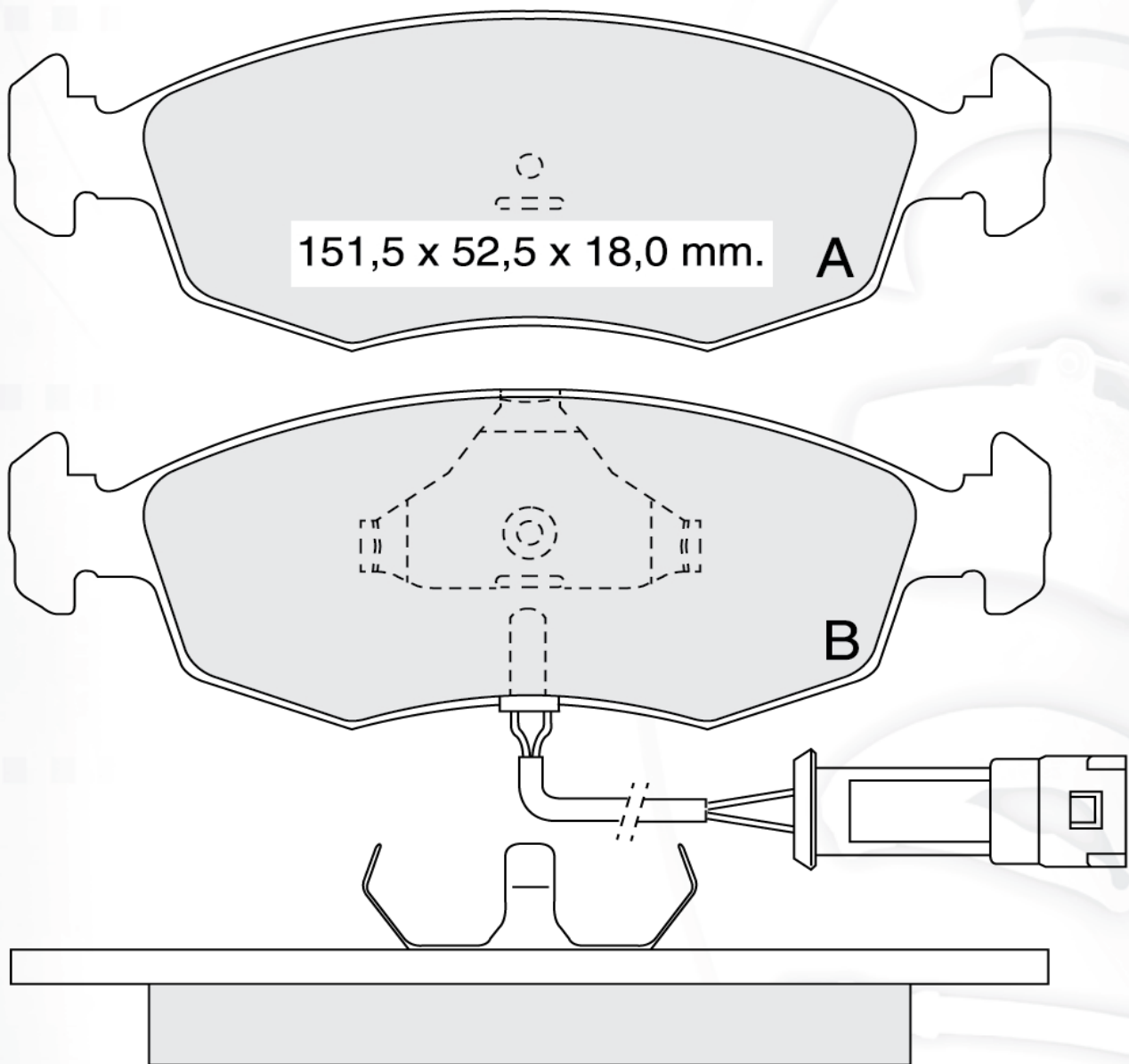
Индикатор износа входит в базовую комплектацию данной колодки.

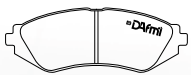
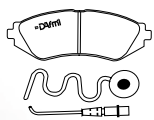

В комплект входят две колодки типа А, две колодки типа В

			W.V.A
<b>Д789</b>		<b>FORD</b>	<b>20907</b>

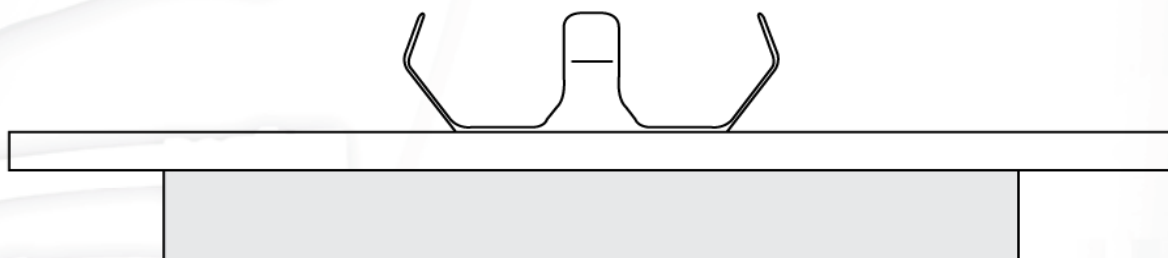
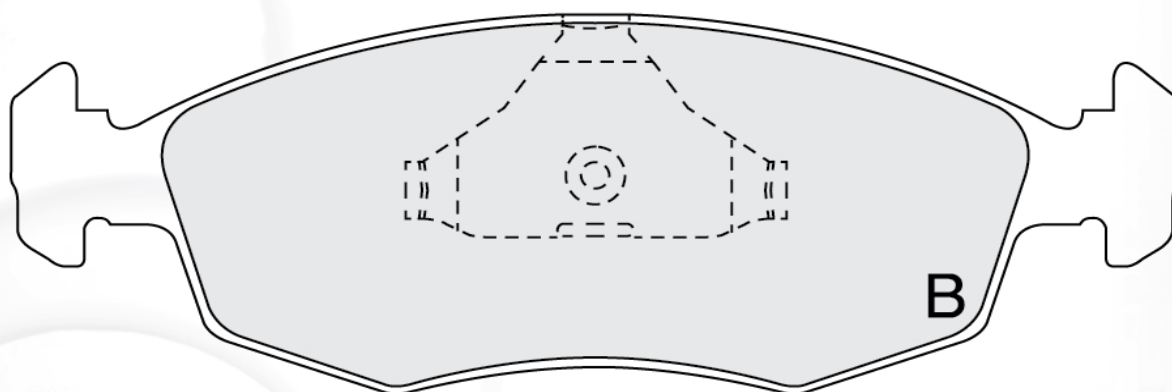
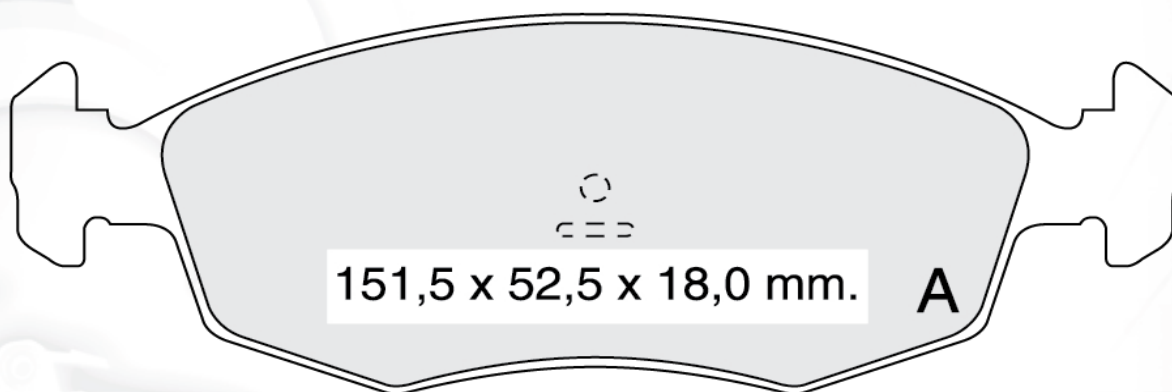

В комплект входят две колодки типа А, две колодки типа В

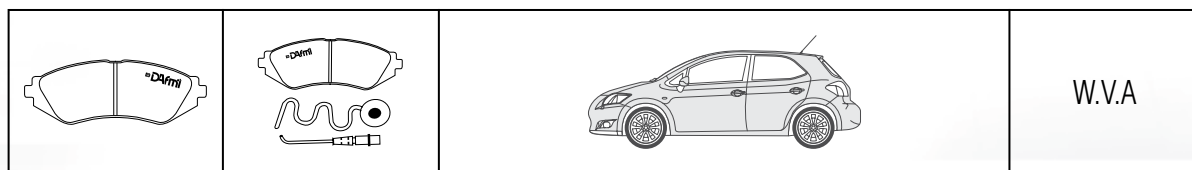

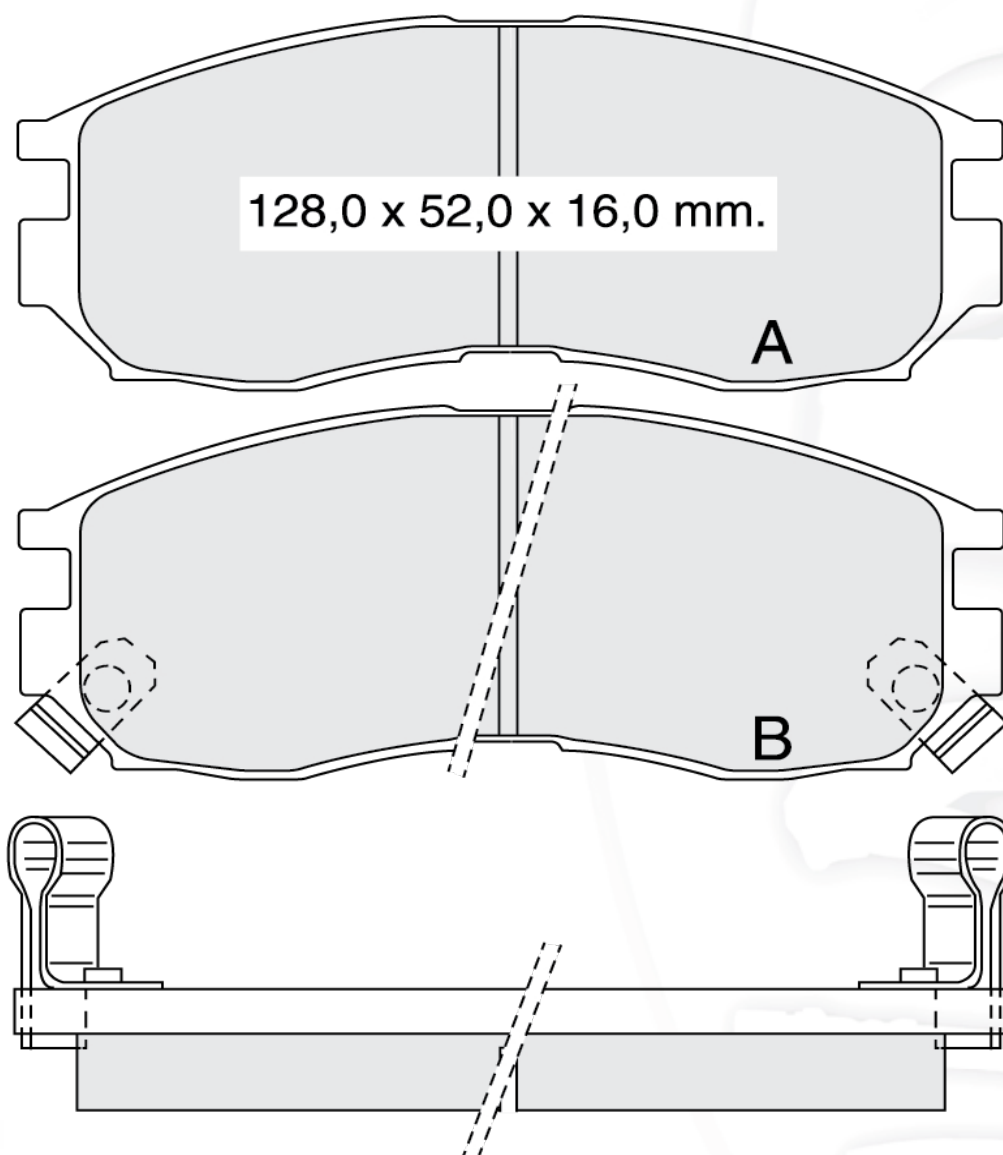

<b>Д791</b>		<b>МITSUBISHI</b>	<b>21647</b>
-------------	--	-------------------	--------------

Индикатор износа входит в базовую комплектацию данной колодки.

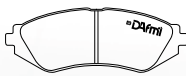
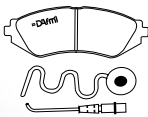

В комплект входят две колодки типа А, две колодки типа В

			W.V.A
---	---	--	-------

	<b>Д792И</b>	<b>ALFA ROMEO, FIAT</b>	<b>21182</b>
--	--------------	-------------------------	--------------

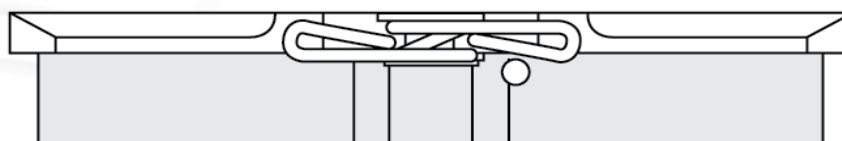
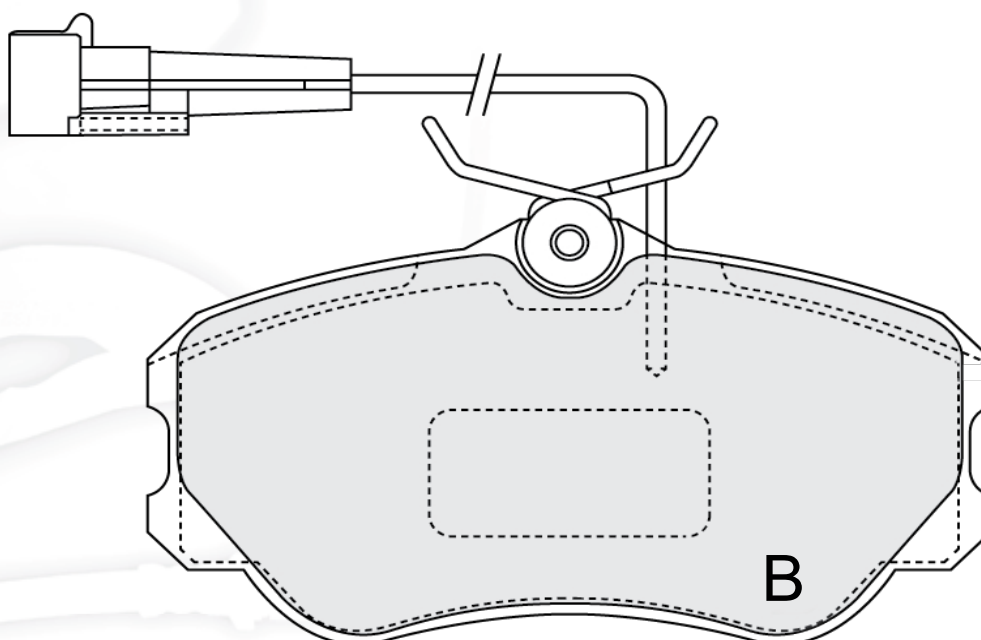
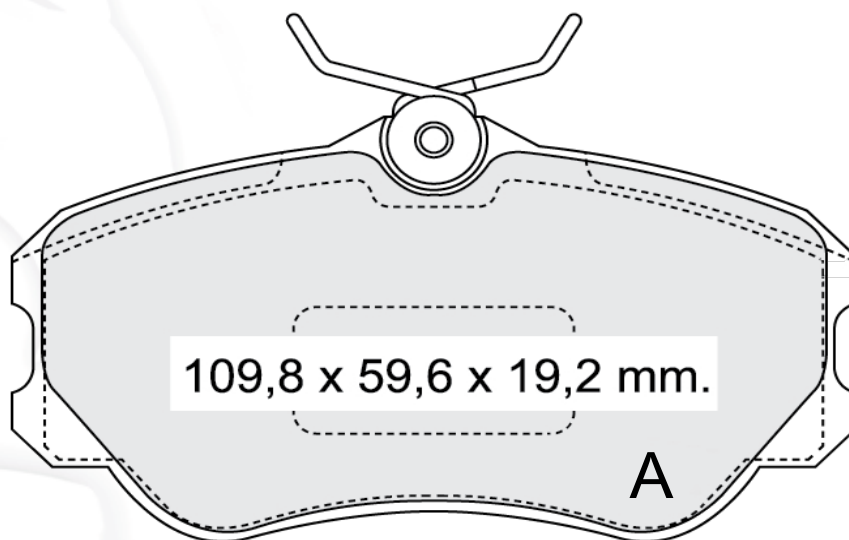

В комплект входят две колодки типа А, две колодки типа В



			W.V.A
--	--	--	-------

<b>Д805</b>		<b>KIA</b>	<b>21892</b>
-------------	--	------------	--------------

Индикатор износа входит в базовую комплектацию данной колодки

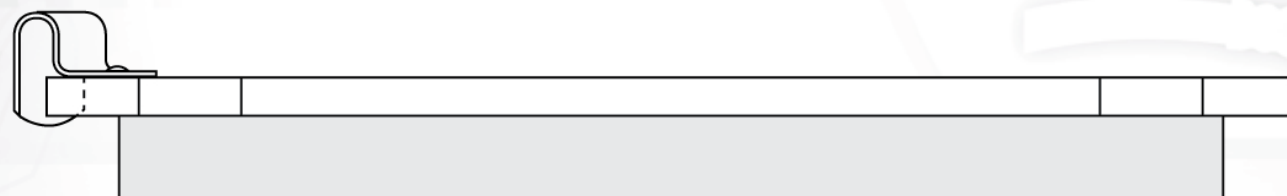
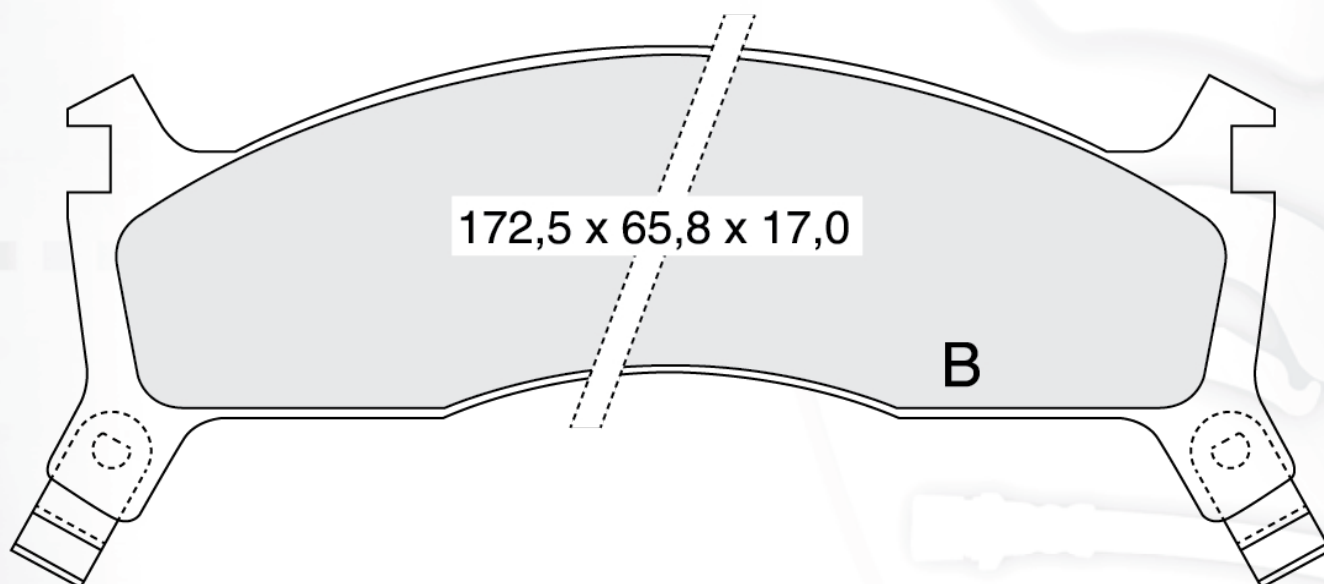
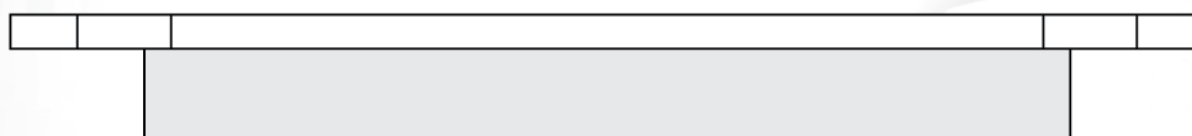
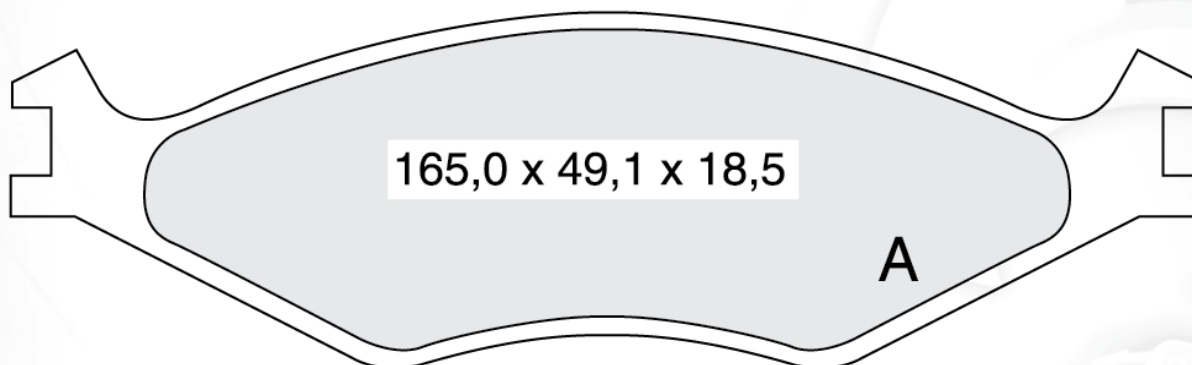

В комплект входят две колодки типа А, две колодки типа В

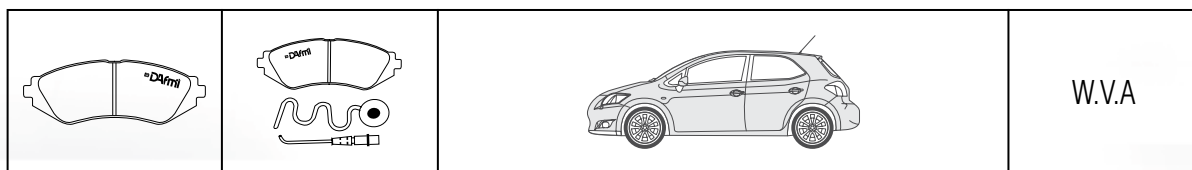

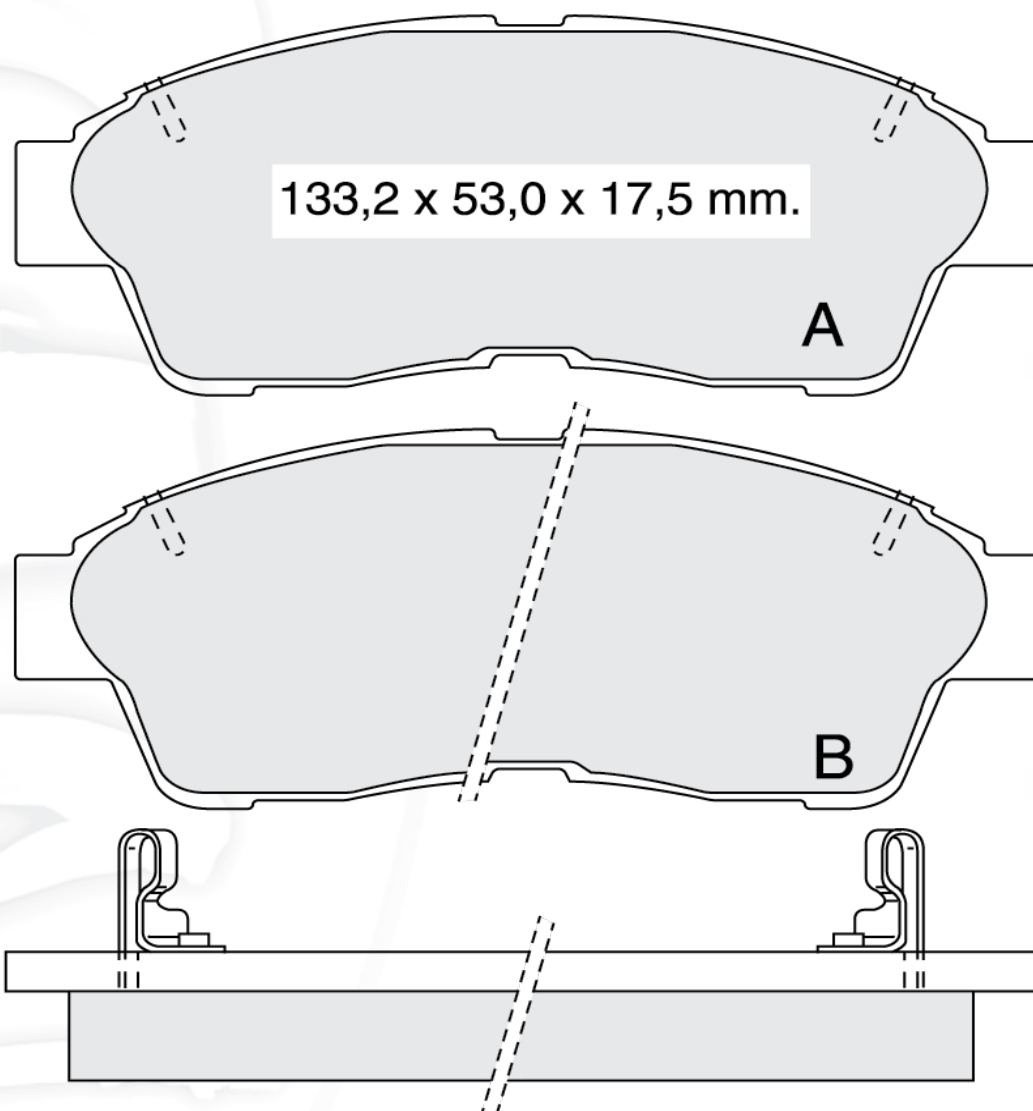

<b>Д816</b>		<b>TOYOTA</b>	<b>21601</b>
-------------	--	---------------	--------------

Индикатор износа входит в базовую комплектацию данной колодки.

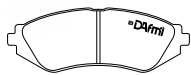
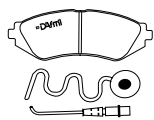

В комплект входят две колодки типа А, две колодки типа В

			W.V.A
<b>Д819</b>		<b>VOLVO</b>	<b>20163</b>

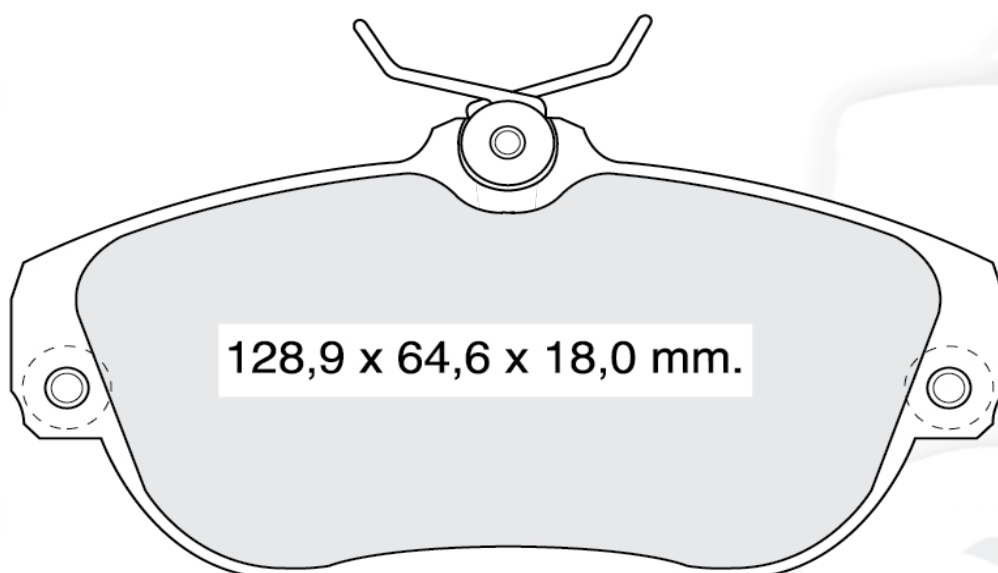

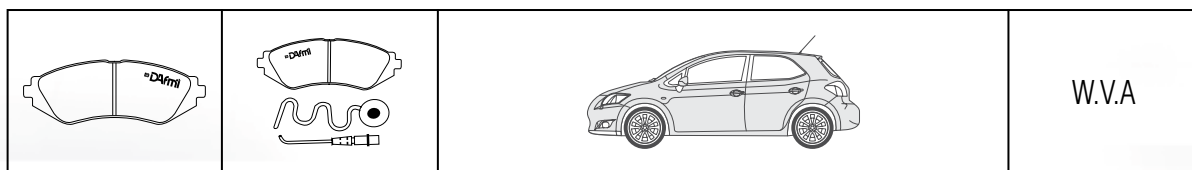

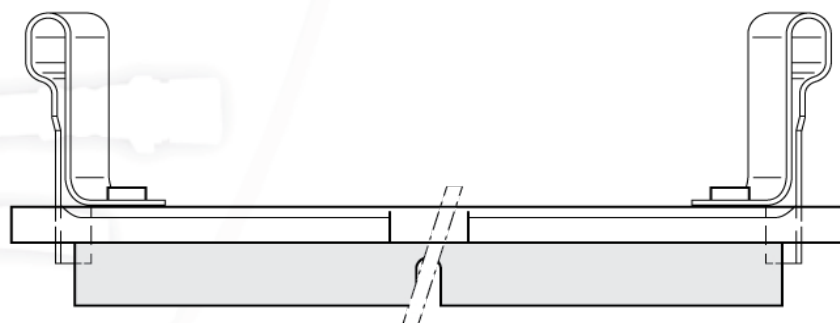
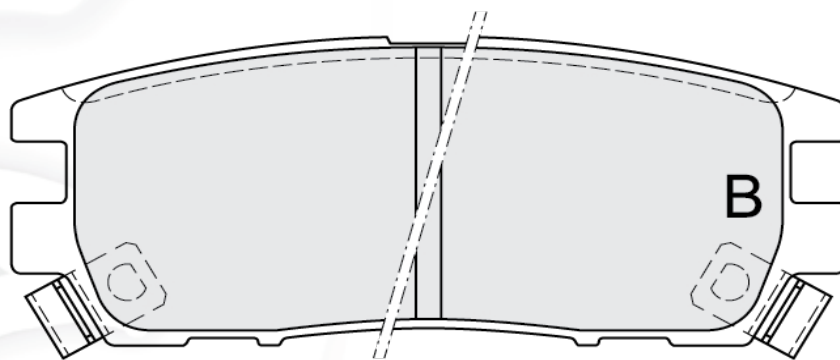
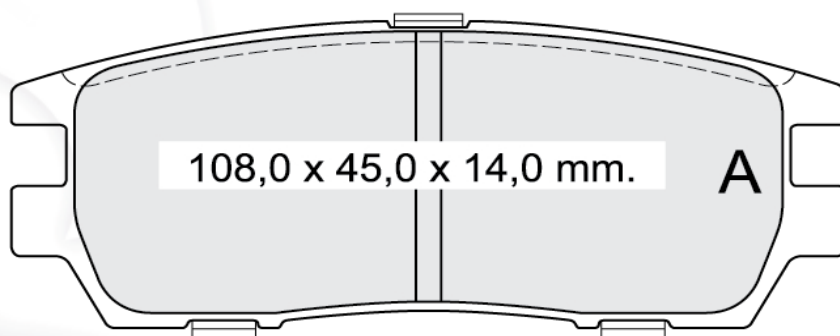

<b>Д821</b>		<b>МITSUBISHI</b>	<b>21840</b>
-------------	--	-------------------	--------------

Индикатор износа входит в базовую комплектацию данной колодки.

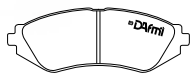
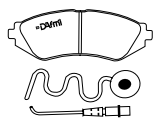

В комплект входят две колодки типа А, две колодки типа В

			W.V.A
<b>Д837</b>	<b>Д837И</b>	<b>FORD</b>	<b>21470</b>

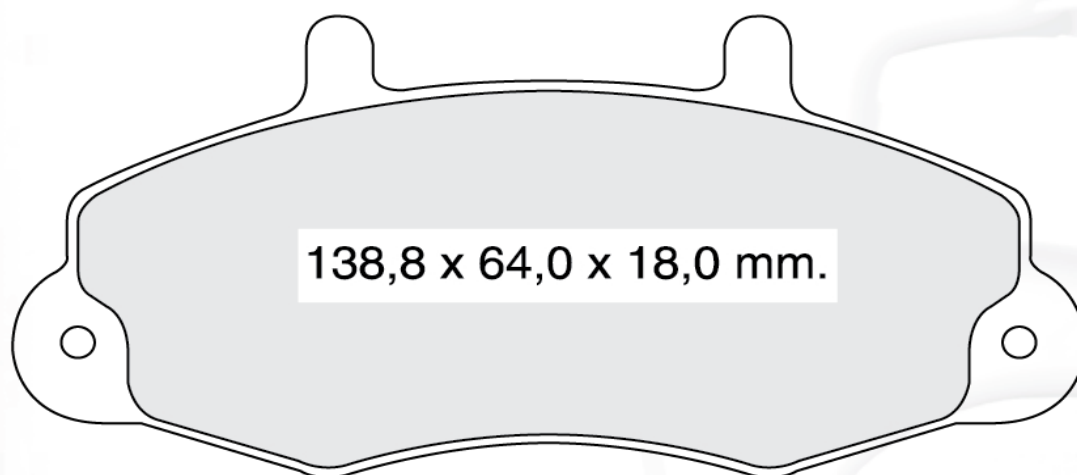

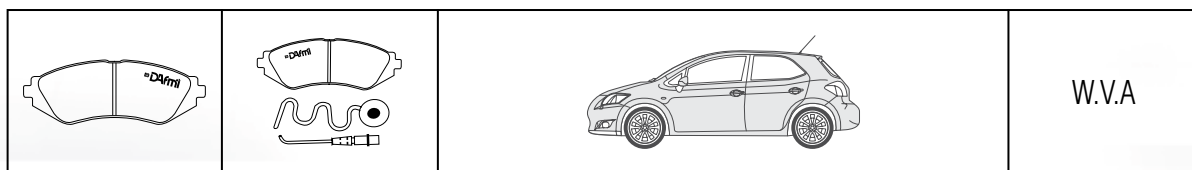

<b>Д840</b>		<b>NISSAN</b>	<b>21657</b>
-------------	--	---------------	--------------

Индикатор износа входит в базовую комплектацию данной колодки.

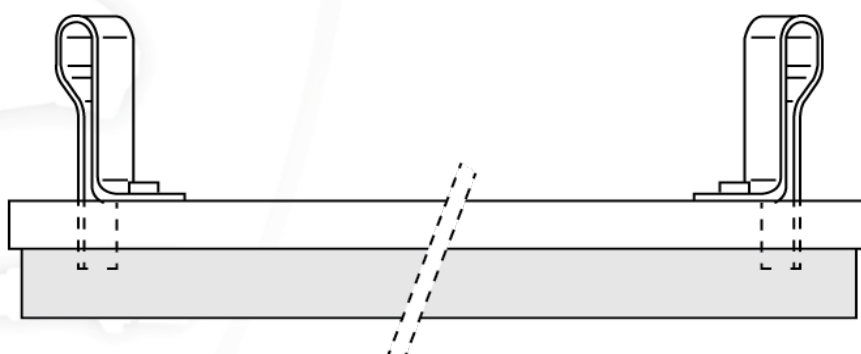
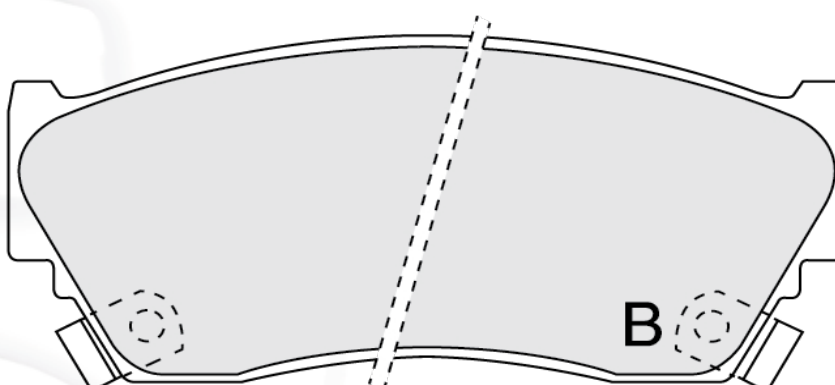
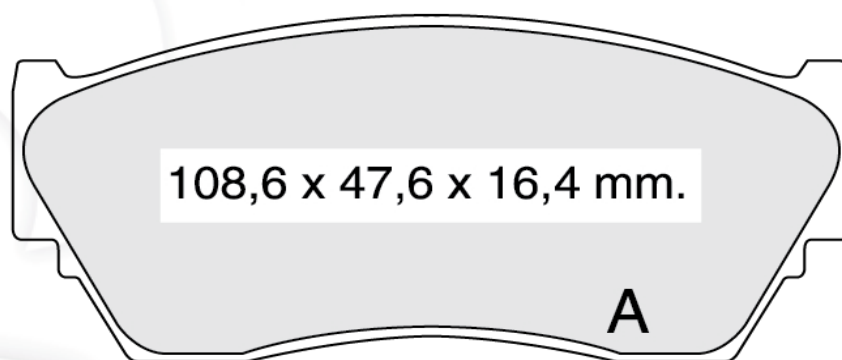

В комплект входят две колодки типа А, две колодки типа В

			W.V.A
<b>Д864</b>	<b>Д864И</b>	<b>FORD</b>	<b>21469</b>

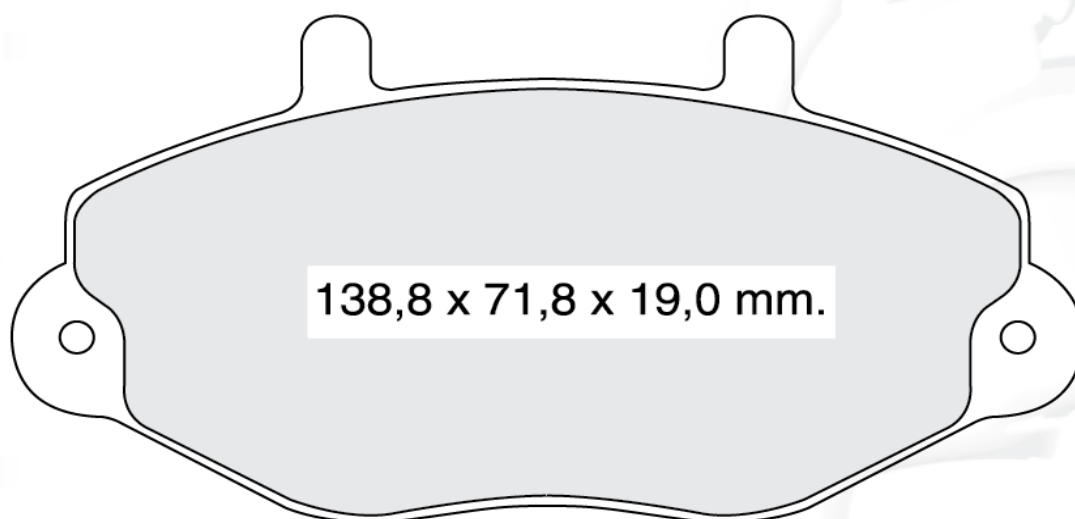

<b>Д866</b>		<b>ISUZU, OPEL</b>	<b>21543</b>
Индикатор износа входит в базовую комплектацию данной колодки.			

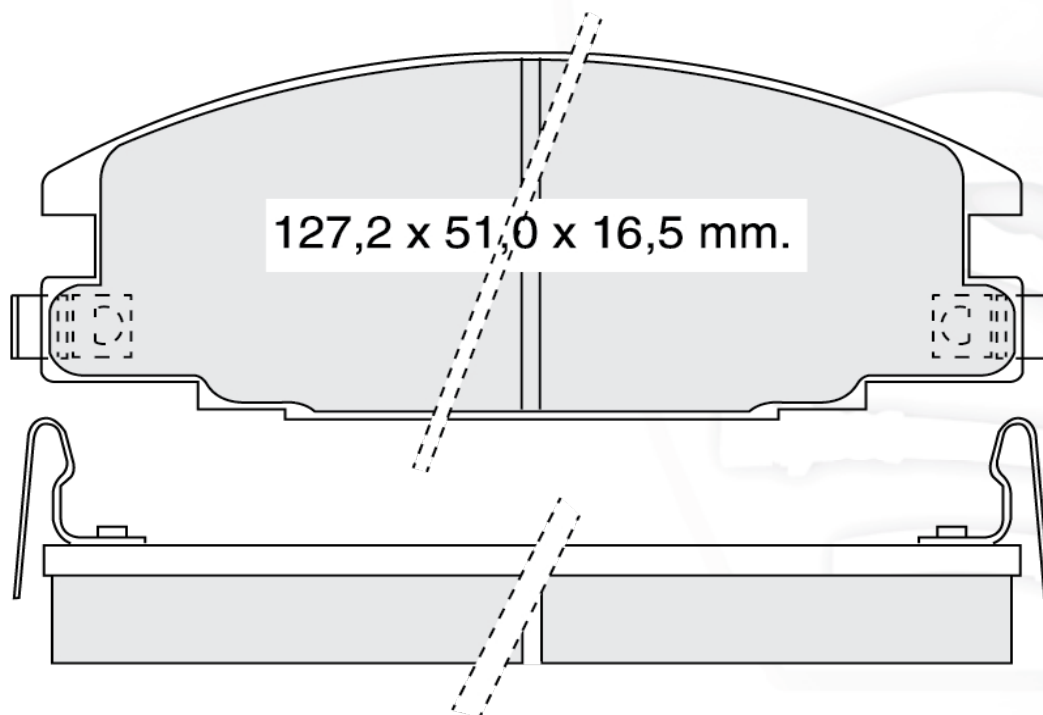

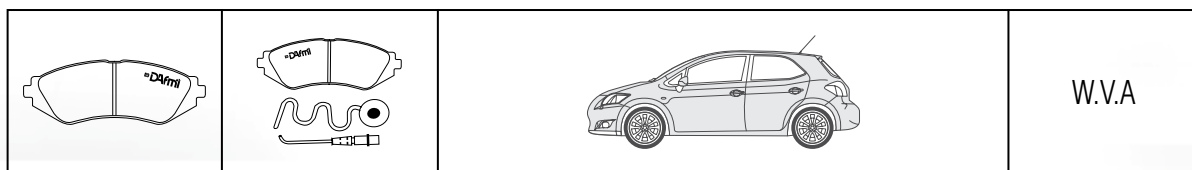

<b>Д872</b>		<b>HONDA</b>	<b>21697</b>
-------------	--	--------------	--------------

Индикатор износа входит в базовую комплектацию данной колодки.

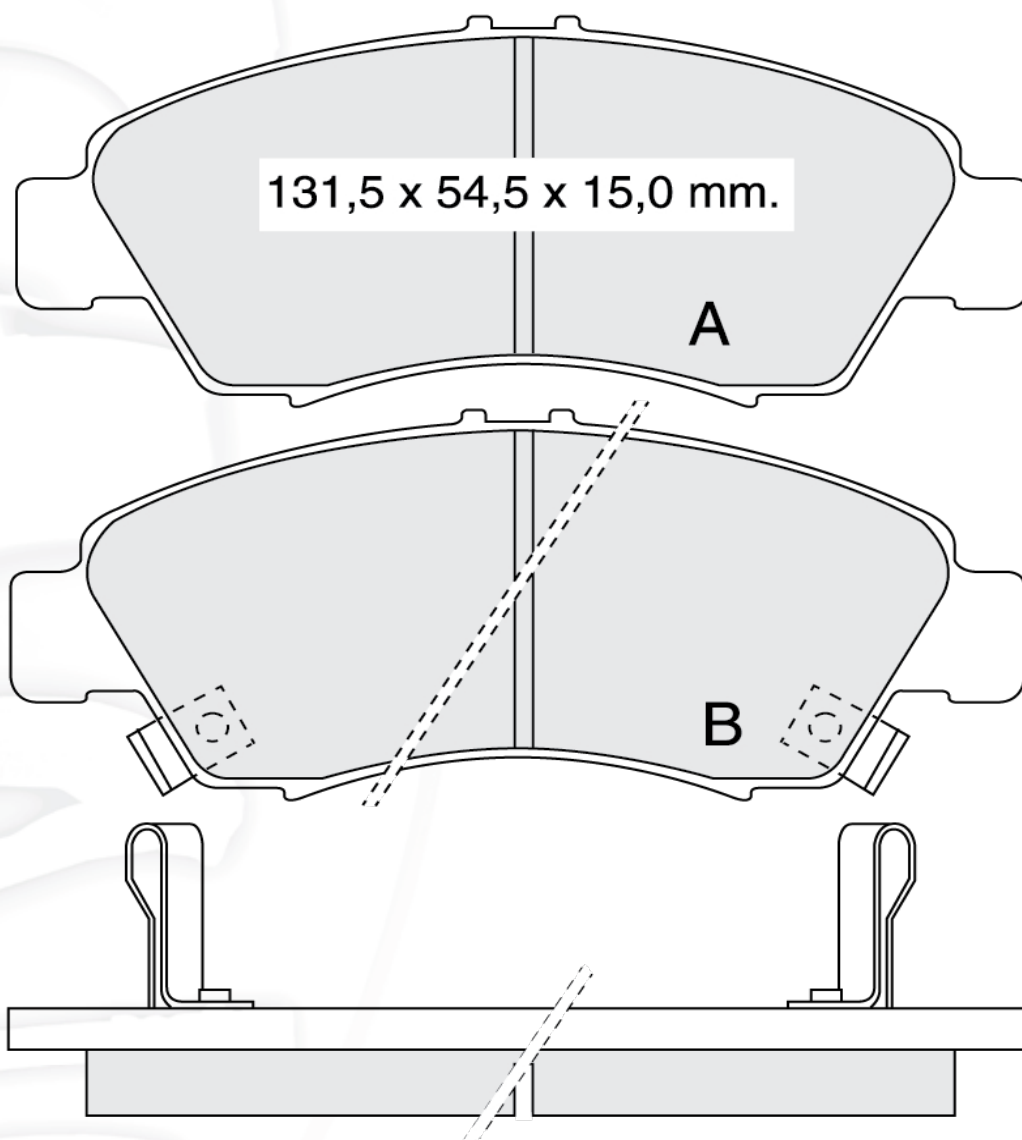

В комплект входят две колодки типа А, две колодки типа В



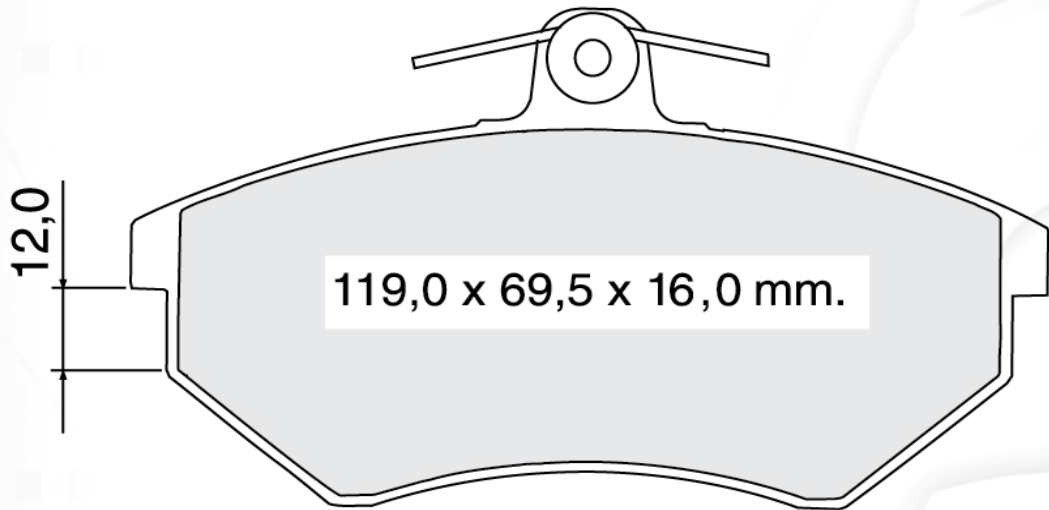

			W.V.A
--	--	--	-------

<b>Д884</b>		<b>SEAT, VOLKSWAGEN</b>	<b>20168</b>
-------------	--	-------------------------	--------------

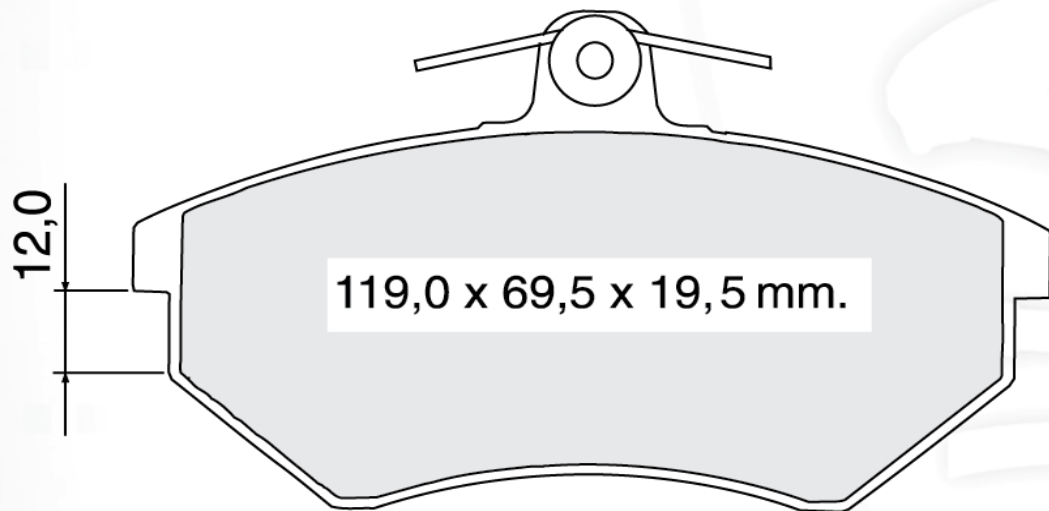

<b>Д885</b>		<b>SEAT, VOLKSWAGEN</b>	<b>20168</b>
-------------	--	-------------------------	--------------

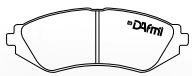
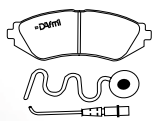

			W.V.A
	<b>Д890И</b>	<b>HONDA, ROVER</b>	<b>21879</b>

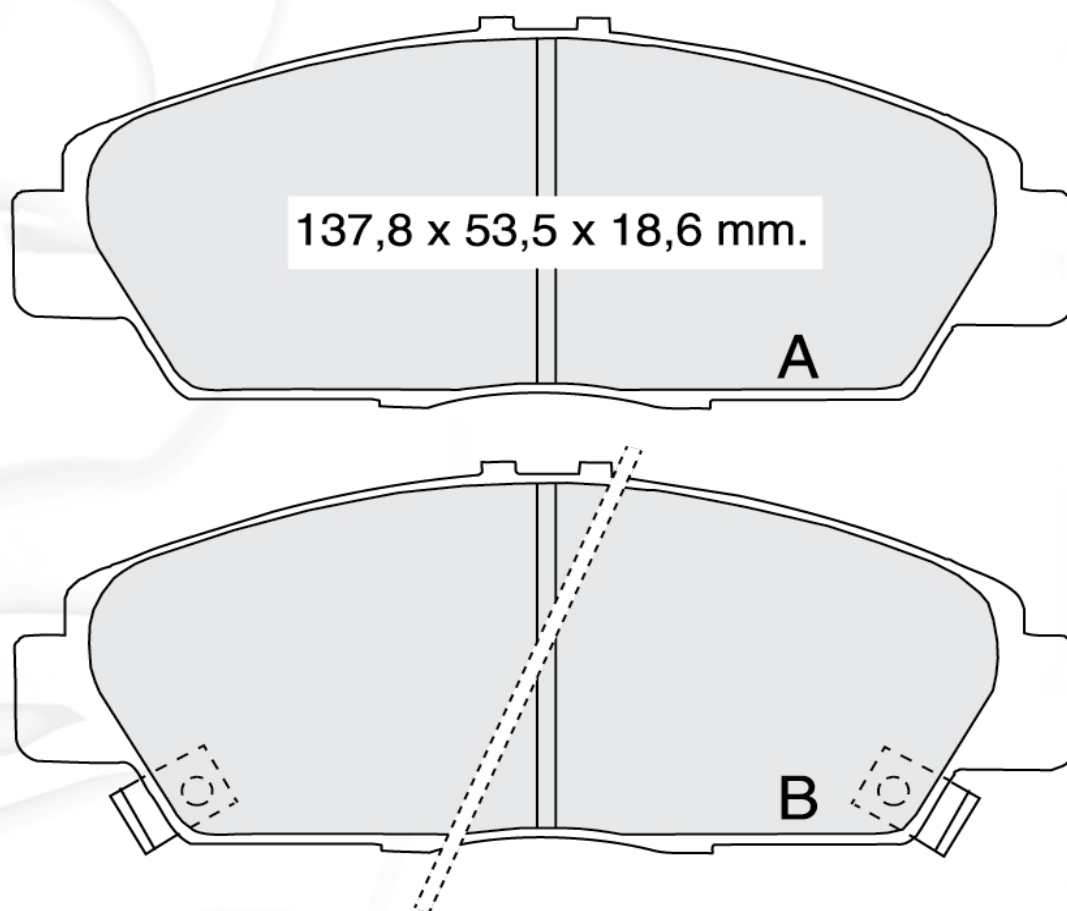

В комплект входят две колодки типа А, две колодки типа В



			W.V.A
--	--	--	-------

<b>Д897</b>		<b>TOYOTA</b>	<b>21975</b>
-------------	--	---------------	--------------

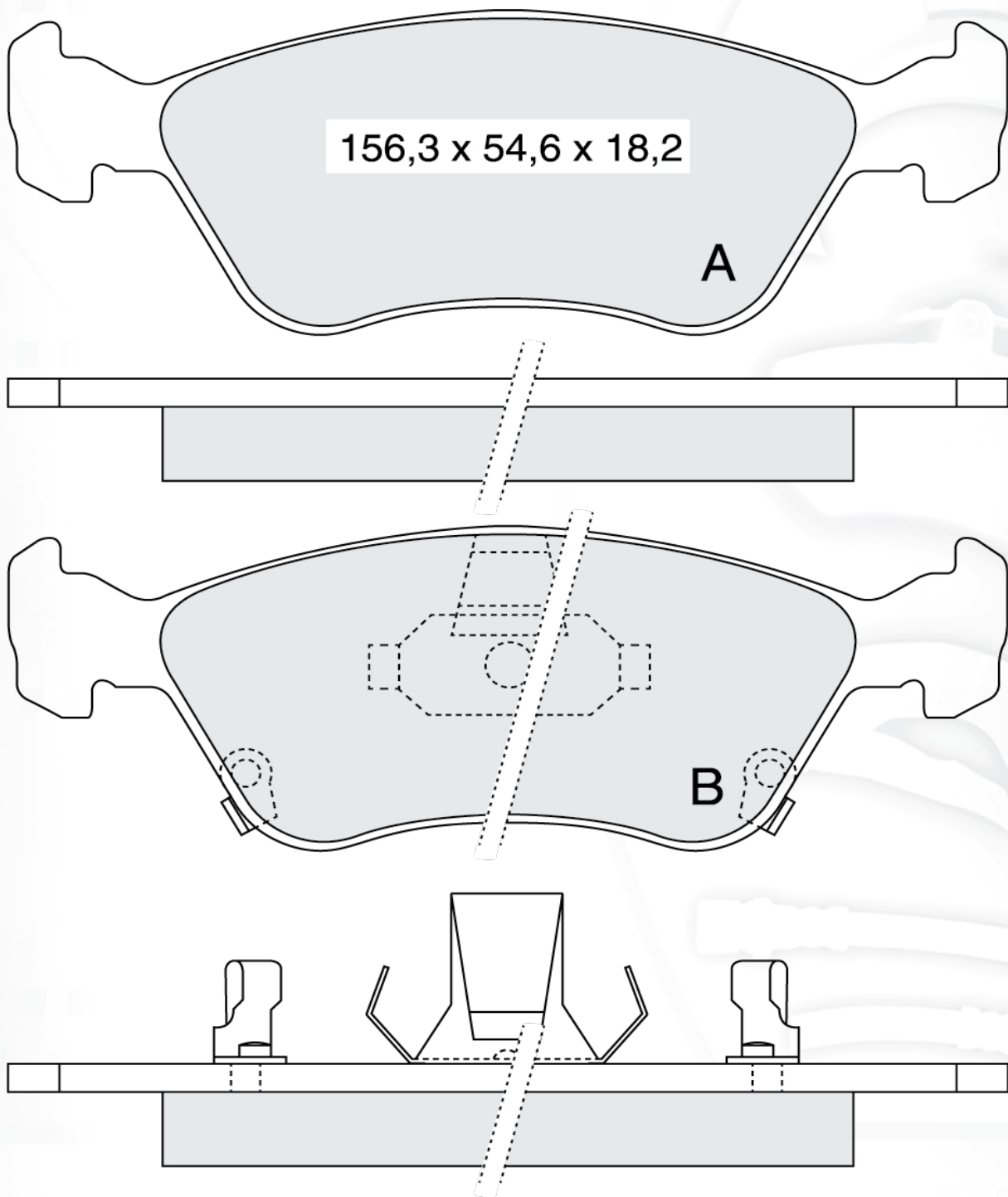
Индикатор износа входит в базовую комплектацию данной колодки.

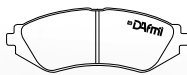
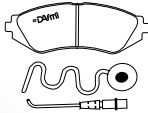

В комплект входят две колодки типа А, две колодки типа В

			W.V.A
---	---	--	-------

<b>Д916</b>		<b>FORD</b>	<b>21396</b>
-------------	--	-------------	--------------

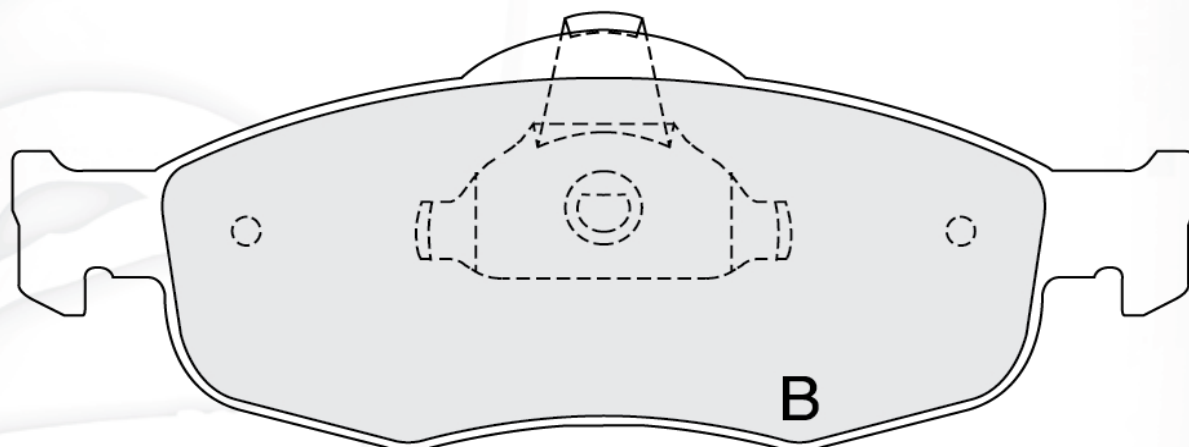
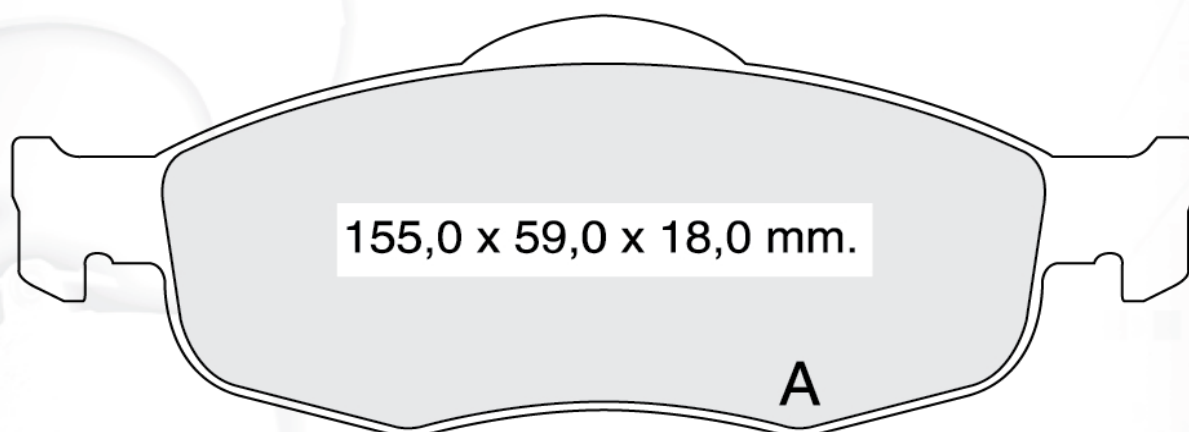

В комплект входят две колодки типа А, две колодки типа В

			W.V.A
--	--	--	-------

<b>Д926</b>		<b>RENAULT</b>	<b>20916</b>
-------------	--	----------------	--------------

Индикатор износа входит в базовую комплектацию данной колодки.

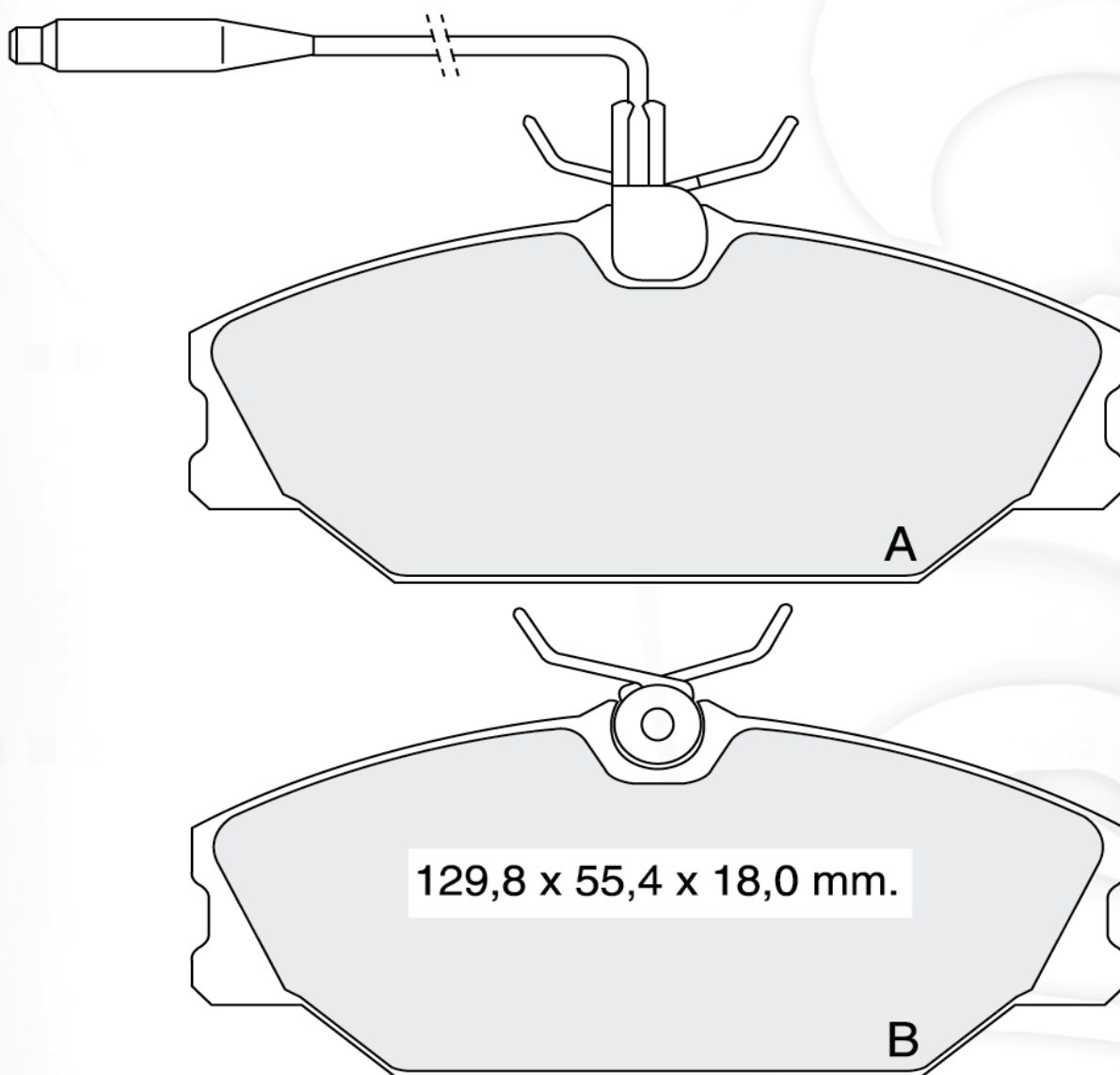

В комплект входят две колодки типа А, две колодки типа В

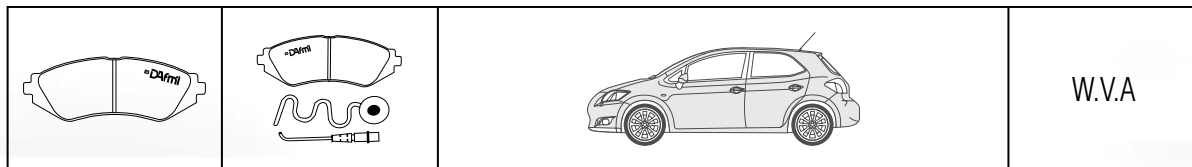



<b>Д930</b>		<b>FORD</b>	<b>21395</b>
-------------	--	-------------	--------------

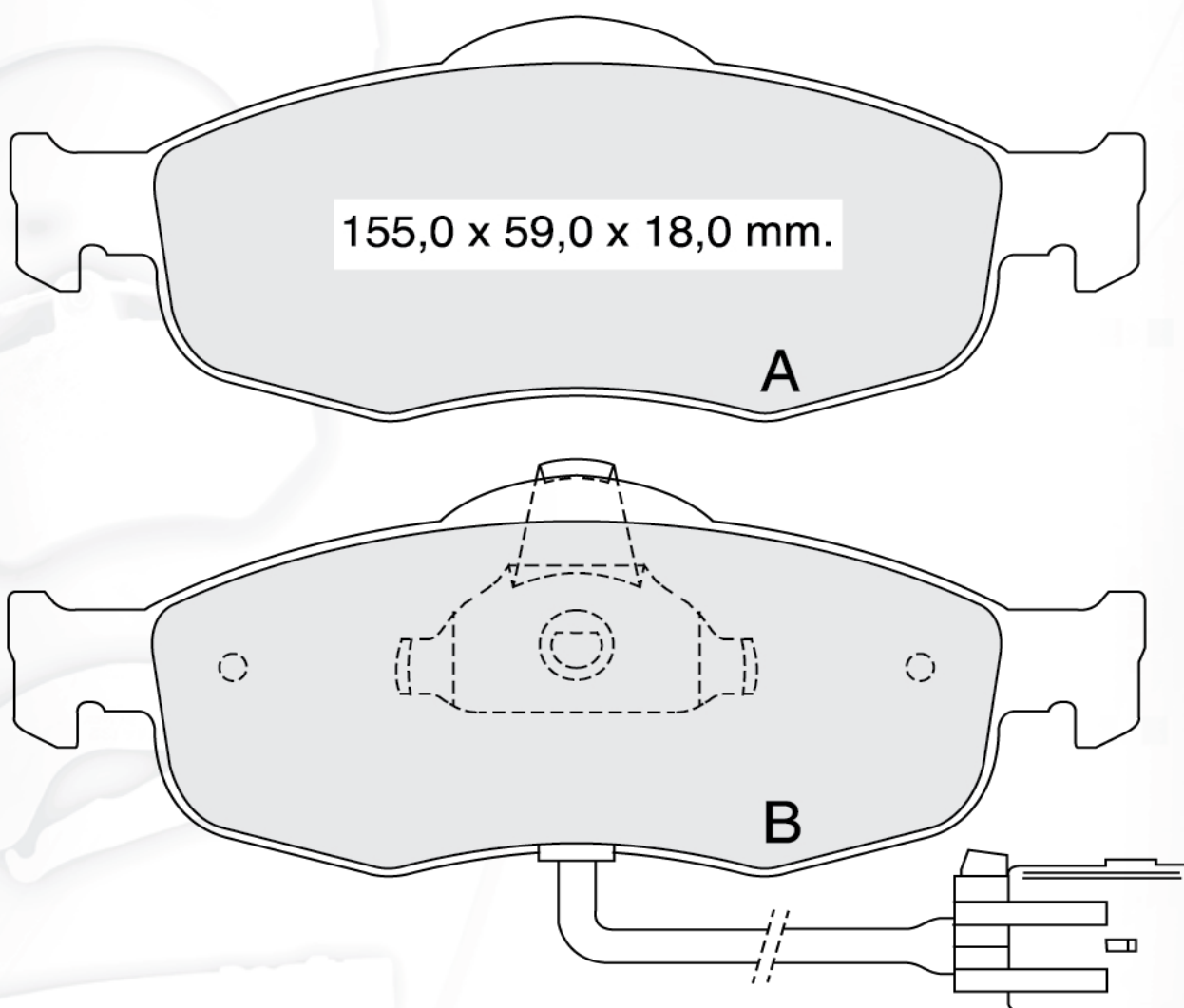

Индикатор износа входит в базовую комплектацию данной колодки.

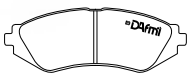
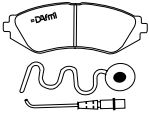

В комплект входят две колодки типа А, две колодки типа В

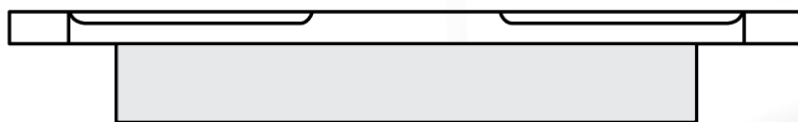
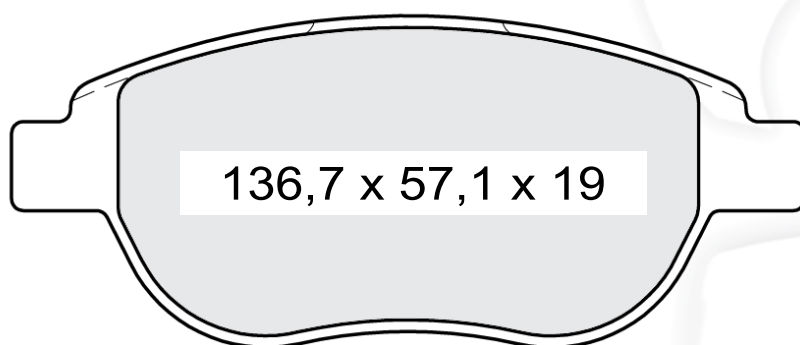
			<p>W.V.A</p>
<p><b>Д934</b></p>		<p><b>CITROEN PEUGEOT</b></p>	<p>23600</p>

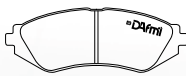
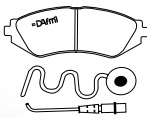

			W.V.A
---	---	--	-------

<b>Д937</b>	<b>Д937И</b>	<b>MERCEDES-BENZ</b>	<b>21439</b>
-------------	--------------	----------------------	--------------

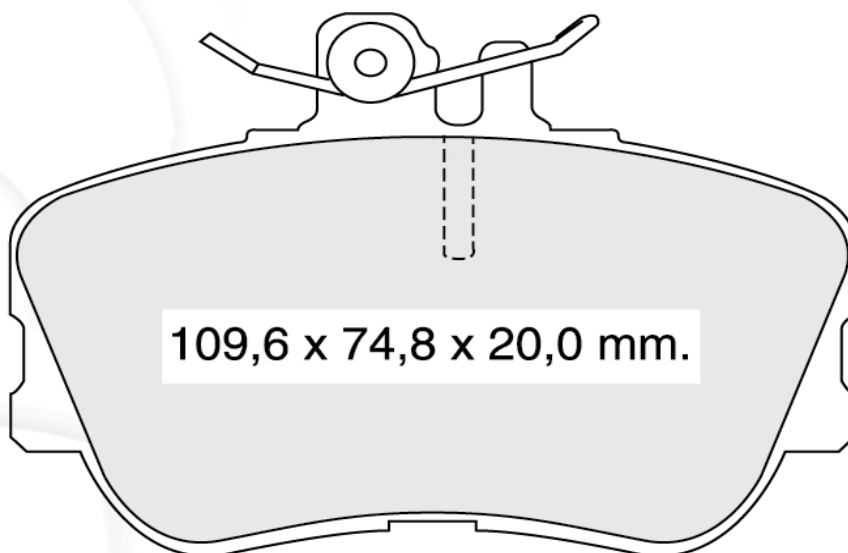

<b>Д938</b>		<b>ALFA ROMEO, FIAT, LANCIA</b>	<b>21103</b>
-------------	--	---------------------------------	--------------

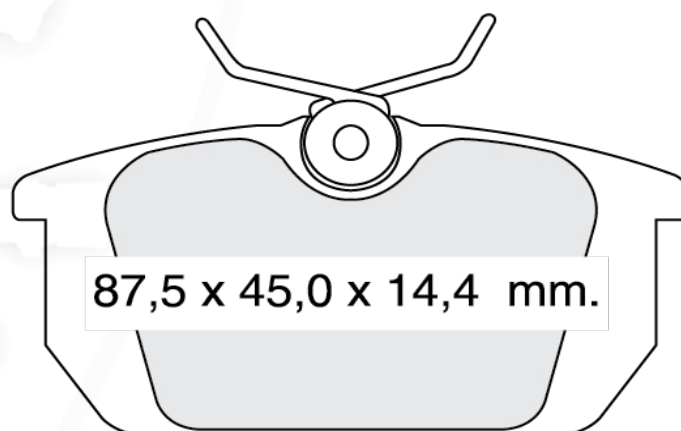



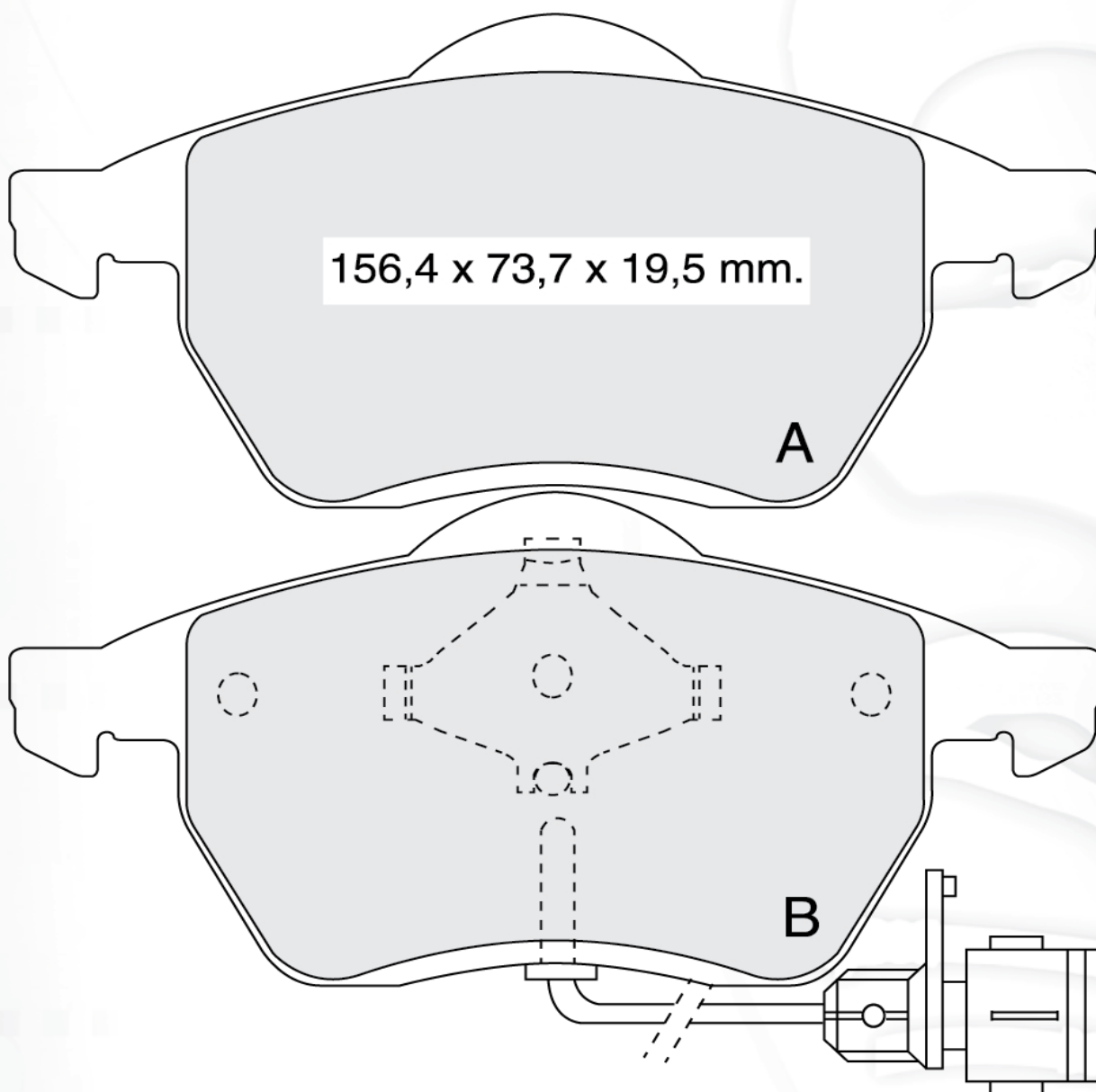

			W.V.A
<b>Д957</b>	<b>Д957И</b>	<b>AUDI, VOLKSWAGEN</b>	<b>20676</b>
Индикаторы износа (2 шт.) входят только в Д957И.			

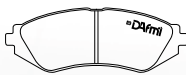
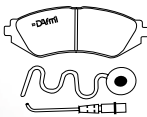

В комплект входят две колодки типа А, две колодки типа В

			W.V.A
---	---	--	-------

	Д957И2 Д957И3	AUDI, VOLKSWAGEN, SKODA	20676 23392
--	------------------	-------------------------	----------------

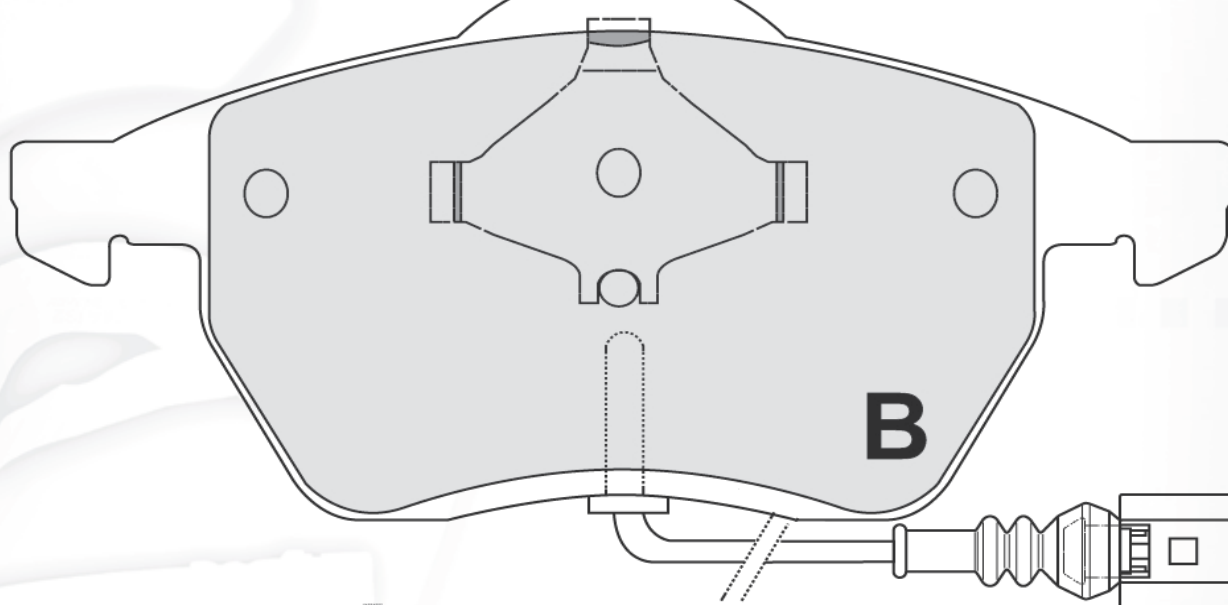
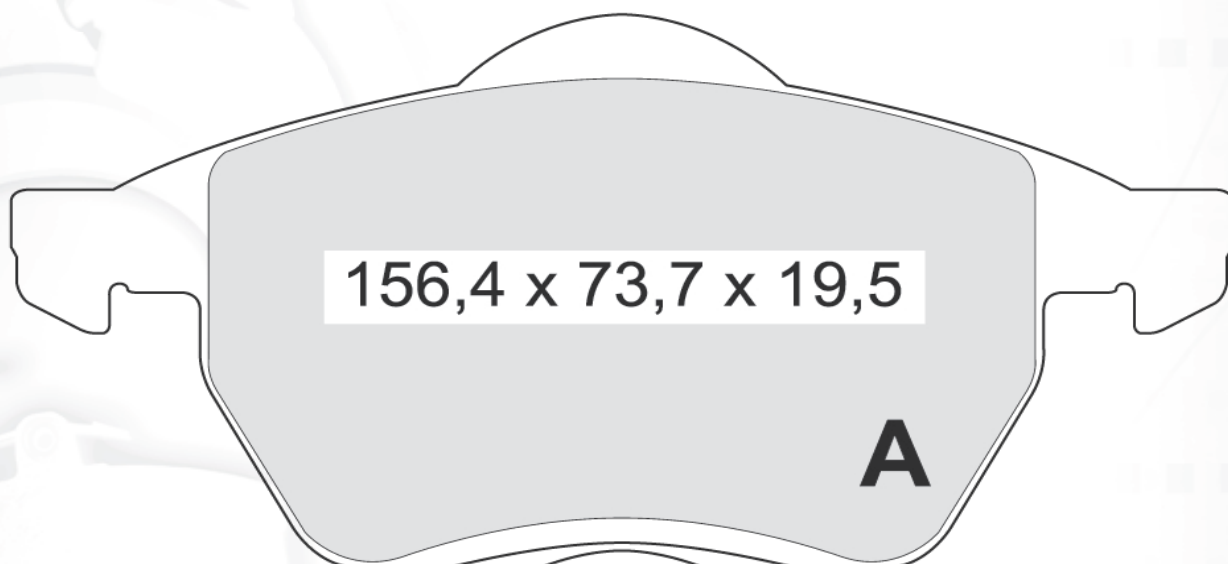

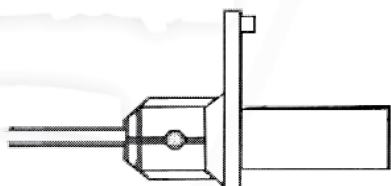

Индикатор Д957И2



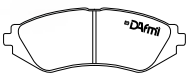
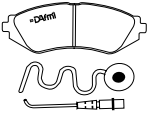

Индикатор Д957И3

В комплект входят две колодки типа А, две колодки типа В

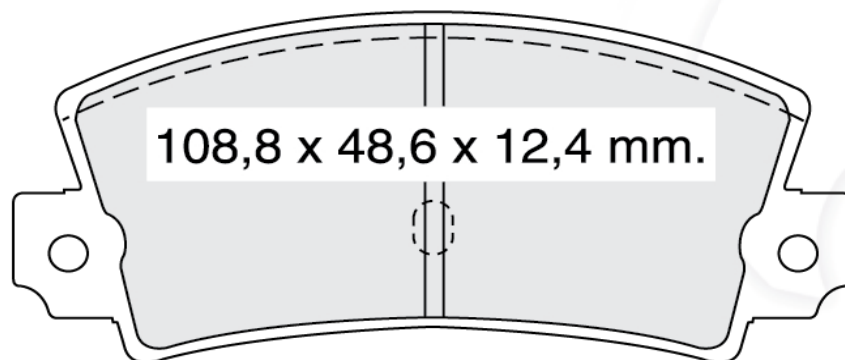
			<p>W.V.A</p>
<p><b>Д960</b></p>		<p><b>FIAT, LANCIA</b></p>	<p><b>20293</b></p>

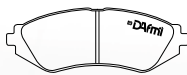
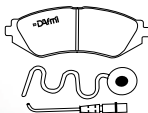

			W.V.A
---	---	--	-------

<b>Д966</b>		<b>NISSAN, RENAULT, MAZDA, FORD</b>	23482 23483
-------------	--	---	----------------

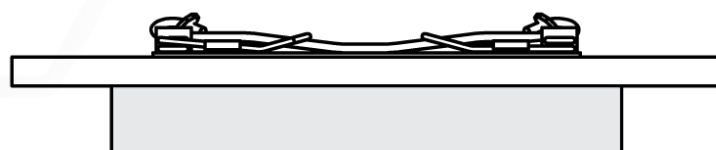
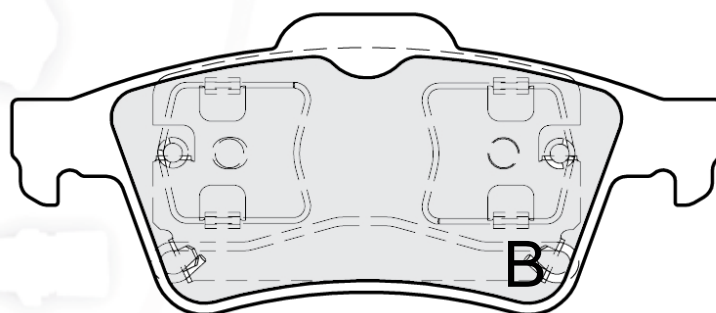
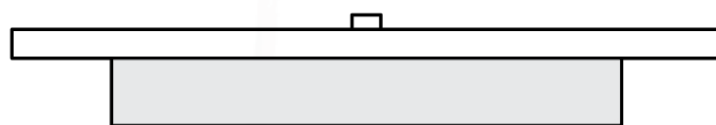
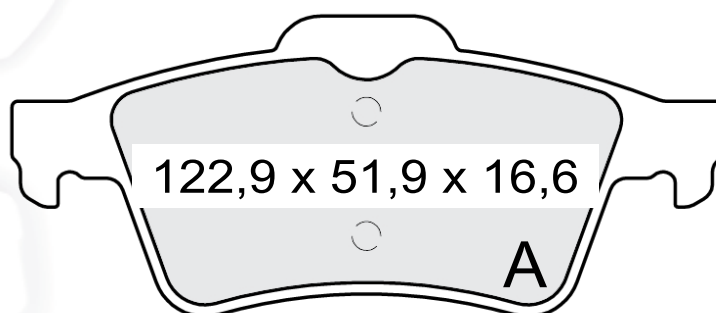

В комплект входят две колодки типа А, две колодки типа В

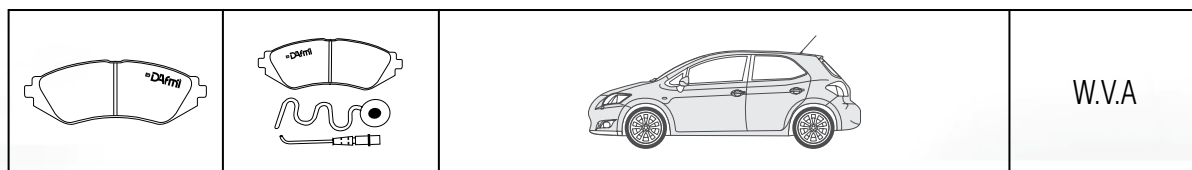

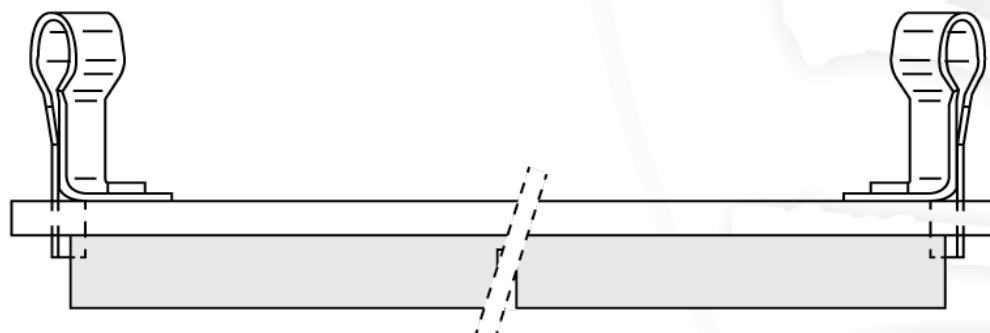
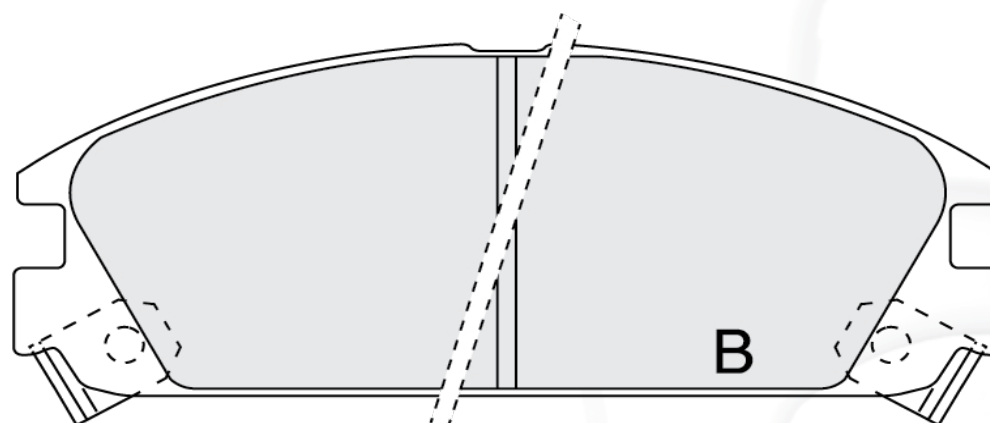
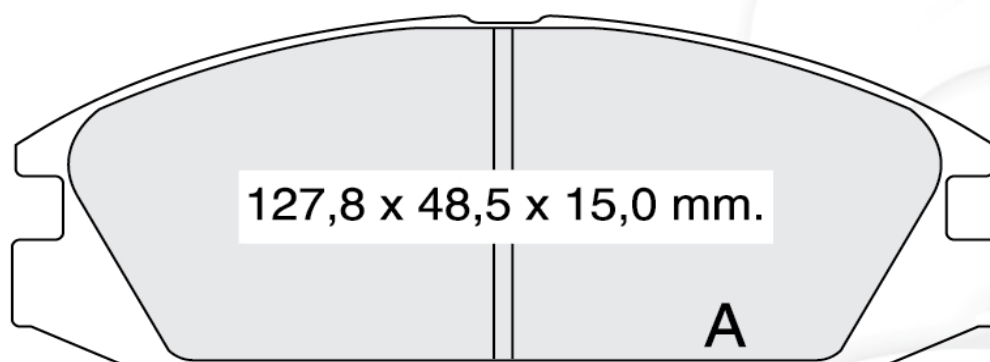

<b>Д968</b>		<b>HONDA</b>	<b>20099</b>
-------------	--	--------------	--------------

Индикатор износа входит в базовую комплектацию данной колодки.

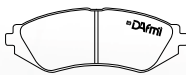
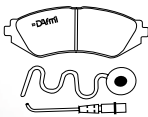

В комплект входят две колодки типа А, две колодки типа В

			W.V.A
---	---	--	-------

<b>Д974</b>		<b>TOYOTA, VOLKSWAGEN</b>	<b>20852</b>
-------------	--	---------------------------	--------------

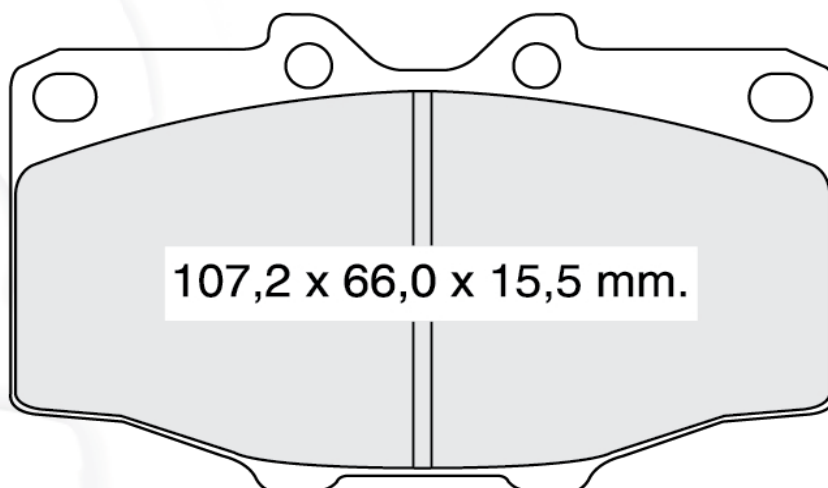

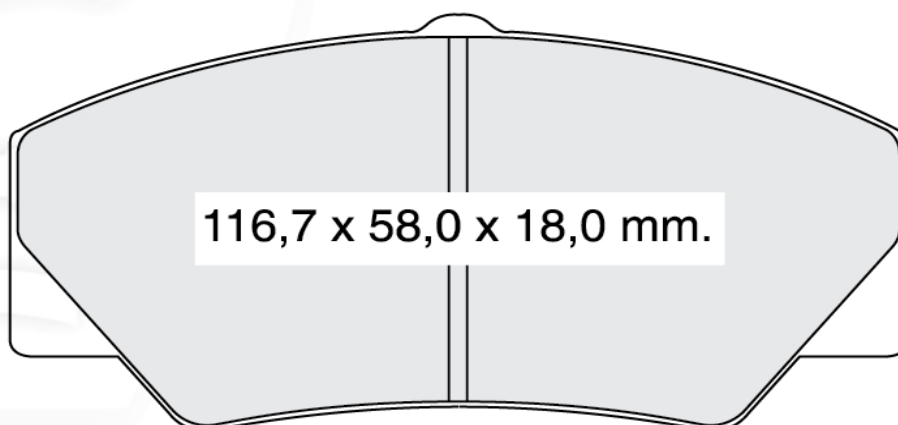

<b>Д983</b>		<b>FORD</b>	<b>21141</b>
-------------	--	-------------	--------------

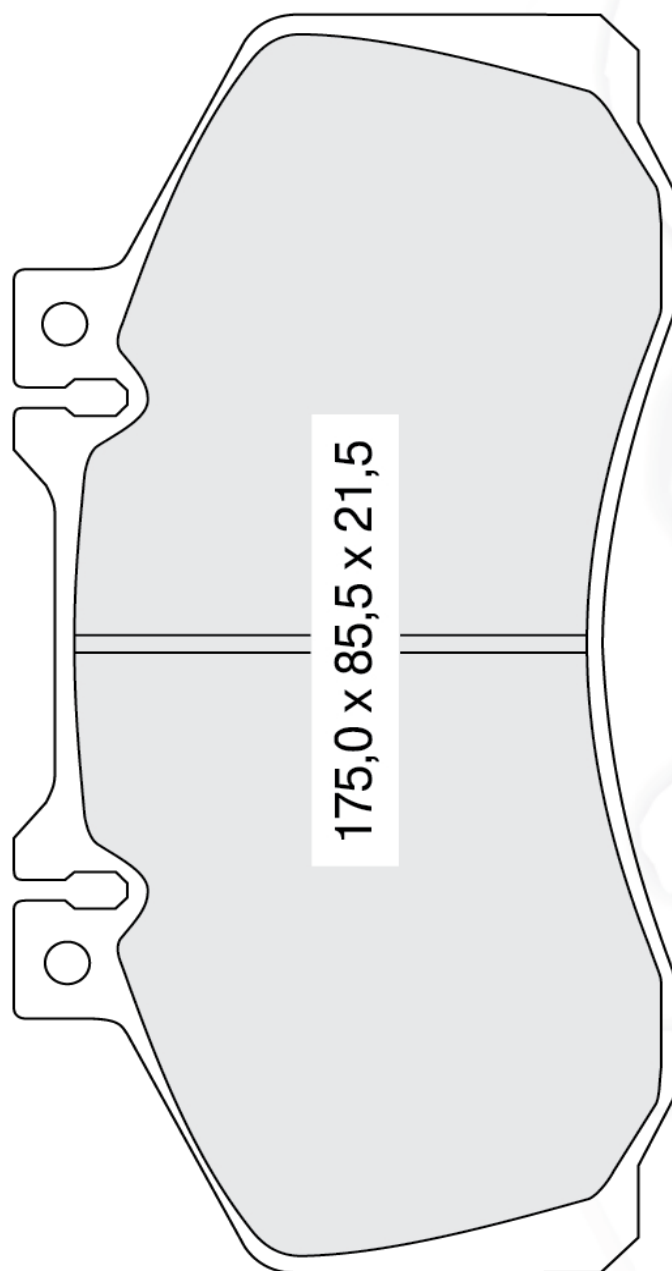

			W.V.A
<b>Д989</b>	<b>Д989И</b>	<b>MERCEDES-BENZ</b>	<b>29835</b>

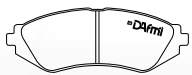
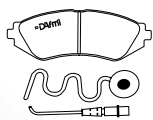

			W.V.A
---	---	--	-------

<b>Д991</b>	<b>Д991И</b>	<b>HONDA, HYUNDAI</b>	21012
-------------	--------------	-----------------------	-------

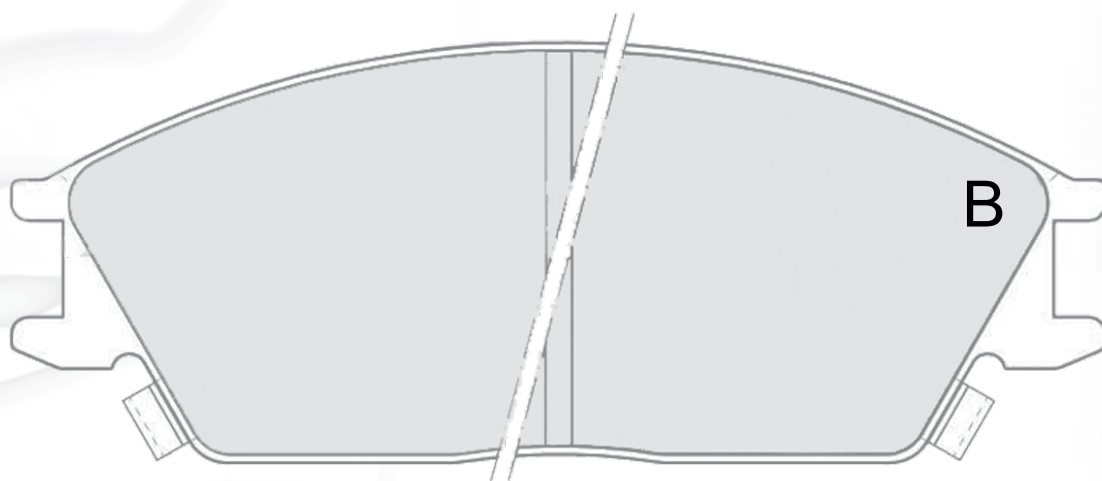
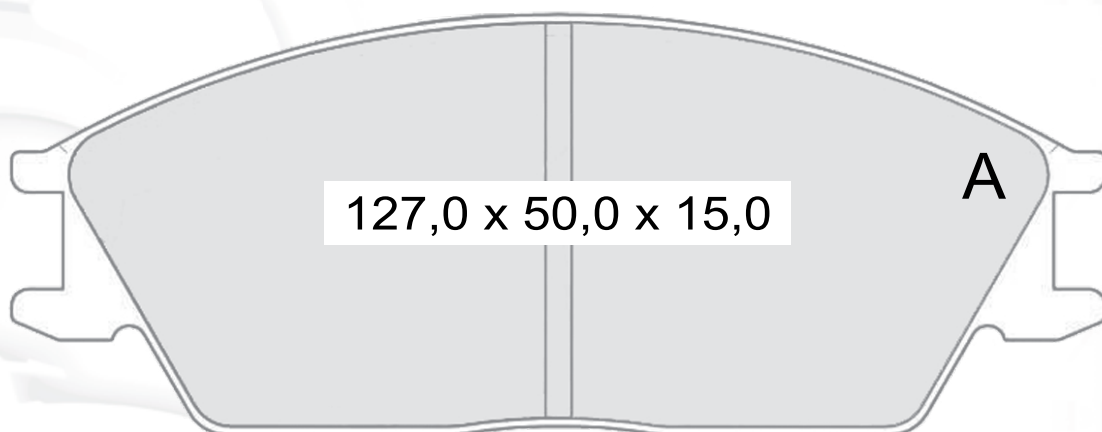

Д991 – в комплект входят четыре колодки типа А  
 Д991И – в комплект входят две колодки типа А, две колодки типа В



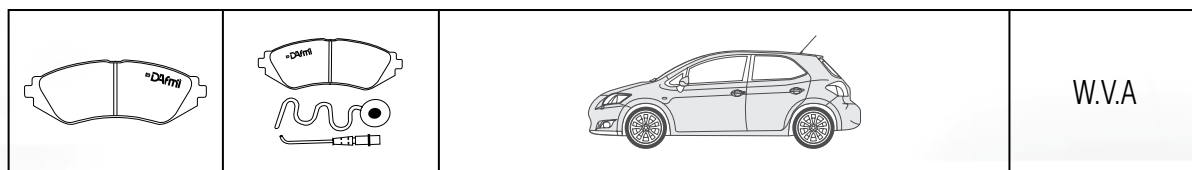

<p><b>Д996</b></p>		<p><b>RENAULT</b></p>	<p><b>20928</b></p>
--------------------	--	-----------------------	---------------------

Индикатор износа входит в базовую комплектацию данной колодки.

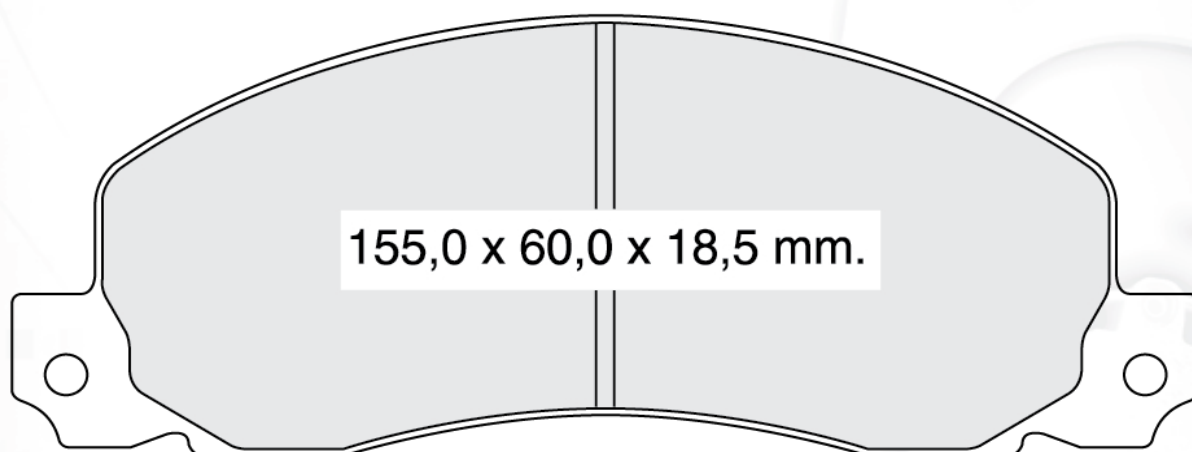

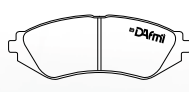
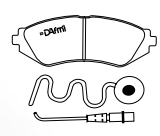
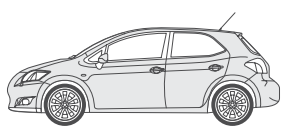
			<p>W.V.A</p>
---	---	--	--------------

<p>TK 0100.000</p>		<p>Трамвай Т3М</p>	
--------------------	--	--------------------	--

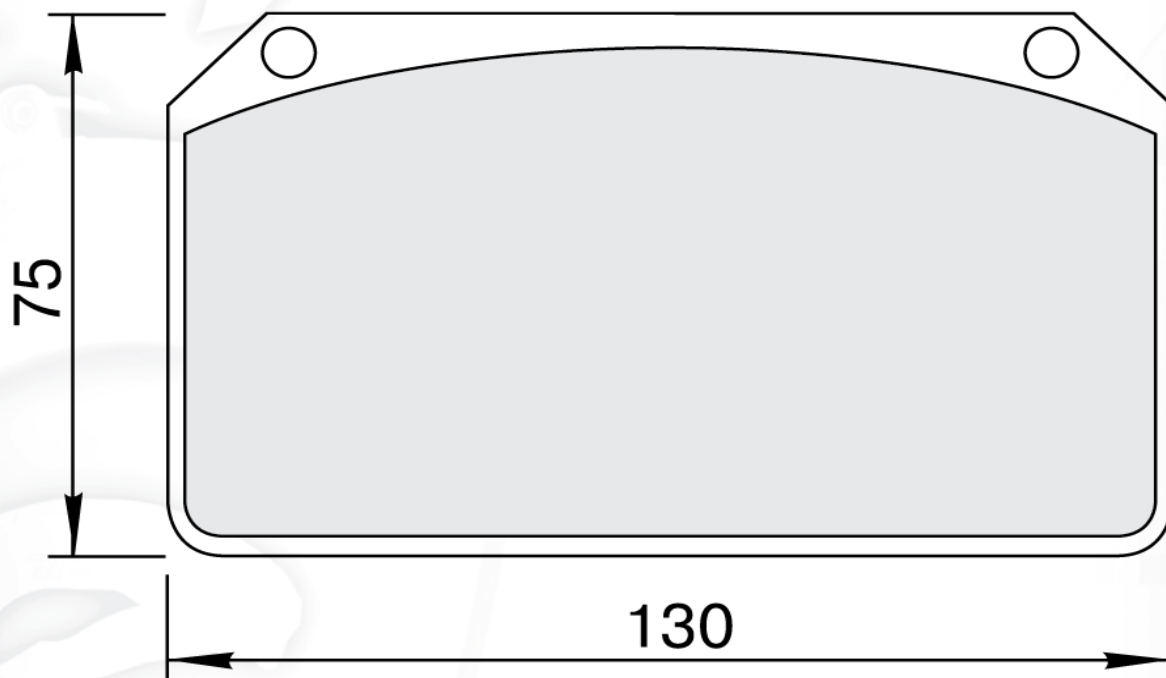

			W.V.A
<b>P406</b>		<b>Снегоход "Тайга"</b>	

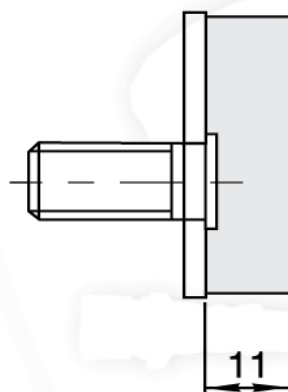
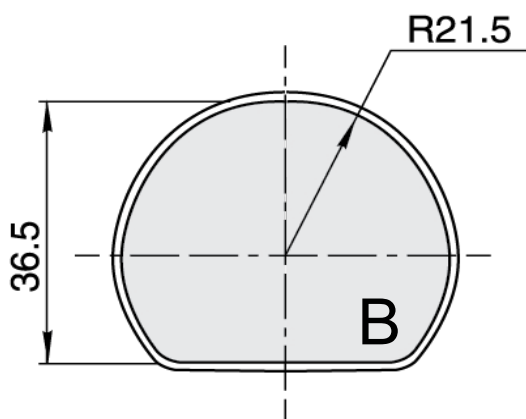
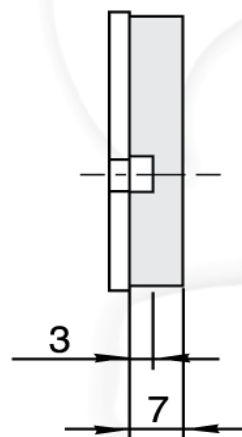
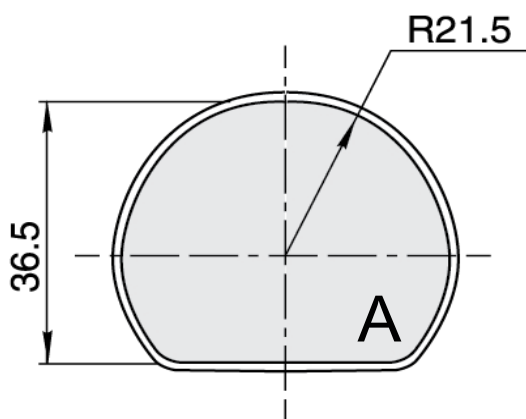

В комплект входят одна колодка типа А, одна колодка типа В

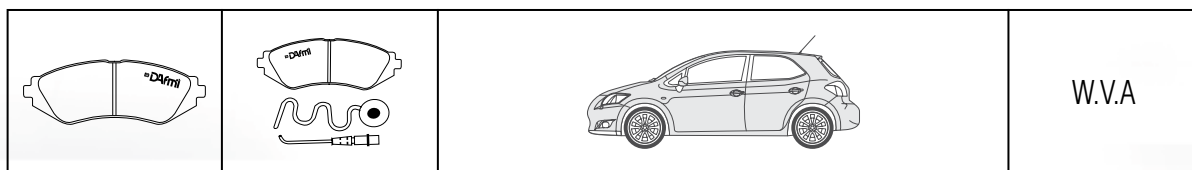

45-3502040A-01		<b>ЮМЗ-6</b>	
3518020-45860-01		<b>Дон - 1500</b>	
70-3502040-03-01		<b>МТЗ - 80</b>	

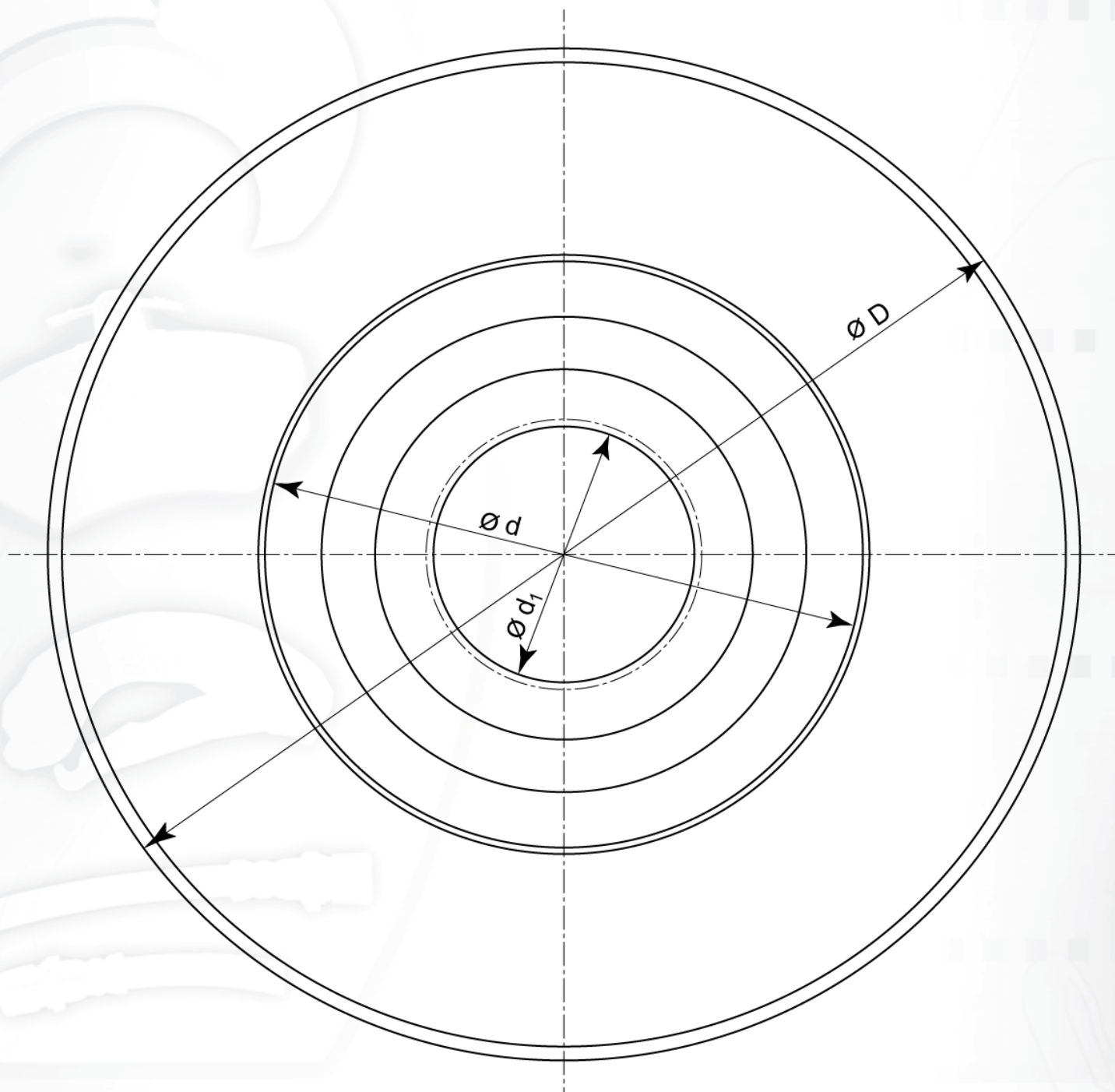

	<b>D</b>	<b>d</b>	<b>d<sub>1</sub></b>
<b>ЮМЗ-6</b>	181	100	44
<b>Дон - 1500</b>	182	100	40
<b>МТЗ - 80</b>	181	100	44

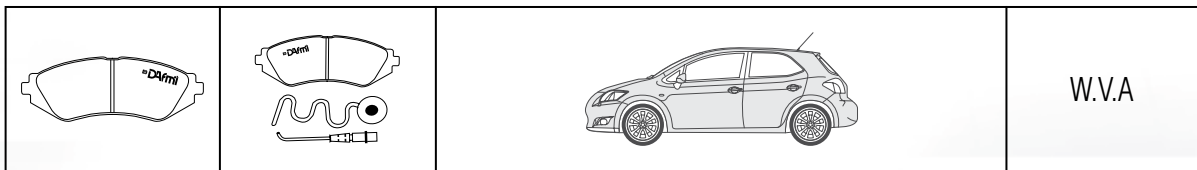

<b>125.38.102A-01</b>	<b>T - 150K</b>	
-----------------------	-----------------	--

Изображение в масштабе

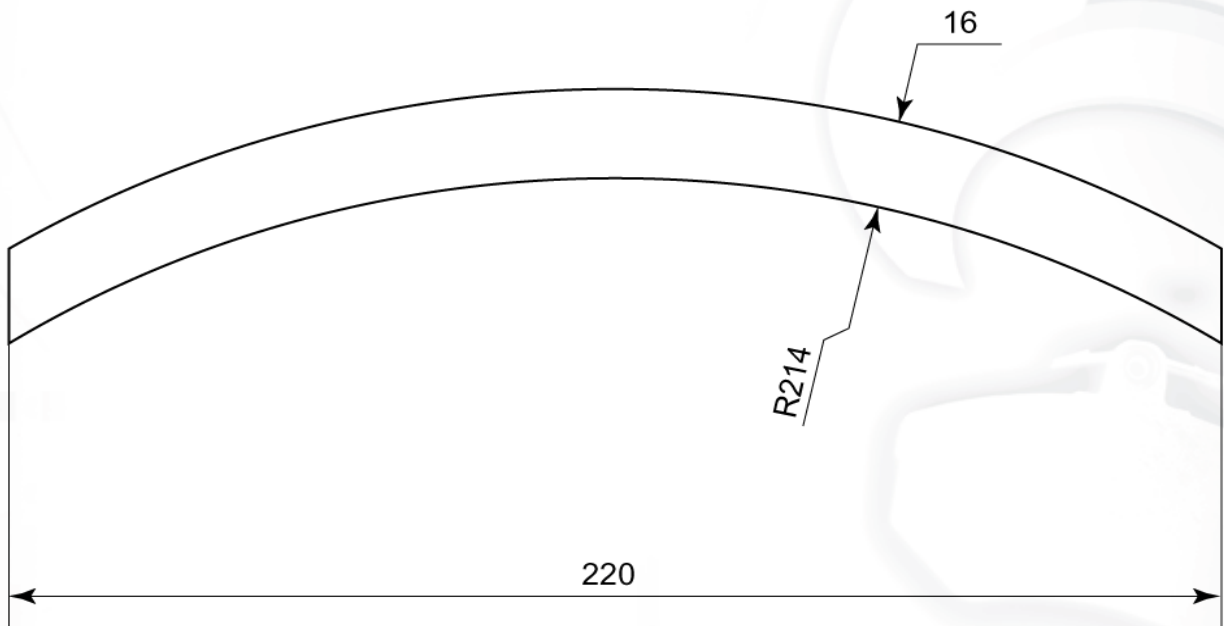

WVA	ДАФМИ
20002	Д628
20034	Д602
20039	Д774
20099	Д968
20104	Д968
20124	Д637
20140	Д226
20141	Д226
20163	Д819
20164	Д819
20166	Д656
20168	Д151
20168	Д161
20168	Д884
20168	Д885
20180	Д698
20193	Д475
20200	Д784
20228	Д598
20228	Д608
20293	Д960
20336	Д226
20337	Д226
20338	Д226
20339	Д226
20341	Д679
20359	Д430
20366	Д499
20392	Д242
20437	Д279
20465	Д168
20491	Д359
20547	Д700
20574	Д253
20575	Д284
20588	Д276
20629	Д620
20635	Д352
20640	Д309
20645	Д222
20652	Д763

WVA	ДАФМИ
20660	Д301
20668	Д369
20669	Д327
20669	Д328
20669	Д332
20675	Д381
20676	Д957
20676	Д957И
20687	Д213
20687	Д741
20703	Д646
20718	Д331
20740	Д736
20741	Д530
20749	Д224
20758	Д213
20770	Д339
20783	Д311
20784	Д261
20838	Д373
20852	Д974
20859	Д352
20870	Д404
20887	Д364
20888	Д366
20889	Д368
20895	Д421
20901	Д328
20903	Д121
20905	Д294
20907	Д785
20907	Д789
20909	Д785
20916	Д926
20919	Д478
20928	Д996
20939	Д269
20950	Д334
20955	Д396
20958	Д321
20960	Д481

WVA	ДАФМИ
20960	Д653
20961	Д481
20961	Д653
20968	Д494
20979	Д173
20981	Д685
20981	Д689
20995	Д765
21012	Д991
21028	Д742
21041	Д387
21048	Д129
21050	Д687
21055	Д501
21074	Д711
21079	Д685
21080	Д702
21080	Д744
21089	Д511
21093	Д425
21099	Д415
21100	Д482
21103	Д938
21115	Д175
21124	Д144
21125	Д401
21140	Д459
21141	Д983
21154	Д492
21170	Д140
21170	Д743
21171	Д324
21173	Д342
21182	Д792И
21190	Д433
21205	Д674
21206	Д674
21209	Д439
21210	Д439
21216	Д645
21233	Д739

WVA	ДАФМИ
21273	Д176
21274	Д176
21278	Д548
21280	Д618
21292	Д720
21293	Д720
21312	Д563
21333	Д174
21334	Д174
21344	Д436
21345	Д436
21346	Д436
21347	Д159
21351	Д475
21363	Д780
21368	Д152
21372	Д445
21373	Д123
21375	Д123
21378	Д450
21395	Д930
21396	Д916
21410	Д138
21411	Д160
21413	Д160
21439	Д937
21469	Д864
21470	Д837
21479	Д142
21495	Д641
21496	Д641
21497	Д122
21498	Д122
21499	Д122
21507	Д572
21543	Д866
21545	Д163
21546	Д619
21553	Д211
21554	Д211
21555	Д211

WVA	ДАФМИ
21561	Д497
21573	Д585
21576	Д145
21577	Д145
21592	Д148
21593	Д148
21601	Д816
21620	Д147
21647	Д791
21648	Д791
21649	Д791
21650	Д601
21651	Д717И
21652	Д717И
21654	Д774
21657	Д840
21662	Д446
21664	Д155
21676	Д153
21679	Д210
21680	Д210
21681	Д210
21689	Д183
21690	Д154
21697	Д872
21706	Д188
21707	Д188
21708	Д188
21713	Д162
21719	Д751
21720	Д751
21721	Д751
21725	Д487
21727	Д487
21754	Д594
21756	Д594
21757	Д594
21766	Д551
21768	Д780
21769	Д780
21775	Д172

WVA	ДАФМИ
21785	Д210
21791	Д185
21797	Д149
21799	Д150
21800	Д150
21822	Д130
21829	Д156
21834	Д288
21840	Д821
21845	Д139
21866	Д157
21866	Д158
21866	Д177
21868	Д177
21879	Д890
21892	Д805
21920	Д169
21920	Д169И
21938	Д957И3
21939	Д957И3
21945	Д151
21945	Д161И
21974	Д137
21975	Д897
21976	Д897
21977	Д897
21980	Д179
23004	Д181
23005	Д181
23006	Д181
23020	Д187
23021	Д167
23022	Д186
23063	Д184И
23064	Д184И
23066	Д184И
23072	Д230
23073	Д230
23074	Д230
23080	Д180
23086	Д165

WVA	ДАФМИ
23093	Д197
23094	Д200
23094	Д200И
23095	Д200
23095	Д200И
23154	Д189
23155	Д189
23202	Д714
23203	Д714
23224	Д638
23234	Д133
23235	Д133
23236	Д133
23237	Д135
23241	Д132
23245	Д231
23247	Д231
23248	Д231
23278	Д205
23279	Д205
23314	Д178
23321	Д205
23347	Д225
23392	Д957И2
23430	Д340
23450	Д134
23451	Д134
23455	Д235
23456	Д235
23457	Д235
23463	Д197
23480	Д126
23481	Д126
23482	Д966
23483	Д966
23543	Д198
23569	Д209
23584	Д192
23585	Д215
23587	Д194
23588	Д194

WVA	ДАФМИ
23589	Д194
23589	Д195
23599	Д219
23600	Д934
23723	Д613
23724	Д613
23768	Д126
23794	Д225
23891	Д191
23891	Д212
23914	Д203
23930	Д202
23968	Д225
23973	Д204
23974	Д190
24014	Д171
24015	Д171
24031	Д214
24032	Д214
24033	Д214
24045	Д222
24046	Д199
24047	Д199
24048	Д199
24068	Д232
24069	Д232
24070	Д232
24071	Д125
24101	Д219
24137	Д206
24153	Д195
29040	Д168
29076	Д146
29121	Д128
29121	Д164
29123	Д281
29835	Д989

TRW	ДАФМИ
GDB 101	Д602
GDB 114	Д585
GDB 140	Д656
GDB 148	Д226
GDB 149	Д226
GDB 155	Д960
GDB 197	Д331
GDB 199	Д269
GDB 238	Д311
GDB 242	Д242
GDB 255	Д309
GDB 259	Д281
GDB 261	Д279
GDB 263	Д284
GDB 264	Д679
GDB 265	Д301
GDB 284	Д421
GDB 288	Д321
GDB 294	Д213
GDB 295	Д646
GDB 297	Д334
GDB 298	Д620
GDB 299	Д381
GDB 301	Д785
GDB 313	Д352
GDB 317	Д261
GDB 318	Д415
GDB 323	Д404
GDB 327	Д294
GDB 341	Д430
GDB 344	Д996
GDB 345	Д175
GDB 349	Д983
GDB 352	Д974
GDB 354	Д387
GDB 355	Д396
GDB 367	Д415
GDB 374	Д774
GDB 392	Д511
GDB 397	Д499
GDB 399	Д173
GDB 404	Д328
GDB 425	Д478

TRW	ДАФМИ
GDB 430	Д332
GDB 434	Д224
GDB 447	Д674
GDB 454	Д366
GDB 457	Д373
GDB 459	Д364
GDB 463	Д368
GDB 464	Д425
GDB 466	Д938
GDB 469	Д743
GDB 471	Д685
GDB 472	Д689
GDB 478	Д129
GDB 482	Д736
GDB 499	Д563
GDB 628	Д253
GDB 648	Д608
GDB 654	Д276
GDB 660	Д359
GDB 663	Д598
GDB 695	Д530
GDB 774	Д751
GDB 784	Д968
GDB 791	Д763
GDB 792	Д123
GDB 793	Д439
GDB 796	Д572
GDB 797	Д210
GDB 798	Д445
GDB 808	Д702
GDB 808	Д744
GDB 812	Д645
GDB 817	Д501
GDB 818	Д742
GDB 820	Д342
GDB 826	Д327
GDB 833	Д482
GDB 837	Д819
GDB 848	Д619
GDB 862	Д637
GDB 863	Д253
GDB 864	Д792И
GDB 870	Д866

TRW	ДАФМИ
GDB 882	Д436
GDB 883	Д174
GDB 893	Д991
GDB 894	Д122
GDB 895	Д487
GDB 897	Д324
GDB 911	Д741
GDB 915	Д687
GDB 916	Д494
GDB 917	Д765
GDB 925	Д968
GDB 945	Д401
GDB 951	Д433
GDB 952	Д459
GDB 957	Д152
GDB 969	Д492
GDB 970	Д739
GDB 981	Д450
GDB 983	Д628
GDB 985	Д548
GDB 988	Д321
GDB 989	Д641
GDB 1003	Д497
GDB 1005	Д618
GDB 1012	Д840
GDB 1017	Д159
GDB 1023	Д188
GDB 1024	Д774
GDB 1030	Д926
GDB 1040	Д700
GDB 1044	Д885
GDB 1048	Д884
GDB 1049	Д957И
GDB 1058	Д711
GDB 1061	Д890
GDB 1068	Д381
GDB 1080	Д864
GDB 1084	Д837
GDB 1092	Д142
GDB 1094	Д937
GDB 1100	Д720
GDB 1105	Д149
GDB 1106	Д150

TRW	ДАФМИ
GDB 1107	Д916
GDB 1113	Д138
GDB 1126	Д780
GDB 1127	Д821
GDB 1128	Д791
GDB 1129	Д601
GDB 1139	Д594
GDB 1140	Д551
GDB 1153	Д130
GDB 1154	Д172
GDB 1159	Д176
GDB 1164	Д872
GDB 1166	Д160
GDB 1168	Д288
GDB 1186	Д139
GDB 1187	Д505
GDB 1189	Д698
GDB 1196	Д481
GDB 1197	Д180
GDB 1198	Д169
GDB 1198	Д169И
GDB 1205	Д155
GDB 1208	Д785
GDB 1218	Д158
GDB 1220	Д145
GDB 1248	Д168
GDB 1263	Д148
GDB 1266	Д161
GDB 1271	Д156
GDB 1274	Д157
GDB 1280	Д446
GDB 1288	Д146
GDB 1306	Д177
GDB 1307	Д957
GDB 1307	Д957И3
GDB 1312	Д151
GDB 1321	Д179
GDB 1328	Д481
GDB 1330	Д481
GDB 1345	Д164
GDB 1351	Д184И
GDB 1358	Д189
GDB 1360	Д653



TRW	ДАФМИ
GDB 1361	Д179
GDB 1366	Д161И
GDB 1372	Д481
GDB 1373	Д186
GDB 1376	Д957
GDB 1383	Д789
GDB 1388	Д230
GDB 1399	Д167
GDB 1403	Д957И
GDB 1403	Д957И2
GDB 1408	Д187
GDB 1416	Д481
GDB 1419	Д714
GDB 1422	Д137
GDB 1429	Д957
GDB 1434	Д205
GDB 1435	Д362
GDB 1439	Д653
GDB 1443	Д789
GDB 1446	Д140
GDB 1458	Д481
GDB 1464	Д934
GDB 1467	Д653
GDB 1468	Д231
GDB 1469	Д966
GDB 1504	Д481
GDB 1534	Д128
GDB 1550	Д194
GDB 1551	Д203
GDB 1552	Д202
GDB 1559	Д225
GDB 1563	Д219
GDB 1572	Д837
GDB 1573	Д864
GDB 1577	Д153
GDB 1583	Д613
GDB 1584	Д507
GDB 1605	Д195
GDB 1609	Д164
GDB 1614	Д204
GDB 1621	Д206
GDB 1622	Д203
GDB 1623	Д219

TRW	ДАФМИ
GDB 1624	Д934
GDB 3089	Д343
GDB 3092	Д163
GDB 3108	Д143
GDB 3109	Д183
GDB 3123	Д805
GDB 3124	Д165
GDB 3132	Д178
GDB 3155	Д185
GDB 3163	Д897
GDB 3168	Д197
GDB 3170	Д211
GDB 3171	Д133
GDB 3172	Д135
GDB 3173	Д134
GDB 3176	Д872
GDB 3178	Д309
GDB 3180	Д181
GDB 3181	Д162
GDB 3186	Д200И
GDB 3194	Д222
GDB 3195	Д132
GDB 3196	Д717И
GDB 3203	Д235
GDB 3216	Д133
GDB 3227	Д200
GDB 3231	Д222
GDB 3244	Д218
GDB 3245	Д196
GDB 3251	Д215
GDB 3265	Д133
GDB 3279	Д495
GDB 3282	Д198
GDB 3284	Д198
GDB 3287	Д192
GDB 3288	Д201
GDB 3289	Д489
GDB 3291	Д200
GDB 3292	Д966
GDB 3297	Д209
GDB 3298	Д198
GDB 3300	Д816
GDB 3309	Д218

TRW	ДАФМИ
GDB 3310	Д199
GDB 3311	Д222
GDB 3314	Д234
GDB 3330	Д190
GDB 3332	Д204
GDB 3336	Д126
GDB 3337	Д361
GDB 3341	Д344
GDB 3342	Д233
GDB 3343	Д232
GDB 3344	Д345
GDB 3348	Д125
GDB 3352	Д191
GDB 3367	Д193
GDB 3378	Д214
GDB 3386	Д191
GDB 3396	Д204И
GDB 3421	Д234
GDB 4104	Д130
GDB 5050	Д989

FERODO	ДАФМИ
FCV239	Д261
FCV516	Д168
FCV879	Д989
FDB1000	Д711И3
FDB1015	Д139
FDB1017	Д505
FDB102	Д960
FDB1024	Д819
FDB1034	Д805
FDB1038	Д145
FDB1039	Д147
FDB1044	Д548
FDB1045	Д148
FDB1049	Д155
FDB105	Д608
FDB1050	Д155
FDB1054	Д158
FDB1055	Д957
FDB1067	Д433
FDB1068	Д156
FDB1073	Д153
FDB1075	Д154
FDB1083	Д481
FDB1091	Д181
FDB1092	Д180
FDB1093	Д169
FDB1094	Д137
FDB1096	Д197
FDB1101	Д157
FDB1108	Д143
FDB1112	Д144
FDB1113	Д938
FDB1117	Д459
FDB113	Д226
FDB1131	Д763
FDB1135	Д179
FDB114	Д226
FDB1157	Д135
FDB1167	Д957
FDB128	Д598
FDB1285	Д176
FDB1288	Д177
FDB1289	Д161

FERODO	ДАФМИ
FDB1293	Д184
FDB1301	Д765
FDB1304	Д186
FDB1305	Д187
FDB1306	Д167
FDB1312	Д151
FDB1318	Д189
FDB1321	Д897
FDB1323	Д957И
FDB1336	Д135
FDB1337	Д132
FDB1338	Д837И
FDB1339	Д864И
FDB1369	Д133
FDB1370	Д179
FDB1382	Д230
FDB1394	Д714
FDB1399	Д219
FDB1416	Д362
FDB1425	Д205
FDB143	Д242
FDB1439	Д200И
FDB1441	Д231
FDB1476	Д934
FDB1531	Д495
FDB1540	Д966
FDB1544	Д202
FDB1569	Д235
FDB1573	Д201
FDB1574	Д489
FDB1580	Д200
FDB1594	Д613
FDB1602	Д196
FDB1605	Д209
FDB1606	Д198
FDB1617	Д204
FDB1619	Д199
FDB162	Д281
FDB1620	Д234
FDB1621	Д192
FDB163	Д279
FDB1636	Д203
FDB1641	Д194

FERODO	ДАФМИ
FDB1648	Д126
FDB1649	Д361
FDB167	Д359
FDB1699	Д190
FDB1707	Д218
FDB1721	Д222
FDB1728	Д195
FDB173	Д269
FDB1733	Д191
FDB1735	Д232
FDB1736	Д345
FDB1738	Д507
FDB175	Д253
FDB1766	Д206
FDB1773	Д225
FDB1839	Д344
FDB1840	Д214
FDB1869	Д233
FDB192	Д276
FDB195	Д301
FDB2	Д602
FDB201	Д284
FDB206	Д309
FDB212	Д311
FDB222	Д369
FDB225	Д331
FDB243	Д679
FDB256	Д620
FDB275	Д446
FDB276	Д785
FDB285	Д421
FDB287	Д530
FDB288	Д974
FDB289	Д446И
FDB293	Д321
FDB296	Д381
FDB300	Д475
FDB304	Д387
FDB308	Д404
FDB317	Д736
FDB328	Д213
FDB340	Д415
FDB346	Д334

FERODO	ДАФМИ
FDB360	Д960
FDB368	Д396
FDB370	Д373
FDB372	Д222
FDB377	Д129
FDB385	Д368
FDB392	Д364
FDB393	Д294
FDB398	Д689
FDB406	Д478
FDB408	Д685
FDB409	Д938
FDB410	Д425
FDB412	Д253
FDB414	Д996
FDB415	Д742И
FDB418	Д175
FDB419	Д366
FDB428	Д352
FDB434	Д702
FDB435	Д991И
FDB450	Д983
FDB454	Д968
FDB455	Д744
FDB472	Д563
FDB478	Д288
FDB506	Д511
FDB507	Д401
FDB510	Д674
FDB511	Д129
FDB517	Д173
FDB524	Д482
FDB525	Д687
FDB527	Д743
FDB540	Д439
FDB541	Д653
FDB542	Д711И2
FDB550	Д436
FDB556	Д123
FDB565	Д711И3
FDB576	Д450
FDB578	Д765
FDB579	Д789

FERODO	ДАФМИ
FDB581	Д121
FDB584	Д433
FDB585	Д475
FDB586	Д459
FDB588	Д174
FDB590	Д957И
FDB595	Д792И
FDB596	Д369
FDB600	Д487
FDB602	Д445И
FDB604	Д619
FDB609	Д459
FDB610	Д446
FDB615	Д284
FDB617	Д324
FDB619	Д548
FDB621	Д563
FDB623	Д572
FDB628	Д739
FDB638	Д211
FDB641	Д159
FDB644	Д741
FDB645	Д741
FDB650	Д711И1
FDB651	Д711И2
FDB654	Д551
FDB655	Д129
FDB660	Д224
FDB660	Д342
FDB667	Д618
FDB669	Д501
FDB670	Д492
FDB671	Д645
FDB676	Д689
FDB678	Д866
FDB681	Д176
FDB686	Д152
FDB687	Д702
FDB691	Д497
FDB693	Д741
FDB700	Д837
FDB701	Д864
FDB707	Д163

FERODO	ДАФМИ
FDB715	Д774
FDB719	Д294
FDB722	Д763
FDB725	Д720
FDB726	Д653
FDB729	Д294
FDB730	Д294
FDB732	Д700
FDB746	Д572
FDB752	Д585
FDB757	Д628
FDB759	Д601
FDB763	Д840
FDB764	Д791
FDB765	Д780
FDB766	Д930
FDB768	Д711И2
FDB774	Д332
FDB774	Д884
FDB775	Д327
FDB775	Д885
FDB777	Д872
FDB779	Д494
FDB780	Д436
FDB785	Д637
FDB789	Д641
FDB797	Д172
FDB797	Д210
FDB803	Д188
FDB813	Д784
FDB829	Д430
FDB845	Д339
FDB846	Д785
FDB85	Д646
FDB850	Д698
FDB854	Д937
FDB867	Д816
FDB868	Д185
FDB869	Д551
FDB884	Д916
FDB901	Д160
FDB904	Д890И
FDB905	Д717И

FERODO	ДАФМИ
FDB909	Д138
FDB915	Д685
FDB929	Д130
FDB941	Д585
FDB949	Д183
FDB950	Д594
FDB951	Д328
FDB954	Д328
FDB956	Д751
FDB96	Д656
FDB967	Д149
FDB968	Д150
FDB969	Д957
FDB970	Д142
FDB979	Д741
FDB993	Д774
FDB994	Д711И1
FSL626	Д499
FVR1315	Д128

BENDIX	ДАФМИ
571202	Д656
571217	Д499
571221	Д608
571224	Д226
571232	Д598
571234	Д784
571243	Д226
571247	Д359
571250	Д430
571261	Д279
571264	Д284
571265	Д301
571271	Д276
571272	Д261
571276	Д269
571278	Д679
571279	Д602
571291	Д311
571297	Д334
571300	Д381
571302	Д352
571304	Д530
571306	Д996
571308	Д446И
571309	Д373
571313	Д478
571315	Д368
571316	Д364
571317	Д366
571319	Д702
571320	Д744
571325	Д129
571327	Д339
571330	Д482
571332	Д294
571336	Д983
571337	Д226
571340	Д499
571344	Д213
571346	Д743
571347	Д792И
571350	Д369
571351	Д785

BENDIX	ДАФМИ
571352	Д342
571353	Д501
571355	Д494
571356	Д328
571357	Д327
571357	Д885
571359	Д439
571361	Д653
571365	Д711И2
571366	Д572
571369	Д572
571370	Д739
571372	Д242
571374	Д281
571375	Д253
571376	Д884
571380	Д173
571382	Д742
571387	Д765
571389	Д687
571390	Д687
571391	Д433
571392	Д121
571393	Д674
571398	Д548
571400	Д618
571404	Д736
571407	Д459
571408	Д685
571409	Д938
571411	Д720
571414	Д645
571416	Д129
571419	Д168
571421	Д163
571422	Д129
571423	Д711И1
571426	Д425
571428	Д511
571446	Д168
571447	Д129
571456	Д819
571457	Д176

BENDIX	ДАФМИ
571458	Д763
571460	Д637
571462	Д653
571465	Д492
571472	Д711И1
571474	Д960
571475	Д960
571476	Д926
571491	Д253
571492	Д700
571493	Д152
571512	Д957
571519	Д130
571521	Д585
571522	Д930
571526	Д339
571529	Д620
571530	Д160
571536	Д309
571539	Д269
571540	Д446
571542	Д620
571546	Д687
571555	Д741
571559	Д224
571560	Д742
571725	Д324
571726	Д324
571733	Д572
571743	Д294
571745	Д837
571746	Д864
571752	Д572
571825	Д261И
571828	Д937
571832	Д916
571833	Д269
571837	Д698
571838	Д711И3
571839	Д149
571840	Д150
571844	Д145
571845	Д548

BENDIX	ДАФМИ
571846	Д147
571847	Д142
571848	Д366
571849	Д785
571864	Д128
571868	Д224И1
571869	Д482
571877	Д155
571880	Д153
571894	Д711И1
571899	Д548
571900	Д957
571905	Д711И1
571906	Д481
571910	Д148
571915	Д158
571919	Д144
571920	Д156
571921	Д957
571923	Д157
571924	Д700
571929	Д137
571930	Д179
571931	Д179
571935	Д957
571936	Д154
571939	Д177
571940	Д169
571942	Д180
571946	Д186
571947	Д187
571950	Д167
571954	Д179
571955	Д161
571959	Д720
571960	Д154
571967	Д189
571968	Д184И
571969	Д151
571971	Д137И
571977	Д563
571982	Д557И
572100	Д774

BENDIX	ДАФМИ
572120	Д646
572135	Д563
572136	Д563
572138	Д751
572140	Д172
572140	Д210
572143	Д774
572144	Д774
572145	Д774
572159	Д401
572161	Д551
572178	Д974
572179	Д174
572180	Д421
572181	Д421
572185	Д172
572186	Д188
572188	Д916
572206	Д321
572210	Д840
572230	Д331
572232	Д331
572233	Д331
572236	Д436
572237	Д475
572238	Д475
572253	Д172
572254	Д172
572255	Д404
572256	Д445
572268	Д991
572269	Д991
572270	Д991
572271	Д866
572272	Д866
572275	Д641
572280	Д123
572281	Д123
572287	Д968
572288	Д968
572295	Д396
572310	Д619
572312	Д415

BENDIX	ДАФМИ
572313	Д415И
572317	Д450
572319	Д387
572320	Д387
572324	Д872
572325	Д594
572331	Д628
572332	Д628
572333	Д816
572335	Д175
572345	Д497
572346	Д497
572347	Д487
572348	Д139
572349	Д122
572350	Д890
572370	Д780
572373	Д159
572375	Д601
572376	Д162
572378	Д183
572381	Д791
572382	Д138
572383	Д165
572388	Д309
572392	Д185
572393	Д717И
572396	Д181
572400	Д897
572402	Д132
572403	Д133
572411	Д343
572412	Д134
572422	Д197
572428	Д200
572429	Д200И
572453	Д218
572482	Д199
572485	Д126
572488	Д495
572490	Д222
572491	Д201
572492	Д489

BENDIX	ДАФМИ
572511	Д232
572514	Д191
573017	Д231
573018	Д966
573020	Д205
573031	Д934
573041	Д714
573120	Д362
573125	Д204
573128	Д194
573134	Д195

SANGSIN	ДАФМИ
SP1007	Д646
SP1030	Д415
SP1043	Д327
SP1043	Д328
SP1043	Д332
SP1044	Д628
SP1046	Д188
SP1047	Д991
SP1048	Д487
SP1050	Д143
SP1051	Д387
SP1054-F	Д791
SP1055	Д269
SP1062	Д211
SP1064	Д324
SP1067	Д774
SP1068	Д780
SP1070	Д805
SP1072	Д343
SP1076-F	Д717И
SP1077	Д133
SP1079-F	Д134
SP1079-R	Д235
SP1086	Д132
SP1102	Д133
SP1105	Д404

SANGSIN	ДАФМИ
SP1106	Д840
SP1107-F	Д497
SP1107-R	Д162
SP1109	Д122
SP1110	Д816
SP1111	Д487
SP1113	Д196
SP1114	Д135
SP1115	Д209
SP1115	Д218
SP1117	Д198
SP1117	Д198
SP1120	Д641
SP1138	Д185
SP1139	Д183
SP1140-1	Д159
SP1142	Д601
SP1143	Д364
SP1152	Д214
SP1153	Д232
SP1154	Д345
SP1155	Д191
SP1155	Д212
SP1158	Д190
SP1159	Д133
SP1160	Д125
SP1162	Д233
SP1165	Д140
SP1165	Д743
SP1167	Д193
SP1168	Д301
SP1180	Д439
SP1233	Д215
SP1240	Д233
SP2001	Д957
SP2005	Д327
SP2005	Д328
SP2005	Д332
SP2009	Д174
SP2024	Д700
SP2029	Д481
SP2029	Д653
SP2039	Д172

REMSA	ДАФМИ
006.30	Д602
006.80	Д741
010.10	Д195
010.20	Д242
010.40	Д679
011.20	Д279
014.10	Д276
016.00	Д281
017.10	Д608
017.20	Д598
017.30	Д598
021.12	Д226
021.30	Д226
021.36	Д226
021.40	Д960
023.02	Д996
025.30	Д960
026.12	Д499
028.00	Д656
042.00	Д784
042.30	Д784
046.00	Д253
046.10	Д253
046.20	Д253
047.22	Д168
047.30	Д261
047.52	Д168
056.00	Д430
063.00	Д359
063.10	Д359
079.00	Д646
079.20	Д646
080.00	Д656
101.00	Д269
102.00	Д284
103.00	Д301
117.00	Д331
119.20	Д309
119.32	Д311
132.00	Д974
134.00	Д327
134.02	Д328
134.10	Д332

REMSA	ДАФМИ
134.40	Д885
134.50	Д884
134.62	Д328
135.00	Д369
135.10	Д369
139.00	Д620
141.02	Д339
142.10	Д585
142.20	Д585
143.02	Д530
144.24	Д352
145.00	Д224
145.00	Д501
146.14	Д373
146.32	Д425
146.52	Д369
147.00	Д421
147.02	Д174
147.22	Д421
149.00	Д321
149.02	Д321
154.00	Д446
154.02	Д446И
155.00	Д381
155.20	Д511
156.00	Д736
156.10	Д736
157.00	Д213
157.10	Д741
157.20	Д741
164.00	Д387
167.04	Д404
170.02	Д744
170.04	Д702
170.12	Д744
170.14	Д702
171.00	Д364
171.10	Д366
171.20	Д368
172.00	Д789
172.02	Д785
172.22	Д785
173.00	Д121

REMSA	ДАФМИ
173.10	Д121
175.00	Д601
176.20	Д739
179.30	Д222
179.40	Д222
184.00	Д415
184.02	Д415
188.00	Д396
189.02	Д742
189.02	Д742И
189.10	Д742И
191.12	Д641
192.12	Д294
192.22	Д294
192.34	Д294
192.44	Д294
193.00	Д475
193.02	Д475
202.02	Д996
204.00	Д175
205.00	Д689
205.02	Д685
205.12	Д685
206.00	Д983
208.02	Д926
208.12	Д478
211.04	Д129
211.12	Д129
211.22	Д129
212.02	Д774
212.12	Д774
214.14	Д288
215.00	Д401
215.00	Д821
219.00	Д436
219.02	Д436
221.00	Д743
223.00	Д173
224.02	Д991
224.02	Д991И
228.02	Д968
231.00	Д938
233.00	Д563

REMSA	ДАФМИ
233.12	Д563
233.20	Д563
236.00	Д159
238.04	Д866
239.00	Д687
239.10	Д459
239.50	Д459
244.02	Д628
245.12	Д989
245.22	Д989
245.32	Д989
261.00	Д674
261.02	Д674
262.02	Д439
263.01	Д481
263.05	Д481
263.10	Д653
263.20	Д653
264.02	Д482
265.00	Д765
265.15	Д154
265.30	Д698
265.50	Д765
268.04	Д445
268.04	Д445И
270.00	Д494
270.25	Д153
273.02	Д450
275.02	Д123
282.10	Д459
282.20	Д741
286.30	Д433
286.50	Д433
287.00	Д487
290.02	Д791
291.02	Д188
293.12	Д497
293.22	Д497
294.22	Д211
296.02	Д342
297.00	Д689
303.02	Д792И
303.12	Д711И2

REMSA	ДАФМИ	REMSA	ДАФМИ	REMSA	ДАФМИ	REMSA	ДАФМИ
305.02	Д711И2	390.10	Д156	594.02	Д178	776.00	Д205
305.12	Д711И3	390.20	Д957	598.02	Д165И	777.00	Д362
305.31	Д711И2	390.22	Д957И	600.02	Д805	800.22	Д218
305.32	Д711И1	390.22	Д957И3	601.00	Д155	804.12	Д192
305.44	Д711И3	390.41	Д957И2	609.00	Д158	813.00	Д215
305.72	Д711И1	391.00	Д837	609.10	Д157	822.12	Д201
309.00	Д645	391.02	Д837И	609.20	Д177	839.02	Д495
310.04	Д572	392.00	Д864	614.00	Д146	841.00	Д934
311.00	Д284	392.02	Д864И	620.20	Д446	842.00	Д966
315.04	Д172	393.00	Д700	631.00	Д151	843.00	Д231
315.04	Д210	395.02	Д618	631.10	Д161	874.02	Д489
318.12	Д487	401.04	Д572	631.12	Д161И	890.00	Д345
318.22	Д487	402.02	Д816	633.00	Д137	893.02	Д214
319.00	Д492	406.02	Д890	633.00	Д137И	953.02	Д191
320.00	Д619	406.02	Д890И	634.00	Д144	970.02	Д199
321.02	Д548	412.20	Д183	643.00	Д179	976.10	Д202
321.22	Д548	415.04	Д594	645.02	Д133	986.00	Д190
324.02	Д122	415.32	Д196	645.12	Д133И	987.00	Д204
325.02	Д751	416.00	Д551	646.10	Д135	1030.01	Д194
329.00	Д551	419.02	Д872	648.02	Д134И	1031.00	Д203
331.00	Д324	425.02	Д139	649.02	Д235	1038.02	Д233
335.12	Д135	426.02	Д505	651.00	Д164	1041.02	Д232
343.00	Д163	429.04	Д172	651.10	Д128	1047.02	Д361
344.00	Д618	432.00	Д916	676.02	Д897	1048.00	Д125
350.00	Д487	432.02	Д930	684.02	Д184	1051.02	Д171
351.02	Д717И	445.00	Д937	691.00	Д189	1051.02	Д344
354.02	Д780	445.02	Д937И	692.00	Д938	1082.00	Д613
357.00	Д601	446.00	Д176	694.02	Д200И	1134.02	Д193
364.00	Д840	459.00	Д143	694.10	Д200		
364.02	Д840	462.00	Д138	696.00	Д132		
366.12	Д162	467.00	Д130	701.00	Д186		
368.00	Д819	468.00	Д160	704.10	Д197		
368.10	Д819	480.00	Д142	708.02	Д176		
370.00	Д185	486.02	Д149	713.00	Д230		
372.02	Д334	487.02	Д150	717.00	Д187		
382.00	Д152	494.02	Д343	726.00	Д179		
383.00	Д637	578.00	Д145	733.00	Д167		
384.00	Д720	579.00	Д147	746.02	Д198		
385.00	Д763	580.00	Д148	766.00	Д714		
385.10	Д763	582.80	Д180	767.10	Д638		
390.00	Д957	586.00	Д155	771.12	Д209		
390.01	Д957	590.82	Д169	771.12	Д218		
390.02	Д957И	592.02	Д181	772.12	Д340		

ICER	ДАФМИ
140405	Д261
140452	Д585
140521	Д175
140526	Д415
140542	Д983
140563	Д168
140648	Д173
140690	Д628
140700	Д674
140701	Д123
140783	Д674
140791	Д123
140814	Д168
140853	Д866
140854	Д866
140880	Д637
140881	Д637
140884	Д159
140885	Д159
140886	Д159
140892	Д129
140893	Д585
140895	Д763
140896	Д837
140897	Д864
140904	Д168
140914	Д162
140915	Д162
140933	Д138
140968	Д130
140979	Д780
140990	Д139
141006	Д172
141007	Д172
141007	Д210
141009	Д183И
141010	Д183И
141025	Д172
141026	Д172
141028	Д499
141046	Д711И3
141049	Д142
141053	Д149

ICER	ДАФМИ
141054	Д150
141087	Д154И
141102	Д147
141103	Д148
141104	Д145
141126	Д146К
141146	Д342
141208	Д128
141208	Д164
141238	Д135
141241	Д548
141270	Д805
141284	Д187
141288	Д186
141289	Д167
141425	Д142И
180052	Д226
180060	Д226
180088	Д784
180089	Д226
180098	Д960
180101	Д226
180102	Д226
180139	Д226
180142	Д784
180162	Д602
180164	Д646
180169	Д608
180170	Д276
180182	Д226
180188	Д996
180197	Д242
180218	Д960
180219	Д598
180221	Д608
180230	Д430
180255	Д359
180258	Д226
180281	Д373
180292	Д284
180302	Д281
180305	Д279
180307	Д276

ICER	ДАФМИ
180317	Д331
180318	Д253
180323	Д679
180324	Д679
180329	Д309
180337	Д369
180355	Д311
180375	Д352
180388	Д421
180397	Д373
180402	Д359
180409	Д321
180410	Д311
180413	Д446
180414	Д446И
180415	Д373
180417	Д352
180418	Д334
180419	Д224
180420	Д213
180422	Д381
180423	Д620
180439	Д425
180446	Д387
180448	Д373
180454	Д269
180457	Д352
180459	Д364
180460	Д366
180461	Д368
180462	Д404
180472	Д439
180475	Д785
180484	Д174
180490	Д960
180494	Д475
180496	Д226
180497	Д601
180509	Д641
180510	Д742
180511	Д242
180517	Д741
180519	Д321

ICER	ДАФМИ
180540	Д401
180543	Д789
180553	Д744
180554	Д339
180555	Д702
180557	Д478
180598	Д685
180602	Д396
180611	Д774
180616	Д991
180618	Д689
180622	Д373
180633	Д294
180670	Д387
180674	Д938
180685	Д679
180692	Д687
180696	Д439
180697	Д481
180726	Д425
180729	Д482
180734	Д288
180742	Д792И
180744	Д224
180745	Д501
180749	Д968
180751	Д563
180752	Д563
180753	Д563
180758	Д433
180760	Д711И1
180761	Д711И2
180766	Д342
180767	Д224
180771	Д791
180772	Д741
180773	Д494
180774	Д492
180775	Д511
180778	Д511
180780	Д482
180784	Д369
180785	Д222



ICER	ДАФМИ
180786	Д572
180787	Д548
180789	Д653
180790	Д324
180795	Д450
180797	Д122
180798	Д751
180801	Д720
180802	Д968
180803	Д619
180804	Д163
180807	Д459
180808	Д957И
180809	Д332
180810	Д436
180811	Д174
180815	Д121
180835	Д327
180836	Д328
180837	Д739
180857	Д572
180858	Д700
180862	Д702
180863	Д339
180864	Д294
180865	Д253
180866	Д294
180875	Д601
180877	Д487
180878	Д618
180882	Д840
180883	Д494
180887	Д991И
180916	Д916
180917	Д930
180928	Д482
180930	Д926
180934	Д176
180937	Д840
180946	Д276
180947	Д602
180949	Д792И
180955	Д785

ICER	ДАФМИ
180956	Д785
180958	Д872
180960	Д563
180967	Д653
180970	Д774
180971	Д594
180972	Д742И
180973	Д742И
180974	Д741
180981	Д188
180985	Д487
180986	Д487
180988	Д160
180989	Д152
180993	Д339
180998	Д641
181004	Д445
181005	Д816
181011	Д885
181012	Д884
181013	Д884
181014	Д736
181015	Д819
181019	Д717И
181020	Д890И
181023	Д459
181024	Д563
181033	Д711И3
181045	Д563
181048	Д366
181051	Д765
181083	Д494
181084	Д700
181092	Д269
181093	Д269
181094	Д181
181097	Д487
181098	Д711И1
181100	Д497
181101	Д497
181110	Д551
181115	Д155
181117	Д180И

ICER	ДАФМИ
181118	Д169И
181119	Д158
181120	Д294
181128	Д156
181130	Д157
181131	Д957
181134	Д143
181136	Д144
181138	Д957
181139	Д937
181140	Д153
181141	Д154
181142	Д309
181144	Д211
181147	Д165
181152	Д433
181155	Д689
181156	Д151
181157	Д161
181165	Д938
181174	Д765
181178	Д177
181179	Д165И
181184	Д137
181186	Д551
181187	Д751
181191	Д957И
181204	Д179
181214	Д765
181217	Д179
181235	Д897
181249	Д184И
181255	Д179
181260	Д133
181261	Д135
181262	Д132
181263	Д133
181264	Д189
181269	Д134И
181287	Д938
181297	Д230
181299	Д687
181308	Д140И

ICER	ДАФМИ
181317	Д446
181319	Д178И
181332	Д443
181338	Д137
181343	Д714
181349	Д137И
181358	Д780
181362	Д957И
181366	Д433
181372	Д218
181388	Д219
181429	Д934
181432	Д231
181433	Д966
181513	Д201
181519	Д215
181520	Д495
181534	Д204
181535	Д202
181542	Д218
181566	Д190
181567	Д194
181573	Д126
181578	Д199
181581	Д200
181600	Д203
181606	Д232
181610	Д196
181617	Д613
181637	Д195
181643	Д214
181644	Д191
181644	Д212
181645	Д198
181651	Д206
181669	Д235
181683	Д225
181689	Д234
181727	Д125
181746	Д344
181748	Д204И
181806	Д192
181806	Д193

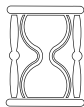
DAFMI	передняя / задняя			W.V.A
-------	----------------------	---	---	-------

Д110	п	ЗА3	ЗА3 1102 "Таврия"	86-	
			ЗА3 1103 "Славута"	99-	
Д121	п	OPEL	Omega A	87-90	20903
			Senator A	83-90	
Д122	п	HONDA	Accord	90-93	21497/21948/21949
Д123	п	MITSUBISHI	L	87-96	21373/21375
Д125	з	CHEVROLET	Lacetti	97-	24071
Д126	п	TOYOTA	Avensis	03-	23480/ 23481/ 23768
			Corolla	04-	
Д128	п	IVECO	Turbo Daily	99-	29121
Д129	п	FIAT	Daily	91-	21048
		IVECO	Daily	90-96	
			Turbo Daily	91-	
Д130	п	JEEP	Cherokee	91-96	21822
			Grand Cherokee	92-99	
			Wrangler	91-99	
		KIA	Carnival	98-00	
Д131	п	BA3	BA3 1111 "OKA"	86-	
Д132	п	CHEVROLET	Lanos	98-	23241
			Spark	98-	
		DAEWOO	Lanos	98-	
			Matiz	98-	
			Sens	98-	
Д133	п	CHEVROLET	Tacuma	05-	23234/23235/23236
			DAEWOO	Espero	
		Nubira	97-01		
		Prince			
		Tacuma			
Д133И	п	CHEVROLET	Lacetti	97-	23234/23235/23236
		DAEWOO	Leganza	97-	
Д134	п	KIA	Clarus	96-00	23450/23451
Д135	з	DAEWOO	Korando	99-	23237
			Leganza	97-	
			Musso	99-	
			Nubira	97-01	
Д137	п	AUDI	A3	96-	21974
		SEAT	Leon	99-	
			Toledo	98-	
		SKODA	Fabia	99-	
			Octavia	96-	
		VOLKSWAGEN	Beetle New	98-	
			Bora	98-	
Golf	97-				
Д137И	п	AUDI	A2	00-05	21974
Д138	п	FORD	Maverick	93-	21410

# Таблица применяемости тормозных колодок

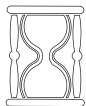

DAFMI	передняя / задняя			W.V.A
-------	----------------------	---	---	-------

		NISSAN	Serena	92-	
			Terrano	93-	
			Vanette Cargo	95-	
Д139	п	ISUZU	Trooper	91-97	21845
		OPEL	Frontera	95-	
			Monterey	91-	
Д140	п	BA3	BA3 2110	95-	21170
Д141	п	АЗЛК/ ИЖ	М 2141	83-	
Д142	п	VOLKSWAGEN	Caravelle	90-95	21479
			Transporter/ Bus	90-	
			Transporter / Caravelle T4	90-	
Д143	п	DAEWOO	Tico	94-00	
		SUZUKI	Alto	94-	
Д144	п	CITROEN	Xsara	97-	21124
			Xsara Picasso	99-	
			Berlingo	96-	
		PEUGEOT	306	97-00	
			Partner	96-	
Д145	п	MERCEDES-BENZ	Sprinter	94-	21576/21577
			Vito	96-97	
		VOLKSWAGEN	LT	97-	
Д146	п/з	MERCEDES-BENZ	Sprinter	95-	29076
		VOLKSWAGEN	LT	96-	
Д147	з	MERCEDES-BENZ	Sprinter	95-	21620
		VOLKSWAGEN	LT	97-	
Д148	з	MERCEDES-BENZ	Sprinter	94-	21592/21593
		VOLKSWAGEN	LT	97-	
Д149	п	CITROEN	Jumper	94-	21797
		FIAT	Ducato	94-	
		PEUGEOT	Boxer	94-	
		OPEL	Vivaro	01-	
		NISSAN	Primastar	02-	
		RENAULT	Trafic	01-	
Д150	п	CITROEN	Jumper	94-	21799/21800
		FIAT	Ducato	94-	
		PEUGEOT	Boxer	94-	
Д151	п	VOLKSWAGEN	Caddy	96-	21945/20168
			Passat	93-96	
			Polo	94-	
Д152	п	OPEL	Omega	90-	21368
			Senator	87-93	
Д153	п	BMW	500	95-	21676
Д154	з	BMW	500	95-	21690
		ROVER	75	99-	
Д155	п	MERCEDES-BENZ	W	95-	21664
Д156	п	OPEL	Vectra	95-	21829
		SAAB	900	93-98	
			9--3	98-	

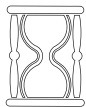
DAFMI	передняя / задняя			W.V.A
-------	----------------------	---	---	-------

			9--5	97-	
Д157	п	SEAT	Arosa	97-	21866
		VOLKSWAGEN	Ibiza	93-	
			Lupo	98-	
		Polo	95-		
Д158	п	VOLKSWAGEN	Golf	91-98	21866
			Vento	95-97	
		SEAT	Cordoba	95-	
Д159	п	FORD	Maverick	93-	21374
		NISSAN	Terrano	93-	
			Pathfinder	88-90	
			Urvan	87-96	
			King cab	92-	
		Vanette	87-94		
Д160	п	OPEL	Vectra	93-95	21411/21413
			Omega	94-99	
Д161	п	AUDI	A4	97-	20168
		VOLKSWAGEN	Passat	96-	
Д161И	п	AUDI	A4	99-04	21945
Д162	з	NISSAN	Maxima	94-	21713
			Primera	93-98	
Д163	з	NISSAN	Almera	00-	21545
			Primera	90-01	
Д164	п/з	IVECO	Daily	92-	29121
			Turbo Daily	96-	
Д165	п	NISSAN	Maxima	94-	23086
Д167	з	VOLKSWAGEN	LT	97-	23021
		MERCEDES-BENZ	Sprinter	98-	
Д168	п	IVECO	Daily	89-	29040/20465
			Turbo Daily	89-96	
Д169	п	mitsubishi	Carisma	95-	21920
		VOLVO	S 40	95-97	
			V 40	95-99	
Д171	з	mitsubishi	Lancer	03-	24014/ 24015
			Outlander	03-	
Д172	п	TOYOTA	4-Runner	87-96	21775
			Hi-Lux	89-	
			Land cruiser	92-	
		VOLKSWAGEN	Taro	88-96	
Д173	п	VOLKSWAGEN	Caravelle	85-90	20979
			Transporter/ Bus	79-91	
Д174	п	SUZUKI	Alto	94-	21333/21334
			Swift	85-	
		SUBARU	Justy	96-	
Д175	п	ISUZU	Midi	89-	21115

# Таблица применяемости тормозных колодок

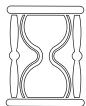

DAFMI	передняя / задняя			W.V.A
-------	----------------------	---	---	-------

			WFR/MFR 11/12/53	83-90	
Д176	п	VOLVO	850	91-96	21273/21274
			C 70	97-	
			S 70	97-	
Д177	п	VOLKSWAGEN	Golf	97-98	21866/21868
			Polo	95-	
Д178	п	SUZUKI	Grand Vitara	98-	23314
			Vitara	94-99	
Д179	п	PEUGEOT	206	98-01	21980
			306	97-00	
		RENAULT	Kangoo	97-	
Д180	п	MITSUBISHI	Carisma	95-	23080
Д181	п	NISSAN	Almera	95-99	23004/23005/23006
Д183	п	TOYOTA	Hi-Ace	89-95	21689
			Hi-Lux	82-93	
Д184И	п	OPEL	Astra	98-	23063/23064/23066
Д185	п	LEXUS		89-92	21791
		TOYOTA	Camry	91-	
Д186	п	MERCEDES-BENZ	Sprinter	98-	23022
			Vito	98-	
Д187	з	MERCEDES-BENZ	Vito	98-	23020
Д188	з	MITSUBISHI	Galant	92-96, 99-03	21706/ 21707/ 21708
			Space runner	91-03	
			Space Wagon	91-98	
			Eclipse	89-99	
			Pajero Pinin	99-	
			RVR	91-99	
			Sapporo	87-90	
			Shogun Pinin	99-	
Д189	п	FORD	Focus	98-	23154/23155
Д190	п	CHEVROLET	Aveo	05-	23974
Д191	п	HYUNDAI	Coupe	02-	23891
			Sonata	01--04	
			Sonica	02-	
			Tiburon	04-	
			Tucson	04-	
			Tuscani	01-	
		KIA	Sportage	04-	23891
Д192	п	MITSUBISHI	Galant	00-03	23584
			Lancer	03-	
			Space runner	00-03	
Д193	п	KIA	Cerato	04-	

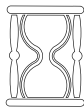
DAFMI	передняя / задняя			W.V.A
-------	----------------------	---	---	-------

Д194	п	AUDI	A3	03-	23587/ 23588/ 23589
		SEAT	Toledo	04-	
		SKODA	Octavia	04-	
		VOLKSWAGEN	Caddy	04-	
			Golf	03-	
			Jetta	05-	
			Passat	05-	
			Touran	03-	
Д195	п	CITROEN	C4	04-	23589/ 24153
		PEUGEOT	307	03-	
Д196	п	KIA	Carens	99-02	
			Clarus	99-01	
			Credos	96-00	
			Rio	02--05	
Д197	п	NISSAN	Almera	00-	23093/ 23463
			Primera	98-01	
Д198	з	HYUNDAI	Santa Fe	00-	23543
			Lavita	00-	
			Matrix	01-	
			Sonata	98-	
			Sonica	98-	
			Tucson	04-	
			XG25	99-05	
			XG30	99-05	
XG350	02-				
Д199	п	MAZDA	6	02-	24046/ 24047/ 24048
			Atenza	02-	
Д200	п	NISSAN	Almera	00-03	23094/ 23095
			Primera	02-	
Д200И	п	HONDA	Accord	98-02	23094/ 23095
Д201	п	TOYOTA	Corolla	01-	
Д202	п	RENAULT	Kangoo	01-	23930
			Megane	02-	
			Scenic	03-	
Д203	з	AUDI	A3	04-	23914
			A6	04-	
		SKODA	Octavia	04-	
		VOLKSWAGEN	Caddy	04-	
			Jetta	05-	
			Passat	05-	
Touran	03-				
Д204	п	NISSAN	Micra	03-	23973
			Micra CC	05-	
		RENAULT	Clio	05-	

# Таблица применяемости тормозных колодок

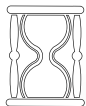

DAFMI	передняя / задняя			W.V.A
-------	-------------------	---	---	-------

			Modus	04-	
Д204И	п	SUZUKI	Swift	05-	
Д205	п	FORD	Mondeo	00-	23278/ 23279/ 23321
Д206	з	FORD	Focus	04-	24137
		MAZDA	5	05-	
Д209	п	HYUNDAI	Santa Fe	00-	23569
Д210	п	TOYOTA	4-Runner	89-91	21679/ 21680/ 21681/ 21785
			Hi-Lux	88-	
			Land cruiser	90-02	
Д211	з	HYUNDAI	Coupe	96-	21553/ 21554/ 21555
			Tiburon	99-	
			Tuscani	01-	
			Avante	95--03	
			Elantra/Lantra	90-03	
		KIA	Cerato	04-	
Д212	з	FORD	Transit	06-	
Д213	з	MERCEDES-BENZ	W	82-93	20758/20687
Д214	п	HYUNDAI	Avante	01--03	24031/ 24032/ 24033
			Elantra/Lantra	01--03	
			Lavita	02-	
			Matrix	02-	
Д215	п	TOYOTA	Rav 4	00-	23585
Д216	п	CHERY	Amulet		
Д217	п	FORD	Transit	06-	
Д218	п	MAZDA	6	02-	
Д219	п	CITROEN	C4	04-	24101/ 23599
			Xsara Picasso	01-	
			Berlingo	00-	
		PEUGEOT	Partner	01-	
			Ranch	01-	
Д221	п	VA3	Патриот		
Д222	з	MAZDA	626	97-02	20645/ 24045
			6	02-	
			Atenza	02-	
			323	98-03	

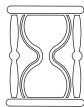
DAFMI	передняя / задняя			W.V.A
-------	----------------------	---	---	-------

Д224	п	MERCEDES-BENZ	W	82-87	20749
		BMW	300	82-87	
Д225	п	BMW	300	05-	23347/ 23794/ 23968
			500	03-	
Д226	з	RENAULT	Espace	85-99	20336/20337/20338 / 20339/20140/20141
		RENAULT	R	75-94	
	з	RENAULT	Fuego	83-86	
	з	RENAULT	Alpine	78-85	
	п	DACIA	Nova	96-	
	п	DACIA	Super Nova	00-	
Д229	п	ISUZU	NQR	95-	
		БОГДАН	A092 (EURO-II)	95-	
Д230	п	VOLVO	S 60	00-	23072/ 23073/ 23074
			S 80	98-	
			V 70	96-04	
			XC70	02-	
Д231	п	RENAULT	Espace	02-	23245/ 23247/ 23248
			Grand Espace	02-	
			Laguna	01-	
			Scenic RX4	02--04	
			Vel Satis	02-	
Д232	п	KIA	Sorento	02-	24068/ 24069/ 24070
Д233	п	KIA	Carens II Ceed	02-	
Д234	з	KIA	Pride	05-	
			Rio New	05-	
			Ceed	05-	
Д235	з	KIA	Clarus	96-01	23455/ 23456/ 23457
			Carens	99-	
			Credos	96-00	
			Mentor	99-	
			Sephia	01-	
			Shuma	98-	



# Таблица применяемости тормозных колодок

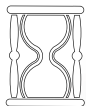

DAFMI	передняя / задняя			W.V.A
-------	----------------------	---	---	-------

			Spectra	01-	
Д242	п	MERCEDES-BENZ	W	72-79	20392
Д253	п	AUDI	80	77-86	20574
			100	76-84	
		VOLVO	340-360	76-92	
		VOLKSWAGEN	Passat	78-80	
Д261	п	MERCEDES-BENZ	G	79-93	20784
			D	82-96	
			G	79-93	
Д269	п	DAEWOO	Racer	93-95	20939
			Nexia	93-	
			Espero	95-	
		OPEL	Ascona	74-88	
			Kadett	79-91	
			Corsa	83-97	
			Manta	76-98	
			Omega	86-89	
			Record	81-86	
			Vectra	88-91	
Д276	п	ALFA ROMEO		80-87	20588
		BMW	300	75-82	
		OPEL	Ascona	74-81	
			Kadett	77-79	
			Manta	74-80	
			Record	74-81	
Д279	п	BMW	500	76-81	20437
			600	76-91	
			700	77-86	
Д281	з	IVECO	Turbo Daily	99-	29123
Д284	з	CITROEN	BX	82-93	20575
			CX	74-85	
Д288	з	TOYOTA	Camry	88-	21834
			Carina	88-94	
			AvensisStation Wagon	00-	
Д294	п	CITROEN	AX	91-95	20905
			Saxo	96-	
			ZX	92-97	
		PEUGEOT	106	91-	
			205	83-97	
			305	83-90	
			306	93-97	
			309	85-93	
			405	87-92	
			RENAULT	Clio	
		Espace		84-90	

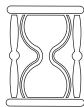
DAFMI	передняя / задняя			W.V.A
-------	----------------------	---	---	-------

			Fuego	80-86	
			R	80-96	
			Rapid	86-98	
			Express	85-	
Д301	п	BA3	BA3 2121 "НИВА"	76-	20660
			BA3 2123 "CHEVROLET-NIVA"	02-	
		CHEVROLET	BA3 2123	02-	
Д309	п	FORD	Courier	91-	20640
			Escort	80-90	
			Fiesta	89-00	
			Ka	96-00	
			Orion	86-90	
			Puma	97-	
			Sierra	87-92	
		KIA	Sephia	93-98	
		MAZDA	121	96-	
Д311	п	FORD	Fiesta	89-95	20783
			Sierra	82-87	
			Orion	83-90	
			Escort	83-90	
Д321	п	NISSAN	Cherry	82-86	20958
			Sunny	82-90	
		SUBARU	Domingo	92-94	
Д324	п	FORD	Escort	90-99	21171
			Orion	90-93	
Д327	п	AUDI	80	86-91	20669
			90	87-91	
			100	78-81	
			200	79-83	
			Coupe	88-94	
		VOLKSWAGEN	Corrado	88-95	
			Golf	89	
			Passat	88-89	
Д328	п	AUDI	80	86-94	20901/20669
			90	84-91	
			100	82-94	
			200	82-91	
			Coupe	87-92	
Д331	п	NISSAN	Bluebird	80-83	20718
			Cherry	82-86	
			Laurel	81-89	
			Prairie	82-89	
			Vanette	81-85	
			STANZA	81-85	

# Таблица применяемости тормозных колодок

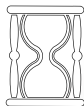

DAFMI	передняя / задняя			W.V.A
-------	----------------------	---	---	-------

			URVAN	85-87				
Д332	п	AUDI	80	83-87	20669			
			90	88-91				
		VOLKSWAGEN	Corrado	88-95				
			Golf	86-91				
			Jetta	87-89				
			Passat	86-93				
			Scirocco	85-89				
Д334	п	FIAT	131	82-84	20950			
			Regata	83-89				
			Ritmo	82-88				
			Uno	83-94				
			Panda	93-				
		LANCIA	Y10	85-96				
		SEAT	131	82-83				
			Ibiza	86-93				
			Malaga	85-91				
			Marbella	87-96				
			Panda	82-86				
			Ritmo	79-83				
			Ronda	83-86				
			Д339	п		DACIA	Logan	04-
		PEUGEOT				205	86-94	
309	87-93							
RENAULT	Espace	85-96						
	Alpine	85-91						
	Clio	90-						
	Logan	04-						
	Megane	95-						
	Megane Scenic	96-99						
	R	80-96						
	Twingo	96-						
	Fuego	80-86						
	Rapid	86-98						
	Express	85-						
Д340	п	FORD	Transit	00-	23430			
Д342	п	BMW	300	82-93	21173			
			Z1	88-91				
Д343	п	HYUNDAI	Porter (TarA3) H-100					
Д344	з	MITSUBISHI	Outlander	03-	24014/24015			
			Lancer	03-				
Д345	з	KIA	Sorento	02-				
Д352	п	RENAULT	Safrane	92-	20859/20635			
		CITROEN	BX	82-93				

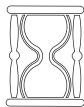
DAFMI	передняя / задняя			W.V.A
-------	----------------------	---	---	-------

Д359	п	FORD	Capry	74-86	20491
			Cortina	74-82	
			Escort	75-80	
			Taurus	75-82	
		HYUNDAI	Stellar	84-90	
Д361	з	TOYOTA	Avensis	03-	
			Corolla	04-	
Д362	з	FORD	Mondeo	00-	
Д364	п	VOLKSWAGEN	Golf	79-93	20887
			Jetta	79-91	
			Passat	79-88	
			Polo	90-94, 96-	
			Santana	81-85	
			Scirocco	79-92	
		SEAT	Cordoba	95-	
Д366	п	SEAT	Cordoba	93-99	20888
			Ibiza	93-	
			Toledo	91-96	
		VOLKSWAGEN	Golf	76-99	
			Jetta	79-90	
			Passat	79-94	
			Polo	94-	
			Santana	81-85	
			Scirocco	79-83	
			Vento	92-97	
			Caddy	82-93	
Д368	п	SEAT	Ibiza	93-	20889
		VOLKSWAGEN	Polo	85-	
			Golf	82-92	
			Jetta	84-92	
Д369	з	VOLKSWAGEN	Passat	96-	20668
		ALFA ROMEO		89-98	
		AUDI	A4	94-99	
			A6	94-	
			A8	83-	
			200	79-83, 89-90	
			Coupe	87-96	
			80	86-95	
			90	84-91	
			100	82-94	
		FIAT	Croma	85-96	
		LANCIA	Thema	84-95	
Y	89-				
Д373	п	ALFA ROMEO		94-00	20838
		FIAT	Argenta	83-85	

# Таблица применяемости тормозных колодок

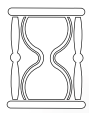

DAFMI	передняя / задняя			W.V.A
-------	-------------------	---	---	-------

			Croma	95-96	
			Punto	93-99	
			Regata	84-89	
			Ritmo	83-88	
			Tempra	90-96	
			Tipo	88-93	
			Uno	85-94	
			Panda	93-	
			Croma	88-96	
			LANCIA	Dedra	
Prisma	85-89				
Y10	85-				
Д381	з	BMW	300	82-93	20675
			700	81-86	
			500	81-87	
			600	82-89	
Д387	п	MAZDA	626	82-87	21041
Д396	п	MITSUBISHI	Colt	81-90	20955
			Cordia/Tredia	84-86	
			Galant	85-90	
			Lancer	84-88	
			Spase Wagon	84-91	
			Tredia	83-88	
Д401	з	MITSUBISHI	Colt	84-92	21125
			Galant	88-90	
			Eclipse	89-99	
			Lancer	88-93	
Д404	п	TOYOTA	Camry	83-86	20870
			Carina	78-96	
			Corolla	83-92	
			Corona	88-92	
			Paseo	91-	
			Starlet	90-96	
			Tercel	82-88	
			Д412	п	
АЗЛК/ ИЖ	М 2140	70-			
	М 412	68-			
Д415	п	NISSAN	300	85-87	21099
			Bluebird	84-90	
			Laurel	81-85	
			Silvia	83-88	
			Trade	85-97	
			Cabstar	82-90	
			King cab	85-88	
			PICK-UP	83-88	

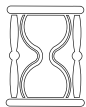
DAFMI	передняя / задняя			W.V.A
-------	----------------------	---	---	-------

			Vanette	85-94	
			Vanette Cargo	91-	
Д421	п	HONDA	Accord	82-83	20895
			Civic	83-97	
Д425	п	FIAT	Croma	85-91	21093
		LANCIA	Delta	85-93	
			Prisma	82-86	
			Thema	84-88	
Д430	п	D.A.F.	Sherpa	82-94	20359
		FORD	Transit	76-91	
		LAND ROVER		70-90	
Д433	п	DAEWOO	Aranos	95-97	21190
			Nexia	93-	
			Espero	95-	
		OPEL	Astra	91-98	
			Calibra	90-98	
			Kadett	84-91	
			Omega	88-94	
			Vectra	88-	
Д436	п	NISSAN	Sunny	86-93	21344/21345/21346
		SUZUKI	Swift	89-96	
Д439	п	PEUGEOT	306	93-97	21209/21210
			405	87-96	
Д443	п	ГАЗ	ГАЗ 3110 "ВОЛГА"	96-	
			ГАЗ 3302 "ГАЗЕЛЬ"	94-	
Д445	п	TOYOTA	Camry	86-94	21372
			Carina	88-92, 94-96	
Д446	п	FORD	Sierra	82-87	21662
		SKODA	Favorit	89-95	
			Felicia	95-01	
			Forman	91-95	
			PICK-UP	93-95	
Д450	п	FORD	Probe	90-	21378
		MAZDA	626	87-92	
Д459	з	OPEL	Vectra	93-95	21140
			Kadett	84-91	
			Astra	91-98	
			Calibra	90-98	
			Vectra	88-95	
		SAAB	900	84-98	
Д475	п	HONDA	Civic	82-95	21351
			Prelude	83-87	
Д478	п	DAEWOO	Lublin		20919
Д481	з	AUDI	A2	02--05	20961/20960

# Таблица применяемости тормозных колодок

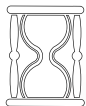

DAFMI	передняя / задняя			W.V.A
-------	----------------------	---	---	-------

			A3	96-	
			A4	94-	
			A6	97-	
			TT	98-	
			TT Coupe/Cabrio	99-	
		CITROEN	C4	04-	
		PEUGEOT	306	93-97	
			307	03-	
			405	87-96	
		RENAULT	Modus	04-	
			Megane Scenic	96-	
			Scenic	03-	
			Scenic RX4	02--04	
		SEAT	Alhambra	96-	
			Leon	99-	
			Toledo	98-	
		SKODA	Fabia	00-	
			Octavia	00-	
		VOLKSWAGEN	Bora	98-	
			Golf	97-	
			Passat	96-	
			Sharan	95-	
Д482	п	FIAT	Tempra	90-96	21100
			Tipo	88-93	
		LANCIA	Dedra	89-94	
Д487	п	HYUNDAI	Avante	95-00	21725/21727
			Coupe	96-97	
			Elantra/Lantra	90-	
			Galloper	97-	
			Sonata	91-98	
		NISSAN	Prairie	89-96	
			Primera	90-98	
Д489	з	TOYOTA	Corolla	01-	
Д492	з	VOLKSWAGEN	Transporter / Caravelle T4	90-98	21154
Д494	п	BMW	300	90-	20968
			500	88-95	
			700	86-94	
			Z3	95-97	
Д495	з	TOYOTA	RAV-4	05-	
		CHERY	Tiggo	06-	
Д497	п	NISSAN	Maxima	89-91, 94-	21561
Д499	п	PEUGEOT	J9	80-92	20366
Д501	п	MERCEDES-BENZ	W	87-93	21055
Д503	п	GREAT WALL	Hoover	06-	
Д505	з	GREAT WALL	Hoover	06-	

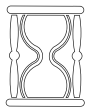
DAFMI	передняя / задняя			W.V.A
-------	----------------------	---	---	-------

Д507	п	MITSUBISHI	Colt	04-	21796
Д511	з	VOLVO	440	88-97	21089
			460	89-96	
			480	87-95	
		SAAB	99	74-80	
			900	79-84, 89-93	
Д530	п	CITROEN	C	81-94	20741
		FIAT	Ducato	81-94	
		PEUGEOT	J5 (light commercial)	81-94	
		TALBOT	Express	82-94	
Д531	п	ЗИЛ	ЗИЛ 5301 "БЫЧОК"	96-	
Д548	з	MERCEDES-BENZ	Sprinter	94-98	21278
		MERCEDES-BENZ	Vito	96-97	
	п	PEUGEOT	106	95-96	
		PEUGEOT	605	89-	
Д551	з	FORD	Puma	97-	21766
			Probe	93-97	
		MAZDA	626	91-97	
			Xedos 6	94-	
Д563	з	HONDA	Civic	87-	21312
			Accord	85-89	
			Prelude	90-91	
			Concerto	89-96	
		ROVER	200	89-96	
			400	89-97	
Д572	п	PEUGEOT	605	91-	21507
Д585	п	MERCEDES-BENZ	G	79-93	21573
			MB 80	93-95	
			MB 100	87-95	
			MB 140	88-95	
			MB 160	91-	
			MB 180	88-95	
Д594	п	FORD	Probe	93-97	21754/21755/21756
			626	91-	
			Premacy	99-	
			XEDOS 6	92-	
Д598	п	AUDI	80	75-78	20228
		VOLKSWAGEN	Scirocco	74-79	
			Golf	76-84	
Д601	п	MITSUBISHI	Colt	90-	21650
			Lancer	88-97	
Д602	п	ALFA ROMEO		78-83	20034
		з	MERCEDES-BENZ	W	



# Таблица применяемости тормозных колодок

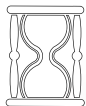

DAFMI	передняя / задняя			W.V.A
-------	----------------------	---	---	-------

	п	OPEL	Kadett C	73-79		
	з	OPEL	Monza	77-87		
	п	OPEL	Record	72-74		
	з	OPEL	Senator	78-90		
	з	VOLVO	240-265	74-93		
	з	VOLVO	740	83-92		
	з	VOLVO	760	82-90		
	з	VOLVO	780 Coupe	86-90		
	з	VOLVO	940	90-95		
	з	VOLVO	960	90-97		
Д608	п	AUDI	50	74-78	20228	
			80	72-81		
		VOLKSWAGEN	Golf	74-83		
			Passat	73-81		
			Jetta	79-84		
		Polo	75-94			
Д609	п	MERCEDES-BENZ	Atego Light	01.95-		
	п/з	ГАЗ	ГАЗ-3310 "ВАЛДАЙ"	01.04-		
Д613	п	FORD	Focus	03-	23723/23724	
			MAZDA	3		03-
				5		05-
Д618	п	NISSAN	Primera	90-96	21280	
Д619	п	NISSAN	Almera	00-	21546	
			Primera	90-96, 98-99		
Д620	п	BMW	300	86-91	20629	
			500	81-87		
			600	82-89		
		PORSCHE	65-85			
Д628	п	FORD	Econovan	86-92	20002	
		KIA		92-97		
		MAZDA	E	87-		
			Econovan	85-91		
Д637	п	VOLKSWAGEN	Transporter/ Bus	90-	20124	
			Caravelle	90-95		
Д638	з	VOLKSWAGEN	Transporter / Caravelle T4	96-	23224	
			Sharan	95-		
		SEAT	Alhambra	95-		
Д641	п	SUBARU	Impreza	93-96	21495/21496	
			Legacy	89-91, 94-		
Д645	п	VOLVO	440	88-97	21216	
			460	89-96		
			480	87-95		
Д646	п	HYUNDAI	Excel	88-91	20703	
			Pony	79-88		
		MITSUBISHI	Colt	80-85		

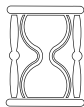
DAFMI	передняя / задняя			W.V.A
-------	----------------------	---	---	-------

			Galant	74-81	
			Lancer	75-79, 83-84	
			Sigma	76-77	
		TOYOTA	Corolla	79-87	
Д647	п	NISSAN	Almera	06-	
Д653	з	SEAT	Toledo	85-	20960/20961
			Cordoba	93-99	
			Ibiza	93-	
		AUDI	A4	97-	
			A6	97-04	
		VOLKSWAGEN	Vento	92-97	
			Passat	85-97	
			Corrado	88-95	
			Golf	84-99	
			Jetta	84-91	
			Lupo	02-	
			Scirocco	85-92	
		PEUGEOT	306	93-97	
			405	87-96	
			307	03-	
		RENAULT	Scenic	03-	
			Modus	04-	
Scenic RX4	02--04				
Megane Scenic	96-				
Grand Scenic	03-				
Д656	п	BA3	BA3 2101,2102, 2105-2107	70-	20166
			BA3 2103	70- 85	
Д674	п	CITROEN	C	86-94	21206/21205
		FIAT	Ducato	86-94	
		PEUGEOT	J5	87-94	
Д679	п	MERCEDES-BENZ	W	79-91	20341
		VOLKSWAGEN	LT	75-96	
Д685	з	FORD	Scorpio	85-98	20981/21079
			Sierra	85-93	
Д687	з	OPEL	Omega	86-	21050
			Senator	87-93	
			Vectra	95-	
		SAAB	900	89-98	
			9--3	98-	
9--5	97-				
Д689	з	FORD	Sierra	87-92	20981
			Scorpio	92-98	
Д698	з	BMW	300	90-	20180
			Z1	88-91	
Д700	п	OPEL	Astra	91-98	20547

# Таблица применяемости тормозных колодок

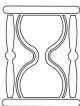

DAFMI	передняя / задняя			W.V.A
-------	-------------------	---	---	-------

			Corsa	88-	
			Tigra	94-	
			Vectra	91-95	
		DAEWOO	Lanos	98-	
Д702	п	CITROEN	C	84-96	21080
			Visa	84-91	
Д711И1	п	ALFA ROMEO		95	21074
		FIAT	Tempra	93-96	
		LANCIA	Dedra	90-	
			Kappa	94-	
			Thema	88-95	
Д711И2	п	ALFA ROMEO		87-95	21074
Д711И3	п	CITROEN		95-	21074
		FIAT	Ulysse	94-	
		LANCIA	Zeta	94-	
		PEUGEOT	806	94-	
Д714	п	FORD	Fiesta	99-	23202/23203
Д717И	п	HONDA	Accord	93-	21651
			Civic	97-	
			CRV	95-	
			HRV	99-	
			Legend	89-98	
			NSX	90-96	
			Prelude	91-	
			Shuttle	95-	
Д720	п	BMW	300	90-	21292/21293
Д736	п	VOLVO	740	83-92	20740
			760	82-90	
			780 Coupe	86-90	
			940	90-95	
			960	90-97	
Д739	п	VOLVO	740	86-92	21233
			760	88-90	
			780 Coupe	86-90	
			940	90-95	
			960	90-97	
Д741	з	MERCEDES-BENZ	W	84-00	20687
Д742	п	MERCEDES-BENZ	W	85-	21028
Д743	п	BA3	BA3 2108-2109 "CAMAPA"	83-	21170
Д744	п	PEUGEOT	205	83-97	21080
			309	85-93	
Д751	з	HONDA	Accord	90-	21719/21720/21721
			Civic	97-	
			Legend	89-	

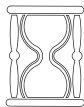
DAFMI	передняя / задняя			W.V.A
-------	----------------------	---	---	-------

			Prelude	90-	
			S200	99-	
			Shuttle	95-	
			Stream	01-	
		ROVER	600	93-98	
			800		
Д763	п	VOLKSWAGEN	Transporter/ Bus	90-	20652
			Transporter / Caravelle T4	90-	
			Caravelle	90-95	
Д765	з	BMW	300	86-	20995
			500	88-95	
			700	86-94	
			Z3	95-97	
Д774	п	MAZDA	121	91-95	21654/20039
			323	89-98	
			Demio	98-	
Д780	п	MITSUBISHI	Eclipse	89-99	21363/21768/21769
			Galant	92-96, 99-00	
			Pajero	91-99	
			Shogun	91-	
			Sigma	90-96	
			Space gear	94-	
Д784	п	VOLVO	240-265	74-93	20200
Д785	п	FORD	Scorpio	85-94	20909/20907
			Sierra	85-92	
Д789	п	FORD	Scorpio	85-94	20907
			Sierra	87-92	
Д791	п	MITSUBISHI	Colt	90-	21647/21648/21649
			Space gear	94-	
			Cordia/Tredia	82-84	
			Eclipse	89-99	
			Galant	90-96	
			Lancer	89-93	
			Space Runner	91-99	
			Space Wagon	91-98	
Д792И	п	ALFA ROMEO		89-98	21182
		FIAT	Croma	87-96	
		LANCIA	Thema	88-94	
Д805	п	KIA	Sportage	94-97	21892
Д816	п	TOYOTA	Carina	92-	21601
			Corolla	92-	
			Picnic	96-	
			Rav 4	94-	
			Camry	91-96	

# Таблица применяемости тормозных колодок

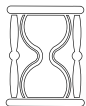

DAFMI	передняя / задняя			W.V.A
-------	----------------------	---	---	-------

Д819	п	VOLVO	740	86-91	20163/20164	
			940	90-95		
			960	90-97		
			S 90	96-		
			V 90	96-		
Д821	з	MITSUBISHI	Pajero	91-99	21840	
			Shogun	91-		
			Space gear	94-		
Д837	п	FORD	Tourneo	94-	21470	
			Transit	91-99		
Д840	п	NISSAN	100	90-95	21657	
			Sunny			
Д864	п	FORD	Tourneo	94-	21469	
			Transit			
Д866	п	ISUZU	Trooper	85-91	21543	
		OPEL	Frontera	92-95		
			Campo	91-		
Д872	п	HONDA	Civic	92-97	21697	
			Logo	99-		
Д884	п	SEAT	Cordoba	93-99	20168	
			Ibiza	93-		
			Toledo	91-98		
		VOLKSWAGEN	Corrado	88-96		
			Golf	90-99		
			Jetta	88-91		
			Passat	84-97		
			Scirocco	90-92		
			Vento	92-97		
			Caddy	96-		
Д885	п	AUDI	A4	94-97	20168	
		SEAT	Toledo	85-98		
			VOLKSWAGEN	Golf		91-99
				Corrado		88-91
				Passat		88-
				Vento		92-97
				Caddy		96-
				Д890		п
Prelude	90-					
ROVER	600	93-98				
Д897	п	TOYOTA	Avensis	97-	21975/21976/21977	
Д916	п	FORD	Cougar	99-	21396	
			Mondeo	93-		
			Scorpio	92-98		
Д926	п	RENAULT	Espace	91-99	20916	

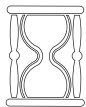
DAFMI	передняя / задняя			W.V.A
-------	----------------------	---	---	-------

			Alpine	91-94	
			Laguna	94-	
			Megane	95-	
			Megane Scenic	96-	
			Safrane	92-	
Д930	п	FORD	Cougar	99-	21395
			Mondeo	93-	
			Scorpio	92-98	
Д934	з	CITROEN	C4	04-	23600
		PEUGEOT	307	03-	
Д937	п	MERCEDES-BENZ	W	93-00	21439
Д938	з	ALFA ROMEO		90-00	21103
		FIAT	Punto	93-98	
			Tempra	90-96	
			Tipo	88-93	
			Uno	85-94	
			Barchetta	95-	
			Coupe	96-	
			Marea	96-	
		LANCIA	Dedra	89-	
			Delta	96-	
Д957	п	AUDI	A3	96-	20676
			A4	94-	
			200	89-90	
		SEAT	Alhambra	03.96-	
			Leon	08.99-	
			Toledo	11.98-08.99	
		SKODA	Fabia	08.00-	
			Octavia	96-	
		VOLKSWAGEN	Bora	04.98-	
			Golf	96-	
			Passat	93-	
			Sharan	95-	
		FORD	Galaxy	95-	
Д957И	п	AUDI	100	90-94	20676
			200	90-94	
			A6	94-	
			Coupe	90-94	
			TT	98-	
Д957И2	п	AUDI	A3	96-	23392
			TT Coupe/Cabrio	99-	
		SEAT	Leon	01-	
			Toledo	01-	
		SKODA	Octavia	00-	
		VOLKSWAGEN	Bora	00-	
			Golf	99-	
Д957И3	п	AUDI	A4	97-	21938/21939

# Таблица применяемости тормозных колодок

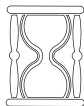

DAFMI	передняя / задняя			W.V.A
-------	----------------------	---	---	-------

			A6	97-04	
Д960	з	FIAT	Croma	85-96	20293
			LANCIA	Dedra	
		Thema		84-95	
		Delta		83-96	
Д966	з	NISSAN	Primera	02-	23482/ 23483
			RENAULT	Espace	
		Grand Espace		02-	
		Laguna		01-	
		Vel Satis		02-	
		MAZDA	3	03-	
FORD	Focus	03-			
Д968	п	HONDA	Accord	85-93	20099/20104
			Ballade	86-93	
			Civic	83-88	
			Civic	88-92	
			Integra	86-88	
Д974	п	TOYOTA	4-Runner	87-89	20852
			Hi-Lux	78-88	
			Land cruiser	75-	
Д983	п	FORD	Sierra	87-93	21141
			Transit	86-91	
Д989	п п/з п	IVECO	Eurocargo	91-96	29835
		IVECO	Eurocargo Range	91-	
		MERCEDES-BENZ	D	86-96	
Д991	п	HONDA	Accord	83-90	21012
			HYUNDAI	Atos	
		Accent		94-	
		Excel		88-99	
		Pony		88-99	
		S-Coupe		90-93	
		Stellar	86-90		
Д996	п	RENAULT	Trafic	80-	20928
			R	75-84	
		TOYOTA	Carina	88-89	
			Corolla	88-91	
125.38.102A-01		ТРАКТОР	T-150K	72-	
3518020-45860-01		КОМБАЙН	ДОН-1500	91-	
45-3502040A-01		ТРАКТОР	ЮМЗ-6	94-	
P406		СНЕГОХОД	"Тайга"	98-	
TK 0100.000		ТРАМВАЙ	T-3 M	94-	
ДА110	з	ЗАЗ	ЗАЗ 1102 "Таврия"	86-	
			ЗАЗ 1103 "Славута"	99-	
ДА124	з	ГАЗ	ГАЗ 3102 "ВОЛГА"	87-	
			ГАЗ 3110 "ВОЛГА"	96-	
			ГАЗ 2410 "ВОЛГА"	72- 85	
ДА132	з	CHEVROLET	Lanos	98-	
			DAEWOO	Sens	
		Nubira		97-01	
		Aranos		95-97	
ДА136	з	DAEWOO	Tico	94-00	

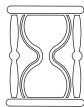
DAFMI	передняя / задняя			W.V.A
-------	----------------------	---	---	-------

			Matiz	98-	
			Nexia	93-	
			Espero	95-	
ДА137	3	SKODA	Octavia	96-	
ДА140	3	BA3	BA3 2110	95-	
			BA3 2108-2109 "САМАРА"	83-	
ДА141	3	АЗЛК/ ИЖ	М 2141	83-	
ДА179	3	PEUGEOT	206	98-01	
ДА184	3	OPEL	Astra	98-	
			Vectra	95-	
ДА189	3	FORD	Focus	98-	
ДА269	3	OPEL	Ascona	81-88	
			Kadett	79-91	
ДА309	3	FORD	Sierra	82-93	
ДА339	3	DACIA	Logan	04-	
		RENAULT	Logan	04-	
ДА327	3	VOLKSWAGEN	Passat	88-90	
			Golf	93-99	
			Caddy	84-93	
		AUDI	80	86-94	
			100	82-90	
ДА366	3	AUDI	50	74-78	
			80	72-86	
			100	76-82	
		SEAT	Arosa	97-	
			Cordoba	93-99	
			Ibiza	93-94	
			Toledo	91-	
		VOLKSWAGEN	Golf	74-93	
			Jetta	79-92	
			Lupo	98-	
			Polo	90-	
			Passat	80-88	
			Santana	81-85	
			Scirocco	79-82	
ДА412	3	АЗЛК/ ИЖ	М 2140	70-	
			М 412	68-	
ДА443	3	ГАЗ	ГАЗ 3302 "ГАЗЕЛЬ"	94-	
ДА531	3	ЗИЛ	ЗИЛ 5301 "БЫЧОК"	96-	
ДА603	3	BA3	BA3 2103	70- 85	
ДА656	3	BA3	BA3 2121 "НИВА"	76-	
			BA3 2123 "CHEVROLET-NIVA"	02-	
			BA3 2101,2102, 2105-2107	70-	
		CHEVROLET	BA3 2123	02-	



# Таблица применяемости тормозных колодок

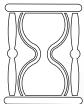

DAFMI	передняя / задняя			W.V.A
-------	----------------------	---	---	-------

ДА700	3	OPEL	Astra	91-98	
			Corsa	93-	
			Tigra	94-	
ДА837	3	FORD	Tourneo	94-	
			Transit	91-99	
ДА884	3	AUDI	80	86-91	
			A2	00-05	
		SEAT	Arosa	97-	
			Ibiza	93-	
			Cordoba	95-	
			Toledo	85-98	
		SKODA	Felicia	95-01	
		VOLKSWAGEN	Golf	91-	
			Lupo	98-	
			Polo	94-	
			Santana	81-85	
Vento	92-97				
ДА885	3	SKODA	Fabia	99-	
		AUDI	80	80-91	
		VOLKSWAGEN	Passat	80-88	
ДА916	3	FORD	Mondeo	93-	
ДА991	3	HYUNDAI	Accent	94-	
ДА995	3	FORD	Transit	00-	

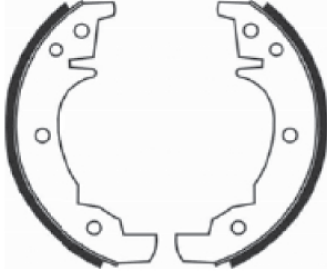
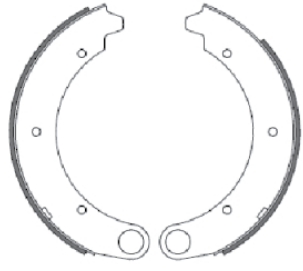
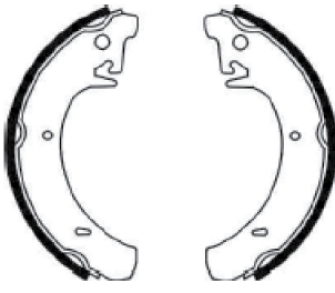
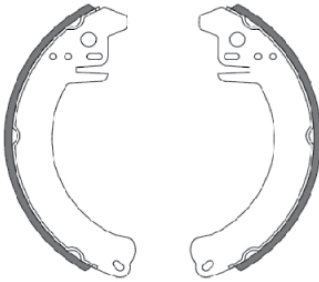
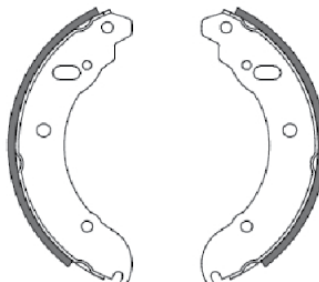
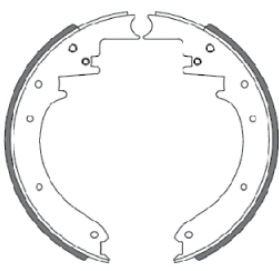
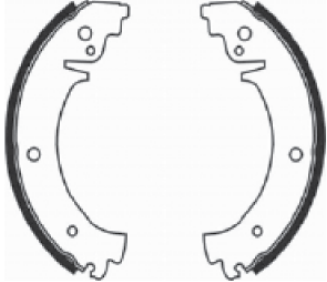
<b>ДА110</b>	180x30	<b>ДА124</b>	280x70	<b>ДА140</b>	200x41
					
ТАВРИЯ ЗАЗ 1102		ВОЛГА ГАЗ-24		ЛАДА ВАЗ 2108-2110	
<b>ДА412</b>	230x40	<b>ДА443</b>	280x70	<b>ДА531</b>	318x80
					
Москвич 412		Газель ГАЗ-3302		Бычек ЗИЛ-5301	
<b>ДА656</b>	250x51				
					
Жигули ВАЗ 2101-2107					

Колодки барабанного тормоза  
Графические изображения



<b>ДА132</b>	200x46	<b>ДА136</b>	180x30	<b>ДА137</b>	230x32
DAEWOO, CHEVROLET		DAEWOO		SKODA	
<b>ДА179</b>	180x32	<b>ДА184</b>	230x42	<b>ДА189</b>	203x38
PEUGEOT		OPEL		FORD	
<b>ДА269</b>	200x46	<b>ДА309</b>	228,6x57	<b>ДА327</b>	230x40
OPEL		FORD		AUDI, VW	
<b>ДА339</b>	203x38	<b>ДА366</b>	180x31	<b>ДА700</b>	200x29
RENAULT, DACIA		AUDI VOLKSWAGEN		OPEL	

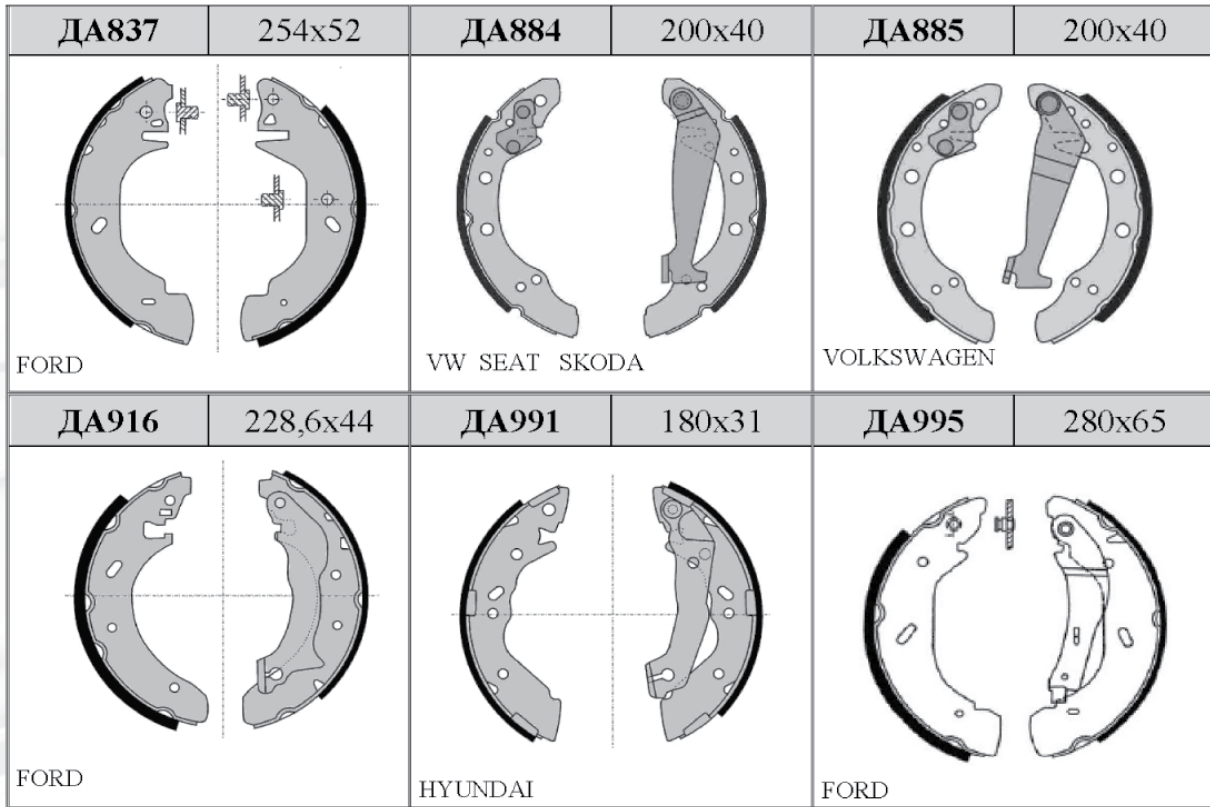

## Таблицы соответствия колодок барабанного тормоза

REMSA	DAfmi	DELPHI	DAfmi	JURID	DAfmi	LUCAS	DAfmi	LPR	DAfmi	MAFF	DAfmi	FOMAR	DAfmi
4040	ДА189	LS1268	ДА309	361216	ДА366	GS6207	ДА309	140	ДА366	93014	ДА366	342	ДА327
4045	ДА366	LS1276	ДА366	361260	ДА885	GS6212	ДА269	150	ДА327	93015	ДА327	343	ДА366
4046	ДА885	LS1277	ДА885	361302	ДА309	GS8092	ДА885	4100	ДА885	93410	ДА885	344	ДА885
4046.01	ДА884	LS1292	ДА269	361417	ДА269	GS8113	ДА327	4640	ДА269	93464	ДА269	385	ДА309
4063	ДА309	LS1317	ДА327	361560	ДА837	GS8166	ДА366	6760	ДА837	93676	ДА837	419	ДА269
4076	ДА179	LS1621	ДА700	361576	ДА700	GS8526	ДА884	6790	ДА700	93679	ДА700	563	ДА700
4082	ДА137	LS1622	ДА132	361578	ДА884	GS8536	ДА916	6800	ДА132	93680	ДА132	571	ДА884
4086	ДА136	LS1625	ДА884	362218	ДА132	GS8539	ДА837	6830	ДА884	93683	ДА884	625	ДА916
4088	ДА269	LS1631	ДА837	362288	ДА916	GS8542	ДА700	7100	ДА916	93710	ДА916	635	ДА132
4117	ДА991	LS1746	ДА916	362385	ДА137	GS8543	ДА132	7200	ДА184	93718	ДА991	644	ДА837
4300	ДА916	LS1784	ДА137	362389	ДА184	GS8636	ДА189	7260	ДА136	93740	ДА184	672	ДА184
4305	ДА837	LS1821	ДА136	362391	ДА189	GS8637	ДА184	7300	ДА137	93743	ДА136	705	ДА137
4307	ДА700	LS1829	ДА184	362393	ДА179	GS8639	ДА137	7380	ДА189	93747	ДА189	716	ДА189
4397	ДА327	LS1836	ДА991	362394	ДА136	GS8642	ДА179	7430	ДА179	93748	ДА179	719	ДА179
4398	ДА132	LS1848	ДА179	362395	ДА991	GS8645	ДА136	7870	ДА991	93800	ДА137	724	ДА136
4422	ДА184	LS1850	ДА189			GS8658	ДА991	1380B	ДА309	931381	ДА309	769	ДА991
4199.01	ДА339	LS1717	ДА339	362318	ДА339	GS8534	ДА339	7130	ДА339	93711	ДА339		ДА339
4108	ДА995	LS1914	ДА995		ДА995	GS8690	ДА995	7790	ДА995	93829	ДА995		ДА995

**С помощью нашего каталога Вы очень легко сможете подобрать  
тормозной шланг к определенному автомобилю.**

		i	Код Дафми	Дополнительная информация	Тип №
1	2	3	4	5	6

В разделах «Тормозные шланги для автомобилей иностранного производства» и «Тормозные шланги для автомобилей производства стран СНГ» в алфавитном порядке указаны производители автомобилей. В первой колонке – модель автомобиля с необходимыми данными. Во второй колонке – дата производства данной модели. Номера и типы тормозных шлангов ДАФМИ указаны в колонках 4 и 6. В колонках 3 и 5 под знаком «i» указывается дополнительная информация о шлангах:

- |   |                            |   |                          |
|---|----------------------------|---|--------------------------|
| ↖ | Левый передний шланг       | ↙ | Левый задний шланг       |
| ↗ | Правый передний шланг      | ↘ | Правый задний шланг      |
| ↑ | Центральный передний шланг | ↓ | Центральный задний шланг |

В соответствии с кодом шланга определен круг моделей, для которых он применяется (см. раздел «Краткие таблицы применимости»). По типу, которому соответствует конкретный шланг (колонка 6), осуществляется переход к разделу «Графические изображения и размеры», где дана более подробная информация о тормозном шланге: графические изображения, геометрические размеры, наличие дополнительных аксессуаров и др.

В случае, если в Каталоге указаны два типа шлангов на один автомобиль (это возможно, если применяются различные поставщики элементов тормозной системы), то обязательно для проверки используйте раздел «Графические изображения и размеры».

В качестве дополнительной информации в Каталоге представлен раздел «Таблицы соответствия OEM – ДАФМИ», в котором приведены номера тормозных шлангов в системе кодировки производителей автомобилей и соответствующие им номера ДАФМИ.

**ВНИМАНИЕ!** В настоящем Каталоге в обозначении тормозных шлангов используется **Система кодировки ДАФМИ**, которая отличается от систем кодирования других производителей. При подборе тормозных шлангов используйте **Каталог тормозных шлангов ДАФМИ**.







Структура кода тормозного шланга ДАФМИ следующая:

**31.001.010.000.1**  
1            2            3            4            5



















































- 1**    Обозначение товарной группы «Тормозные шланги ДАФМИ»
- 2**    Порядковый номер (полностью идентифицирует тормозной шланг)
- 3**    Тип тормозного шланга (дополнительная информация)
- 4**    Технологическая группа знаков
- 5**    Обозначение упаковки: 1 – в индивидуальной упаковке, 0 – без упаковки

		i	Код Дафми	Дополнительная информация	Тип №
---	---	---	-----------	---------------------------	-------

## ALFA ROMEO











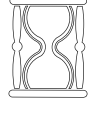































145 (930)					
All models	07.94 -		31.094.018.000.1		018
Alfasud (901)					
All models	- 09.84		31.006.005.000.1		005
Alfasud sprint (902.A)					
1,3 1,4 1,5 1,7 1,7i.e.	- 07.85		31.006.005.000.2		005
AR 6 box body					
2,4 TD 2,5 D	03.86 - 12.89		31.095.007.000.1	Нижний	007
	03.86 - 12.89		31.098.007.000.1	Верхний	007
	03.86 - 12.89		31.014.008.000.1		008

## AUDI

50(86)					
1,1 1,3	08.74 - 07.78		31.009.005.000.1	К суппорту	005
	08.74 - 07.78		31.016.026.000.1		026
	08.74 - 07.78		31.009.005.000.1		005
80 МК II.(82)					
1,3 1,6 1,6 GTE	08.76 - 07.78		31.020.005.000.1		005
	08.76 - 07.78		31.016.026.000.1		026
80 МК III. (81,85)					
1,3	09.78 - 07.86		31.020.005.000.1	Шасси 81A0190514-	005
	09.78 - 07.86		31.022.026.000.1		026
	09.78 - 07.86		31.144.026.000.1		026
1,6	08.78 - 07.86		31.020.005.000.1		005
	08.78 - 07.86		31.022.026.000.1		026
	08.78 - 07.86		31.016.026.000.1		026
1,6 D	08.80 - 08.86		31.020.005.000.1		005
	08.80 - 08.86		31.016.026.000.1		026
	08.80 - 08.86		31.022.026.000.1		026
1,6 GLE	01.79 - 06.82		31.020.005.000.1	Шасси 81A0190514-	005
	01.79 - 06.82		31.022.026.000.1		026
	01.79 - 06.82		31.144.026.000.1		026
1,6TD	08.81 - 05.86		31.020.005.000.1		005
	08.81 - 05.86		31.016.026.000.1		026
	08.81 - 05.86		31.022.026.000.1		026
1,8	03.82 - 08.86		31.020.005.000.1		005
	03.82 - 08.86		31.016.026.000.1		026
	03.82 - 08.86		31.022.026.000.1		026
1,8 GTE	08.85 - 07.86		31.020.005.000.1		005
	08.85 - 07.86		31.016.026.000.1		026
	08.85 - 07.86		31.022.026.000.1		026
1,8 GTE quattro	03.85 - 08.86		31.020.005.000.1		005
1.9CD5S	09.81 - 07.83		31.020.005.000.1		005
	09.81 - 07.83		31.016.026.000.1		026
	09.81 - 07.83		31.022.026.000.1		026
2,0, 2,0 quattro	10.83 - 09.84		31.020.005.000.1		005
	10.83 - 09.84		31.016.026.000.1		026
	10.83 - 09.84		31.022.026.000.1		026
80 МК IV. (89,89Q,8A)					
1,6	09.86 - 09.91		31.015.005.000.1	Шасси 8AL038657- I К суппорту	005
	09.86 -		31.020.005.000.1		005
	09.86 - 09.91		31.015.005.000.1		К суппорту
1,6 D	02.87 - 08.89		31.020.005.000.1	К суппорту	005
	09.86 - 08.91		31.015.005.000.1	К суппорту	005
	09.89 - 08.91		31.015.005.000.1	К суппорту	005
1,6 TD 1,9 D	- 08.91		31.015.005.000.1	Шасси 8AL038657- I К суппорту	005
	- 08.91		31.020.005.000.1		-Шасси 8AL038656
	- 08.91		31.015.005.000.1		К суппорту
	- 08.91		31.022.026.000.1		026
1,8 quattro 1,8 E quattro	09.86 -		31.015.005.000.1	Шасси 8AL030001- I К суппорту	005
	09.86 -		31.020.005.000.1		-Шасси 8AL030000
1,8 1,8 S 1,8 E	06.86 -		31.015.005.000.1	Шасси 8AL038657- I К суппорту	005
	06.86 -		31.020.005.000.1		-Шасси 8AL038656
	06.86 -		31.015.005.000.1		К суппорту
2,0 E	08.88 - 10.90		31.015.005.000.1	Шасси 8AL038657- I К суппорту	005
	08.88 - 10.90		31.020.005.000.1		-Шасси 8AL038656
	08.88 - 10.90		31.015.005.000.1		К суппорту
2,0 quattro 2,0 E16V quattro	- 08.91		31.015.005.000.1	Шасси 8AL030001-	005
	- 08.91		31.020.005.000.1		-Шасси 8AL030000
2,0 2,0 E 16V	03.90-09.91		31.015.005.000.1	Шасси 8AL038657- I К суппорту	005

# Таблица применяемости тормозных шлангов

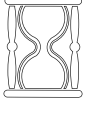

		i	Код Дафми	Дополнительная информация	Тип №
	03.90 - 09.91		31.020.005.000.1	-Шасси 8AL038656	005
	03.90 - 09.91		31.015.005.000.1	К суппорту	005
<b>80 MK V. (8C,B4)</b>					
1,6 E	06.93 - 12.94		31.015.005.000.1	К суппорту	005
1,6 2,0 2,0 E	09.91 - 12.94		31.015.005.000.1	К суппорту	005
2,0 E 16V	08.92 - 12.94		31.015.005.000.1	К суппорту	005
2,0 E 16V quattro	04.92 - 07.94		31.015.005.000.1	К суппорту	005
	04.92 - 07.94		31.005.005.000.1	К суппорту	005
2,0 e quattro	09.91 - 07.94		31.015.005.000.1	К суппорту	005
	09.91 - 07.94		31.005.005.000.1	К суппорту	005
2,2 S2 quattro	02.93 - 12.94		31.015.005.000.1	К суппорту	005
	02.93 - 12.94		31.005.005.000.1	К суппорту	005
2,3 E	09.91 - 12.95		31.015.005.000.1	К суппорту	005
2,3 E quattro	09.91 - 12.94		31.015.005.000.1	К суппорту	005
	09.91 - 12.94		31.005.005.000.1	К суппорту	005
2,6 V6	07.92 - 12.95		31.015.005.000.1	К суппорту	005
2,6 V6 quattro	06.92 - 07.95		31.015.005.000.1	К суппорту	005
	06.92 - 07.95		31.005.005.000.1	К суппорту	005
2,8 E quattro	09.91 - 07.95		31.015.005.000.1	К суппорту	005
	09.91 - 07.95		31.005.005.000.1	К суппорту	005
2,8 E 1,9 TD 1,9 TDI	09.91 - 12.95		31.015.005.000.1	К суппорту	005
<b>80 MK V. Avant (8C,B4)</b>					
1,6	06.93 - 01.96		31.015.005.000.1	К суппорту	005
2,0 2,0 E	07.92 - 01.96		31.015.005.000.1	К суппорту	005
2,0 E 16V	02.93 - 01.96		31.015.005.000.1	К суппорту	005
2,0 E 16V quattro	12.92 - 07.95		31.015.005.000.1	К суппорту	005
	12.92 - 07.95		31.005.005.000.1	К суппорту	005
2,2 RS2 quattro	03.94 - 05.95		31.015.005.000.1	К суппорту	005
	03.94 - 05.95		31.005.005.000.1	К суппорту	005
2,2 S2 quattro	02.93 - 07.95		31.015.005.000.1	К суппорту	005
	02.93 - 07.95		31.005.005.000.1	К суппорту	005
<b>90 (81,85)</b>					
2,0	10.84 - 03.87		31.020.005.000.1		005
	10.84 - 03.87		31.022.026.000.1		026
2,2	10.84 - 03.87		31.020.005.000.1	К суппорту	005
	10.84 - 03.87		31.015.005.000.1		005
	10.84 - 03.87		31.022.026.000.1		026
	10.84 - 03.87		31.020.005.000.1		005
2,2 E quattro	11.84 - 03.87		31.020.005.000.1		005
<b>90 (89, 89Q, 8A)</b>					
1,6D	04.87 - 09.91		31.015.005.000.1	Шасси 8AL038657-	005
	04.87 - 09.91		31.020.005.000.1	-Шасси 8AL038656	005
	04.87 - 09.91		31.015.005.000.1	К суппорту	005
2,0	07.88 - 07.91		31.015.005.000.1	Шасси 8AL038657-	005
	07.88 - 07.91		31.020.005.000.1	-Шасси 8AL038656	005
	07.88 - 07.91		31.015.005.000.1	К суппорту	005
2,2 E	04.87 - 07.91		31.015.005.000.1	К суппорту	005
	04.87 - 07.91		31.020.005.000.1	-Шасси 8AL038656	005
	04.87 - 07.91		31.015.005.000.1	К суппорту	005
2,2 E quattro	04.87 - 09.91		31.015.005.000.1	Шасси 8AL030001-	005
	04.87 - 09.91		31.020.005.000.1	-Шасси 8AL030000	005
2,3 E	03.90 - 07.91		31.015.005.000.1	К суппорту	005
2,3 E 20V	04.90 - 07.91		31.015.005.000.1	К суппорту	005
	04.90 - 07.91		31.015.005.000.1	К суппорту	005
2,3 E 20V quattro	06.88 - 09.91		31.015.005.000.1	Шасси 8AL030001-	005
	06.88 - 09.91		31.172.045.000.1		045
2,3 E quattro	04.90 - 09.91		31.015.005.000.1	К суппорту	005
<b>100 (43)</b>					
All models	08.76 - 07.82		31.024.005.000.1		005
	08.76 - 07.82		31.016.026.000.1		026
	08.76 - 07.82		31.011.026.000.1		026
<b>100 (44,44Q) /Avant/</b>					
1,8	01.86 - 07.89		31.019.006.000.1	К шасси	006
	01.86 - 07.89		31.060.026.000.1	Шасси 44G073363- 1 Барабанные тормоза	026
	08.82 - 07.89		31.020.005.000.1	Шасси 44G200001-	005
	08.82 - 07.89		31.047.026.000.1	-Шасси 44G200000	026
	08.82 - 12.85		31.016.026.000.1	-Шасси 44G073362 1 Барабанные тормоза	026
	08.82 - 12.85		31.019.006.000.1	-Шасси 44G073362 1 К суппорту 1 К шасси	006
	08.82 - 12.85		31.060.026.000.1	К шасси	026
1,8 KAT	08.86 - 07.90		31.020.005.000.1	Шасси 44G200001-	005
	08.86 - 07.90		31.047.026.000.1	-Шасси 44G200000	026
	08.86 - 07.90		31.005.005.000.1	К суппорту	005

		i	Код Дафми	Дополнительная информация	Тип №
1,8 1,8 KAT	01.88 - 11.90	↗	31.020.005.000.1	Шасси 44G200001-	005
	01.88 - 11.90	↘	31.047.026.000.1	-Шасси 44G200000	026
	01.88 - 07.89	↖	31.060.026.000.1	К суппорту	026
	01.88 - 11.90	↗	31.005.005.000.1		005
	08.89 - 11.90	↘	31.016.026.000.1		026
1,9	08.82 - 07.84	↗	31.047.026.000.1	Дисковые тормоза   К суппорту	026
	08.82 - 07.84	↘	31.019.006.000.1		006
2,0	08.82 - 07.84	↖	31.060.026.000.1	Дисковые тормоза	026
	07.86 - 12.87	↖	31.060.026.000.1	Шасси 44G200001-   Барабанные тормоза	026
	08.84 - 12.87	↗	31.020.005.000.1	Шасси 44G200001-	005
	08.84 - 12.87	↘	31.047.026.000.1	-Шасси 44G200000	026
	08.84 - 06.86	↖	31.016.026.000.1	-Шасси 44G200000   Барабанные тормоза	026
2,0 D 2,0 D Turbo	08.84 - 12.85	↗	31.019.006.000.1	Дисковые тормоза	006
	08.84 - 12.87	↘	31.060.026.000.1	К шасси	026
	07.86 - 07.88	↖	31.060.026.000.1	Шасси 44G200001-   Барабанные тормоза	026
	08.82 - 07.88	↗	31.020.005.000.1	Шасси 44G200001-	005
	08.82 - 07.88	↘	31.047.026.000.1	-Шасси 44G200000	026
2,0 KAT	08.82 - 12.85	↖	31.019.006.000.1	-Шасси 44G073362   Дисковые тормоза	006
	08.82 - 07.84	↗	31.060.026.000.1	-Шасси 44E300000   Барабанные тормоза	026
	08.84 - 06.86	↘	31.016.026.000.1	Шасси 44F000001-   Барабанные тормоза   -Шасси 44G200000	026
	01.88 - 11.90	↗	31.020.005.000.1	Шасси 44G200000 -	005
	01.88 - 11.90	↘	31.047.026.000.1	-Шасси 44G200000	026
2,0 KAT	01.88 - 07.89	↖	31.060.026.000.1	К суппорту	026
	01.88 - 11.90	↗	31.005.005.000.1		005
	08.89 - 11.90	↘	31.016.026.000.1		026
	08.82 - 07.84	↖	31.019.006.000.1	Шасси 44G000001-   Шасси 44G200000	006
	08.82 - 07.84	↗	31.020.005.000.1	Шасси 44G 200001-	005
2,1	08.82 - 07.84	↘	31.047.026.000.1	-Шасси 44G200000   -CS	026
	08.82 - 07.84	↗	31.047.026.000.1	-Шасси 44F 150000	026
	08.82 - 07.84	↖	31.019.006.000.1		006
	07.86 - 09.86	↖	31.060.026.000.1	Шасси 44G00001-   Барабанные тормоза	026
	10.84 - 09.86	↗	31.020.005.000.1	Шасси 44G200001-	005
2,2	10.84 - 09.86	↘	31.047.026.000.1	-Шасси 44G200000	026
	10.84 - 06.86	↖	31.016.026.000.1	-Шасси 44G200000   Барабанные тормоза	026
	10.84 - 12.85	↗	31.019.006.000.1	-Шасси 44G073362   Дисковые тормоза	006
	10.84 - 09.86	↘	31.060.026.000.1	Дисковые тормоза	026
	08.84 - 12.88	↖	31.020.005.000.1	Шасси 44G200001-	005
2,2 (44)	08.84 - 12.88	↗	31.047.026.000.1	-Шасси 44G200000   -CS	026
	08.84 - 12.88	↘	31.047.026.000.1	-Шасси 44F150000	026
	08.84 - 12.85	↖	31.019.006.000.1	-Шасси 44G073362	006
	08.84 - 12.88	↘	31.060.026.000.1		026
	08.85 - 07.86	↖	31.019.006.000.1	-Шасси 44G200000   Без ABS	006
2,2 E quattro	08.85 - 07.86	↗	31.020.005.000.1	Шасси 44G200001-   C ABS	005
	08.85 - 07.86	↘	31.047.026.000.1	-Шасси 44G200000   C ABS	026
	08.85 - 07.86	↖	31.005.005.000.1		005
	08.85 - 07.86	↘	31.005.005.000.1		005
2,2 E Turbo quattro	08.86 - 11.90	↖	31.019.006.000.1	-Шасси 44G200000   Без ABS	006
	08.86 - 11.90	↗	31.020.005.000.1	Шасси 44G200001-   C ABS	005
	08.86 - 11.90	↘	31.047.026.000.1	-Шасси 44G200000   C ABS	026
	08.86 - 11.90	↖	31.005.005.000.1		005
2,2 KAT	06.89 - 11.90	↗	31.020.005.000.1	Шасси 44G200001-	005
	06.89 - 11.90	↘	31.047.026.000.1	-Шасси 44G200000   -CS	026
	06.89 - 07.89	↖	31.060.026.000.1	К суппорту	026
	06.89 - 11.90	↗	31.005.005.000.1		005
	08.89 - 11.90	↘	31.016.026.000.1		026
2,2 quattro	08.84 - 12.88	↖	31.019.006.000.1	-Шасси 44G200000   Без ABS	006
	08.84 - 12.88	↗	31.020.005.000.1	Шасси 44G200001-   C ABS	005
	08.84 - 12.88	↘	31.047.026.000.1	-Шасси 44G200000   C ABS	026
	08.84 - 12.88	↖	31.005.005.000.1		005
2,2 quattro KAT	06.89 - 11.90	↖	31.019.006.000.1	-Шасси 44G200000   Без ABS	006
	06.89 - 11.90	↗	31.047.026.000.1	-Шасси 44G200000   C ABS	026
	06.89 - 11.90	↘	31.005.005.000.1		005
2,2 Turbo	08.86 - 11.90	↖	31.020.005.000.1	К суппорту	005
	08.86 - 07.89	↗	31.060.026.000.1		026
	08.86 - 11.90	↘	31.005.005.000.1		005
	08.89 - 11.90	↖	31.016.026.000.1		026
	01.90 - 11.90	↗	31.020.005.000.1		Шасси 44G200001-
2,3 E	01.90 - 11.90	↘	31.047.026.000.1	-Шасси 44G200000   -CS	026
	01.90 - 11.90	↖	31.016.026.000.1		026
	01.90 - 11.90	↗	31.005.005.000.1	К суппорту	005
	01.90 - 11.90	↘	31.005.005.000.1		005
2,3 E (44)	08.89 - 11.90	↖	31.016.026.000.1		026



# Таблица применяемости тормозных шлангов

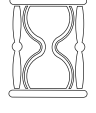

		i	Код Дафми	Дополнительная информация	Тип №
	10.86 - 11.90	↗↗	31.019.006.000.1	Шасси 44G000001-1-Шасси 44G200000	006
	10.86 - 11.90	↗↗	31.020.005.000.1	Шасси 44G200001-	005
	10.86 - 11.90	↗↗	31.047.026.000.1	-Шасси 44G200000 1-CS	026
	10.86 - 11.90	↗↗	31.047.026.000.1	-Шасси 44F150000	026
	10.86 - 07.89	↘↘	31.060.026.000.1		026
	10.86 - 11.90	↘↘	31.005.005.000.1	К суппорту	005
2,3 E quattro	08.86 - 11.90	↗↗	31.019.006.000.1	-Шасси 44G200000 1 Без ABS	006
	08.86 - 11.90	↗↗	31.020.005.000.1	Шасси 44G200001-1 С ABS	005
	08.86 - 11.90	↗↗	31.047.026.000.1	-Шасси 44G200000 1 С ABS	026
	08.86 - 11.90	↘↘	31.005.005.000.1		005
2,3 quattro	01.90 - 11.90	↗↗	31.019.006.000.1	-Шасси 44G200000 1 Без ABS	006
	01.90 - 11.90	↗↗	31.047.026.000.1	-Шасси 44G200000 1 С ABS	026
	01.90 - 11.90	↘↘	31.005.005.000.1		005
2,4 D	08.89 - 12.90	↗↗	31.020.005.000.1		005
	08.89 - 07.91	↘↘	31.016.026.000.1		026
	08.89 - 07.91	↘↘	31.005.005.000.1	К суппорту	005
2,5 TDI	01.90 - 11.90	↗↗	31.020.005.000.1		005
	01.90 - 11.90	↘↘	31.016.026.000.1		026
	01.90 - 11.90	↘↘	31.005.005.000.1	К суппорту	005
<b>100 (4A,C4) /Avant/</b>					
2,0 E quattro	12.90 - 07.92	↗↗	31.172.045.000.1		045
	12.90 - 07.92	↘↘	31.005.005.000.1	-Шасси 4AM150000	005
2,0 2,0 E 2,0 E 16V 2,3 E	- 06.94	↗↗	31.172.045.000.1		045
	- 06.94	↘↘	31.016.026.000.1		026
	01.90 - 11.90	↘↘	31.005.005.000.1	К суппорту	005
2,2 S4 Turbo quattro	08.91 - 06.94	↗↗	31.172.045.000.1		045
	08.91 - 06.94	↘↘	31.005.005.000.1	-Шасси 4AM150000	005
2,3 e quattro 2,8 E quattro	12.90 - 06.94	↗↗	31.172.045.000.1		045
	12.90 - 06.94	↘↘	31.005.005.000.1	-Шасси 4AM150000	005
2,4 D 2,5 TDI	05.91 - 06.94	↗↗	31.172.045.000.1		045
	05.91 - 06.94	↘↘	31.016.026.000.1		026
	05.91 - 06.94	↘↘	31.005.005.000.1	К суппорту	005
2,6 V6 quattro	04.92 - 06.94	↗↗	31.016.026.000.1		026
	04.92 - 06.94	↘↘	31.005.005.000.1	-Шасси 4AM150000	005
2,6 V6, 2,8 E	- 06.94	↗↗	31.016.026.000.1		026
	- 06.94	↘↘	31.016.026.000.1		026
	- 06.94	↘↘	31.005.005.000.1	К суппорту	005
4,2 S4 V8 quattro	10.92 - 06.94	↗↗	31.016.026.000.1		026
	10.92 - 06.94	↘↘	31.005.005.000.1	-Шасси 4AM150000	005
<b>100Avant(43)</b>					
All models	07.77 - 02.83	↗↗	31.024.005.000.1		005
	07.77 - 02.83	↘↘	31.016.026.000.1		026
	07.77 - 02.83	↘↘	31.011.026.000.1		026
<b>100 I</b>					
1,6	01.75 - 07.76	↗↗	31.007.005.000.1		005
	01.75 - 07.76	↘↘	31.016.026.000.1		026
1,7 LS	10.70 - 07.76	↗↗	31.007.005.000.1		005
	10.70 - 07.76	↘↘	31.016.026.000.1		026
1,9 GL	09.71 - 07.76	↗↗	31.009.005.000.1		005
	09.71 - 07.76	↘↘	31.016.026.000.1		026
<b>200 (43)</b>					
2,1 SE, 2,1 5T	10.79 - 09.82	↗↗	31.019.006.000.1		006
	10.79 - 09.82	↘↘	31.015.005.000.1	К суппорту	005
	10.79 - 09.82	↘↘	31.016.026.000.1		026
<b>200 (44,440) /Avant/</b>					
2,1 SE	08.83 - 07.84	↗↗	31.047.026.000.1	-Шасси 44G200000	026
	08.83 - 07.84	↘↘	31.016.026.000.1	Шасси 44G073363-	026
	08.83 - 07.84	↘↘	31.019.006.000.1	-Шасси 44G073362	006
	08.83 - 07.84	↘↘	31.060.026.000.1	-Шасси 44G073362	026
	08.83 - 07.84	↘↘	31.005.005.000.1	Шасси 44G073362-1 К суппорту	005
2,1 Turbo	08.83 - 01.88	↗↗	31.047.026.000.1	-Шасси 44G200000	026
	08.83 - 01.88	↘↘	31.016.026.000.1	Шасси 44G073363-	026
	08.83 - 01.88	↘↘	31.019.006.000.1	-Шасси 44G073362	006
	08.83 - 01.88	↘↘	31.060.026.000.1	-Шасси 44G073362	026
	08.83 - 01.88	↘↘	31.005.005.000.1	Шасси 44G073363-1 К суппорту	005
2,1 Turbo quattro	08.83 - 09.86	↗↗	31.047.026.000.1	-Шасси 44G200000	026
	08.83 - 12.85	↘↘	31.142.005.000.1		005
	08.83 - 12.85	↘↘	31.005.005.000.1		005
2,2	08.84 - 07.85	↗↗	31.047.026.000.1	-Шасси 44G200000	026
	08.84 - 07.85	↘↘	31.016.026.000.1	Шасси 44G073363-	026
	08.84 - 07.85	↘↘	31.019.006.000.1	-Шасси 44G073362	006

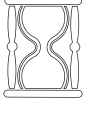
		i	Код Дафми	Дополнительная информация	Тип №
	08.84 - 07.85	↙	31.060.026.000.1	-Шасси 44G073362	026
	08.84 - 07.85	↘	31.005.005.000.1	Шасси 44G073363- 1 К суппорту	005
2,2 Turbo	02.88 - 12.90	↘	31.016.026.000.1		026
	02.88 - 12.90	↙	31.005.005.000.1		005
2,2 Turbo (44)	08.85 - 09.91	↗	31.047.026.000.1	-Шасси 44G200000	026
	08.85 - 09.91	↘	31.016.026.000.1	Шасси 44G073363-	026
	08.85 - 09.91	↙	31.019.006.000.1	-Шасси 44G073362	006
	08.85 - 09.91	↙	31.060.026.000.1	-Шасси 44G073362	026
	08.84 - 07.85	↘	31.005.005.000.1	Шасси 44G073363- 1 К суппорту	005
2,2 Turbo quattro (44Q)	01.85 - 12.91	↗	31.047.026.000.1	-Шасси 44G200000	026
	01.85 - 12.91	↘	31.005.005.000.1		005
2,3	11.86 - 09.91	↘	31.016.026.000.1		026
	11.86 - 09.91	↙	31.005.005.000.1	К суппорту	005
<b>A6 (4A,C4) /Avant/</b>					
1,8 20V quattro	12.95 - 02.97	↗	31.172.045.000.1		045
1,8 20V 2,8 V6 30V	12.95 - 02.97	↗	31.172.045.000.1		045
	12.95 - 02.97	↘	31.016.026.000.1		026
	12.95 - 02.97	↙	31.005.005.000.1	К суппорту	005
2,0 16V quattro	06.94 - 02.97	↗	31.172.045.000.1		045
2,0 2,0 16V 2,3 2,6 V6	06.94 -	↗	31.172.045.000.1		045
	06.94 -	↘	31.016.026.000.1		026
	06.94 -	↙	31.005.005.000.1	К суппорту	005
2,2 S6 Turbo quattro	06.94 - 02.97	↗	31.172.045.000.1		045
2,5 TDI	01.95 - 02.97	↗	31.172.045.000.1		045
	01.95 - 02.97	↘	31.016.026.000.1		026
	01.95 - 02.97	↙	31.005.005.000.1	К суппорту	005
	01.95 - 02.97	↙	31.005.005.000.1	К суппорту	005
2,5 TDI (44)	10.95 - 02.97	↗	31.172.045.000.1		045
2,8 V6 1,9 TDI	06.94 -	↗	31.172.045.000.1		045
	06.94 -	↘	31.016.026.000.1		026
	06.94 -	↙	31.005.005.000.1	К суппорту	005
4,2 S6 Plus quattro	04.96 - 02.97	↗	31.172.045.000.1		045
<b>Coupe (81 ,85)</b>					
1,6 1,9	07.80 -	↗	31.020.005.000.1		005
	07.80 -	↘	31.016.026.000.1		026
	07.80 -	↙	31.022.026.000.1		026
1,8	08.81 -	↗	31.020.005.000.1		005
	08.81 -	↘	31.016.026.000.1		026
	08.81 -	↙	31.022.026.000.1		026
1,8GT 2,1 GT	09.82 -	↗	31.020.005.000.1		005
	09.82 -	↘	31.016.026.000.1		026
	09.82 -	↙	31.022.026.000.1		026
2	03.89 ~ 04.88	↗	31.020.005.000.1		005
	03.89 - 04.88	↘	31.016.026.000.1		026
	03.89 - 04.88	↙	31.022.026.000.1		026
2,2 GT	09.84 - 10.88	↗	31.020.005.000.1		005
	09.84 - 10.88	↘	31.016.026.000.1		026
	09.84 - 10.88	↙	31.022.026.000.1		026
2,2 quattro 2,3 quattro	- 10.88	↗	31.020.005.000.1		005
2,3	01.87 - 10.88	↗	31.020.005.000.1		005
	01.87 - 10.88	↘	31.015.005.000.1		005
<b>Coupe (89,8B)</b>					
1,8 2,0 2,3 E 20V	05.89 -	↗	31.015.005.000.1	Шасси 8BL003792- 1 К суппорту	005
	05.89 -	↗	31.020.005.000.1	-Шасси 8BL003791	005
	05.89 -	↙	31.015.005.000.1	К суппорту	005
2,0 16V	01.92 - 12.96	↘	31.015.005.000.1	К суппорту	005
	01.92 - 12.96	↗	31.015.005.000.1	Шасси 8BL003792- 1 К суппорту	005
	01.92 - 12.96	↗	31.020.005.000.1	-Шасси 8BL003791	005
2,2 quattro 2,3 quattro	11.88 -	↗	31.015.005.000.1	Шасси 8BL003001 - 1 К суппорту	005
	11.88 -	↘	31.020.005.000.1	-Шасси 8BL003000	005
2,2 S2 quattro 2,3 E quattro	05.90 - 12.96	↗	31.015.005.000.1	К суппорту	005
	05.90 - 12.96	↗	31.020.005.000.1	-Шасси 8BL003000	005
2,3	10.88 - 12.96	↗	31.015.005.000.1	Шасси 8BL003792- 1 К суппорту	005
	10.88 - 12.96	↗	31.020.005.000.1	-Шасси 8BL003791	005
	10.88 - 12.96	↘	31.015.005.000.1	К суппорту	005
2,3 E 20V quattro	11.88 - 12.96	↗	31.015.005.000.1	Шасси 8BL003001- 1 К суппорту	005
2,6 V6 quattro 2,8 E quattro	- 12.96	↗	31.015.005.000.1	К суппорту	005
2,6 V6 2,8 E	- 12.96	↗	31.015.005.000.1	К суппорту	005

# Таблица применяемости тормозных шлангов











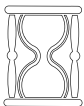



































		i	Код Дафми	Дополнительная информация	Тип №
--	--	---	-----------	---------------------------	-------

	- 12.96		31.015.005.000.1	К суппорту	005
<b>Quattro (85)</b>					
2,1 Turbo 2,1 20V Turbo	- 07.87 - 07.87		31.019.006.000.1 31.020.005.000.1	-Шасси 85G902400 -Шасси 85D902500	006 005
2,2 Turbo	08.87 - 07.89 08.87 - 07.89		31.019.006.000.1 31.020.005.000.1	-Шасси 85G902400 -Шасси 85D902500	006 005

## BMW















































<b>3 er (E21)</b>					
All models	08.75 - 03.84 08.75 - 03.84 08.75 - 03.84		31.012.026.000.1 31.142.005.000.1 31.010.026.000.1		026 005 026
<b>3 er (E30)</b>					
315	09.82 - 10.83 09.82 - 10.83 09.82 - 10.83		31.068.005.000.1 31.142.005.000.1 31.010.026.000.1		005 005 026
316	09.82 - 12.87 09.82 - 12.87 09.82 - 12.87		31.068.005.000.1 31.142.005.000.1 31.010.026.000.1	С ABS I К суппорту	005 005 026
316 i	07.87 - 06.91 07.87 - 06.91 07.87 - 06.91		31.068.005.000.1 31.142.005.000.1 31.010.026.000.1	С ABS I К суппорту	005 005 026
318 i 320 i	09.82 - 06.91 09.82 - 06.91 09.82 - 06.91		31.068.005.000.1 31.142.005.000.1 31.010.026.000.1	С ABS I К суппорту	005 005 026
323 i	09.82 - 08.86 09.82 - 08.86 09.82 - 08.86		31.068.005.000.1 31.142.005.000.1 31.010.026.000.1	К суппорту	005 005 026
324 d	09.85 - 08.91 09.85 - 08.91 09.85 - 08.91		31.068.005.000.1 31.142.005.000.1 31.010.026.000.1	С ABS I К суппорту	005 005 026
325 e, 2,7	10.83 - 12.88 10.83 - 12.88 10.83 - 12.88		31.068.005.000.1 31.142.005.000.1 31.010.026.000.1	К суппорту	005 005 026
325 i, ix	09.83 - 08.91 09.83 - 08.91 09.83 - 08.91		31.068.005.000.1 31.142.005.000.1 31.010.026.000.1	К суппорту	005 005 026
M3 2.3	07.86 - 06.91 07.86 - 06.91 07.86 - 06.91		31.068.005.000.1 31.142.005.000.1 31.010.026.000.1	К суппорту	005 005 026
M3 EVO. I, 2,3	10.88 - 10.90 10.88 - 10.90 10.88 - 10.90		31.068.005.000.1 31.142.005.000.1 31.010.026.000.1	К суппорту	005 005 026
M3 EVO. II, 2,3	01.90 - 01.92 01.90 - 01.92 01.90 - 01.92		31.068.005.000.1 31.142.005.000.1 31.010.026.000.1	К суппорту	005 005 026
<b>3 er (E36)</b>					
316i 318i 320i 325i 328i	09.90 -		31.142.005.000.1	К суппорту	005
325 TD	09.91 - 02.98		31.142.005.000.1	К суппорту	005
325 TDS	05.93 - 02.98		31.142.005.000.1	К суппорту	005
<b>3 er Compact (E36)</b>					
316 g	12.95 - 12.95 - 03.94 - 09.93 - 04.99		31.142.005.000.1 31.010.026.000.1 31.010.026.000.1 31.142.005.000.1	К суппорту	005 026 026 005
318 is 320 i 325 i	03.92 -		31.142.005.000.1	К суппорту	005
318 TDS	01.95 -		31.010.026.000.1		026
318ti	11.94 - 08.95 11.94 - 08.95		31.142.005.000.1 31.010.026.000.1	К суппорту	005 026
323 i 2,5 328 i	01.95 - 04.99		31.142.005.000.1	К суппорту	005
323 ti	08.97 - 08.97 -		31.142.005.000.1 31.010.026.000.1	К суппорту	005 026
<b>3 er Convertible/roadster (E36)</b>					
All models	04.86 - 10.93 04.86 - 10.93 04.86 - 10.93		31.068.005.000.1 31.142.005.000.1 31.010.026.000.1	К суппорту	005 005 026
<b>3 er Convertible/roadster (E36)</b>					
All models	01.94 - 04.99		31.142.005.000.1	К суппорту	005
<b>3 er Touring (E30)</b>					
316 i	09.91 - 06.94 09.91 - 06.94		31.068.005.000.1 31.142.005.000.1	К суппорту	005 005

		i	Код Дафми	Дополнительная информация	Тип №
318 i	09.91 - 06.94		31.010.026.000.1		026
	09.87 - 06.94		31.068.005.000.1	К суппорту	005
	09.87 - 06.94		31.142.005.000.1		005
	09.87 - 06.94		31.010.026.000.1		026
01.88 - 12.91		31.068.005.000.1	005		
320 i	01.88 - 12.91		31.142.005.000.1		005
	01.88 - 12.91		31.010.026.000.1		026
	01.88 - 06.93		31.068.005.000.1	К суппорту	005
01.88 - 06.93		31.142.005.000.1	005		
01.88 - 06.93		31.010.026.000.1	026		
324 TD	01.88 - 06.93		31.068.005.000.1	К суппорту	005
	01.88 - 06.93		31.142.005.000.1		005
	01.88 - 06.93		31.010.026.000.1		026
325 i, ix	07.87 - 10.93		31.164.005.000.1	К суппорту	005
	07.87 - 10.93		31.142.005.000.1		005
	07.87 - 10.93		31.010.026.000.1		026
<b>3 er Touring (E36)</b>					
316 i	01.96 - 10.99		31.142.005.000.1	К суппорту	005
318 i 323 i 2,5	07.95 - 10.99		31.142.005.000.1	К суппорту	005
320 i 328 i 318 TDS 325 TDS	01.95 - 10.99		31.142.005.000.1	К суппорту	005
<b>5 er (E12)</b>					
All models	07.74 - 05.81		31.012.026.000.1		026
	07.74 - 05.81		31.010.026.000.1		026
<b>5 er (E28)</b>					
518 i 524 TD	09.83 - 12.87		31.048.005.000.1	К суппорту	005
	09.83 - 12.87		31.142.005.000.1		005
	09.83 - 12.87		31.010.026.000.1		026
518 520 i 525 i 528 i	06.81 -		31.048.005.000.1	К суппорту	005
	06.81 -		31.142.005.000.1		005
	06.81 -		31.010.026.000.1		026
524 TD	09.83 - 12.87		31.048.005.000.1	К суппорту	005
	09.83 - 12.87		31.142.005.000.1		005
	09.83 - 12.87		31.010.026.000.1		026
525 e 2,7	09.81 - 12.87		31.048.005.000.1	К суппорту	005
	09.81 - 12.87		31.142.005.000.1		005
	09.81 - 12.87		31.010.026.000.1		026
535 i M 535 i	01.85 - 12.87		31.048.005.000.1	К суппорту	005
	01.85 - 12.87		31.142.005.000.1		005
	01.85 - 12.87		31.010.026.000.1		026
M5 3,5	08.85 - 12.87		31.142.005.000.1	К суппорту	005
	08.85 - 12.87		31.010.026.000.1		026
<b>5 er (E34)</b>					
518 i 520 i 24V 525 i 24 V	08.89 - 09.95		31.161.005.000.1	С ABS   К суппорту	005
	08.89 - 09.95		31.142.005.000.1		005
	08.89 - 09.95		31.010.026.000.1		026
520 i 525 i 530 i 535 i 524 TD	01.88 -		31.161.005.000.1	С ABS   К суппорту	005
	01.88 -		31.142.005.000.1		005
	01.88 -		31.010.026.000.1		026
525 TD	04.93 - 09.95		31.161.005.000.1	К суппорту	005
	04.93 - 09.95		31.142.005.000.1		005
	04.93 - 05.95		31.012.026.000.1		026
525 TDS	09.91 - 09.95		31.161.005.000.1	К суппорту	005
	09.91 - 05.95		31.142.005.000.1		005
	09.91 - 09.95		31.010.026.000.1		026
530 i V8 540 i V8	09.92 - 09.95		31.161.005.000.1	С ABS   К суппорту	005
	09.92 - 09.95		31.142.005.000.1		005
	09.92 - 09.95		31.010.026.000.1		026
M5 3,8	03.92 - 09.95		31.161.005.000.1	С ABS   К суппорту	005
	03.92 - 09.95		31.142.005.000.1		005
	03.92 - 09.95		31.010.026.000.1		026
M5 3,5	10.88 - 05.92		31.161.005.000.1	С ABS   К суппорту	005
	10.88 - 05.92		31.142.005.000.1		005
	10.88 - 05.92		31.010.026.000.1		026
<b>5 er Touring (E34)</b>					
All models	11.91 - 01.97		31.161.005.000.1	К суппорту	005
	11.91 - 01.97		31.142.005.000.1		005
	11.91 - 01.97		31.010.026.000.1		026
<b>6 er (E24)</b>					
518 i 540 i 525 TD	03.93 -		31.161.005.000.1	К суппорту	005
	03.93 -		31.142.005.000.1		005
	03.93 -		31.010.026.000.1		026
628 CSi	05.82 - 08.87		31.048.005.000.1		005
	05.82 - 08.87		31.142.005.000.1		005
	09.79 - 04.82		31.012.026.000.1		026









# Таблица применяемости тормозных шлангов









































		i	Код Дафми	Дополнительная информация	Тип №
---	---	---	-----------	---------------------------	-------

630 CS	09.79 - 04.82		31.010.026.000.1		026
	04.76 - 08.79		31.012.026.000.1		026
633 CSi	04.76 - 08.79		31.010.026.000.1		026
	04.76 - 08.84		31.010.026.000.1		026
635 CSi	01.85 - 09.90		31.048.005.000.1	К суппорту	005
	01.85 - 09.90		31.142.005.000.1		005
	01.85 - 09.90		31.010.026.000.1		026
M 635 CSi	03.84 - 05.89		31.142.005.000.1	К суппорту	005
	03.84 - 05.89		31.010.026.000.1		026
<b>7 er (E23)</b>					
728	05.77 - 08.79		31.012.026.000.1		026
	05.77 - 08.79		31.010.026.000.1		026
728 i	07.78 - 08.86		31.012.026.000.1	К суппорту	026
	07.78 - 08.86		31.142.005.000.1		005
730	05.77 - 08.79		31.012.026.000.1		026
	05.77 - 08.79		31.010.026.000.1		026
732 i 733 i	05.77 - 08.86		31.012.026.000.1	К суппорту	026
	05.77 - 08.86		31.142.005.000.1		005
	05.77 - 08.86		31.010.026.000.1		026
735 i	09.79 - 08.86		31.012.026.000.1	К суппорту	026
	09.79 - 08.86		31.142.005.000.1		005
	09.79 - 08.86		31.010.026.000.1		026
745 i	04.80 - 08.86		31.012.026.000.1	К суппорту	026
	04.80 - 08.86		31.142.005.000.1		005
	04.80 - 08.86		31.010.026.000.1		026
<b>7 er (E32)</b>					
All models	12.86 - 09.94		31.161.005.000.1	К суппорту	005
	12.86 - 09.94		31.142.005.000.1		005
	12.86 - 09.94		31.010.026.000.1		026
<b>8 er (E31)</b>					
830 Ci	08.92 -		31.161.005.000.1	К суппорту	005
	08.92 -		31.142.005.000.1		005
840 Ci	02.93 -		31.161.005.000.1	К суппорту	005
	02.93 -		31.142.005.000.1		005
850 Ci	09.94 -		31.161.005.000.1	К суппорту	005
	09.94 -		31.142.005.000.1		005
850 CSi	04.93 - 12.96		31.161.005.000.1	К суппорту	005
	04.93 - 12.96		31.142.005.000.1		005
850 i 850 Ci	04.90 - 10.94		31.161.005.000.1	К суппорту	005
	04.90 - 10.94		31.142.005.000.1		005
<b>Z1</b>					
2,5	06.88 - 06.91		31.068.005.000.1	К суппорту	005
	06.88 - 06.91		31.142.005.000.1		005
<b>Z3</b>					
1,8	10.95 - 10.98		31.142.005.000.1	К суппорту	005
1,9	07.98 -		31.142.005.000.1	К суппорту	005
2	04.99 -		31.142.005.000.1	К суппорту	005
2,8	04.97 - 06.00		31.142.005.000.1	К суппорту	005
3	06.00 -		31.142.005.000.1		005
<b>Z3 coupe</b>					
2,8	07.97 - 06.00		31.142.005.000.1		005
3	06.00 -		31.142.005.000.1		005
M3,2	02.88 -		31.142.005.000.1		005



## CITROEN

<b>AX (ZA-)</b>					
All models	07.86 - 12.98		31.050.018.000.1	Без ABS 1-6321	018
<b>BX (XB-)</b>					
All models	10.82 - 02.93		31.093.010.000.1	Без ABS	010
	01.89 - 02.93		31.141.006.000.1	С ABS	006
<b>BX Break (XB-)</b>					
All models	09.83 - 12.94		31.093.010.000.1	Без ABS	010
	09.83 - 12.94		31.141.006.000.1	С ABS	006
<b>C15 (VD-)</b>					
1,1 i	07.88 - 12.96		31.084.007.000.1		007
1,4 i	05.91 - 12.96		31.084.007.000.1		007
1,4 1,4 E	05.87 - 12.96		31.084.007.000.1		007
1,8 D	07.86 - 12.97		31.084.007.000.1		007







		i	Код Дафми	Дополнительная информация	Тип №
---	---	---	-----------	---------------------------	-------

C 25 (280_, 290_)					
1,8 E 1,9 D	07.87 - 02.94		31.096.007.000.1	172000- I Нижний	007
	07.87 - 02.94		31.098.007.000.1	172000- I Верхний	007
	07.87 - 02.94		31.179.008.000.1	-172000	008
	07.87 - 02.94		31.014.008.000.1	Максимум 1800 кг	008
1,9 TD	04.92 - 02.94		31.096.007.000.1	Нижний	007
	04.92 - 02.94		31.098.007.000.1	Верхний	007
	04.92 - 02.94		31.014.008.000.1	Максимум 1800 кг	008
2,0	02.91 - 02.94		31.096.007.000.1	172000- I Нижний	007
	02.91 - 02.94		31.098.007.000.1	172000- I Верхний	007
	02.91 - 02.94		31.179.008.000.1	-172000	008
	02.91 - 02.94		31.014.008.000.1	Максимум 1800 кг	008
2,0 E	09.81 - 02.94		31.096.007.000.1	172000- I Нижний	007
	09.81 - 02.94		31.098.007.000.1	172000- I Верхний	007
	09.81 - 02.94		31.179.008.000.1	-172000	008
	09.81 - 02.94		31.014.008.000.1	Максимум 1800 кг	008
2,5 D	10.85 - 02.94		31.096.007.000.1	172000- I Нижний	007
	10.85 - 02.94		31.098.007.000.1	172000- I Верхний	007
	10.85 - 02.94		31.179.008.000.1	-172000	008
	10.85 - 02.94		31.014.008.000.1	Максимум 1800 кг	008
2,504X4	01.87 - 02.94		31.096.007.000.1	172000- I Нижний	007
	01.87 - 02.94		31.098.007.000.1	172000- I Верхний	007
	01.87 - 02.94		31.179.008.000.1	-172000	008
	01.87 - 02.94		31.014.008.000.1	Максимум 1800 кг	008
2,50 Turbo, 2,50 Turbo 4x4	08.87 - 02.94		31.096.007.000.1	172000- I Нижний	007
	08.87 - 02.94		31.098.007.000.1	172000- I Верхний	007
	08.87 - 02.94		31.179.008.000.1	-172000	008
	08.87 - 02.94		31.014.008.000.1	Максимум 1800 кг	008
C 25 box body (280_, 290_)					
2,0	02.91 - 03.94		31.096.007.000.1	172000- I Нижний	007
	02.91 - 03.94		31.098.007.000.1	Сонт.пр 172000- I Верхний	007
	02.91 - 03.94		31.179.008.000.1	-172000	008
	02.91 - 03.94		31.014.008.000.1	Максимум 1800 кг	008
2,0 E	09.81 - 03.94		31.096.007.000.1	172000- I Нижний	007
	09.81 - 03.94		31.098.007.000.1	172000- I Верхний	007
	09.81 - 03.94		31.179.008.000.1	-172000	008
	09.81 - 03.94		31.014.008.000.1	Максимум 1800 кг	008
C 25 Platform/Chassis (280_, 290_)					
2,0	02.91 - 03.94		31.096.007.000.1	172000- I Нижний	007
	02.91 - 03.94		31.098.007.000.1	172000- I Верхний	007
	02.91 - 03.94		31.179.008.000.1	-172000	008
	02.91 - 03.94		31.014.008.000.1	Максимум 1800 кг	008

## DAEWOO

Espero (KLEJ)					
1,5 i 16V 1,8 i 2,0 i	02.95 - 06.97		31.202.034.000.1		034
	02.95 - 06.97		31.092.018.000.1		018
Lanos (KLAT)					
1,4 1,5 1,6 16V	05.97 -		31.203.034.000.1		034
	05.97 -		31.209.018.000.1		018
Nexia (KLETN)					
1,5 1,5 16V 1,8	02.95 -		31.202.034.000.1		034
	02.95 -		31.092.018.000.1		018
Nubira (KLAJ)					
1,6 16V 2,0 16V	02.97 -		31.221.043.000.1		043
	02.97 -		31.210.018.000.1	Барабанный тормоз	018
	02.97 -		31.211.018.000.1	Барабанный тормоз	018
Racer	-		31.091.033.000.1		033

## DAIHATSU

Charmant (A)					
1,3 (A35)	11.81 - 07.87		31.042.018.000.1		018
	11.81 - 07.87		31.051.011.000.1		011
1,6 (A45)	12.81 - 09.84		31.042.018.000.1		018
	12.81 - 09.84		31.051.011.000.1		011
1,6(A60)	08.83 - 07.87		31.042.018.000.1		018
	08.83 - 07.87		31.051.011.000.1		011

## FIAT

131					
1,4 Mirafiori	11.80 - 01.84		31.014.008.000.1	RIC.no 1110248-	008





















































# Таблица применяемости тормозных шлангов



		i	Код Дафми	Дополнительная информация	Тип №
---	---	---	--------------	------------------------------	-------

1,6	11.76 - 12.84	↖↗	31.014.008.000.1	RIC.no 1110248-	008
1,6(S)	10.74 - 09.81	↖↗	31.014.008.000.1	RIC.no 1110248-	008
1,6 Super	03.78 - 01.84	↖↗	31.014.008.000.1	RIC.no 1110248-	008
1,6 Super Mirafiori (A)	03.79 - 03.82	↖↗	31.014.008.000.1	RIC.no 1110248-	008
2.0 Abarth Rally	01.76 - 07.80	↖↗	31.014.008.000.1	RIC.no 1110248-	008
2.0 D	07.78 - 08.84	↖↗	31.014.008.000.1	RIC.no 1110248-	008
2.0 Racing	06.78 - 12.81	↖↗	31.014.008.000.1	RIC.no 1110248-	008
2.0 Super	01.81 - 12.84	↖↗	31.014.008.000.1	RIC.no 1110248-	008
2,5 D	06.78 - 02.84	↖↗	31.014.008.000.1	RIC.no 1110248-	008
Coupe (FA/175)					
2.0 16V	11.93 -	↖↗	31.094.018.000.1		018
Croma (154)					
All models	12.85 - 12.96	↖↗	31.180.008.000.1		008
	12.85 - 12.96	↖↗	31.181.008.000.1		008
Ducato box body (280)					
1,8	01.82 - 05.85	↖↗	31.179.008.000.1		008
	01.82 - 10.88	↓	31.014.008.000.1		008
	06.85 - 10.88	↖↗	31.096.007.000.1	Нижний	007
	06.85 - 10.88	↖↗	31.098.007.000.1	Верхний	007
1,9 TD 2,5 D 4X4	03.89 - 08.90	↖↗	31.096.007.000.1	Нижний	007
	03.89 - 08.90	↖↗	31.098.007.000.1	Верхний	007
	03.89 - 08.90	↓	31.014.008.000.1		008
2,0 2,4 D 2,5 D	01.82 - 08.90	↖↗	31.096.007.000.1	Нижний	007
	01.82 - 08.90	↖↗	31.098.007.000.1	Верхний	007
	01.82 - 08.90	↓	31.014.008.000.1		008
Ducato box body (290)					
1,9 D	07.90 - 03.94	↖↗	31.096.007.000.1	Нижний	007
	07.90 - 03.94	↖↗	31.098.007.000.1	Верхний	007
	07.90 - 03.94	↓	31.014.008.000.1		008
1,9 TD	03.89 - 03.94	↖↗	31.096.007.000.1	Нижний	007
	03.89 - 03.94	↖↗	31.098.007.000.1	Верхний	007
	03.89 - 03.94	↓	31.014.008.000.1		008
2,5 D 4x4 2,5 TD 2,5 TD 4x4	07.90 - 03.94	↖↗	31.096.007.000.1	Нижний	007
	07.90 - 03.94	↖↗	31.098.007.000.1	Верхний	007
	07.90 - 03.94	↓	31.014.008.000.1		008
Ducato Panorama (280)					
1,8	06.85 - 12.88	↖↗	31.096.007.000.1	Нижний	007
	06.85 - 12.88	↖↗	31.098.007.000.1	Верхний	007
	07.82 - 05.85	↖↗	31.178.008.000.1	Нижний	008
	07.82 - 05.85	↖↗	31.179.008.000.1	Верхний	008
	07.82 - 12.88	↓	31.014.008.000.1		008
1,9 D	03.89 - 08.90	↖↗	31.096.007.000.1	Нижний	007
	03.89 - 08.90	↖↗	31.098.007.000.1	Верхний	007
	03.89 - 08.90	↓	31.014.008.000.1		008
2,0	01.86 - 08.90	↖↗	31.096.007.000.1	Нижний	007
	01.86 - 08.90	↖↗	31.098.007.000.1	Верхний	007
	01.86 - 08.90	↓	31.014.008.000.1		008
	07.82 - 12.95	↖↗	31.178.008.000.1	Нижний	008
	07.82 - 12.85	↖↗	31.179.008.000.1	Верхний	008
2,4 D	06.85 - 08.90	↖↗	31.096.007.000.1	Нижний	007
	06.85 - 08.90	↖↗	31.098.007.000.1	Верхний	007
	07.82 - 05.85	↖↗	31.178.008.000.1	Нижний	008
	07.82 - 05.85	↖↗	31.179.008.000.1	Верхний	008
	07.82 - 08.90	↓	31.014.008.000.1		008
2,5 D	01.86 - 08.90	↖↗	31.096.007.000.1	Нижний	007
	01.86 - 08.90	↖↗	31.098.007.000.1	Верхний	007
	01.86 - 08.90	↓	31.014.008.000.1		008
2,5 D 4x4 2,5 TD	01.87 - 08.90	↖↗	31.096.007.000.1	Нижний	007
	01.87 - 08.90	↖↗	31.098.007.000.1	Верхний	007
	01.87 - 08.90	↓	31.014.008.000.1		008
2,5 TD 4x4	01.86 - 08.90	↖↗	31.096.007.000.1	Нижний	007
	01.86 - 08.90	↖↗	31.098.007.000.1	Верхний	007
	01.86 - 08.90	↓	31.014.008.000.1		008
Ducalo Panorama (290)					
All models	07.90 - 03.94	↖↗	31.096.007.000.1	Нижний	007
	07.90 - 03.94	↖↗	31.098.007.000.1	Верхний	007
	07.90 - 03.94	↓	31.014.008.000.1		008
Ducato Platform/Chassis (280)					
All models	01.88 - 08.90	↖↗	31.096.007.000.1	Нижний	007
	01.88 - 08.90	↖↗	31.098.007.000.1	Верхний	007
	01.88 - 08.90	↓	31.014.008.000.1		008

		i	Код Дафми	Дополнительная информация	Тип №
---	---	---	-----------	---------------------------	-------

Ducato Platform/Chassis (290)					
1,9 TD	03.89 - 03.94		31.096.007.000.1	Нижний	007
	03.89 - 03.94		31.098.007.000.1	Верхний	007
	03.89 - 03.94		31.014.008.000.1		008
2,0 2,5 D 2,5 D 4x4	07.90 - 03.94		31.096.007.000.1	Нижний	007
	07.90 - 03.94		31.098.007.000.1	Верхний	007
	07.90 - 03.94		31.014.008.000.1		008
2,5 TDI 2,5 TDI 4x4	07.90 - 03.94		31.096.007.000.1	Нижний	007
	07.90 - 03.94		31.098.007.000.1	Верхний	007
	07.90 - 03.94		31.014.008.000.1		008
Marengo					
1,9 D 1,9 TDS	00.90 -		31.182.008.000.1		008
	00.90 -		31.094.018.000.1		018
1,9 TD 1,9 TDS	00.83 - 00.90		31.049.007.000.1		007
Panda (141 A)					
650	09.82 -		31.014.008.000.1		008
800	09.82 - 12.85		31.014.008.000.1		008
Punto (176)					
1,4 GT Turbo	04.97 - 09.99		31.050.018.000.1		018
1,7 D	04.94 - 09.97		31.050.018.000.1		018
1,7 TD	01.94 - 09.99		31.050.018.000.1		018
55 1,1	09.93 - 09.99		31.050.018.000.1		018
60 1,2 75 1,2	01.94 - 09.99		31.050.018.000.1		018
60 1,7 TD	06.96 - 09.99		31.050.018.000.1		018
85 16V 1,2	04.97 - 09.99		31.050.018.000.1		018
90 1,6	01.94 - 04.97		31.050.018.000.1		018
Regata (138)					
60 1,7 D	09.83 - 04.85		31.049.007.000.1		007
65 1,9 D	04.84 - 04.85		31.049.007.000.1		007
70 1,3	05.85 - 12.87		31.049.007.000.1		007
75 1,5	12.83 - 04.85		31.049.007.000.1		007
85 1,6 90i.e. 1,6 100 Super 1,6	10.83 - 04.85		31.049.007.000.1		007
Regata Weekend					
100 1,6	09.84 - 12.86		31.049.007.000.1		007
100 i.e. 1,6	01.87 - 12.90		31.049.007.000.1		007
70 1,3	05.85 - 12.87		31.049.007.000.1		007
75 1,5	12.83 - 04.85		31.049.007.000.1		007
85 1,6 90i.e. 1,6 100 Super 1,6	10.83 - 04.85		31.049.007.000.1		007
Ritmo (138A)					
105 Sport 1,6	05.81 - 12.82		31.049.007.000.1		007
70 1,3	11.83 - 08.85		31.049.007.000.1		007
75 i.e. 1,5	10.85 - 05.87		31.049.007.000.1	-RIC.no 3088504	007
90 i.e. 1,6	09.85 - 12.87		31.049.007.000.1		007
Tempra (159)					
1,4 i.e.	03.91 - 08.96		31.095.007.000.1		007
	03.91 - 08.96		31.094.018.000.1		018
1,6 i.e.	06.90 - 08.96		31.095.007.000.1	Без ABS	007
	06.90 - 08.96		31.182.008.000.1	С ABS	008
	06.90 - 08.96		31.094.018.000.1		018
1,8 i.e.	03.90 - 08.96		31.182.008.000.1		008
	03.90 - 08.96		31.094.018.000.1		018
1,9 D	07.91 - 08.96		31.182.008.000.1		008
	07.91 - 08.96		31.094.018.000.1		018
1,9 TD	05.90 - 08.96		31.182.008.000.1		008
	05.90 - 08.96		31.094.018.000.1		018
2,0 i.e.	10.90 - 08.96		31.182.008.000.1		008
	10.90 - 08.96		31.094.018.000.1		018
Tipo (160)					
1,1	01.88 - 10.91		31.095.007.000.1		007
	01.88 - 10.91		31.094.018.000.1		018
1,4	07.87 - 12.89		31.095.007.000.1	Без ABS	007
	07.87 - 12.89		31.182.008.000.1	С ABS	008
	07.87 - 12.89		31.094.018.000.1		018
1,4 i.e.	05.89 - 04.95		31.095.007.000.1	Без ABS	007
	05.89 - 04.95		31.182.008.000.1	С ABS	008
	05.89 - 04.95		31.094.018.000.1	Без ABS	018
1,6	02.88 - 10.91		31.095.007.000.1	Без ABS	007
	02.88 - 10.91		31.182.008.000.1	С ABS	008
	02.88 - 10.91		31.094.018.000.1		018
1,6 i.e.	07.90 - 04.95		31.182.008.000.1		008
	07.90 - 04.95		31.094.018.000.1		018



# Таблица применяемости тормозных шлангов











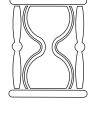





















































		i	Код Дафми	Дополнительная информация	Тип №
---	---	---	-----------	---------------------------	-------

1,7 D	01.88 - 10.95 01.88 - 10.95	↗ ↘	31.182.008.000.1 31.094.018.000.1		008 018
1,8 i.e.	10.90 - 04.95 10.90 - 04.95	↗ ↘	31.182.008.000.1 31.094.018.000.1		008 018
1,8 i.e. 16V Sport	11.89 - 06.92 11.89 - 06.92	↗ ↘	31.182.008.000.1 31.094.018.000.1		008 018
1,9 TD	09.90 - 04.95 09.90 - 04.95	↗ ↘	31.182.008.000.1 31.094.018.000.1		008 018
2,0 i.e.	03.90 - 04.95 03.90 - 04.95	↗ ↘	31.182.008.000.1 31.094.018.000.1		008 018
2,0 i.e. 16V Sport	03.93 - 04.95 03.93 - 04.95	↗ ↘	31.182.008.000.1 31.094.018.000.1		008 018
<b>Uno(146A)</b>					
1,3 Super D	06.83 - 06.89 06.83 - 03.92	↗ ↘	31.097.007.000.1 31.050.018.000.1		007 018
1,3 Turbo i.e.	09.89 - 03.91 09.89 - 03.91	↗ ↓	31.099.007.000.1 31.050.018.000.1	Без ABS Без ABS	007 018
1,3. Turbo i.e.	01.87 - 12.87 01.87 - 12.87	↗ ↓	31.099.007.000.1 31.050.018.000.1	Без ABS Без ABS	007 018
1,4 Turbo i.e.	09.89 - 12.96 09.89 - 12.96	↗ ↓	31.099.007.000.1 31.050.018.000.1	Без ABS Без ABS	007 018
1,9 D	09.89 - 03.94 09.89 - 03.94	↗ ↓	31.099.007.000.1 31.050.018.000.1		007 018
45 0,9	03.83 - 09.92 03.83 - 09.92 03.83 - 09.92	↗ ↗ ↓	31.097.007.000.1 31.176.008.000.1 31.050.018.000.1	RIC.no 642466-1 RIC.no 796273- -RIC.no 642465 1 -RIC.no796272	007 008 018
45 1,0	06.86 - 12.93 06.86 - 12.93	↗ ↓	31.097.007.000.1 31.050.018.000.1		007 018
45 i.e. 1,0	05.85 - 09.92 05.85 - 09.92	↗ ↓	31.097.007.000.1 31.050.018.000.1		007 018
50 1,1	01.86 - 12.93 01.86 - 12.93	↗ ↓	31.097.007.000.1 31.050.018.000.1		007 018
50 i.e. 1,1	06.92 - 12.93 06.92 - 12.93	↗ ↓	31.097.007.000.1 31.050.018.000.1		007 018
55 1,1	01.83 - 08.89 01.83 - 08.89	↗ ↓	31.176.008.000.1 31.050.018.000.1		008 018
60 1,1	04.89 - 12.92 04.89 - 12.92	↗ ↓	31.097.007.000.1 31.050.018.000.1		007 018
60 1,7 D	07.86 - 12.93 07.86 - 12.93	↗ ↓	31.099.007.000.1 31.050.018.000.1		007 018
70 1,3	01.83 - 09.92 01.83 - 09.92 01.83 - 09.92	↗ ↗ ↓	31.097.007.000.1 31.176.008.000.1 31.050.018.000.1	RIC.no 642466-1 RIC.no 796273- -RIC.no 642465 1 -RIC.no 796272	007 008 018
70 1,4 TD	10.86 - 10.90 10.86 - 10.90	↗ ↓	31.099.007.000.1 31.050.018.000.1		007 018
75 i.e. 1,5	10.85 - 06.89 10.85 - 06.89	↗ ↘	31.097.007.000.1 31.050.018.000.1		007 018

## FORD

<b>Escort '81 Express (AVA)</b>					
1,1 1,3 1,6	03.81 - 04.83 03.81 - 01.82 03.81 - 01.82 02.82 - 02.86 02.82 - 02.86 05.83 - 02.86	↗ ↘ ↘ ↘ ↘ ↗	31.040.001.000.1 31.034.014.000.1 31.035.014.000.1 31.036.004.000.1 31.037.004.000.1 31.039.001.000.1		001 014 014 004 004 001
<b>Escort '86 Express (AVF)</b>					
1,1 1,3 1,4 i	01.86 - 07.90 01.86 - 07.90 01.86 - 07.90	↗ ↘ ↘	31.039.001.000.1 31.036.004.000.1 31.037.004.000.1		001 004 004
1,6 D 1,7 D	- 07.90 - 07.90 - 07.90	↗ ↘ ↘	31.039.001.000.1 31.036.004.000.1 31.037.004.000.1		001 004 004
<b>Escort II.(ATH)</b>					
1,1 1,3 1,6 RS 2,0 RS	- 08.80	↗	31.026.001.000.1		001
<b>Escort III. Turnier (AWA)</b>					
1,1 1,3 1,6	09.80 - 04.83 09.80 - 01.82 09.80 - 01.82 02.82 - 12.85 02.82 - 12.95	↗ ↘ ↘ ↘ ↘	31.040.001.000.1 31.034.014.000.1 31.035.014.000.1 31.036.004.000.1 31.037.004.000.1		001 014 014 004 004







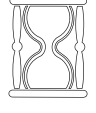

















































		i	Код Дафми	Дополнительная информация	Тип №
	05.85 - 12.85		31.039.001.000.1		001
1,6 D	04.84 - 12.85		31.039.001.000.1		001
	04.84 - 12.85		31.036.004.000.1		004
	04.84 - 12.85		31.037.004.000.1		004
	04.84 - 12.85		31.037.004.000.1		004
Escort III. (GAA, AWA, ABFT, AVA)					
1,1 1,3 1,6	09.80 - 04.83		31.040.001.000.1		001
	09.80 - 01.82		31.034.014.000.1		014
	09.80 - 01.82		31.035.014.000.1		014
	02.82 - 12.85		31.036.004.000.1		004
	02.82 - 12.85		31.037.004.000.1		004
	05.83 - 12.85		31.039.001.000.1		001
1,6 RS Turbo 1,6 D	04.84 - 12.85		31.039.001.000.1		001
	04.84 - 12.85		31.036.004.000.1		004
	04.84 - 12.85		31.037.004.000.1		004
1,6 XR 3 i	10.82 - 04.83		31.040.001.000.1		001
	10.82 - 12.85		31.036.004.000.1		004
	10.82 - 12.85		31.037.004.000.1		004
	05.83 - 12.85		31.039.001.000.1		001
Escort IV.					
SW	11.90 - 09.91		31.079.003.000.1		003
Escort IV. (GAF, AWF, ABF)					
1,1 1,3 1,4 1,6 1,6 Turbo RS	01.86 - 10.90		31.039.001.000.1		001
	01.86 - 10.90		31.036.004.000.1		004
	01.86 - 10.90		31.037.004.000.1		004
1,6 XR 3 i 1,6 D	01.86 -		31.039.001.000.1		001
	01.86 -		31.036.004.000.1		004
	01.86 -		31.037.004.000.1		004
1,8	01.89 - 07.90		31.039.001.000.1		001
	01.89 - 07.90		31.036.004.000.1		004
	01.89 - 07.90		31.037.004.000.1		004
Escort IV. Turnier (AWF, AVF)					
1,3 1,4 1,6 1,6 D	01.86 -		31.039.001.000.1		001
	01.86 -		31.036.004.000.1		004
	01.86 -		31.037.004.000.1		004
1,7	01.89 - 07.90		31.039.001.000.1		001
	01.89 - 07.90		31.036.004.000.1		004
	01.89 - 07.90		31.037.004.000.1		004
Escort V. (GAL)					
1,3	07.90 - 09.92		31.158.051.000.1	свертись с чертежом !	051
	07.90 - 09.92		31.159.051.000.1	свертись с чертежом !	051
	07.90 - 09.92		31.134.001.000.1		001
1,4 1,6 1,8 D	07.90 - 12.90		31.145.051.000.1	свертись с чертежом !	051
	07.90 - 12.92		31.146.051.000.1	свертись с чертежом !	051
	07.90 - 12.92		31.134.001.000.1		001
1,8 16V XR 3 i	02.92 - 12.92		31.145.051.000.1	свертись с чертежом !	051
	02.92 - 12.92		31.146.051.000.1	свертись с чертежом !	051
	02.92 - 12.92		31.134.001.000.1		001
RS 2000	05.91 - 12.92		31.134.001.000.1		001
Escort V. Turnier (GAL, AVL)					
1,4 1,6 1,8 D	07.90 - 12.92		31.145.051.000.1	свертись с чертежом !	051
	07.90 - 12.92		31.146.051.000.1	свертись с чертежом !	051
1,8 16V	02.92 - 12.92		31.145.051.000.1	свертись с чертежом !	051
	02.92 - 12.92		31.146.051.000.1	свертись с чертежом !	051
1,8 16V XR 3 i	02.92 - 12.92		31.145.051.000.1	свертись с чертежом !	051
	02.92 - 12.92		31.146.051.000.1	свертись с чертежом !	051
	02.92 - 12.92		31.134.001.000.1		001
Escort VI. (GAL)					
1,3	09.92 - 01.95		31.158.051.000.1	свертись с чертежом !	051
	09.92 - 01.95		31.159.051.000.1	свертись с чертежом !	051
	09.92 - 01.95		31.134.001.000.1		001
1,4 1,6 i 16V 1,8 i 16V	09.92 - 01.95		31.145.051.000.1	свертись с чертежом !	051
	09.92 - 01.95		31.146.051.000.1	свертись с чертежом !	051
	09.92 - 01.95		31.134.001.000.1		001
1,8 i XR 3 i 16V 4x4	08.93 - 01.95		31.134.001.000.1		001
1,8 TD	02.93 - 01.95		31.134.001.000.1		001
RS 2000 1,8 D	09.92 - 01.95		31.134.001.000.1		001
RS Coswort 4x4	09.92 - 01.95		31.079.003.000.1		003
	09.92 - 01.95		31.103.002.000.1		002
Escort VI. Convertible/roadster (ALL)					
1,4 i	07.93 - 01.95		31.134.001.000.1		001
1,6 16V XR 3 i	02.93 - 01.95		31.134.001.000.1		001

# Таблица применяемости тормозных шлангов













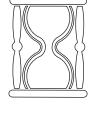































		i	Код Дафми	Дополнительная информация	Тип №
1,6 i 16V	02.94 - 01.95	↖↗	31.134.001.000.1		001
Escort VI. sedan (GAL)					
All models	08.93 - 01.95	↖↗	31.134.001.000.1		001
Escort VI. Turnier (GAL)					
1,3	09.92 - 01.95	↖	31.158.051.000.1	свергесь с чертежем !	051
	09.92 - 01.95	↗	31.159.051.000.1	свергесь с чертежем !	051
1,4 1,6 i 1,8 D	09.92 - 01.95	↗	31.145.051.000.1	свергесь с чертежем !	051
	09.92 - 01.95	↖	31.146.051.000.1	свергесь с чертежем !	051
Fiesta box body (FVD)					
1,0	08.83 - 11.89	↖↗	31.041.001.000.1		001
	08.83 - 11.89	↖↗	31.042.018.000.1		018
1,8 D (FVJ)	03.89 - 12.95	↖↗	31.143.001.000.1		001
	03.89 - 08.91	↖↗	31.103.002.000.1		002
	09.91 - 12.95	↖↗	31.103.002.000.1	Без SCS	002
Fiesta box body (WFFT)					
1,0 1,1	10.77 - 07.83	↖↗	31.040.001.000.1		001
	10.77 - 11.86	↖↗	31.042.018.000.1		018
	08.83 - 11.86	↖↗	31.041.001.000.1		001
Fiesta courier (F3L, F5L)					
1,3 1,8 D	09.91 - 02.96	↖↗	31.143.001.000.1		001
Fiesta I.					
0,9 1,1	05.76 - 07.83	↖↗	31.040.001.000.1		001
	05.76 - 08.83	↖↗	31.042.018.000.1		018
	08.83 -	↖↗	31.041.001.000.1		001
1,1 (WFBT)	02.81 - 07.83	↖↗	31.040.001.000.1		001
	02.81 - 11.86	↖↗	31.042.018.000.1		018
	08.83 - 11.86	↖↗	31.041.001.000.1		001
1,3 1,6 XR 2	- 07.83	↖↗	31.040.001.000.1		001
	- 08.83	↖↗	31.042.018.000.1		018
	08.83 -	↖↗	31.041.001.000.1		001
Fiesta II. (FBD)					
All models	09.83 - 02.89	↖↗	31.041.001.000.1		001
	09.83 - 02.89	↖↗	31.042.018.000.1		018
Fiesta III. (GFJ)					
All models	01.89 - 12.95	↖↗	31.143.001.000.1		001
	01.89 - 12.95	↖↗	31.103.002.000.1		002
	09.91 - 12.95	↖↗	31.153.002.000.1	C ABS	002
Granada (GAE, GGE)					
All models	- 02.92	↖↗	31.079.003.000.1		003
	- 02.92	↖↗	31.103.002.000.1		002
	- 02.92	↖↗	31.104.001.000.1	К суппорту	001
Mondeo (GBP)					
1,6 i 16V 1,8 16V 2,0 i 16V	02.93 - 08.96	↖↗	31.147.049.000.1		049
2,0 i 16V 4x4 2,5 i 24V 1,8 TD	- 08.96	↖↗	31.147.049.000.1		049
Mondeo Turnier (BNP)					
1,6 i 16V	05.98 -	↖↗	31.147.049.000.1		049
1,6 i 16V 1,8 i 16V 2,0 i 16V	04.93 - 08.96	↖↗	31.147.049.000.1		049
1,6 i 1,8 i 2,0 i 2,5 24V 1,8 TD	10.96 -	↖↗	31.147.049.000.1		049
2,0 i 16V 4x4 2,5 i 24V 1,8 TD	- 08.96	↖↗	31.147.049.000.1		049
2,5 ST 200	05.99 -	↖↗	31.147.049.000.1		049
Orion (AFD)					
All models	07.83 - 03.86	↖↗	31.039.001.000.1	-LX	001
	07.83 - 12.85	↖	31.036.004.000.1	-VAN, -LX	004
	07.83 - 12.85	↖	31.037.004.000.1	-VAN, -LX	004
Orion II. (AFF)					
All models	12.85 - 07.90	↖↗	31.039.001.000.1		001
	12.85 - 07.90	↖	31.036.004.000.1	-VAN	004
	12.85 - 07.90	↖	31.037.004.000.1	-VAN	004
Orion III. (GAL)					
1,3	07.90 - 12.93	↖	31.158.051.000.1	свергесь с чертежем !	051
	07.90 - 12.93	↗	31.159.051.000.1	свергесь с чертежем !	051
	07.90 - 12.93	↖↗	31.134.001.000.1		001
1,4 1,6 1,6 i 1,8 D	07.90 - 12.93	↖↗	31.145.051.000.1	свергесь с чертежем !	051
	07.90 - 12.93	↖	31.146.051.000.1	свергесь с чертежем !	051
	07.90 - 12.93	↖↗	31.134.001.000.1		001
1,6 i 16V 1,8 i 16V 1,8 TD	01.92 - 12.93	↖	31.145.051.000.1	свергесь с чертежем !	051
	01.92 - 12.93	↖	31.146.051.000.1	свергесь с чертежем !	051
	01.92 - 12.93	↖↗	31.134.001.000.1		001
P 100 II.					
2,0 1,8 TD	10.87 -	↖↗	31.079.003.000.1	На базе Sierra	003

		i	Код Дафми	Дополнительная информация	Тип №
---	---	---	-----------	---------------------------	-------

















Scorpio I. (GAE, GGE)					
1,8 2,8 i	04.85 -		31.079.003.000.1		003
	04.85 -		31.038.002.000.1		002
	04.85 -		31.104.001.000.1	К суппорту	001
2,0 i 2,9 i 2,9 i 4x4 2,5 TD	- 09.94		31.079.003.000.1		003
	- 09.94		31.038.002.000.1		002
	- 09.94		31.104.001.000.1	К суппорту	001
2,4 i 2,5 D	- 02.92		31.079.003.000.1		003
	- 02.92		31.038.002.000.1		002
	- 02.92		31.104.001.000.1	К суппорту	001
2,8 i 4x4	10.85 - 11.86		31.079.003.000.1		003
	10.85 - 11.86		31.038.002.000.1		002
	10.85 - 11.86		31.104.001.000.1	К суппорту	001
2,9 24V	06.88 - 09.94		31.079.003.000.1		003
	06.88 - 09.94		31.038.002.000.1		002
	06.88 - 09.94		31.104.001.000.1	К суппорту	001
Scorpio II. (GFR, GGR)					
All models	06.88 - 09.94		31.038.002.000.1		002
	06.88 - 09.94		31.104.001.000.1	К суппорту	001
Scorpio Turnier (GGE)					
2,0 i 2,4 i 2,9 i 2,5 TD	09.91 - 09.94		31.079.003.000.1		003
	09.91 - 09.94		31.038.002.000.1		002
	09.91 - 09.94		31.104.001.000.1	К суппорту	001
2,9 24V	08.93 - 09.94		31.079.003.000.1		003
	08.93 - 09.94		31.038.002.000.1		002
	08.93 - 09.94		31.104.001.000.1	К суппорту	001
2,9 i 4x4	05.88 - 02.93		31.079.003.000.1		003
	05.88 - 02.93		31.038.002.000.1		002
	05.88 - 02.93		31.104.001.000.1	К суппорту	001
Sierra (GBG, GB4)					
1,6 1,8 2,0 2,0 i 2,0 i 16V	01.87 - 02.93		31.079.003.000.1		003
	01.87 - 02.93		31.103.002.000.1		002
	01.87 - 02.93		31.104.001.000.1	С ABS	001
2,0 XR 4x4	01.90 - 02.93		31.079.003.000.1		003
	01.90 - 02.93		31.103.002.000.1		002
	01.90 - 02.93		31.104.001.000.1	К суппорту	001
2,3 D	01.87 - 09.89		31.079.003.000.1		003
	01.87 - 08.89		31.103.002.000.1		002
	01.87 - 09.89		31.104.001.000.1	С ABS	001
2,9 i 1,8 TD	08.88 - 02.93		31.079.003.000.1		003
	08.88 - 02.93		31.103.002.000.1		002
	08.88 - 02.93		31.104.001.000.1	С ABS	001
Sierra Hatchback (GBC, GBG)					
1,6 i 1,8 i	- 02.93		31.079.003.000.1		003
	- 02.93		31.103.002.000.1		002
	- 02.93		31.104.001.000.1	С ABS	001
1,6 2,0 i 2,0 i 16V	01.87 - 02.93		31.079.003.000.1		003
	01.87 - 02.93		31.103.002.000.1		002
	01.87 - 02.93		31.104.001.000.1	С ABS	001
2,0 16V Coswort 4x4	01.90 - 02.93		31.079.003.000.1		003
	01.90 - 02.93		31.104.001.000.1	С ABS	001
2,0 RS Coswort	11.87 - 01.90		31.079.003.000.1		003
	11.87 - 01.90		31.103.002.000.1		002
	11.87 - 01.90		31.104.001.000.1	К суппорту	001
2,3 D	01.87 - 09.89		31.079.003.000.1		003
	01.87 - 09.89		31.103.002.000.1		002
	01.87 - 09.89		31.104.001.000.1	С ABS	001
2,8 i XR 4x4	01.87 - 08.88		31.079.003.000.1		003
	01.87 - 08.88		31.104.001.000.1	С ABS	001
2,9 i 2,9 i XR 4x4 1,8 TD	08.88 - 02.93		31.079.003.000.1		003
	08.88 - 02.93		31.103.002.000.1		002
	08.88 - 02.93		31.104.001.000.1	С ABS	001
Sierra Hatchback (GBC)					
1,3	07.82 - 07.85		31.026.001.000.1		001
	07.82 - 11.89		31.103.002.000.1		002
	08.85 - 11.89		31.079.003.000.1		003
1,6 2,0 2,3 2,8 XR 4 i 2,3 D	08.82 - 07.85		31.026.001.000.1		001
	08.82 - 12.86		31.103.002.000.1		002
	08.85 - 12.86		31.079.003.000.1		003
1,8 2,0 i	- 07.85		31.026.001.000.1		001
	- 12.86		31.103.002.000.1		002

# Таблица применяемости тормозных шлангов









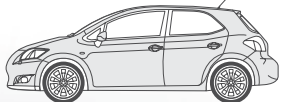























		i	Код Дафми	Дополнительная информация	Тип №
2,8 XR 4x4	08.85 - 12.86		31.079.003.000.1		003
	02.85 - 12.86		31.079.003.000.1		003
	02.85 - 12.86		31.103.002.000.1		002
	02.85 - 12.86		31.104.001.000.1	К суппорту	001
<b>Sierra Turnier (BNC)</b>					
All models	08.82 - 07.85		31.026.001.000.1		001
	08.82 - 12.86		31.103.002.000.1		002
	08.85 - 12.86		31.079.003.000.1		003
<b>Sierra Turnier (BNG)</b>					
All models	01.87 - 02.93		31.079.003.000.1		003
	01.87 - 02.93		31.103.002.000.1		002
	01.87 - 02.93		31.104.001.000.1	С ABS	001
<b>Transit box body (E_ _)</b>					
2,0 2,0 i 2,5 DI 2,5 TD	05.91 - 03.00		31.077.031.000.1		031
	05.91 - 03.00		31.078.032.000.1		032
<b>Transit box body (V_ _)</b>					
1,6 2,0 2,4 D 2,5 D	04.78 - 12.85		31.072.027.000.1	Вертикально   2 порш.   К суппорту	027
	04.78 - 12.85		31.073.028.000.1	Вертикально   2 порш.   К суппорту	028
	04.78 - 12.85		31.074.029.000.1	Вертикально   4 порш.   К суппорту	029
	04.78 - 12.85		31.075.030.000.1	Вертикально   4 порш.   К суппорту	030
	04.78 - 12.85		31.076.025.000.1	Только 80, 100S, 120	025
<b>Transit Bus (E_ _)</b>					
2,0 2,0 i 2,5 DI 2,5 TD	08.91 - 03.00		31.077.031.000.1		031
	08.91 - 03.00		31.078.032.000.1		031
<b>Transit Bus (T_ _)</b>					
1,6	12.85 - 01.89		31.077.031.000.1	ось 80 - 120	031
	12.85 - 01.89		31.078.032.000.1	ось 80 - 120	032
2	11.85 - 09.92		31.077.031.000.1	ось 80 - 120	031
	11.85 - 09.92		31.078.032.000.1	ось 80 - 120	032
2,5 D	12.85 - 09.92		31.077.031.000.1		031
	12.85 - 09.92		31.078.032.000.1		032
<b>Transit Bus (V_ _)</b>					
1,6 2,0	04.78 - 12.85		31.072.027.000.1	Вертикально   2 порш.   К суппорту	027
	04.78 - 12.85		31.073.028.000.1	Вертикально   2 порш.   К суппорту	028
	04.78 - 12.85		31.074.029.000.1	Вертикально   4 порш.   К суппорту	029
	04.78 - 12.85		31.075.030.000.1	Вертикально   4 порш.   К суппорту	030
	04.78 - 12.85		31.076.025.000.1		025
2,3 D 2,5	04.78 - 12.85		31.072.027.000.1	Вертикально   2 порш.   К суппорту	027
	04.78 - 12.85		31.073.028.000.1	Вертикально   2 порш.   К суппорту	028
	04.78 - 12.85		31.074.029.000.1	Вертикально   4 порш.   К суппорту	029
	04.78 - 12.85		31.075.030.000.1	Вертикально   4 порш.   К суппорту	030
	04.78 - 12.85		31.076.025.000.1		025
<b>Transit Platform/Chassis (E_ _)</b>					
2,0, 2,5 DI, 2,5 TD	09.91 - 03.00		31.077.031.000.1		031
	09.91 - 03.00		31.078.032.000.1		032
<b>Transit Platform/Chassis (V_ _)</b>					
1,6,2,0, 2,5 D	04.78 - 12.85		31.072.027.000.1	Вертикально   2 порш.   К суппорту	027
	04.78 - 12.85		31.073.028.000.1	Вертикально   2 порш.   К суппорту	028
	04.78 - 12.85		31.074.029.000.1	Вертикально   4 порш.   К суппорту	029
	04.78 - 12.85		31.075.030.000.1	Вертикально   4 порш.   К суппорту	030
	04.78 - 12.85		31.076.025.000.1		025









## HONDA

<b>Accord III. (CA4, CA5)</b>					
1,6 L	11.85 - 12.89		31.113.041.000.1		041
	11.85 - 12.89		31.114.041.000.1		041
	11.85 - 12.89		31.115.040.000.1	Шасси OC054978-	040
2,0 EX	11.85 - 12.89		31.113.041.000.1		041
	11.85 - 12.89		31.114.041.000.1		041
	11.85 - 12.89		31.115.040.000.1	Шасси OC054978-	040
2,0 EXi	11.85 - 12.87		31.113.041.000.1		041
	11.85 - 12.87		31.114.041.000.1		041
2,0 i 16V	01.87 - 12.89		31.113.041.000.1		041
	01.87 - 12.89		31.114.041.000.1		041
<b>Accord III. Aerodeck (CA5)</b>					
2,0 EX (CA5)	10.87 - 12.89		31.113.041.000.1		041
	10.87 - 12.89		31.114.041.000.1		041
	10.87 - 12.89		31.115.040.000.1		040
2,0 EXi	11.85 - 12.89		31.113.041.000.1		041
	11.85 - 12.89		31.114.041.000.1		041
	11.85 - 12.89		31.115.040.000.1		040









		i	Код Дафми	Дополнительная информация	Тип №
---	---	---	-----------	---------------------------	-------

Civic II.(AL, AJ, AG, AH)					
1,2	01.85 - 10.87		31.116.017.000.1		017
1,3	10.83 - 10.87		31.116.017.000.1		017
1,5GL	10.83 - 10.87		31.116.017.000.1		017
Civic (SL)					
1300 L	09.80 - 08.83		31.174.016.000.1		016
	09.80 - 08.83		31.175.020.000.1		020
Civic Hatchback (SB,SS)					
1300 L	09.79 - 09.83		31.174.016.000.1		016
	09.79 - 09.83		31.175.020.000.1		020
Civic II.					
1,2	01.85 - 10.87		31.116.017.000.1		017
1,3	10.83 - 10.87		31.116.017.000.1		017
1,5 GL	10.83 - 10.87		31.116.017.000.1		017
1,5 GT	01.85 - 10.87		31.116.017.000.1		017
Civic III. Sedan (ED)					
1,5 i 16V	10.87 - 09.91		31.115.040.000.1		040
1,6 i 16V	10.87 - 09.91		31.115.040.000.1		040
Civic IV. Coupe (EJ)					
1,5 i Vtec	01.94 - 12.96		31.115.040.000.1		040
1,6 i	11.95 - 12.96		31.115.040.000.1		040
1,6 i Vtec	01.94 - 12.96		31.115.040.000.1		040
Civic IV. Fastback (MA,MB)					
1,4 i 1,5 i Vtec-E	04.94 - 01.97		31.115.040.000.1		040
1,6 i 1,6 i Vtec	04.94 - 01.97		31.115.040.000.1		040
Civic IV. Hatchback (EG)					
1,3 16V	10.91 - 11.95		31.115.040.000.1		040
1,5 i 16V	10.91 - 11.95		31.115.040.000.1		040
Civic Shuttle (AN, AR)					
1,5	10.83 - 10.87		31.116.017.000.1		017
Civic V.(EJ9, EK3/4)					
1,4 1,5 1,6 i Vti	11.95 - 02.01		31.115.040.000.1		040
Civic V.Fastback(MB)					
1,4 16V 1,5 1,6 i Vti	11.95 - 02.01		31.115.040.000.1		040
Civic V.Hatchback(EJ9, EK1/3/4)					
1,4 i 1,5 i 1,6 i 1,6 i Vti	11.95 - 02.01		31.115.040.000.1		040
Civic Wagon (WC)					
1300	09.79 - 09.83		31.174.016.000.1		016
	79.00 - 09.83		31.175.020.000.1		020
CRX I. (AF, AS)					
1,5 i	10.83 - 11.86		31.116.017.000.1		017
	10.83 - 11.86		31.117.039.000.1		039
1,6 i	03.86 - 10.87		31.116.017.000.1		017
	03.86 - 10.87		31.117.039.000.1		039
Prelude III. (BA)					
2,0 2,0 EX	04.87 - 01.92		31.165.041.000.1		041
	04.87 - 01.92		31.167.041.000.1		041

## HYUNDAI

Lantra I.(J-1)					
1,5 i.e. 1,6 i.e. 16V 1,8 i.e. 16V	12.90 - 05.95		31.062.020.000.1		20
Pony Saloon					
All models	00.85 -		31.118.019.000.1		019
	00.85 -		31.066.010.000.1		010
Sonata I.(Y-2)					
1,8 i	09.88 - 10.93		31.124.020.000.1		20
2,0 i	09.88 - 08.91		31.124.020.000.1		20
2,0 i 16V	01.91 - 10.93		31.124.020.000.1		20
3,0 i 16V	07.92 - 10.93		31.062.020.000.1		20
	07.92 - 10.93		31.124.020.000.1		20
Stellar	00.87 - 00.91		31.118.019.000.1		019

## LANCIA







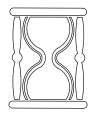

Dedra (835)					
1,6 16V	01.96 - 07.99		31.094.018.000.1		018
1,6 i.e.	08.89 - 07.99		31.095.007.000.1		007
	08.89 - 07.99		31.094.018.000.1		018
1,6 LE	07.94 - 07.99		31.095.007.000.1	Без ABS	007
	07.94 - 07.99		31.182.008.000.1	Без ABS	008
	07.94 - 07.99		31.182.008.000.1	C ABS	008
	07.94 - 07.99		31.094.018.000.1		018
1,8 GT 16V	03.96 - 07.99		31.094.018.000.1		018

# Таблица применяемости тормозных шлангов























































		i	Код Дафми	Дополнительная информация	Тип №
1,8 i.e.	09.89 - 07.99	↗	31.095.007.000.1		007
	09.89 - 07.99	↘	31.094.018.000.1		018
1,8 i.e./LE	08.93 - 07.99	↗	31.095.007.000.1		007
	08.93 - 07.99	↘	31.094.018.000.1		018
1,8 LE	03.96 - 07.99	↗	31.182.008.000.1		008
	03.96 - 07.99	↘	31.094.018.000.1		018
1,9 IDS	04.89 - 07.99	↗	31.182.008.000.1		008
2,0 16 V	07.94 - 07.99	↗	31.182.008.000.1	C ABS	008
	07.94 - 07.99	↘	31.094.018.000.1		018
2,0 HF Integrale 4WD	11.90 - 07.99	↗	31.182.008.000.1		008
	11.90 - 07.99	↘	31.094.018.000.1		018
2,0 i.e.	09.89 - 07.99	↗	31.095.007.000.1	C ABS	007
	09.89 - 07.99	↘	31.182.008.000.1		008
	09.89 - 07.99	↘	31.094.018.000.1		018
2,0 i.e. Turbo	04.91 - 07.99	↗	31.182.008.000.1		008
	04.91 - 07.99	↘	31.094.018.000.1		018
<b>Dedra Station Wagon (835)</b>					
1,6	10.94 - 07.99	↗	31.095.007.000.1	Без ABS	007
	10.94 - 07.99	↘	31.182.008.000.1	Без ABS	008
	10.94 - 07.99	↘	31.182.008.000.1	C ABS	008
	10.94 - 07.99	↘	31.095.007.000.1		007
1,6 16V 1,8 GT 16V	01.96 - 07.99	↘	31.094.018.000.1		018
1,8	07.94 - 07.99	↗	31.095.007.000.1	Без ABS	007
	07.94 - 07.99	↘	31.182.008.000.1	Без ABS	008
	07.94 - 07.99	↘	31.182.008.000.1	C ABS	008
	07.94 - 07.99	↘	31.094.018.000.1		018
1,8 LE	03.96 - 09.97	↗	31.182.008.000.1		008
	03.96 - 09.97	↘	31.094.018.000.1		018
1,9 TDS	07.94 - 07.99	↘	31.094.018.000.1		018
2,0 2,0 4WD	07.94 - 11.95	↗	31.182.008.000.1		008
	07.94 - 07.99	↘	31.094.018.000.1		018
<b>Delta II. (836)</b>					
1,4	10.94 -	↗	31.095.007.000.1		007
	10.94 -	↘	31.182.008.000.1		008
	10.94 -	↘	31.094.018.000.1		018
1,6 i.e.	06.93 -	↗	31.095.007.000.1		007
	06.93 -	↘	31.182.008.000.1		008
	06.93 -	↘	31.094.018.000.1		018
1,8	07.94 -	↗	31.095.007.000.1		007
	07.94 -	↘	31.182.008.000.1		008
1,8 i.e.	06.93 -	↗	31.095.007.000.1		007
	06.93 -	↘	31.182.008.000.1		008
	06.93 -	↘	31.094.018.000.1		018
1,9 TD	10.94 -	↘	31.094.018.000.1		018
2,0 16V, 2,0 Turbo	06.93 -	↘	31.094.018.000.1		018
2,0 HPE	07.96 -	↘	31.094.018.000.1		018
<b>Thema (834)</b>					
2000 16V	08.92 - 12.93	↘	31.181.008.000.1	Без ABS	008
2000 16V Turbo	12.88 - 06.90	↗	31.180.008.000.1	Без ABS	008
	12.88 - 06.90	↘	31.181.008.000.1	Без ABS	008
	10.92 -	↘	31.181.008.000.1	Без ABS	008
2000 i.e.	11.84 - 09.88	↗	31.180.008.000.1		008
	11.84 - 09.88	↘	31.181.008.000.1	Без ABS	008
2000 i.e. 16V	02.89 - 05.92	↗	31.180.008.000.1		008
	02.89 - 05.92	↘	31.181.008.000.1	Без ABS	008
2000 i.e. 16V Turbo	04.89 - 05.92	↗	31.180.008.000.1		008
	04.89 - 05.92	↘	31.181.008.000.1	Без ABS	008
2000 i.e. Turbo	11.84 - 05.90	↗	31.180.008.000.1		008
	11.84 - 05.90	↘	31.181.008.000.1	Без ABS	008
2500 TD	11.84 - 09.88	↗	31.180.008.000.1		008
	11.84 - 09.88	↘	31.181.008.000.1	Без ABS	008
2500 TDS	06.88 - 05.92	↗	31.180.008.000.1		008
	06.88 - 05.92	↘	31.181.008.000.1	Без ABS	008
2850 V6 i.e.	11.84 - 05.92	↗	31.180.008.000.1		008
	11.84 - 05.92	↘	31.181.008.000.1	Без ABS	008
8,32	10.87 -	↗	31.180.008.000.1		008
<b>Thema Station Wagon (834)</b>					
2000 16V	05.92 - 07.94	↘	31.181.008.000.1	Без ABS	008
2000 i.e. Turbo	02.89 - 05.92	↗	31.180.008.000.1		008
	02.89 - 05.92	↘	31.181.008.000.1	Без ABS	008
2000 Turbo 16V	01.89 - 03.93	↗	31.180.008.000.1		008

		i	Код Дафми	Дополнительная информация	Тип №
---	---	---	-----------	---------------------------	-------

	01.89 - 03.93		31.181.008.000.1	Без ABS	008
2500 TD	03.87 - 09.90		31.181.008.000.1	Без ABS	008
<b>Y (840)</b>					
1.1	04.97 -		31.050.018.000.1		018
1.2	03.96 -		31.050.018.000.1		018
	03.96 -		31.050.018.000.1		018
1.2 16V	04.97 -		31.050.018.000.1		018
1.4 12V	03.96 -		31.050.018.000.1		018
<b>Y10 (156)</b>					
1,0 Fire	06.85 - 12.85		31.097.007.000.1		007

## MAZDA































































<b>323 II. (BD)</b>					
1,3	11.80 - 05.85		31.119.037.000.1		037
	11.80 - 05.85		31.061.020.000.1		020
	06.85 - 10.89		31.120.037.000.1		037
	06.85 - 10.89		31.121.019.000.1		019
1,5	05.81 - 05.85		31.119.037.000.1		037
	05.81 - 05.85		31.061.020.000.1		020
	06.85 - 09.86		31.120.037.000.1		037
	06.85 - 09.86		31.121.019.000.1		019
<b>323 II. Hatchback (BD)</b>					
1,1	11.80 - 05.85		31.119.037.000.1		037
	11.80 - 05.85		31.061.020.000.1		020
	06.85 - 10.85		31.120.037.000.1	Барabanные тормоза	037
	06.85 - 10.85		31.121.019.000.1		019
1,3	06.85 - 10.89		31.120.037.000.1	Барabanные тормоза	037
	06.85 - 10.89		31.121.019.000.1		019
	11.80 - 05.85		31.119.037.000.1		037
	11.80 - 05.85		31.061.020.000.1		020
1,5	11.80 - 05.85		31.119.037.000.1		037
	11.80 - 05.85		31.061.020.000.1		020
	06.85 - 12.85		31.120.037.000.1		037
	06.85 - 12.85		31.121.019.000.1		019
<b>323 III. (BF)</b>					
1,3	08.85 - 05.89		31.120.037.000.1		037
	08.85 - 05.89		31.121.019.000.1		019
1,5	08.85 - 10.89		31.120.037.000.1		037
	08.85 - 10.89		31.121.019.000.1		019
1,6 GT	01.86 - 10.89		31.120.037.000.1		037
1,6 GT Turbo	10.85 - 11.91		31.120.037.000.1		037
1,7 D	09.86 - 05.89		31.120.037.000.1		037
	09.86 - 05.89		31.121.019.000.1		019
<b>323 III. Station Wagon (BW)</b>					
1,5	01.87 - 05.89		31.120.037.000.1	Внутренний	037
	01.87 - 05.89		31.121.019.000.1		019
	01.87 - 05.89		31.154.050.000.1		050
1,6	09.86 - 03.93		31.120.037.000.1		037
	09.86 - 03.93		31.121.019.000.1		019
1,6 4x4	05.90 - 03.93		31.120.037.000.1		037
	05.90 - 03.93		31.121.019.000.1		019
1,7 D	11.86 - 03.93		31.120.037.000.1		037
	11.86 - 03.93		31.121.019.000.1		019
<b>323 III. Hatchback (BF)</b>					
1,1 1,3	09.85 - 12.87		31.120.037.000.1		037
	09.85 - 12.87		31.121.019.000.1		019
1,4	09.87 - 10.89		31.120.037.000.1		037
	09.87 - 10.89		31.121.019.000.1		019
1,5	08.85 - 10.89		31.120.037.000.1		037
	08.85 - 10.89		31.121.019.000.1		019
1,6 GT	08.85 - 12.88		31.120.037.000.1		037
1,6 GT TURBO (BF1)	10.85 - 11.91		31.120.037.000.1		037
1,6 GT Turbo 4WD (BF2)	08.87 - 11.91		31.120.037.000.1		037
1,7 D	04.86 - 06.89		31.120.037.000.1		037
	04.86 - 06.89		31.121.019.000.1		019
<b>323 (FA)</b>					
1,0 1,3	06.77 - 05.80		31.059.015.000.1		015
1,4	05.78 - 05.80		31.059.015.000.1		015
<b>323 C IV.(BG)</b>					
1,3	09.89 - 07.94		31.201.047.000.1		047
	09.89 - 07.94		31.154.050.000.1		050















































# Таблица применяемости тормозных шлангов

















		i	Код Дафми	Дополнительная информация	Тип №
---	---	---	-----------	---------------------------	-------

1,3 16V	09.89 - 07.94		31.201.047.000.1		047
	09.89 - 07.94		31.154.050.000.1		050
1,6	09.89 - 06.91		31.201.047.000.1		047
	09.89 - 06.91		31.154.050.000.1		050
1,6 16V	03.91 - 10.94		31.201.047.000.1		047
	03.91 - 10.94		31.154.050.000.1		050
1,7 D	08.89 - 07.94		31.201.047.000.1		047
	08.89 - 07.94		31.154.050.000.1		050
1,8 16V GT	09.89 - 03.93		31.201.047.000.1		047
	09.89 - 03.93		31.154.050.000.1		050
1,8 16V Turbo 4WD	09.90 - 12.92		31.201.047.000.1		047
	09.90 - 12.92		31.154.050.000.1		050
<b>323 C V. (BA)</b>					
All models	08.94 - 09.98		31.207.047.000.1		047
	08.94 - 09.98		31.200.050.000.1		050
<b>323 F IV. (BG)</b>					
All models	09.89 - 10.94		31.201.047.000.1		050
	09.89 - 06.91		31.154.050.000.1		050
<b>323 F V. (BA)</b>					
All models	07.94 - 07.98		31.207.047.000.1		047
	07.94 - 07.98		31.200.050.000.1		050
<b>323 S IV. (BG)</b>					
1,3	09.89 - 06.91		31.201.047.000.1		047
	09.89 - 06.91		31.154.050.000.1		050
1,3 16V	04.91 - 07.94		31.201.047.000.1		047
	04.91 - 07.94		31.154.050.000.1		050
1,6	09.89 - 06.91		31.201.047.000.1		047
	09.89 - 06.91		31.154.050.000.1		050
1,6 16V	03.91 - 10.94		31.201.047.000.1		047
	03.91 - 10.94		31.154.050.000.1		050
1,7 D	01.90 - 07.94		31.201.047.000.1		047
	01.90 - 07.94		31.154.050.000.1		050
1,8 16V	09.91 - 07.94		31.154.050.000.1		050
<b>323 S V. (BA)</b>					
All models	08.94 - 07.98		31.207.047.000.1		047
	08.94 - 07.99		31.200.050.000.1		050
<b>323 Station Wagon (FA)</b>					
1,4	05.78 - 08.82		31.059.015.000.1		015
	05.78 - 08.82		31.061.020.000.1		020
1,5	04.82 - 05.86		31.059.015.000.1		015
	04.82 - 05.85		31.061.020.000.1		020
	06.85 - 05.86		31.121.019.000.1		019
	06.85 - 05.86		31.121.019.000.1		019
<b>626 II. (GC)</b>					
1,6	11.82 - 06.87		31.122.037.000.1		037
	11.82 - 06.87		31.123.020.000.1	Барабанные тормоза	020
2	03.83 - 09.87		31.122.037.000.1		037
	03.83 - 09.87		31.123.020.000.1	Барабанные тормоза	020
2,2 D	01.83 - 06.87		31.122.037.000.1		037
	01.83 - 06.87		31.123.020.000.1	Барабанные тормоза	020
<b>626 II. Hatchback (GC)</b>					
1,6	03.83 - 09.87		31.122.037.000.1		037
	03.83 - 09.87		31.123.020.000.1		020
<b>626 III. Coupe (GD)</b>					
1,8	09.87 - 08.91		31.122.037.000.1		037
	09.87 - 08.91		31.123.020.000.1	Барабанные тормоза	020
2	09.87 - 10.90		31.122.037.000.1		037
	09.87 - 10.90		31.123.020.000.1	Барабанные тормоза	020
2,0 12V	09.87 - 12.88		31.122.037.000.1		037
	09.87 - 12.88		31.123.020.000.1	Барабанные тормоза	020
2,0 16V	06.87 - 10.90		31.122.037.000.1		037
	06.87 - 10.90		31.123.020.000.1	Барабанные тормоза	020
2,2 12V	03.90 - 12.91		31.122.037.000.1		037
	03.90 - 12.91		31.123.020.000.1	Барабанные тормоза	020
<b>626 III. (GO)</b>					
1,8	11.87 - 05.92		31.122.037.000.1		037
	11.87 - 05.92		31.123.020.000.1	Барабанные тормоза	020
2	09.87 - 10.90		31.122.037.000.1		037
	09.87 - 10.90		31.123.020.000.1	Барабанные тормоза	020
2,0 12V	09.87 - 05.92		31.122.037.000.1		037
	09.87 - 05.92		31.123.020.000.1	Барабанные тормоза	020
2,0 16V	11.87 - 05.92		31.122.037.000.1		037

		i	Код Дафми	Дополнительная информация	Тип №
---	---	---	-----------	---------------------------	-------

	11.87 - 05.92		31.123.020.000.1	Барабанные тормоза	020
2,0 D	07.87 - 07.91		31.122.037.000.1		037
	07.87 - 07.91		31.123.020.000.1	Барабанные тормоза	020
2,2 12V	11.87 - 07.91		31.122.037.000.1		037
	11.87 - 07.91		31.123.020.000.1	Барабанные тормоза	020
<b>626 III.Hatchback (GD)</b>					
1,8	11.87 - 05.92		31.122.037.000.1		037
	11.87 - 07.91		31.123.020.000.1	Барабанные тормоза	020
2	09.87 - 10.90		31.122.037.000.1		037
	09.87 - 10.90		31.123.020.000.1	Барабанные тормоза	020
2,0 12V	11.87 - 05.92		31.122.037.000.1		037
	11.87 - 05.92		31.123.020.000.1	Барабанные тормоза	020
2	07.87 - 07.91		31.122.037.000.1		037
	07.87 - 07.91		31.123.020.000.1	Барабанные тормоза	020
2,2 12V	06.88 - 04.92		31.122.037.000.1		037
	06.88 - 04.92		31.123.020.000.1	Барабанные тормоза	020
<b>626 III.Station Wagon (GV)</b>					
1,8	01.88 - 03.92		31.122.037.000.1		037
	01.88 - 03.92		31.123.020.000.1	Барабанные тормоза	020
2	10.88 - 10.90		31.122.037.000.1		037
	10.88 - 10.90		31.166.037.000.1		037
2,0 12V	09.87 - 01.90		31.122.037.000.1		037
	09.87 - 01.90		31.166.037.000.1		037
2,0 16V	01.88 - 03.92		31.122.037.000.1		037
	01.88 - 03.92		31.166.037.000.1		037
2,0 D	09.88 - 07.91		31.122.037.000.1		037
	09.88 - 07.91		31.166.037.000.1		037
2,0 D Complex	05.93 - 11.96		31.166.037.000.1		037
2,2 12V	03.89 - 10.90		31.122.037.000.1		037
	03.89 - 10.90		31.166.037.000.1		037
2,2 12V 4WD	05.91 - 11.92		31.122.037.000.1		037
	05.91 - 11.92		31.166.037.000.1		037
<b>626 IV.(GE)</b>					
1,8 i	01.92 - 04.97		31.201.047.000.1		047
2,0 i	01.92 - 04.97		31.201.047.000.1		047
	01.92 - 04.97		31.208.037.000.1		037
2,0 i 4 WD	01.92 - 04.97		31.201.047.000.1		047
<b>626 IV.Hatchback (GE)</b>					
1,8	08.91 - 04.97		31.201.047.000.1		047
2,0 D GLX Complex	01.93 - 04.97		31.208.037.000.1		037
2,0 i	08.91 - 04.97		31.201.047.000.1		047
	08.91 - 04.97		31.208.037.000.1		037
2,5 24V	08.91 - 04.97		31.201.047.000.1		047
	01.92 - 04.97		31.208.037.000.1		037
<b>626 (CB)</b>					
1,6 2,0	05.79 - 07.80		31.059.015.000.1		015
<b>E2200, 2200</b>					
2,0 2,0 D	05.85 - 04.89		31.155.047.000.1		047
2,2 D	05.85 - 02.88		31.155.047.000.1		047
2,2 D 4WD	03.91 -		31.155.047.000.1		047
<b>RX7 I (SA)</b>					
Wankel	05.79 - 03.86		31.059.015.000.1	Свертесь с чертежем !	015









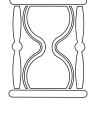

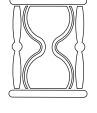















































## MERCEDES

<b>/8 (W114)</b>					
230	01.68 - 11.76		31.008.005.000.1		005
	01.68 - 11.76		31.060.026.000.1	-Шасси 065713	026
	01.68 - 11.76		31.006.005.000.1	Шасси 144895-	005
250	01.68 - 08.72		31.008.005.000.1		005
	01.68 - 08.72		31.060.026.000.1	-Шасси 055234	026
250 2,8	06.72 - 11.76		31.008.005.000.1		005
	06.72 - 03.73		31.008.005.000.1		005
	-		31.060.026.000.1	-Шасси 055234	026
	04.73 - 06.76		31.006.005.000.1		005
280 280 E	06.72 - 11.76		31.008.005.000.1		005
	06.72 - 11.76		31.006.005.000.1	Шасси 013048-	005
<b>/8 (W115)</b>					
200	01.68 - 01.77		31.008.005.000.1		005
	01.68 - 01.77		31.060.026.000.1	-Шасси 070415	026
	01.68 - 01.77		31.006.005.000.1	Шасси 159568-	005
200 D 220 D	01.68 - 01.77		31.008.005.000.1		005

# Таблица применяемости тормозных шлангов



		i	Код Дафми	Дополнительная информация	Тип №
220	01.68 - 01.77	↖↗	31.060.026.000.1	-Шасси 076568	026
	01.68 - 01.77	↖↗	31.006.005.000.1	Шасси 329665-	005
	01.68 - 07.73	↖↗	31.008.005.000.1		005
	01.68 - 07.73	↖↗	31.060.026.000.1	-Шасси 070415	026
	01.68 - 07.73	↖↗	31.006.005.000.1	Шасси 159568-	005
230	08.73 - 12.76	↖↗	31.008.005.000.1		005
	08.73 - 12.76	↖↗	31.006.005.000.1		005
240 D	08.73 - 01.77	↖↗	31.008.005.000.1		005
	08.73 - 01.77	↖↗	31.006.005.000.1		005
240 D 3,0	08.74 - 11.76	↖↗	31.008.005.000.1		005
	08.74 - 11.76	↖↗	31.006.005.000.1		005
<b>100 (W631)</b>					
All models	02.88 - 02.96	↖↗	31.131.043.000.1		043
	02.88 - 02.96	↓	31.137.044.000.1		044
<b>190 (W201)</b>					
1,8	04.90 - 08.93	↖↗	31.025.044.000.1		044
	04.90 - 08.93	↖↗	31.006.005.000.1		005
2,0	10.82 - 05.90	↖↗	31.025.044.000.1		044
	10.82 - 05.90	↖↗	31.006.005.000.1		005
2,0 D	08.83 - 08.93	↖↗	31.025.044.000.1		044
	08.83 - 08.93	↖↗	31.006.005.000.1		005
2,5 D 2,5 TD	04.85 - 08.93	↖↗	31.025.044.000.1		044
	04.85 - 08.93	↖↗	31.006.005.000.1		005
E 2,0	01.85 - 08.93	↖↗	31.025.044.000.1		044
	01.85 - 08.93	↖↗	31.006.005.000.1		005
E 2,3-16	04.84 - 01.87	↖↗	31.025.044.000.1		044
	04.84 - 01.87	↖↗	31.006.005.000.1		005
E 2,3	09.86 - 08.91	↖↗	31.025.044.000.1		044
	09.86 - 08.91	↖↗	31.006.005.000.1		005
E 2,5-16	09.88 - 08.93	↖↗	31.025.044.000.1		044
	09.88 - 08.93	↖↗	31.006.005.000.1		005
E 2,6	09.86 - 08.93	↖↗	31.025.044.000.1		044
	09.86 - 08.93	↖↗	31.006.005.000.1		005
E Evolution II. 2,5	05.90 - 08.93	↖↗	31.025.044.000.1		044
	05.90 - 08.93	↖↗	31.006.005.000.1		005
<b>307 D</b>					
	00.77 -	↖↗	31.069.026.000.1		026
	00.77 -	↓	31.008.005.000.1		005
<b>308/310 (602)</b>					
	00.77 -	↖↗	31.069.026.000.1		026
	00.77 -	↓	31.008.005.000.1		005
<b>407/410 D TN(BM611)</b>					
	06.81 -	↖↗	31.069.026.000.1		026
	06.81 -	↓	31.008.005.000.1		005
<b>507D/510 LN(BM667)</b>					
	00.86 -	↖↗	31.069.026.000.1		026
<b>C-Klasse (W202)</b>					
C 180	11.94 - 05.00	↖↗	31.006.005.000.1		005
C 200	01.94 - 05.00	↖↗	31.006.005.000.1		005
C 200 GDI	03.98 - 05.00	↖↗	31.006.005.000.1		005
C 200 D	08.93 - 05.00	↖↗	31.006.005.000.1		005
C 220	03.93 - 05.00	↖↗	31.006.005.000.1		005
C 220 GDI	09.97 - 05.00	↖↗	31.006.005.000.1		005
C 230	06.96 - 05.00	↖↗	31.006.005.000.1		005
C 240	06.97 - 05.00	↖↗	31.006.005.000.1		005
C 250 D	05.93 - 05.00	↖↗	31.006.005.000.1		005
C 250 TD	10.95 - 05.00	↖↗	31.006.005.000.1		005
C 280	05.93 - 05.00	↖↗	31.006.005.000.1		005
C 36 AMG	05.94 - 05.00	↖↗	31.006.005.000.1		005
C 43 AMG	08.97 - 05.00	↖↗	31.006.005.000.1		005
<b>C-Klasse T-Mod. (T202)</b>					
C 180 T C 200 T C 220 TD	05.96 -	↖↗	31.006.005.000.1		005
C 240 T C 280 T	06.97 -	↖↗	31.006.005.000.1		005
C 250 T Turbo D	06.96 -	↖↗	31.006.005.000.1		005
C 43 AMG C 220 T GDI	08.97 -	↖↗	31.006.005.000.1		005
C 200 T 2,0 C 230 T C 200 TD	10.96 -	↖↗	31.006.005.000.1		005
<b>CLK (C208)</b>					
200 Kompressor	06.97 - 06.00	↖↗	31.006.005.000.1		005
200 200 16V 230 16V 320	06.97 -	↖↗	31.006.005.000.1		005
230 Kompressor	06.97 - 06.00	↖↗	31.006.005.000.1		005
430	07.98 -	↖↗	31.006.005.000.1		005











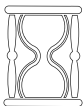























































		i	Код Дафми	Дополнительная информация	Тип №
55 AMG	08.99 -		31.006.005.000.1		005
<b>CLK (C209)</b>					
200 CGI, Kompressor	09.02 -		31.006.005.000.1		005
240	06.02 -		31.006.005.000.1		005
270 CDI	10.02 -		31.006.005.000.1		005
320	06.02 -		31.006.005.000.1		005
200	06.02 -		31.006.005.000.1		005
55 AMG	09.02 -		31.006.005.000.1		005
<b>Convertible/roadster (A124)</b>					
300 CE 24	04.92 - 06.93		31.025.044.000.1		044
	04.92 - 06.93		31.006.005.000.1		005
<b>Coupe (C123)</b>					
230 C	05.77 - 04.80		31.025.044.000.1	Шасси 015331- -Шасси 015330	044
	05.77 - 04.80		31.007.005.000.1		005
	05.77 - 04.80		31.006.005.000.1		005
230 CE	04.80 - 12.85		31.025.044.000.1		044
	04.80 - 12.85		31.006.005.000.1		005
280 C	03.77 - 03.80		31.025.044.000.1	Шасси 003417- -Шасси 003416	044
	03.77 - 03.80		31.007.005.000.1		005
	0377 - 03.80		31.006.005.000.1		005
280 CE	09.77 - 11.85		31.025.044.000.1	Шасси 017059- -Шасси 017058	044
	09.77 - 11.85		31.007.005.000.1		005
	09.77 - 11.85		31.006.005.000.1		005
300 C Turbo D	09.81 - 07.85		31.025.044.000.1	Автоматическая КПП Ручная КПП	044
	09.81 - 07.85		31.007.005.000.1		005
	09.81 - 07.85		31.006.005.000.1		005
<b>Coupe (C124)</b>					
200 CE 320 CE	10.92 - 05.93		31.025.044.000.1		044
	10.92 - 05.93		31.006.005.000.1		005
230 CE 300 CE	03.87 - 12.92		31.025.044.000.1		044
	03.87 - 12.92		31.006.005.000.1		005
<b>E-Klasse (W124)</b>					
300 D 300 TD	06.93 - 06.95		31.025.044.000.1		044
	06.93 - 06.95		31.006.005.000.1		005
E 300 4-matic E 300 TD 4-matic	06.93 - 06.95		31.006.005.000.1		005
E 36 AMG E 60 AMG	05.94 - 06.95		31.025.044.000.1		044
	05.94 - 06.95		31.006.005.000.1		005
E 200 E 220 E 280 E 320 E 420	06.93 - 06.95		31.025.044.000.1		044
	06.93 - 06.95		31.006.005.000.1		005
E 500 E 200 D E 250 D E 250 TD	06.93 - 06.95		31.025.044.000.1		044
	06.93 - 06.95		31.006.005.000.1		005
<b>E-Klasse coupe (C124, A124)</b>					
E 36 AMG	05.94 -		31.025.044.000.1		044
	05.94 -		31.006.005.000.1		005
E 200 E 220 E 320	06.93 -		31.025.044.000.1		044
	06.93 -		31.006.005.000.1		005
<b>E-Klasse T-Mod. (S124)</b>					
E 36 T AMG	05.94 - 06.96		31.025.044.000.1		044
	05.94 - 06.96		31.006.005.000.1		005
E 200 T E 220 T E 280 T	06.93 - 06.96		31.025.044.000.1		044
	06.93 - 06.96		31.006.005.000.1		005
E 300 T 4-matic E 300 T 4-matic	06.93 - 06.96		31.006.005.000.1		005
E 320 T E 300 T E 300 D E 300 TD	06.93 - 06.96		31.025.044.000.1		044
	06.93 - 06.96		31.006.005.000.1		005
<b>G Modell (W460)</b>					
230 GE 300 GE 250 GD	06.90 -		31.007.005.000.1		005
300 GD	09.89 -		31.007.005.000.1		005
G 300 TD G 350 TD	08.96 -		31.007.005.000.1		005
G 320	09.94 - 12.97		31.007.005.000.1		005
G 36 AMG	01.95 -		31.007.005.000.1		005
G 500 E	09.93 -		31.007.005.000.1		005
<b>Pullmann</b>					
600	09.64 - 01.79		31.008.005.000.1		005
	09.64 - 01.79		31.008.005.000.1		005
<b>S-Klasse (W116)</b>					
280 S,SE,SEL 350 SE,SEL	04.73 - 07.80		31.006.005.000.1		005
	08.72 - 07.80		31.008.005.000.1		005
450 SE,SEL	01.73 - 04.80		31.008.005.000.1		005
	04.73 - 04.80		31.006.005.000.1		005

# Таблица применяемости тормозных шлангов



		i	Код Дафми	Дополнительная информация	Тип №
--	--	---	-----------	---------------------------	-------

<b>S-Klasse (W126)</b>					
All models	10.79 - 06.91		31.025.044.000.1		044
	10.79 - 06.91		31.006.005.000.1		005
<b>S-Klasse (W140)</b>					
All models	03.91 - 10.98		31.006.005.000.1		005
<b>S-Klasse (W220)</b>					
S 280 S 320 S 430 S 500	10.98 -		31.006.005.000.1	Сверьтесь с чертежом !	005
<b>S-Klasse coupe (C126)</b>					
All models	10.81 - 06.91		31.025.044.000.1		044
	10.81 - 06.91		31.006.005.000.1		005
<b>S-Klasse coupe (C140)</b>					
SEC/CL 420 SEC/CL 600	10.94 - 08.95		31.006.005.000.1		005
SEC/CL 500	10.92 - 08.95		31.006.005.000.1		005
<b>SL (R107)</b>					
280 SL	08.74 - 07.85		31.008.005.000.1		005
	08.74 - 07.85		31.006.005.000.1		005
300 SL	09.85 - 08.89		31.025.044.000.1		044
	09.85 - 08.89		31.006.005.000.1		005
350 SL	05.71 - 02.80		31.008.005.000.1		005
	05.71 - 02.80		31.006.005.000.1		005
380 SL	09.80 - 08.85		31.008.005.000.1		005
	09.80 - 08.85		31.006.005.000.1		005
420 SL	01*86:- 08.89		31.025.044.000.1		044
	01.86 - 08.89		31.006.005.000.1		005
450 SL	10.72 - 10.80		31.008.005.000.1		005
	10.72 - 10.80		31.006.005.000.1		005
500 SL	05.80 - 12.85		31.008.005.000.1		005
	05.80 - 12.85		31.006.005.000.1		005
	01.86 - 08.89		31.025.044.000.1		044
	01.86 - 08.89		31.006.005.000.1		005
<b>SL (R129)</b>					
280 18V 320 18V 500 24V	05.98 -		31.025.044.000.1		044
	05.98 -		31.006.005.000.1		005
280 320	08.93 -		31.025.044.000.1		044
	08.93 -		31.006.005.000.1		005
300 SL 300 SL-24	03.89 - 08.93		31.025.044.000.1		044
	03.89 - 08.93		31.006.005.000.1		005
500 SL	09.89 - 08.92		31.025.044.000.1		044
	09.89 - 08.92		31.006.005.000.1		005
500 600	07.92 -		31.025.044.000.1		044
	07.92 -		31.006.005.000.1		005
60 AMG	05.97 -		31.025.044.000.1		044
	05.97 -		31.006.005.000.1		005
600 48V	05.98 -		31.025.044.000.1		044
	05.98 -		31.006.005.000.1		005
<b>SL coupe (C107)</b>					
All models	01.72 - 09.81		31.008.005.000.1		005
	01.72 - 09.81		31.006.005.000.1		005
<b>SLK (R170)</b>					
200 230	09.96 -		31.006.005.000.1		005
<b>Sprinter 2-t (901-902)</b>					
All models	02.95 -		31.213.058.000.1		005
	02.95 -		31.213.058.000.1		005
<b>Sprinter 3-t box body (903)</b>					
All models	02.95 -		31.213.058.000.1		005
	02.95 -		31.213.058.000.1		005
<b>Sprinter 3-t bus (903)</b>					
All models	02.95 -		31.213.058.000.1		005
	02.95 -		31.213.058.000.1		005
<b>Sprinter 4-t box (904)</b>					
All models	04.00 -		31.213.058.000.1		005
	04.00 -		31.213.058.000.1	К суппорту   Без ABS	005
<b>Sprinter 4-t bus (904)</b>					
All models	04.00 -		31.213.058.000.1		005
	04.00 -		31.213.058.000.1	К суппорту   Без ABS	005
<b>Sprinter 4-t Platform/Chassis (904)</b>					
All models	04.00 -		31.213.058.000.1		005
	04.00 -		31.213.058.000.1	К суппорту   Без ABS	005
<b>T-Mod. (S123)</b>					
200 T	11.80 - 11.85		31.025.044.000.1		044
	11.80 - 11.85		31.006.005.000.1		005

		i	Код Дафми	Дополнительная информация	Тип №
230 T	09.77 - 03.80		31.025.044.000.1	Шасси 004327- -Шасси 004326	044 005 005
	09.77 - 03.80		31.007.005.000.1		
	09.77 - 03.80		31.006.005.000.1		
230 TE	04.80 - 11.85		31.025.044.000.1		044 005
	04.80 - 11.85		31.006.005.000.1		
240 TD	09.77 - 12.85		31.025.044.000.1	Шасси 007371- -Шасси 007370	044 005 005
	09.77 - 12.85		31.007.005.000.1		
	09.77 - 12.85		31.006.005.000.1		
250 TE	05.78 - 08.82		31.025.044.000.1	Шасси 003286- -Шасси 003285	044 005 005
	05.78 - 08.82		31.007.005.000.1		
	05.78 - 08.82		31.006.005.000.1		
280 TE	09.77 - 11.85		31.025.044.000.1	Шасси 004196- -Шасси 004195	044 005
	09.77 - 11.85		31.007.005.000.1		
300 T Turbo D	10.80 - 11.85		31.025.044.000.1		044 005
	10.80 - 11.85		31.006.005.000.1		
300 TD	09.77 - 11.85		31.025.044.000.1	Шасси 011093- -Шасси 011092	044 005 005
	09.77 - 11.85		31.007.005.000.1		
	09.77 - 11.85		31.006.005.000.1		
<b>T-Mod. (S124)</b>					
All models	09.85 - 06.93		31.025.044.000.1		044 005
	09.85 - 06.93		31.006.005.000.1		
<b>T1 (601)</b>					
All models	04.77 - 02.96		31.069.026.000.1		044 026 005
	04.77 - 02.96		31.008.005.000.1		
<b>T1 (602)</b>					
308 D2,3, 310 D 2,9	06.89 - 02.96		31.069.026.000.1		026
	06.89 - 02.96		31.008.005.000.1		005
<b>W 123</b>					
200	02.76 - 11.85		31.025.044.000.1	Шасси 126116 -Шасси 126115	044 005 005
	02.76 - 11.85		31.007.005.000.1		
	02.76 - 11.85		31.006.005.000.1		
200 D	03.79 - 11.85		31.025.044.000.1	Шасси 179857- Шасси 179856	044 005 005
	03.79 - 11.85		31.007.005.000.1		
	03.79 - 11.85		31.006.005.000.1		
200 D.	06.76 - 02.79		31.025.044.000.1	Шасси 179866- -Шасси 179865	044 005 005
	06.76 - 02.79		31.007.005.000.1		
	06.76 - 02.79		31.006.005.000.1		
220 D	01.77 - 03.79		31.007.005.000.1		005 005
	01.77 - 03.79		31.006.005.000.1		
230	02.76 - 03.81		31.025.044.000.1	Шасси 158356- -Шасси 158355	044 005 005
	02.76 - 03.81		31.007.005.000.1		
	02.76 - 03.81		31.006.005.000.1		
230 E	04.80 - 12.85		31.025.044.000.1		044 005
	04.80 - 12.85		31.006.005.000.1		
240 D	02.76 - 11.85		31.025.044.000.1	Шасси 150315- -Шасси 150314	044 005 005
	02.76 - 11.85		31.007.005.000.1		
	02.76 - 11.85		31.006.005.000.1		
250	02.76 - 07.85		31.025.044.000.1	Шасси 079229- -Шасси 079228	044 005 005
	02.76 - 07.85		31.007.005.000.1		
	02.76 - 07.85		31.006.005.000.1		
280	02.76 - 08.81		31.025.044.000.1	Шасси 027814- -Шасси 027813	044 005 005
	02.76 - 08.81		31.007.005.000.1		
	02.76 - 08.81		31.006.005.000.1		
280 E	02.76 - 11.85		31.025.044.000.1	Шасси 064177- -Шасси 064176	044 005 005
	02.76 - 11.85		31.007.005.000.1		
	02.76 - 11.85		31.006.005.000.1		
300 D	02.76 - 11.85		31.025.044.000.1	Шасси 165148- -Шасси 165147	044 005 005
	02.76 - 11.85		31.007.005.000.1		
	02.76 - 11.85		31.006.005.000.1		
300 Turbo D	08.81 - 07.85		31.025.044.000.1	Автоматическая КПП Ручная КПП	044 005 005
	08.81 - 07.85		31.007.005.000.1		
	08.81 - 07.85		31.006.005.000.1		
<b>W 124</b>					
200	12.85 - 05.90		31.025.044.000.1		044 005
	12.85 - 05.90		31.006.005.000.1		
200 D	12.84 - 06.93		31.025.044.000.1		044 005
	12.84 - 06.93		31.006.005.000.1		
200 E	09.88 - 08.92		31.025.044.000.1		044 005
	09.88 - 08.92		31.006.005.000.1		
220 E	10.92 - 06.93		31.025.044.000.1		044 005
	10.92 - 06.93		31.006.005.000.1		

# Таблица применяемости тормозных шлангов



































































		i	Код Дафми	Дополнительная информация	Тип №
--	--	---	-----------	---------------------------	-------

230 E	12.84 - 06.93 12.84 - 06.93		31.025.044.000.1 31.006.005.000.1		044 005
250 D 250 TD	04.85 - 06.93 04.85 - 06.93		31.025.044.000.1 31.006.005.000.1		044 005
260 E	09.85 - 08.92 09.85 - 08.92		31.025.044.000.1 31.006.005.000.1		044 005
260 E 4-matic	09.86 - 08.92		31.006.005.000.1		005
280 E	10.92 - 06.93 10.92 - 06.93		31.025.044.000.1 31.006.005.000.1		044 005
300 D	12.84 - 06.93 12.84 - 06.93		31.025.044.000.1 31.006.005.000.1		044 005
300 D 4-matic	09.86 - 06.93		31.006.005.000.1		005
300 E	08.85 - 08.92 08.85 - 08.92		31.025.044.000.1 31.006.005.000.1		044 005
300 E 2,4	09.88 - 08.92 09.88 - 08.92		31.025.044.000.1 31.006.005.000.1		044 005
300 E 4-matic	09.86 - 06.93		31.006.005.000.1		005
300 TD	09.86 - 06.93 09.86 - 06.93		31.025.044.000.1 31.006.005.000.1		044 005
300 TD 4-matic	09.86 - 06.93		31.006.005.000.1		005
320 E, 400E	10.92 - 06.93 10.92 - 06.93		31.025.044.000.1 31.006.005.000.1		044 005
500 E	01.91 - 06.93 01.91 - 06.93		31.025.044.000.1 31.006.005.000.1		044 005

## MITSUBISHI

<b>3000 GT(Z16A)</b>					
2.0 Turbo ECi	05.82 - 05.84		31.062.020.000.1		020
<b>Celeste (A7)</b>					
2.0 Turbo ECi	05.82 - 05.84 05.82 - 05.84 05.82 - 05.84		31.066.010.000.1 31.062.020.000.1 31.065.010.000.1	К суппорту	010 020 010
<b>Colt I.(A15 A)</b>					
1,4 GLX, GT	05.79 - 01.84 05.79 - 01.84 05.79 - 01.84		31.062.020.000.1 31.066.010.000.1 31.063.020.000.1	К суппорту	020 010 020
1,2 GL	12.78 - 01.84 12.78 - 01.84 12.78 - 01.84		31.062.020.000.1 31.066.010.000.1 31.063.020.000.1	К суппорту	020 010 020
1,4 Turbo	09.81 - 01.84 09.81 - 01.84 09.81 - 01.84		31.062.020.000.1 31.066.010.000.1 31.063.020.000.1	К суппорту	020 010 020
<b>Colt II.(C1 A)</b>					
All models	02.84 - 04.88 02.84 - 04.88		31.062.020.000.1 31.066.010.000.1	К суппорту	020 010
<b>Colt III.(C5 A)</b>					
All models	04.88 - 05.92 04.88 - 05.92		31.062.020.000.1 31.066.010.000.1	К суппорту	020 010
<b>Cordia (A21_A)</b>					
1,6 GSL	10.82 - 12.86 10.82 - 12.86 10.82 - 12.86		31.062.020.000.1 31.066.010.000.1 31.063.020.000.1	К суппорту	020 010 020
1,6 Turbo	09.82 - 05.85 09.82 - 05.85		31.062.020.000.1 31.063.020.000.1		020 020
1,8 GSL	10.86 - 12.86 10.86 - 12.86 10.86 - 12.86		31.062.020.000.1 31.066.010.000.1 31.063.020.000.1	К суппорту	020 010 020
1,8 Turbo ECi	10.84 - 12.86 10.84 - 12.86 10.84 - 12.86		31.062.020.000.1 31.066.010.000.1 31.063.020.000.1	К суппорту	020 010 020
<b>Eclipse I.(D2_A)</b>					
2.0 i 16V 2.0 i 16V 4x4	04.91 - 11.95 09.80 - 05.84		31.064.010.000.1 31.062.020.000.1		010 020
<b>Galant II.(A16)</b>					
1,6 GLX	09.80 - 05.84 09.80 - 05.84		31.066.010.000.1 31.062.020.000.1	К суппорту	010 020
2,0 GLS	09.80 - 05.84		31.062.020.000.1		020
2,0 Turbo ECi	05.82 - 05.84 05.82 - 05.84 05.82 - 05.84		31.066.010.000.1 31.062.020.000.1 31.065.010.000.1	К суппорту	010 020 010
2,3 TD	09.80 - 05.84		31.062.020.000.1		020











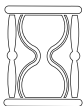











































		i	Код Дафми	Дополнительная информация	Тип №
---	---	---	-----------	---------------------------	-------

Galant III.(E1_A)					
1,6 GLX	06.84 - 12.87		31.062.020.000.1	К суппорту	020
	06.84 - 12.87		31.066.010.000.1		010
	06.84 - 12.87		31.124.020.000.1		020
1,8 TD	06.84 - 12.87		31.062.020.000.1	К суппорту	020
	06.84 - 12.87		31.066.010.000.1		010
	06.84 - 12.87		31.124.020.000.1		020
2,0 GLS	06.84 - 12.87		31.062.020.000.1	К суппорту К суппорту	020
	06.84 - 12.87		31.066.010.000.1		010
	06.84 - 12.87		31.065.010.000.1		010
	06.84 - 12.87		31.124.020.000.1		020
2,0 Turbo ECi	06.84 - 05.85		31.062.020.000.1	К суппорту К суппорту	020
	06.84 - 05.85		31.066.010.000.1		010
	06.84 - 05.85		31.065.010.000.1		010
	06.84 - 05.85		31.124.020.000.1		020
2,3 GLS	07.85 - 12.87		31.062.020.000.1	К суппорту К суппорту	020
	07.85 - 12.87		31.066.010.000.1		010
	07.85 - 12.87		31.065.010.000.1		010
	07.85 - 12.87		31.124.020.000.1		020
Galant IV. Sedan (E3 A)					
1,8	11.87 - 10.92		31.062.020.000.1	К суппорту	020
	11.87 - 10.92		31.066.010.000.1		010
	11.87 » 10.92		31.065.010.000.1		С ABS 010
1,8 TD	12.87 - 10.92		31.062.020.000.1	К суппорту К суппорту	020
	12.87 - 10.92		31.066.010.000.1		010
	12.87 - 10.92		31.065.010.000.1		010
2,0	11.87 - 10.92		31.062.020.000.1	К суппорту К суппорту	020
	11.87 - 10.92		31.066.010.000.1		010
	11.87 - 10.92		31.065.010.000.1		010
2,0 4x4	12.88 - 10.92		31.062.020.000.1	К суппорту К суппорту	020
	12.88 - 10.92		31.064.010.000.1		010
	12.88 - 10.92		31.065.010.000.1		010
2,0 GTI 16V	11.87 - 10.92		31.062.020.000.1	К суппорту К суппорту	020
	11.87 - 10.92		31.066.010.000.1		010
	11.87 - 10.92		31.065.010.000.1		010
2,0 GTI 16V 4x4	06.88 - 10.92		31.062.020.000.1	К суппорту К суппорту	020
	06.88 - 10.92		31.064.010.000.1		010
	06.88 - 10.92		31.065.010.000.1		010
2,0 GTI 16V 4x4 KAT	09.91 - 10.92		31.062.020.000.1	К суппорту К суппорту	020
	09.91 - 10.92		31.066.010.000.1		010
	09.91 - 10.92		31.065.010.000.1		010
Galant IV.(E3_A)					
1,8	11.88 - 10.92		31.062.020.000.1	К суппорту	020
	11.88 - 10.92		31.066.010.000.1		010
	11.88 - 10.92		31.065.010.000.1		С ABS 010
1,8 TD	11.88 - 10.92		31.062.020.000.1	К суппорту	020
	11.88 - 10.92		31.066.010.000.1		010
2,0	04.89 - 10.92		31.062.020.000.1	К суппорту К суппорту	020
	04.89 - 10.92		31.066.010.000.1		010
	04.89 - 10.92		31.065.010.000.1		С ABS 010
2,0 4x4	04.89 - 10.92		31.062.020.000.1	К суппорту	020
	04.89 - 10.92		31.064.010.000.1		010
2,0 GTI 16V	11.88 - 10.92		31.062.020.000.1	К суппорту К суппорту	020
	11.88 - 10.92		31.066.010.000.1		010
	11.88 - 10.92		31.065.010.000.1		010
2,0 GTI 16V 4x4	07.89 - 12.92		31.062.020.000.1	К суппорту К суппорту	020
	07.89 - 12.92		31.064.010.000.1		010
	07.89 - 12.92		31.065.010.000.1		010
L200 (K6_T)					
2,0 2.4 4x4	06.96 -		31.066.010.000.1		010
2,5 D 2.5 TD 4x4	06.96 -		31.066.010.000.1		010
L200 (K_4T)					
2,5 D	11.86 - 08.96		31.062.020.000.1		020
			31.066.010.000.1		010
2,5 D 2.5 TD 4x4	12.87 - 05.93		31.066.010.000.1		010
			31.066.010.000.1		010
L300 box body (L03_P)					
1,6	05.80 - 10.86		31.063.020.000.1		020
			31.125.020.000.1		020
2,3 D	09.83 - 10.86		31.063.020.000.1		020









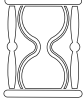

















































# Таблица применяемости тормозных шлангов



		i	Код Дафми	Дополнительная информация	Тип №	
<b>L300 Platform/Chassis (L03_P)</b>						
09.83 - 10.86			31.125.020.000.1		020	
<b>L300 Platform/Chassis (L03_P)</b>						
1,6	04.83 - 04.94		31.063.020.000.1		020	
2,5 D	11.86 - 04.94		31.063.020.000.1		020	
	11.86 - 04.94		31.066.010.000.1		010	
	11.86 - 04.94		31.125.020.000.1		020	
<b>Lancer (A17_)</b>						
All models	09.79 - 02.83		31.066.010.000.1	К суппорту	010	
	09.79 - 02.83		31.062.020.000.1		020	
<b>Lancer FII.(A17_)</b>						
All models	03.83 - 01.84		31.062.020.000.1	К суппорту	020	
	03.83 - 01.84		31.066.010.000.1		010	
	03.83 - 01.84		31.063.020.000.1		020	
<b>Lancer III.(C1_A, C6_A)</b>						
All models	11.83 - 04.88		31.062.020.000.1	К суппорту	020	
	11.83 - 04.88		31.066.010.000.1		010	
<b>Lancer III.S.W.(C1_V,C3_V)</b>						
1,5	09.85 - 12.90		31.062.020.000.1	К суппорту	020	
	09.85 - 12.90		31.066.010.000.1		010	
	09.85 - 12.90		31.063.020.000.1		020	
1,5 12V	09.90 - 12.91		31.062.020.000.1	К суппорту	020	
	09.90 - 12.91		31.066.010.000.1		010	
	09.90 - 12.91		31.063.020.000.1		020	
1,8 4x4	01.87 - 08.89		31.062.020.000.1	К суппорту	020	
	01.87 - 08.89		31.066.010.000.1		010	
	03.89 - 06.92		31.062.020.000.1		020	
	03.89 - 06.92		31.063.020.000.1		020	
1,8 D	08.86 - 06.92		31.062.020.000.1	К суппорту	020	
	08.86 - 06.92		31.066.010.000.1		010	
	08.86 - 06.92		31.063.020.000.1		020	
<b>Lancer IV.(C6_A, C7_A)</b>						
1,5 12V	05.89 - 05.92		31.062.020.000.1	К суппорту	020	
	05.89 - 05.92		31.066.010.000.1		010	
1,8 D	04.88 - 05.92		31.062.020.000.1	К суппорту	020	
	04.88 - 05.92		31.066.010.000.1		010	
1,8 GLXi 4x4	09.89 - 06.92		31.062.020.000.1		020	
	09.89 - 06.92		31.062.020.000.1		020	
1,8 GTi 16V	11.89 - 12.93		31.062.020.000.1	К суппорту	020	
	11.89 - 12.93		31.066.010.000.1		010	
<b>Lancer IV.Sedan (C6_A)</b>						
1,3	04.88 - 05.92		31.062.020.000.1	К суппорту	020	
	04.88 - 05.92		31.066.010.000.1		010	
1,3 12V	01.91 - 06.92		31.066.010.000.1	К суппорту	010	
1,5	04.88 - 05.92		31.062.020.000.1	К суппорту	020	
	04.88 - 05.92		31.066.010.000.1		010	
1,5 12V	05.89 - 05.92		31.062.020.000.1	К суппорту	020	
	05.89 - 05.92		31.066.010.000.1		010	
1,8 GLX D	04.88 - 05.92		31.062.020.000.1	К суппорту	020	
	04.88 - 05.92		31.066.010.000.1		010	
<b>Sapporo II.(A16_A)</b>						
1,6 GLX	06.80 - 09.84		31.066.010.000.1	К суппорту	010	
	06.80 - 09.84		31.062.020.000.1		020	
	06.80 - 09.84		31.065.010.000.1		К суппорту	010
2,0 GSL	08.80 - 08.83		31.062.020.000.1	GL	020	
	08.80 - 08.83		31.065.010.000.1		GLS, GSR	010
2,0 GSR	08.80 - 09.84		31.062.020.000.1	GL	020	
	08.80 - 09.84		31.065.010.000.1		GLS, GSR	010
2,0 Turbo ECi	08.82 - 08.83		31.066.010.000.1	К суппорту	010	
	08.82 - 08.83		31.062.020.000.1		020	
	08.82 - 08.83		31.065.010.000.1		К суппорту	010
<b>Sapporo III.(E16A)</b>						
2,3	06.87 - 08.90		31.062.020.000.1	К суппорту	020	
	06.87 - 08.90		31.066.010.000.1		010	
	06.87 - 08.90		31.066.010.000.1		К суппорту	010
	06.87 - 08.90		31.124.020.000.1		020	
<b>Shogun (L04_G,L14_G)</b>						
2,5 TD	11.89 - 12.91		31.063.020.000.1		020	
3,0 V6	11.88 - 11.90		31.063.020.000.1		020	
<b>Space Runner (N1_W,N2_W)</b>						
All models	10.91 - 08.99		31.066.010.000.1		010	
	10.91 - 08.99		31.063.020.000.1		020	

		i	Код Дафми	Дополнительная информация	Тип №
---	---	---	-----------	---------------------------	-------

<b>Space Wagon (DO_W)</b>					
1,8 4x4	10.87 - 08.88		31.062.020.000.1	К суппорту	020
	10.87 - 08.88		31.066.010.000.1		010
	10.87 - 08.88		31.063.020.000.1		020
1,8 GLX	01.84 - 12.88		31.062.020.000.1	К суппорту	020
	01.84 - 12.88		31.066.010.000.1		010
	01.84 - 12.88		31.063.020.000.1		020
1,8 TD	06.86 - 04.91		31.062.020.000.1	К суппорту	020
	06.86 - 04.91		31.066.010.000.1		010
	06.86 - 04.91		31.063.020.000.1		020
2,0 4x4	03.85 - 04.91		31.062.020.000.1		020
2,0 GLX	06.86 - 05.88		31.062.020.000.1	К суппорту	020
	06.86 - 05.88		31.066.010.000.1		010
	06.86 - 05.88		31.063.020.000.1		020
2,0 GLX 4x4	06.86 - 05.88		31.062.020.000.1		020
2,0 GLX i	06.88 - 04.91		31.062.020.000.1	On саипер	020
	06.88 - 04.91		31.066.010.000.1		010
	06.88 - 04.91		31.063.020.000.1		020
2,0 GLX i 4X4	06.88 - 04.91		31.062.020.000.1		020
<b>Space Wagon (N3_W, N4_W)</b>					
All models	10.91 - 10.98		31.066.010.000.1		010
	10.91 - 10.98		31.063.020.000.1		020
<b>Starion (A18_A)</b>					
2,0 Turbo ECi	06.82 - 08.87		31.066.010.000.1	К суппорту	010
	06.82 - 08.87		31.063.020.000.1		020
	06.82 - 08.87		31.065.010.000.1	К суппорту	010
2,5 Turbo ECi	09.87 - 06.90		31.066.010.000.1	К суппорту	010
	09.87 - 06.90		31.063.020.000.1		020
<b>Tredia(A21_)</b>					
1,4 GLX	10.82 - 08.85		31.066.010.000.1	К суппорту	010
	10.82 - 08.85		31.063.020.000.1		020
1,6 GLS	09.82 - 10.87		31.066.010.000.1	К суппорту	010
	09.82 - 10.87		31.063.020.000.1		020
1,6 Turbo	09.82 - 05.85		31.062.020.000.1		020
1,8 GLS	08.84 - 07.86		31.066.010.000.1	К суппорту	010
	08.84 - 07.86		31.063.020.000.1		020
1,8 Turbo	08.84 - 07.86		31.062.020.000.1		020
<b>NISSAN</b>					
<b>Bluebird (U11)</b>					
1,8	11.83 - 06.88		31.031.023.000.1		023
1,8 Turbo	04.84 - 05.90		31.031.023.000.1	Свертись с чертежем !	023
	04.84 - 00.86		31.032.024.000.1		024
2,0 D	04.84 - 01.88		31.031.023.000.1		023
2,0 i	04.84 - 01.88		31.031.023.000.1		023
<b>Bluebird Station Wagon (WU11)</b>					
2	04.86 - 12.87		31.031.023.000.1		023
2,0 D	04.84 - 12.90		31.031.023.000.1		023
2,0 i	04.84 - 12.90		31.031.023.000.1		023
<b>Cherry (N12)</b>					
All models	05.82 - 12.86		31.030.024.000.1		024
	05.82 - 12.86		31.002.019.000.1		019
<b>Laurel Six (C230)</b>					
	00.77 - 00.81		31.002.019.000.1		019
<b>Maxima (J30)</b>					
3,0 i	10.88 - 06.94		31.031.023.000.1		023
	10.88 - 06.94		31.031.023.000.1		023
<b>Praire (M10, NM10)</b>					
1,5 S	01.84 - 12.87		31.030.024.000.1		024
1,8 SQL	07.83 - 10.87		31.030.024.000.1		024
<b>Primera (P10)</b>					
All models	06.90 - 01.96		31.169.053.000.1		053
	06.90 - 01.96		31.170.053.000.1		053
<b>Sunny (B11)</b>					
1,3	03.82 - 09.87		31.030.024.000.1		024
	03.82 - 09.87		31.002.019.000.1		019
1,5	03.82 * 10.86		31.030.024.000.1		024
	03.82 - 10.86		31.002.019.000.1		019
1,7 D	0&82 - 10.86		31.030.024.000.1		024
	03.82 - 10.86		31.002.019.000.1		019





























































# Таблица применяемости тормозных шлангов



		i	Код Дафми	Дополнительная информация	Тип №
---	---	---	-----------	---------------------------	-------

Sunny II. (N13)					
1,3	07.86 - 10.91	↗	31.151.048.000.1		048
1,4 LX	10.88 - 08.91	↗	31.151.048.000.1		048
1,5	06.86 - 10.88	↗	31.151.048.000.1		048
1,6	06.86 - 10.88	↗	31.151.048.000.1		048
1,6 GTI 16V	02.87 - 10.88	↗	31.151.048.000.1		048
1,6 i	06.86 - 10.90	↗	31.151.048.000.1		048
1,6 i 12V	10.88 - 06.91	↗	31.151.048.000.1		048
1,6 i 4x4 (A)	06.86 - 10.90	↗	31.151.048.000.1		048
1,7	06.86 - 05.89	↗	31.151.048.000.1		048
Sunny II. Coupe (B12)					
1,5	06.86 - 10.88	↗	31.151.048.000.1		048
1,6	08.86 - 10.88	↗	31.151.048.000.1		048
1,6 GTI 16V	05.87 - 05.89	↗	31.151.048.000.1		048
1,6 i	08.86 - 05.89	↗	31.151.048.000.1		048
1,6 i 12V	10.88 - 06.91	↗	31.151.048.000.1		048
1,8 GTI 16V	01.89 - 06.91	↗	31.151.048.000.1		048
Sunny II. Traveller (B12)					
1,5	06.86 - 10.88	↗	31.151.048.000.1		048
1,6	06.86 - 10.88	↗	31.151.048.000.1		048
1,6 i	08.86 - 05.89	↗	31.151.048.000.1		048
1,6 i 12V	10.88 - 06.91	↗	31.151.048.000.1		048
1,6 i 4x4 (A)	06.86 - 05.89	↗	31.151.048.000.1		048
1,7	10.88 - 06.91	↗	31.151.048.000.1		048
OPEL					
Arena					
All models	03.98 - 08.01	↓	31.184.013.000.1		013
Ascona B					
All models	09.75 - 08.81	↓	31.140.018.000.1		018
Ascona C,CC					
1,3 N, S	09.81 - 08.88	↗	31.027.033.000.1		033
	09.81 - 08.88	↘	31.028.018.000.1	-Шасси G1001771   -Шасси G6000000	018
	09.81 - 08.88	↘	31.092.018.000.1	Шасси G1001772-   Шасси G6000001-	018
1,6	09.81 - 08.88	↗	31.027.033.000.1	-Шасси G1000071   -Шасси G6000000	033
	09.81 - 08.88	↗	31.091.033.000.1	Шасси G1000072-   Шасси G6000001-	033
	09.81 - 08.88	↘	31.028.018.000.1	-Шасси G1000071   -Шасси G6000000	018
	09.81 - 08.88	↘	31.092.018.000.1	Шасси G1000072-   Шасси G6000001-	018
1,6 i 1,8 E, i	09.87 -	↗	31.027.033.000.1	-Шасси G1000071   -Шасси G6000000	033
	09.87 -	↗	31.091.033.000.1	Шасси G1000072-   Шасси G6000001-	033
	09.87 -	↘	31.028.018.000.1	-Шасси G1000071   -Шасси G6000000	018
	09.87 -	↘	31.092.018.000.1	Шасси G1000072-   Шасси G6000001-	018
1,8 E, i 1,6 D	03.82 -	↗	31.027.033.000.1	-Шасси G1000071   -Шасси G6000000	033
	03.82 -	↗	31.091.033.000.1	Шасси G1000072-   Шасси G6000001-	033
	03.82 -	↘	31.028.018.000.1	-Шасси G1000071   -Шасси G6000000	018
	03.82 -	↘	31.092.018.000.1	Шасси G1000072-   Шасси G6000001-	018
2,0 i 2,0 i KAT 2,0 i GT	09.86 - 08.88	↗	31.027.033.000.1	-Шасси G1000071   -Шасси G6000000	033
	09.86 - 08.88	↗	31.091.033.000.1	Шасси G1000072-   Шасси G6000001-	033
	09.86 - 08.88	↘	31.028.018.000.1	-Шасси G1000071   -Шасси G6000000	018
	09.86 - 08.88	↘	31.092.018.000.1	Шасси G1000072-   Шасси G6000001-	018
Astra F box (55_)					
All models	10.91 - 01.99	↗	31.091.033.000.1		033
	10.91 - 01.99	↘	31.192.018.000.1		018
Astra F Classic Hatchback					
All models	01.98 -	↗	31.091.033.000.1		033
	01.98 -	↘	31.168.052.000.1		052
Astra F Convertible/roadster					
All models	01.96 -	↗	31.091.033.000.1		033
	01.96 -	↘	31.168.052.000.1		052
Astra F,CC					
All models	09.91 - 09.98	↗	31.091.033.000.1		033
	09.91 - 09.98	↘	31.092.018.000.1	Break, VAN	018
	09.91 - 09.98	↘	31.168.052.000.1		052
Astra G(F69),(F35),(F48_ ;F08_)					
All models	09.98 -	↗	31.194.055.000.1		055
	09.98 -	↘	31.195.056.000.1	Дисковый тормоз	056
Astra G Box (F70)					
1,6 1,7 TD 2,0 DI	01.99 -	↗	31.194.055.000.1		055
Astra G Coupe (F07_)					
All models	09.00 -	↗	31.194.055.000.1		055
	09.98 -	↘	31.195.056.000.1		056

		i	Код Дафми	Дополнительная информация	Тип №
---	---	---	-----------	---------------------------	-------

Calibra A					
2,0 i 16V 4x4	06.90 - 07.97		31.091.033.000.1	Шасси L1000001-1 - Шасси N1999999 Шасси P1000001-1 - Шасси P9999999	033
	06.90 - 07.97		31.092.018.000.1		018
	06.90 - 07.97		31.168.052.000.1		052
2,0 i 2,0 i 4x4 2,0 i 16V	06.90 - 07.97		31.091.033.000.1	Шасси L1000001-1 - Шасси N1999999 Шасси P1000001-1 - Шасси P9999999	033
	06.90 - 07.97		31.092.018.000.1		018
	06.90 - 07.97		31.168.052.000.1		052
2,0 i Turbo 4x4	03.92 - 07.97		31.091.033.000.1	Шасси L1000001-1 - Шасси N1999999 Шасси P1000001-1 - Шасси P9999999	033
	03.92 - 07.97		31.092.018.000.1		018
	03.92 - 07.97		31.168.052.000.1		052
2,5 i V6	04.93 - 07.97		31.091.033.000.1	Шасси L1000001-1 - Шасси N1999999 Шасси P1000001-1 - Шасси P9999999	033
	04.93 - 07.97		31.092.018.000.1		018
	04.93 - 07.97		31.168.052.000.1		052
Commodore C					
2,5 S 2,5 E	- 12.82		31.017.018.000.1		018
Corsa A					
1,0 1,2 S 1,3 S	09.82 - 10.87		31.067.033.000.1	-Шасси G4000000 -Шасси G4000000 Шасси G4000001-	033
	09.82 - 10.87		31.028.018.000.1		018
	09.82 - 10.87		31.092.018.000.1		018
1,2 N 1,3	- 10.97		31.067.033.000.1	-Шасси G4000000 -Шасси G4000000 Шасси G4000001-	033
	- 10.97		31.028.018.000.1		018
	- 10.97		31.092.018.000.1		018
1,5 D	09.87 - 09.89		31.067.033.000.1	-Шасси G4000000 -Шасси G4000000 Шасси G4000001-	033
	09.87 - 09.89		31.028.018.000.1		018
	09.87 - 09.89		31.092.018.000.1		018
Corsa A box body					
1,0 1,2 1,3	02.86 - 04.89		31.067.033.000.1	-Шасси G4000000 -Шасси G4000000 Шасси G4000001-	033
	02.86 - 04.89		31.028.018.000.1		018
	02.86 - 04.89		31.092.018.000.1		018
1,5 D	06.87 - 04.89		31.092.018.000.1		018
Corsa A, CC					
1,0 1,2 S 1,3 S	09.82 -		31.067.033.000.1	-Шасси G4000000 -Шасси G4000000 -Шасси G4000001-	033
	09.82 -		31.028.018.000.1		018
	09.82 -		31.092.018.000.1		018
1,2	01.86 - 10.89		31.067.033.000.1	-Шасси G4000000 -Шасси G4000000 -Шасси G4000001-	033
	01.85 - 10.89		31.028.018.000.1		018
	01.85 - 10.89		31.092.018.000.1		018
1,2 i 1,3 i	09.89 - 03.93		31.067.033.000.1	-Шасси G4000000 -Шасси G4000001 Шасси G4000001-	033
	09.89 - 03.93		31.028.018.000.1		018
	09.89 - 03.93		31.092.018.000.1		018
1,2 N 1,4 i 1,4 S	01.90 - 03.93		31.067.033.000.1	-Шасси G4000000 -Шасси G4000000 Шасси G4000001-	033
	01.90 - 03.93		31.028.018.000.1		018
	01.90 - 03.93		31.092.018.000.1		018
1,3	09.85 - 10.89		31.067.033.000.1	-Шасси G4000000 -Шасси G4000000 Шасси G4000001-	033
	09.85 - 10.89		31.028.018.000.1		018
	09.85 - 10.89		31.092.018.000.1		018
1,4 Si	09.91 - 03.93		31.067.033.000.1	-Шасси G4000000 -Шасси G4000000 Шасси G4000001-	033
	09.91 - 03.93		31.028.018.000.1		018
	09.91 - 03.93		31.092.018.000.1		018
1,5 D	09.87 - 03.93		31.067.033.000.1	-Шасси G4000000 -Шасси G4000000 Шасси G4000001-	033
	09.87 - 03.93		31.028.018.000.1		018
	09.87 - 03.93		31.092.018.000.1		018
1,6 GSI	05.88 - 03.93		31.067.033.000.1	-Шасси G4000000 -Шасси G4000000 Шасси G4000001-	033
	05.88 - 03.93		31.028.018.000.1		018
	05.88 - 03.93		31.092.018.000.1		018
Corsa B					
1,0 i 12V	11.96 -		31.092.018.000.1		018
1,2 i 1,4 i 1,4 Si 1,6 i 16V	03.93 -		31.092.018.000.1		018
1,4 i 16V	09.94 -		31.092.018.000.1		018
1,6 GSI 16V 1,5 D 1,5 TD	03.93 -		31.092.018.000.1		018
1,7 D	02.96 -		31.092.018.000.1		018
Corsa B box body					
1,4 i 1,7 D	08.99 -		31.092.018.000.1		018
Corsa C(F08, F68)					
1,0 12V 1,6 16V	09.00 -		31.092.018.000.1		018
1,4 16V 1,8 16V	09.00 -		31.092.018.000.1		018
1,7 DI 16V 1,7 DTI 16V	09.00 -		31.092.018.000.1		018
Frontera					
	00.91 -		31.149.046.000.1		046
Kadett C					
1,0	01.74 - 07.76		31.140.018.000.1		018

# Таблица применяемости тормозных шлангов



		i	Код Дафми	Дополнительная информация	Тип №
--	--	---	-----------	---------------------------	-------











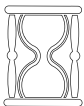

















































1,2	08.73 - 07.76	↓	31.140.018.000.1		018
1,6 S	08.73 - 07.79	↓	31.140.018.000.1		018
<b>Kadett D</b>					
1,2 1,3 N 1,3 S	08.79 - 08.84	↗	31.027.033.000.1	Шасси D2500064   Шасси D5000001-	033
	08.79 - 08.84	↗	31.029.034.000.1	-Шасси D2500063   -Шасси D5000000	034
	08.79 - 08.84	↘	31.028.018.000.1		018
1,6 D	03.82 - 08.84	↗	31.027.033.000.1		033
	03.82 - 08.84	↘	31.028.018.000.1		018
1,6 S	09.81 - 08.84	↗	31.027.033.000.1	Шасси D2500064   Шасси D5000001-	033
	09.81 - 08.84	↗	31.029.034.000.1	-Шасси D2500063   -Шасси D5000000	034
	09.81 - 08.84	↘	31.028.018.000.1		018
1,8 GT 1,8 E	02.83 - 08.84	↗	31.027.033.000.1		033
	02.83 - 08.84	↘	31.028.018.000.1		018
<b>Kadett D Caravan</b>					
1,2 1,2 S 1,3 N 1,3 S	08.79 - 08.84	↗	31.027.033.000.1	Шасси D2500064   Шасси D5000001-	033
	08.79 - 08.84	↗	31.029.034.000.1	-Шасси D2500063   -Шасси D5000000	034
	08.79 - 08.84	↘	31.028.018.000.1		018
1,6 D	03.82 - 08.84	↗	31.027.033.000.1		033
	03.82 - 08.84	↘	31.028.018.000.1		018
1,6 S	09.81 - 08.84	↗	31.027.033.000.1	Шасси D2500064   Шасси D5000001-	033
	09.81 - 08.84	↗	31.029.034.000.1	-Шасси D2500063   -Шасси D5000000	034
	09.81 - 08.84	↘	31.028.018.000.1		018
<b>Kadett E box body</b>					
1,2 1,3 N 1,8 i 1,6 D	08.84 -	↗	31.027.033.000.1	-Шасси G2502696   -Шасси G5000000	033
	08.84 -	↗	31.089.035.000.1	-Шасси G2502696   -Шасси G5000000	035
	08.84 -	↗	31.090.035.000.1		035
	08.84 -	↗	31.091.033.000.1		033
	08.84 -	↘	31.028.018.000.1	-Шасси G2502696   -Шасси G5000000	018
	08.84 -	↘	31.092.018.000.1		018
1,4 i	01.90 - 08.91	↗	31.090.035.000.1		035
	01.90 - 08.91	↗	31.091.033.000.1		033
	01.90 - 08.91	↘	31.092.018.000.1		018
1,6 i	08.69 - 09.93	↗	31.027.033.000.1	-Шасси G2502696   -Шасси G5000000	033
	08.89 - 09.93	↗	31.089.035.000.1	-Шасси G2502696   -Шасси G5000000	035
	08.89 - 09.93	↗	31.090.035.000.1		035
	08.89 - 09.93	↗	31.091.033.000.1		033
	08.89 - 09.93	↘	31.028.018.000.1	-Шасси G2502696   -Шасси G5000000	018
	08.89 - 09.93	↘	31.092.018.000.1		018
1,7 D	08.88 - 09.92	↗	31.090.035.000.1		035
	08.88 - 09.92	↗	31.091.033.000.1		033
	08.88 - 09.92	↘	31.092.018.000.1		018
<b>Kadett E Combo</b>					
1,3 N 1,3 S 1,6 1,6 D	01.86 -	↗	31.027.033.000.1	-Шасси G2502696   -Шасси G5000000	033
	01.86 -	↗	31.089.035.000.1	-Шасси G2502696   -Шасси G5000000	035
	01.86 -	↗	31.090.035.000.1		035
	01.86 -	↗	31.091.033.000.1		033
	01.86 -	↘	31.028.018.000.1	-Шасси G2502696   -Шасси G5000000	018
	01.86 -	↘	31.092.018.000.1		018
1,4 i 1,6 i	08.91 - 04.97	↗	31.027.033.000.1		033
	08.91 - 04.97	↗	31.090.035.000.1		035
	08.91 - 04.97	↘	31.092.018.000.1		018
1,4 S 1,7 D	01.89 -	↗	31.090.035.000.1		035
	01.89 -	↗	31.091.033.000.1		033
	01.89 -	↘	31.092.018.000.1		018
<b>Kadett E Convertible/roadster</b>					
1,3 S	03.87 - 02.93	↗	31.027.033.000.1	-Шасси G2502696   -Шасси G5000000	033
	03.87 - 02.93	↗	31.089.035.000.1	-Шасси G2502696   -Шасси G5000000	035
	03.87 - 02.93	↗	31.090.035.000.1		035
	03.87 - 02.93	↗	31.091.033.000.1		033
	03.87 - 02.93	↘	31.028.018.000.1	-Шасси G2502696	018
	03.87 - 02.93	↘	31.092.018.000.1		018
1,4 i	01.90 - 08.91	↗	31.090.035.000.1		035
	01.90 - 08.91	↗	31.091.033.000.1		033
	01.90 - 08.91	↘	31.092.018.000.1		018
1,6 i, KAT 2,0 i, KAT	10.86 - 02.93	↗	31.027.033.000.1	-Шасси G2502696   -Шасси G5000000	033
	10.86 - 02.93	↗	31.089.035.000.1	-Шасси G2502696   -Шасси G5000000	035
	10.86 - 02.93	↗	31.090.035.000.1		035
	10.86 - 02.93	↗	31.091.033.000.1		033
	10.86 - 02.93	↘	31.028.018.000.1	-Шасси G2502696   -Шасси G5000000	018
	10.86 - 02.93	↘	31.092.018.000.1		018

		i	Код Дафми	Дополнительная информация	Тип №
---	---	---	-----------	---------------------------	-------

Kadett E, CC					
1,2 1,3 N 1,3 S 1,6 S 1,8 GSI	09.84 -	↗	31.027.033.000.1	-Шасси G2502696   -Шасси G5000000	033
	09.84 -	↖	31.089.035.000.1		-Шасси G2502696   -Шасси G5000000
	09.84 -	↗	31.090.035.000.1		035
	09.84 -	↖	31.091.033.000.1		033
	09.84 -	↗↘	31.028.018.000.1	-Шасси G2502696   -Шасси G5000000	018
1,3 i KAT 1,8 i 1,8 E	06.85 -	↗	31.027.033.000.1	-Шасси G2502696   -Шасси G5000000	033
	06.85 -	↖	31.089.035.000.1		-Шасси G2502696   -Шасси G5000000
	06.85 -	↗	31.090.035.000.1		035
	06.85 -	↖	31.091.033.000.1		033
	06.85 -	↗↘	31.028.018.000.1	-Шасси G2502696   -Шасси G5000000	018
1,4 i	01.90 - 08.91	↗	31.090.035.000.1		035
	01.90 - 08.91	↖	31.091.033.000.1		033
	01.90 - 08.91	↗↘	31.092.018.000.1		018
1,5 TD	07.88 - 08.91	↗	31.090.035.000.1		035
	07.88 - 08.91	↖	31.091.033.000.1		033
	07.88 - 08.91	↗↘	31.092.018.000.1		018
1,6 D	09.84 - 01.89	↗	31.027.033.000.1	-Шасси G2502696   -Шасси G5000000	033
	09.84 - 01.89	↖	31.089.035.000.1		-Шасси G2502696   -Шасси G5000000
	09.84 - 01.89	↗	31.090.035.000.1		035
	09.84 - 01.89	↖	31.091.033.000.1		033
	09.84 - 01.89	↗↘	31.028.018.000.1	-Шасси G2502696   -Шасси G5000000	018
1,6 i 1,6 i KAT 2,0 GSI, KAT	09.86 - 08.91	↗	31.027.033.000.1	-Шасси G2502696   -Шасси G5000000	033
	09.86 - 08.91	↖	31.089.035.000.1		-Шасси G2502696   -Шасси G5000000
	09.86 - 08.91	↗	31.090.035.000.1		035
	09.86 - 08.91	↖	31.091.033.000.1		033
	09.86 - 08.91	↗↘	31.028.018.000.1	-Шасси G2502696   -Шасси G5000000	018
1,7	02.89 - 08.91	↗	31.090.035.000.1		035
	02.89 - 08.91	↖	31.091.033.000.1		033
	02.89 - 08.91	↗↘	31.092.018.000.1		018
1,8 S	09.87 - 08.91	↗	31.027.033.000.1	-Шасси G2502696   -Шасси G5000000	033
	09.87 - 08.91	↖	31.089.035.000.1		-Шасси G2502696   -Шасси G5000000
	09.87 - 08.91	↗	31.090.035.000.1		035
	09.87 - 08.91	↖	31.091.033.000.1		033
	09.87 - 08.91	↗↘	31.028.018.000.1	-Шасси G2502696   -Шасси G5000000	018
	09.87 - 08.91	↗↘	31.092.018.000.1		018
2,0 GSI 16V 2,0 GSI 16V KAT	03.88 - 08.91	↗	31.027.033.000.1	-Шасси G2502696   -Шасси G5000000	033
	03.88 - 08.91	↖	31.089.035.000.1		-Шасси G2502696   -Шасси G5000000
	03.88 - 08.91	↗	31.090.035.000.1		035
	03.88 - 08.91	↖	31.091.033.000.1		033
	03.88 - 08.91	↗↘	31.028.018.000.1	-Шасси G2502696   -Шасси G5000000	018
	03.88 - 08.91	↗↘	31.092.018.000.1		018
Monza A					
2,0 E	03.83 - 10.84	↗↘	31.017.018.000.1		018
2,2 E	11.84 - 08.86	↗↘	31.017.018.000.1		018
2,5 E	05.81 - 08.86	↗↘	31.017.018.000.1		018
2,8	02.78 - 04.81	↗↘	31.017.018.000.1		018
3,0 3,0 GSE	02.78 -	↗↘	31.017.018.000.1		018
Omega A					
1,8 N,S 2,0 2,0 I	09.86 - 03.94	↗↘	31.023.036.000.1		036
	09.86 - 03.94	↗↘	31.092.018.000.1		018
2,3 D 2,3 TD	10.86 -	↗↘	31.023.036.000.2		036
	10.86 -	↗↘	31.092.018.000.2		018
2,4 i 2,3 TD Interc.	08.88 - 03.94	↗↘	31.023.036.000.1		036
	08.88 - 03.94	↗↘	31.092.018.000.2		018
2,6 i 3,6 24V	08.90 -	↗↘	31.023.036.000.1		036
	08.90 -	↗↘	31.091.033.000.1		018
3,0	03.87 - 09.90	↗↘	31.023.036.000.1		036
	03.87 - 09.90	↗↘	31.092.018.000.1		018
3,0 24V	09.89 - 03.94	↗↘	31.023.036.000.1		036
	09.89 - 03.94	↗↘	31.092.018.000.1		018
3,0 KAT	03.88 - 03.94	↗↘	31.023.036.000.1		036
	03.88 - 03.94	↗↘	31.092.018.000.1		018
Omega B					
2,0 DTI 16V	09.97 -	↗↘	31.092.018.000.1		018
2,0 i 2,0 i 16V 2,5 i V6	03.94 -	↗↘	31.092.018.000.1		018
2,2 i	09.99 -	↗↘	31.092.018.000.1		018

# Таблица применяемости тормозных шлангов



		i	Код Дафми	Дополнительная информация	Тип №
3,0 i V6 2,5 TD	09.94 -		31.092.018.000.1		018
<b>Rekord E</b>					
1,7	09.77 - . 1.0.82.		31.017.018.000.1	Неподвижная скоба	018
1,8 E	05.85 - 08.86		31.017.018.000.1	Неподвижная скоба	018
1,8 1,8 S	11.82 - 08.86		31.017.018.000.1	Неподвижная скоба	018
1,9 2,0 2,0 S 2,0 E	09.77 -		31.017.018.000.1	Неподвижная скоба	018
2,0 D 2,1 D	09.77 -		31.017.018.000.1	Неподвижная скоба	018
2,2 D	08.78 - 08.86		31.017.018.000.1	Неподвижная скоба	018
2,2 E 2,2 TD	06.84 - 08.86		31.017.018.000.1	Неподвижная скоба	018
<b>Senator A</b>					
2,0 E, 2,5 E,	01.83 -		31.017.018.000.1	-Шасси E1019585	018
2,2 E, 2,2 TD	11.84 - 08.87		31.017.018.000.1		018
2,5, 2,8, 3,0, 3,0 E	02.78 -		31.017.018.000.1	-Шасси E1019585	018
<b>Senator B</b>					
2,5 i 2,6 i	09.90 - 09.93 09.90 - 09.93	 	31.023.036.000.1 31.092.018.000.1		036 018
3,0 24V	09.89 - 09.93 09.89 - 09.93	 	31.023.036.000.1 31.092.018.000.1		036 018
3,0 3,0 i KAT	09.87 - 09.93 09.87 - 09.93	 	31.023.036.000.1 31.092.018.000.1		036 018
<b>Tigra</b>					
1,4 16V 1,6 16V	07.94 -		31.092.018.000.1		018
<b>Vectra A</b>					
1,4	04.88 - 06.92 04.88 - 06.92	 	31.091.033.000.1 31.092.018.000.1		033 018
1,6 1,6 i 1,6 i KAT 1,8 S	08.92 - 09.88 - 09.88 - 07.92	  	31.168.052.000.1 31.091.033.000.1 31.092.018.000.1		052 033 018
1,7	08.92 - 11.95 10.88 - 11.95 10.88 - 07.92	  	31.168.052.000.1 31.091.033.000.1 31.092.018.000.1		052 033 018
1,7 TD	03.90 - 11.95 03.90 - 07.92 08.92 - 11.95	  	31.091.033.000.1 31.092.018.000.1 31.168.052.000.1		033 018 052
1,8 S 4x4 2,0 i 4x4	01.89 - 01.89 - 07.92 08.92 -	  	31.091.033.000.1 31.092.018.000.1 31.168.052.000.1		033 018 052
2,0 i 16V 4x4 KAT	02.90 - 11.95 02.90 - 07.92 08.92 - 11.95	  	31.091.033.000.1 31.092.018.000.1 31.168.052.000.1		033 018 052
2,0 i 16V KAT 1,8 i KAT	02.90 - 11.95 02.90 - 07.92 08.92 - 11.95	  	31.091.033.000.1 31.092.018.000.1 31.168.052.000.1		033 018 052
2,0 i 16V, 2,0 i 16V 4x4	01.89 - 11.95 01.89 - 07.92 08.92 - . 11.95	  	31.091.033.000.1 31.092.018.000.1 31.168.052.000.1		033 018 052
2,0 i Turbo 4x4	06.94 - 11.95 06.94 - 11.95	 	31.091.033.000.1 31.168.052.000.1		033 052
2,0 2,0 i 2,0 i KAT	08.92 - 09.88 - 09.88 - 07.92	  	31.168.052.000.1 31.091.033.000.1 31.092.018.000.1		052 033 018
2,5 V6	02.93 - 11.95 02.93 - 11.95	 	31.091.033.000.1 31.168.052.000.1		033 052
<b>Vectra A, CC</b>					
1,4 2,0	04.88 - 04.88 -	 	31.091.033.000.1 31.092.018.000.1		033 018
1,6 i 1,6 S 1,8 S 1,8 i	08.92 - 09.88 - 09.88 - 07.92	  	31.168.052.000.1 31.091.033.000.1 31.092.018.000.1		052 033 018
1,8 i KAT 2,0 i 16V KAT 1,7 TD	02.90 - 11.95 02.90 - 07.92 08.92 - 11.95	  	31.091.033.000.1 31.092.018.000.1 31.168.052.000.1		033 018 052
2,0 i 16V	02.89 - 11.95 02.89 - 07.92 08.92 - 11.95	  	31.092.018.000.1 31.092.018.000.1 31.168.052.000.1		018 018 052
2,0 i 2,0 i KAT 2,0 i GT 1,7 D	08.92 - 09.88 - 09.88 - 07.92	  	31.168.052.000.1 31.091.033.000.1 31.092.018.000.1		052 033 018
2,5 V6	02.93 - 11.95		31.091.033.000.1		033

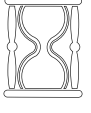







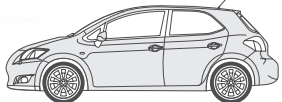

















































		i	Код Дафми	Дополнительная информация	Тип №
	02.93 - 11.95	↗↘	31.168.052.000.1		052
<b>Vectra B Caravan</b>					
All models	11.96 - 11.96	↗↘	31.216.060.000.1		060
		↘↗	31.199.018.000.1		018
<b>Vectra B, CC</b>					
All models	10.95 - 10.95	↗↘	31.216.060.000.1		060
		↘↗	31.199.018.000.1		018
<b>PEUGEOT</b>					
<b>205 (741 A/C)</b>					
All models	02.83 - 10.87	↗↘	31.084.007.000.1	С пружинной	007
	02.83 - 10.87	↗↘	31.086.007.000.1	К суппорту	007
	02.83 - 10.87	↘↗	31.088.018.000.1		018
	02.83 - 10.87	↘	31.004.018.000.1		018
<b>205 box body</b>					
1.7 D	09.83 - 09.83	↗↘	31.084.007.000.1	Армированный шланг	007
	09.83 - 03.94	↗↘	31.086.007.000.1		007
	09.83 - 03.94	↘↗	31.088.018.000.1		018
	09.83 - 03.94	↘	31.004.018.000.1		018
	03.94 -	↘↗	31.084.007.000.1		007
<b>205 Convertible/roadster (741B, 20D)</b>					
1,1 CJ	10.89 - 12.94	↗↘	31.084.007.000.1	Армированный шланг	007
	10.89 - 12.94	↗↘	31.086.007.000.1		007
	10.89 - 12.94	↘↗	31.088.018.000.1		018
	09.83 - 03.94	↘	31.004.018.000.1		018
	03.88 - 05.94	↗↘	31.084.007.000.1		007
1,4 CJ	03.88 - 05.94	↗↘	31.086.007.000.1	Армированный шланг	007
	03.88 - 05.94	↗↘	31.086.007.000.1		007
	03.88 - 05.94	↘↗	31.088.018.000.1		018
	09.83 - 03.94	↘	31.004.018.000.1		018
	03.88 - 05.94	↗↘	31.084.007.000.1		007
1,4 CT	03.88 - 05.94	↗↘	31.086.007.000.1	Армированный шланг	007
	03.88 - 05.94	↗↘	31.086.007.000.1		007
	03.88 - 05.94	↘↗	31.088.018.000.1		018
	09.83 - 03.94	↘	31.004.018.000.1		018
	03.88 - 05.94	↗↘	31.084.007.000.1		007
1,6 CJ	08.92 - 12.94	↗↘	31.084.007.000.1	Армированный шланг	007
	08.92 - 12.94	↗↘	31.086.007.000.1		007
	08.92 - 12.94	↘↗	31.088.018.000.1		018
	09.83 - 03.94	↘	31.004.018.000.1		018
	04.86 - 10.90	↗↘	31.084.007.000.1		007
1,6 CTI	04.86 - 10.90	↗↘	31.086.007.000.1	Армированный шланг	007
	04.86 - 10.90	↗↘	31.086.007.000.1		007
	04.86 - 10.90	↘↗	31.088.018.000.1		018
	09.83 - 03.94	↘	31.004.018.000.1		018
	10.87 - 12.94	↗↘	31.084.007.000.1		007
1,9 CTI	10.87 - 12.94	↗↘	31.086.007.000.1	Армированный шланг	007
	10.87 - 12.94	↗↘	31.086.007.000.1		007
	10.87 - 12.94	↘↗	31.087.008.000.1		008
	10.87 - 12.94	↘	31.087.008.000.1		008
	10.87 - 12.94	↘↗	31.087.008.000.1		008
<b>205 II.(20 A/C)</b>					
1,0 1,1 1,4 1,6 1,9 D	10.87 - 09.98	↗↘	31.084.007.000.1	Армированный шланг	007
	10.87 - 09.98	↗↘	31.086.007.000.1		007
	10.87 - 09.98	↘↗	31.088.018.000.1		018
	09.83 - 03.94	↘	31.004.018.000.1		018
	10.87 - 12.89	↗↘	31.084.007.000.1		007
1,6 GTI	10.87 - 12.89	↗↘	31.086.007.000.1	Армированный шланг	007
	10.87 - 12.89	↗↘	31.086.007.000.1		007
	10.87 - 12.89	↘↗	31.088.018.000.1		018
	09.83 - 03.94	↘	31.004.018.000.1		018
	07.87 - 12.89	↗↘	31.084.007.000.1		007
1,7 D	07.87 - 12.89	↗↘	31.086.007.000.1	Армированный шланг	007
	07.87 - 12.89	↗↘	31.086.007.000.1		007
	07.87 - 12.89	↘↗	31.088.018.000.1		018
	09.83 - 03.94	↘	31.004.018.000.1		018
	01.90 - 09.98	↗↘	31.084.007.000.1		007
1,7 TD	01.90 - 09.98	↗↘	31.086.007.000.1	Армированный шланг	007
	01.90 - 09.98	↗↘	31.086.007.000.1		007
	01.90 - 09.98	↘↗	31.088.018.000.1		018
	09.83 - 03.94	↘	31.004.018.000.1		018
	10.87 - 09.98	↗↘	31.084.007.000.1		007
1,9 GTI	10.87 - 09.98	↗↘	31.086.007.000.1	Армированный шланг	007
	10.87 - 09.98	↗↘	31.086.007.000.1		007
	10.87 - 09.98	↘↗	31.088.018.000.1		018
	10.87 - 09.98	↘	31.088.018.000.1		018
	10.85 - 07.89	↗↘	31.085.008.000.1		008
309 (10C, 10A)	10.85 - 07.89	↗↘	31.086.007.000.1	Армированный шланг	007
All models	10.85 - 07.89	↗↘	31.086.007.000.1		007
	10.85 - 07.89	↘↗	31.087.008.000.1		008
	10.85 - 07.89	↘	31.088.018.000.1		018
	10.85 - 07.89	↘↗	31.088.018.000.1		018



# Таблица применяемости тормозных шлангов



		i	Код Дафми	Дополнительная информация	Тип №
---	---	---	--------------	------------------------------	-------

309 II.(3C, 3A)					
All models	07.89 - 12.93		31.085.008.000.1	Армированный шланг	008
	07.89 - 12.93		31.086.007.000.1		007
	07.89 - 12.93		31.087.008.000.1		008
	07.89 - 12.93		31.088.018.000.1		018
405 Break (15E)					
1,6 1,9 1,8 TD 1,9 D	10.88 - 08.92		31.106.038.000.1		038
	10.88 - 08.92		31.108.042.000.1		042
1,9 4x4	10.88 - 08.92		31.109.038.000.1	К суппорту	038
	10.88 - 08.92		31.107.013.000.1		013
	10.88 - 08.92		31.108.042.000.1		042
405 I.(15B)					
1,4	01.87 - 07.92		31.106.038.000.1	-Шасси 8043879 Шасси 8043880-	038
	01.87 - 07.92		31.109.038.000.1		038
	01.87 - 07.92		31.108.042.000.1		042
1,6 1,9	07.87 - 12.92		31.106.038.000.1	-Шасси 8043879 Шасси 8043880- К суппорту	038
	07.87 - 12.92		31.109.038.000.1		038
	07.87 - 12.92		31.107.013.000.1		013
	07.87 - 12.92		31.108.042.000.1		042
1,8 TD 1,9 D	03.88 - 12.92		31.106.038.000.1	-Шасси 8043879 Шасси 8043880-	038
	03.88 - 12.92		31.109.038.000.1		038
	03.88 - 12.92		31.108.042.000.1		042
1,9 4x4	07.88 - 12.92		31.106.038.000.1	-Шасси 8043879 Шасси 8043880-	038
	07.88 - 12.92		31.109.038.000.1		038
	07.88 - 12.92		31.108.042.000.1		042
1,9 Sport MI-16	07.87 - 11.91		31.106.038.000.1	-Шасси 8043879 Шасси 8043880- К суппорту	038
	07.87 - 11.91		31.109.038.000.1		038
	07.87 - 11.91		31.107.013.000.1		013
	07.87 - 11.91		31.108.042.000.1		042
1,9 Sport MI-16 4x4	04.88 - 12.92		31.106.038.000.1	-Шасси 8043879 Шасси 8043880-	038
	04.88 - 12.92		31.109.038.000.1		038
	04.88 - 12.92		31.108.042.000.1		042
405 II. Break (4E)					
1,6 1,9 D 1,9 TD	08.92 - 10.96		31.106.038.000.1	Без ABS С ABS	038
	08.92 - 10.96		31.109.038.000.1		038
	08.92 - 10.96		31.108.042.000.1		042
1,8 2,0	08.92 - 10.96		31.106.038.000.1	Без ABS С ABS К суппорту	038
	08.92 - 10.96		31.109.038.000.1		038
	08.92 - 10.96		31.107.013.000.1		013
	08.92 - 10.96		31.108.042.000.1		042
2,0 4x4	08.92 - 10.96		31.106.038.000.1	Без ABS С ABS	038
	08.92 - 10.96		31.109.038.000.1		038
	08.92 - 10.96		31.107.013.000.1		013
405 II.(4B)					
1,4	08.92 - 10.95		31.109.038.000.1		038
	08.92 - 10.95		31.108.042.000.1		042
1,6	08.92 - 10.95		31.106.038.000.1	Без ABS С ABS	038
	08.92 - 10.95		31.109.038.000.1		038
	08.92 - 10.95		31.108.042.000.1		042
1,8	08.92 - 10.95		31.106.038.000.1	Без ABS С ABS К суппорту	038
	08.92 - 10.95		31.109.038.000.1		038
	08.92 - 10.95		31.107.013.000.1		013
	08.92 - 10.95		31.108.042.000.1		042
1,9 D	08.92 - 10.95		31.106.038.000.1		038
	08.92 - 10.95		31.108.042.000.1		042
1,9 TD	09.92 - 10.95		31.106.038.000.1	Без ABS С ABS	038
	09.92 - 10.95		31.109.038.000.1		038
	09.92 - 10.95		31.108.042.000.1		042
2,0	08.92 - : 10.95		31.109.038.000.1	К суппорту	038
	08.92 - 10.95		31.107.013.000.1		013
	08.92 - 10.95		31.108.042.000.1		042
2,0 4x4	08.92 - 10.95		31.109.038.000.1	Без ABS	038
	08.92 - 10.95		31.107.013.000.1		013
	08.92 - 10.95		31.108.042.000.1		042
2,0 16V	06.94 - 10.95		31.109.038.000.1	К суппорту	038
	06.94 - 10.95		31.107.013.000.1		013
	06.94 - 10.95		31.108.042.000.1		042
2,0 MI-16	08.92 - 10.95		31.109.038.000.1	К суппорту	038
	08.92 - 10.95		31.107.013.000.1		013
	08.92 - 10.95		31.108.042.000.1		042
2,0 T 16X4	08.92 - 10.95		31.109.038.000.1		038
	08.92 - 10.95		31.107.013.000.1		013

		i	Код Дафми	Дополнительная информация	Тип №
--	--	---	-----------	---------------------------	-------

<b>505 (551 A)</b>					
All models	09.80 - 12.93		31.086.007.000.1	C ABS	007
<b>505 Break (551 D)</b>					
All models	09.80 - 12.93		31.086.007.000.1	C ABS	007
<b>605 (68)</b>					
2,0	06.89 - 06.89 - 06.89 -	  	31.136.038.000.1 31.108.042.000.1 31.139.013.000.1	К суппорту	038 042 013
2,0 16V	07.94 - 07.94 - 07.94 -	  	31.136.038.000.1 31.108.042.000.1 31.139.013.000.1	К суппорту	038 042 013
2,0 Turbo	07.91 - 07.91 - 07.91 -	  	31.136.038.000.1 31.108.042.000.1 31.139.013.000.1	К суппорту	038 042 013
2,1 D	05.89 - 07.95 05.89 - 07.95 05.89 - 07.95	  	31.136.038.000.1 31.108.042.000.1 31.139.013.000.1	К суппорту	038 042 013
2,1 TD	06.89 - 06.89 - 06.89 -	  	31.136.038.000.1 31.108.042.000.1 31.139.013.000.1	К суппорту	038 042 013
2,1 TD 12V	08.94 - 08.94 - 08.94 -	  	31.136.038.000.1 31.108.042.000.1 31.139.013.000.1	К суппорту	038 042 013
2,5 TD	07.94 - 07.94 -	 	31.136.038.000.1 31.108.042.000.1		038 042
3,0	10.89 - 10.89 - 10.89 -	  	31.136.038.000.1 31.108.042.000.1 31.139.013.000.1	К суппорту	038 042 013
3,0 SV 24	06.90 - 06.90 - 06.90 -	  	31.136.038.000.1 31.108.042.000.1 31.139.013.000.1	Для ABS BENDIX   - шасси 90807683	038 042 013
3,0 V6	04.97 - 04.97 - 04.97 -	  	31.136.038.000.1 31.108.042.000.1 31.139.013.000.1	К суппорту	038 042 013
<b>607 (9_)</b>					
2,2 16V 2,2 HDI	02.00 - 02.00 -	 	31.108.042.000.1 31.139.013.000.1	-шасси 08686   внутренний -шасси 08686   к суппорту	042 013
3,0 V6	02.00 - 02.00 -	 	31.108.042.000.1 31.139.013.000.1	-шасси 08686   внутренний -шасси 08686   к суппорту	042 013
<b>J5 box body (280L)</b>					
1,8	01.83 - 11.88 01.83 - 11.88 01.83 - 11.86	  	31.096.007.000.1 31.098.007.000.1 31.014.008.000.1	Шасси 172001-   Нижний Шасси 172001-   Верхний	007 007 008
<b>J5 box body (290L)</b>					
1,9 D 2,5 D 4x4 2,5 TD 4x4	10.90 - 10.90 - 10.90 -	  	31.096.007.000.1 31.098.007.000.1 31.014.008.000.1	Шасси 172001-   Нижний Шасси 172001-   Верхний	007 007 008
<b>J5 bus (280P)</b>					
2,0 2,5 D	09.81 - 09.90 09.81 - 09.90 09.81 - 09.90 09.81 - 09.90	   	31.096.007.000.1 31.098.007.000.1 31.179.008.000.1 31.014.008.000.1	Шасси 172001-   Нижний Шасси 172001-   Верхний -Шасси 172000	007 007 008 008
<b>J5 bus (290P)</b>					
2,0 1,9 D 2,5 D 2,5 D 4x4	10.90 - 10.90 - 10.90 -	  	31.096.007.000.1 31.098.007.000.1 31.014.008.000.1	Шасси 172001-   Нижний Шасси 172001-   Верхний	007 007 008
2,5 TD 2,5 TD 4x4	10.90 - 10.90 - 10.90 -	  	31.096.007.000.1 31.098.007.000.1 31.014.008.000.1	Шасси 172001-   Нижний Шасси 172001-   Верхний	007 007 008
<b>J5 Platform/Chassis (2801)</b>					
2,0	01.83 - 11.88 01.83 - 11.88 01.83 - 11.88 01.83 - 11.88	   	31.096.007.000.1 31.098.007.000.1 31.179.008.000.1 31.014.008.000.1	Шасси 172001-   Нижний Шасси 172001-   Верхний -Шасси 172000	007 007 008 008
2,5 D	09.81 - 09.90 09.81 - 09.90 09.81 - 09.90 09.81 - 09.90	   	31.096.007.000.1 31.098.007.000.1 31.179.008.000.1 31.014.008.000.1	Шасси 172001-   Нижний Шасси 172001-   Верхний -Шасси 172000	007 007 008 008
<b>J5 Platform/Chassis (290L)</b>					
2,0 1,9 D 2,5 D 2,5 D 4x4	10.90 - 10.90 -	 	31.096.007.000.1 31.098.007.000.1	Ch 172001-   Нижний Ch 172001-   Верхний	007 007

# Таблица применяемости тормозных шлангов



		i	Код Дафми	Дополнительная информация	Тип №
--	--	---	-----------	---------------------------	-------

2,5 TD 2,5 TD 4x4	10.90 -	↓	31.014.008.000.1		008
	10.90 -	↗	31.096.007.000.1	Ch 172001- I Нижний	007
	10.90 -	↘	31.098.007.000.1	Ch 172001- I Верхний	007
	10.90 -	↓	31.014.008.000.1		008
<b>J7</b>					
1,6 1,8 2,1 D 2,3 D	09.79 - 03.80	↗	31.204.010.000.1		010
<b>J9 Bus</b>					
1,6 2,0 2,1 D	03.80 - 06.87	↗	31.204.010.000.1		010
	03.80 - 06.87	↘	31.212.057.000.1		057
2,3 D	03.80 - 07.82	↗	31.204.010.000.1		010
	03.80 - 07.82	↘	31.212.057.000.1		057
2,5 D	07.82 - 03.87	↗	31.204.010.000.1		010
	07.82 - 03.87	↘	31.212.057.000.1		057
<b>J9 Box</b>					
2,0	03.80 - 06.87	↗	31.204.010.000.1		010
	03.80 - 06.87	↘	31.212.057.000.1		057
2,3 D	03.80 - 07.82	↗	31.204.010.000.1		010
	03.80 - 07.82	↘	31.212.057.000.1		057
2,5 D	07.82 - 03.87	↗	31.204.010.000.1		010
	07.82 - 03.87	↘	31.212.057.000.1		057
<b>J9 Platform/Chassis</b>					
2,0	03.80 - 06.87	↗	31.204.010.000.1		010
	03.80 - 06.87	↘	31.212.057.000.1		057
2,3 D	03.80 - 07.82	↗	31.204.010.000.1		010
	03.80 - 07.82	↘	31.212.057.000.1		057
2,5 D	07.82 - 03.87	↗	31.204.010.000.1		010
	07.82 - 03.87	↘	31.212.057.000.1		057

## RENAULT

<b>4</b>					
1,1	06.78 - 06.90	↗	31.080.013.000.1	Шасси 378299-	013
<b>4 box body</b>					
1,1	10.76 - 07.89	↗	31.080.013.000.1	Шасси 296903 F6-	013
<b>5</b>					
0,8	01.82 - 12.84	↗	31.080.013.000.1	Шасси 335201- I Шасси 51151-	013
1,0	01.72 - 12.85	↗	31.080.013.000.1		013
1,3	09.76 - 09.84	↗	31.080.013.000.1		013
1,4	01.82 - 12.85	↗	31.080.013.000.1		013
1,4 Alpine A5	09.77 - 09.81	↗	31.080.013.000.1		013
1,4 Alpine Turbo	10.81 - 01.85	↗	31.080.013.000.1		013
<b>5 Super (B/C40)</b>					
1,0	10.84 - 10.88	↗	31.080.013.000.1		013
	10.84 - 10.88	↘	31.045.042.000.1		042
	10.84 - 10.88	↓	31.081.042.000.1		042
1,1	10.84 - 03.95	↗	31.080.013.000.1		013
	10.84 - 03.95	↘	31.045.042.000.1		042
	10.84 - 03.95	↓	31.081.042.000.1		042
1,2	01.87 - 12.96	↗	31.080.013.000.1		013
	01.87 - 12.96	↘	31.045.042.000.1		042
	01.87 - 12.96	↓	31.081.042.000.1		042
1,4	10.84 - 12.96	↗	31.080.013.000.1		013
	10.84 - 12.96	↘	31.045.042.000.1		042
	10.84 - 12.96	↓	31.081.042.000.1		042
1,4 Turbo	04.85 - 08.90	↗	31.080.013.000.1		013
	04.85 - 08.90	↘	31.045.042.000.1		042
1,4 Turbo GT	01.85 - 05.91	↗	31.080.013.000.1		013
	01.85 - 05.91	↘	31.045.042.000.1		042
1,6 D	10.87 - 03.95	↗	31.080.013.000.1		013
	10.87 - 03.95	↘	31.045.042.000.1		042
	10.87 - 03.95	↓	31.081.042.000.1		042
1,7	10.86 - 03.95	↗	31.080.013.000.1		013
	10.86 - 03.95	↘	31.045.042.000.1		042
	10.86 - 03.95	↓	31.081.042.000.1		042
1,7 i	10.86 - 08.91	↗	31.080.013.000.1		013
	10.86 - 08.91	↘	31.045.042.000.1		042
<b>9 (L42)</b>					
All models	09.81 - 12.89	↗	31.083.013.000.1		013
	09.81 - 12.89	↘	31.045.042.000.1	Проверьте длину!	042
	09.81 - 12.89	↘	31.082.042.000.1	Проверьте длину!	042
<b>11 (B/C37)</b>					
All models	08.83 - 12.88	↗	31.083.013.000.1		013

		i	Код Дафми	Дополнительная информация	Тип №
	08.83 - 12.88		31.045.042.000.1	Проверьте длину!	042
	08.83 - 12.88		31.082.042.000.1	Проверьте длину!	042
<b>18 (134)</b>					
1,4	04.78 - 07.86		31.014.008.000.1		008
1,6	04.78 - 07.86		31.014.008.000.1		008
1,6 TS	05.82 - 07.86		31.043.008.000.1		008
	05.82 - 07.86		31.014.008.000.1		008
1,6 Turbo	01.81 - 09.82		31.043.008.000.1		008
	10.80 - 09.82		31.014.008.000.1		008
2,0	05.82 - 12.82		31.043.008.000.1		008
2,0 4x4	05.83 - 12.86		31.043.008.000.1		008
2,1 D	11.81 - 07.86		31.043.008.000.1		008
2,1 TD	11.81 - 07.86		31.043.008.000.1		008
<b>19 (B/C53)</b>					
1,4	01.88 - 12.92		31.110.013.000.1		013
	01.88 - 12.92		31.045.042.000.1	Без ABS   Проверьте длину!	042
1,4 KAT	01.89 - 04.92		31.110.013.000.1		013
	01.89 - 04.92		31.045.042.000.1	Без ABS   Проверьте длину!	042
1,7	09.88 - 04.92		31.110.013.000.1		013
	09.88 - 04.92		31.045.042.000.1	Без ABS   Проверьте длину!	042
	09.88 - 04.92		31.111.042.000.1	Без ABS	042
1,8 16V	06.89 - 04.92		31.110.013.000.1		013
	06.89 - 04.92		31.045.042.000.1	Без ABS   Проверьте длину!	042
	06.89 - 04.92		31.111.042.000.2	Без ABS	042
1,9	09.88 - 04.92		31.110.013.000.1		013
	09.88 - 04.92		31.045.042.000.1	Без ABS   Проверьте длину!	042
	09.88 - 04.92		31.111.042.000.3	Без ABS	042
<b>19 box body</b>					
1,2	01.88 - 12.92		31.110.013.000.1		013
	01.88 - 12.92		31.045.042.000.1	Проверьте длину!	042
	01.88 - 12.92		31.111.042.000.1	Проверьте длину!	042
1,9 D	01.89 - 04.92		31.110.013.000.1		013
	01.89 - 04.92		31.045.042.000.1	Без ABS   Проверьте длину!	042
	01.88 - 12.92		31.111.042.000.1	Без ABS   Проверьте длину!	042
<b>19 Chamade (L53)</b>					
1,4	04.89 - 12.89		31.110.013.000.1		013
	04.89 - 12.89		31.045.042.000.1	Проверьте длину!	042
1,4 KAT	10.89 - 04.92		31.110.013.000.1		013
	10.89 - 04.92		31.045.042.000.1	Проверьте длину!	042
1,4 1,7 1,8 1,9 D 1,9 TD	04.92 - 12.95		31.110.013.000.1		013
	04.92 - 12.95		31.045.042.000.1	Без ABS   Проверьте длину!	042
	04.92 - 12.95		31.111.042.000.6	Без ABS	042
1,7 1,8 16V 1,9 D	10.89 - 04.92		31.110.013.000.1		013
	10.89 - 04.92		31.045.042.000.1	Проверьте длину!	042
	10.89 - 04.92		31.111.042.000.7	Без ABS	042
<b>19 II. box body</b>					
1,9 TD	03.92 - 12.95		31.110.013.000.1		013
	03.92 - 12.95		31.045.042.000.1		042
<b>20</b>					
2,2 2,1 D 2,1 TD	10.80 - 12.83		31.043.008.000.1		008
<b>21 (B48)</b>					
1,7	09.89 - 06.94		31.135.013.000.1		013
	09.89 - 06.94		31.081.042.000.1	Без ABS	042
1,9 D	09.89 - 10.93		31.138.013.000.1		013
	09.89 - 10.93		31.110.013.000.1	С ABS   Внешний, Внутренний   Проверьте длину!	013
	09.89 - 06.94		31.081.042.000.1	Без ABS	042
	09.89 - 10.93		31.138.013.000.1	С ABS   Внутренний   Проверьте длину!	013
2,0 2,2 2,1 D 2,1 Turbo	08.89 -		31.138.013.000.1		013
	08.89 -		31.110.013.000.1	С ABS   Внешний, Внутренний   Проверьте длину!	013
	08.89 -		31.081.042.000.1	Без ABS	042
	08.89 -		31.138.013.000.1	С ABS   Внутренний   Проверьте длину!	013
2,2 4x4	07.90 - 06.94		31.138.013.000.1		013
	07.90 - 06.94		31.110.013.000.1	С ABS   Внешний, Внутренний   Проверьте длину!	013
	07.90 - 06.94		31.081.042.000.1	Без ABS	042
	07.90 - 06.94		31.138.013.000.1	С ABS   Внутренний   Проверьте длину!	013
<b>21 Estate (K48)</b>					
1,7	06.86 -		31.135.013.000.1		013
1,9 D	03.86 - 08.94		31.135.013.000.1		013
2,0 2,2 2,2 4x4	03.86 - 12.93		31.138.013.000.1		013
	03.86 - 12.93		31.080.013.000.1	С ABS   Внешний, Внутренний   Проверьте длину!	013
	03.86 - 12.93		31.110.013.000.1	С ABS   Внутренний   Проверьте длину!	013

























































# Таблица применяемости тормозных шлангов



		i	Код Дафми	Дополнительная информация	Тип №
--	--	---	-----------	---------------------------	-------

2,1 D 2,1 TD	10.86 -		31.138.013.000.1	С ABS   Внешний, Внутренний   Проверьте длину! С ABS   Внутренний   Проверьте длину!	013
	10.86 -		31.080.013.000.1		013
	10.86 -		31.110.013.000.1		013
<b>21 Sedan (L48)</b>					
1,7	03.86 - 02.94		31.135.013.000.1	Без ABS	013
	03.86 - 02.94		31.081.042.000.1		042
1,9 D	08.89 - 10.93		31.135.013.000.1	Без ABS	013
	08.89 - 10.93		31.081.042.000.1		042
2,0 T4X4 2,0 T Q 2,2 4x4	02.90 -		31.138.013.000.1	С ABS   Внешний, Внутренний   Проверьте длину! Без ABS С ABS   Внутренний   Проверьте длину!	013
	02.90 -		31.110.013.000.1		013
	02.90 -		31.081.042.000.1		042
	02.90 -		31.138.013.000.1		013
2,0 2,2 2,1 D 2,1 TD	03.86 -		31.138.013.000.1	С ABS   Внешний, Внутренний   Проверьте длину! Без ABS С ABS   Внутренний   Проверьте длину!	013
	03.86 -		31.110.013.000.1		013
	03.86 -		31.081.042.000.1		042
	03.86 -		31.138.013.000.1		013
<b>25 (B297)</b>					
2,0	04.84 - 12.93		31.112.013.000.1	С ABS Без ABS Без ABS К клапану С ABS   К суппорту	013
	04.84 - 06.84		31.044.013.000.1		013
	06.84 - 12.93		31.112.013.000.1		013
	04.84 - 12.93		31.045.042.000.1		042
	04.84 - 12.93		31.046.013.000.1		013
2,0 12V	06.88 - 12.93		31.112.013.000.1	К клапану К суппорту	013
	06.88 - 12.93		31.045.042.000.1		042
	06.88 - 12.93		31.046.013.000.1		013
2,1 D	04.84 - 06.84		31.044.013.000.1	К клапану С ABS   К суппорту	013
	07.84 -		31.112.013.000.1		013
	04.84 -		31.045.042.000.1		042
	04.84 -		31.046.013.000.1		013
2,1 TD	04.84 - 06.84		31.044.013.000.1	К клапану С ABS   К суппорту	013
	07.84 - 12.92		31.112.013.000.1		042
	04.84 - 12.92		31.045.042.000.1		042
	04.84 - 12.92		31.046.013.000.1		013
2,2	04.84 - 12.89		31.112.013.000.1	С ABS К клапану С ABS   К суппорту Без ABS	013
	04.84 - 12.89		31.045.042.000.1		042
	04.84 - 12.89		31.046.013.000.1		013
	06.84 - 12.89		31.112.013.000.1		013
2,2.	09.86 - 12.92		31.112.013.000.1	К клапану К суппорту	013
	09.86 - 12.92		31.045.042.000.1		042
	09.86 - 12.92		31.046.013.000.1		013
2,4 V6 Turbo	10.84 - 05.90		31.112.013.000.1	К клапану К суппорту	013
	10.84 - 05.90		31.045.042.000.1		042
	10.84 - 05.90		31.046.013.000.1		013
2,5 V6 Turbo	01.90 - 12.92		31.112.013.000.1	К клапану К суппорту	013
	01.90 - 12.92		31.045.042.000.1		042
	01.90 - 12.92		31.046.013.000.1		013
2,7 V6 Injection	04.84 - 08.84		31.044.013.000.1	К клапану К суппорту	013
	09.84 - 08.89		31.112.013.000.1		013
	04.84 - 08.89		31.045.042.000.1		042
	04.84 - 08.89		31.046.013.000.1		013
2,8 V6 Injection	06.86 - 12.92		31.112.013.000.1	К клапану К суппорту	013
	06.86 - 12.92		31.045.042.000.1		042
	06.86 - 12.92		31.046.013.000.1		013
<b>30 (127)</b>					
2,1 TD	02.82 - 03.86		31.043.008.000.1		008
	02.82 -		31.094.018.000.1		018
2,6	08.76 - 08.78		31.094.018.000.1		018
2,6 TS, TX	07.78 - 01.84		31.094.018.000.1		018
<b>Espace (J11/13)</b>					
2,0	07.84 - 12.90		31.043.008.000.1	С ABS	008
	07.84 - 12.90		31.014.008.000.1		008
2,0 i	01.89 - 12.90		31.043.008.000.1	С ABS	008
	01.89 - 12.90		31.014.008.000.1		008
2,0 i. Quadra	03.88 - 12.92		31.043.008.000.1	К суппорту	008
	03.88 - 12.92		31.014.008.000.1		008
2,1 TD	10.84 - 12.90		31.043.008.000.1	С ABS   К суппорту	008
	10.84 - 12.90		31.014.008.000.1		008
2,2	07.86 - 12.90		31.043.008.000.1	С ABS   К суппорту	008
	07.86 - 12.90		31.014.008.000.1		008
2,2 Quadra	01.88 - 12.90		31.043.008.000.1	С ABS   К суппорту	008
	01.88 - 12.90		31.014.008.000.1		008

		i	Код Дафми	Дополнительная информация	Тип №
---	---	---	--------------	------------------------------	-------

Espace II. (J63)					
2,0 2,2	01.91 - 10.96		31.044.013.000.1		013
	01.91 - 10.96		31.014.008.000.1	Без ABS I К клапану	008
	01.91 - 10.96		31.014.008.000.1	С ABS I К клапану	008
2,1 TD	11.94 - 10.96		31.044.013.000.1		013
	11.94 - 10.96		31.014.008.000.1	К клапану	008
2,2 4x4	03.91 - 12.96		31.044.013.000.1		013
	03.91 - 12.96		31.014.008.000.1	К суппорту	008
2,8 V6	01.91 - 10.96		31.044.013.000.1		013
	01.91 - 10.96		31.014.008.000.1	К клапану	008
Espace III. (JE)					
2,0 16V 3,0 V6 24V	10.98 -		31.110.013.000.1		013
2,0 2,2 12V TD 3,0	11.96 -		31.110.013.000.1		013
Fuego (136)					
All models	02.80 - 10.85		31.043.008.000.1		008
	02.80 - 10.85		31.110.013.000.1	К суппорту	013
	02.80 - 10.85		31.014.008.000.1		008
Laguna (B56, K56)					
1,6 16V 1,8 16V	11.97 -		31.081.042.000.1		042
1,8 2,0 2,0 16V 2,2 D	11.93 -		31.081.042.000.1		042
	11.93 -		31.046.013.000.1	К суппорту	013
1,9 dCi	09.99 -		31.081.042.000.1		042
	09.99 -		31.046.013.000.1	К суппорту	013
1,9 dTi	10.97 -		31.081.042.000.1		042
	10.97 -		31.046.013.000.1	К суппорту	013
2,9 24V	03.97 -		31.081.042.000.1		042
	03.97 -		31.046.013.000.1	К суппорту	013
3,0 2,2 dT	02.96 -		31.081.042.000.1		042
	02.96 -		31.046.013.000.1	К суппорту	013
Megane Classic (LA)					
All models	09.96 -		31.206.013.000.1		008
	09.96 -		31.198.042.000.1		013
Megane Coach (DA)					
All models	03.96 -		31.206.013.000.1		008
	03.96 -		31.198.042.000.1		013
Megane I. (BA)					
All models	07.96 -		31.206.013.000.1		008
	07.96 -		31.198.042.000.1		013
Megane II. (BM0_, CM0_)					
All models	11.02 -		31.206.013.000.1		008
	11.02 -		31.198.042.000.1		013
R5					
Express	10.85 -		31.080.013.000.1		013
	10.85 -		31.045.042.000.1		042
	10.85 -		31.081.042.000.1		042
Rapid box body (F40)					
1,0	02.86 - 05.92		31.080.013.000.1		013
	02.86 - 05.92		31.045.042.000.1		042
1,2	09.91 - 03.98		31.080.013.000.1		013
	09.91 - 03.98		31.045.042.000.1		042
1,4	07.85 - 03.98		31.080.013.000.1		013
	07.85 - 03.98		31.045.042.000.1		042
	07.85 - 03.98		31.081.042.000.1	Увеличена нагрузка	042
1,6 D	03.86 - 08.98		31.080.013.000.1		013
	03.86 - 08.98		31.045.042.000.1		042
	03.86 - 08.98		31.081.042.000.1	Увеличена нагрузка	042
1,9 D	04.94 - 03.98		31.080.013.000.1		013
	04.94 - 03.98		31.045.042.000.1		042
	04.94 - 03.98		31.081.042.000.1	Увеличена нагрузка	042
Safrane (B54)					
3,0 Biturbo 4x4	02.93 -		31.080.013.000.1		013
3,0 V6 4x4	12.92 - 07.96		31.080.013.000.1		013
Scenic (JA)					
All models	11.02 -		31.206.013.000.1		008
	11.02 -		31.198.042.000.1		013
Trafic (T1-T7) (P6)					
All models	03.80 - 04.89		31.138.013.000.1		013
	03.80 - 04.89		31.044.013.000.1		013
	03.80 - 04.89		31.184.013.000.1	Проверьте длину!	013
Trafic box body (TXX)					
All models	05.89 -		31.138.013.000.1		013

# Таблица применимости тормозных шлангов





















































		i	Код Дафми	Дополнительная информация	Тип №
--	--	---	-----------	---------------------------	-------

	05.89 - 05.89 -		31.044.013.000.1 31.184.013.000.1	Проверьте длину!	013 013
<b>Trafic bus (TXW)</b>					
1,4 2,0 2,2 2,2 4x4	05.89 - 05.89 - 05.89 -		31.138.013.000.1 31.044.013.000.1 31.184.013.000.1	Проверьте длину!	013 013 013
1,7	08.92 - 08.94 08.92 - 08.94 08.92 - 08.94		31.138.013.000.1 31.044.013.000.1 31.184.013.000.1	К суппорту Проверьте длину!	013 013 013
2,0	05.89 - 08.90 05.89 - 08.90 05.89 - 08.90		31.138.013.000.1 31.044.013.000.1 31.184.013.000.1	Проверьте длину!	013 013 013
2,1 D	05.89 - 06.94 05.89 - 05.89 - 06.94		31.138.013.000.1 31.044.013.000.1 31.184.013.000.1	Проверьте длину!	013 013 013
2,2	05.89 - 05.89 -		31.184.013.000.1 31.044.013.000.1	Проверьте длину!	013 013
2,5 D	05.89 - 05.89 -		31.138.013.000.1 31.044.013.000.1	К суппорту	013 013
<b>Trafic Platform/Chassis (PXX)</b>					
2,0 2,1 D	05.89 - 05.89 -		31.138.013.000.1 31.044.013.000.1		013 013
<b>Twingo (C06)</b>					
1,2	03.93 - 10.96 05.96 -		31.135.013.000.1 31.135.013.000.1		013 013
<b>Twingo box (S06)</b>					
1,2	03.93 -		31.135.013.000.1		013

## SEAT

<b>Cordoba (6K2)</b>					
1,4	06.99 -		31.021.005.000.1	Шасси 6KZR632593-	005
1,4 16V	05.00 -		31.021.005.000.1	Шасси 6KZR632593-	005
1,6	06.99 -		31.021.005.000.1	Шасси 6KZR632593-	005
1,8 T 20V	06.99 -		31.021.005.000.1	Шасси 6KZR632593-	005
1,9 SDI	06.99 -		31.021.005.000.1	Шасси 6KZR632593-	005
1,9 TDI	06.99 -		31.021.005.000.1	Шасси 6KZR632593-	005
<b>Cordoba (6K2/C2)</b>					
1,0 i	09.96 - 06.99 09.96 - 06.99		31.021.005.000.1 31.157.019.000.1		005 019
1,4 i	06.94 - 06.99 06.94 - 06.99		31.021.005.000.1 31.157.019.000.1	-Шасси 6KZR106941   -Шасси 6KZR632592	005 019
1,4 i 16V	09.96 - 06.99 09.96 - 06.99		31.021.005.000.1 31.157.019.000.1	-Шасси 6KZR106941   -Шасси 6KZR632593	005 019
1,6 i	02.93 - 06.99 02.93 - 06.99		31.021.005.000.1 31.157.019.000.1	-Шасси 6KZR106941   -Шасси 6KZR632594	005 019
1,7 SDI	07.97 - 06.99 07.97 - 06.99		31.021.005.000.1 31.157.019.000.1	-Шасси 6KZR106941   -Шасси 6KZR632595	005 019
1,8 i	02.93 - 06.99 02.93 - 06.99		31.021.005.000.1 31.157.019.000.1	-Шасси 6KZR106941   -Шасси 6KZR632596	005 019
1,8 i 16V	10.93 - 08.96 10.93 - 08.96 10.93 - 08.96		31.021.005.000.1 31.015.005.000.1 31.157.019.000.1	-Шасси 6KZR106941   -Шасси 6KZR632597 К суппорту	005 005 019
1,9 D	02.93 - 08.96 02.93 - 08.96		31.021.005.000.1 31.157.019.000.1	-Шасси 6KZR106941   -Шасси 6KZR632597	005 019
1,9 SDI	08.96 - 06.99 08.96 - 06.99		31.021.005.000.1 31.157.019.000.1	-Шасси 6KZR106941   -Шасси 6KZR632598	005 019
1,9 TD	02.93 - 08.96 02.93 - 08.96		31.021.005.000.1 31.157.019.000.1	-Шасси 6KZR106941   -Шасси 6KZR632599	005 019
1,9 TDI	08.96 - 06.99 08.96 - 06.99		31.021.005.000.1 31.157.019.000.1	-Шасси 6KZR106941   -Шасси 6KZR632600	005 019
2,0 i	02.93 - 06.99 02.93 - 06.99 02.93 - 06.99		31.021.005.000.1 31.015.005.000.1 31.157.019.000.1	-Шасси 6KZR106941   -Шасси 6KZR632601 К суппорту	005 005 019
2,0 i 16V	08.96 - 06.99 08.96 - 06.99 08.96 - 06.99		31.021.005.000.1 31.015.005.000.1 31.157.019.000.1	-Шасси 6KZR106941   -Шасси 6KZR632601 К суппорту	005 005 019
<b>Cordoba (6L2)</b>					
All models	06.99 -		31.215.060.000.1		060

		i	Код Дафми	Дополнительная информация	Тип №
---	---	---	-----------	---------------------------	-------









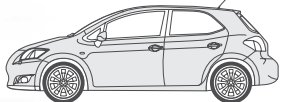
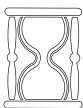





















Cordoba Vario					
1,4	06.99 -		31.021.005.000.1		005
1,4 16V	06.99 -		31.021.005.000.1		005
1,6	06.99 -		31.021.005.000.1		005
1,9 SDI	06.99 -		31.021.005.000.1		005
1,9 TDI	06.99 -		31.021.005.000.1		005
Cordoba Vario (6K5)					
1,4 i	06.96 - 06.99		31.157.019.000.1	-Шасси 6KZR106941   -Шасси 6KZR632592	019
	09.96 - 06.99		31.021.005.000.1		005
1,6 i	09.96 - 06.99		31.021.005.000.1	-Шасси 6KZR106941   -Шасси 6KZR632592	005
	09.96 - 06.99		31.157.019.000.1		019
1,7 SDI	07.97 - 06.99		31.021.005.000.1	-Шасси 6KZR106941   -Шасси 6KZR632592	005
	07.97 - 06.99		31.157.019.000.1		019
1,9 SDI	06.96 - 06.99		31.157.019.000.1	-Шасси 6KZR106941   -Шасси 6KZR632592	019
	09.96 - 06.99		31.021.005.000.1		005
1,9 TDI	07.97 - 06.99		31.021.005.000.1	-Шасси 6KZR106941   -Шасси 6KZR632592	005
	07.97 - 06.99		31.157.019.000.1		019
Ibiza II.(6K1)					
1,0	03.93 - 09.96		31.021.005.000.1	-Шасси 6KZR106941   -Шасси 6KZR632592	005
	03.93 - 09.96		31.157.019.000.1		019
1,0 i	09.96 - 08.99		31.021.005.000.1	-Шасси 6KZR106941   -Шасси 6KZR632592	005
	09.96 - 08.99		31.157.019.000.1		019
1,3 i	03.93 - 08.99		31.021.005.000.1	-Шасси 6KZR106941   -Шасси 6KZR632592	005
	03.93 - 08.99		31.157.019.000.1		019
1,4 i	03.93 - 08.99		31.021.005.000.1	-Шасси 6KZR106941   -Шасси 6KZR632592	005
	03.93 - 08.99		31.157.019.000.1		019
1,4 i 16V	06.96 - 08.99		31.157.019.000.1	-Шасси 6KZR106941   -Шасси 6KZR632592	019
	09.96 - 08.99		31.021.005.000.1		005
1,6 i	03.93 - 08.99		31.021.005.000.1	-Шасси 6KZR106941   -Шасси 6KZR632592	005
	03.93 - 08.99		31.157.019.000.1		019
1,7 SDI	07.97 - 08.89		31.021.005.000.1	-Шасси 6KZR106941   -Шасси 6KZR632592	005
	07.97 - 08.89		31.157.019.000.1		019
1,8 i	03.93 - 08.99		31.021.005.000.1	-Шасси 6KZR106941   -Шасси 6KZR632592	005
	03.93 - 08.99		31.157.019.000.1		019
1,8 i 16V	11.93 - 08.96		31.021.005.000.1	-Шасси 6KZR106941   -Шасси 6KZR632592 К суппорту	005
	11.93 - 08.96		31.015.005.000.1		005
	11.93 - 08.96		31.157.019.000.1		019
1,9 D	04.93 - 08.96		31.021.005.000.1	-Шасси 6KZR106941   -Шасси 6KZR632592	005
	04.93 - 08.96		31.157.019.000.1		019
1,9 SDI	08.96 - 08.99		31.021.005.000.1	-Шасси 6KZR106941   -Шасси 6KZR632592	005
	08.96 - 08.99		31.157.019.000.1		019
1,9 TD	03.93 - 08.96		31.021.005.000.1	-Шасси 6KZR106941   -Шасси 6KZR632592	005
	03.93 - 08.96		31.157.019.000.1		019
1,9 TDI	08.96 - 08.99		31.021.005.000.1	-Шасси 6KZR106941   -Шасси 6KZR632592 К суппорту	005
	08.96 - 08.99		31.015.005.000.1		005
	08.96 - 08.98		31.157.019.000.1		019
2,0 i	03.93 - 08.99		31.021.005.000.1	-Шасси 6KZR106941   -Шасси 6KZR632592 К суппорту	005
	03.93 - 08.99		31.015.005.000.1		005
	03.93 - 08.99		31.157.019.000.1		019
2,0 i 16V	08.96 - 08.99		31.021.005.000.1	-Шасси 6KZR106941   -Шасси 6KZR632592 К суппорту	005
	08.96 - 08.99		31.015.005.000.1		005
	08.96 - 08.99		31.157.019.000.1		019
Ibiza III.					
1,4	08.99 -		31.021.005.000.1	-Шасси 6KZR106941   -Шасси 6KZR632592	005
1,4 16V	08.99 -		31.021.005.000.1	-Шасси 6KZR106941   -Шасси 6KZR632592	005
1,6	08.99 -		31.021.005.000.1	-Шасси 6KZR106941   -Шасси 6KZR632592	005
1,8 T 20V	08.99 -		31.021.005.000.1	-Шасси 6KZR106941   -Шасси 6KZR632592	005
1,9 SDI	08.99 -		31.021.005.000.1	-Шасси 6KZR106941   -Шасси 6KZR632592	005
1,9 TDI	08.99 -		31.021.005.000.1	-Шасси 6KZR106941   -Шасси 6KZR632592	005
Ibiza IV.(6L1)					
All models	02.02 -		31.215.060.000.1		060
Inka (6K9)					
1,4 i	11.95 -		31.021.005.000.1		005
1,6 i	11.95 -		31.021.005.000.1		005
1,7 D	09.96 -		31.021.005.000.1		005
1,9 D	11.95 -		31.021.005.000.1		005

























# Таблица применяемости тормозных шлангов























		i	Код Дафми	Дополнительная информация	Тип №
---	---	---	--------------	------------------------------	-------

1,9 SDI	11.95 -		31.021.005.000.1		005
1,9 TDI	09.96 -		31.021.005.000.1		005
<b>Leon (1M)</b>					
All models	07.99 -		31.214.059.000.1		059
<b>Terra(24)</b>					
0,9	02.87 - 12.96		31.014.008.000.1		008
0,9 KAT	02.92 - 12.94		31.014.008.000.1		008
1,3	03.90 - 12.94		31.014.008.000.1		008
1,4 D	10.90 - 12.95		31.014.008.000.1		008
<b>Terra box body (024 A)</b>					
0,9	01.87 - 12.95		31.014.008.000.1		008
0,9 KAT	01.90 - 12.95		31.014.008.000.1		008
1,3 D	03.90 - 02.92		31.014.008.000.1		008
1,4	10.90 - 02.92		31.014.008.000.1		008
<b>Toledo (1L)</b>					
1,6 i	05.91 - 03.99		31.020.005.000.1	-Шасси 1L-ZD342000	005
	05.91 - 03.99		31.144.026.000.1		026
1,8 i	05.91 - 03.99		31.020.005.000.1	-Шасси 1L-ZD342000	005
	05.91 - 03.99		31.144.026.000.1		026
1,8 i 16V	05.91 - 03.99		31.015.005.000.1	К суппорту	005
	05.91 - 03.99		31.144.026.000.1		026
1,9	05.91 - 03.99		31.020.005.000.1		005
	05.91 - 03.99		31.144.026.000.1		026
1,9 SDI	12.95 - 03.99		31.020.005.000.1		005
	12.95 - 03.99		31.144.026.000.1		026
1,9 TD	05.91 - 03.99		31.020.005.000.1		005
	05.91 - 03.99		31.144.026.000.1		026
1,9 TDI	08.95 - 03.99		31.020.005.000.1		005
	08.95 - 03.99		31.144.026.000.1		026
2,0 i	05.91 - 12.96		31.015.005.000.1	К суппорту	005
	05.91 - 12.96		31.144.026.000.1		026
2,0 i 16V	11.93 - 03.99		31.015.005.000.1	К суппорту	005
	11.93 - 03.99		31.157.019.000.1		019
<b>Toledo MKII. (1M2)</b>					
All models	07.99 -		31.214.059.000.1		059









## SKODA

<b>Fabia (6Y2)</b>					
All models	12.99 -		31.215.060.000.1		060
<b>Fabia Combi (6Y5)</b>					
All models	11.00 -		31.215.060.000.1		060
<b>Fabia Praktik</b>					
1,9 SDI	05.03 -		31.215.060.000.1		060
<b>Fabia Saloon (6Y3)</b>					
All models	07.00 -		31.215.060.000.1		060
<b>Favorit (781)</b>					
1,3	01.94 -		31.128.008.000.1		008
	01.94 -		31.129.019.000.1		019
1,3 (135)	10.90 -		31.128.008.000.1		008
	10.90 -		31.129.019.000.1		019
1,3 (135L)	05.89 -		31.128.008.000.1		008
	05.89 -		31.129.019.000.1		019
1,3 (136)	10.90 -		31.128.008.000.1		008
	10.90 -		31.129.019.000.1		019
1,3 135 X, LX, GLX	01.90 -		31.128.008.000.1		008
	01.90 -		31.129.019.000.1		019
<b>Favorit pick-up (787)</b>					
1,3	12.91 - 06.97		31.128.008.000.1		008
	12.91 - 06.97		31.129.019.000.1		019
<b>Favorit, Forman (785)</b>					
1,3	01.94 -		31.128.008.000.1		008
	01.94 -		31.129.019.000.1		019
1,3 (135)	12.91 -		31.128.008.000.1		008
	12.91 -		31.129.019.000.1		019
1,3 (135E)	12.92 -		31.128.008.000.1		008
	12.92 -		31.129.019.000.1		019
1,3 (136)	08.91 -		31.128.008.000.1		008



















		i	Код Дафми	Дополнительная информация	Тип №
---	---	---	-----------	---------------------------	-------

	08.91 -		31.129.019.000.1		019
<b>Felicia II.</b>					
1,3 1,6 1,9 D	03.98 -		31.205.008.000.1		008
	03.98 -		31.197.018.000.1		018
<b>Felicia (791)</b>					
1,3	10.94 - 03.98		31.205.008.000.1		008
	10.94 - 03.95		31.129.019.000.1		019
	04.95 - 03.98		31.197.018.000.1		018
1,6 LX	08.95 - 03.98		31.205.008.000.1		008
	10.95 - 03.98		31.197.018.000.1		018
1,9 D	10.95 - 03.98		31.205.008.000.1		008
	10.95 - 03.98		31.197.018.000.1		018
<b>Felicia Estate II.</b>					
1,3 1,6 1,9 D	03.98 -		31.205.008.000.1		008
<b>Felicia Estate (795)</b>					
1,3	08.95 - 03.98		31.205.008.000.1		008
1,3 LX	08.95 -		31.128.008.000.1		008
1,3 LXI	08.95 -		31.128.008.000.1		008
1,6 GLX	08.95 - 03.98		31.128.008.000.1		008
1,9 D	10.95 - 03.98		31.128.008.000.1		008
<b>Felicia Fun (797)</b>					
1,3 1,6 1,9 D	06.97 -		31.205.008.000.1		008
<b>Octavia (1U)</b>					
All models	09.96 -		31.214.059.000.1		045
	09.96 -		31.196.045.000.1		059
<b>Octavia combi (1U)</b>					
All models	07.98 -		31.214.059.000.1		045
	07.98 -		31.196.045.000.1		059

## SUZUKI

<b>Alto II.(EC)</b>					
0,8	01.86 - 11.93		31.162.024.000.1		024
<b>Swift II. (AH, AJ)</b>					
1,3	03.89 -		31.163.054.000.1		054
<b>Swift II.Hatchback (EA)</b>					
1,3	03.89 -		31.163.054.000.1		054
1,3GTI	03.89 -		31.163.054.000.1		054
<b>Swift (AA)</b>					
1,0	10.83 - 03.89		31.163.054.000.1		054
1,0 Turbo	02.85 - 12.89		31.163.054.000.1		054
1,3	10.84 - 03.89		31.163.054.000.1		054
1,3 Gil 1,3GXI	08.86 - 03.89		31.163.054.000.1		054

## TOYOTA







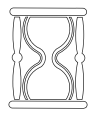



















<b>Camry ( V2 )</b>					
1,8 i	10.86 - 08.88		31.055.022.000.1		022
	10.86 - 08.88		31.152.021.000.1		021
2,0 GLI 16V 2,0 2,0 TD	11.86 - 05.91		31.055.022.000.1		022
	11.86 - 05.91		31.152.021.000.1		021
2,0 TD	11.88 - 05.91		31.055.022.000.1		022
	11.88 - 05.91		31.152.021.000.1		021
2,5 V6 GXI	02.88 - 05.91		31.055.022.000.1		022
<b>Camry Liftbac (V1)</b>					
1,8	02.83 - 10.86		31.055.022.000.1		022
1,8 TD	10.84 - 01.88		31.055.022.000.1		022
<b>Camry Sedan (V1)</b>					
1,8TD	11.83 - 01.88		31.055.022.000.1		022
1,8, 2,0 GLI	02.83 - 10.86		31.055.022.000.1		022
<b>Camry Station Wagon ( V2 )</b>					
All models	11.86 - 05.91		31.055.022.000.1		022
	11.86 - 05.91		31.152.021.000.1		021
<b>Carina (TA4L,TA6L)</b>					
1,6 (TA4L)	01.78 - 01.82		31.051.011.000.1		011
	08.81 - 01.82		31.052.021.000.1		021
1,6 (TA60L)	02.82 - 09.83		31.051.011.000.1		011
	09.83 -		31.058.022.000.1		022
1,8	01.82 - 02.87		31.052.021.000.1		021
	01.82 - 02.87		31.051.011.000.1		011

# Таблица применяемости тормозных шлангов

























		i	Код Дафми	Дополнительная информация	Тип №
1,8 D	04.82 - 09.83 04.82 - 09.83	↗ ↓	31.052.021.000.1 31.051.011.000.1		021 011
<b>Carina E ( T19_ )</b>					
All models	04.92 - 04.92 - 04.92 - 04.92 -	↗ ↗ ↘ ↘	31.217.061.000.1 31.218.061.000.1 31.219.062.000.1 31.220.062.000.1		061 061 062 062
<b>Carina E Estate ( T19_ )</b>					
All models	01.93 - 01.93 - 01.93 - 01.93 -	↗ ↗ ↘ ↘	31.217.061.000.1 31.218.061.000.1 31.219.062.000.1 31.220.062.000.1		061 061 062 062
<b>Carina E Saloon ( T19_ )</b>					
All models	01.93 - 01.93 - 01.93 - 01.93 -	↗ ↗ ↘ ↘	31.217.061.000.1 31.218.061.000.1 31.219.062.000.1 31.220.062.000.1		061 061 062 062
<b>Carina II. ( T15 )</b>					
1,6 1,8 GLi	10.83 - 11.87	↗↘	31.058.022.000.1		022
2,0 D	02.84 - 05.88	↗↘	31.058.022.000.1		022
<b>Carina II. ( T17 )</b>					
1,6 2,0 GLi	12.87 - 03.92 12.87 - 03.92	↗↘ ↘↗	31.156.022.000.1 31.152.021.000.1		022 021
2,0 D	03.88 - 06.93 03.88 - 06.93	↗↘ ↘↗	31.156.022.000.1 31.152.021.000.1		022 021
<b>Carina Station Wagon</b>					
1,6 (TA4K)	03.81 - 01.82	↓	31.051.011.000.1		011
1,6 (TA60LG)	02.82 - 09.83	↓	31.051.011.000.1		011
<b>Celica (T16)</b>					
1,6	04.86 - 02.90 04.86 - 02.90	↗↘ ↘↗	31.058.022.000.1 31.152.021.000.1		022 021
1,6 GT 16V	04.86 - 08.89 04.86 - 08.89	↗↘ ↘↗	31.058.022.000.1 31.152.021.000.1		022 021
2,0	01.87 - 08.90	↗↘	31.058.022.000.1		022
<b>Celica (TA 60, RA 40, RA6 )</b>					
1,6 ST	08.77 - 08.83	↓	31.051.011.000.1		011
1,6 ST.	02.82 - 12.83	↓	31.051.011.000.1		011
2,0 GT	02.78 - 08.83	↓	31.051.011.000.1		011
2,0 XT (RA40)	02.79 - 07.85	↓	31.051.011.000.1		011
2,0 XT (RA61)	02.82 - 12.83	↓	31.051.011.000.1		011
<b>Celica Convertible/roadster ( T16 )</b>					
2,0 GT	01.87 - 08.90	↗↘	31.058.022.000.1		022
<b>Celica coupe (T16F)</b>					
2,0 Turbo 4x4	03.88 - 08.90	↗↘	31.058.022.000.1		022
<b>Celica Lift back (T16)</b>					
1,6	04.86 - 02.90 04.86 - 02.90	↗↘ ↘↗	31.058.022.000.1 31.152.021.000.1		022 021
1,6 GT	08.87 - 08.89 08.87 - 08.89	↗↘ ↘↗	31.058.022.000.1 31.152.021.000.1		022 021
1,6 GT 16V	09.85 - 08.89	↗↘	31.058.022.000.1		022
2,0 GT	09.85 - 08.89	↗↘	31.058.022.000.1		022
<b>Corolla ( E7 )</b>					
All models	09.79 - 09.83 09.79 - 09.83	↗↘ ↓	31.057.021.000.1 31.051.011.000.1		021 011
<b>Corolla ( E8 )</b>					
1,3	06.83 - 08.87	↗↘	31.058.022.000.1		022
1,6 1,8 D	06.83 - 05.88	↗↘	31.058.022.000.1		022
<b>Corolla ( E9 )</b>					
All models	07.87 - 06.93 07.87 - 06.93	↗↘ ↘↗	31.126.022.000.1 31.127.021.000.1		022 021
<b>Corolla Liftback ( E9 )</b>					
All models	07.87 - 06.93 07.87 - 06.93	↗↘ ↘↗	31.126.022.000.1 31.127.021.000.1		022 021
<b>Corolla Liftback FX (E8B)</b>					
1,3	08.85 - 08.87	↗↘	31.058.022.000.1		022
1,6 GT 16V	08.85 - 08.87 08.85 - 08.87	↗↘ ↓	31.058.022.000.1 31.051.011.000.1		022 011

		i	Код Дафми	Дополнительная информация	Тип №
---	---	---	-----------	---------------------------	-------

1,8	01.85 - 05.88		31.058.022.000.1		022
Corolla Station Wagon ( E7 )					
1,3	12.79 - 08.87		31.057.021.000.1		021
1,8 D	05.83 - 08.87		31.058.022.000.1		022
Corolla Station Wagon ( E9 )					
1,3	12.87 - 12.89		31.126.022.000.1		022
	12.87 - 12.89		31.127.021.000.1		021
1,3 I	06.89 - 06.92		31.126.022.000.1		022
	06.89 - 06.92		31.127.021.000.1		021
1,6 XLI	11.89 - 06.92		31.126.022.000.1		022
	11.89 - 06.92		31.127.021.000.1		021
1,6 XLI 4x4	08.88 - 06.92		31.126.022.000.1		022
1,8 D	12.87 - 06.92		31.126.022.000.1		022
	12.87 - 06.92		31.127.021.000.1		021
Cressida ( X6 )					
2,0	05.81 - 03.85		31.051.011.000.1		011
2,2 D	09.80 - 07.84		31.051.011.000.1		011
Cressida (RX3)					
2,0	07.77 - 07.81		31.057.021.000.1		021
	07.77 - 07.81		31.051.011.000.1		011
Crown Station Wagon ( S1 )					
2,7	09.80 - 09.83		31.056.012.000.1		012
	09.80 - 09.83		31.051.011.000.1		011
Land Cruiser ( J6 )					
4,0 D	01.82 - 12.87		31.054.011.000.1		011
	11.84 - 12.87		31.053.011.000.1		011
4,2 Wagon 4,0 D Wagon	10.81 - 01.88		31.054.011.000.1		011
	11.84 - 01.88		31.053.011.000.1		011
Land Cruiser Hardtop ( J7 )					
3,0	05.93 - 05.96		31.054.011.000.1		011
Land Cruiser II. ( J7 )					
2,4 TD	10.85 - 05.96		31.054.011.000.1		011
Modell F bus (YR2)					
1,8 De luxe	11.82 - 08.84		31.051.011.000.1		011
2,0 Super	08.84 - 08.88		31.051.011.000.1		011
Tercel ( L1 , L2 )					
1,3	03.79 - 01.88		31.056.012.000.1		012
	03.79 - 01.88		31.057.021.000.1		021
Tercel (AL25)					
1,4 4WD	10.82 - 01.88		31.056.012.000.1		012
	10.82 - 01.88		31.056.012.000.1		012

## VOLKSWAGEN











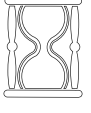























Caddy (14)					
1,5	08.82 - 07.83		31.020.005.000.1		005
1,6	08.83 - 07.92		31.020.005.000.1		005
1,6	08.82 - 07.90		31.020.005.000.1		005
1,8	08.85 - 07.92		31.020.005.000.1		005
Caddy II. box body (9K9)					
1,9 TDI	09.96 -		31.021.005.000.1		005
60 1,4 75 1,6 1,9 SDI	11.95 -		31.021.005.000.1		005
Corrado(531)					
1,8 16V	04.89 - 07.92		31.021.005.000.1	Шасси 50N000001-	005
	04.89 - 07.92		31.130.045.000.1	-Шасси 50M035000	045
	04.89 - 07.92		31.015.005.000.1	К суппорту	005
	04.89 - 07.92		31.144.026.000.1		026
1,8 G60	09.88 - 09.93		31.021.005.000.1	Шасси 50N000001-	005
	09.88 - 09.93		31.130.045.000.1	-Шасси 50M035000	045
	09.88 - 09.93		31.015.005.000.1	К суппорту	005
	09.88 - 09.93		31.144.026.000.1		026
2,0 i	04.93 - 12.95		31.021.005.000.1		005
	04.93 - 12.95		31.015.005.000.1	К суппорту	005
	04.93 - 12.95		31.144.026.000.1		026
2,0 i 16V	08.91 - 12.95		31.021.005.000.1		005
	08.91 - 12.95		31.015.005.000.1	К суппорту	005
	08.91 - 12.95		31.144.026.000.1		026
2,9 VR6	08.91 » 12.95		31.021.005.000.1		005
	08.91 - 12.95		31.015.005.000.1		005

# Таблица применяемости тормозных шлангов



		i	Код Дафми	Дополнительная информация	Тип №
--	--	---	-----------	---------------------------	-------

	08.91 - 12.95		31.157.019.000.1		019
<b>Derby (86)</b>					
0,9 1,1 1,3	02.77 - 09.81		31.009.005.000.1		005
	02.77 - 09.81		31.016.026.000.1		026
<b>Derby (86C)</b>					
1,0 1,1 1,3	10.81 - 12.84		31.009.005.000.1		005
	10.81 - 12.84		31.016.026.000.1		026
<b>Golf (17)</b>					
1,1	04.74 - 07.83		31.018.018.000.1	Барабаные тормоза	018
	04.74 - 07.83		31.020.005.000.1	скоба ATE	005
	04.74 - 07.83		31.105.005.000.1	скоба GIRLING	005
	04.74 - 10.78		31.144.026.000.1		026
	11.78 - 07.83		31.016.026.000.1		026
1,3	08.79 - 07.83		31.018.018.000.1	Барабаные тормоза	018
	08.79 - 07.83		31.020.005.000.1	скоба ATE	005
	08.79 - 07.83		31.105.005.000.1	скоба GIRLING	005
	08.79 - 07.83		31.016.026.000.1		026
1,5	08.77 - 07.83		31.018.018.000.1	Барабаные тормоза	018
	08.77 - 07.83		31.020.005.000.1	скоба ATE	005
	08.77 - 07.83		31.105.005.000.1	скоба GIRLING	005
	08.77 - 10.78		31.144.026.000.1		026
	11.78 - 07.83		31.016.026.000.1		026
1,5 D	08.76 - 07.80		31.020.005.000.1	скоба ATE	005
	08.76 - 07.80		31.105.005.000.1	скоба GIRLING	005
	08.76 - 10.78		31.144.026.000.1		026
	11.78 - 07.80		31.016.026.000.1		026
1,6	08.75 - 07.77		31.018.018.000.1		018
	08.75 - 07.77		31.144.026.000.1		026
1,6 D	08.80 - 07.83		31.020.005.000.1	скоба ATE	005
	08.80 - 07.83		31.105.005.000.1	скоба GIRLING	005
	08.80 - 07.83		31.016.026.000.1		026
1,6 GTI	08.76 - 07.82		31.020.005.000.1		005
	08.76 - 07.82		31.144.026.000.1		026
1,6 TD	03.82 - 07.83		31.020.005.000.1	скоба ATE	005
	03.82 - 07.83		31.105.005.000.1	скоба GIRLING	005
	03.82 - 07.83		31.016.026.000.1		026
1,8 GTI	08.82 - 12.83		31.020.005.000.1		005
	08.82 - 12.83		31.016.026.000.1		026
<b>Golf I. Convertible/roadster (155)</b>					
1,5	01.79 - 11.83		31.020.005.000.1	скоба ATE	005
	01.79 - 11.83		31.105.005.000.1	скоба GIRLING	005
	01.79 - 11.83		31.016.026.000.1		026
1,6	08.79 - 04.92		31.020.005.000.1		005
	08.79 » 04.92		31.016.026.000.1		026
1,8	08.82 - 04.93		31.020.005.000.1		005
	08.82 - 04.93		31.016.026.000.1		026
<b>Golf II.(19E)</b>					
1,0	11.83 - 10.91		31.020.005.000.1		005
	11.83 - 07.88		31.016.026.000.1		026
	08.88 - 10.91		31.144.026.000.1		026
1,3	08.83 - 06.87		31.020.005.000.1	К суппорту   Дисковые тормоза	005
	08.83 - 06.87		31.015.005.000.1		005
	08.83 - 06.87		31.016.026.000.1		026
1,3 KAT	06.86 - 12.92		31.020.005.000.1		005
	06.86 - 07.88		31.016.026.000.1		026
	08.88 - 12.92		31.144.026.000.1		026
1,6	08.83 - 12.92		31.020.005.000.1		005
	08.83 - 07.88		31.016.026.000.1		026
	08.88 - 12.92		31.144.026.000.1		026
1,6 D 1,6 TD	08.83 - 10.91		31.020.005.000.1		005
	08.83 - 07.88		31.016.026.000.1		026
	08.88 - 10.91		31.144.026.000.1		026
1,8	08.84 - 10.91		31.020.005.000.1		005
	08.84 - 07.88		31.016.026.000.1		026
	08.88 - 10.91		31.144.026.000.1		026
1,8 GTI	08.85 - 12.89		31.020.005.000.1	-Шасси 1GKW240000   -Шасси 1GKB075000	005
	08.85 - 12.89		31.015.005.000.1	К суппорту	005

		i	Код Дафми	Дополнительная информация	Тип №
1,8 GTI 16V	08.85 - 12.89		31.016.026.000.1		026
	02.86 - 10.91		31.020.005.000.1	-Шасси 1GKW240000   -Шасси 1GKB075000	005
	02.86 - 10.91		31.015.005.000.1	К суппорту	005
1,8 GTI G60	04.90 - 04.90		31.020.005.000.1		005
	04.90 - 04.90		31.130.045.000.1	С ABS	045
	04.90 - 04.90		31.015.005.000.1	К суппорту	005
1,8 GTI G60 Syncro	04.90 - 04.90		31.144.026.000.1		026
	08.88 - 07.91		31.020.005.000.1		005
	08.88 - 07.91		31.130.045.000.1	С ABS	045
1,8 GTI KAT	08.88 - 07.91		31.015.005.000.1	К суппорту	005
	08.88 - 07.91		31.144.026.000.1		026
	01.87 - 10.91		31.020.005.000.1	-Шасси 1GKW240000   -Шасси 1GKB075000	005
1,8 i KAT	01.87 - 10.91		31.015.005.000.1	К суппорту	005
	01.87 - 10.91		31.016.026.000.1		026
	08.87 - 10.91		31.020.005.000.1		005
1,8 i Syncro KAT	08.87 - 10.91		31.144.026.000.1		026
	08.87 - 08.87		31.020.005.000.1		005
	08.87 - 08.87		31.130.045.000.1	С ABS	045
1,8 Syncro	08.87 - 08.87		31.144.026.000.1		026
	02.86 - 07.91		31.020.005.000.1		005
	02.86 - 07.91		31.130.045.000.1	С ABS	045
Golf III. (1HX)	02.86 - 07.91		31.144.026.000.1		026
	10.91 - 08.97		31.021.005.000.1		005
	10.91 - 08.97		31.015.005.000.1	К суппорту	005
Golf III. Convertible/roadster (1E7)	10.91 - 08.97		31.157.019.000.1		019
	06.98 - 06.98		31.021.005.000.1		005
	06.98 - 06.98		31.015.005.000.1	К суппорту	005
Golf III. Variant (1HXO)	06.98 - 06.98		31.157.019.000.1		019
	04.93 - 04.99		31.021.005.000.1		005
	04.93 - 04.99		31.157.019.000.1		019
1,6 1,9 TDI	03.94 - 04.99		31.021.005.000.1		005
	03.94 - 04.99		31.157.019.000.1		019
	10.94 - 04.99		31.021.005.000.1		005
1,8 Syncro	10.94 - 04.99		31.157.019.000.1		019
	04.97 - 04.99		31.021.005.000.1		005
	04.97 - 04.99		31.157.019.000.1		019
1,9 SDI	07.95 - 04.99		31.021.005.000.1		005
	07.95 - 04.99		31.157.019.000.1		019
	08.95 - 04.99		31.021.005.000.1		005
2,0 Syncro	08.95 - 04.99		31.157.019.000.1		019
	10.94 - 04.99		31.021.005.000.1		005
	10.94 - 04.99		31.015.005.000.1	К суппорту	005
2,9 VR6 2,9 VR6 Syncro	10.94 - 04.99		31.157.019.000.1		019
	08.79 - 12.83		31.020.005.000.1	скоба ATE	005
	08.79 - 12.83		31.105.005.000.1	скоба GIRLING	005
Jetta (17)	08.79 - 12.83		31.144.026.000.1		026
	01.84 - 06.87		31.020.005.000.1		005
	01.84 - 06.87		31.016.026.000.1		026
1,3 KAT	06.87 - 12.91		31.020.005.000.1		005
	06.87 - 07.88		31.016.026.000.1		026
	08.88 - 12.91		31.144.026.000.1		026
1,6	03.86 - 03.86		31.020.005.000.1		005
	03.86 - 07.88		31.016.026.000.1		026
	08.88 - 08.88		31.144.026.000.1		026
1,6 D 1,6 TD	01.84 - 10.91		31.020.005.000.1		005
	01.84 - 07.88		31.016.026.000.1		026
	08.88 - 10.91		31.144.026.000.1		026
1,8	08.84 - 10.91		31.020.005.000.1		005
	08.84 - 07.88		31.016.026.000.1		026
	08.88 - 10.91		31.144.026.000.1		026
1,8 16V	08.86 - 10.91		31.020.005.000.1	-Шасси 1GKW240000   -Шасси 1GKB075000	005

# Таблица применяемости тормозных шлангов

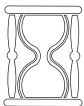

		i	Код Дафми	Дополнительная информация	Тип №
1,8 KAT	08.86 - 10.91	↙↘	31.015.005.000.1	К суппорту	005
	08.86 - 10.91	↙↘	31.144.026.000.1		026
	01.87 - 10.91	↙↘	31.020.005.000.1		005
1,8 Syncro	01.87 - 10.91	↙↘	31.015.005.000.1	К суппорту	005
	01.87 - 10.91	↙↘	31.144.026.000.1		026
1,8 Syncro	08.87 - 07.91	↙↘	31.020.005.000.1		005
08.87 - 07.91	↙↘	31.144.026.000.1			026
<b>LT-28 I. Bus (281-363)</b>					
2,0	04.75 - 09.83	↙↘	31.018.018.000.1		018
	04.75 - 09.83	↙↘	31.071.026.000.1		026
	04.75 - 09.83	↙↘	31.024.005.000.1		Шасси 28D007274-
2,4	12.82 - 07.92	↙↘	31.018.018.000.1		018
	12.82 - 07.92	↙↘	31.071.026.000.1		026
	12.82 - 07.92	↙↘	31.024.005.000.1		Шасси 28D007274-
2,4 D	01.79 - 06.96	↙↘	31.018.018.000.1		018
	01.79 - 06.96	↙↘	31.071.026.000.1		026
	01.79 - 06.96	↙↘	31.024.005.000.1		Шасси 28D007274-
2,4 i	08.89 - 06.96	↙↘	31.018.018.000.1		018
	08.89 - 06.96	↙↘	31.071.026.000.1		026
	08.89 - 06.96	↙↘	31.024.005.000.1		Шасси 28D007274-
2,4 TD	12.82 - 06.96	↙↘	31.018.018.000.1		018
	12.82 - 06.96	↙↘	31.071.026.000.1		026
	12.82 - 06.96	↙↘	31.024.005.000.1		Шасси 28D007274-
<b>LT-28-35 I. box body (281-363)</b>					
2,0	04.75 - 09.83	↙↘	31.018.018.000.1		018
	04.75 - 09.83	↙↘	31.071.026.000.1		026
	04.75 - 09.83	↙↘	31.024.005.000.1		Шасси 28D007274-
2,4	12.82 - 07.92	↙↘	31.018.018.000.1		018
	12.82 - 07.92	↙↘	31.071.026.000.1		026
	12.82 - 07.92	↙↘	31.024.005.000.1		Шасси 28D007274-
2,4 D	01.79 - 05.96	↙↘	31.018.018.000.1		018
	01.79 - 05.96	↙↘	31.071.026.000.1		026
	01.79 - 05.96	↙↘	31.024.005.000.1		Шасси 28D007274-
2,4 i	03.94 - 06.96	↙↘	31.071.026.000.1		026
	03.94 - 06.96	↙↘	31.024.005.000.1		Шасси 28D007274-
2,4 TD	02.86 - 05.96	↙↘	31.018.018.000.1		018
	02.86 - 05.96	↙↘	31.071.026.000.1		026
	02.86 - 05.96	↙↘	31.024.005.000.1		Шасси 28D007274-
2,7 D	11.75 - 01.80	↙↘	31.018.018.000.1		018
	11.75 - 01.80	↙↘	31.071.026.000.1		026
	11.75 - 01.80	↙↘	31.024.005.000.1		Шасси 28D007274-
<b>LT-28-35 Platform/Chassis (281-363)</b>					
2,0	04.75 - 09.83	↙↘	31.018.018.000.1		018
	04.75 - 09.83	↙↘	31.071.026.000.1		026
	04.75 - 09.83	↙↘	31.024.005.000.1		Шасси 28D007274-
2,4	12.82 - 07.92	↙↘	31.018.018.000.1		018
	12.82 - 07.92	↙↘	31.071.026.000.1		026
	12.82 - 07.92	↙↘	31.024.005.000.1		Шасси 28D007274-
2,4 D	12.78 - 06.96	↙↘	31.018.018.000.1		018
	12.78 - 06.96	↙↘	31.071.026.000.1		026
	12.78 - 06.96	↙↘	31.024.005.000.1		Шасси 28D007274-
2,4 i	03.94 - 06.96	↙↘	31.071.026.000.1		026
	03.94 - 06.96	↙↘	31.024.005.000.1		Шасси 28D007274-
2,4 TD	12.82 - 06.96	↙↘	31.018.018.000.1		018
	12.82 - 06.96	↙↘	31.071.026.000.1		026
	12.82 - 06.96	↙↘	31.024.005.000.1		Шасси 28D007274-
2,7 D	11.75 - 01.80	↙↘	31.018.018.000.1		018
	11.75 - 01.80	↙↘	31.071.026.000.1		026
	11.75 - 01.80	↙↘	31.024.005.000.1		Шасси 28D007274-
<b>LT-28-46 II. box body (2DXOAE)</b>					
2,3	05.96 -	↙↘	31.213.058.000.1	LT-46	058
	05.96 -	↓	31.213.058.000.1		058
	05.96 -	↙↘	31.213.058.000.1		LT-28/35
2,5 SDI	09.96 - 08.99	↙↘	31.213.058.000.1	LT-46	058
	09.96 - 08.99	↓	31.213.058.000.1		058
	09.96 - 08.99	↙↘	31.213.058.000.1		LT-28/35
2,5 TDI	05.96 -	↙↘	31.213.058.000.1		058

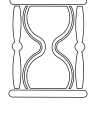







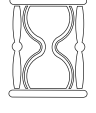

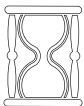

















































		i	Код Дафми	Дополнительная информация	Тип №
	05.96 -	↓	31.213.058.000.1	LT-46	058
	05.96 -	↙↘	31.213.058.000.1	LT-28/35	058
2,8 TDI	06.97 -	↙↘	31.213.058.000.1		058
	06.97 -	↓	31.213.058.000.1	LT-46	058
	06.97 -	↙↘	31.213.058.000.1	LT-28/35	058
<b>LT-28-46 II. Platform/Chassis (2DXOFE)</b>					
2,3 2,5 SDI 2,5 TDI	06.96 -	↙↘	31.213.058.000.1		058
	06.96 -	↓	31.213.058.000.1	LT-46	058
	06.96 -	↙↘	31.213.058.000.1	LT-28/35	058
2,8 TDI	06.97 -	↙↘	31.213.058.000.1		058
	06.97 -	↓	31.213.058.000.1	LT-46	058
	06.97 -	↙↘	31.213.058.000.1	LT-28/35	058
<b>LT-40-55 I. boxbody (291-512)</b>					
2,0	04.75 - 09.83	↙↘	31.071.026.000.1		026
	0475 - 09.83	↙↘	31.024.005.000.1	Шасси 28D007274-	005
2,4	12.82 - 07.92	↙↘	31.071.026.000.1		026
	12.82 - 07.92	↙↘	31.024.005.000.1	Шасси 28D007274-	005
2,4 4WD	12.82 - 07.92	↙↘	31.071.026.000.1		026
2,4	01.79 - 05.96	↙↘	31.071.026.000.1		026
	0179 - 05.96	↙↘	31.024.005.000.1	Шасси 28D007274-	005
2,4 D 4WD	0179 - 03.86	↙↘	31.071.026.000.1		026
2,4 i	01.93 - 06.96	↙↘	31.071.026.000.1		026
	01.93 - 06.96	↙↘	31.024.005.000.1	Шасси 28D007274-	005
2,4 TD	02.86 - 05.96	↙↘	31.071.026.000.1		026
	02.86 - 05.96	↙↘	31.024.005.000.1	Шасси 28D007274-	005
2,4 TD 4WD	0878 - 03.86	↙↘	31.071.026.000.1		026
<b>LT-40-55 I. Platform/Chassis</b>					
All models	04.75 - 06.96	↙↘	31.071.026.000.1		026
	04.75 - 06.96	↙↘	31.024.005.000.1	Шасси 28D007274-	005
<b>Passat (32/33)</b>					
All models	05.73 - 07.80	↙↘	31.020.005.000.1	скоба ATE	005
	05.73 - 07.80	↙↘	31.105.005.000.1	скоба GIRLING	005
	05.73 - 07.80	↙↘	31.016.026.000.1		026
1,5	07.73 - 12.75	↙↘	31.020.005.000.1	скоба ATE	005
	07.73 - 12.75	↙↘	31.105.005.000.1	скоба GIRLING	005
	07.73 - 12.75	↙↘	31.016.026.000.1		026
1,5 D	08.77 - 07.80	↙↘	31.020.005.000.1	скоба ATE	005
	08.77 - 07.80	↙↘	31.105.005.000.1	скоба GIRLING	005
	08.77 - 07.80	↙↘	31.016.026.000.1		026
1,6	08.75 - 07.80	↙↘	31.020.005.000.1	скоба ATE	005
	08.75 - 07.80	↙↘	31.105.005.000.1	скоба GIRLING	005
	08.75 - 07.80	↙↘	31.016.026.000.1		026
<b>Passat (32B)</b>					
1,3	08.80 - 07.86	↙↘	31.020.005.000.1	скоба ATE	005
	08.80 - 07.86	↙↘	31.105.005.000.1	скоба GIRLING	005
	08.80 - 07.86	↙↘	31.144.026.000.1		026
1,6	08.80 - 03.88	↙↘	31.020.005.000.1		005
	08.84 - 03.88	↙↘	31.016.026.000.1	Полностью автоматическая КПП	026
	08.84 - 03.88	↙↘	31.144.026.000.1	Ручная КПП	026
	08.84 - 03.88	↓	31.144.026.000.1	Полностью автоматическая КПП	026
1,6 D	08.80 - 03.88	↙↘	31.020.005.000.1		005
	08.84 - 03.88	↙↘	31.016.026.000.1	Полностью автоматическая КПП	026
	08.84 - 03.88	↙↘	31.144.026.000.1	Ручная КПП	026
	08.84 - 03.88	↓	31.144.026.000.1	Полностью автоматическая КПП	026
1,6 TD	04.82 - 03.88	↙↘	31.020.005.000.1	скоба ATE	005
	04.82 - 03.88	↙↘	31.105.005.000.1	скоба GIRLING	005
	08.84 - 03.88	↙↘	31.016.026.000.1	Полностью автоматическая КПП	026
	08.84 - 03.88	↙↘	31.144.026.000.1	Ручная КПП	026
	08.84 - 03.88	↓	31.144.026.000.1	Полностью автоматическая КПП	026
1,8	01.83 - 03.88	↙↘	31.020.005.000.1		005
	08.84 - 03.88	↙↘	31.016.026.000.1	Полностью автоматическая КПП	026
	08.84 - 03.88	↙↘	31.144.026.000.1	Ручная КПП	026
	08.84 - 03.88	↓	31.144.026.000.1	Полностью автоматическая КПП	026
1,9	01.81 - 07.83	↙↘	31.020.005.000.1	скоба ATE	005
	01.81 - 07.83	↙↘	31.105.005.000.1	скоба GIRLING	005
	01.81 - 07.83	↙↘	31.016.026.000.1		026
	01.81 - 07.83	↓	31.144.026.000.1		026



# Таблица применяемости тормозных шлангов











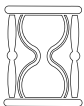





















































		i	Код Дафми	Дополнительная информация	Тип №
2,0	08.83 - 03.88	↗	31.020.005.000.1	скоба АТЕ	005
	08.83 - 03.88	↘	31.105.005.000.1	скоба GIRLING	005
	08.83 - 03.88	↙	31.016.026.000.1		026
	08.83 - 03.88	↘	31.144.026.000.1		026
2,2	01.85 - 03.88	↗	31.020.005.000.1		005
	01.85 - 03.88	↘	31.015.005.000.1	Без ABS	005
<b>Passat (351)</b>					
1,6	02.88 - 09.91	↗	31.130.045.000.1		045
	02.88 - 09.91	↘	31.016.026.000.1		026
1,6 TD	08.88 - 09.93	↗	31.130.045.000.1		045
	08.88 - 09.93	↘	31.016.026.000.1		026
1,6.	10.94 - 08.96	↗	31.130.045.000.1	К суппорту	045
	10.94 - 08.96	↘	31.015.005.000.1		005
	10.94 - 08.96	↘	31.144.026.000.1		026
1,8	02.88 - 08.96	↗	31.130.045.000.1	К суппорту	045
	02.88 - 08.96	↘	31.015.005.000.1		005
	02.88 - 10.93	↘	31.016.026.000.1		026
	10.93 - 08.96	↘	31.144.026.000.1		026
1,8 16V	04.88 - 12.89	↗	31.130.045.000.1	К суппорту	045
	04.88 - 12.89	↘	31.015.005.000.1		005
	04.88 - 12.89	↘	31.016.026.000.1		026
1,8 G60 Syncro	08.88 - 08.96	↗	31.130.045.000.1	К суппорту	045
	08.88 - 08.96	↘	31.015.005.000.1		005
	08.88 - 08.96	↘	31.016.026.000.1		026
1,9	05.89 - 10.93	↗	31.130.045.000.1		045
	05.89 - 10.93	↘	31.016.026.000.1		026
1,9 TD	03.91 - 08.96	↗	31.130.045.000.1	К суппорту	045
	03.91 - 08.96	↘	31.015.005.000.1		005
	03.91 - 09.93	↘	31.016.026.000.1		026
	10.93 - 08.96	↘	31.144.026.000.1		026
1,9 TDI	10.93 - 08.96	↗	31.130.045.000.1	К суппорту	045
	10.93 - 08.96	↘	31.015.005.000.1		005
	10.93 - 08.96	↘	31.144.026.000.1		026
2,0	02.90 - 08.96	↗	31.130.045.000.1	К суппорту	045
	02.90 - 08.96	↘	31.015.005.000.1		005
	02.90 - 09.93	↘	31.016.026.000.1		026
	10.93 - 08.96	↘	31.144.026.000.1		026
2,0 16V	01.94 - 08.96	↗	31.130.045.000.1	К суппорту	045
	01.94 - 08.96	↘	31.015.005.000.1		005
	01.94 - 08.96	↘	31.144.026.000.1		026
2,0 16V GT	08.88 - 09.93	↗	31.130.045.000.1	К суппорту	045
	08.88 - 09.93	↘	31.015.005.000.1		005
	08.88 - 09.93	↘	31.016.026.000.1		026
2,0 Syncro	10.90 - 08.96	↗	31.130.045.000.1	К суппорту	045
	10.90 - 08.96	↘	31.015.005.000.1		005
	10.90 - 08.96	↘	31.144.026.000.1		026
2,8 VR6	06.91 - 08.96	↗	31.130.045.000.1	К суппорту	045
	06.91 - 08.96	↘	31.015.005.000.1		005
	06.91 - 09.93	↘	31.016.026.000.1		026
	10.93 - 08.96	↘	31.144.026.000.1		026
<b>Passat (3B2)</b>					
1,8 20V Syncro 1,9 TDI Syncro	10.96 -	↘	31.015.005.000.1	Дисковые тормоза I - Шасси 3AV300000	005
	10.96 -	↘	31.144.026.000.1	Барабанные тормоза I - Шасси 3AV300000	026
2,3 VR5 Syncro	10.97 -	↘	31.015.005.000.1	Дисковые тормоза I - Шасси 3AV300000	005
	10.97 -	↘	31.144.026.000.1	Барабанные тормоза I - Шасси 3AV300000	026
2,8 30V 2,8 30V Syncro	08.96 -	↘	31.015.005.000.1	Дисковые тормоза I - Шасси 3AV300000	005
	08.96 -	↘	31.144.026.000.1	Барабанные тормоза I - Шасси 3AV300000	026
<b>Passat sedan (32B)</b>					
1,6 1,8 1,6 TD	01.85 - 03.88	↗	31.020.005.000.1	Полностью автоматическая КПП Ручная КПП	005
	01.85 - 03.88	↘	31.016.026.000.1		026
	01.85 - 03.88	↘	31.144.026.000.1		026
	01.85 - 03.88	↘	31.144.026.000.1		Полностью автоматическая КПП
2,2	01.85 - 03.88	↗	31.020.005.000.1		005
	01.85 - 03.88	↘	31.016.026.000.1		026
	01.85 - 03.88	↘	31.144.026.000.1		026
<b>Passat Variant (32/33)</b>					
All models	05.73 - 07.80	↗	31.020.005.000.1	скоба АТЕ	005

		i	Код Дафми	Дополнительная информация	Тип №
	05.73 - 07.80 05.73 - 07.80	 	31.105.005.000.1 31.016.026.000.1	скоба GIRLING	005 026
<b>Passat Variant (32B)</b>					
1,3	08.80 - 07.86		31.020.005.000.1	скоба ATE	005
	08.80 - 07.86		31.105.005.000.1	скоба GIRLING	005
	08.80 - 07.86		31.016.026.000.1		026
	08.80 - 07.86		31.144.026.000.1		026
1,6	08.80 - 03.88		31.020.005.000.1		005
	08.80 - 03.88		31.016.026.000.1		026
	08.80 - 03.88		31.144.026.000.1		026
1,6 D	08.80 - 03.88		31.020.005.000.1	скоба ATE	005
	08.80 - 03.88		31.105.005.000.1	скоба GIRLING	005
	08.80 - 03.88		31.016.026.000.1		026
	08.80 - 03.88		31.144.026.000.1		026
1,6 TD	04.82 - 03.88		31.020.005.000.1	скоба ATE	005
	04.82 - 03.88		31.105.005.000.1	скоба GIRLING	005
	04.82 - 03.88		31.016.026.000.1		026
	04.82 - 03.88		31.144.026.000.1		026
1,8	01.83 - 03.88		31.020.005.000.1	скоба ATE	005
	01.83 - 03.88		31.105.005.000.1	скоба GIRLING	005
	01.83 - 03.88		31.016.026.000.1		026
	01.83 - 03.88		31.144.026.000.1		026
1,9	01.81 - 07.83		31.020.005.000.1	скоба ATE	005
	01.81 - 07.83		31.105.005.000.1	скоба GIRLING	005
	01.81 - 07.83		31.016.026.000.1		026
	01.81 - 07.83		31.144.026.000.1		026
2,0	08.83 - 03.88		31.020.005.000.1	скоба ATE	005
	08.83 - 03.88		31.105.005.000.1	скоба GIRLING	005
	08.83 - 03.88		31.016.026.000.1		026
	08.83 - 03.88		31.144.026.000.1		026
2,2	08.85 - 03.88		31.020.005.000.1		005
	08.85 - 03.88		31.016.026.000.1		026
	08.85 - 03.88		31.144.026.000.1		026
<b>Polo (6N1)</b>					
120 1,6 16V GTI	09.98 - 10.99		31.015.005.000.1		005
<b>Polo (86)</b>					
0,9 1,1	09.75 - 09.81		31.009.005.000.1		005
	09.75 - 09.81		31.016.026.000.1		026
1,3	12.76 - 09.81		31.009.005.000.1		005
	12.76 - 09.81		31.016.026.000.1		026
<b>Polo box body (86CF)</b>					
1,0, 1,3, 1,40	04.93 -		31.009.005.000.1		005
	04.93 -		31.016.026.000.1		026
<b>Polo Classic (86C)</b>					
All models	01.85 - 12.88		31.009.005.000.1		005
	01.85 - 12.88		31.016.026.000.1		026
<b>Polo Coupe (86C)</b>					
All models	10.81 - 01.92		31.009.005.000.1		005
	10.81 - 01.92		31.016.026.000.1		026
<b>Polo Variant (6KV5)</b>					
1,4	05.97 -		31.021.005.000.1		005
1,6	05.97 -		31.021.005.000.1		005
1,7 SDI 1,9 SDI 1,9TDI	05.97 -		31.021.005.000.1		005
1,8	05.97 -		31.021.005.000.1		005
<b>Santana (32B)</b>					
1,3	08.81 - 07.83		31.020.005.000.1		005
	08.81 - 07.83		31.144.026.000.1		026
1,6 1,6 D 1,6 TD	08.81 - 12.84		31.020.005.000.1		005
	08.81 - 12.84		31.016.026.000.1	Полностью автоматическая КПП	026
	08.81 - 12.84		31.144.026.000.1	Ручная КПП	026
	08.81 - 12.84		31.144.026.000.1	Полностью автоматическая КПП	026
1,8	01.83 - 12.84		31.020.005.000.1		005
	01.83 - 12.84		31.016.026.000.1	Полностью автоматическая КПП	026
	01.83 - 12.84		31.144.026.000.1	Ручная КПП	026
	01.83 - 12.84		31.144.026.000.1	Полностью автоматическая КПП	026
1,9	08.81 - 07.83		31.020.005.000.1		005
	08.81 - 07.83		31.016.026.000.1	Полностью автоматическая КПП	026

# Таблица применяемости тормозных шлангов



		i	Код Дафми	Дополнительная информация	Тип №
2,0	08.81 - 07.83		31.144.026.000.1	Ручная КПП	026
	08.81 - 07.83		31.144.026.000.1	Полностью автоматическая КПП	026
	08.83 - 12.84		31.020.005.000.1	Полностью автоматическая КПП	005
	08.83 - 12.84		31.016.026.000.1	Полностью автоматическая КПП	026
	08.83 - 12.84		31.144.026.000.1	Ручная КПП	026
08.83 - 12.84		31.144.026.000.1	Полностью автоматическая КПП	026	
<b>Scirocco (53)</b>					
All models	11.78 - 07.80		31.020.005.000.1	скоба ATE	005
	11.78 - 07.80		31.105.005.000.1	скоба GIRLING	005
	11.78 - 07.80		31.144.026.000.1		026
<b>Scirocco (53B)</b>					
All models	08.80 - 07.92		31.020.005.000.1		005
	08.80 - 07.92		31.016.026.000.1		026
<b>Transporter box body (70 XA)</b>					
All models	07.90 -		31.133.045.000.1	-Шасси 70T199999	045
	07.90 -		31.015.005.000.1	К суппорту	005
	07.90 -		31.144.026.000.1		026
<b>Transporter II.</b>					
1,6	08.67 - 04.79		31.018.018.000.1		018
1,7	08.71 - 10.73		31.018.018.000.1		018
1,8	11.73 - 07.75		31.018.018.000.1		018
<b>Transporter III.</b>					
1,6	05.79 - 12.82		31.070.026.000.1		026
	05.79 - 12.82		31.016.026.000.1		026
1,6 D	01.81 - 07.85		31.070.026.000.1	Неподвижная скоба Скоба I-го типа	026
	01 - 81 - 07.87		31.016.026.000.1		026
	08.85 - 07.87		31.018.018.000.1		018
	08.85 - 07.87		31.071.026.000.1		026
1,6 TD	08.84 - 07.85		31.070.026.000.1	Неподвижная скоба Скоба I-го типа	026
	08.84 - 07.92		31.016.026.000.1		026
	08.85 - 07.92		31.018.018.000.1		018
	08.85 - 07.92		31.071.026.000.1		026
1,6 TD Syncro	03.86 - 07.92		31.071.026.000.1		026
	03.86 - 07.92		31.016.026.000.1		026
1,6 2,0 2,0 i	05.79 - 12.82		31.070.026.000.1		026
	05.79 - 12.82		31.016.026.000.1		026
1,7	10.86 - 07.92		31.018.018.000.1	Неподвижная скоба Скоба I-го типа	018
	10.86 - 07.92		31.071.026.000.1		026
	10.86 - 07.92		31.016.026.000.1		026
1,9	08.82 - 07.85		31.070.026.000.1	Неподвижная скоба   -Шасси 24G200000 Скоба I-го типа	026
	08.82 - 07.92		31.016.026.000.1		026
	08.85 - 07.92		31.018.018.000.1		018
	08.85 - 07.92		31.071.026.000.1		026
1,9 Syncro	02.85 - 07.92		31.071.026.000.1		026
	02.85 - 07.92		31.016.026.000.1		026
2,0 2,0 i	05.79 -		31.070.026.000.1		026
	05.79 -		31.016.026.000.1		026
2,1	10.86 - 07.92		31.018.018.000.1	Неподвижная скоба   -Шасси 24G200000 Скоба I-го типа	018
	10.86 - 07.92		31.071.026.000.1		026
	10.86 - 07.92		31.016.026.000.1		026
2,1 i	07.89 - 07.92		31.018.018.000.1	Неподвижная скоба Скоба I-го типа	018
	07.89 - 07.92		31.071.026.000.1		026
	07.89 - 07.92		31.016.026.000.1		026
2,1 Syncro	10.86 - 07.92		31.071.026.000.1		026
	10.86 - 07.92		31.016.026.000.1		026
2,1 2,1 i	08.85 -		31.071.026.000.1	Скоба I-го типа	026
	08.85 -		31.016.026.000.1		026
<b>Transporter IV.</b>					
1,8	12.90 -		31.133.045.000.1		045
	12.90 -		31.144.026.000.1		026
1,9 TD	10.92 -		31.133.045.000.1	К суппорту	045
	10.92 -		31.015.005.000.1		005
	10.92 -		31.144.026.000.1		026
2,0 2,5 1,9 D 2,4 D	09.90 -		31.133.045.000.1	К суппорту	045
	09.90 -		31.015.005.000.1		005
	09.90 -		31.144.026.000.1		026
2,5 TDI	09.95 - 12.96		31.133.045.000.1		045

		i	Код Дафми	Дополнительная информация	Тип №
---	---	---	-----------	---------------------------	-------











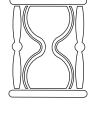































	09.95 - 12.96 09.95 - 12.96	↖↗ ↖↗	31.015.005.000.1 31.144.026.000.1	К суппорту	005 026
2,8	11.95 - 11.95 - 11.95 -	↖↗ ↖↗ ↖↗	31.133.045.000.1 31.015.005.000.1 31.144.026.000.1	К суппорту	045 005 026
<b>Transporter IV.(70 XB, 70 XC, 7DB, 7DW)</b>					
1,8	12.90 - 07.92 12.90 - 07.92	↖↗ ↖↗	31.133.045.000.1 31.144.026.000.1		045 026
2,0 2,5 1,9 D 2,4 D	09.90 - 09.90 - 09.90 -	↖↗ ↖↗ ↖↗	31.133.045.000.1 31.015.005.000.1 31.144.026.000.1	-СМ.70Т1 99999 К суппорту	045 005 026
2,5 Syncro 2,4 D Syncro 1,9 TD	10.92 - 10.92 - 10.92 -	↖↗ ↖↗ ↖↗	31.133.045.000.1 31.015.005.000.1 31.144.026.000.1	-Шасси 70Т1 99999 К суппорту	045 005 026
2,5 TDI (7DW)	05.98 - 05.98 -	↖↗ ↖↗	31.015.005.000.1 31.144.026.000.1	К суппорту	005 026
2,8 2,5 TDi	09.95 - 09.95 - 09.95 -	↖↗ ↖↗ ↖↗	31.133.045.000.1 31.015.005.000.1 31.144.026.000.1	-С.70Т1 99999 К суппорту	045 005 026
<b>Transporter Platform/Chassis (70 XD)</b>					
All models	07.90 - 07.90 - 07.90 -	↖↗ ↖↗ ↖↗	31.133.045.000.1 31.015.005.000.1 31.144.026.000.1	-Шасси 70Т199999 К суппорту	045 005 026
<b>Vento (1HX0)</b>					
All models	11.91 - 09.98 11.91 - 09.98 11.91 - 09.98	↖↗ ↖↗ ↖↗	31.021.005.000.1 31.015.005.000.1 31.157.019.000.1	К суппорту	005 005 019

## VOLVO

<b>240</b>					
2,0	08.80 - 07.85 08.74 - 07.85	↖↗ ↖↗	31.012.026.000.1 31.068.005.000.1	Шасси 471318-1 Без ABS	026 005
2,1	08.79 - 07.84 08.74 - 07.84	↖↗ ↖↗	31.012.026.000.1 31.068.005.000.1	Шасси 471318-1 Без ABS	026 005
2,1 Turbo	08.80 - 07.84 08.80 - 07.84	↖↗ ↖↗	31.012.026.000.1 31.068.005.000.1	Шасси 471318-1 Без ABS	026 005
2,3	08.80 - 07.93 08 - 80 - 07.93	↖↗ ↖↗	31.012.026.000.1 31.068.005.000.1	Шасси CNH471318-1 С ABS	026 005
2,4 D	08.78 - 08.93 08.78 - 07.85 08.87 - 08.93	↖↗ ↖↗ ↖↗	31.012.026.000.1 31.068.005.000.1 31.068.005.000.1	Без ABS Шасси CNH471318-1 С ABS	026 005 005
2,7 GLT 6	08.79 - 07.80	↖↗	31.012.026.000.1		026
<b>260</b>					
2,7	01.79 - 07.82	↖↗	31.012.026.000.1		026
2,8	08.80 - 07.82	↖↗	31.012.026.000.1		026
<b>260 Estate</b>					
2,8	08.80 - 07.82	↖↗	31.012.026.000.1		026
<b>340-360</b>					
1,4	08.75 - 12.88	↓	31.060.026.000.1		026
1,6 D	08.84 - 07.91	↓	31.060.026.000.1		026
1,7	08.85 - 07.91	↓	31.060.026.000.1		026
2,0	08.82 - 07.90	↓	31.060.026.000.1		026
<b>440 K-460 L</b>					
1,6 1,7	07.93 - 09.88 - 12.96 10.91 -	↖↗ ↖↗ ↖↗	31.102.005.000.1 31.100.005.000.1 31.101.005.000.1	С ABS	005 005 005
1,7 Turbo	08.88 - 12.96 08.88 - 12.96	↖↗ ↖↗	31.100.005.000.1 31.101.005.000.1	Барабанные тормоза	005 005
1,8	08.91 - 12.96 08.91 - 12.96	↖↗ ↖↗	31.100.005.000.1 31.101.005.000.1	Барабанные тормоза	005 005
1,9 TD	07.94 - 12.96 07.94 - 12.96 07.94 - 12.96	↖↗ ↖↗ ↖↗	31.100.005.000.1 31.101.005.000.1 31.102.005.000.1	Дисковые/Барабанные тормоза	005 005 005
2,0	08.92 - 12.96 08.92 - 12.96	↖↗ ↖↗	31.100.005.000.1 31.101.005.000.1	Барабанные тормоза	005 005
<b>480 E</b>					
1,7	04.86 - 07.90	↖↗	31.100.005.000.1		005

# Таблица применяемости тормозных шлангов



		i	Код Дафми	Дополнительная информация	Тип №
1,7 Turbo	04.86 - 07.90		31.102.005.000.1	-СКЕJС522771   Без ABS	005
	08.87 -		31.102.005.000.1	С ABS	005
2,0	08.87 - 07.96		31.100.005.000.1	С ABS	005
	08.87 - 07.96		31.102.005.000.1	-Шасси JС522771   Без ABS	005
740	08.92 - 09.95		31.100.005.000.1		005
	08.92 - 09.95		31.102.005.000.1	С ABS	005
All models	08.83 - 07.92		31.148.005.000.1		005
	08.83 - 07.92		31.173.005.000.1		005
760	08.82 - 07.85		31.148.005.000.1		005
	08.82 - 07.85		31.173.005.000.1		005
2,4 TD	02.82 -		31.148.005.000.1	Без ABS	005
	08.82 - 07.87		31.173.005.000.1		005
2,4 TD Interc.	09.85 -		31.068.005.000.1	С ABS	005
	02.82 -		31.148.005.000.1	Без ABS	005
2,8	08.87 - 07.92		31.173.005.000.1		005
	09.85 -		31.068.005.000.1	С ABS	005
760 Kombi	02.82 -		31.148.005.000.1	Без ABS	005
	08.81 - 07.90		31.173.005.000.1		005
2,4 TD Interc.	09.85 -		31.068.005.000.1	С ABS	005
	08.87 » 07.92		31.068.005.000.1	С ABS	005
780 Bertone	08.87 - 07.92		31.173.005.000.1		005
	05.86 - 08.91		31.068.005.000.1	С ABS	005
2,9	05.86 - 08.91		31.173.005.000.1		005
	08.86 - 07.90		31.068.005.000.1		005
850 (LS)	08.86 - 07.90		31.148.005.000.1		005
	08.86 - 07.90		31.148.005.000.1		005
All models	06.91 - 12.96		31.148.005.000.1		005
	06.91 - 12.96		31.010.026.000.1		026
850 Estate (LW)	02.93 - 12.96		31.148.005.000.1		005
	02.93 - 12.96		31.010.026.000.1		026
940	08.88 - 12.94		31.148.005.000.1		005
	08.88 - 12.94		31.068.005.000.1		005
940 Kombi	01.92 - 07.94		31.148.005.000.1		005
	01.92 - 07.94		31.068.005.000.1		005
2,0 Turbo	01.91 - 07.95		31.148.005.000.1		005
	01.91 - 07.95		31.068.005.000.1		005
2,3	08.90 - 12.94		31.148.005.000.1		005
	08.90 - 12.94		31.068.005.000.1		005
2,3 16V	08.90 - 07.91		31.148.005.000.1		005
	08.90 - 07.91		31.068.005.000.1		005
2,3 Turbo	08.90 - 07.94		31.148.005.000.1		005
	08.90 - 07.94		31.068.005.000.1		005
2,4 TD	08.90 -		31.148.005.000.1		005
	08.90 -		31.068.005.000.1		005
940 MK II.	08.94 - 10.98		31.148.005.000.1		005
	08.94 - 10.98		31.068.005.000.1		005
960	09.91 - 07.94		31.148.005.000.1		005
	09.91 - 08.93		31.068.005.000.1		005
2,9	08.90 - 07.94		31.148.005.000.1		005
	08.90 - 08.93		31.068.005.000.1		005
960 MK II.	08.94 - 12.96		31.148.005.000.1		005
	08.94 - 12.96		31.068.005.000.1		005
2,5 24V	08.95 - 12.96		31.148.005.000.1		005
	08.95 - 12.96		31.068.005.000.1		005
S 70	01.97 -		31.148.005.000.1		005
	01.97 -		31.148.005.000.1		005

		i	Код Дафми	Дополнительная информация	Тип №
	01.97 -		31.010.026.000.1		026
<b>V 70</b>					
All models	01.97 - 03.00		31.148.005.000.1		005
	01.97 - 03.00		31.010.026.000.1		026
<b>ВАЗ</b>					
<b>2101-2107</b>					
	01.70 -		31.185.055.000.1		055
	01.70 -		31.186.006.000.1		006
<b>2108-2109</b>					
	01.86 -		31.187.055.000.1		055
	01.86 -		31.188.006.000.1		006
<b>2121</b>					
	12.76 -		31.189.055.000.1	верхний	055
	12.76 -		31.190.006.000.1	нижний	006
<b>ЗАЗ</b>					
<b>1102</b>					
	00.87 - 12.03		31.191.055.000.1		055
<b>ГАЗ</b>					
<b>ГАЗ - 3302</b>					
	-		31.192.019.000.1		019
<b>ГАЗ - 3310</b>					
	-		31.192.019.000.1		019

**Тип 1**

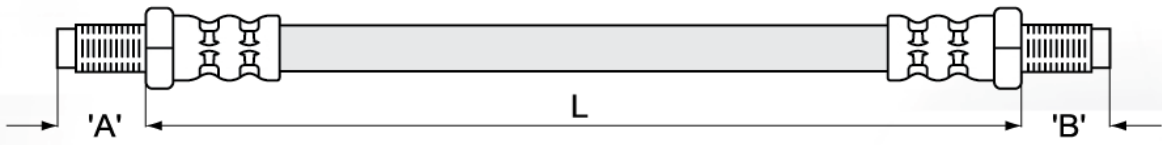

Код ДАФМИ	Длина (мм)	Фитинг 'А'		Фитинг 'В'		Примечания
		Резьба	Размер (мм)	Резьба	Размер (мм)	
31.026.001.000.1	334,0	M10x1	23,0	M10x1	15,0	Рез. манжета
31.039.001.000.1	377,0	M10x1	23,0	M10x1	14,0	Рез. муфта; рез. втулка
31.040.001.000.1	272,0	M10x1	23,0	M10x1	14,0	Рез. муфта
31.041.001.000.1	389,0	M10x1	23,0	M10x1	15,8	Рез. муфта; манжета защитная
31.104.001.000.1	182,0	M10x1	23,0	M10x1	14,0	
31.134.001.000.1	455,0	M10x1	23,0	M10x1	14,0	Армирован.; рез. амортизатор; рез. втулка
31.143.001.000.1	409,0	M10x1	23,0	M10x1	14,0	Рез. муфта; рез. втулка; армирован

**Тип 2**

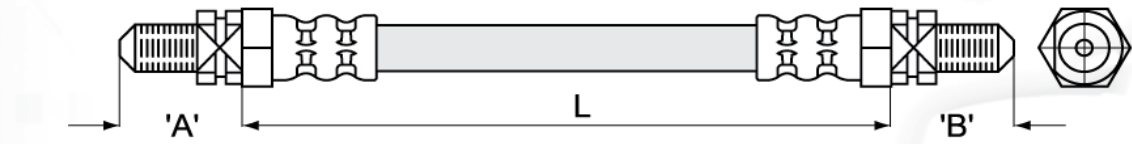

Код ДАФМИ	Длина (мм)	Фитинг 'А'		Фитинг 'В'		Примечания
		Резьба	Размер (мм)	Резьба	Размер (мм)	
31.038.002.000.1	291,0	M10x1	24,0	M10x1	24,0	
31.103.002.000.1	295,0	M10x1	24,0	M10x1	24,0	
31.153.002.000.1	295,0	M10x1	24,0	M10x1	24,0	Рез. муфта

**Тип 3**

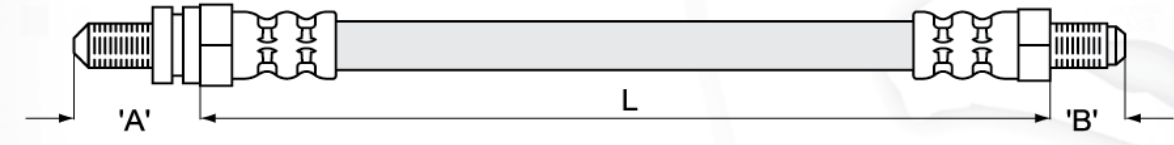

Код ДАФМИ	Длина (мм)	Фитинг 'А'		Фитинг 'В'		Примечания
		Резьба	Размер (мм)	Резьба	Размер (мм)	
31.079.003.000.1	314,0	M10x1	24,0	M10x1	15,0	

**Тип 4**

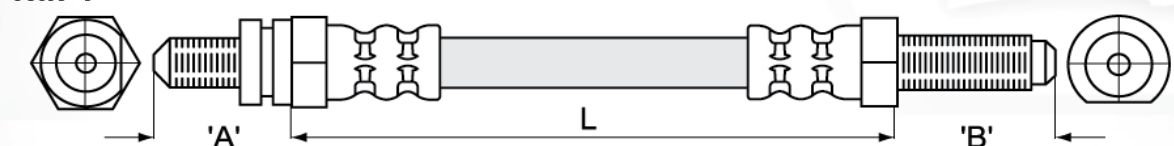

Код ДАФМИ	Длина (мм)	Фитинг 'А'		Фитинг 'В'		Примечания
		Резьба	Размер (мм)	Резьба	Размер (мм)	
31.036.004.000.1	253,0	M10x1	24,0	M10x1	28,0	Рез. амортизатор; манжета
31.037.004.000.1	228,0	M10x1	24,0	M10x1	28,0	Рез. амортизатор

**Тип 5**

Код ДАФМИ	Длина (мм)	Фитинг 'А'		Фитинг 'В'		Примечания
		Резьба	Размер (мм)	Резьба	Размер (мм)	
31.005.005.000.1	217,0	M10x1 (внутр.)	10,5	M10x1	14,0	Рез. муфта
31.006.005.000.1	285,0	M10x1 (внутр.)	10,5	M10x1	14,0	
31.007.005.000.1	366,0	M10x1 (внутр.)	10,5	M10x1	14,0	
31.008.005.000.1	421,0	M10x1 (внутр.)	10,5	M10x1	14,0	
31.009.005.000.1	294,0	M10x1 (внутр.)	10,5	M10x1	14,0	Рез. амортизатор
31.015.005.000.1	160,0	M10x1 (внутр.)	10,5	M10x1	14,0	
31.020.005.000.1	315,0	M10x1 (внутр.)	11,5	M10x1	15,0	Рез. амортизатор x 2; муфта x 2
31.024.005.000.1	366,0	M10x1 (внутр.)	10,5	M10x1	14,0	Рез. амортизатор
31.025.005.000.1	345,0	M10x1 (внутр.)	11,0	M10x1	14,0	
31.048.005.000.1	425,0	M10x1 (внутр.)	11,5	M10x1	15,0	Рез. муфта; манжета защитная
31.068.005.000.1	305,0	M10x1 (внутр.)	11,5	M10x1	15,0	Манжета защитная
31.100.005.000.1	461,0	M10x1 (внутр.)	10,5	M10x1	14,0	Рез. втулка
31.101.005.000.1	384,0	M10x1 (внутр.)	10,5	M10x1	14,0	Рез. муфта
31.102.005.000.1	290,0	M10x1 (внутр.)	10,5	M10x1	14,0	Рез. муфта
31.105.005.000.1	267,0	M10x1 (внутр.)	10,5	M10x1 (лев.)	14,0	Рез. амортизатор; фитинг 'В' с лев. резьбой
31.142.005.000.1	203,0	M10x1 (внутр.)	10,5	M10x1	14,0	
31.148.005.000.1	339,0	M10x1 (внутр.)	10,5	M10x1	14,0	Рез. амортизатор
31.161.005.000.1	425,0	M10x1 (внутр.)	10,5	M10x1	14,0	Рез. муфта; рез. амортизатор
31.164.005.000.1	334,0	M10x1 (внутр.)	10,5	M10x1	14,0	Рез. муфта
31.173.005.000.1	307,0	M10x1 (внутр.)	10,5	M10x1	14,0	Рез. амортизатор
31.187.005.000.1	303,0	M10x1,25 (внутр.)	19,0	M10x1,25	14,9	Муфта
31.193.005.000.1	182,0	M10x1,25 (внутр.)	19,0	M10x1,25	17,0	

**Тип 6**

Код ДАФМИ	Длина (мм)	Фитинг 'А'		Фитинг 'В'		Примечания
		Резьба	Размер (мм)	Резьба	Размер (мм)	
31.019.006.000.1	338,0	M10x1 (внутр.)	10,5	M10x1	14,0	Рез. амортизатор
31.141.006.000.1	430,0	M8 (внутр.)	21,0	M10x1	14,0	Рез. амортизатор
31.186.006.000.1	262,0	M10x1,25 (внутр.)	18,0	M10x1,25	17,0	
31.191.006.000.1	280,0	M10x1,25 (внутр.)	19,0	M10x1,25	22,0	

**Тип 7**

Код ДАФМИ	Длина (мм)	Фитинг 'А'		Фитинг 'В'		Примечания
		Резьба	Размер (мм)	Резьба	Размер (мм)	
31.049.007.000.1	418,0	M10x1 (внутр.)	9,5	M10x1	14,0	Рез. муфта; рез. амортизатор; фикс. клипса
31.084.007.000.1	329,0	M10x1 (внутр.)	9,5	M10x1	14,0	Рез. муфта; армирован
31.086.007.000.1	408,0	M10x1 (внутр.)	9,5	M10x1	14,0	Рез. амортизатор
31.095.007.000.1	361,0	M10x1 (внутр.)	9,5	M10x1	14,0	Рез. втулка; рез. амортизатор; фикс. клипса
31.096.007.000.1	443,0	M10x1 (внутр.)	9,5	M10x1	14,0	Рез. муфта; фикс. клипса
31.097.007.000.1	390,0	M10x1 (внутр.)	9,5	M10x1	14,0	Рез. муфта; рез. амортизатор; фикс. клипса
31.098.007.000.1	442,0	M10x1 (внутр.)	9,5	M10x1	14,0	Рез. муфта; рез. амортизатор
31.099.007.000.1	437,0	M10x1 (внутр.)	9,5	M10x1	14,0	Рез. муфта; рез. амортизатор; фикс. клипса



**Тип 8**

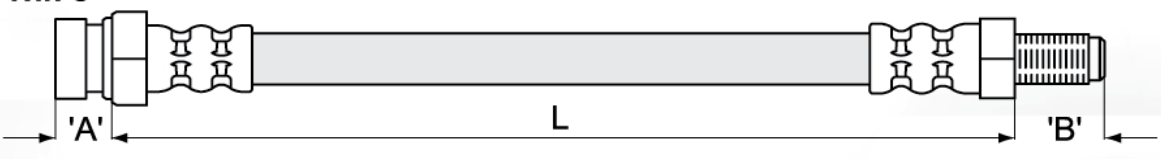

Код ДАФМИ	Длина (мм)	Фитинг 'А'		Фитинг 'В'		Примечания
		Резьба	Размер (мм)	Резьба	Размер (мм)	
31.014.008.000.1	268,0	M10x1 (внутр.)	9,5	M10x1	14,0	
31.043.008.000.1	384,0	M10x1 (внутр.)	9,5	M10x1	14,0	Рез. муфта
31.085.008.000.1	332,0	M10x1 (внутр.)	9,5	M10x1	14,0	Рез. муфта; рез. амортизатор
31.087.008.000.1	236,0	M10x1 (внутр.)	9,5	M10x1	14,0	Армирован
31.128.008.000.1	352,0	M10x1 (внутр.)	9,5	M10x1	14,0	
31.176.008.000.1	411,0	M10x1 (внутр.)	9,5	M10x1	14,0	Рез. муфта; рез. амортизатор
31.178.008.000.1	366,0	M10x1 (внутр.)	9,5	M10x1	14,0	Рез. муфта
31.179.008.000.1	366,0	M10x1 (внутр.)	9,5	M10x1	14,0	Рез. муфта ; фикс. клипса
31.180.008.000.1	563,0	M10x1 (внутр.)	9,5	M10x1	14,0	Рез. втулка; фикс. клипса
31.181.008.000.1	383,0	M10x1 (внутр.)	9,5	M10x1	14,0	Рез. втулка
31.182.008.000.1	386,0	M10x1 (внутр.)	9,5	M10x1	14,0	Рез. втулка; рез. амортизатор; фикс. клипса
31.205.008.000.1	352,0	M10x1 (внутр.)	9,5	M10x1	14,0	

**Тип 9**

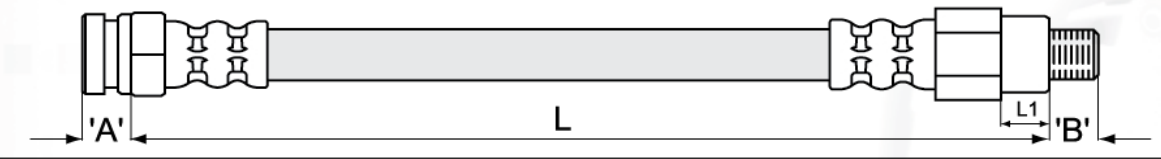

Код ДАФМИ	Длина (мм)	Фитинг 'А'		Фитинг 'В'		Примечания
		Резьба	Размер (мм)	Резьба	Размер (мм)	
31.013.009.000.1	410,0	3/8" (внутр.)	9,5	3/8"	12,0	L1=17,5

**Тип 10**

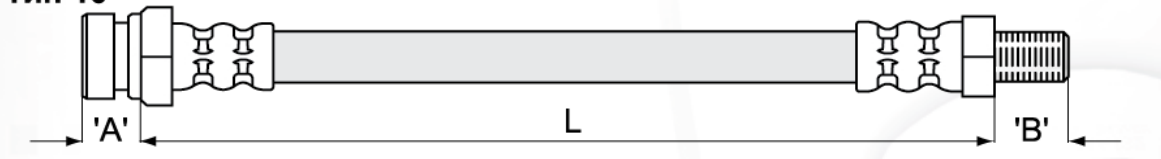

Код ДАФМИ	Длина (мм)	Фитинг 'А'		Фитинг 'В'		Примечания
		Резьба	Размер (мм)	Резьба	Размер (мм)	
31.001.010.000.1	228,0	M10x1 (внутр.)	10,0	M10x1	12,0	
31.064.010.000.1	203,0	M10x1 (внутр.)	9,5	M10x1	14,0	
31.065.010.000.1	235,0	M10x1 (внутр.)	9,5	M10x1	14,0	
31.066.010.000.1	184,0	M10x1 (внутр.)	9,5	M10x1	14,0	
31.093.010.000.1	435,0	M8 (внутр.)	10,0	M10x1	14,0	Рез. амортизатор
31.204.010.000.1	466,0	3/8"-24 (внутр.) 5/8"-18 (внеш.)	15,0	M10x1	12,0	

**Тип 11**

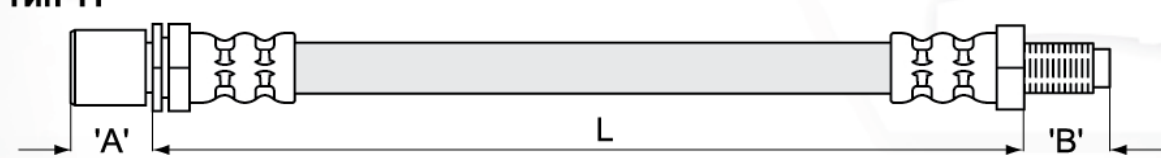

Код ДАФМИ	Длина (мм)	Фитинг 'А'		Фитинг 'В'		Примечания
		Резьба	Размер (мм)	Резьба	Размер (мм)	
31.051.011.000.1	253,0	M10x1 (внутр.)	16,0	M10x1	17,0	
31.053.011.000.1	352,0	M10x1 (внутр.)	16,0	M10x1	17,0	
31.054.011.000.1	155,0	M10x1 (внутр.)	16,0	M10x1	17,0	

**Тип 12**

Код ДАФМИ	Длина (мм)	Фитинг 'А'		Фитинг 'В'		Примечания
		Резьба	Размер (мм)	Резьба	Размер (мм)	
31.056.012.000.1	254,0	M10x1 (внутр.)	16,0	M10x1	16,5	L1=10,5

**Тип 13**

Код ДАФМИ	Длина (мм)	Фитинг 'А'		Фитинг 'В'		Примечания
		Резьба	Размер (мм)	Резьба	Размер (мм)	
31.044.013.000.1	445,0	M10x1 (внутр.)	11,5	M10x1	14,0	Рез. муфта
31.046.013.000.1	155,0	M10x1 (внутр.)	11,5	M10x1	14,0	
31.080.013.000.1	303,0	M10x1 (внутр.)	11,5	M10x1	14,0	
31.083.013.000.1	350,0	M10x1 (внутр.)	11,5	M10x1	14,0	Рез. амортизатор
31.107.013.000.1	234,0	M10x1 (внутр.)	11,5	M10x1	14,0	
31.110.013.000.1	265,0	M10x1 (внутр.)	11,5	M10x1	14,0	
31.112.013.000.1	395,0	M10x1 (внутр.)	11,5	M10x1	14,0	Рез. муфта
31.135.013.000.1	246,0	M10x1 (внутр.)	11,5	M10x1	14,0	Рез. амортизатор
31.138.013.000.1	320,0	M10x1 (внутр.)	11,5	M10x1	14,0	
31.139.013.000.1	203,0	M10x1 (внутр.)	11,5	M10x1	14,0	Армирован
31.184.013.000.1	386,0	M10x1 (внутр.)	11,5	M10x1	14,0	
31.206.013.000.1	396,0	M10x1 (внутр.)	11,5	M10x1	14,0	Рез. муфта

**Тип 14**

Код ДАФМИ	Длина (мм)	Фитинг 'А'		Фитинг 'В'		Примечания
		Резьба	Размер (мм)	Резьба	Размер (мм)	
31.034.014.000.1	253,0	M10x1 (внутр.)	17,0	M10x1	28,0	
31.035.014.000.1	227,0	M10x1 (внутр.)	17,0	M10x1	28,0	

**Тип 15**

Код ДАФМИ	Длина (мм)	Фитинг 'А'		Фитинг 'В'		Примечания
		Резьба	Размер (мм)	Резьба	Размер (мм)	
31.059.015.000.1	467,0	M10x1,25 (внутр.)	9,5	M10x1,25	14,0	

## Тип 16

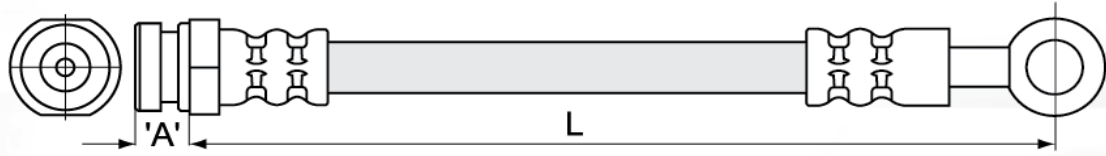

Код ДАФМИ	Длина (мм)	Фитинг 'А'		Фитинг 'В'		Примечания
		Резьба	Размер (мм)	Резьба	Размер (мм)	
31.174.016.000.1	475,0	M10x1 (внутр.)	9,5	Спец. фитинг		Рез. муфта

## Тип 17

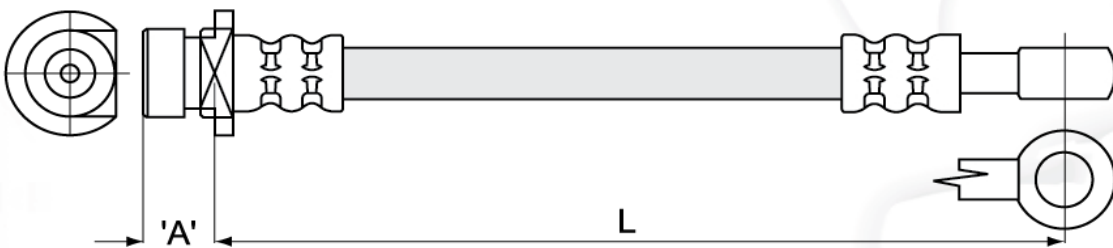

Код ДАФМИ	Длина (мм)	Фитинг 'А'		Фитинг 'В'		Примечания
		Резьба	Размер (мм)	Резьба	Размер (мм)	
31.116.017.000.1	475,0	M10x1 (внутр.)	13,0	Спец. фитинг		Рез. муфта

## Тип 18

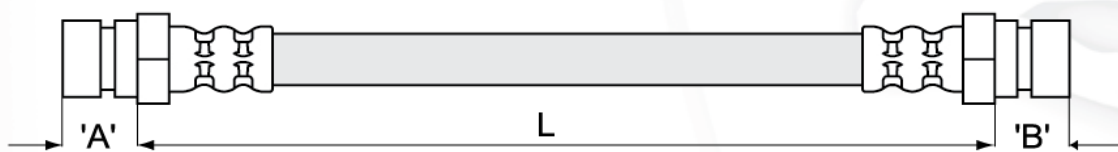

Код ДАФМИ	Длина (мм)	Фитинг 'А'		Фитинг 'В'		Примечания
		Резьба	Размер (мм)	Резьба	Размер (мм)	
31.004.018.000.1	248,0	M10x1 (внутр.)	9,5	M10x1 (внутр.)	9,5	
31.017.018.000.1	293,0	M10x1 (внутр.)	18,0	M10x1 (внутр.)	18,0	Две лыски
31.018.018.000.1	303,0	M10x1 (внутр.)	17,5	M10x1 (внутр.)	17,5	Рез. муфта; манжета защитная
31.028.018.000.1	197,0	M10x1 (внутр.)	18,0	M10x1 (внутр.)	18,0	Две лыски
31.042.018.000.1	319,0	M10x1 (внутр.)	17,0	M10x1 (внутр.)	17,0	Две лыски
31.050.018.000.1	200,0	M10x1 (внутр.)	9,5	M10x1 (внутр.)	9,5	
31.088.018.000.1	257,0	M10x1 (внутр.)	9,5	M10x1 (внутр.)	9,5	Армирован
31.092.018.000.1	197,0	M10x1 (внутр.)	18,0	M10x1 (внутр.)	18,0	Две лыски
31.094.018.000.1	225,0	M10x1 (внутр.)	9,5	M10x1 (внутр.)	9,5	
31.140.018.000.1	247,0	M10x1 (внутр.)	18,0	M10x1 (внутр.)	18,0	
31.197.018.000.1	177,0	M10x1 (внутр.)	9,5	M10x1 (внутр.)	9,5	
31.199.018.000.1	199,0	M10x1 (внутр.)	18,0	M10x1 (внутр.)	18,0	Две лыски
31.209.018.000.1	199,0	M10x1 (внутр.)	18,0	M10x1 (внутр.)	18,0	Две лыски
31.210.018.000.1	211,0	M10x1 (внутр.)	18,0	M10x1 (внутр.)	18,0	Две лыски
31.211.018.000.1	211,0	M10x1 (внутр.)	18,0	M10x1 (внутр.)	18,0	Две лыски

## Тип 19

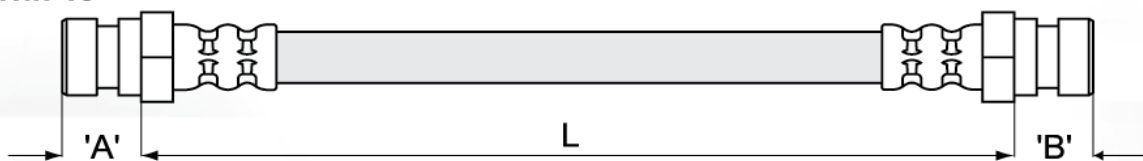

Код ДАФМИ	Длина (мм)	Фитинг 'А'		Фитинг 'В'		Примечания
		Резьба	Размер (мм)	Резьба	Размер (мм)	
31.002.019.000.1	260,0	M10x1 (внутр.)	11,0	M10x1 (внутр.)	11,0	
31.118.019.000.1	295,0	M10x1 (внутр.)	9,5	M10x1 (внутр.)	9,5	Армирован
31.121.019.000.1	301,0	M10x1 (внутр.)	9,5	M10x1 (внутр.)	9,5	Две лыски расположены под углом 180°
31.129.019.000.1	233,0	M10x1 (внутр.)	9,5	M10x1 (внутр.)	9,5	
31.157.019.000.1	138,0	M10x1 (внутр.)	9,5	M10x1 (внутр.)	9,5	
31.192.019.000.1	220,0	M10x1,25 (внутр.)	19,0	M10x1,25 (внутр.)	19,0	

## Тип 20

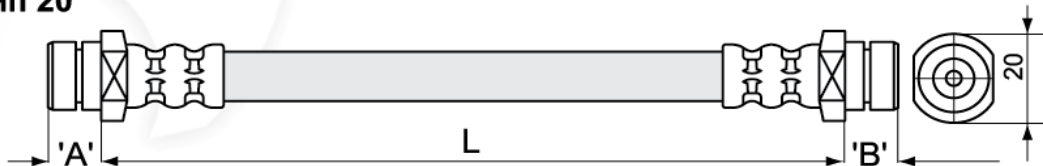

Код ДАФМИ	Длина (мм)	Фитинг 'А'		Фитинг 'В'		Примечания
		Резьба	Размер (мм)	Резьба	Размер (мм)	
31.061.020.000.1	251,0	M10x1 (внутр.)	9,5	M10x1 (внутр.)	9,5	
31.062.020.000.1	297,0	M10x1 (внутр.)	9,5	M10x1 (внутр.)	9,5	Армирован
31.063.020.000.1	245,0	M10x1 (внутр.)	9,5	M10x1 (внутр.)	9,5	
31.123.020.000.1	276,0	M10x1 (внутр.)	9,5	M10x1 (внутр.)	9,5	Две дополнительных лыски
31.124.020.000.1	245,0	M10x1 (внутр.)	11,0	M10x1 (внутр.)	11,0	Пружина
31.125.020.000.1	334,0	M10x1 (внутр.)	9,5	M10x1 (внутр.)	9,5	
31.175.020.000.1	227,0	M10x1 (внутр.)	9,5	M10x1 (внутр.)	9,5	

## Тип 21

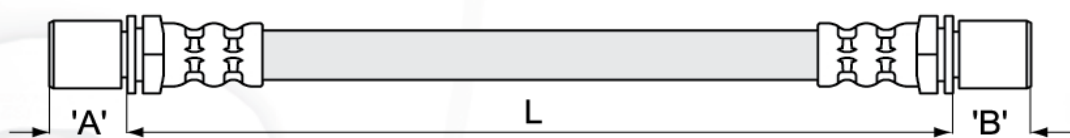

Код ДАФМИ	Длина (мм)	Фитинг 'А'		Фитинг 'В'		Примечания
		Резьба	Размер (мм)	Резьба	Размер (мм)	
31.052.021.000.1	325,0	M10x1 (внутр.)	16,0	M10x1 (внутр.)	16,0	
31.057.021.000.1	290,0	M10x1 (внутр.)	16,0	M10x1 (внутр.)	16,0	
31.127.021.000.1	318,0	M10x1 (внутр.)	16,0	M10x1 (внутр.)	16,0	
31.152.021.000.1	340,0	M10x1 (внутр.)	16,0	M10x1 (внутр.)	16,0	

## Тип 22

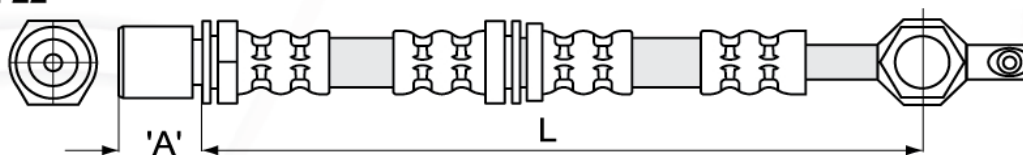

Код ДАФМИ	Длина (мм)	Фитинг 'А'		Фитинг 'В'		Примечания
		Резьба	Размер (мм)	Резьба	Размер (мм)	
31.055.022.000.1	538,0	M10x1 (внутр.)	16,0	Спец. фитинг		
31.058.022.000.1	463,0	M10x1 (внутр.)	16,0	Спец. фитинг		
31.126.022.000.1	475,0	M10x1 (внутр.)	16,0	Спец. фитинг		Скоба
31.156.022.000.1	478,0	M10x1 (внутр.)	16,0	Спец. фитинг		

## Тип 23

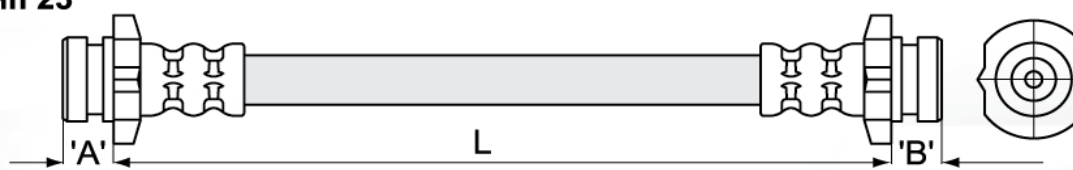

Код ДАФМИ	Длина (мм)	Фитинг 'А'		Фитинг 'В'		Примечания
		Резьба	Размер (мм)	Резьба	Размер (мм)	
31.031.023.000.1	290,0	M10x1 (внутр.)	10,0	M10x1 (внутр.)	10,0	

## Тип 24

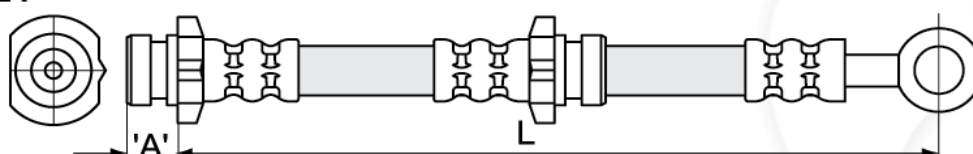

Код ДАФМИ	Длина (мм)	Фитинг 'А'		Фитинг 'В'		Примечания
		Резьба	Размер (мм)	Резьба	Размер (мм)	
31.030.024.000.1	548,0	M10x1 (внутр.)	10,0	Спец. фитинг		
31.032.024.000.1	506,0	M10x1 (внутр.)	10,0	Спец. фитинг		
31.160.024.000.1	490,0	M10x1 (внутр.)	10,0	Спец. фитинг		Спец. фитинг развернут под углом 30°
31.162.024.000.1	447,0	M10x1 (внутр.)	10,0	Спец. фитинг		

## Тип 25

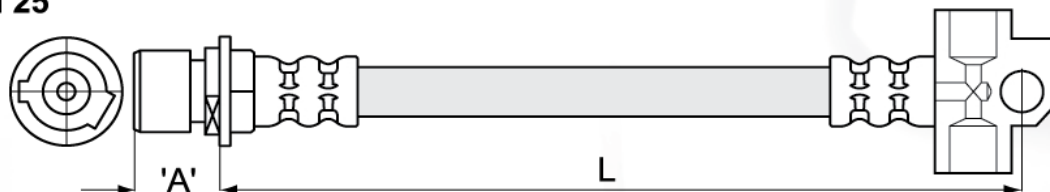

Код ДАФМИ	Длина (мм)	Фитинг 'А'		Фитинг 'В'		Примечания
		Резьба	Размер (мм)	Резьба	Размер (мм)	
31.076.025.000.1	408,0	M10x1 (внутр.)	16,0	M10x1 Block (внутр.)		

## Тип 26

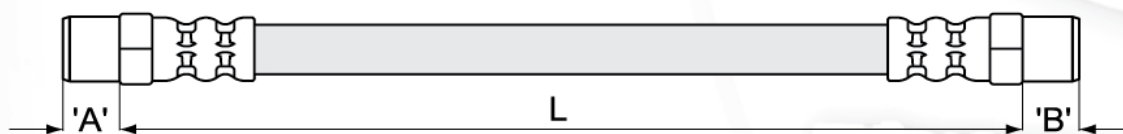

Код ДАФМИ	Длина (мм)	Фитинг 'А'		Фитинг 'В'		Примечания
		Резьба	Размер (мм)	Резьба	Размер (мм)	
31.010.026.000.1	204,0	M10x1 (внутр.)	10,5	M10x1 (внутр.)	10,5	
31.011.026.000.1	280,0	M10x1 (внутр.)	10,5	M10x1 (внутр.)	10,5	
31.012.026.000.1	292,0	M10x1 (внутр.)	11,5	M10x1 (внутр.)	44,5	
31.016.026.000.1	188,0	M10x1 (внутр.)	10,5	M10x1 (внутр.)	10,5	Рез. амортизатор
31.022.026.000.1	203,0	M10x1 (внутр.)	10,5	M10x1 (внутр.)	10,5	Рез. амортизатор
31.047.026.000.1	305,0	M10x1 (внутр.)	11,5	M10x1 (внутр.)	11,5	Рез. амортизатор; муфта
31.060.026.000.1	245,0	M10x1 (внутр.)	10,5	M10x1 (внутр.)	10,5	
31.069.026.000.1	472,0	M10x1 (внутр.)	10,5	M10x1 (внутр.)	10,5	
31.070.026.000.1	384,0	M10x1 (внутр.)	10,5	M10x1 (внутр.)	10,5	Рез. муфта
31.071.026.000.1	444,0	M10x1 (внутр.)	10,5	M10x1 (внутр.)	10,5	
31.144.026.000.1	163,0	M10x1 (внутр.)	10,5	M10x1 (внутр.)	10,5	
31.188.026.000.1	226,0	M10x1,25 (внутр.)	19,0	M10x1,25 (внутр.)	19,0	

## Тип 27

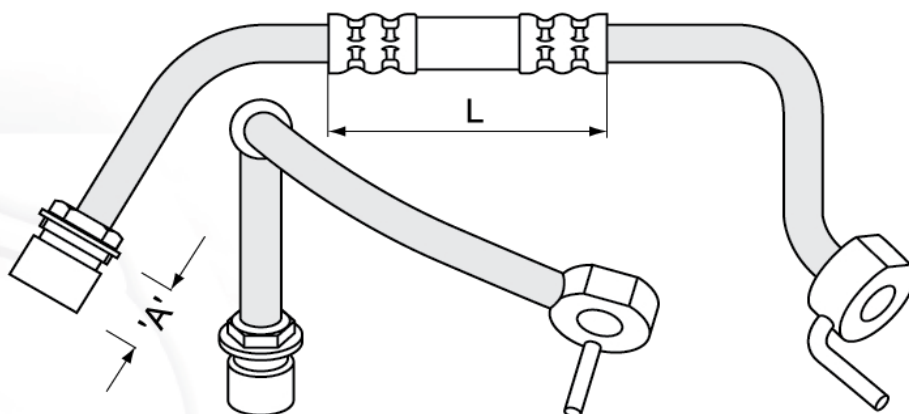

Код ДАФМИ	Длина (мм)	Фитинг 'А'		Фитинг 'В'		Примечания
		Резьба	Размер (мм)	Резьба	Размер (мм)	
31.072.027.000.1	281,0	Спец. фитинг		M10x1 (внутр.)	17,0	

## Тип 28

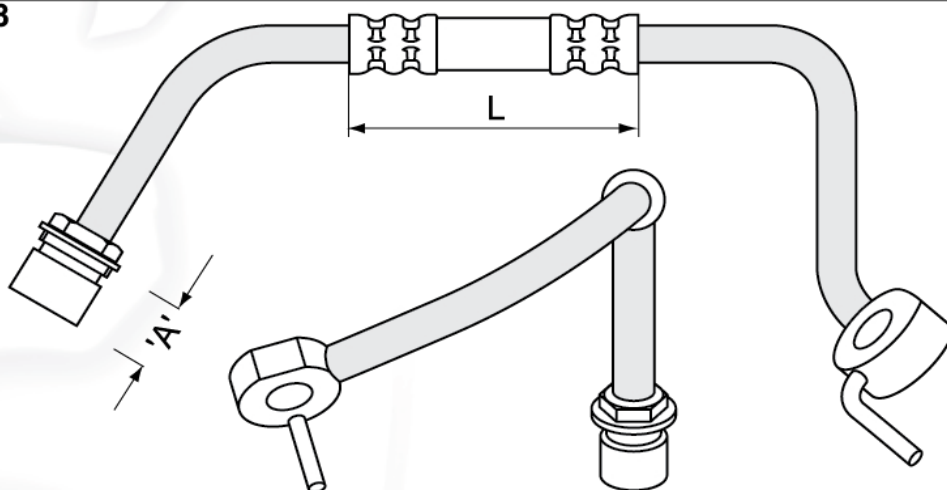

Код ДАФМИ	Длина (мм)	Фитинг 'А'		Фитинг 'В'		Примечания
		Резьба	Размер (мм)	Резьба	Размер (мм)	
31.073.028.000.1	281,0	Спец. фитинг		M10x1 (внутр.)	17,0	

## Тип 29

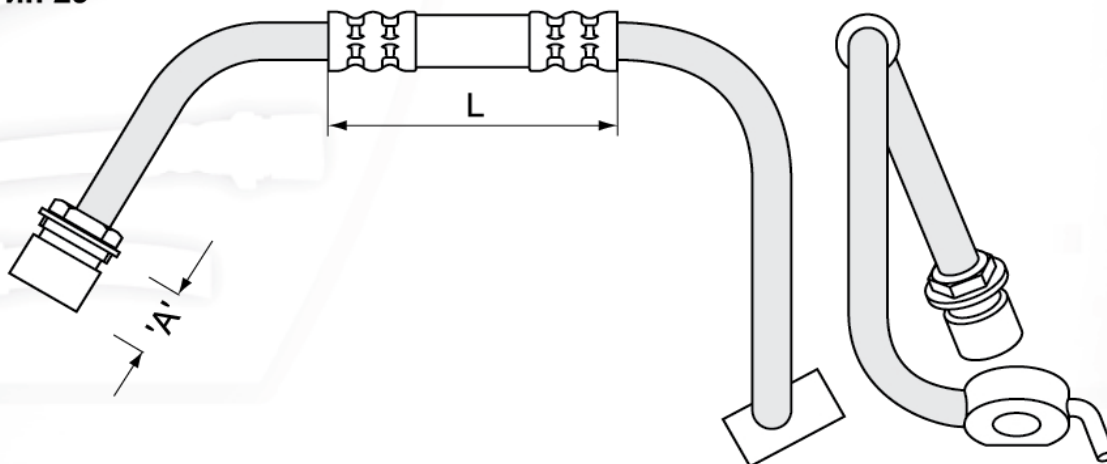

Код ДАФМИ	Длина (мм)	Фитинг 'А'		Фитинг 'В'		Примечания
		Резьба	Размер (мм)	Резьба	Размер (мм)	
31.074.029.000.1	278,0	Спец. фитинг		M10x1 (внутр.)	17,0	

**Тип 30**

Код ДАФМИ	Длина (мм)	Фитинг 'А'		Фитинг 'В'		Примечания
		Резьба	Размер (мм)	Резьба	Размер (мм)	
31.075.030.000.1	278,0	Спец. фитинг		M10x1 (внутр.)	17,0	

**Тип 31**

Код ДАФМИ	Длина (мм)	Фитинг 'А'		Фитинг 'В'		Примечания
		Резьба	Размер (мм)	Резьба	Размер (мм)	
31.077.031.000.1	430,0	Спец. фитинг		M10x1 (внутр.)	17,0	

**Тип 32**

Код ДАФМИ	Длина (мм)	Фитинг 'А'		Фитинг 'В'		Примечания
		Резьба	Размер (мм)	Резьба	Размер (мм)	
31.078.032.000.1	430,0	Спец. фитинг		M10x1 (внутр.)	17,0	Зеркальный вид

**Тип 33**

Код ДАФМИ	Длина (мм)	Фитинг 'А'		Фитинг 'В'		Примечания
		Резьба	Размер (мм)	Резьба	Размер (мм)	
31.027.033.000.1	330,0	Спец. фитинг		M10x1 (внутр.)	18,0	Рез. муфта
31.067.033.000.1	292,0	Спец. фитинг		M10x1 (внутр.)	18,0	Рез. муфта
31.091.033.000.1	320,0	Спец. фитинг		M10x1 (внутр.)	18,0	Рез. муфта; манжета

**Тип 34**

Код ДАФМИ	Длина (мм)	Фитинг 'А'		Фитинг 'В'		Примечания
		Резьба	Размер (мм)	Резьба	Размер (мм)	
31.029.034.000.1	368,0	M10x1 (внутр.)	18,0x	Спец. фитинг		
31.202.034.000.1	349,0	M10x1 (внутр.)	18,0x	Спец. фитинг		Рез. муфта
31.203.034.000.1	325,0	M10x1 (внутр.)	18,0x	Спец. фитинг		Рез. муфта



**Тип 35**

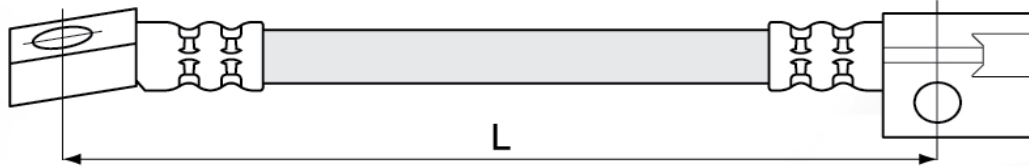

Код ДАФМИ	Длина (мм)	Фитинг 'А'		Фитинг 'В'		Примечания
		Резьба	Размер (мм)	Резьба	Размер (мм)	
31.089.035.000.1	330,0	Спец. фитинг		M10x1 Block (внутр.)		Рез. муфта
31.090.035.000.1	337,0	Спец. фитинг		M10x1 Block (внутр.)		Рез. муфта

**Тип 36**

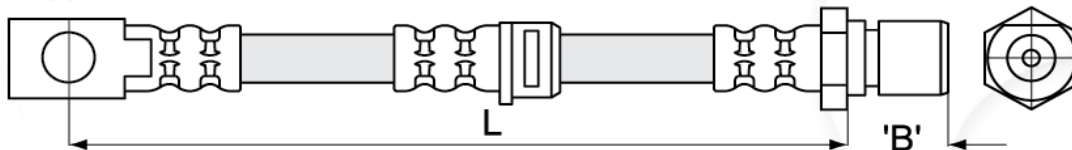

Код ДАФМИ	Длина (мм)	Фитинг 'А'		Фитинг 'В'		Примечания
		Резьба	Размер (мм)	Резьба	Размер (мм)	
31.023.036.000.1	423,0	Спец. фитинг		M10x1 (внутр.)	18,0	

**Тип 37**

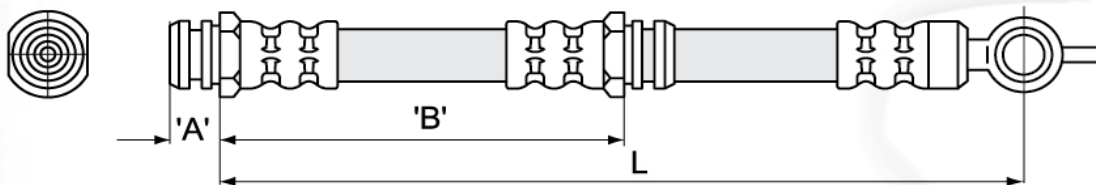

Код ДАФМИ	Длина (мм)	Фитинг 'А'		Фитинг 'В'		Примечания
		Резьба	Размер (мм)	Резьба	Размер (мм)	
31.119.037.000.1	455,0	M10x1 (внутр.)	9,5	Спец. фитинг		
31.120.037.000.1	415,0	M10x1 (внутр.)	9,5	Спец. фитинг		
31.122.037.000.1	542,0	M10x1 (внутр.)	9,5	Спец. фитинг		
31.166.037.000.1	495,0	M10x1 (внутр.)	9,5	Спец. фитинг		
31.208.037.000.1	495,0	M10x1 (внутр.)	9,5	Спец. фитинг		Две доп. лыски

**Тип 38**

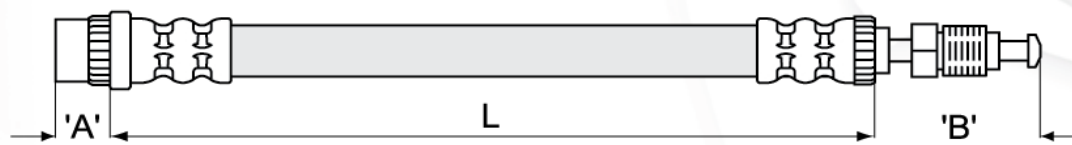

Код ДАФМИ	Длина (мм)	Фитинг 'А'		Фитинг 'В'		Примечания
		Резьба	Размер (мм)	Резьба	Размер (мм)	
31.106.038.000.1	464,0	M10x1 (внутр.)	11,5	M10x1	33,0	Рез. муфта; рез. амортизатор
31.109.038.000.1	412,0	M10x1 (внутр.)	11,5	M10x1	33,0	Армирован; рез. амортизатор
31.136.038.000.1	520,0	M10x1 (внутр.)	11,5	M10x1	33,0	Рез. муфта; рез. амортизатор

**Тип 39**

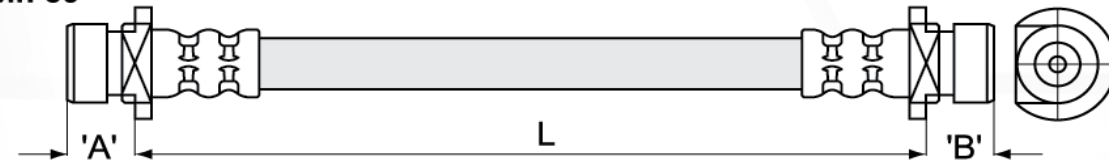

Код ДАФМИ	Длина (мм)	Фитинг 'А'		Фитинг 'В'		Примечания
		Резьба	Размер (мм)	Резьба	Размер (мм)	
31.117.039.000.1	249,0	M10x1 (внутр.)	13,0	M10x1 (внутр.)	13,0	

**Тип 40**

Код ДАФМИ	Длина (мм)	Фитинг 'А'		Фитинг 'В'		Примечания
		Резьба	Размер (мм)	Резьба	Размер (мм)	
31.115.040.000.1	316,0	M10x1 (внутр.)	13,0	M10x1 (внутр.)	13,0	

**Тип 41**

Код ДАФМИ	Длина (мм)	Фитинг 'А'		Фитинг 'В'		Примечания
		Резьба	Размер (мм)	Резьба	Размер (мм)	
31.113.041.000.1	650,0	M10x1 (внутр.)	13,0	Спец. фитинг		Рез. муфта; зеркальный вид
31.114.041.000.1	650,0	M10x1 (внутр.)	13,0	Спец. фитинг		Рез. муфта
31.165.041.000.1	656,0	M10x1 (внутр.)	13,0	Спец. фитинг		Рез. муфта
31.167.041.000.1	656,0	M10x1 (внутр.)	13,0	Спец. фитинг		Рез. муфта

**Тип 42**

Код ДАФМИ	Длина (мм)	Фитинг 'А'		Фитинг 'В'		Примечания
		Резьба	Размер (мм)	Резьба	Размер (мм)	
31.045.042.000.1	248,0	M10x1 (внутр.)	11,5	M10x1 (внутр.)	11,5	Рез. амортизатор
31.081.042.000.1	286,0	M10x1 (внутр.)	11,5	M10x1 (внутр.)	11,5	
31.082.042.000.1	297,0	M10x1 (внутр.)	11,5	M10x1 (внутр.)	11,5	
31.108.042.000.1	182,0	M10x1 (внутр.)	11,5	M10x1 (внутр.)	11,5	Пружина
31.111.042.000.1	255,0	M10x1 (внутр.)	11,5	M10x1 (внутр.)	11,5	
31.198.042.000.1	265,0	M10x1 (внутр.)	11,5	M10x1 (внутр.)	11,5	Армирован

**Тип 43**

Код ДАФМИ	Длина (мм)	Фитинг 'А'		Фитинг 'В'		Примечания
		Резьба	Размер (мм)	Резьба	Размер (мм)	
31.131.043.000.1	375,0	M10x1 (внутр.)	16,5	Спец. фитинг		
31.221.043.000.1	396,0	M10x1 (внутр.)	18,0	Спец. фитинг		Рез. муфта

**Тип 44**

Код ДАФМИ	Длина (мм)	Фитинг 'А'		Фитинг 'В'		Примечания
		Резьба	Размер (мм)	Резьба	Размер (мм)	
31.137.044.000.1	363,0	M12x1,5 (внутр.) вращ.	16,0	M10x1	14,0	Фитинг А вращающийся

**Тип 45**

Код ДАФМИ	Длина (мм)	Фитинг 'А'		Фитинг 'В'		Примечания
		Резьба	Размер (мм)	Резьба	Размер (мм)	
31.130.045.000.1	338,0	M10x1 (внутр.)	11,5	M10x1 (внутр.)	11,5	Муфта x2
31.133.045.000.1	330,0	M10x1 (внутр.)	11,0	M10x1 (внутр.)	11,0	Муфта x2
31.172.045.000.1	272,0	M10x1 (внутр.)	11,0	M10x1 (внутр.)	11,0	Манжета защитная
31.196.045.000.1	146,0	M10x1 (внутр.)	11,5	M10x1 (внутр.)	11,5	

**Тип 46**

Код ДАФМИ	Длина (мм)	Фитинг 'А'		Фитинг 'В'		Примечания
		Резьба	Размер (мм)	Резьба	Размер (мм)	
31.149.046.000.1	430,0	M10x1 (внутр.)	10,0	Спец. фитинг		

**Тип 47**

Код ДАФМИ	Длина (мм)	Фитинг 'А'		Фитинг 'В'		Примечания
		Резьба	Размер (мм)	Резьба	Размер (мм)	
31.155.047.000.1	277,0	M10x1 (внутр.)	10,0	Спец. фитинг		
31.201.047.000.1	418,0	M10x1 (внутр.)	9,5	Спец. фитинг		
31.207.013.000.1	418,0	M10x1 (внутр.)	9,5	Спец. фитинг		

**Тип 48**

Код ДАФМИ	Длина (мм)	Фитинг 'А'		Фитинг 'В'		Примечания
		Резьба	Размер (мм)	Резьба	Размер (мм)	
31.151.048.000.1	510,0	Спец. фитинг		M10x1 (внутр.)	10,0	

**Тип 49**

Код ДАФМИ	Длина (мм)	Фитинг 'А'		Фитинг 'В'		Примечания
		Резьба	Размер (мм)	Резьба	Размер (мм)	
31.147.049.000.1	555,0	Спец. фитинг		M10x1 (внутр.)	13,0	

**Тип 50**

Код ДАФМИ	Длина (мм)	Фитинг 'А'		Фитинг 'В'		Примечания
		Резьба	Размер (мм)	Резьба	Размер (мм)	
31.150.050.000.1	418,0	M10x1 (внутр.)	9,5	M10x1 (внутр.)	9,5	
31.154.050.000.1	262,0	M10x1 (внутр.)	9,5	M10x1 (внутр.)	9,5	Рез. амортизатор
31.200.050.000.1	291,0	M10x1 (внутр.)	9,5	M10x1 (внутр.)	9,5	

**Тип 51**

Код ДАФМИ	Длина (мм)	Фитинг 'А'		Фитинг 'В'		Примечания
		Резьба	Размер (мм)	Резьба	Размер (мм)	
31.145.051.000.1	325,0	M10x1	28,0	Спец. фитинг		Рез. втулка; зеркальный вид
31.146.051.000.1	325,0	M10x1	28,0	Спец. фитинг		Рез. втулка
31.158.051.000.1	321,0	M10x1	23,0	Спец. фитинг		Рез. втулка
31.159.051.000.1	321,0	M10x1	23,0	Спец. фитинг		Рез. втулка; зеркальный вид

**Тип 52**

Код ДАФМИ	Длина (мм)	Фитинг 'А'		Фитинг 'В'		Примечания
		Резьба	Размер (мм)	Резьба	Размер (мм)	
31.168.052.000.1	207,0	M10x1 (внутр.)	18,0	M10x1	13,5	

**Тип 53**

Код ДАФМИ	Длина (мм)	Фитинг 'А'		Фитинг 'В'		Примечания
		Резьба	Размер (мм)	Резьба	Размер (мм)	
31.169.053.000.1	0,0	Спец. фитинг		M10x1 (внутр.)	9,5	L1=190; L2=255; муфта
31.170.053.000.1	0,0	Спец. фитинг		M10x1 (внутр.)	9,5	L1 = 190; L2=255; зеркальный вид; муфта

**Тип 54**

Код ДАФМИ	Длина (мм)	Фитинг 'А'		Фитинг 'В'		Примечания
		Резьба	Размер (мм)	Резьба	Размер (мм)	
31.163.054.000.1	225,0	M10x1 (внутр.)	10,0	M10x1 (внутр.)	10,0	

**Тип 55 - 1**

Код ДАФМИ	Длина (мм)	Фитинг 'А'		Фитинг 'В'		Примечания
		Резьба	Размер (мм)	Резьба	Размер (мм)	
31.185.055.000.1	268,0	M10x1,25 (внутр.)	18,0	Спец. фитинг		-
31.189.055.000.1	478,0	M10x1,25 (внутр.)	18,0	Спец. фитинг		Манжета, пружина
31.190.055.000.1	428,0	M10x1,25 (внутр.)	18,0	Спец. фитинг		Манжета, пружина

**Тип 55 - 2**

Код ДАФМИ	Длина (мм)	Фитинг 'А'		Фитинг 'В'		Примечания
		Резьба	Размер (мм)	Резьба	Размер (мм)	
31.194.055.000.1	398	M10x1 (внутр.)	11,0	Спец. фитинг		

**Тип 56 - 1**

Код ДАФМИ	Длина (мм)	Фитинг 'А'		Фитинг 'В'		Примечания
		Резьба	Размер (мм)	Резьба	Размер (мм)	
31.021.056.000.1	441,0	M10x1 (внутр.)	10,5	M10x1	33,0	Рез. муфта; рез. втулка

**Тип 56 - 2**

Код ДАФМИ	Длина (мм)	Фитинг 'А'		Фитинг 'В'		Примечания
		Резьба	Размер (мм)	Резьба	Размер (мм)	
31.195.056.000.1	200	M10x1 (внутр.)	11,0	Спец. фитинг		

**Тип 57**

Код ДАФМИ	Длина (мм)	Фитинг 'А'		Фитинг 'В'		Примечания
		Резьба	Размер (мм)	Резьба	Размер (мм)	
31.212.057.000.1	289,0	3/8x24 (внутр.) 5/8x18 (внеш.)	15,9	3/8x24 (внутр.) 5/8x18 (внеш.)	15,9	

**Тип 58**

Код ДАФМИ	Длина (мм)	Фитинг 'А'		Фитинг 'В'		Примечания
		Резьба	Размер (мм)	Резьба	Размер (мм)	
31.213.058.000.1	364,0	M10x1 (внутр.)	11,0	M10x1	33,0	

**Тип 59**

Код ДАФМИ	Длина (мм)	Фитинг 'А'		Фитинг 'В'		Примечания
		Резьба	Размер (мм)	Резьба	Размер (мм)	
31.214.059.000.1	442,0	M10x1 (внутр.)	11,5	Спец. фитинг		Рез. амортизатор

**Тип 60**

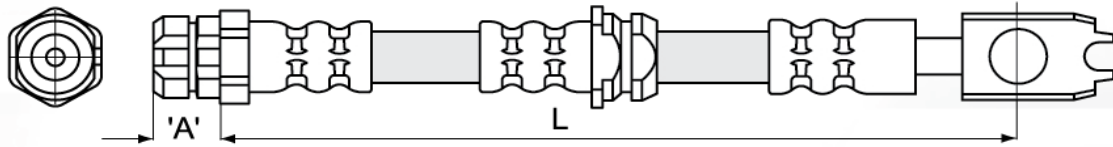

Код ДАФМИ	Длина (мм)	Фитинг 'А'		Фитинг 'В'		Примечания
		Резьба	Размер (мм)	Резьба	Размер (мм)	
31.215.060.000.1	525,0	M10x1 (внутр.)	11,5	Спец. фитинг		Рез. амортизатор
31.216.060.000.1	390,0	M10x1 (внутр.)	18,0	Спец. фитинг		Рез. муфта

**Тип 61**

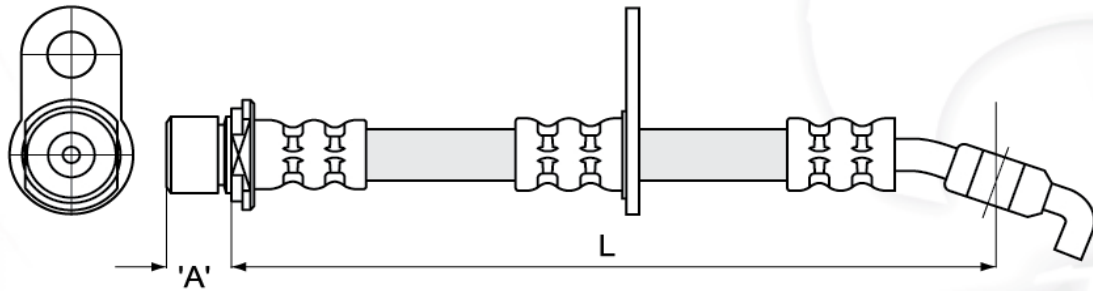

Код ДАФМИ	Длина (мм)	Фитинг 'А'		Фитинг 'В'		Примечания
		Резьба	Размер (мм)	Резьба	Размер (мм)	
31.217.061.000.1	525,0	M10x1 (внутр.)	12,0	Спец. фитинг		
31.218.061.000.1	525,0	M10x1 (внутр.)	12,0	Спец. фитинг		

**Тип 62**

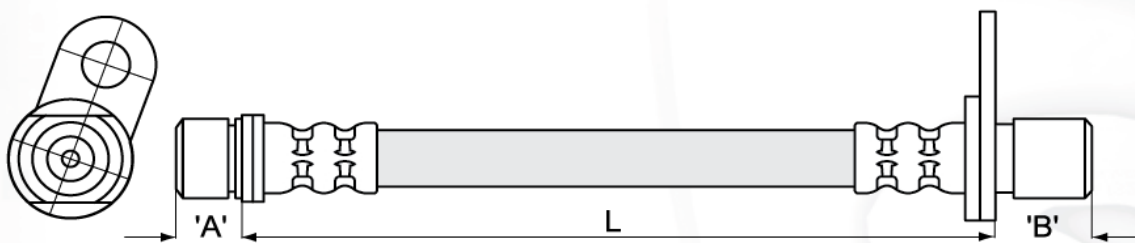

Код ДАФМИ	Длина (мм)	Фитинг 'А'		Фитинг 'В'		Примечания
		Резьба	Размер (мм)	Резьба	Размер (мм)	
31.219.062.000.1	326,0	M10x1 (внутр.)	10,5	M10x1 (внутр.)	18,5	Зеркальный вид
31.220.062.000.1	326,0	M10x1 (внутр.)	10,5	M10x1 (внутр.)	18,5	

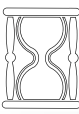
Код ДАФМИ	Шланг		
-----------	-------	--	---

31.001.010.000.1	↘	Mitsubishi Galant (E3)	88-...
31.002.019.000.1	↗↘	Nissan Laurel, Sunny (B11)	77-86
31.003.018.000.1	↗	Mitsubishi L300	80-92
31.004.018.000.1	↘	Peugeot 204, 205, 304, 309	75-77
31.005.005.000.1	↘	Audi 100 Avant, 200, BMW 3-й серии	75-86
31.006.005.000.1	↘	MB (W202, 124, 140, 123, 126)	80-87
31.007.005.000.1	↗ ↓	MB (W123), VW LT	76-85
31.008.005.000.1	↗ ↓	MB 208D/410D	81-...
31.009.005.000.1	↑ ↗	Peugeot J5, VW Polo	74-85
31.010.026.000.1	↘	BMW 3, 5, 6-й серии (E30, 32)	75-90
31.011.026.000.1	↘	Audi 100 Avant	78-82
31.012.026.000.1	↗	BMW 3, 5, 6-й серии (E12, E21)	75-82
31.013.009.000.1	↗	Renault R4, R5, R6	70-87
31.014.008.000.1	↓ ↗	Renault R18, Fuego	81-91
31.015.005.000.1	↘	VW Jetta, Passat	84-91
31.016.026.000.1	↘	Audi 50, 80, 90, 100, 200, A6, VW Golf II, Passat	74-91
31.017.018.000.1	↗	Opel Rekord E, Senator	77-87
31.018.018.000.1	↗	VW LT 28, 31, 35	75-93
31.019.005.000.1	↗	Audi 100 Avant, 200, VW Golf	78-82
31.020.005.000.1	↗	Audi 80, 90, 100 Avant, SEAT Toledo, VW Golf II, Jetta, Passat	84-91-...
31.021.005.000.1	↗	VW Golf III	93-...
31.022.026.000.1	↘	Audi 80, 90	80-91
31.023.036.000.1	↗	Opel Omega	86-94
31.024.005.000.1	↗	Audi 100 Avant	76-82
31.025.044.000.1	↗	MB (W124)	93-96
31.026.001.000.1	↗	Ford Sierra	82-85
31.027.033.000.1	↗	Opel Kadett D, E, Ascona C	79-85
31.028.018.000.1	↘	Opel Kadett D, E, Ascona C, Corsa, Astra	79-85
31.029.034.000.1	↗	Opel Kadett D	79-84
31.030.024.000.1	↗	Nissan Sunny (B11), Prairie (M10)	83-89
31.031.023.000.1	↗	Nissan Bluebird (U11, T12/72)	84-87
31.032.024.000.1	↗	Nissan Bluebird (U11, T12/72) Turbo	84-87
31.033.008.000.1	↘ ↓	Citroen C25, FIAT Ducato, Panda	82-94
31.034.014.000.1	↘	Ford Escort Mk III, XR3, XR3i	80-82
31.035.014.000.1	↘	Ford Escort Mk III, XR3, XR3i	80-82
31.036.004.000.1	↘	Ford Escort 86, Mk III, XR3, XR3i, Orion	83-90
31.037.004.000.1	↘	Ford Escort 86, Mk III, XR3, XR3i, Orion	83-90
31.038.002.000.1	↘	Ford Granada, Scorpio, Sierra	82-92
31.039.001.000.1	↗	Ford Escort 86, Mk III, XR3, XR3i, Orion	83-90
31.040.001.000.1	↗	Ford Escort 86, Mk III, XR3, XR3i, Fiesta	83-90
31.041.001.000.1	↗	Ford Fiesta	77-83
31.042.018.000.1	↘	Ford Fiesta	77-89
31.043.008.000.1	↗	Renault R18, Espace, Fuego	81-91
31.044.013.000.1	↗	Renault R25, Espace	84-96
31.045.042.000.1	↘	Renault R25, Twingo, R9, R11	85-95
31.046.013.000.1	↘	Renault R25	84-92
31.047.026.000.1	↗	Audi 100 Avant, 200, Coupe	82-86
31.048.005.000.1	↗	BMW 5-й серии (E28)	81-87
31.049.007.000.1	↗	FIAT Fiorino, Uno	88-93
31.050.018.000.1	↘ ↓	FIAT 900T, Uno	79-80
31.051.011.000.1	↓	Toyota Carina (TA4,TA6)	78-84
31.052.021.000.1	↗	Toyota Carina (TA6), Celica	82-85
31.053.011.000.1	↓	Toyota Landcruiser (J6)	77-90
31.054.011.000.1	↗	Toyota Landcruiser (J6)	84-90
31.055.022.000.1	↗	Toyota Camry (V1, V2)	83-87
31.056.012.000.1	↗	Toyota Tercel	82-89
31.057.021.000.1	↗ ↘	Toyota Corolla (E7, E8), Tercel	80-85
31.058.022.000.1	↗	Toyota Carina II (TA15), Corolla (E8)	84-88
31.059.015.000.1	↗	Mazda 323 (FA4/BU) RWD	76-83
31.060.026.000.1	↘	Volvo 340/360	76-85
31.061.020.000.1	↘ ↓	Honda Prelude, Mazda 323 (BD/BF/BW)	80-85
31.062.020.000.1	↗ ↓	Mitsubishi Colt (C1,C5), Galant (E1,E3,A16), Lancer (C1,C6,A17), L200 Pickup (L.../K1)	79-87
31.063.020.000.1	↘	Mitsubishi L300 Van (P...), Colt (A15), Lancer (A17)	84-88



# Краткая таблица применяемости тормозных шлангов

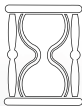

Код ДАФМИ	Шланг		
--------------	-------	--	---

31.064.010.000.1	↗↗	Mitsubishi L300 Van (L03), Galant (A16)	80-92
31.065.010.000.1	↘↘	Mitsubishi Colt (C5), Galant (A16,E1), Lancer (C6)	84-92
31.066.010.000.1	↗↗	Mitsubishi Colt (C1,C5), Galant (E1,E3,A16), Lancer (C1,C6,A17), Spacewagon, L200 Pickup	79-88
31.067.033.000.1	↗↗	Opel Corsa	83-85
31.068.005.000.1	↗↗	BMW 3-й серии (E30), Volvo 740/940/960	82-90
31.069.026.000.1	↗↗	MB 207D -809D	77-...
31.070.026.000.1	↗↗	VW Transporter (Type II)	79-85
31.071.026.000.1	↗↗	VW LT Van, Transporter (Type II, IV)	85-91
31.072.027.000.1	↗	Ford Transit (2-х порошневая скоба)	76-86
31.073.028.000.1	↖	Ford Transit (2-х порошневая скоба)	76-86
31.074.029.000.1	↗	Ford Transit (4-х порошневая скоба)	76-86
31.075.030.000.1	↖	Ford Transit (4-х порошневая скоба)	76-86
31.076.025.000.1	↘↘	Ford Transit	76-86
31.077.031.000.1	↗	Ford Transit 80-120	86-...
31.078.032.000.1	↖	Ford Transit 80-120	86-...
31.079.003.000.1	↗↗	Ford Scorpio, Granada	85-93
31.080.013.000.1	↘↘	Renault Safrane	92-...
31.081.042.000.1	↘↘	Renault R21	85-...
31.082.042.000.1	↘↘	Renault R9, R11	82-89
31.083.013.000.1	↗↗	Renault R9, R11	82-91
31.084.007.000.1	↗↗	Citroen C15D, Visa, Peugeot 204D	83-...
31.085.008.000.1	↗↗	Peugeot 309	87-...
31.086.007.000.1	↗↗	Citroen Visa, Peugeot 204, 309, 505	83-...
31.087.008.000.1	↘ ↘	Peugeot 204, 309	86-...
31.088.018.000.1	↘ ↘	Peugeot 204, 309	86-...
31.089.035.000.1	↖	Opel Kadett E	84-85
31.090.035.000.1	↖	Opel Kadett E	85-91
31.091.033.000.1	↗↗	Opel Ascona C, Astra, Kadett E, Vectra	88-...
31.092.018.000.1	↘↘	Opel Ascona C, Astra, Corsa, Kadett E, Omega, Vectra, Daewoo Espero, Nexia	86-...
31.093.010.000.1	↗↗	Citroen BX	82-...
31.094.018.000.1	↘↘	FIAT Tempra, Tipo, Lancia Dedra	88-93
31.095.007.000.1	↗↗	FIAT Tempra, Tipo, Lancia Dedra	88-93
31.096.007.000.1	↗↗	Citroen C25 Van, FIAT Ducato нижний	83-...
31.097.007.000.1	↗↗	FIAT Uno, Lancia Y10	86-...
31.098.007.000.1	↗↗	Citroen C25 Van, FIAT Ducato верхний	83-...
31.099.007.000.1	↗↗	FIAT Uno	86-...
31.100.005.000.1	↗↗	Volvo 440/460/480	87-...
31.101.005.000.1	↘↘	Volvo 440/460/480	87-...
31.102.005.000.1	↘↘	Volvo 440/460/480	87-...
31.103.002.000.1	↘↘	Ford Fiesta	89-...
31.104.001.000.1	↘↘	Ford Sierra	86-93
31.105.005.000.1	↗↗	VW Passat, Golf, Jetta	78-83
31.106.038.000.1	↗↗	Peugeot 405	88-...
31.107.013.000.1	↗↗	Peugeot 405	88-...
31.108.042.000.1	↘↘	Peugeot 405	88-...
31.109.038.000.1	↗↗	Peugeot 405	88-...
31.110.013.000.1	↗↗	Renault R19/Shamade (C53), Nevada	89-...
31.111.042.000.1	↘↘	Renault R19/Shamade (C53), Nevada	89-...
31.112.013.000.1	↗↗	Renault R25 (R29)	84-92
31.113.041.000.1	↖	Honda Accord (CA)	85-89
31.114.041.000.1	↗	Honda Accord (CA)	85-89
31.115.040.000.1	↘↘	Honda Accord (CA)	85-89
31.116.017.000.1	↗↗	Honda Civic (A), Shuttle	84-87
31.117.039.000.1	↘↘	Honda Civic (A), Shuttle	84-87
31.118.019.000.1	↗↗	Hyundai Pony, Stellar	85-...
31.119.037.000.1	↗↗	Mazda 323 (BD/BF/BW) FWD	80-85
31.120.037.000.1	↗↗	Mazda 323 (BD/BF/BW) FWD	85-89
31.121.019.000.1	↘	Mazda 323 (BD/BF/BW) FWD	80-85
31.122.037.000.1	↗↗	Mazda 626 (GB/GC/GD/GV)	83-...
31.123.020.000.1	↘	Mazda 626 (GB/GC/GD/GV)	83-...
31.124.020.000.1	↘↘	Mitsubishi Galant (E1)	84-88
31.125.020.000.1	↘	Mitsubishi L300 Van (L03)	80-92
31.126.022.000.1	↗↗	Toyota Corolla (E9)	87-92

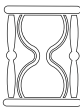
Код ДАФМИ	Шланг		
-----------	-------	--	---

31.127.021.000.1	↙↘	Toyota Corolla (E9)	87-92
31.128.008.000.1	↗↘	Skoda Favorit	89-...
31.129.019.000.1	↙↘	Skoda Favorit	89-...
31.130.045.000.1	↗↘	VW Passat	88-91
31.131.043.000.1	↗↘	MB 100	-
31.132.044.000.1	↓	MB 100	-
31.133.045.000.1	↗↘	VW Transporter Typ IV	91-...
31.134.001.000.1	↙↘	Ford Escort 91, Orion	91-...
31.135.013.000.1	↗↘	Renault R21 (L48)	86-...
31.136.038.000.1	↗↘	Peugeot 605	90-...
31.137.044.000.1	↗↘	SEAT Toledo, VW Golf, Jetta	83-95
31.138.013.000.1	↗↘	Renault R21 (L48), Trafic, Twingo	86-...
31.139.013.000.1	↙↘	Peugeot 605	90-...
31.140.018.000.1	↙↘	Ford Escort Cosworth	91-...
31.141.006.000.1	↗↘	Citroen BX (with ABS)	82-...
31.142.005.000.1	↙↘	BMW 3, 5-й серии (E30, 32, 34, 36)	81-95
31.143.001.000.1	↗↘	Ford Fiesta	89-...
31.144.026.000.1	↗↘ ↙↘	Audi 90, SEAT Ibiza III, Toledo, VW Golf II, Vento, Transporter IV	88-95
31.145.051.000.1	↗	Ford Escort 91, Orion	91-...
31.146.051.000.1	↖	Ford Escort 91, Orion	91-...
31.147.049.000.1	↗↘	Ford Mondeo	93-...
31.148.005.000.1	↗↘	Volvo 740/760/780/940/960	82-90
31.149.046.000.1	↗↘	Opel Frontera	91-...
31.150.050.000.1	↗↘	Mazda E2200	88-...
31.151.048.000.1	↗↘	Nissan Sunny (B12/N13)	82-92
31.152.021.000.1	↙↘	Toyota Camry (V2), Carina II (TA15)	83-91
31.153.002.000.1	↙↘	Ford Fiesta	89-...
31.154.050.000.1	↙↘	Mazda 323 (BG)	90-...
31.155.047.000.1	↗↘	Mazda E2200	88-...
31.156.022.000.1	↗↘	Toyota Carina II (TA15)	86-92
31.157.019.000.1	↙↘	VW Golf, Vento	91-...
31.158.051.000.1	↖	Ford Escort 91, Orion	91-...
31.159.051.000.1	↗	Ford Escort 91, Orion	91-...
31.160.024.000.1	↖	Nissan Sunny (N14), 100NX	90-...
31.161.005.000.1	↗↘	BMW 5-й серии (E34)	91-...
31.162.024.000.1	↗↘	Suzuki Swift (SA310/SA413, SF413)	85-89
31.163.054.000.1	↙↘	Suzuki Swift (SA310/SA413, SF413)	85-89
31.164.005.000.1	↗↘	BMW 3-й серии (E30) 325ix	86-...
31.165.041.000.1	↗	Honda Prelude	87-91
31.166.037.000.1	↙↘	Mazda 626 (GB/GC/GD/GV)	87-92
31.167.041.000.1	↖	Honda Prelude	87-91
31.168.052.000.1	↙↘	Opel Astra, Calibra, Vectra	83-...
31.169.053.000.1	↖	Nissan Primera	90-...
31.170.053.000.1	↗	Nissan Primera	90-...
31.171.005.000.1	↙↘	Audi 100, A6	94-...
31.172.045.000.1	↗↘	Audi 100, A6	94-...
31.173.005.000.1	↙↘	Volvo 760/780/960	82-...
31.174.016.000.1	↗↘	Honda Civic (S)	79-83
31.175.020.000.1	↙↘	Honda Civic (S)	79-83
31.176.008.000.1	↗↘	FIAT Uno	86-...
31.177.019.000.1	↓	FIAT Uno	86-...
31.178.008.000.1	↗↘	FIAT Ducato верхний	...83
31.179.008.000.1	↗↘	FIAT Ducato нижний	...83
31.180.008.000.1	↗↘	FIAT Croma, Lancia Thema	85-91
31.181.008.000.1	↙↘	FIAT Croma, Lancia Thema	85-91
31.182.008.000.1	↗↘	FIAT Tempra, Tipo, Lancia Dedra	89-93
31.183.008.000.1	↗↘	FIAT Tempra	89-93
31.184.013.000.1	↙↘	Renault Trafic	81-...
31.194.055.000.1	↗↘	Opel Astra G	98-...
31.195.056.000.1	↙↘	Opel Astra G	98-...
31.196.045.000.1	↙↘	Skoda Oktavia Fabia	96-...
31.197.018.000.1	↙↘	Skoda Felicia	96-99
31.198.042.000.1	↙↘	Renault Megane	94-...

# Краткая таблица применяемости тормозных шлангов

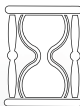

Код ДАФМИ	Шланг		
--------------	-------	--	---

31.199.018.000.1	↙↘	Opel Vectra B	95-...
31.200.050.000.1	↙↘	Mazda 323 (BA)	94-...
31.201.047.000.1	↗↘	Mazda 626 (GE)	92-97
31.202.034.000.1	↗↘	Daewoo Nexia Espero	93-...
31.203.034.000.1	↗↘	Daewoo Lanos	98-...
31.204.010.000.1	↗↘	Peugeot J9	80-...
31.205.008.000.1	↗↘	Skoda Felicia	96-99
31.206.013.000.1	↗↘	Renault Megane	94-...
31.207.047.000.1	↗↘	Mazda 323 (BA)	94-...
31.208.037.000.1	↙↘	Mazda 626 (GE)	92-97
31.209.018.000.1	↙↘	Daewoo Lanos	98-...
31.210.018.000.1	↘	Daewoo Nubira	97-...
31.211.018.000.1	↙	Daewoo Nubira	97-...
31.212.057.000.1	↙↘	Peugeot J9	80-...
31.213.058.000.1	↗↘ ↙↘	MB Sprinter	95-...
31.214.059.000.1	↗↘	Skoda Oktavia	96-...
31.215.060.000.1	↗↘	Skoda Fabia	98-...
31.216.060.000.1	↗↘	Opel Vectra B	95-...
31.217.061.000.1	↗	Toyota Carina E	92-97
31.218.061.000.1	↗	Toyota Carina E	92-97
31.219.062.000.1	↙	Toyota Carina E	92-97
31.220.062.000.1	↘	Toyota Carina E	92-97
31.221.043.000.1	↗↘	Daewoo Nubira	97-...
31.224.050.000.1	↗↘	Богдан А091 (EURO II)	95-...

ALFA ROMEO	
4283535	31.006.005.000.1
1234280135	31.006.005.000.1
46202H7025	31.002.019.000.1
7567861	31.098.007.000.1
7570315	31.014.008.000.1
7619751	31.094.018.000.1
7655155	31.095.007.000.1
7667806	31.094.018.000.1
7704001939	31.014.008.000.1
BMW	
1229347	31.012.026.000.1
34321113184	31.012.026.000.1
34321115695	31.010.026.000.1
34321152274	31.048.005.000.1
34321154904	31.068.005.000.1
34321156334	31.164.005.000.1
34321159891	31.161.005.000.1
34324051524	31.142.005.000.1
CITROEN	
4806,31	31.086.007.000.1
5944002	31.050.018.000.1
5952296	31.179.008.000.1
7563852	31.050.018.000.1
7567861	31.098.007.000.1
7567862	31.096.007.000.1
7570315	31.014.008.000.1
7704001939	31.014.008.000.1
91515816	31.084.007.000.1
^5494973	31.093.010.000.1
95599101	31.050.018.000.1
95632790	31.141.006.000.1
DAEWOO	
562094	31.092.018.000.1
562095	31.202.034.000.1
562346	31.209.018.000.1
562358	31.091.033.000.1
90235568	31.091.033.000.1
90235999	31.092.018.000.1
90473452	31.203.034.000.1
96179489	31.209.018.000.1
96300046	31.221.043.000.1
96300330	31.211.018.000.1
96308124	31.210.018.000.1
FIAT	
21013506060	31.185.055.000.1
21013506085	31.186.006.000.1
4349187	31.186.006.000.1
4434663	31.185.055.000.1
4816,24	31.004.018.000.1
5944002	31.050.018.000.1
5952296	31.179.008.000.1
5952297	31.178.008.000.1
5966685	31.176.008.000.1
5988077	31.049.007.000.1
7563848	31.097.007.000.1
7563849	31.049.007.000.1
7563850	31.049.007.000.1
7563852	31.050.018.000.1
7567861	31.098.007.000.1
7567862	31.096.007.000.1
4280535	31.008.005.000.1
443611775A	31.060.026.000.1

6314280035	31.131.043.000.1
6314280335	31.137.044.000.1
9014280235	31.213.058.000.1
FORD	
1613337	31.075.030.000.1
1613344	31.040.001.000.1
1613348	31.042.018.000.1
1613349	31.075.030.000.1
1613351	31.037.004.000.1
1631045	31.072.027.000.1
1631046	31.073.028.000.1
1631048	31.074.029.000.1
1631049	31.075.030.000.1
1631051	31.076.025.000.1
1648810	31.037.004.000.1
176657328	31.145.051.000.1
6098253	31.034.014.000.1
6102786	31.035.014.000.1
6114613	31.041.001.000.1
6125634	31.079.003.000.1
6125636	31.104.001.000.1
6129003	31.036.004.000.1
6132910	31.038.002.000.1
6135220	31.039.001.000.1
6158424	31.077.031.000.1
6158425	31.078.032.000.1
6179304	31.103.002.000.1
6191842	31.143.001.000.1
6535451	31.146.051.000.1
6535452	31.145.051.000.1
6657327	31.158.051.000.1
6657328	31.159.051.000.1
6714710	31.153.002.000.1
6828211	31.134.001.000.1
7067563	31.147.049.000.1
86VB2078AC	31.077.031.000.1
D74VB2078AC	31.072.027.000.1
D74VB2078BC	31.073.028.000.1
D76VB2078AD	31.074.029.000.1
D76VB2078BD	31.075.030.000.1
6125634	31.026.001.000.1
GAZELLA	
3302350602510	31.193.005.000.1
HONDA	
01464SA0030	31.174.016.000.1
01464SB2030	31.116.017.000.1
01466SA0010	31.175.020.000.1
01466SE0020	31.115.040.000.1
46410SE0013	31.114.041.000.1
46410SF1023	31.165.041.000.1
HYUNDAI	
5873721020	31.118.019.000.1
MB238151	31.066.010.000.1
MB238161	31.062.020.000.1
MB238169	31.124.020.000.1
MR129744	31.066.010.000.1
MR129779	31.062.020.000.1
MR129781	31.062.020.000.1
LADA	
21013506060	31.185.055.000.1
21013506085	31.186.006.000.1
21083506060	31.187.005.000.1
21083506085	31.188.026.000.1

21213506060	31.189.055.000.1
21213506061	31.190.055.000.1
4349187	31.186.006.000.1
4434663	31.185.055.000.1
LANCIA	
5944002	31.050.018.000.1
7563848	31.097.007.000.1
7563852	31.050.018.000.1
7569161	31.097.007.000.1
7609087	31.182.008.000.1
7619751	31.094.018.000.1
7655155	31.095.007.000.1
7667806	31.094.018.000.1
82422141	31.180.008.000.1
82422142	31.181.008.000.1
82422143	31.180.008.000.1
82468102	31.182.008.000.1
95599101	31.050.018.000.1
MAZDA	
395843980	31.059.015.000.1
B00143810	31.061.020.000.1
B00143980A	31.119.037.000.1
B09243810A	31.121.019.000.1
B09243980	31.120.037.000.1
B45543810A	31.154.050.000.1
B45543980B	31.201.047.000.1
B45543980B	31.207.047.000.1
BC1D43810	31.200.050.000.1
G03043980	31.122.037.000.1
G03143810A	31.123.020.000.1
GJ2543980	31.166.037.000.1
GJ2543981	31.208.037.000.1
S08343810	31.155.047.000.1
S08343810A	31.155.047.000.1
MERCEDES	
4283535	31.006.005.000.1
4288035	31.008.005.000.1
14288835	31.007.005.000.1
14289535	31.069.026.000.1
1234280135	31.006.005.000.1
1234280635	31.025.044.000.1
2D0611701B	31.213.058.000.1
32687055	31.060.026.000.1
115595621	31.129.019.000.1
1J0611701	31.214.059.000.1
6Q0611701C	31.215.060.000.1
6U0611775	31.197.018.000.1
MITSUBISHI	
MB150762	31.125.020.000.1
MB238151	31.066.010.000.1
MB238152	31.064.010.000.1
MB238153	31.065.010.000.1
MB238160	31.063.020.000.1
MB238161	31.062.020.000.1
MB238169	31.124.020.000.1
MB857543	31.064.010.000.1
MR129724	31.125.020.000.1
MR129744	31.066.010.000.1
MR129746	31.064.010.000.1
MR129777	31.063.020.000.1
MR129779	31.062.020.000.1
MR129781	31.062.020.000.1

# Таблицы соответствия OEM – Дафми



NISSAN	
46202H7025	31.002.019.000.1
4621002E0	31.032.024.000.1
4621002E10	31.032.024.000.1
4621004A10	31.030.024.000.1
4621050J60	31.170.053.000.1
4621050Y12	31.160.024.000.1
4621060A10	31.151.048.000.1
4621090J00	31.170.053.000.1
4621150J60	31.169.053.000.1
4621189910	31.001.010.000.1
4621190J00	31.169.053.000.1
4621401	31.031.023.000.1
OPEL	
562094	31.092.018.000.1
562095	31.202.034.000.1
562311	31.140.018.000.1
562314	31.017.018.000.1
562320	31.029.034.000.1
562321	31.028.018.000.1
562325	31.027.033.000.1
562328	31.067.033.000.1
562336	31.089.035.000.1
562344	31.090.035.000.1
562346	31.199.018.000.1
562353	31.023.036.000.1
562358	31.091.033.000.1
562359	31.168.052.000.1
562373	31.216.060.000.1
562454	31.140.018.000.1
7704001955	31.184.013.000.1
7704002447	31.184.013.000.1
90168898	31.067.033.000.1
90235568	31.091.033.000.1
90235999	31.092.018.000.1
90236355	31.090.035.000.1
90445764	31.023.036.000.1
90473452	31.203.034.000.1
90539252	31.216.060.000.1
91149880	31.149.046.000.1
96179489	31.199.018.000.1
7569161	31.097.007.000.1
7570315	31.014.008.000.1
7573858	31.004.018.000.1
7577466	31.099.007.000.1
7577467	31.099.007.000.1
7609087	31.182.008.000.1
7619751	31.094.018.000.1
7655155	31.095.007.000.1
7667806	31.094.018.000.1
7704001939	31.014.008.000.1
82422141	31.180.008.000.1
82422142	31.181.008.000.1
82422143	31.180.008.000.1
82468102	31.182.008.000.1
95599101	31.050.018.000.1
0562377	31.194.055.000.1
5562078	31.195.056.000.1
PEUGEOT	
4806.15	31.204.010.000.1
4806.31	31.086.007.000.1
4806.32	31.087.008.000.1
4806.37	31.085.008.000.1
4806.39	31.106.038.000.1
4806.4	31.108.042.000.1
4806.41	31.107.013.000.1
4806.42	31.109.038.000.1
4806.44	31.136.038.000.1
4806.45	31.139.013.000.1
4806.47	31.108.042.000.1
4806.48	31.107.013.000.1
4806.93	31.045.042.000.1
4816.24	31.004.018.000.1
4816.29	31.088.018.000.1
5952296	31.179.008.000.1

7567861	31.098.007.000.1
7567862	31.096.007.000.1
7570315	31.014.008.000.1
7573858	31.004.018.000.1
7704001939	31.014.008.000.1
7704003549	31.045.042.000.1
91515816	31.084.007.000.1
RENAULT	
34321152274	31.048.005.000.1
4806.93	31.045.042.000.1
7570315	31.014.008.000.1
7619751	31.094.018.000.1
7667806	31.094.018.000.1
7700834863	31.198.042.000.1
7700840390	31.206.013.000.1
7701204831	31.112.013.000.1
7704001925	31.013.009.000.1
7704001939	31.014.008.000.1
7704001948	31.043.008.000.1
7704001954	31.083.013.000.1
7704001955	31.184.013.000.1
7704001956	31.044.013.000.1
7704002443	31.046.013.000.1
7704002444	31.044.013.000.1
7704002447	31.184.013.000.1
7704003549	31.045.042.000.1
7704003764	31.082.042.000.1
7704003765	31.081.042.000.1
7704003846	31.112.013.000.1
7704003887	31.135.013.000.1
7704003905	31.081.042.000.1
7704003913	31.080.013.000.1
7704003958	31.110.013.000.1
7704003961	31.111.042.000.1
SEAT	
171611701G,L	31.020.005.000.1
171611775	31.144.026.000.1
1H0611701	31.021.056.000.1
1H0611775	31.157.019.000.1
1J0611701	31.214.059.000.1
6Q0611701C	31.215.060.000.1
7570315	31.014.008.000.1
7704001939	31.014.008.000.1
893611775A	31.015.005.000.1
5312593	31.128.008.000.1
46411SE0013	31.113.041.000.1
46411SF1023	31.167.041.000.1
46430SA0003	31.175.020.000.1
46430SB2013	31.117.039.000.1
46430SE0013	31.115.040.000.1
SUZUKI	
5155084150	31.162.024.000.1
5156086000	31.163.054.000.1
TAVRIA	
11023506060	31.191.006.000.1
11023506085	31.192.019.000.1
TOYOTA	
9094702426	31.052.021.000.1
9094702429	31.055.022.000.1
9094702437	31.056.012.000.1
9094702455	31.058.022.000.1
9094702497	31.152.021.000.1
9094702532	31.126.022.000.1
9094702533	31.127.021.000.1
9094702565	31.156.022.000.1
9094702634	31.220.062.000.1
9094702694	31.219.062.000.1
9094702820	31.217.061.000.1
9094702821	31.218.061.000.1
9094702904	31.058.022.000.1
9694032805	31.051.011.000.1
9694032855	31.051.011.000.1
9694033805	31.053.011.000.1
9694039855	31.054.011.000.1
9695032405	31.138.013.000.1

9695033205	31.057.021.000.1
VOLKSWAGEN	
171611701G,L	31.020.005.000.1
171611775	31.144.026.000.1
1H0611701	31.021.056.000.1
1H0611775	31.157.019.000.1
1J0611701	31.214.059.000.1
211611775A	31.018.018.000.1
251611775A	31.070.026.000.1
281611775B	31.018.018.000.1
291611775	31.071.026.000.1
2D0611701B	31.213.058.000.1
321611701D	31.105.005.000.1
431611707	31.024.005.000.1
433611775A	31.016.026.000.1
535611701	31.130.045.000.1
6Q0611701C	31.215.060.000.1
701611701	31.133.045.000.1
861611707B,C	31.009.005.000.1
893611775A	31.015.005.000.1
9014280235	31.213.058.000.1
437611775	31.005.005.000.1
433611775	31.011.026.000.1
433611707	31.019.006.000.1
433611775A	31.022.026.000.1
803611707	31.047.026.000.1
4A0611707	31.172.045.000.1
1JD611775	31.196.045.000.1
6U0611701B	31.205.008.000.1
VOLVO	
1229347	31.012.026.000.1
1329594	31.173.005.000.1
13296116	31.148.005.000.1
32687055	31.060.026.000.1
34126854	31.102.005.000.1
34304089	31.101.005.000.1
3432113184	31.012.026.000.1
3432115695	31.010.026.000.1
34321154904	31.068.005.000.1
34474320	31.100.005.000.1
443611775A	31.060.026.000.1

К&К	Код ДАФМИ
FT 68	31.002.019.000.1
FT 331	31.213.058.000.1
FT 352	31.215.060.000.1
FT 568	31.006.005.000.1
FT 571	31.007.005.000.1
FT 573	31.008.005.000.1
FT 580	31.009.005.000.1
FT 594	31.010.026.000.1
FT 595	31.011.026.000.1
FT 597	31.012.026.000.1
FT 601	31.140.018.000.1
FT 608	31.221.043.000.1
FT 612	31.210.018.000.1
FT 613	31.211.018.000.1
FT 916	31.014.008.000.1
FT 1155	31.204.010.000.1
FT 1343	31.015.005.000.1
FT 1351	31.016.026.000.1
FT 1352	31.017.018.000.1
FT 1429	31.018.018.000.1
FT 1694	31.019.006.000.1
FT 1716	31.020.005.000.1
FT 1716	31.132.044.000.1
FT 1718	31.021.056.000.1
FT 1756	31.022.026.000.1
FT 1758	31.023.036.000.1
FT 1763	31.024.005.000.1
FT 1774	31.025.044.000.1
FT 1947	31.027.033.000.1
FT 1948	31.028.018.000.1
FT 1955	31.029.034.000.1
FT 1998	31.030.024.000.1
FT 2017	31.001.010.000.1
FT 2059	31.031.023.000.1
FT 2060	31.032.024.000.1
FT 2100	31.034.014.000.1
FT 2101	31.035.014.000.1
FT 2102	31.036.004.000.1
FT 2103	31.037.004.000.1
FT 2105	31.038.002.000.1
FT 2106	31.039.001.000.1
FT 2107	31.040.001.000.1
FT 2108	31.041.001.000.1
FT 2109	31.042.018.000.1
FT 2143	31.043.008.000.1
FT 2146	31.045.042.000.1
FT 2151	31.047.026.000.1
FT 2154	31.048.005.000.1
FT 2159	31.051.011.000.1
FT 2161	31.052.021.000.1
FT 2170	31.053.011.000.1
FT 2180	31.220.062.000.1
FT 2181	31.054.011.000.1
FT 2183	31.219.062.000.1
FT 2188	31.218.061.000.1
FT 2189	31.217.061.000.1
FT 2190	31.055.022.000.1
FT 2192	31.056.012.000.1
FT 2209	31.057.021.000.1
FT 2213	31.058.022.000.1
FT 2218	31.059.015.000.1
FT 2220	31.060.026.000.1
FT 2254	31.061.020.000.1
FT 2257	31.062.020.000.1
FT 2258	31.063.020.000.1
FT 2262	31.064.010.000.1
FT 2266	31.065.010.000.1
FT 2269	31.066.010.000.1
FT 2293	31.067.033.000.1
FT 2301	31.068.005.000.1
FT 2304	31.069.026.000.1

К&К	Код ДАФМИ
FT 2307	31.070.026.000.1
FT 2309	31.071.026.000.1
FT 2317	31.072.027.000.1
FT 2318	31.073.028.000.1
FT 2322	31.074.029.000.1
FT 2323	31.075.030.000.1
FT 2327	31.026.001.000.1
FT 2332	31.076.025.000.1
FT 2333	31.077.031.000.1
FT 2334	31.078.032.000.1
FT 2502	31.079.003.000.1
FT 2798	31.080.013.000.1
FT 2801	31.082.042.000.1
FT 2802	31.083.013.000.1
FT 2803	31.084.007.000.1
FT 2804	31.085.008.000.1
FT 2805	31.086.007.000.1
FT 2807	31.087.008.000.1
FT 2808	31.088.018.000.1
FT 2810	31.089.035.000.1
FT 2811	31.090.035.000.1
FT 2812	31.091.033.000.1
FT 2813	31.092.018.000.1
FT 2813	31.199.018.000.1
FT 2813	31.209.018.000.1
FT 2814	31.216.060.000.1
FT 2819	31.093.010.000.1
FT 2820	31.185.055.000.1
FT 2821	31.186.006.000.1
FT 3242	31.094.018.000.1
FT 3243	31.095.007.000.1
FT 3244	31.096.007.000.1
FT 3245	31.097.007.000.1
FT 3246	31.098.007.000.1
FT 3247	31.099.007.000.1
FT 3249	31.100.005.000.1
FT 3250	31.101.005.000.1
FT 3252	31.102.005.000.1
FT 3254	31.103.002.000.1
FT 3255	31.104.001.000.1
FT 3257	31.105.005.000.1
FT 3258	31.106.038.000.1
FT 3259	31.107.013.000.1
FT 3260	31.108.042.000.1
FT 3261	31.109.038.000.1
FT 3268	31.189.055.000.1
FT 3269	31.190.055.000.1
FT 3270	31.187.005.000.1
FT 3271	31.188.026.000.1
FT 3284	31.110.013.000.1
FT 3285	31.111.042.000.1
FT 3286	31.112.013.000.1
FT 3288	31.113.041.000.1
FT 3289	31.114.041.000.1
FT 3290	31.115.040.000.1
FT 3292	31.116.017.000.1
FT 3293	31.117.039.000.1
FT 3298	31.118.019.000.1
FT 3301	31.119.037.000.1
FT 3302	31.120.037.000.1
FT 3303	31.121.019.000.1
FT 3304	31.122.037.000.1
FT 3305	31.123.020.000.1
FT 3306	31.124.020.000.1
FT 3309	31.125.020.000.1
FT 3666	31.126.022.000.1
FT 3667	31.127.021.000.1
FT 3702	31.128.008.000.1
FT 3702	31.205.008.000.1
FT 3703	31.129.019.000.1
FT 4000	31.130.045.000.1

К&К	Код ДАФМИ
FT 4050	31.131.043.000.1
FT 4051	31.137.044.000.1
FT 4053	31.200.050.000.1
FT 4600	31.133.045.000.1
FT 4620	31.134.001.000.1
FT 4635	31.044.013.000.1
FT 4637	31.081.042.000.1
FT 4645	31.135.013.000.1
FT 4646	31.136.038.000.1
FT 4647	31.013.009.000.1
FT 4653	31.138.013.000.1
FT 4659	31.139.013.000.1
FT 4661	31.141.006.000.1
FT 4663	31.142.005.000.1
FT 4669	31.005.005.000.1
FT 4670	31.143.001.000.1
FT 4672	31.144.026.000.1
FT 4675	31.145.051.000.1
FT 4676	31.146.051.000.1
FT 4678	31.147.049.000.1
FT 4679	31.202.034.000.1
FT 4679	31.203.034.000.1
FT 4685	31.148.005.000.1
FT 4688	31.150.050.000.1
FT 4690	31.151.048.000.1
FT 4694	31.152.021.000.1
FT 4701	31.153.002.000.1
FT 4702	31.154.050.000.1
FT 4705	31.155.047.000.1
FT 4706	31.156.022.000.1
FT 4707	31.157.019.000.1
FT 4708	31.158.051.000.1
FT 4709	31.159.051.000.1
FT 4710	31.160.024.000.1
FT 4711	31.046.013.000.1
FT 4714	31.161.005.000.1
FT 4715	31.162.024.000.1
FT 4718	31.163.054.000.1
FT 4719	31.164.005.000.1
FT 4720	31.165.041.000.1
FT 4721	31.166.037.000.1
FT 4721	31.208.037.000.1
FT 4725	31.167.041.000.1
FT 4730	31.168.052.000.1
FT 4737	31.169.053.000.1
FT 4738	31.170.053.000.1
FT 4744	31.172.045.000.1
FT 4746	31.173.005.000.1
FT 4760	31.149.046.000.1
FT 4764	31.206.013.000.1
FT 4765	31.198.042.000.1
FT 4779	31.214.059.000.1
FT 4780	31.201.047.000.1
FT 4780	31.207.047.000.1
FT 4799	31.197.018.000.1
FT 5165	31.174.016.000.1
FT 5220	31.175.020.000.1
FT 7024	31.191.006.000.1
FT 7025	31.192.019.000.1
FT 7045	31.193.005.000.1
FT 8350	31.176.008.000.1
FT 8355	31.049.007.000.1
FT 8364	31.178.008.000.1
FT 8365	31.179.008.000.1
FT 8400	31.180.008.000.1
FT 8401	31.181.008.000.1
FT 8406	31.004.018.000.1
FT 8415	31.182.008.000.1
FT 8427	31.050.018.000.1
FT 8499	31.184.013.000.1

BENDIX	DAfmi	BENDIX	DAfmi	BENDIX	DAfmi	BENDIX	DAfmi
169007	31.186.006.000.0	171181B	31.012.026.000.0	171516B	31.032.024.000.0	834522	31.135.013.000.0
169115	31.042.018.000.0	171182B	31.091.033.000.0	171518B	31.030.024.000.0	834529	31.205.008.000.0
169356	31.067.033.000.0	171186B	31.005.005.000.0	171539B	31.031.023.000.0	834535	31.184.013.000.0
169361	31.027.033.000.0	171188B	31.048.005.000.0	171540B	31.031.023.000.0	834538	31.085.008.000.0
169373	31.020.005.000.0	171203B	31.058.022.000.0	171543B	31.096.008.000.0	834544	31.050.018.000.0
169374	31.016.026.000.0	171206B	31.093.010.000.0	171544B	31.096.008.000.0	835247	31.043.008.000.0
169375	31.022.026.000.0	171215B	31.092.018.000.0	171547B	31.020.005.000.0	835930	31.046.013.000.0
169377	31.024.005.000.0	171216B	31.202.034.000.0	171619B	31.065.010.000.0	990010	31.067.033.000.0
169381	31.012.026.000.0	171217B	31.017.018.000.0	171620B	31.062.020.000.0	990016	31.027.033.000.0
169382	31.142.005.000.0	171221B	31.023.036.000.0	171642B	31.055.022.000.0	990030	31.022.026.000.0
169383	31.010.026.000.0	171222B	31.168.052.000.0	171643B	31.098.007.000.0	990031	31.020.005.000.0
171003B	31.014.008.000.0	171228B	31.079.003.000.0	171644B	31.096.008.000.0	990032	31.016.026.000.0
171004B	31.080.013.000.0	171249B	31.035.014.000.0	171677B	31.125.020.000.0	990036	31.012.026.000.0
171006B	31.139.013.000.0	171250B	31.034.014.000.0	171681B	31.064.010.000.0	990037	31.142.005.000.0
171007B	31.107.018.000.0	171252B	31.072.027.000.0	171684B	31.063.020.000.0	990038	31.010.026.000.0
171008B	31.138.013.000.0	171253B	31.073.028.000.0	171715B	31.149.046.000.0	HYH02122	31.052.021.000.0
171009B	31.106.038.000.0	171254B	31.074.029.000.0	171836B	31.031.023.000.0	HYH02426	31.052.021.000.0
171011B	31.109.038.000.0	171255B	31.075.030.000.0	171858B	31.052.021.000.0	HYH02429	31.054.011.000.0
171012B	31.111.042.000.0	171258B	31.077.031.000.0	171883B	31.127.021.000.0	HYH02437	31.056.012.000.0
171014B	31.107.018.000.0	171259B	31.078.032.000.0	171887B	31.156.022.000.0	HYH02455	31.058.022.000.0
171015B	31.135.013.000.0	171266B	31.158.051.000.0	171912B	31.053.011.000.0	HYH02820	31.002.019.000.0
171019B	31.112.013.000.0	171267B	31.159.051.000.0	171930B	31.022.026.000.0	HYH04448	31.063.020.000.0
171021B	31.044.013.000.0	171269B	31.077.031.000.0	171931B	31.027.033.000.0	HYH32855	31.051.011.000.0
171022B	31.138.013.000.0	171270B	31.078.032.000.0	171940B	31.029.034.000.0	HYH43810	31.061.020.000.0
171031B	31.139.013.000.0	171279B	31.145.051.000.0	171947B	31.054.011.000.0	HYH43981	31.119.037.000.0
171033B	31.136.038.000.0	171280B	31.146.051.000.0	171948B	31.204.010.000.0	HYH43982	31.122.037.000.0
171036B	31.085.008.000.0	171294B	31.158.051.000.0	171950B	31.205.008.000.0	HYH50672	31.125.020.000.0
171037B	31.088.018.000.0	171296B	31.159.051.000.0	171951B	31.046.013.000.0	HYH58592	31.063.020.000.0
171040B	31.084.007.000.0	171305B	31.097.007.000.0	171975B	31.009.005.000.0	HYH58593	31.062.020.000.0
171069B	31.094.018.000.0	171306B	31.098.007.000.0	171976B	31.060.026.000.0	HYH71002	31.063.020.000.0
171070B	31.129.019.000.0	171310B	31.069.026.000.0	171982B	31.109.038.000.0	HYH74501	31.031.023.000.0
171092B	31.083.013.000.0	171311B	31.099.007.000.0	172049B	31.147.049.000.0	HYH81946	31.064.010.000.0
171098B	31.082.042.000.0	171312B	31.099.007.000.0	172052B	31.187.006.000.0	HYH89904	31.031.023.000.0
171100B	31.045.042.000.0	171318B	31.095.007.000.0	172053B	31.188.026.000.0	HYH89929	31.002.019.000.0
171101B	31.112.013.000.0	171321B	31.094.018.000.0	172074B	31.206.013.000.0		
171102B	31.135.013.000.0	171332B	31.100.005.000.0	172075B	31.198.042.000.0		
171106B	31.184.013.000.0	171334B	31.101.005.000.0	172127B	31.190.055.000.0		
171108B	31.050.018.000.0	171336B	31.100.005.000.0	172131B	31.124.020.000.0		
171126B	31.026.001.000.0	171367B	31.180.008.000.0	172134B	31.128.008.000.0		
171128B	31.036.044.000.0	171374B	31.181.008.000.0	525553	31.212.057.000.0		
171129B	31.037.004.000.0	171376B	31.095.007.000.0	526201	31.212.057.000.0		
171130B	31.039.001.000.0	171379B	31.093.010.000.0	526851	31.212.057.000.0		
171132B	31.038.002.000.0	171384B	31.133.045.000.0	527353	31.212.057.000.0		
171133B	31.079.003.000.0	171389B	31.061.020.000.0	529103	31.212.057.000.0		
171135B	31.067.033.000.0	171390B	31.119.037.000.0	529107	31.212.057.000.0		
171136B	31.028.018.000.0	171391B	31.121.019.000.0	533581	31.004.018.000.0		
171139B	31.020.005.000.0	171392B	31.120.037.000.0	534021	31.129.019.000.0		
171143B	31.068.005.000.0	171395B	31.201.047.000.0	534249	31.128.008.000.0		
171144B	31.015.005.000.0	171396B	31.201.047.000.0	534293	31.043.008.000.0		
171146B	31.024.005.000.0	171399B	31.122.037.000.0	544293	31.043.008.000.0		
171149B	31.047.026.000.0	171400B	31.123.020.000.0	604561	31.139.013.000.0		
171150B	31.012.026.000.0	171415B	31.054.011.000.0	604562	31.107.018.000.0		
171152B	31.010.026.000.0	171416B	31.056.012.000.0	604565	31.106.038.000.0		
171153B	31.068.005.000.0	171423B	31.152.021.000.0	604570	31.109.038.000.0		
171154B	31.048.005.000.0	171426B	31.126.022.000.0	604571	31.111.042.000.0		
171155B	31.025.044.000.0	171437B	31.065.010.000.0	829103	31.212.057.000.0		
171156B	31.006.005.000.0	171439B	31.051.011.000.0	833581	31.004.018.000.0		
171158B	31.040.001.000.0	171450B	31.186.006.000.0	834021	31.129.019.000.0		
171159B	31.143.001.000.0	171462B	31.113.041.000.0	834249	31.128.008.000.0		
171160B	31.042.018.000.0	171468B	31.114.041.000.0	834450	31.012.026.000.0		
171161B	31.104.001.000.0	171472B	31.063.020.000.0	834472	31.083.013.000.0		
171164B	31.050.018.000.0	171479B	31.117.039.000.0	834474	31.045.042.000.0		
171173B	31.094.018.000.0	171481B	31.115.040.000.0	834496	31.044.013.000.0		
171174B	31.090.035.000.0	171486B	31.105.005.000.0	834499	31.084.007.000.0		
171175B	31.089.035.000.0	171487B	31.144.026.000.0	834505	31.082.042.000.0		
171176B	31.007.005.000.0	171492B	31.021.005.000.0	834511	31.080.013.000.0		
171177B	31.070.026.000.0	171493B	31.157.019.000.0	834515	31.045.042.000.0		
171178B	31.018.018.000.0	171507B	31.002.019.000.0	834517	31.112.013.000.0		

TRW	DAfmi
GHP41	31.042.018.000.0
GHP60	31.037.004.000.0
GHP61	31.036.044.000.0
GHP105	31.040.001.000.0
GHP110	31.038.002.000.0
GHP129	31.034.014.000.0
GHP130	31.035.014.000.0
GHP139	31.016.026.000.0
GHP140	31.015.005.000.0
GHP142	31.185.055.000.0
GHP144	31.024.005.000.0
GHP147	31.020.005.000.0
GHP152	31.031.023.000.0
GHP158	31.002.019.000.0
GHP200	31.063.020.000.0
GHP216	31.062.020.000.0
GHP217	31.063.020.000.0
GHP241	31.129.019.000.0
GHP251	31.012.026.000.0
GHP252	31.212.057.000.0
GHP263	31.143.001.000.0
GHP265	31.142.005.000.0
GHP266	31.010.026.000.0
GHP271	31.144.026.000.0
GHP277	31.039.001.000.0
GHP283	31.094.018.000.0
GHP309	31.051.011.000.0
GHP311	31.064.010.000.0
GHP315	31.007.005.000.0
GHP326	31.004.018.000.0
GHP330	31.007.005.000.0
GHP338	31.017.018.000.0
GHP360	31.030.024.000.0
GHP362	31.059.015.000.0
GHP371	31.124.020.000.0
GHP375	31.063.020.000.0
GHP376	31.062.020.000.0
GHP383	31.058.022.000.0
GHP398	31.028.018.000.0
GHP403	31.012.026.000.0
GHP408	31.186.006.000.0
GHP422	31.125.020.000.0
GHP426	31.063.020.000.0
GHP430	31.002.019.000.0
GHP431	31.052.021.000.0
GHP461	31.070.026.000.0
GHP463	31.018.018.000.0
GHP519	31.128.008.000.0
GHP521	31.043.008.000.0
GHP529	31.143.001.000.0
GHP536	31.042.018.000.0
GHP538	31.029.034.000.0
GHP551	31.026.001.000.0
GHP555	31.046.013.000.0
GHP558	31.068.005.000.0
GHP562	31.050.018.000.0
GHP564	31.044.013.000.0
GHP572	31.084.007.000.0
GHP573	31.109.038.000.0
GHP575	31.110.013.000.0
GHP576	31.045.042.000.0
GHP577	31.111.042.000.0
GHP580	31.094.018.000.0
GHP582	31.085.008.000.0
GHP583	31.088.018.000.0
GHP602	31.067.033.000.0
GHP604	31.089.035.000.0
GHP608	31.091.033.000.0
GHP609	31.092.018.000.0
GHP610	31.090.035.000.0

TRW	DAfmi
GHP613	31.072.027.000.0
GHP614	31.073.028.000.0
GHP616	31.074.029.000.0
GHP617	31.075.030.000.0
GHP618	31.076.025.000.0
GHP635	31.068.005.000.0
GHP643	31.054.011.000.0
GHP649	31.120.037.000.0
GHP650	31.121.019.000.0
GHP651	31.121.019.000.0
GHP664	31.079.003.000.0
GHP666	31.104.001.000.0
GHP667	31.083.013.000.0
GHP669	31.105.005.000.0
GHP673	31.047.026.000.0
GHP763	31.048.005.000.0
GHP770	31.080.013.000.0
GHP775	31.045.042.000.0
GHP785	31.140.018.000.0
GHP787	31.027.033.000.0
GHP790	31.016.026.000.0
GHP808	31.098.007.000.0
GHP812	31.139.013.000.0
GHP819	31.135.013.000.0
GHP824	31.081.042.000.0
GHP831	31.093.010.000.0
GHP833	31.050.018.000.0
GHP839	31.093.010.000.0
GHP851	31.180.008.000.0
GHP852	31.077.031.000.0
GHP853	31.078.032.000.0
GHP856	31.074.029.000.0
GHP857	31.075.030.000.0
GHP870	31.134.001.000.0
GHP890	31.037.004.000.0
GHP891	31.036.044.000.0
GHP911	31.181.008.000.0
GHP920	31.118.019.000.0
GHP921	31.187.006.000.0
GHP922	31.188.026.000.0
GHP926	31.082.042.000.0
GHP931	31.130.045.000.0
GHP934	31.069.026.000.0
GHP940	31.138.013.000.0
GHP941	31.189.055.000.0
GHP942	31.190.055.000.0
GHP951	31.184.013.000.0
GHP952	31.044.013.000.0
GHP960	31.107.018.000.0
GHP961	31.135.013.000.0
GHP962	31.082.042.000.0
GHP971	31.106.038.000.0
GHP972	31.097.007.000.0
GHP973	31.099.007.000.0
GHP1050	31.159.051.000.0
GHP1051	31.158.051.000.0
GHP1056	31.128.008.000.0
GHP1057	31.129.019.000.0
GHP1098	31.021.005.000.0
GHP1197	31.023.036.000.0
GHP5006	31.121.019.000.0
GHP5012	31.166.037.000.0
GHP5015	31.119.037.000.0
GHP5016	31.061.020.000.0
GHP5018	31.002.019.000.0
GHP5019	31.122.037.000.0
GHP5020	31.123.020.000.0
GHP5056	31.117.039.000.0
GHP5059	31.116.017.000.0
GHP5061	31.114.041.000.0

TRW	DAfmi
GHP5068	31.115.040.000.0
GHP5146	31.099.007.000.0
GHP5172	31.053.011.000.0
GHP5240	31.056.012.000.0
GHP5273	31.054.011.000.0
GHP5304	31.061.020.000.0
GHP5319	31.116.017.000.0
GHP5437	31.163.054.000.0
GHP5471	31.126.022.000.0
GHP5475	31.054.011.000.0
GHP5482	31.156.022.000.0
PHA102	31.129.019.000.0
PHA114	31.063.020.000.0
PHA117	31.129.019.000.0
PHA119	31.020.005.000.0
PHA127	31.022.026.000.0
PHA129	31.017.018.000.0
PHA134	31.124.020.000.0
PHA135	31.063.020.000.0
PHA138	31.028.018.000.0
PHA140	31.012.026.000.0
PHA141	31.042.018.000.0
PHA145	31.002.019.000.0
PHA153	31.070.026.000.0
PHA154	31.018.018.000.0
PHA162	31.154.050.000.0
PHA164	31.061.020.000.0
PHA167	31.123.020.000.0
PHA170	31.117.039.000.0
PHA186	31.031.023.000.0
PHA200	31.163.054.000.0
PHA211	31.046.013.000.0
PHA221	31.050.018.000.0
PHA222	31.112.013.000.0
PHA224	31.111.042.000.0
PHA226	31.088.018.000.0
PHA229	31.092.018.000.0
PHA232	31.076.025.000.0
PHA236	31.120.037.000.0
PHA237	31.083.013.000.0
PHA243	31.080.013.000.0
PHA244	31.045.042.000.0
PHA248	31.139.013.000.0
PHA256	31.050.018.000.0
PHA261	31.188.026.000.0
PHA263	31.069.026.000.0
PHA266	31.184.013.000.0
PHA267	31.044.013.000.0
PHA269	31.107.018.000.0
PHA270	31.135.013.000.0
PHA271	31.082.042.000.0
PHA292	31.157.019.000.0
PHA314	31.133.045.000.0
PHA317	31.094.018.000.0
PHA322	31.118.019.000.0
PHA337	31.216.060.000.0
PHA341	31.196.045.000.0
PHA350	31.197.018.000.0
PHA358	31.111.042.000.0
PHA368	31.200.050.000.0
PHB101	31.048.005.000.0
PHB106	31.128.008.000.0
PHB107	31.034.014.000.0
PHB108	31.035.014.000.0
PHB111	31.009.005.000.0
PHB112	31.019.005.000.0
PHB113	31.020.005.000.0
PHB121	31.190.055.000.0
PHB125	31.006.005.000.0
PHB128	31.144.026.000.0

TRW	DAfmi
PHB136	31.025.044.000.0
PHB138	31.007.005.000.0
PHB141	31.059.015.000.0
PHB152	31.186.006.000.0
PHB177	31.068.005.000.0
PHB186	31.109.038.000.0
PHB188	31.095.007.000.0
PHB189	31.085.008.000.0
PHB193	31.098.007.000.0
PHB200	31.054.011.000.0
PHB202	31.105.005.000.0
PHB209	31.048.005.000.0
PHB219	31.093.010.000.0
PHB223	31.180.008.000.0
PHB224	31.181.008.000.0
PHB226	31.098.007.000.0
PHB229	31.187.006.000.0
PHB241	31.106.038.000.0
PHB243	31.099.007.000.0
PHB255	31.021.005.000.0
PHB256	31.005.005.000.0
PHB258	31.147.049.000.0
PHB279	31.101.005.000.0
PHB281	31.100.005.000.0
PHB282	31.205.008.000.0
PHB283	31.107.018.000.0
PHB284	31.136.038.000.0
PHB286	31.168.052.000.0
PHB305	31.112.013.000.0
PHB307	31.205.008.000.0
PHB319	31.005.005.000.0
PHB339	31.168.052.000.0
PHB348	31.211.018.000.0
PHC113	31.038.002.000.0
PHC132	31.143.001.000.0
PHC137	31.039.001.000.0
PHC192	31.026.001.000.0
PHC204	31.079.003.000.0
PHC205	31.104.001.000.0
PHD109	31.185.055.000.0
PHD113	31.030.024.000.0
PHD124	31.119.037.000.0
PHD125	31.122.037.000.0
PHD134	31.114.041.000.0
PHD136	31.113.041.000.0
PHD145	31.054.011.000.0
PHD161	31.029.034.000.0
PHD168	31.163.054.000.0
PHD179	31.126.022.000.0
PHD189	31.114.041.000.0
PHD225	31.067.033.000.0
PHD226	31.089.035.000.0
PHD229	31.090.035.000.0
PHD230	31.072.027.000.0
PHD231	31.073.028.000.0
PHD232	31.074.029.000.0
PHD233	31.075.030.000.0
PHD248	31.077.031.000.0
PHD249	31.078.032.000.0
PHD250	31.072.027.000.0
PHD252	31.074.029.000.0
PHD253	31.075.030.000.0
PHD263	31.189.055.000.0
PHD264	31.190.055.000.0
PHD288	31.202.034.000.0
PHD295	31.023.036.000.0
PHD307	31.131.043.000.0
PHD349	31.214.059.000.0
PHD380	31.217.061.000.0



МОПРОД	Код "ДАФМИ"
BH150	31.143.001.000.0
BH151	31.039.001.000.0
BH152	31.036.044.000.0
BH153	31.037.004.000.0
BH154	31.034.014.000.0
BH155	31.035.014.000.0
BH156	31.038.002.000.0
BH158	31.026.001.000.0
BH168	31.028.018.000.0
BH169	31.067.033.000.0
BH172	31.027.033.000.0
BH253	31.042.018.000.0
BH255	31.040.001.000.0
BH270	31.072.027.000.0
BH271	31.073.028.000.0
BH272	31.072.027.000.0
BH273	31.074.029.000.0
BH276	31.073.028.000.0
BH277	31.029.034.000.0
BH278	31.028.018.000.0
BH507	31.144.026.000.0
BH509	31.142.005.000.0
BH517	31.007.005.000.0
BH537	31.010.026.000.0
BH541	31.012.026.000.0
BH550	31.016.026.000.0
BH573	31.186.006.000.0
BH605	31.004.018.000.0
BH607	31.129.019.000.0
BH610	31.128.008.000.0
BH633	31.024.005.000.0
BH634	31.016.026.000.0
BH635	31.011.026.000.0
BH637	31.185.055.000.0
BH639	31.018.018.000.0
BH695	31.002.019.000.0
BH703	31.185.055.000.0
BH704	31.186.006.000.0
BH713	31.065.010.000.0
BH717	31.022.026.000.0
BH722	31.082.042.000.0
BH728	31.045.042.000.0
BH729	31.083.013.000.0
BH732	31.047.026.000.0
BH741	31.050.018.000.0
BH743	31.068.005.000.0
BH749	31.069.026.000.0
BH758	31.052.021.000.0
BH760	31.057.021.000.0

МОПРОД	Код "ДАФМИ"
BH767	31.051.011.000.0
BH776	31.062.020.000.0
BH777	31.066.010.000.0
BH778	31.063.020.000.0
BH779	31.125.020.000.0
BH794	31.030.024.000.0
BH801	31.123.020.000.0
BH802	31.122.037.000.0
BH803	31.119.037.000.0
BH804	31.061.020.000.0
BH814	31.058.022.000.0
BH822	31.068.005.000.0
BH825	31.090.035.000.0
BH826	31.093.010.000.0
BH830	31.077.031.000.0
BH831	31.078.032.000.0
BH832	31.075.030.000.0
BH833	31.074.029.000.0
BH835	31.116.017.000.0
BH836	31.031.023.000.0
BH848	31.088.018.000.0
BH852	31.045.042.000.0
BH854	31.046.013.000.0
BH857	31.080.013.000.0
BH858	31.092.018.000.0
BH865	31.097.007.000.0
BH866	31.099.007.000.0
BH869	31.085.008.000.0
BH881	31.089.035.000.0
BH885	31.079.003.000.0
BH887	31.104.001.000.0
BH888	31.089.035.000.0
BH889	31.091.033.000.0
BH897	31.075.030.000.0
BH898	31.076.025.000.0
BH903	31.189.055.000.0
BH904	31.190.055.000.0
BH905	31.187.006.000.0
BH906	31.188.026.000.0
BH953	31.189.055.000.0
BH955	31.187.006.000.0
BH956	31.188.026.000.0
BH958	31.050.018.000.0
BH959	31.064.010.000.0
BH961	31.128.008.000.0
BH964	31.054.011.000.0
BH970	31.055.022.000.0
BH972	31.096.008.000.0
BH973	31.098.007.000.0

МОПРОД	Код "ДАФМИ"
BH975	31.183.008.000.0
BH977	31.094.018.000.0
BH989	31.149.046.000.0
BH996	31.113.041.000.0
BH997	31.114.041.000.0
BH998	31.115.040.000.0
BH999	31.117.039.000.0
BH1000	31.118.019.000.0
BH1003	31.121.019.000.0
BH1004	31.120.037.000.0
BH1006	31.124.020.000.0
BH1019	31.109.038.000.0
BH1020	31.107.018.000.0
BH1021	31.139.013.000.0
BH1027	31.184.013.000.0
BH1028	31.111.042.000.0
BH1031	31.135.013.000.0
BH1043	31.126.022.000.0
BH1044	31.152.021.000.0
BH1045	31.127.021.000.0
BH1049	31.053.011.000.0
BH1050	31.054.011.000.0
BH1055	31.101.005.000.0
BH1058	31.100.005.000.0
BH1059	31.133.045.000.0
BH1060	31.062.020.000.0
BH1061	31.158.051.000.0
BH1062	31.159.051.000.0
BH1063	31.146.051.000.0
BH1064	31.145.051.000.0
BH1069	31.168.052.000.0
BH1070	31.202.034.000.0
BH1072	31.154.050.000.0
BH1082	31.156.022.000.0
BH1083	31.021.005.000.0
BH1084	31.157.019.000.0

DELPHI	Код "ДАФМИ"
LH68	31.002.019.000.0
LH69	31.002.019.000.0
LH105	31.202.034.000.0
LH111	31.133.045.000.0
LH149	31.154.050.000.0
LH155	31.169.053.000.0
LH156	31.170.053.000.0
LH180	31.163.054.000.0
LH192	31.021.005.000.0
LH193	31.157.019.000.0
LH218	31.048.005.000.0
LH234	31.186.006.000.0
LH236	31.094.018.000.0
LH246	31.153.002.000.0
LH270	31.023.036.000.0
LH271	31.149.046.000.0
LH273	31.216.060.000.0
LH275	31.205.008.000.0
LH279	31.206.013.000.0
LH280	31.198.042.000.0
LH283	31.112.013.000.0
LH284	31.107.018.000.0
LH294	31.196.045.000.0
LH304	31.212.057.000.0
LH319	31.004.018.000.0
LH320	31.094.018.000.0
LH324	31.043.008.000.0
LH349	31.071.026.000.0
LH372	31.111.042.000.0
LH374	31.214.059.000.0
LH388	31.131.043.000.0
LH395	31.005.005.000.0
LH443	31.200.050.000.0
LH463	31.168.052.000.0
LH469	31.197.018.000.0
LH471	31.219.062.000.0
LH472	31.220.062.000.0
LH473	31.218.061.000.0
LH474	31.217.061.000.0
LH568	31.006.005.000.0
LH571	31.007.005.000.0
LH580	31.009.005.000.0
LH597	31.012.026.000.0
LH916	31.014.008.000.0
LH961	31.129.019.000.0
LH1343	31.144.026.000.0
LH1351	31.015.005.000.0
LH1352	31.017.018.000.0
LH1429	31.018.018.000.0
LH1694	31.019.005.000.0
LH1716	31.020.005.000.0
LH1756	31.022.026.000.0
LH1763	31.024.005.000.0
LH1774	31.025.044.000.0
LH1934	31.026.001.000.0
LH1947	31.091.033.000.0
LH1948	31.028.018.000.0
LH1955	31.029.034.000.0
LH1998	31.030.024.000.0
LH2059	31.031.023.000.0
LH2060	31.032.024.000.0
LH2095	31.098.007.000.0
LH2100	31.035.014.000.0
LH2101	31.034.014.000.0
LH2102	31.036.044.000.0
LH2103	31.037.004.000.0
LH2105	31.038.002.000.0
LH2106	31.039.001.000.0
LH2107	31.040.001.000.0
LH2108	31.143.001.000.0

DELPHI	Код "ДАФМИ"
LH2109	31.042.018.000.0
LH2145	31.044.013.000.0
LH2146	31.045.042.000.0
LH2147	31.046.013.000.0
LH2151	31.047.026.000.0
LH2154	31.048.005.000.0
LH2156	31.050.018.000.0
LH2159	31.051.011.000.0
LH2161	31.052.021.000.0
LH2170	31.053.011.000.0
LH2181	31.054.011.000.0
LH2182	31.065.010.000.0
LH2190	31.054.011.000.0
LH2192	31.056.012.000.0
LH2213	31.058.022.000.0
LH2218	31.059.015.000.0
LH2244	31.063.020.000.0
LH2254	31.061.020.000.0
LH2257	31.062.020.000.0
LH2258	31.063.020.000.0
LH2262	31.064.010.000.0
LH2293	31.067.033.000.0
LH2301	31.068.005.000.0
LH2304	31.069.026.000.0
LH2307	31.070.026.000.0
LH2317	31.072.027.000.0
LH2318	31.073.028.000.0
LH2322	31.074.029.000.0
LH2323	31.075.030.000.0
LH2332	31.076.025.000.0
LH2333	31.077.031.000.0
LH2334	31.078.032.000.0
LH2335	31.072.027.000.0
LH2336	31.073.028.000.0
LH2337	31.074.029.000.0
LH2338	31.075.030.000.0
LH2502	31.079.003.000.0
LH2798	31.080.013.000.0
LH2800	31.081.042.000.0
LH2801	31.082.042.000.0
LH2802	31.083.013.000.0
LH2803	31.084.007.000.0
LH2804	31.085.008.000.0
LH2808	31.088.018.000.0
LH2810	31.089.035.000.0
LH2811	31.090.035.000.0
LH2813	31.092.018.000.0
LH2819	31.093.010.000.0
LH2820	31.185.055.000.0
LH2821	31.186.006.000.0
LH3244	31.096.008.000.0
LH3245	31.097.007.000.0
LH3246	31.098.007.000.0
LH3247	31.099.007.000.0
LH3248	31.050.018.000.0
LH3249	31.100.005.000.0
LH3250	31.101.005.000.0
LH3255	31.104.001.000.0
LH3257	31.105.005.000.0
LH3258	31.106.038.000.0
LH3259	31.107.018.000.0
LH3260	31.139.013.000.0
LH3261	31.109.038.000.0
LH3268	31.189.055.000.0
LH3269	31.190.055.000.0
LH3270	31.187.006.000.0
LH3271	31.188.026.000.0
LH3286	31.112.013.000.0
LH3288	31.114.041.000.0
LH3289	31.113.041.000.0

DELPHI	Код "ДАФМИ"
LH3290	31.115.040.000.0
LH3292	31.116.017.000.0
LH3294	31.117.039.000.0
LH3298	31.118.019.000.0
LH3300	31.149.046.000.0
LH3301	31.119.037.000.0
LH3302	31.120.037.000.0
LH3303	31.121.019.000.0
LH3304	31.122.037.000.0
LH3305	31.123.020.000.0
LH3306	31.124.020.000.0
LH3309	31.125.020.000.0
LH3600	31.149.046.000.0
LH3632	31.098.007.000.0
LH3638	31.095.007.000.0
LH3645	31.184.013.000.0
LH3650	31.149.046.000.0
LH3666	31.126.022.000.0
LH3667	31.127.021.000.0
LH3681	31.136.038.000.0
LH3687	31.163.054.000.0
LH3695	31.180.008.000.0
LH3696	31.181.008.000.0
LH3702	31.128.008.000.0
LH3703	31.129.019.000.0
LH3724	31.135.013.000.0
LH3725	31.138.013.000.0
LH3740	31.008.005.000.0
LH3780	31.147.049.000.0
LH4201	31.159.051.000.0
LH4202	31.158.051.000.0
LH4203	31.145.051.000.0
LH4204	31.146.051.000.0
LH5151	31.047.026.000.0
LH5955	31.026.001.000.0
LH6018	31.209.018.000.0
LH6021	31.221.043.000.0
LH6022	31.210.018.000.0
LH6023	31.211.018.000.0
LH6036	31.167.041.000.0
LH6037	31.165.041.000.0
LH6072	31.194.055.000.0
LH6073	31.195.056.000.0
LH6095	31.053.011.000.0

ATE	DAfmi
03.5104-0335.3	31.024.005.000.0
03.5113-0435.3	31.021.005.000.0
03.5124-0362.3	31.024.005.000.0
03.5124-0302.3	31.068.005.000.0
03.5124-0305.3	31.068.005.000.0
03.5124-0422.3	31.012.026.000.0
03.5154-0340.3	31.025.044.000.0
03.5204-0200.3	31.010.026.000.0
03.5204-0207.3	31.142.005.000.0
03.5204-0270.3	31.011.026.000.0
03.5213-0330.3	31.130.045.000.0

ATE	Код "ДАФМИ"
03.5213-0332.3	31.133.045.000.0
03.5224-0200.3	31.022.026.000.0
03.5224-0300.3	31.047.026.000.0
03.5236-0135.3	31.157.019.000.0
03.5267-0195.3	31.028.018.000.0
03.5267-0196.3	31.092.018.000.0
24.5111-0220.3	31.107.018.000.0
24.5111-0240.3	31.135.013.000.0
24.5111-0300.3	31.080.013.000.0
24.5205-0243.3	31.063.020.000.0
24.5205-0246.3	31.063.020.000.0
24.5205-0250.3	31.061.020.000.0
83.5101-0160.3	31.144.026.000.0
83.5101-0450.3	31.008.005.000.0
83.5104-0160.3	31.144.026.000.0
83.5104-0200.3	31.142.005.000.0
83.5104-0201.3	31.142.005.000.0
83.5104-0350.3	31.007.005.000.0
83.5104-0360.3	31.007.005.000.0
83.5120-0420.3	31.008.005.000.0
83.5123-0504.3	31.093.010.000.0
83.5124-0302.3	31.068.005.000.0
83.5124-0305.3	31.068.005.000.0
83.5124-0362.3	31.024.005.000.0
83.5134-0332.3	31.051.011.000.0
83.5170-0226.3	31.034.014.000.0
83.5170-0228.3	31.034.014.000.0
83.5170-0250.3	31.035.014.000.0
83.5170-0251.3	31.035.014.000.0
83.5175-0312.3	31.020.005.000.0
83.5196-0379.3	31.043.008.000.0
83.5204-0180.3	31.015.005.000.0
83.5204-0200.3	31.010.026.000.0
83.5204-0260.3	31.060.026.000.0
83.5204-0286.3	31.012.026.000.0
83.5204-0470.3	31.069.026.000.0
83.5224-0180.3	31.016.026.000.0
83.5224-0300.3	31.047.026.000.0
83.5224-0383.3	31.070.026.000.0
83.5259-0250.3	31.004.018.000.0
83.5263-0240.3	31.129.019.000.0
83.5266-0285.3	31.038.002.000.0
83.5266-0315.3	31.042.018.000.0
83.5267-0240.3	31.140.018.000.0
83.5267-0285.3	31.017.018.000.0
83.5267-0295.3	31.017.018.000.0
83.5273-0250.3	31.212.057.000.0
83.5278-0365.3	31.029.034.000.0
83.5288-0280.3	31.067.033.000.0
83.5288-0312.3	31.091.033.000.0
83.5288-0314.3	31.027.033.000.0
83.5294-0315.3	31.090.035.000.0
83.5294-0316.3	31.090.035.000.0
83.5327-0180.3	31.104.001.000.0
83.5327-0181.3	31.104.001.000.0
83.5327-0271.3	31.040.001.000.0
83.5327-0331.3	31.026.001.000.0
83.5327-0333.3	31.026.001.000.0
83.5327-0372.3	31.039.001.000.0
83.5327-0385.3	31.143.001.000.0
83.5327-0386.3	31.143.001.000.0
83.5339-0227.3	31.037.004.000.0
83.5339-0250.3	31.037.004.000.0
83.5339-0252.3	31.036.044.000.0
83.5352-0310.3	31.079.003.000.0
83.5352-0311.3	31.079.003.000.0
83.5384-0300.3	31.012.026.000.0
83.6124-0422.3	31.048.005.000.0
83.6204-0200.3	31.010.026.000.0
83.6204-0290.3	31.012.026.000.0